

17.15 Fishfinder alarms

The following Fishfinder alarms can be set when a depth data source is available.

- **Fish** — alarm sounds when a target meets the specified sensitivity level and, is within the depth limits (if enabled).
- **Fishfinder Deep** — alarm sounds when the detected depth is greater than the deep limit.
- **Fishfinder Shallow** — alarm sounds when the detected depth is less than the shallow limit.

Setting up fish alarms

From the Alarms menu **homescreen > Set-up > Alarms:**

1. Select **Fish**.
The Fish alarms menu is displayed.
2. Select **Fish** so that On is highlighted.
3. Select **Fish Sensitivity**.
The fish sensitivity numeric adjust control is displayed.
4. Adjust the fish sensitivity to the require value.
The greater the fish alarm sensitivity, the greater the number of target image depths displayed.
5. Select **Fish Depth Limits** so that **On** is highlighted.
The shallow and deep fish limit settings will be activated in the menu.
6. Select **Shallow Fish Limit**.
The shallow fish limit numeric adjust control is displayed.
7. Adjust the value to the require setting.
8. Select **Ok** to confirm the new value and close the numeric adjust control.
9. Select **Deep Fish Limit**.
The deep fish limit numeric adjust control is displayed.
10. Adjust the value to the require setting.
11. Select **Ok** to confirm the new value and close the numeric adjust control.

Setting up fishfinder deep alarm

From the Alarms menu **homescreen > Set-up > Alarms:**

1. Select **Fishfinder Deep**.
2. Select Deep so that On is highlighted.
Selecting Deep will switch between On and Off.
3. Select **Deep Limit**.
The deep limit numeric adjust control is displayed.
4. Adjust the setting to the required value.
5. Select **Ok** to confirm the new value and close the numeric adjust control.

Note: The Deep Limit cannot be set to less than the Shallow Limit.

Setting up fishfinder shallow alarm

From the Alarms menu **homescreen > Set-up > Alarms:**

1. Select **Fishfinder Shallow**.
2. Select Shallow so that On is highlighted.
Selecting Shallow will switch between On and Off.
3. Select **Shallow Limit**.
The shallow limit numeric adjust control is displayed.
4. Adjust the setting to the required value.
5. Select **Ok** to confirm the new value and close the numeric adjust control.

Note: The Shallow Limit cannot be set to greater than the Deep Limit.

17.16 Frequency tuning

The frequency is dependent on the sonar module and transducer in use. When using a non-CHIRP sonar module or a CHIRP sonar module that is operating in non-CHIRP mode then the transducer's frequency can be manually fine-tuned.

The advantages of being able to tune the frequency include:

- Optimization for particular species of fish and water conditions.
- Avoiding interference from other sonar operating nearby (at the same frequency).
- Use of wide or narrow beam on a particular transducer.

Traditional and Legacy frequency tuning

The following frequency types are available on Legacy and Traditional sonar modules:

- **Auto** — When operating in automatic no fine-tuning is needed as the system will set the frequency automatically to suit your transducer's operating conditions.
- **Lower frequencies** — (e.g. 50 kHz) — Produces a wide sonar beam and penetrate the water well. Lower frequencies provide a lower resolution image that may not be as good at detecting small fish. Use lower frequencies if you require a large coverage beneath your vessel or if you are in deep water.
- **Medium frequencies** — (e.g. 90 kHz) — Produces good detail at most depths, with moderately wide sonar beam.
- **Higher frequencies** — (e.g. 200 kHz) — Produces a narrow beam and produce a high resolution image. They are most useful in shallower water (up to 1000 ft) and at higher speeds.

The graph below depicts fine-tuning of a Traditional or Legacy sonar frequency (from -50% to +50%).

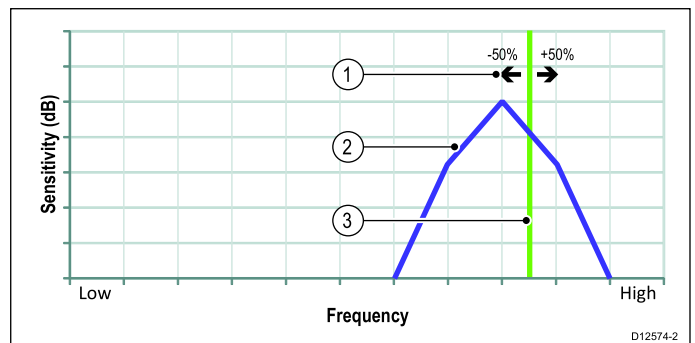

1. Tuning range
2. Transducer characteristics
3. Operating frequency

CHIRP frequency tuning

The list below provides details of the frequency types available when using a CHIRP sonar module.

- **Auto** — When operating in automatic no fine-tuning is needed as the system will set the frequency automatically to suit your transducer's operating conditions.
- **Low frequency** — non-CHIRP mode (e.g. 50 kHz) — Produces a wide sonar beam and penetrate the water well. Lower frequencies provide a lower resolution image that may not be as good at detecting small fish. Use lower frequencies if you require a large coverage beneath your vessel or if you are in deep water.
- **Medium frequency** — non-CHIRP mode (e.g. 90 kHz) — Produces good detail at most depths, with moderately wide sonar beam.
- **High frequency** — non-CHIRP mode (e.g. 160 kHz) — Produces a narrow beam and produce a high resolution image. They are most useful in shallower water (up to 1000 ft) and at higher speeds.
- **Low Chirp** — CHIRP mode (e.g. 42 to 65 kHz) — No fine-tuning is not needed as the CHIRP sonar module will sweep the transducer's available frequency range in each ping.
- **Med Chirp** — CHIRP mode (e.g. 85 to 135 kHz) — No fine-tuning is not needed as the CHIRP sonar module will

sweep the transducer's available frequency range in each ping.

- **High Chirp** — CHIRP mode (e.g. 130 to 210 kHz) — No fine-tuning is not needed as the CHIRP sonar module will sweep the transducer's available frequency range in each ping.

With the CHIRP sonar module set to a non-CHIRP mode the frequency can be fine tuned to adjust the frequency at which the transducer is transmitting.

The graph below depicts fine-tuning of a CHIRP broadband sonar frequency (from -50% to +50%).

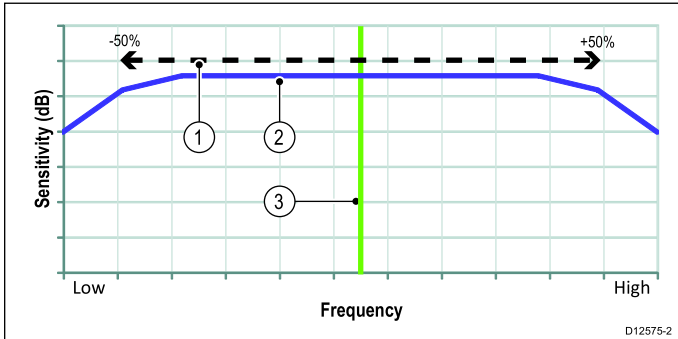

1. Tuning range
2. Transducer characteristics
3. Operating (center) frequency

Fine-tuning the sonar frequency

When connected to a Traditional or Legacy sonar module or when operating a CHIRP sonar module in non-CHIRP mode the transmit frequency can be fine-tuned.

From the Fishfinder application:

1. Ensure that the channel frequency that you want to fine-tune is displayed in the active Fishfinder pane.
2. Select **Menu**.
3. Select **Set-up**.
4. Select **Sounder Set-up**.
5. Select **Tune Frequency**.
The frequency adjust control is displayed.
6. Adjust the frequency until optimum results are achieved.

17.17 Sounder set-up menu options

This section details the options available in the Sounder set-up menu: (**Menu > Set-up > Sounder Set-up**).

Menu Item	Description	Options
Ping Rate	Hyper Ping is a setting only available on Traditional internal and Legacy sonar modules, for use in shallow waters (depth range set to 6 meters (20 feet) or less. In depths of over 6 meters (20 feet) the ping rate will revert to normal until depth conditions are met. When set to Hyper the display will provide an accurate, undistorted image of the bottom at speeds of up to 40 kts.	<ul style="list-style-type: none"> • Normal (default) • Hyper
Ping Rate Limit	Provides a speed limiter; it is useful to adjust the ping rate limit to suit local conditions. For example, the ping rate may be too fast when there is a hard bottom in shallow water. Note: Ping rate limit is disabled if Ping Rate is set to Hyper.	<ul style="list-style-type: none"> • DownVision™ and SideVision™ sonars: 5 to 80 pings per second. • Legacy and Traditional Internal sonars: 5 to 50 pings per second. • CHIRP and traditional external sonars: 5 to 30 pings per second.
Ping Enable	The sonar ping can be disabled. This is useful when other equipment is being tested, or if someone is diving beneath the boat. This setting reverts to Enabled when the sonar module is powered off.	<ul style="list-style-type: none"> • On • Off
Tune Frequency	Enables non-CHIRP channel frequencies to be manually tuned.	<ul style="list-style-type: none"> • -50% to +50%
Interference rejection	Removes spikes caused by other fishfinder-equipped vessels. Note: Interference rejection is disabled if Ring Rate is set to Hyper.	<ul style="list-style-type: none"> • Auto • Low • Medium • High • Off
2nd Echo IR	Adjusts the ping rate in small increments, according to the 2nd echo level. This results in better sensitivity of the image. Note: 2nd Echo IR is disabled if Ring Rate is set to Hyper.	<ul style="list-style-type: none"> • Off • Low • High
Sonar reset	Restore all settings on the sonar module to factory default. When performing a sonar Reset, it is normal to briefly lose connection with the sonar module. Transducer selection is not affected by the Sonar Reset operation.	<ul style="list-style-type: none"> • Yes • No
Trip Reset	Resets the Trip Counter of the sonar module	<ul style="list-style-type: none"> • Yes • No

17.18 Transducer set-up menu options

The **Transducer Set-up** menu should be used when setting up your multifunction display for the first time or when installing a depth transducer.

Menu Item	Description	Options
Transducer	Select the appropriate transducer type from those displayed. Some transducers may be detected by the system automatically.	Options available are dependent on the sonar module connected.
Speed Transducer	Select the appropriate speed transducer from those available. This option is only available if you are not using a combined Depth/Speed or Depth/Speed/Temperature transducer.	Options available are dependent on the sonar module connected.
Depth Offset	Offset represents the depth of the transducer relative to: <ul style="list-style-type: none"> • Waterline = 0.0 ft and above. • Keel = 0.1 ft and below. 	• -9.8 to +9.8 feet — or equivalent units
Speed Offset	Offset applied to the speed log.	• 0 to 100%
Temperature Offset	Offset applied to the temperature transducer value.	• -9.9 to +9.9 °F — or equivalent units

17.19 Resetting the sonar

The reset function restores the unit to its factory default values.

Note: Performing a factory reset will clear speed and temperature calibration settings and the depth offset.

1. Using a compatible Raymarine multifunction display go to the Fishfinder application page.
2. Select **Menu** from the side menu.
3. Select **Set-up**.
4. Select **Sounder Set-up**.
5. Select **Sonar reset**.
6. Select **Yes** to confirm.

The unit will now be reset to factory default settings.

Chapter 18: Radar application

Chapter contents

- [18.1 Radar overview on page 206](#)
- [18.2 Radar scanner status symbols on page 207](#)
- [18.3 Radar display overview on page 208](#)
- [18.4 Radar range and image quality on page 209](#)
- [18.5 Target tracking on page 211](#)
- [18.6 Distances, range, and bearing on page 213](#)
- [18.7 Radar mode and orientation on page 215](#)
- [18.8 Radar presentation menu options on page 217](#)
- [18.9 !\[\]\(36f8637baaa56c4be44b454435949289_img.jpg\) Radar tuning: On-screen gain controls on page 220](#)
- [18.10 HD and SuperHD radar adjustments on page 221](#)
- [18.11 Non-HD digital radomes adjustments on page 223](#)
- [18.12 Dual range radar operation on page 224](#)
- [18.13 Radar scan speed on page 225](#)
- [18.14 Radar Set-up menu on page 226](#)
- [18.15 Resetting the radar on page 227](#)

18.1 Radar overview

Radar is used to provide information that can help you to track targets and measure distances and bearings.

Radio Detection And Ranging (RADAR) is used at sea to detect the presence of objects (known as ‘targets’) at a distance, and if they are moving, detect their speed.

Radar works by transmitting radio pulses, then detecting reflections of these pulses (echoes) from objects in the area and displaying the reflections as targets on your display.

Until you are familiar with interpreting the radar display, every opportunity should be taken to compare the radar screen patterns with visual targets, such as other boats, buoys and coastal structures. You should practise harbor and coastal navigation during daylight hours and in clear weather conditions.

HD and SuperHD radar

Your multifunction display can be used with radar scanners.

HD and SuperHD radar scanners provide a range of advantages, making it easier to discern objects around your vessel.

HD and SuperHD radar scanners provide:

- Improved target detection.
- Full-color image.
- Dual Range operation.
- SuperHD option. This effectively increases the transmitter power by a factor of at least 2, and reduces the beamwidth by a similar amount.

Note: You must connect a SuperHD radar scanner in order to use the SuperHD option.

Multiple radar scanners

The multifunction display only supports the use of 1 radar on the network.

When the radar application is opened, if multiple radar scanners are detected then a warning message shall be displayed. Additional scanners will need to be removed from the network before the radar application will function.

Radar Features

Depending on the type of Raymarine radar you have different features will be available to you, the table below shows which features and settings are supported by radar type:





Feature	Non-HD Digital Radome	HD Radome	HD Open Array	SuperHD Open Array
Color Gain	✗	Auto / Manual (0-100%)	Auto / Manual (0-100%)	Auto / Manual (0-100%)
FTC	Off/On (0-100%)	✗	✗	✗
Sea	Harbour / Coastal / Offshore / Manual (0-100%)	Auto / Manual (0-100%)	Auto / Manual (0-100%)	Auto / Manual (0-100%)
Auto Mode: Buoy	✗	✓	✓	✓
Auto Mode: Harbor	✗	✓	✓	✓
Auto Mode: Offshore	✗	✓	✓	✓
Auto Mode: Coastal	✗	✓	✓	✓
Auto Mode: Bird	✗	✓	✗	✓

Feature	Non-HD Digital Radome	HD Radome	HD Open Array	SuperHD Open Array
Power Boost	✗	✗	✗	✓
Antenna Boost	✗	✗	✗	✓
Interference Rejection	Off / Normal / High	Off / On	Off / On	Off / On
Target Expansion	Off / Low / High	Off / On	Off / On	Off / On
MARPA Targets	10	25	25	25
Dual Range	✗	✓	✓	✓
Dual Range Restrictions	N/A	✗	✗	✗
Scanner Speed	24 RPM	24 RPM / Auto	24 RPM / Auto	24 RPM / Auto
Parking Offset	✗	✗	0-360 degrees	0-360 degrees
Antenna Size	✗	✗	4ft / 6ft	4ft / 6ft
Display Timing	0-153.6m	0-767m (range dependant)	0-767m (range dependant)	0-767m (range dependant)
STC Preset	0-100%	✗	✗	✗
Gain Preset	0-100	✗	✗	✗
Tune Correction	✗	✓	✓	✓

Note: Features not listed are supported by all types of Raymarine Non-HD Digital, HD and SuperHD radars.

18.2 Radar scanner status symbols

The radar scanner power mode status is indicated in the databar.

Symbol	Radar power mode	Description
	Transmit (TX)	Rotating icon, signifying that the scanner is on and transmitting. When SCANNER is set to ON, select this mode to activate the scanner. This is the usual mode of operation.
	Standby (STBY)	Static icon, indicating that the scanner is on but not transmitting, and the antenna is not rotating. The scanner does not transmit and the radar data is removed from the screen. This is a power-save mode used when the radar is not needed for short time periods. When you return to transmit mode, the magnetron does not need to warm up again. This is the default mode.
	Off	Scanner powered off when radar not required, but display is in use for other applications, such as the chart. When selected, the system counts down. During this time you cannot re-power the scanner.
 	Timed Transmit	Scanner switches between on/transmitting, and standby mode. Scanner goes into power save mode when constant use of radar is not required.

2. Select **Power up Radar** to turn the radar on, or **Power down Radar** to turn the radar off.
3. Select **Radar: Tx** to start the radar transmitting, or **Radar: Stdby** to stop the radar transmitting.

Powering the radar scanner on and off

In the radar application:

1. Select **Menu**.
2. Select **Power** to switch the Radar's power On and Off.
The radar will always power up in Standby mode.
3. Select **Radar** to switch the radar between Transmit and Standby modes.

Using the power button to switch operating modes

The radar operating modes can also be set using the multifunction displays power button menu.

1. Press and release the **Power** button.

The shortcuts menu is displayed:

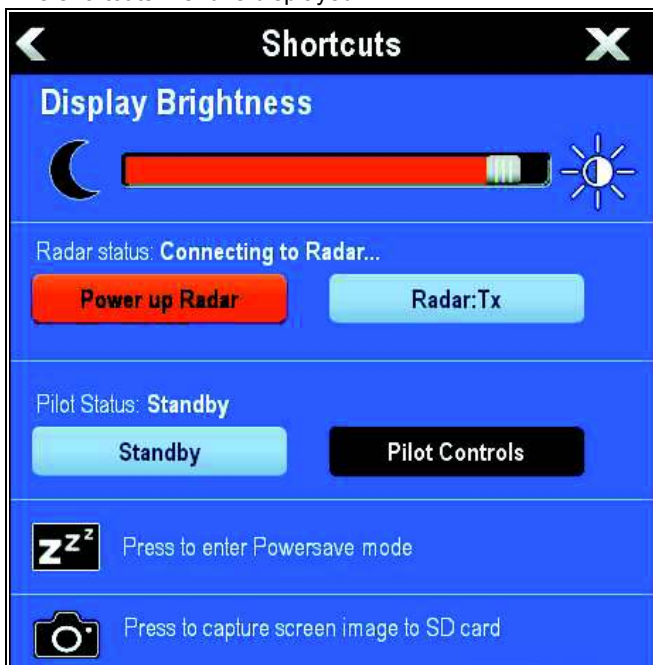

18.3 Radar display overview

With your radar scanner connected and the radar in transmit mode, the radar picture provides a map-like representation of the area in which the radar is operating.

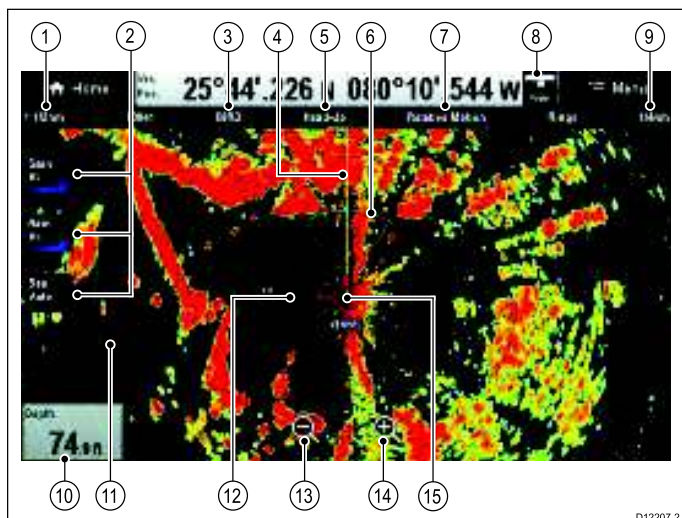

Item	Description
1	Range
2	On-screen controls (Touchscreen multifunction displays only.)
3	Gain mode
4	Ship's Heading Marker (SHM)
5	Orientation
6	Guard Zone
7	Motion mode
8	Range status
9	Range ring spacing
10	Data cell overlay
11	Waypoint
12	Safe zone ring
13	Range out (Touchscreen multifunction displays only.)
14	Range in (Touchscreen multifunction displays only.)
15	Ship's position

Note: On-screen range controls can be enabled and disabled from the homescreen: **Customize > Display Preferences > Range Controls**

Additional functionality of the radar application includes:

- Color palettes.
- Adding AIS overlay.
- MARPA targets.
- VRM/EBL markers

Typically, your vessel's position is at the center of the display, and its dead ahead bearing is indicated by a vertical heading line, known as the Ship's Heading Marker (SHM).

Note: If the cursor is placed over the SHM, the SHM will temporarily be removed to help placing markers or acquiring targets etc.

On-screen targets may be large, small, bright or faint, depending on the size of the object, its orientation and surface. If using a non-HD digital radome scanner, strongest target returns are displayed in yellow with weaker returns in 2 shades of blue. If using a HD or SuperHD radar scanner, stronger target returns show as different colors from a range of 256 colors, providing

better clarity. Be aware that the size of a target on screen is dependent on many factors and may not necessarily be proportional to its physical size. Nearby objects may appear to be the same size as distant larger objects.

Note: Colors stated above refer to the default color palette.

With experience, the approximate size of different objects can be determined by the relative size and brightness of the echoes.

You should bear in mind that the size of each on-screen target is affected by:

- The physical size of the reflecting object.
- The material from which the object is made. Metallic surfaces reflect signals better than non-metallic surfaces.
- Vertical objects such as cliffs reflect signals better than sloping objects such as sandbanks.
- High coastlines and mountainous coastal regions can be observed at longer radar ranges. Therefore, the first sight of land may be a mountain several miles inland from the coastline. Although the coastline may be much nearer, it may not appear on the radar until the vessel is closer to shore.
- Some targets, such as buoys and small vessels difficult to discern, because they do not present a consistent reflecting surface as they bob and toss about in the waves. Consequently these echoes tend to fade and brighten, and at times disappear momentarily.
- Buoys and small vessels resemble each other, but vessels can often be distinguished by their motion.

Note: A GPS receiver and a fast heading sensor are required for MARPA operation, and to enable radar/chart overlay.

Radar context menu

The radar application includes a context menu which provides positional data and menu items.



The context menu provides the following positional data for the cursor location in relation to your vessel:

- Latitude
- Longitude
- Range
- Bearing

The context menu also provide the following menu items:

- **Acquire Target**
- **Place VRM/EBL**
- **Place Waypoint At Cursor**
- **Slew thermal camera** (Only available when thermal camera is connected and operating.)

Accessing the context menu

You can access the context menu by following the steps below.

1. Non-touchscreen and HybridTouch displays:
 - i. Selecting a location, object or target on-screen and pressing the **Ok** button.
2. HybridTouch and Touch only displays:
 - i. Selecting an object or target on-screen.
 - ii. Selecting and holding on a location on-screen.

18.4 Radar range and image quality

Maximum radar range

The usable range of the radar is limited by factors such as the height of the scanner, and height of the target.

Maximum radar range is essentially line-of-sight, so is limited by the height of the scanner and the height of the target as illustrated below:

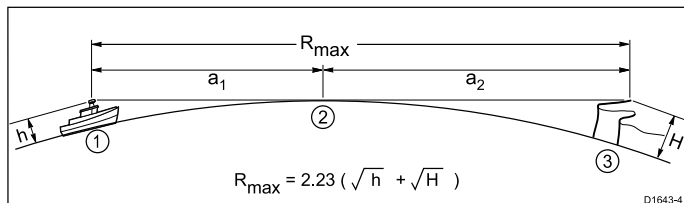

Item	Description
1	Radar equipped vessel.
2	Curvature of the earth.
3	Target (Cliff).
a ₁	Radar horizon of antenna.
a ₂	Radar horizon of target.
R _{max}	Maximum radar range in nautical miles. $R_{max} = a_1 + a_2$
h	Radar antenna height in metres.
H	Target height in metres.

The table below shows typical maximum radar ranges for various radar antenna heights and target heights. Remember that although the radar horizon is greater than the optical horizon, the radar can only detect targets if a large enough target is above the radar horizon.

Antenna height (meters)	Target height (meters)	Maximum range (Nautical miles)
3	3	7.7
3	10	10.9
5	3	8.8
5	10	12

Radar image quality

A number of factors can affect the quality of a radar image, including echoes, sea clutter, and other interference.

Not all radar echoes are produced by valid targets. Spurious or missing echoes may be caused by:

- Side lobes.
- Indirect echoes.
- Multiple echoes.
- Blind sectors.
- Sea, rain, or snow clutter.
- Interference.

Through observation, practice, and experience, you can generally detect these conditions very quickly and use the radar controls to minimize them.

Side Lobes

Side lobe patterns are produced by small amounts of energy from the transmitted pulses that are radiated outside the narrow main beam. The effects of side lobes are most noticeable with targets at short ranges (normally below 3 nm), and in particular with larger objects. Side lobe echoes form either arcs on the radar screen similar to range rings, or a series of echoes forming a broken arc.

Radar application

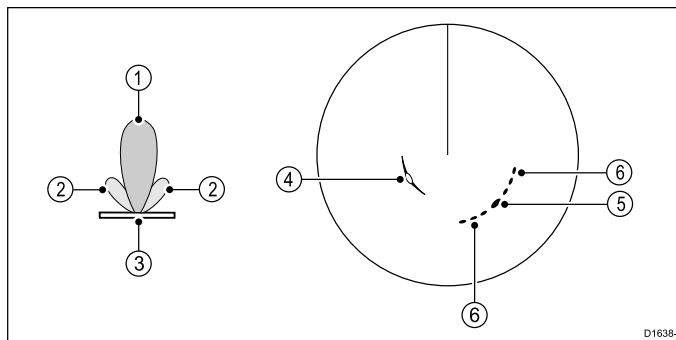

Item	Description
1	Main lobe
2	Side lobes
3	Antenna
4	Arc
5	True echo
6	Side echoes

Indirect Echoes

There are several types of indirect echoes or ghost images. These sometimes have the appearance of true echoes, but in general they are intermittent and poorly defined.

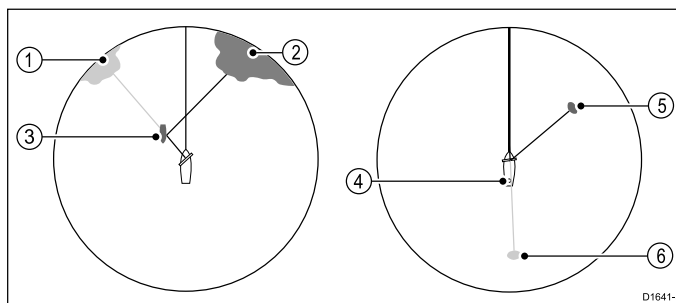

Item	Description
1	False echo
2	True echo
3	Passing ship
4	Mast or funnel
5	True echo
6	False echo

Multiple Echoes

Multiple echoes are not very common but can occur if there is a large target with a wide vertical surface at a comparatively short range. The transmitted signal will be reflected back and forth between the target and your own ship, resulting in multiple echoes, displayed beyond the range of the true target echo, but on the same bearing.

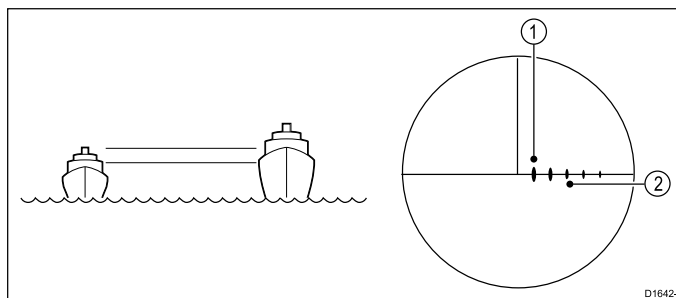

Item	Description
1	True echo
2	Multiple echoes

Blind Sectors

Obstructions such as funnels and masts near the radar antenna may obstruct the radar beam and cause radar shadows or 'blind sectors'. If the obstruction is relatively narrow, there will be a reduction of the beam intensity, though not necessarily a complete cut-off. However, for wider obstructions there may be a total loss of signal in the shadow area. There may also be multiple echoes which extend behind the obstruction. Blind sector effects can normally be minimized by careful selection of the scanner site prior to installation.

Rain or Snow Clutter

The radar can see echoes from rain or snow. Returns from storm areas and rain squalls consist of countless small echoes that continuously change size, intensity and position. These returns sometimes appear as large hazy areas, depending on the intensity of the rainfall or snow in the storm cell. The images in the table below show how the Rain control can clear up this clutter:

Rain clutter off	
Rain clutter on	

Sea Clutter

Radar returns from waves around the vessel can clutter the centre of the radar picture, making it difficult to detect real targets. Such 'sea clutter' usually appears as multiple echoes on the display at short range scales, and the echoes are not repetitive or consistent in position. With high winds and extreme conditions, echoes from sea clutter may cause dense background clutter in the shape of an almost solid disc. Sea clutter can be suppressed using the sea clutter settings. The images in the table below show how the sea clutter settings can clear up some of this clutter:

Sea clutter off	
Sea clutter in auto	

Interference

When two or more radar-equipped vessels are operating within range of each other mutual radar interference can occur. This usually appears as a spiral of small dots from the display centre. This type of interference is most noticeable at long ranges. This interference can be suppressed using the interference rejection settings. The images in the table below show how the Interference rejection settings can clear up some of this interference:

Interference rejection off	
Interference rejection on	

18.5 Target tracking

The **Guard Zone**, **VRM/EBL** and **MARPA** functions will help you track targets and avoid collisions.

With a radar connected to your multifunction display, you can:

- Assess how far away a target is and its bearing (VRM/EBL).
- Set an alarm to trigger when a target is within a specified zone (Guard Zone).
- Display detailed information on tracked targets (MARPA).
- Display the range and bearing of a target.

Setting up a radar guard zone

From the radar application:

1. Select **Menu**.
2. Select **Zones**.
3. Select **Guard Zone** so that On is highlighted.
Selecting Guard Zone will switch the zone On and Off.
4. Select **Guard Zone Set-up**.
5. Select **Shape**: to switch between Sector or Circle.
6. Select **Outer**: .
The Outer numeric adjust control is displayed.
7. Adjust the outer edge of the guard zone to the required distance.
8. Select **Ok** to close the numeric adjust control.
9. Select **Inner**: .
The Inner numeric adjust control is displayed.
10. Adjust the inner edge of the guard zone to the required distance.
11. Select **Ok** to close the numeric adjust control.
12. Select **Width**: .
The Width numeric adjust control is displayed.
13. Adjust the width of the guard zone in degrees.
14. Select **Ok** to close the numeric adjust control.
15. Select **Bearing**: .
The Bearing numeric adjust control is displayed.
16. Adjust the bearing of the guard zone in degrees port or degrees starboard.
17. Select **Ok** to close the numeric adjust control.

Note: Guard zone width and bearing can only be adjusted when the **Shape**: is set to Sector.

Guard zone context menu

The guard zone function includes a context menu which provides additional menu items.

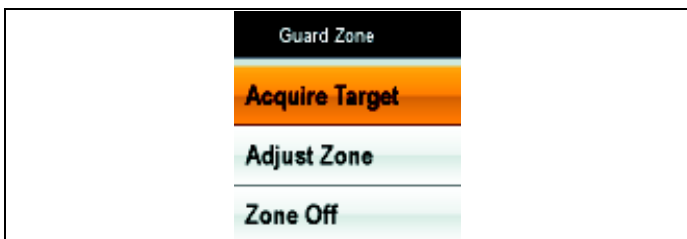

The context menu provides the following menu items:

- **Acquire Target**.
- **Adjust Zone**
- **Zone Off**

Accessing the context menu

You can access the context menu by following the steps below.

1. Non-touchscreen and HybridTouch displays:
 - i. Selecting a location, object or target on-screen and pressing the **Ok** button.
2. HybridTouch and Touch only displays:
 - i. Selecting an object or target on-screen.
 - ii. Selecting and holding on a location on-screen.

Radar application

Adjusting guard zone sensitivity

You can adjust the threshold at which the alarm is triggered by a target entering the guard zone.

From the Radar application menu:

1. Select **Zones**.
2. Select **Sensitivity**.
The sensitivity numeric adjust control is displayed.
3. Adjust the sensitivity to the required value.
4. Select **Ok** or **Back** to confirm setting and close the numeric adjust control.

The guard zone sensitivity setting can also be accessed from the **Alarms** menu: **Homescreen > Set-up > Alarms > Guard Zone > Sensitivity**.

MARPA overview

MARPA is used for target tracking and risk analysis in the radar application.

With an accurate heading sensor connected to your multifunction display, you can use the Mini Automatic Radar Plotting Aid (MARPA) functions for target tracking and risk analysis. MARPA improves collision avoidance by calculating information for tracked targets, and provides continuous, accurate, and rapid situation evaluation. The number of targets that you can track at any one time is dependent on the model of radar scanner that you are using.

MARPA tracks acquired targets, and calculates the target's speed and course.

Each target tracked can be displayed with a graphic indicating the Closest Point of Approach (CPA), and Time to Closest Point of Approach (TCPA). The calculated target data can also be shown on your screen. Each target is continually assessed and an audible alarm is sounded if a target becomes dangerous, or is lost.

For effective MARPA operation, your multifunction display must have accurate heading and speed data for your vessel. The better the quality of the heading and speed data, the better MARPA will perform. For the best heading data, a Raymarine SMART heading sensor or a gyro-stabilized autopilot is required.

In True Motion mode, Speed Over Ground (SOG) and Course Over Ground (COG) information is required to show true target course and speed.

In Relative Motion mode, heading and speed information is required.

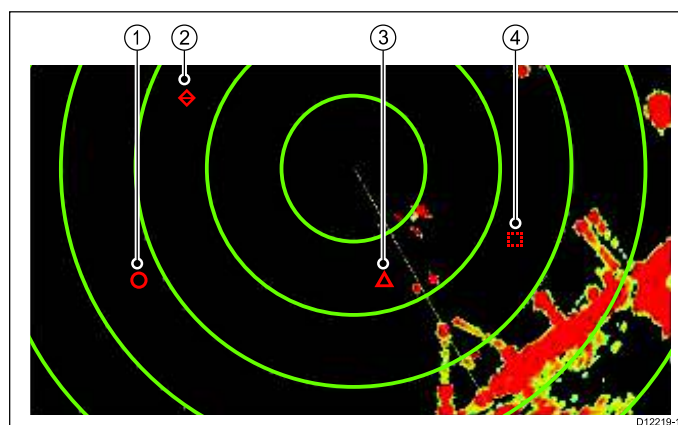

Item	Description
1	Safe target
2	Lost target
3	Dangerous target
4	Target being acquired

Safety notices

MARPA can improve collision avoidance when used wisely. It is your responsibility to exercise common prudence and navigational judgement.

There are conditions where acquiring a target may become difficult. These same conditions may be a factor in successfully tracking a target. Some of the conditions are:

- The target echo is weak. The target is very close to land, buoys or other large targets.
- The target or your own vessel is making rapid manoeuvres.
- Choppy sea state conditions exist and the target is buried in excessive sea clutter or in deep swells.
- Choppy sea state conditions exist yielding poor stability; own vessel's heading data is very unstable.
- Inadequate heading data.

Symptoms of such conditions include:

- target acquisition is difficult and the MARPA vectors are unstable;
- the symbol wanders away from the target, locks-on to another target, or changes to a lost symbol target.

In these circumstances, target acquisition and tracking may need to be re-initiated and in some cases might be impossible to maintain. Better quality heading data might improve performance in these circumstances.

How a MARPA risk is assessed

Each target is monitored to ascertain whether it will be within a certain distance from your vessel within a certain time. If so, the target is designated as dangerous, and an audible warning is sounded and a warning displayed. The target symbol changes to the dangerous target symbol and flashes to indicate that it is a dangerous target. Acknowledging the alarm will remove the warning.

If a target is lost, either because the MARPA software has lost contact with it, or because it has moved out of range, an audible alarm is sounded and an on-screen warning appears. The on-screen symbol will change to the target lost symbol. Acknowledging the warning will silence the alarm and remove the on-screen warning and the target lost symbol.

Effective range for MARPA targets

MARPA target acquisition is only available at radar range scales of up to 12 nm, although tracking continues at all ranges.

If you change to a smaller range scale, targets may be beyond the range of your radar scanner and will be lost. In such cases, an on-screen warning indicates that the target is off-screen.

MARPA context menu

The MARPA function includes a context menu which provides positional data and menu items.

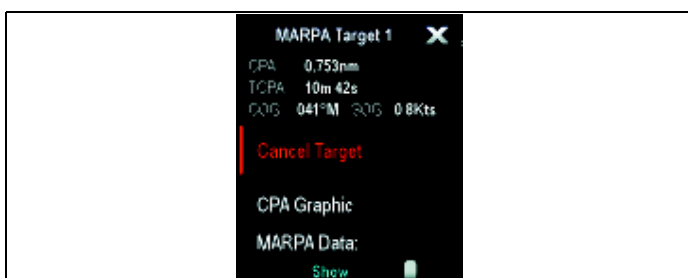

The context menu provides the following target information:

- CPA
- TCPA
- COG
- SOG

The context menu also provide the following menu items:

- **Cancel target**
- **CPA Graphic**
- **MARPA Data**
- **Slew thermal camera** (Only available when thermal camera is connected and operating.)

Accessing the context menu

You can access the context menu by following the steps below.

1. Non-touchscreen and HybridTouch displays:

- i. Selecting a location, object or target on-screen and pressing the **Ok** button.
2. HybridTouch and Touch only displays:
 - i. Selecting an object or target on-screen.
 - ii. Selecting and holding on a location on-screen.

Configuring target options

From the radar application:

1. Select **Menu**.
2. Select **Targets**.
3. Select **Target Options**.
4. Select **Vector Length**.
5. Select an appropriate time period.
The distance that your vessel travels in the time period you specify here determines the length of the vector lines.
6. Select **Target History**.
7. Select an appropriate time period.
The target's previous position will be plotted on the radar display as a target icon with lighter shading than the actual target.

Note: MARPA and AIS functions share **Safe Zone** and **Vector Length** settings.

Setting up the Safe Zone Ring

You can adjust the Safe Zone Ring radius, the time to Safe Zone and choose whether AIS targets trigger the Safe Zone alarm from the Safe Zone Ring Set-up menu.

The Safe Zone Set-up menu can be accessed as follows:

- From the Radar application: **Menu > Zones > Safe Zone Set-up**.
- From the Chart application with only the AIS overlay enabled: **Menu > AIS Options > Safe Zone > Safe Zone Set-up**.
- From the Chart application with only the Radar overlay enabled: **Menu > Radar Options > Safe Zone > Safe Zone Set-up**.
- From the Chart application with the AIS and Radar overlays enabled: **Menu > Radar & AIS Options > Safe Zone > Safe Zone Set-up**.

From the Safe Zone Set-up menu:

1. Select **Safe Zone Radius**.
 - i. Select the required radius for the safe zone.
2. Select **Time to Safe Zone**.
 - i. Select the required time period.
3. Select **AIS Alarm** so that On is highlighted.
Selecting AIS Alarm will switch the dangerous target alarm between On and Off.

Using MARPA

Acquiring a MARPA target to track

From the radar application:

1. Select the target to be acquired.
The MARPA context menu is displayed.
2. Select **Acquire Target**.

The "target being acquired" symbol is displayed. If the target is present for several scans, the radar locks-on to the target, and the symbol changes to "safe target" status.

Cancelling a MARPA target using the MARPA context menu

From the radar application:

1. Select the relevant target.
The MARPA context menu is displayed.
2. Select **Cancel Target** or **Cancel All Targets**.

Cancelling a MARPA target using the menu

1. Select **Menu**.
2. Select **Targets**.
3. Select **View Target Lists**.
4. Select **View MARPA List**.
5. Select the relevant MARPA target from the list.
6. Select **Cancel Target** or **Cancel All Targets**.

Vessel vectors (CPA graphics) overview

CPA graphics show vectors for your vessel and a selected target.

A vector is a line on-screen showing the predicted courses of your vessel and the selected target if you both remain on your present course. These vectors vary in length due to vessel speed and vector length set in the MARPA Set-up menu.

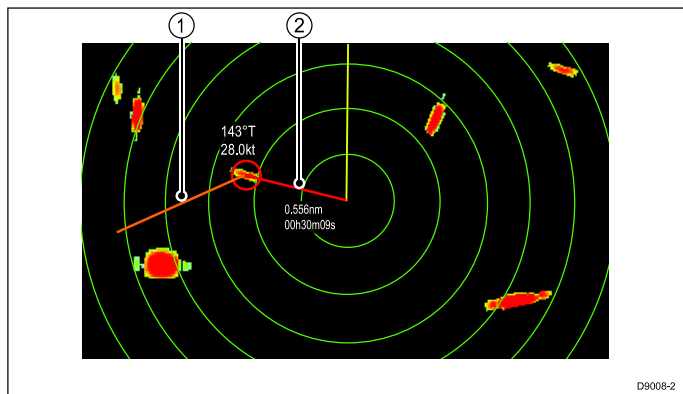

Item	Description
1	Target vector
2	CPA graphic

True motion

With the display set in true motion mode, the vectors of your vessel and the target are shown extended to their intersection point. The CPA is shown as a line that is placed on your vessel's vector at the point of the CPA. The length and direction of the line indicates the distance and bearing of the target at CPA. The text indicates CPA and TCPA. The text next to the target symbol indicates its true course and speed.

Relative motion

With the display set in relative motion mode, no vector extension of your vessel is shown. The CPA line emerges from your own vessel, with the target vector extension being shown as relative, not true. The text next to the target indicates its course and speed.

Displaying MARPA target data

- Select the target.
 - The MARPA context menu is displayed which provides the following data:
 - Closest Point of Approach (CPA).
 - Time to Closest Point of Approach (TCPA).
 - COG (if available).
 - SOG (if available).
- To display CPA graphics select **CPA Graphic** from the context menu:
 - Select **Auto** to display the CPA graphic when the target is selected.
 - Select **On** to display the CPA graphic while the target is being tracked.
 - Select **Off** to hide the CPA graphic.
- To display course and bearing information alongside to the target select **MARPA Data** so that Show is highlighted.
 - Selecting MARPA Data will switch between Show and Hide.

Viewing full MARPA target information

From the radar application:

- Select **Menu**.
- Select **Targets**.
- Select **View Target Lists**.
- Select **View MARPA List**.
- Select the relevant target.
- Select **View Full Target Data**.

Radar application

18.6 Distances, range, and bearing

When you are using the radar application, you can measure distances, ranges and bearings in a variety of ways.

These options are detailed in the table below:

Functions	Distances Between Points	Range From Your Vessel	Bearings
Range Rings	Yes (approximate distance)	Yes (approximate range)	No
Cursor	No	Yes	Yes
Variable Range Markers / Electronic Bearing Lines (VRM/EBL)	No	Yes	Yes
Floating VRM/EBL	Yes	No	Yes

Measuring using the range rings

Use the range rings to gauge the approximate distances between points. Range rings are concentric circles displayed on the screen and centred from your vessel at pre-set distances. The number and spacing of the rings changes as you range in and out.

Examples:

Range — 1/4 nm Range Rings — 760ft apart	Range — 3/4 nm Range Rings — 1/4 nm apart	Range — 1 1/2 nm Range Rings — 1/4 nm apart

Measuring using the cursor

To measure the bearing and range from your vessel to a specified target, move the cursor to the appropriate position on the screen and press **Ok**, the radar context menu will be displayed which shall provide:

- Latitude
- Longitude
- Range
- Bearing

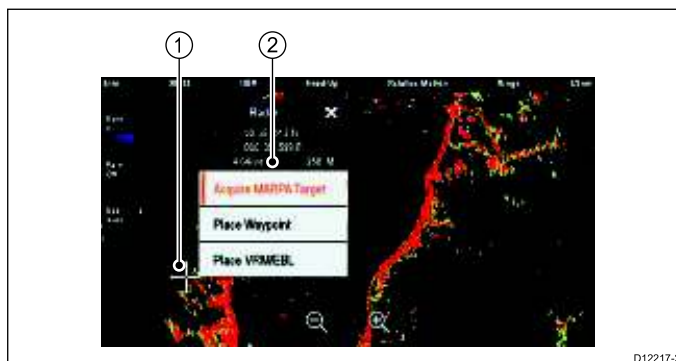

Item	Description
1.	Cursor
2.	Bearing and range from your vessel to the cursor position

You can also display the cursor position in the databar, from the homescreen select: **Customize > Databar Set-up > Edit Databar**, now select the data box where you want the cursor position to be displayed. Select **Navigation > Cursor Position**.

Measuring using VRM/EBL

Variable Range Markers (VRM)

A Variable Range Marker (VRM) is a circle centred on your vessel's position and fixed with respect to the heading mode. When this circle is adjusted to align with a target, its range from your vessel is measured and displayed on the Radar context menu when you select the VRM with the cursor.

Electronic Bearing Lines (EBL)

An Electronic Bearing Line (EBL) is a line drawn from your vessel to the edge of the window. When this line is rotated to align with a target, its bearing relative to your vessel's heading is measured and displayed on the Radar context menu when you select the VRM with the cursor.

The VRM/EBL are combined to measure both the range and the bearing of the specified target.

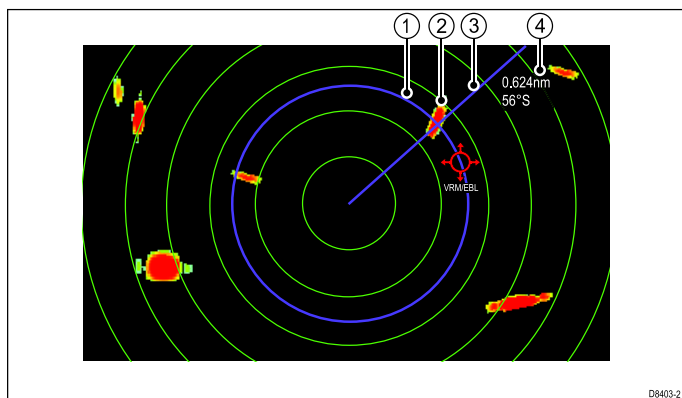

D8403-2

Item	Description
1	VRM
2	Target
3	EBL
4	Range and bearing

Measuring using floating VRM/EBL

You can use the VRM/EBL float function to measure the range and bearing between any two points on the radar screen. This function allows you to move the VRM/EBL centre away from your vessel's position and onto a target. You can then change the radius of the VRM to determine the distance between two points and change the angle of the EBL, relative to its new origin, to obtain the bearing.

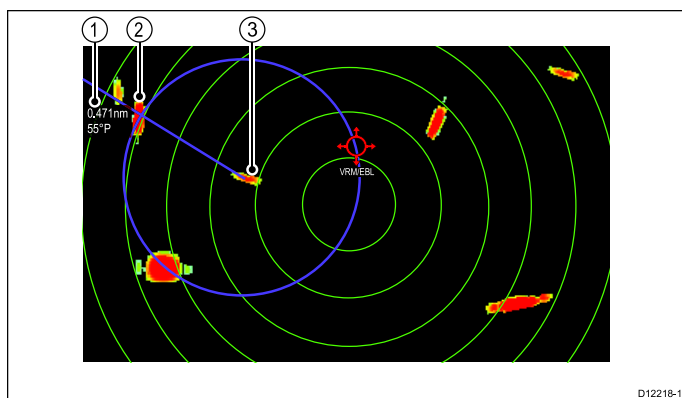

D12218-1

Item	Description
1	Range and bearing
2	Target 1
3	Target 2

VRM/EBL context menu

The VRM/EBL function includes a context menu which provides positional data and menu items.

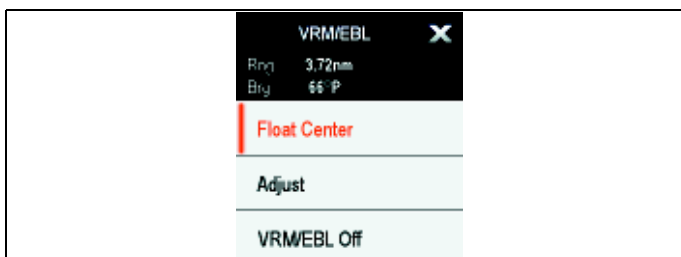

The context menu provides positional data of the VRM/EBL in relation to your vessel:

- Range
- Bearing

The context menu also provide the following menu items:

- **Float Centre**
- **Adjust**
- **VRM/EBL Off**

Accessing the context menu

You can access the context menu by following the steps below.

1. Non-touchscreen and HybridTouch displays:
 - i. Selecting a location, object or target on-screen and pressing the **Ok** button.
2. HybridTouch and Touch only displays:
 - i. Selecting an object or target on-screen.
 - ii. Selecting and holding on a location on-screen.



Creating a VRM/EBL on the radar display

To create a VRM/EBL on a touchscreen multifunction display follow the steps below:

From the radar application:

1. Select and hold on the screen.
The radar context menu is displayed.
2. Select **Place VRM/EBL**.
3. Select the required location / target.
The VRM/EBL is now set at the selected location.



Creating a VRM/EBL on the radar display

From the radar application:

1. Select a target or location on screen.
2. Press the **Ok** button.
The radar context menu is displayed.
3. Select **Place VRM/EBL**.
4. Using the **Joystick** adjust the VRM/EBL to the required bearing and range.
5. Press the **Ok** button to save the setting.



Creating a floating VRM/EBL on the radar display

To float a VRM/EBL on a touchscreen multifunction display follow the steps below:

From the radar application with a VRM/EBL already created:

1. Press and hold on the VRM/EBL.
The VRM/EBL context menu is displayed.
2. Select **Float Center**.
3. Select the desired location for the center position.
The VRM/EBL is placed at the new location.



Creating a floating VRM/EBL on the radar display

From the radar application with a VRM/EBL already created:

1. Position the cursor over the VRM/EBL.

- Press the **Ok** button.
The radar context menu is displayed.
- Use the **Rotary Control** to select **Float Center**.
- Press the **Ok** button.
- Using the **Joystick**, move the center position of the circle to the desired position.
- Press the **Ok** button to confirm the new position.

Unfloating a VRM/EBL on the radar display

To re-center a VRM/EBL on a touchscreen multifunction display follow the steps below:

From the radar application:

- Position the cursor over the VRM/EBL.
The Radar context menu is displayed.
- Select **Center**.

Unfloating a VRM/EBL on the radar display

From the radar application:

- Position the cursor over the VRM/EBL.
The VRM/EBL context menu is displayed.
- Press the **Ok** button.
- Select **Center**.

Using the radar range rings

Radar range rings enable you to measure the distance between two points on the radar display.

Use the range rings to gauge the approximate distances between points. Range rings are concentric circles displayed on the screen and centred from your vessel at pre-set distances. The number and spacing of the rings changes as you range in and out.

Examples:

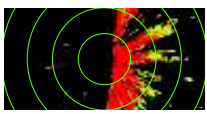
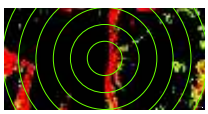
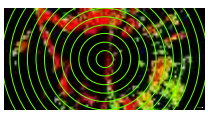
		
Range — 1/4 nm Range Rings — 760ft apart	Range — 3/4 nm Range Rings — 1/4 nm apart	Range — 1 1/2 nm Range Rings — 1/4 nm apart

Enabling and disabling radar range rings

From the radar application:

- Select **MENU**.
- Select **Presentation**.
- Select **Range Rings**.
Selecting Range rings will switch the range rings On and Off.

18.7 Radar mode and orientation

Radar orientation modes

The radar can operate in a number of orientation modes to suit different types of navigation.

The orientation of the radar refers to the relationship between the radar and the direction that you are travelling in. There are three orientation modes to choose from:

- Head-Up
- North-Up
- Course-Up

These orientation modes are used in conjunction with motion mode to control how your boat and radar relate to one another and how they are displayed on screen. Any changes that you make to the orientation of the radar are retained when you switch off your multifunction display.

Head-Up

This is the default mode for the radar application.

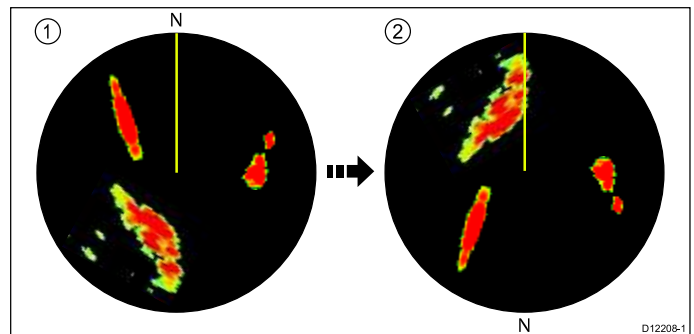

Item	Description
1	Ship's Heading Marker (SHM) (indicating the vessel's current heading is upwards).
2	As the vessel's heading changes: <ul style="list-style-type: none"> • SHM is fixed upwards • Radar picture rotates accordingly

North-Up

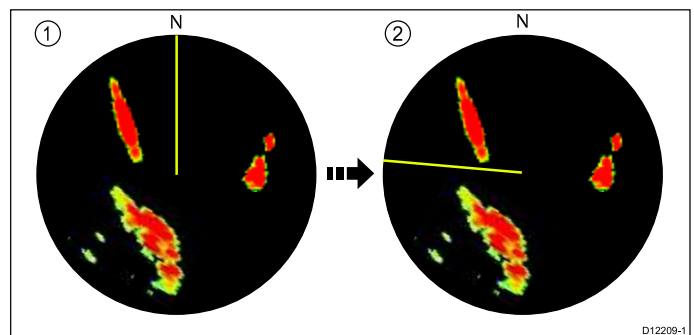

Item	Description
1	True north at top.
2	As your vessel's heading changes: <ul style="list-style-type: none"> • Radar picture is fixed (north up) • SHM rotates accordingly

Note: If heading data becomes unavailable whilst in this mode, a warning message will be shown, the status bar indicates North-Up in brackets and the radar uses 0° heading in relative motion. When heading data becomes available once more, North-Up mode is reinstated.

Note: It is not possible to select Head Up mode when the motion mode is set to True.

Course-Up

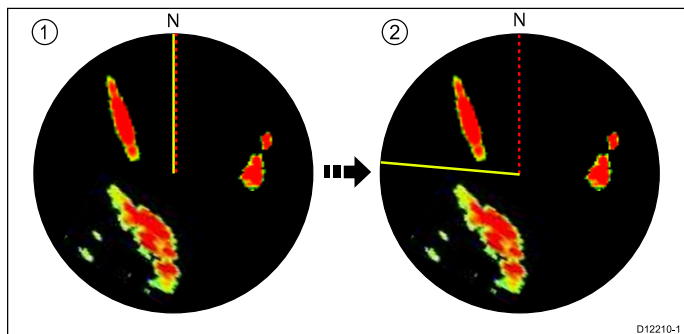

Item	Description
1	Current course upwards.
2	As your vessel's heading changes: <ul style="list-style-type: none"> • Radar picture is fixed • SHM rotates accordingly

If you select a new course, the picture will reset to display the new course upwards.

The reference used for Course-Up depends upon the information available at a given time. The system always prioritizes this information in the following order:

1. Bearing from origin to destination, that is, intended course.
2. Locked heading from an Autopilot.
3. Bearing to waypoint.
4. Instantaneous heading (when course-up is selected).

Note: If heading data becomes unavailable whilst in this mode, a warning message will be shown, the status bar indicates the Course Up in brackets and the radar uses 0° heading in relative motion. When heading data becomes available once more, Course-Up mode is reinstated.

Selecting the radar orientation mode

From the radar application:

1. Select **Menu**.
2. Select **Presentation**.
3. Select **Orientation & Motion Mode**.
4. Select **Orientation**.
5. Select the required orientation.

Radar motion modes overview

The motion mode controls the relationship between the radar and your vessel. There are two modes:

- Relative motion.
- True motion.

The selected motion mode is displayed in the status bar. The default setting is Relative Motion with no offset.

Relative Motion (RM) with optional Vessel Offset

When the motion mode is set to Relative, the position of your vessel is fixed on the screen and all the targets move relative to the vessel. You can specify whether the vessel is fixed in the center of the window, partially offset or fully offset to increase the view ahead, as shown below:

Examples:

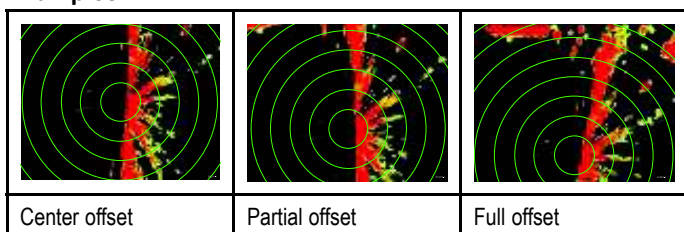

The default motion mode is "Relative", with center offset.

True Motion (TM)

When the motion mode is set to True, fixed radar targets maintain a constant position and moving vessels (including your vessel) travel in true perspective to each other and to fixed landmasses on the screen. As the vessel's position approaches the edge of the screen, the radar picture is automatically reset to reveal the area ahead.

Note: If heading and position data become unavailable when True motion is selected, a warning message will be shown, the mode will revert to relative motion and be noted in the status bar in brackets, for example, (TM).

Note: It is not possible to select True Motion when the orientation is set to Head Up.

Selecting the radar motion mode

From the radar application:

1. Select **Menu**.
2. Select **Presentation**.
3. Select **Orientation & Motion Mode**.
4. Select **Motion Mode**.
Selecting Motion Mode will switch between True and Relative.

Changing the radar vessel offset

Radar offset is only available in Relative motion mode.

From the radar application:

1. Select **Menu**.
2. Select **Presentation**.
3. Select **Orientation & Motion Mode**.
4. Select **Boat Offset**.
5. Select the required offset value.

18.8 Radar presentation menu options

Function	Description	Options
Dual Range	This menu item allows you to turn Dual range mode On and Off.	<ul style="list-style-type: none"> • On • Off
Dual Range Channel	This menu item allows you to choose long or short channel for dual range.	<ul style="list-style-type: none"> • 1 • 2
Orientation & Motion Mode	<p>This menu item contains a sub-menu which enables you to adjust the orientation and motion mode:</p> <ul style="list-style-type: none"> • Orientation • Motion Mode • Boat Offset 	<p>Orientation</p> <ul style="list-style-type: none"> • Head Up • North Up • Course Up <p>Motion Mode</p> <ul style="list-style-type: none"> • True • Relative <p>Boat Offset</p> <ul style="list-style-type: none"> • Center (default) • Partial Offset • Full Offset
Select Waypoints to Display	This menu item takes you to the Display Waypoints dialog where you can choose which waypoint icons to Show/Hide in the radar application.	<p>Display Waypoint</p> <ul style="list-style-type: none"> • Show • Hide
Waypoint Name	This menu item allows you to show or hide waypoint names in the radar application.	<ul style="list-style-type: none"> • Show • Hide
Enhance Echoes	<p>This menu item contains a sub-menu which enable you to adjust the follow options:</p> <ul style="list-style-type: none"> • Interference Rejection • IR Level — only available on non-HD digital radomes. • Expansion • Expansion Level — only available on non-HD digital radomes. • Wakes • Wakes Period 	<p>Interference Rejection</p> <ul style="list-style-type: none"> • On • Off <p>IR Level — only available on non-HD digital radomes.</p> <ul style="list-style-type: none"> • Normal • High <p>Expansion</p> <ul style="list-style-type: none"> • On • Off <p>Expansion Level — only available on non-HD digital radomes.</p> <ul style="list-style-type: none"> • Low • High <p>Wakes</p> <ul style="list-style-type: none"> • On • Off <p>Wakes Time Period</p> <ul style="list-style-type: none"> • 10 Secs • 30 Secs • 1 Min • 5 Min • 10 Min

Function	Description	Options
Color Palette	This menu item allows you to select a Color Palette for the radar application.	<ul style="list-style-type: none"> • Bold • Professional 1 • Professional 2 • Classic • Night Vision
Range Rings	This menu item allows you to turn the range rings On and Off.	<ul style="list-style-type: none"> • On • Off
Safe Zone Ring	This item allows you to show or hid the safe zone ring in the radar application.	<ul style="list-style-type: none"> • Show • Hide
Gain Controls	This item allows you to show or hide the onscreen gain controls on multifunction displays with a touchscreen.	<ul style="list-style-type: none"> • Show • Hide
Databoxes	<p>This menu item contains a sub-menu which enables you to turn on and select information to display in data cells located on the bottom left of the radar application (Data cells will be displayed in all radar windows).</p> <ul style="list-style-type: none"> • Data Cell 1 • Select Data Category • Data Cell 2 • Select Data Cell 	<p>Data Cell 1 & 2</p> <ul style="list-style-type: none"> • On • Off <p>Select Data Cell</p> <ul style="list-style-type: none"> • List of available data by category

Enhance echoes functions

Enabling radar interference rejection

From the radar application:

1. Select **Menu**.
2. Select **Presentation**.
3. Select **Enhance Echoes**.
4. Select **Interference Rejection** so that On is highlighted.
Selecting Interference Rejection will switch the function between On and Off.
5. For non-HD digital radomes you can also select an interference rejection level:
 - i. Select **IR Level**.
Selecting IR Level will switch between Normal and High.

Enabling radar expansion

From the radar application:

1. Select **Menu**.
2. Select **Presentation**.
3. Select **Enhance Echoes**.
4. Select **Expansion** so that On is highlighted.
Selecting expansion will switch the function between On and Off.
5. For non-HD digital radomes you can also select an interference rejection level
 - i. Select **Expansion Level**.
Selecting Expansion Level will switch between Low and High.

Radar wakes (Trails)

Radar wakes enable you to see target history. Wakes will appear differently depending on whether your radar is set to True motion mode or Relative motion mode.

Relative motion mode

In relative motion mode radar wakes appear on targets that are moving relative to the sea (Sea stabilized) this includes targets that are fixed to the ground, such as piles.

Wakes do not appear if a target is moving at the same speed and in the same direction as your vessel.

Relative motion mode example

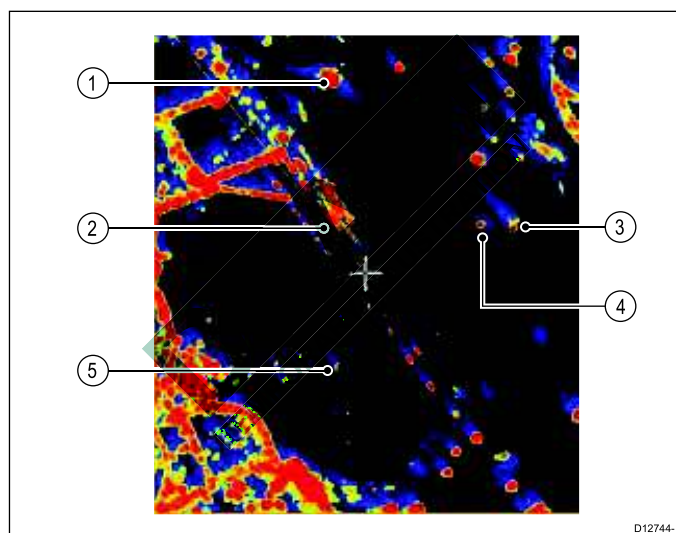

1	Target moving faster and in the same direction as vessel (Wake appears towards your vessel's heading).
2	Ships heading marker.
3	Target moving in opposite direction to vessel (Wake appears opposite to your vessel's heading).
4	Target moving at approximately the same speed and direction as vessel (Minimal to no wake).
5	Fixed target (Wake in opposite direction to your vessel's heading).

True motion mode

In true motion mode radar wakes appear on targets that are moving relative to the ground.

Wakes do not appear on targets that are fixed to the ground.

True motion mode example

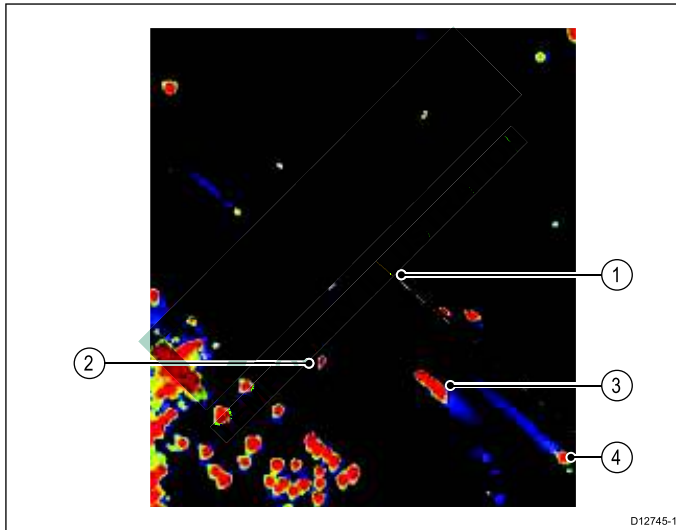

1	Ships heading marker.
2	Target travelling at between 0 kt to 1 kt (Minimal to no wake).
3	Target moving in opposite direction to vessel (Wake appears in opposite direction to your vessel's heading).
4	Target moving in same direction as vessel (Wake appears towards your vessel's heading).

Note: You may see a wake 'ring' around fixed targets due to small error factors such as rotation time delays. This is normal operation.

Enabling radar wakes

From the radar application:

1. Select **Menu**.
2. Select **Presentation**.
3. Select **Enhance Echoes**.
4. Select **Wakes** so that On is highlighted.
Selecting Wakes will switch the function between On and Off.
5. Select **Wakes time period**.
A list of wake time periods is displayed:
 - 10 sec
 - 30 sec
 - 1 min
 - 5 min
 - 10 min
6. Select the required time period.

18.9 Radar tuning: On-screen gain controls

Touchscreen multifunction displays provide on-screen access to controls for Gain, Rain and Sea clutter.

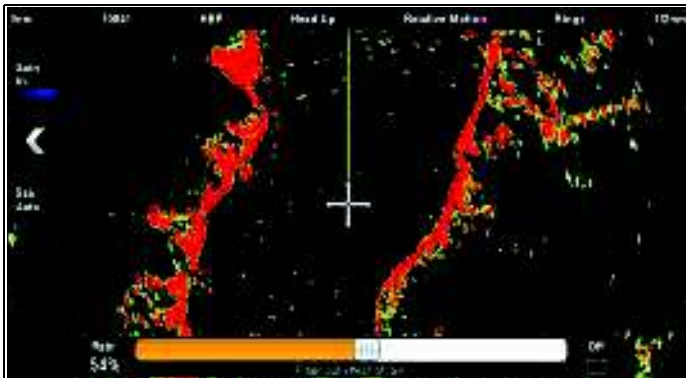

Gain control



Rain control



Sea control



Note: non-touchscreen controls are accessed by the menu options: **Menu > Rain** and **Menu > Adjust Gain**.

Enabling and disabling on-screen gain controls

You can enable and disable the on-screen gain controls by following the steps below.

On a touchscreen multifunction display, with the relevant application displayed.

1. Select **Menu**.
2. Select **Presentation**.
3. Select **Gain Controls**.

Selecting Gain Controls will switch between showing and hiding the on-screen controls.

Note: When the on-screen Gain controls are set to Hidden then the Gain settings can be accessed directly from the application menu: **Menu > Gain**.

Using the on-screen gain controls

To adjust settings using the on-screen controls follow the steps below.

On a touchscreen multifunction display, with the radar application displayed:

1. Select either the **Gain**, **Rain** or **Sea** on-screen icon.
The on-screen slider bar control is displayed.
2. Select the **Auto** box (Gain and Sea) or **Off** box (Rain) so that a tick is **placed** in the box to switch to automatic control or switch the control off, or
3. Select the **Auto** box (Gain and Sea) or **Off** box (Rain) so that a tick is **removed** placed in the box to switch to manual control.
4. Adjust the slider bar to the required setting.
5. The slider bar will auto dismiss, or you can select the on-screen icon again to close the slider bar.

18.10 HD and SuperHD radar adjustments

You can use the presets and other functions to improve the quality of the radar picture.

The following settings are available from the Radar menu and apply to HD radomes, HD and SuperHD open array scanners:

Menu Item	Description	Options
Preset Mode	The radar gain presets enable you to quickly select pre-configured settings to achieve the best picture in different situations. Raymarine strongly recommends the use of these presets to achieve optimum results.	<ul style="list-style-type: none"> • Buoy — a special mode that enhances the detection of small objects like mooring buoys. It is useful at ranges up to 0.75 nm. • Harbor — this is the default mode. This setting takes account of land clutter so that smaller targets, like navigation buoys, are not lost. • Coastal — accounts for the slightly higher levels of sea clutter you might encounter out of harbor and adjusts the radar display accordingly. • Offshore — automatically adjusts for high levels of sea clutter. • Bird Mode — a special mode that helps you to identify flocks of birds, useful when identifying suitable fishing locations, for example. <div style="border: 1px solid black; padding: 5px; margin-top: 10px;"> <p>Note: Bird Mode requires a SuperHD open array with software version 3.23 or above or an HD radome.</p> </div>
Rain	The radar scanner detects echoes from rain or snow. These echoes appear on screen as countless small echoes continuously changing size, intensity and position. Turning the rain clutter function On suppresses the bulk effect of rain returns from around your vessel, making it easier to recognize other objects. You can adjust the intensity of this setting between 0 and 100%.	<ul style="list-style-type: none"> • On — enables the Rain function and allows you to adjust the setting between 0 and 100%. • Off — disables the Rain function. This is the default.
Adjust Preset	Each of the gain presets can be manually adjusted using gain, color gain and sea clutter functions.	<ul style="list-style-type: none"> • Gain — enables you to use a preset in automatic mode, or to adjust its gain manually between 0 and 100%. • Color Gain— adjusts the intensity (color) of displayed targets, but does not affect the number of targets displayed. Increasing the color gain causes more targets to be displayed in the same color, which may help you to determine whether an object is an actual target, or just background noise. Reducing the color gain may provide better target detail and detection. • Sea — radar echoes from waves around your vessel can clutter the center of the radar picture, making it difficult to detect real targets. Adjusting the sea gain reduces this clutter for up to 5 nautical miles (depending on wave and sea conditions) from your vessel. • SuperHD Controls — for SuperHD scanners only: <ul style="list-style-type: none"> – Antenna Boost: scales the effective antenna size. At zero, the effective antenna size matches its actual size. At 95%, the effective antenna size is doubled. Increasing the effective antenna size separates targets that appear merged at lower settings. – Power Boost: adjusts effective transmit power. At zero, the radar operates at its standard power (4 kW or 12 kW). At 90, the effective power is increased by a factor of at least two. Increasing the power makes targets more distinct from noise. For maximum benefit, reduce power boost to prevent saturation of strong targets.

Selecting radar presets

These presets require a HD or SuperHD radar scanner. Bird mode requires a SuperHD open array scanner with software version 3.23 or above or an HD radome.

From the Radar application menu:

1. Select **Preset Mode**.
2. Select Buoy, Harbor, Coastal, Offshore, or Bird as appropriate.

Adjusting radar preset gain

Raymarine strongly recommends the use of the preset gain modes to achieve optimum results. However if required manual adjustments can be made.

From the Radar application menu, with the required **Preset Mode** selected:

1. Select **Adjust Preset <Mode>**, where <Mode> shall be the Preset mode already selected.
2. Select **Gain**.
3. The Gain slider bar control is displayed.

4. Adjust the Gain slider bar control to the appropriate setting (between 0 and 100%), or
5. Select the **Auto** box so that a tick is placed in the box for automatic gain control.

Adjusting radar preset color

From the Radar application menu, with the required **Preset Mode** selected:

1. Select **Menu**.
2. Select **Adjust Preset <Mode>**, where <Mode> shall be the Preset mode already selected.
3. Select **Col:**.
4. The Color slider bar control is displayed.
5. Adjust the Color slider bar control to the appropriate setting (between 0 and 100%), or
6. Select the **Auto** box so that a tick is placed in the box for automatic color control.

Adjusting radar anti sea clutter

From the Radar application menu, with the required **Preset Mode** selected:

1. Select **Adjust Preset <Mode>**, where <Mode> shall be the Preset mode already selected.
2. Select **Sea:** .
3. The Sea clutter slider bar control is displayed.
4. Adjust the Sea clutter slider bar control to the appropriate setting (between 0 and 100%), or
5. Select the **Auto** box so that a tick is placed in the box for automatic sea clutter control.

Adjusting radar anti rain clutter

From the radar application:

1. Select **Menu**.
2. Select **Rain**.
The Rain clutter slider bar control is displayed.
3. Adjust the Rain clutter slider bar control to the appropriate setting (between 0% and 100%), or
4. Select the **Off** box so that a tick is placed in the box to turn off anti rain clutter control.

Adjusting SuperHD radar antenna boost

From the Radar application menu:

1. Select **Adjust Preset <Mode>**, where <Mode> shall be the Preset mode already selected.
2. Select **Antenna**.
The Antenna Boost slider bar control is displayed.
3. Adjust the Antenna Boost slider bar control to the appropriate setting (between 0 and 100%), or
4. Select the **Auto** box so that a tick is placed in the box for automatic boost control.

Adjusting SuperHD radar power boost

From the Radar application menu:

1. Select **Adjust Preset <Mode>**, where <Mode> shall be the Preset mode already selected.
2. Select **Power**.
The Power Boost slider bar control is displayed.
3. Adjust the Power Boost slider bar control to the appropriate setting (between 0 and 100%), or
4. Select the **Auto** box so that a tick is placed in the box for automatic boost control.

18.11 Non-HD digital radomes adjustments

You can use the gain presets and other functions to improve the quality of the radar picture.

The following settings apply to non-HD digital radomes and are available from the Radar menu:

Menu Item	Description	Options
Rain	The radar scanner detects echoes from rain or snow. These echoes appear on screen as countless small echoes continuously changing size, intensity and position. Turning the rain clutter function On suppresses the bulk effect of rain returns from around your vessel, making it easier to recognize other objects. You can adjust the intensity of this setting between 0 and 100%.	<ul style="list-style-type: none"> • On — enables the Rain function and allows you to adjust the setting between 0 and 100%. • Off — disables the Rain function. This is the default.
Adjust Preset	<p>Enables you to adjust the sensitivity of the radar reception. In some situations, adjusting the sensitivity may improve the clarity of the radar picture. The following settings are available:</p> <ul style="list-style-type: none"> • Gain • FTC — Enables you to remove areas of clutter at a distance from your vessel. It also helps you to distinguish between two very close echoes on the same bearing, which may otherwise merge and appear as one echo. You can adjust the intensity of the FTC function between 0 and 100%: <ul style="list-style-type: none"> – A higher setting shows only the leading edge of large (rain clutter) echoes, while the effect on smaller (ship) echoes is only slight. – A lower setting reduces background noise and fill-in returns from land and other large targets. • Sea — Enable you to quickly select pre-configured settings to achieve the best picture in different situations. Each of the gain presets has a gain function, which is set to automatic mode by default. Raymarine strongly recommends the use of these presets to achieve optimum results. However, you can adjust this gain manually if required. • Auto Sea Mode 	<p>Gain</p> <ul style="list-style-type: none"> • Auto — the preset operates in automatic mode. This is the default. • Man — allows you to manually adjust the intensity of the gain, from 0 to 100%. <p>FTC</p> <ul style="list-style-type: none"> • On — enables the FTC function and allows you to adjust the setting between 0 and 100%. • Off — disables the FTC function. This is the default. <p>Sea</p> <ul style="list-style-type: none"> • Auto— the preset operates in automatic mode. This is the default. • Man— allows you to manually adjust the intensity of the sea gain, from 0 to 100%. <p>Auto Sea Mode</p> <ul style="list-style-type: none"> • Harbor — this is the default mode. This setting takes account of land clutter so that smaller targets, like navigation buoys, are not lost. • Coastal — accounts for the slightly higher levels of sea clutter you might encounter out of harbor and adjusts the radar display accordingly. • Offshore — Automatically adjusts for high levels of sea clutter.

Adjusting radar anti rain clutter

From the radar application:

1. Select **Menu**.
2. Select **Rain**.
The Rain clutter slider bar control is displayed.
3. Adjust the Rain clutter slider bar control to the appropriate setting (between 0% and 100%), or
4. Select the **Off** box so that a tick is placed in the box to turn off anti rain clutter control.

1. Select **Adjust Preset <Mode>**, where <Mode> shall be the Preset mode already selected.
2. Select **Sea** .
3. The Sea clutter slider bar control is displayed.
4. Adjust the Sea clutter slider bar control to the appropriate setting (between 0 and 100%), or
5. Select the **Auto** box so that a tick is placed in the box for automatic sea clutter control.

Adjusting the radar FTC function

From the radar application:

1. Select **Menu**.
2. Select **Adjust Preset <Mode>**, where <Mode> shall be the Preset mode already selected.
3. Select **FTC**.
The FTC slider bar control is displayed.
4. Adjust the FTC slider bar control to the appropriate setting (between 0 and 100%), or
5. Select the **Auto** box so that a tick is placed in the box for automatic FTC control.

Selecting radar preset mode

These presets require a digital radar scanner.

From the radar application:

1. Select **Menu**.
2. Select **Preset Mode**.
3. Select Harbor, Coastal or Offshore as appropriate.

Adjusting radar anti sea clutter

From the Radar application menu, with the required **Preset Mode** selected:

18.12 Dual range radar operation

The Dual Range radar function enables you to view 2 ranges at the same time in separate windows. The function is available with SuperHD and HD radar scanners.

Using your multifunction display and an HD or SuperHD radar scanner, you can view either a short or a long range image in separate radar windows.

The default setting is Long, which provides a standard scanner range.

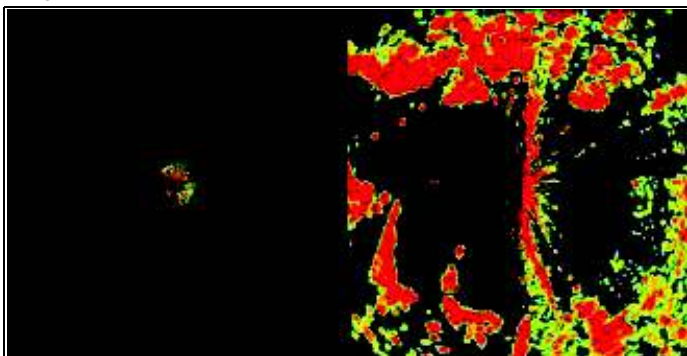

Limitations

- Dual Range operation is not available if MARPA targets are active.
- You cannot acquire MARPA targets if Dual Range is enabled.
- Radar/chart sync and radar/chart overlay are temporarily disabled when Dual Range is enabled.

Dual range radar compatibility

The range covered by the short Dual Range option depends on the radar scanner you are using, and the software version it is using.

Scanner	Dual range mode	*Range covered by software versions 1.xx to 2.xx	Range covered by software versions 3.xx onwards
4 Kw HD Open Array	Long (1)	1/8 nm to 72 nm	1/8 nm to 72 nm
	Short (2)	1/8 nm to 3 nm	1/8 nm to 72 nm
4 Kw SuperHD Open Array	Long (1)	1/8 nm to 72 nm	1/8 nm to 72 nm
	Short (2)	1/8 nm to 3 nm	1/8 nm to 72 nm
12 Kw HD Open Array	Long (1)	n/a	1/8 nm to 72 nm
	Short (2)	n/a	1/8 nm to 72 nm
12 Kw SuperHD Open Array	Long (1)	1/8 nm to 72 nm	1/8 nm to 72 nm
	Short (2)	1/8 nm to 3 nm	1/8 nm to 72 nm
HD Radome	Long (1)	1/8 nm to 48 nm	1/8 nm to 48 nm
	Short (2)	1/8 nm to 48 nm	1/8 nm to 48 nm

Limitations of software version 1.xx and 2.xx

- The value for the short range setting must be less than or equal to the long range setting.
- With **Dual Range** On and a short range window active Expansion control shall be disabled in the **Enhance Echoes** menu.

Using Dual Range with SuperHD scanners

Dual range radar operation with SuperHD scanners.

When using the short Dual Range option, a SuperHD scanner operates in HD mode only. When using the long Dual Range option, a SuperHD radar operates in SuperHD mode.

Scanner	Dual Range mode	Operating mode
4 Kw SuperHD Open Array	Long	SuperHD
	Short	HD
12 Kw SuperHD Open Array	Long	SuperHD
	Short	HD

Enabling Dual Range radar operation

In the radar application.

1. Select **Menu**.
2. Select **Presentation**.
3. Select **Dual Range** so that On is highlighted.
Selecting Dual Range will switch between dual range On and Off.

Selecting range operation

With Dual Range set to on and the radar application screen displayed:

1. Select **Menu**.
2. Select **Presentation**.
3. Select **Dual Range Channel** to switch between 1 or 2, as appropriate.

18.13 Radar scan speed

SuperHD open array radars with software version 3.23 or above or HD radomes support multiple scan speeds.

Radar scan speed is set up using the Radar Set-up menu. When the system detects a scanner that is capable of operating at both 24 RPM and 48 RPM, 2 options are provided for scanner speed:

- 24 RPM
- Auto

If you have a radar scanner that only operates at 24 RPM, the scanner speed option is disabled. If the scanner speed option is enabled, you must select the Auto option if you want to use the higher scan speeds. This option automatically switches between the 24 RPM and 48 RPM scan speeds as appropriate.

Selecting radar scan speed

Follow the steps below to change the radar speed.

The speed option requires a 48 RPM compatible Raymarine HD radome or Raymarine SuperHD open array radar scanner.

Select your radar scanner speed from within the radar application.

1. Select **Menu**.
2. Select **Radar Set-up**.
3. Select **Radar Speed**
4. Select the required scanner speed:
 - Auto
 - 24 RPM

The Auto option automatically selects the appropriate speed for your radar range. 48 RPM is used at radar ranges of up to 3 nm. It provides an increased refresh rate, which is useful at high speed or in areas where you have large numbers of radar targets. At radar ranges of greater than 3 nm the display switches the radar speed to 24 RPM.

18.14 Radar Set-up menu

The Radar Set-up menu enables you to configure the performance and behavior of your radar scanner.

Function	Description	Options
Timed Transmit Set-up	This menu item contains a sub-menu that enables you to adjust the timed transmit options: <ul style="list-style-type: none"> • Timed Transmit • Transmit Period • Standby Period 	Timed Transmit <ul style="list-style-type: none"> • On • Off Transmit Period <ul style="list-style-type: none"> • 10 Scans • 20 Scans • 30 Scans Standby Period <ul style="list-style-type: none"> • 3 minutes • 5 minutes • 10 minutes • 15 minutes
Tune Adjust	This menu item allows you to fine tune the radar scanner's receiver for maximum returns on the display. Raymarine recommends that this function is set to Auto. If you set this function to Manual and adjust the setting shortly after powering up the radar scanner, you should adjust it again approximately 10 minutes after powering up the scanner, as the required setting will change after the magnetron has warmed up.	Man <ul style="list-style-type: none"> • Auto • Man 0% — 100%
EBL Reference	The measurement point used for reference when measuring distances using Electronic Bearing Lines (EBLs) and range rings in the chart application. The options are Relative to ships heading or referenced to the compass is degrees Magnetic — True as selected in Bearing Mode.	<ul style="list-style-type: none"> • Relative • Mag-True
Sea Clutter Curve	This menu item allows you to adjust the Sea Clutter — radar echoes from waves can make it difficult to detect real targets. These echoes are known as "sea clutter". Several factors can affect the level of clutter you see, including the weather and sea conditions, and the mounting height of the radar. The sea clutter curve setting adjusts the radar's sensitivity to sea clutter. The steepest setting for the curve is 1, and the most shallow setting is 8.	<ul style="list-style-type: none"> • Adjust Curve (1 to 8)
Scanner Speed	SuperHD open array radars with software version 3.23 or above or HD radomes support multiple scan speeds: <ul style="list-style-type: none"> • 24 RPM • 48 RPM 	Scanner Speed <ul style="list-style-type: none"> • 24 RPM • Auto — this option automatically switches between the 24 RPM and 48 RPM scan speeds as appropriate.
Advanced	This menu item contains a sub-menu that enables you to adjust the following options: <ul style="list-style-type: none"> • Bearing Alignment • Display Timing • Main Bang Suppression • Tune Preset • STC Preset— Non-HD Digital radomes only • Reset Advanced 	Bearing Alignment <ul style="list-style-type: none"> • -180° — 179.5° Display Timing <ul style="list-style-type: none"> • 0.415 n m — selected range Main Bang Suppression <ul style="list-style-type: none"> • On • Off Tune Preset <ul style="list-style-type: none"> • 0 — 255 STC Preset <ul style="list-style-type: none"> • 0 — 100% Reset Advanced <ul style="list-style-type: none"> • Yes • No

Adjusting the radar tune control

From the radar application:

1. Select **Menu**.
2. Select **Radar Set-up**.
3. Select **Tune Adjust**.
4. Select **Tune Adjust**: .
The Tune Adjust slider bar control is displayed.
5. Adjust the slider bar control to the appropriate setting, or
6. Select the **Auto** box so that a tick is placed in the box for automatic tuning.

18.15 Resetting the radar

To reset radar settings to defaults follow the steps below:

From in the radar application:

1. Select **Menu**.
2. Select **Radar Set-up**.
3. Select **Advanced**.
4. Select **Reset Advanced**.
A confirmation pop up message is displayed.
5. Select **Yes** to confirm reset.

Chapter 19: Data application

Chapter contents

- [19.1 Data application overview on page 230](#)
- [19.2 !\[\]\(36f8637baaa56c4be44b454435949289_img.jpg\) Selecting datapages using touch on page 232](#)
- [19.3 !\[\]\(b556e0ef1e10ccfc32976edb6416074f_img.jpg\) Selecting datapages on page 232](#)
- [19.4 Customizing the data application on page 233](#)
- [19.5 Resetting minimum and maximum readings on page 245](#)
- [19.6 Resetting all datapages on page 245](#)

19.1 Data application overview

The Data application enables you to view data generated by the multifunction display or data that is available on your system.

Data can be obtained from devices connected using SeaTalk^{hs}, SeaTalk^{ng} or NMEA protocols.



Pre-configured datapages

The default datapage configuration is dependant upon the boat type selected during the initial set-up wizard.

Each datapage consists of a number of 'cells', that display the information.

Default datapage configuration is shown below:

Motor vessel		Sailing vessel	
Page number	Page	Page number	Page
1/6	Engine	1/5	Engine
2/6	Navigation	2/5	Navigation
3/6	Environment	3/5	Sailing
4/6	Fishing	4/5	Environment
5/6	Fuel	5/5	Rolling road
6/6	Rolling road		

Note: Datapage selection is a local setting, and therefore only affects the individual display that you are currently using. It does not affect any networked displays.

Engine page

The Engine page is available for all boat types. The dials and type of data displayed is dependent on the **Number of engines** set in the Boat Details settings.

Important: The relevant engine data must be available on your network for the Engine page to show engine data.

Example — engine page for 2 engine vessel.

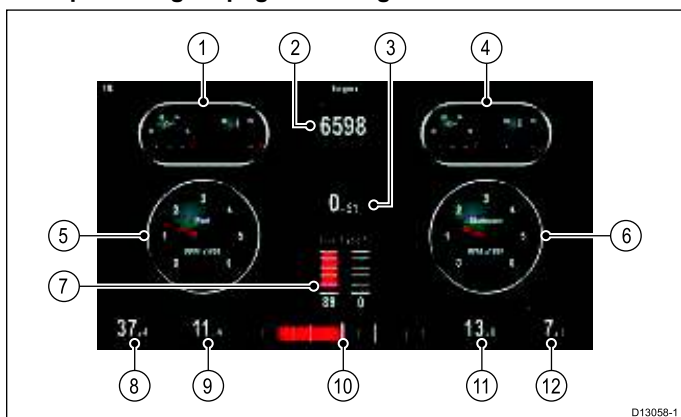

1. Port engine combined oil pressure and coolant temperature dial
2. Total fuel

3. Engine Economy total
4. Starboard engine combined oil pressure and coolant temperature dial
5. Port engine RPM dial
6. Starboard engine RPM dial
7. Trim tabs
8. SOG
9. Port alternator
10. Rudder bar
11. Starboard alternator
12. Depth

Navigation page

The Navigation page is available for all boat types.

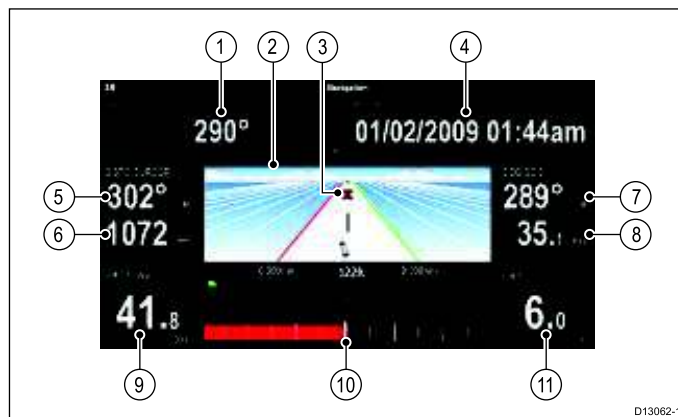

1. Heading
2. Rolling road
3. Target waypoint
4. Waypoint ETA (Estimated time of arrival)
5. Heading to target waypoint
6. Distance to target waypoint
7. COG
8. SOG
9. VMG to waypoint
10. Rudder bar
11. Depth

Sailing page

When the boat type has been configured as a sailing vessel, the Sailing page is available in the Data application.

The Sailing page includes compass and wind dials that displays various data designed specifically for sailing vessel.



1. Compass dial
2. Wind dial
3. Waypoint icon — Only displayed during active navigation.

4. **Heading** (red) and **COG** (green) arrows
5. **True wind arrow** (yellow)
6. **Apparent wind arrow** (yellow)
7. **Tide arrow** (blue)

Environment page

The Environment page is available for all boat types.



1. Wind dial
2. AWAS and AWS
3. Air temperature
4. Water temperature
5. Set
6. AWS
7. Drift
8. TWS
9. True wind arrow
10. Apparent wind arrow

Fishing page

The Fishing page is available when the boat type is set to a motor vessel.



1. Water temperature
2. Live well
3. Time
4. Target waypoint range and bearing
5. Waypoint TTG
6. SOG
7. Depth

Fuel page

The Fuel page is available when the boat type is set to a motor vessel.

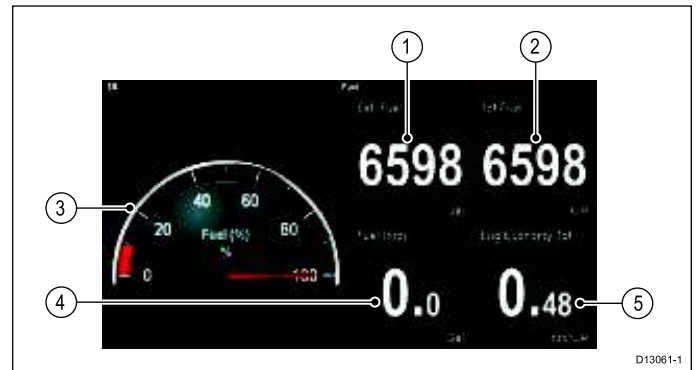

1. Estimated fuel
2. Total fuel
3. Fuel gauge
4. Fuel (trip)
5. Engine economy total

Rolling road

The Rolling road page is available for all boat types.

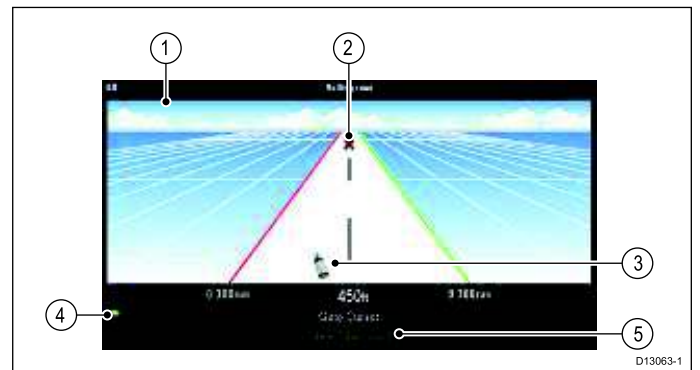

1. Rolling road
2. Target waypoint
3. Vessel icon
4. Course correction indicator
5. Course correction details

19.2 Selecting datapages using touch

You can scroll through all available pages using the touchscreen.

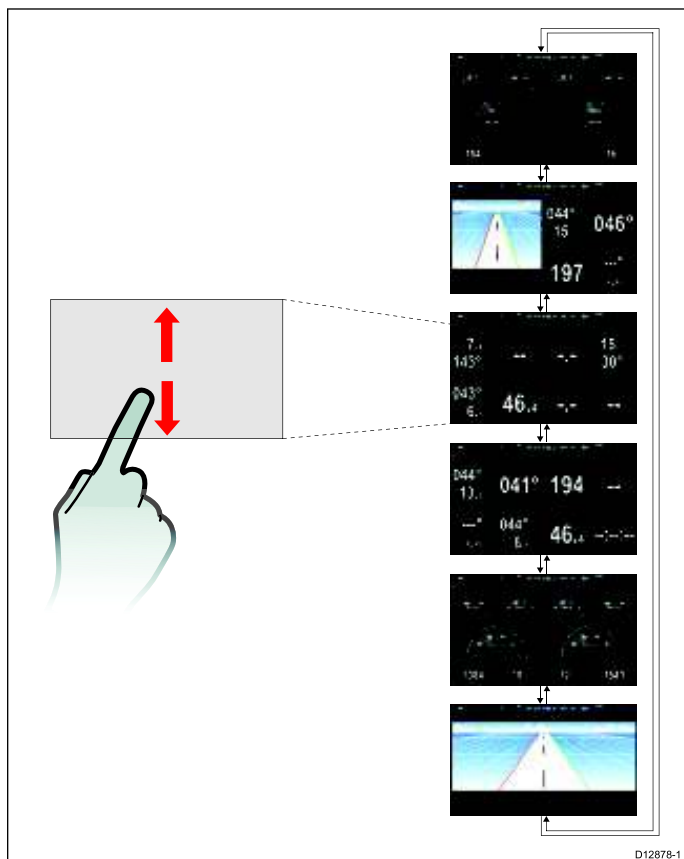

From the Data application:

1. Touch the screen.
2. Slide your finger up and let go of the screen to go to the next datapage.
3. Slide your finger down and let go of the screen to go to the previous datapage.

19.3 Selecting datapages

To select datapages using a non-touch multifunction display follow the steps below.

From the data application:

1. Move the **Joystick Down** to goto the next page, or
2. Move the **Joystick Up** to goto the previous page.

19.4 Customizing the data application

You can customize the data application to show the system and instrument data that you require.

In addition to displaying the default, pre-configured datapages in the data application, you can also:

- Change the order datapages appear.
- Customize datapages content to your specific requirements.
- Rename the datapages.
- Add new custom datapages.
- Delete existing datapages.
- Set boat details such as number of engines, fuel tanks, and batteries.
- Set the maximum engine RPM range.
- Change color theme.
- Change the units of measurement.
- Reset minimum and maximum readings.
- Reset all pages to default.

Changing datapage order

You can change the order that datapages appear.

From the data application:

1. Scroll to the datapage you want to move.
2. Select **Menu**.
3. Select **Edit Page**.
The edit page menu is displayed.
4. Select **Move Page Up** or **Move Page Down**.
Each time move page up or move page down is selected the datapage will be moved 1 space up or down in the data application.



Customizing datapage content using touch

On touchscreen multifunction displays you can customize a data item by pressing and holding on the item onscreen.

From the Data application:

1. Display the datapage that contains the data item you want to change.
2. Touch and hold your finger on the data item.
After approximately 3 seconds the data item is highlighted and the **Select Data Category** menu is displayed.
3. Navigate the menu to locate the data item you want to use.
4. Select the data item.
The selected data item is now displayed in place of the original data item.

Customizing datapage content

From the data application:

1. Select **Menu**.
2. Select **Edit Page**.
3. Select the cell you want to change.
4. Select **Select Data Category**.
5. Select a data category.
Selecting a data category will display a list of data items for that category.
6. Select the data item you want to display.
Once selected a tick will be placed next to the data item in the menu and the cell on screen will display the new data item
7. Repeat steps 3 to 6 for all the data items you want to change.

Renaming a datapage

From the data application:

1. Select **Menu**.
2. Select **Edit Page**.
3. Select **Rename Page**.
The on screen keyboard is displayed.

4. Enter the new name for the datapage.
5. Select **SAVE**.

Adding a new datapage

You can add your own customized datapages to the data application. The total number of datapages including pre-configured pages is 10.

From the data application:

1. Select **Menu**.
2. Select **Create New Page**.
A list of available page layouts is displayed.
3. Select the required page layout.
The new page is displayed on screen.



4. Select the blank cell on the new page layout that you want to add a data item to.
5. Select **Select Data Category**.
6. Select a data category.
Selecting a data category will display a list of data items for that category.
7. Select the data item you want to display.
Once selected a tick will be placed next to the data item in the menu and the cell on screen will display the selected data item.
8. Repeat steps 3 to 6 for all the data items you want to change.
9. Select **Rename Page**.
The on screen keyboard is displayed.
10. Enter the new name for the datapage.
11. Select **SAVE**.

Deleting a datapage

You can delete custom or pre-configured datapages from the data application. The minimum number of datapages allowed is 1.

From the data application:

1. Scroll to the datapage you want to delete.
2. Select **Menu**.
3. Select **Delete Page**.
The confirm delete pop up message is displayed.
4. Select **Yes** to delete the datapage, or **No** to cancel the action.

Note: You cannot create a new engine page with the same layout as the pre-configured engine datapages.

Setting boat details

You can change vessel settings from the Data application menu.

From the Data application:

1. Select **Menu**.
2. Select **Boat Details**.
3. Select **Num. of Engines**, **Num. of Fuel Tanks**, or **Num. of Batteries**.

4. Select either 1, 2, 3, 4 or 5.

If the number of engines has been changed then the Engine datapage will be reset to display the correct number of engines.

Engine identification

Engine data can be displayed on your MFD using the Data application, which provides some preset Engine pages for displaying some of the most common types of engine data.

Important: Before you can display Engine data on your MFD, you must:

- Ensure that your MFD is running LightHouse software version 8 or later.
- **Refer to the important “Engine instancing” and “Engine identification wizard” information.**
- Make the data connections, according to the instructions provided in the **87202 ECI Installation instructions.**
- Ensure all data buses are powered up (including engine data CAN buses, gateways, and also the SeaTalk^{ng} bus).
- Start the engine. Ensure that you follow any applicable sequencing rules, as specified in the **“Engine instancing”** information.
- Run the **Engine identification wizard** to complete any “instancing” required and ensure that your engines are displayed in the correct order in the Data application.



Engine instancing and setup

Before you can display engine data on your MFD, setup and “instancing” may be required.

Note: Engine setup and instancing is NOT required for single engine vessels.

Most engine data configurations can be setup using the “Engine Identification” wizard available on Raymarine MFDs running LightHouse software version 8 or later. However, for some multiple engine installations, it may be necessary to first have your engines “instanced” correctly by your engine representative / dealer (assigned a unique ID / address).

The following table details the different types of engine supported, and the setup requirements for each:

Engine CAN bus protocol	Number of engines	Engine CAN bus configuration	Number of ECI units required	Setup via wizard on MFD required	Engine instancing by Dealer required
NMEA 2000	1	Single CAN bus	1	✗	✗
NMEA 2000	2+	Single shared CAN bus	1	✗	✓
NMEA 2000	2+	Separate CAN bus for each engine	1 for each CAN bus	✓	✗
J1939	1	Single CAN bus	1	✗	✗
J1939	2+	Single shared CAN bus	1	✓	✗
J1939	2+	Separate CAN bus for each engine	1 for each CAN bus	✓	✗

Using the engine identification wizard

If your engine data appears in the wrong order on the engine data pages you can correct this by running the engine identification wizard.

From the Homescreen:

1. Select **Set-up > System Settings > External Devices > Engines Set-up.**
2. If required change the number of engines your vessel has by selecting **Num. of Engines:** and entering the correct number of engines.

You can select up to 5 engines.

3. Select **Identify engines.**

Important: It is important that only one engine is running at a time, to ensure that the system can isolate the correct engine data message.

4. Follow the onscreen prompts to complete the engine identification wizard.

The engines that will be included in the identification wizard are determined by the Number of engines set during step 2 above.

- i. Switch Off ALL vessel engines and select **Next.**

The wizard will run through all engines (max of 5 as defined in step 2 above) from port to starboard in sequence.

- ii. Turn On the **port engine** and select **OK.**

The wizard will now listen for data and assign the engine instance as the port engine.

- iii. Turn On the **center port engine** and select **OK.**

The wizard will now listen for data and assign the engine instance as the center port engine.

- iv. Turn On the **center engine** and select **OK.**

The wizard will now listen for data and assign the engine instance as the center engine.

- v. Turn On the **center starboard engine** and select **OK.**

The wizard will now listen for data and assign the engine instance as the center starboard engine.

- vi. Turn On the **starboard engine** and select **OK.**

The wizard will now listen for data and assign the engine instance as the starboard engine.

5. Select **OK** on the Identify Engines confirmation dialog.

The engines will now appear in the correct location on the engine data page.

Setting maximum engine RPM

You can set the maximum RPM range to display on the RPM data item.

From the data application:

1. Select **Menu**.
2. Select **Max RPM Range**.
A list of available RPM settings is displayed.
3. Select the required RPM range.
A tick will be placed next to the selected RPM range in the menu and the RPM range on the engine datapage will be changed to your new setting.

Examples

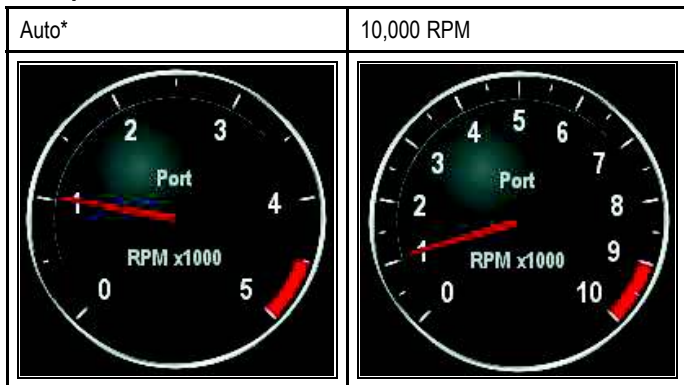

Note: *The maximum RPM when in auto mode is set by the engine.

Color theme

The color theme in the Data application can be switched between light and dark.

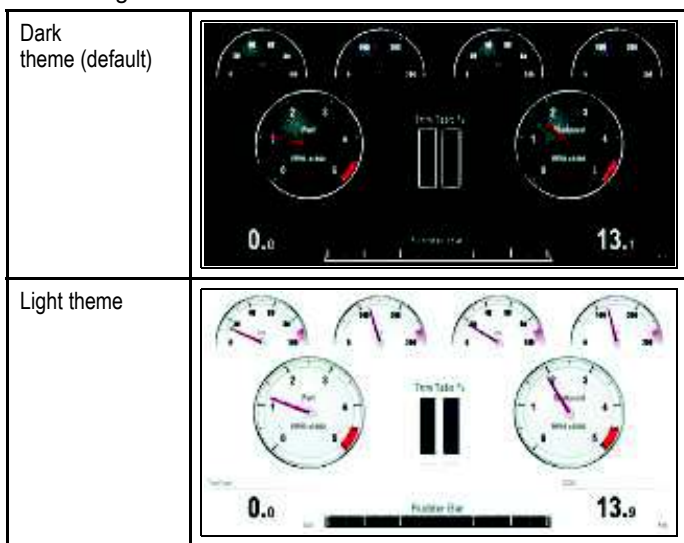

Changing the color theme

You can change the color theme by following the steps below.

From the Data application:

1. Select **Menu**.
2. Select **Presentation**.
3. Select **Color Theme**.
Selecting color theme will switch color between Light and Dark.

Units set-up

You can specify your preference for the units of measurement that will be used in all applications.

Menu item	Description	Options
Distance Units	The units of measure that will be used in all applications for the display of all values related to distance.	<ul style="list-style-type: none"> • Nautical Miles • NM & m (major units = Nautical Miles, minor units = meters) • Statute Miles • Kilometers
Speed Units	The units of measure that will be used in all applications for the display of all values related to speed.	<ul style="list-style-type: none"> • Knots • MPH (Miles Per Hour) • KPH (Kilometers Per Hour)
Depth Units	The units of measure that will be used in all applications for the display of all values related to depth.	<ul style="list-style-type: none"> • Feet • Meters • Fathoms
Temperature Units	The units of measure that will be used in all applications for the display of all values related to temperature.	<ul style="list-style-type: none"> • Fahrenheit • Celsius
Pressure Units	The units of measure that will be used in all applications for the display of all values related to pressure.	<ul style="list-style-type: none"> • Bar • PSI • Kilopascals
Volume Units	The units of measure that will be used in all applications for the display of all values related to volume.	<ul style="list-style-type: none"> • US Gallons • Imperial Gallons • Liters
Economy Units	The units of measure that will be used in all applications for the display of all values related to fuel usage.	<ul style="list-style-type: none"> • Distance per Volume • Volume per Distance • Liters per 100 km
Wind Speed Units	The units of measure that will be used in all applications for the display of all values related to wind speed.	<ul style="list-style-type: none"> • Knots • Metres per second

Changing units of measure

You can change the units of measure used by the multifunction display.



























From the Data application:















































1. Select **Menu**.
2. Select **Units Set-up**.
3. Select the type of measurement you want to change.
4. Select the new unit of measure.











List of data items































Categories of data available to display in the data application, databoxes, databar, and expanded databar are shown below. Dial graphics are not available in databoxes or databars.





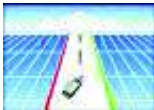



































The following table shows the data items available by category.



































Data Category	Description	Data Item	Data application Graphics			
Battery**	Battery status	Battery Amps				
		Battery Temperature				
		Battery Voltage				
Boat	Types of data generated by your vessel. For example, tank levels.	Rate of Turn				
		Heel Angle				
		Trim Tabs (Data application only.)				
Depth	Depth data.	Depth				
		Maximum Depth				
		Minimum Depth				
Distance	Types of data related to distance travelled by your vessel. For example, trip distance.	Log & Trip				
		Log				
		Trip				
		Ground Log and Trip				
		Ground Log				
		Ground Trip 1				
		Ground Trip 2				
		Ground Trip 3				
		Ground Trip 4				











Data Category	Description	Data Item	Data application Graphics			
Engine**	Types of data generated by engines. For example, oil pressure.	RPM				
		RPM & Speed				
		Coolant Temperature				
		Coolant Pressure				
		Oil Temperature				
		Oil Pressure				
		Oil Pressure & Coolant Temperature				
		Transmission Oil Temperature				
		Transmission Oil Pressure				
		Transmission Gear				
		Boost Pressure				
		Fuel Pressure				
		Fuel Flow Rate				
		Fuel Flow (Inst)				
		Fuel Flow (Avg)				
		Engine Hours				
		Engine Trim				
		Alternator				
Engine Load						

Data Category	Description	Data Item	Data application Graphics			
Fuel**	Types of data related to the fuel system. For example, fuel levels.	Fuel Level (%)	88.8			
		Total Fuel (vol)	88.8			
		Fuel Flow Total	88.8			
		Economy	88.8			
		Estimated Fuel Remaining	88.8			
		Distance to Empty	88.8			
		Time to Empty	88.8			
		Fuel Used (Trip)	88.8			
		Fuel Used (Season)	88.8			
Environment	Environmental-related data. For example, air temperature.	Pressure	88.8			
		Air Temperature	88.8			
		Minimum Air Temperature	88.8			
		Maximum Air Temperature	88.8			
		Drift	88.8			
		Set	88.8			
		Set & Drift	88.8			
		Apparent Wind Chill	88.8			
		True Wind Chill	88.8			
		Humidity	88.8			
		Dew Point	88.8			
		Sunset / Sunrise	88.8			
		Water Temperature	88.8			
Minimum Water Temperature	88.8					

Data Category	Description	Data Item	Data application Graphics				
		Maximum Water Temperature					
GPS	GPS-related data. For example, vessel position.	Vessel Position					
		COG & SOG					
		COG					
		SOG					
		Maximum SOG					
		Average SOG					
Heading	Heading-related data. For example, locked heading.	Heading					
		Heading and Speed (Data application only.)					
		Locked Heading					
		Locked Heading Error					
		LH Error and LH (Data application only.)					
		Tack Heading					
		Compass (Data application only.)					
Navigation	Types of data related to navigation. For example, bearing to waypoint.	Cursor Position (Only available in the Databar and data overlay.)					
		Cursor info (Only available in the Databar and data overlay.)					
		Cross Track Error					
		Rolling Road (Data application only.)					
		Waypoint Info					
		Active Waypoint Name					
		Target Position					

Data Category	Description	Data Item	Data application Graphics			
		Bearing to Waypoint				
		BTW & DTW (Data application only.)				
		Course Made Good				
		CMG & DMG				
		CMG & VMG (Data application only.)				
		Distance to Waypoint				
		Distance Made Good				
		Waypoint ETA				
		Waypoint TTG				
		Route ETA				
		Route TTG				
		Pilot	Pilot-related data. For example, rudder.	Rudder Angle		
Speed	Speed-related data. For example, VMG (Velocity Made Good) to Waypoint.	Speed				
		Maximum Speed				
		Average Speed				
		Speed and SOG				
		VMG to Windward				
		VMG to Waypoint				
Tanks**	Data related to water tanks	Fresh Water (%)				
		Grey Water (%)				
		Black Water (%)				
		Live Well (%)				

Data Category	Description	Data Item	Data application Graphics			
Time	Time-related data. For example, local time.	Local Time				
		Local Date				
Wind	Wind-related data. For example, VMG (Velocity Made Good) to Windward.	AWA				
		Maximum AWA				
		Minimum AWA				
		AWS				
		Maximum AWS				
		Minimum AWS				
		TWA				
		Maximum TWA				
		Minimum TWA				
		TWS				
		Maximum TWS				
		Minimum TWS				
		TWD				
		Cardinal Wind				
		Ground Wind				
		Beaufort				
		AWA and TWA				
		AWA & AWS				
		AWA (CH) and AWS				
		AWA and VMG				

Data Category	Description	Data Item	Data application Graphics			
		TWA & TWS				
		TWA (CH) and TWS				
		TWA and VMG				
		GWD and Beaufort				
		GWD & GWS				
None						

Note: *Dials and graphical representations are only available from the Data application. Databar and data cell overlays can only display digital items.

Note: **The Battery, Engine, Fuel and Tanks menus will display 1 set of data items per configured device (e.g. if the system has been configured with 3 engines then 3 sets of engine data items will be displayed).

19.5 Resetting minimum and maximum readings

Minimum and maximum readings sorted on the display can be reset from the Data application.

From the Data application, with the data you want to reset displayed onscreen:

1. Select **Menu**.
2. Select **Data Resets**.
3. Select the data item you want to reset.

The reading is reset.

Note: Resets will only be available for data items that are currently displayed onscreen.

19.6 Resetting all datapages

You can reset the datapages in the data application to the factory defaults.

1. Select **Menu**.
2. Select **Reset All Pages**.
The confirm reset pop up message is displayed.
3. Select **Yes** to reset or **No** to cancel the action.

Note: Resetting all pages will restore your pre-configured pages to default settings and remove any custom pages that have been created. Number of engines and maximum RPM settings will not be changed during the reset.

Chapter 20: Thermal camera application — Pan and tilt cameras

Chapter contents

- [20.1 Thermal camera application overview on page 248](#)
- [20.2 Thermal camera image on page 248](#)
- [20.3 Controls overview on page 249](#)
- [20.4 Camera control on page 250](#)
- [20.5 Image adjustments on page 252](#)
- [20.6 Pan and tilt camera — new camera interface on page 254](#)
- [20.7 High power and high torque modes on page 257](#)
- [20.8 Pan and tilt camera — old camera interface on page 258](#)

20.1 Thermal camera application overview

The thermal camera application enables you to control a connected thermal camera and display its image on your multifunction display.

Thermal imaging (also known as infrared) cameras enable you to see clearly in low-light and no-light conditions. For example, a thermal camera can help you navigate at night or identify obstacles in areas of low visibility or even total darkness.

The thermal application enables you to:

- **Control the camera:**
 - Pan.
 - Tilt.
 - Zoom (range).
 - Return camera to “home” (default) position.
 - Set the camera “home” position.
 - Pause the camera image.
 - Toggle between visible light and thermal camera lenses.
 - Toggle surveillance mode.
- **Adjust the camera image:**
 - Color palette.
 - Scene presets.
 - Brightness.
 - Contrast.
 - Color.
 - Video polarity (reverse video color).

Displaying the thermal camera application

With the home screen displayed:

1. Select a page icon that includes the thermal camera application.
The thermal camera application is displayed.

Note: If the home screen does NOT include a page icon that features the thermal camera application you will need to create a new page icon featuring the thermal camera application.

20.2 Thermal camera image

The thermal camera provides a video image which is shown on your display.



The video feed provides:

- Thermal image.
- Status icons / system information.











You should take time to familiarize yourself with the thermal image. This will help you to make the most of your system:

- Consider every object you view in terms of how it will look “thermally” as opposed to how it looks to your eye. For example look for changes caused by the heating effect of the sun. These are particularly evident right after sunset.
- Experiment with white-hot and black-hot (reverse video) modes.
- Experiment by looking for hot objects (such as people) compared to the colder surroundings.
- Experiment with the camera for daytime viewing. The camera can provide improved daytime viewing in environments where traditional video camera performance suffers, such as in shadows or backlit scenes.

Thermal camera status icons

The thermal camera image includes icons to show the current status of the camera.

Icon	Description
	Camera direction indicator.
	Camera home position.
	Camera paused.
	Scene preset mode for night conditions.
	Scene preset mode for daytime conditions.
	Scene preset mode for night docking.
	Scene preset mode for identifying people or objects in the water.

Icon	Description
	Rear-view mode — image is flipped horizontally.
	Zoom setting: 2x zoom.
	Zoom setting: 4x zoom.
	Single active controller on network.
	Multiple active controllers on network.
	PC / laptop detected on network.
	Point mode enabled.
	Point mode disabled.
	Stabilization Off.
	Stabilization On.

20.3 Controls overview

The thermal camera application is available on compatible Raymarine multifunction displays and systems. It includes controls for the thermal camera.

Rotary control	Zoom image in / out.
Joystick	<ul style="list-style-type: none"> • Pan and tilt camera <div style="border: 1px solid black; padding: 5px; margin: 5px 0;"> <p>Note: On touchscreen displays you can also use the touchscreen to pan and tilt the camera.</p> </div> <ul style="list-style-type: none"> • Navigate menus
OK	Confirm menu selection
CANCEL / Back	Cancel selection
RANGE IN / OUT	Zoom image in / out.

FFC (Flat Field Correction)

Periodically the camera will perform a Flat Field Correction (FFC). This will fine tune the thermal image to suit the current ambient temperature.

The FFC operation is indicated by a momentary pause and a green rectangle displayed in the upper left of the thermal video image.

20.4 Camera control

Power up and standby

When the breaker connecting power to the camera is switched on, the camera will run a boot up sequence lasting for about 1 minute, after which the camera will be in **Standby** mode.

In order for the camera to operate, you must bring the camera out of standby mode using the camera controls.

Thermal camera standby

Standby mode can be used to temporarily suspend the thermal camera's functions when the camera is not needed for a prolonged period.

When in standby mode the camera:

- Does NOT provide a live video image.
- Moves the camera into its “stowed” (parked) position (lens facing down into the camera base) to protect the camera optics.
- Engages its pan / tilt motors to hold the camera in place in rough seas.

Note: The “stowed” (parked) position can be configured using the camera's setup menu.

Enabling and disabling thermal camera standby

With the thermal camera application displayed:

1. Select **Menu**.
2. Use the **Standby** menu item to switch the camera in and out of standby mode.

Note: You can also use any of the camera controls in the thermal camera application to “wake” the camera from standby mode.

Pan, tilt and zoom

The camera controls allow for pan and tilt (elevation) of the camera, as well as zoom (magnification) of the thermal image.

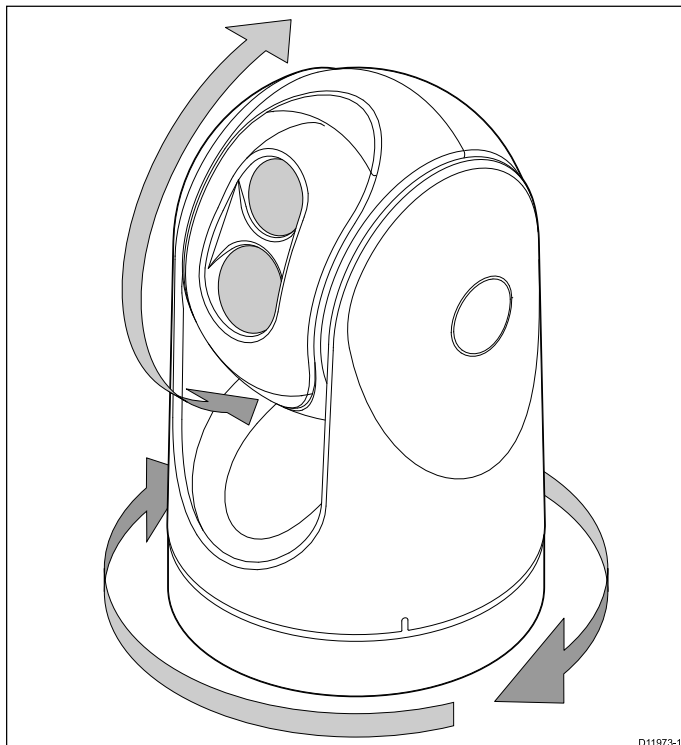

- Pan continuously through 360°.
- Tilt (elevate) to $\pm 90^\circ$ relative to the horizon.
- Zoom (magnify) the thermal camera image.

Note: Stabilized variants of the T-Series thermal cameras include a continuous zoom function, non-stabilized variants can switch between x2 and x4 magnification.



Panning and tilting, and the thermal image

On a touchscreen multifunction display you can pan and tilt the thermal camera image using the touchscreen.

	Move your finger up and down the screen to tilt the camera up or down.
	Move your finger left and right on the screen to rotate the camera left or right (panning).

Thermal camera home position

The home position is a preset position for the camera.

The home position usually defines a useful reference point — for example, straight ahead and level with the horizon. You can set the home position as required and to return the camera to the home position at any time.

	The home icon appears on-screen momentarily when the camera returns to the home position. The icon flashes when a new home position is set.
--	---

Resetting the thermal camera to the home position

When connected to a pan, tilt thermal camera the home position of the camera can be set.

In the thermal camera application:

1. Select **Menu**.
2. Select **Camera Home**.
The camera returns to its currently defined home position, and the “Home” icon appears on-screen momentarily.

Setting the thermal camera home position

With the thermal camera application displayed:

1. Use the joystick or touchscreen to move the camera to the desired position.
2. Select **Menu**.
3. Select **Camera Set-up**.
4. Select **Set Home Position**.
The “Home” icon flashes on-screen to indicate that a new home position has been set.

Pausing the thermal camera image

With the thermal camera application displayed:

1. Select **Menu**.
2. Select **Pause Image**.

Thermal camera surveillance mode

In surveillance mode the camera pans left and right continuously.

The camera continues to pan until surveillance mode is disabled, or the camera controls are used to move the camera. When this occurs the camera does not automatically resume surveillance mode and the mode must be enabled again if required.

Enabling and disabling thermal camera surveillance mode

With the thermal camera application displayed:

1. Select **Menu**.
2. Select **Image Options**.
3. Use the **Surveillance** menu item to select the On or Off option, as appropriate.

Surveillance mode settings

The scan width and scan speed can be adjusted.

Scan Width

The scan width determines the distance that the camera pans left and right when in surveillance mode.

Scan Speed

The scan speed determines the speed at which the camera pans left and right when in surveillance mode.

Setting scan width

The surveillance mode scan width can be adjusted by following the steps below.

From the thermal camera application:

1. Select **Menu**.
2. Select **Camera Set-up**.
3. Select **Surveillance Settings**.
4. Select **Scan Width**.

The scan width options will be displayed:

- **Narrow** — The camera will scan approximately 20° left and right of the center (40° total).
 - **Medium** — The camera will scan approximately 40° left and right of the center (80° total).
 - **Wide** — The camera will scan approximately 80° left and right of the center (160° total).
5. Select the required option.

Setting scan speed

The surveillance mode scan speed can be adjusted by following the steps below.

From the thermal camera application:

1. Select **Menu**.
2. Select **Camera Set-up**.
3. Select **Surveillance Settings**.
4. Select **Scan Speed**.

The scan speed options will be displayed:

- **Slow**
 - **Medium**
 - **Fast**
5. Select the required option.

Thermal camera stabilization

The Raymarine T470SC and T473SC thermal cameras includes a mechanical stabilization feature.

The mechanical stabilization feature improves image stability by compensating for vessel motion and keeping the camera aimed at the point of interest. Mechanical stabilization has two aspects: horizontal (azimuth) and vertical (elevation). By default, mechanical stabilization is set to on, which provides the best on-the-water performance particularly when the vessel is underway and traveling on rough water or in swell conditions. You can disable or enable stabilization whenever you want. When you enable full stabilization (horizontal and vertical), the Stabilization On (no wave) icon flashes. It does not display continually, since this is the normal mode of operation. If you disable stabilization, the Stabilization Off (wave) icon remains on the screen to make you aware that the motion of the vessel can affect the camera performance. This is not a normal mode of operation. Stabilization is automatically turned off when the camera is stowed, but the system restores your setting when the camera is powered on. You can turn off the horizontal (pan) stabilization while retaining the tilt stabilization by enabling point mode.

Enabling / Disabling stabilization

Stabilization is enabled by default. You can enable or disable stabilization at any time by following the steps below.

From the thermal camera application

Thermal camera application — Pan and tilt cameras

1. Select **Menu**.
2. Select **Camera Set-up**.
3. Select **Stabilization Mode**.

Selecting Stabilization mode switches stabilization On and Off.

Thermal camera point mode

Point mode is only applicable to thermal cameras which have mechanical stabilization.

Enabling point mode only has significance when stabilization is enabled. Enabling point mode turns off the horizontal (pan) stabilization while retaining the vertical (tilt) stabilization. This can be helpful when you want to use the thermal camera as an aide to navigation and keep the camera pointing in the same position relative to the vessel as it turns. For example, you may have stabilization enabled and have set the camera to point straight ahead relative to the front of the vessel. If the vessel is turned at a sharp angle under these conditions, the camera sensor will not follow the direction of the vessel. Enabling point mode keeps the camera in sync with the vessel direction while maintaining a stable elevation position. When point mode is enabled, a lock icon displays. The camera's azimuth position is now locked to the base. When you disable point mode, the unlock icon displays momentarily. The camera always starts up with point mode disabled.

Enabling / Disabling point mode

Point mode is disabled by default. With Stabilization enabled you can also enable point mode at any time by following the steps below.

From the thermal camera application:

1. Select **Menu**.
2. Select **Camera Set-up**.
3. Select **Point Mode**.

Selecting point mode switches point mode On and Off.

20.5 Image adjustments

Adjusting the thermal camera image

With the thermal camera application displayed:

1. Select **Menu**.
2. Select **Adjust Contrast**.
3. Select the Contrast, Brightness, or Color option as appropriate.





The relevant numeric adjust control is displayed.

4. Adjust the value as required.
5. Select **Back** or **Ok** to confirm the new value.

Thermal camera scene presets

Scene presets enable you to quickly select the best image setting for the current environmental conditions.

During normal operation the thermal camera automatically adjusts itself to provide a high-contrast image optimized for most conditions. The Scene presets provide 4 additional settings that may provide better imagery in certain conditions. The 4 modes are:

	Night Running — scene preset mode for night conditions.
	Day Running — scene preset mode for daytime conditions.
	Night Docking — scene preset mode for night docking.
	Search — scene preset mode for identifying people or objects in the water.

Although the preset names indicate their intended use, varying environmental conditions might make another setting more preferable. For example, the night running scene preset might also be useful while in a harbor. You may find it beneficial to experiment with the different scene presets to discover the best preset to use for different conditions.

Changing the thermal camera scene preset

With the thermal camera application displayed:

1. Select **Menu**.
2. Select **Image Options**.
3. Use the **Scene** menu item to switch between the available scene presets, as appropriate.

Thermal camera color modes

A range of color modes are available to help you distinguish objects on-screen in different conditions.

Changing the color mode switches the thermal camera image between a greyscale mode and 1 or more color modes. There are 5 color modes available.

The factory default color mode is white, which may improve your night vision. This default mode can be changed if required using the camera's on-screen **Video Setup** menu.

Note: If you have the Disable Color Thermal Video option selected in the camera's on-screen **Video Setup** menu, only 2 color modes are available — greyscale and red.

Changing the thermal camera color mode

With the thermal camera application displayed:

1. Select **Menu**.
2. Select **Image Options**.
3. Use the **Colour** menu item to switch between the available color palettes, as appropriate.

Thermal camera reverse video

You can reverse the polarity of the video image to change the appearance of objects on-screen.

The reverse video option (video polarity) switches the thermal image from white-hot (or red-hot if the color mode setting is active) to black-hot. The difference between white-hot and black-hot is shown below:

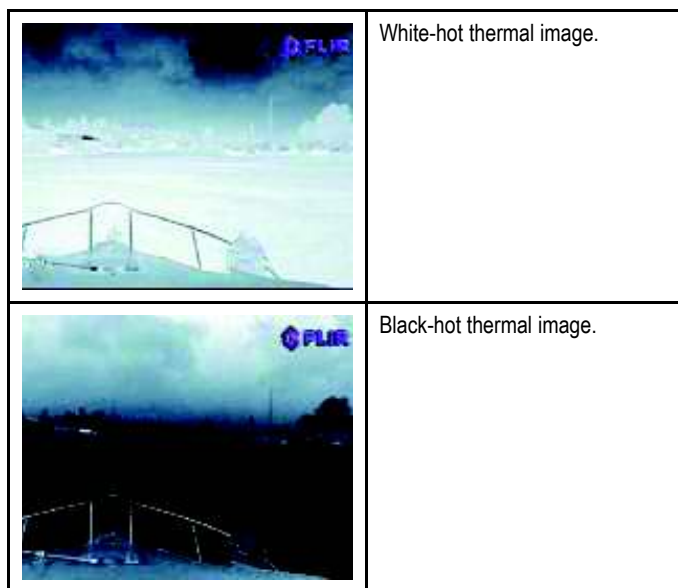

You may find it useful to experiment with this option to find the best setting to suit your needs.



Enabling thermal camera reverse video

With the thermal camera application displayed:

1. Select **Menu**.
2. Select **Image Options**.
3. Select **Reverse Video**.

Thermal and visible-light operation

“Dual payload” thermal cameras are equipped with 2 cameras — a thermal imaging (infrared) camera and a visible-light camera.

	Thermal camera — provides night-time imagery, based on temperature differences between objects. Thermal imaging produces a clear image even in total darkness.
	Visible-light camera — provides black and white (or greyscale) imagery during the day and in low-light conditions. Helps to improve navigational abilities in low-light conditions; for example during twilight hours when operating along intercoastal waterways and near harbor entrances.

Note: The T470SC and T473SC have a color camera and continuous zoom lens.

Switching between thermal and visible-light camera lenses

With the thermal camera application displayed:

1. Select **Menu**.
2. Select **Image Options**.

3. Use the **Image Type** menu item to switch between IR and Visible Light views, as appropriate.

4. Adjust the value to the required setting.
This value will adjust the camera's offset position to port or starboard.

Thermal camera rear view mode

The rear view mode flips the video image horizontally, providing a "mirror image".

This is useful for example in instances where the camera is rear-facing and you are viewing the image on a forward-facing monitor.

Enabling thermal camera rear view mode

With the thermal camera application displayed:

1. Select **Menu**.
2. Select **Image Options**.
3. Select **Rear View**.

Slew to Cue

Slew to cue is a feature which maintains a selected position or object in the thermal cameras field of view. Slew to Cue options are available in the chart and radar applications as target context menu items.

Note: Heading data must be available on the system for Slew to Cue to work correctly.

For details on how to select a target to 'slew to' refer to the radar and chart sections of your manual.

The thermal camera can also automatically slew to:

- MOB target
- Dangerous AIS target
- Dangerous MARPA target

Options to enable or disable the automatic slew options are available in the thermal camera application

Setting the camera's height above sea level

To ensure that the thermal camera's alignment can be set correctly the height of the camera above sea level must be set.

From the thermal camera application:

1. Select **Menu**.
2. Select **Camera Set-up**.
3. Select **Slew Settings**.
The Slew settings page is displayed.
4. Select **Camera height above sea level**.
The Camera height above sea level pop up is displayed.
5. Adjust the value to the required setting.

Aligning the thermal camera horizontally

If you find that slew to cue objects are consistently too far left or right on the screen then you can make fine adjustments to the cameras alignment by following the steps below.

From the thermal camera application:

1. Select **Menu**.
2. Select **Camera Set-up**.
3. Select **Align camera**.
The Align camera to boat pop up is displayed.
4. Adjust the value to the required setting.
This value will adjust the camera's offset position to port or starboard.

Aligning the thermal cameras elevation

If you find that slew to cue objects are consistently too low or high on the screen then you can make fine adjustments to the cameras alignment by following the steps below.

From the thermal camera application:

1. Select **Menu**.
2. Select **Camera Set-up**.
3. Select **Elev Align**.
The Align camera to boat pop up is displayed.

Enabling / disabling automatic slew to cue

From the thermal camera application:

1. Select **Menu**.
2. Select **Camera Set-up**.
3. Select **Slew Settings**.
The Slew settings page is displayed which includes the following auto slew options:
 - Auto Slew to MOB
 - Auto Slew to Dangerous AIS target
 - Auto Slew to Dangerous MARPA target
4. Select the relevant option.
Selecting an option from the list will switch the auto slew option for that item On or Off.

20.6 Pan and tilt camera — new camera interface

The thermal camera application menu options for a pan and tilt thermal camera with the new camera interface are shown below.

Activate Camera	Brings the thermal camera out of standby mode. (only available when camera is in standby.)
Pause Image	<ul style="list-style-type: none"> • On • Off (default)
Camera Home	Select to return the camera to its home position.
Image Options	<p>Select to display the Image Options sub-menu.</p> <ul style="list-style-type: none"> • Color <ul style="list-style-type: none"> – Red – Greyscale – Glowbow – Rainbow – Fusion • Scene <ul style="list-style-type: none"> – Night Running – Night Docking – Day Running – Man Overboard • Thermal / Visible • Reverse video • Rear View • Surveillance
Adjust Contrast	<p>Select to display the Adjust Contrast sub-menu.</p> <ul style="list-style-type: none"> • Contrast • Brightness • Color
Standby	Select to place the camera in to standby mode. (only available when camera is activated.)
Camera Set-up	<p>Select to display the Camera Set-up menu.</p> <ul style="list-style-type: none"> • Set Home Position • Slew Settings • Align Camera • Elev Align: • Surveillance Settings • Default Color • Icon Level • Stabilization Mode • Point Mode • Ball Down Mode • High Power Standby • High Power Torque • JCU Icon • PC Icon • Restore Factory Defaults • Calibrate Platform

Camera Set-up menu

Set Home Position	Sets the camera's current position as the Camera Home position.	
Slew Settings	Provides automatic slew options and camera alignment settings.	<ul style="list-style-type: none"> • Auto Slew to MOB • Auto Slew to dangerous AIS target • Auto Slew to dangerous MARPA target • Camera height above sea level
Align Camera	Enables changes to camera's horizontal alignment.	
Elev Align	Enables changes to camera's elevation (vertical) alignment.	
Surveillance Settings	Enables you to set the speed and width the camera will scan when in surveillance mode.	<ul style="list-style-type: none"> • Scan Speed <ul style="list-style-type: none"> – Slow – Medium – Fast • Scan Width <ul style="list-style-type: none"> – Narrow – Medium – Wide
Default Color	Enables selection of default color palette.	<ul style="list-style-type: none"> • Red • Greyscale • Glowbow • Rainbow • Fusion
Icon Level	Enables selection of level of icons displayed on-screen.	<ul style="list-style-type: none"> • None • Minimal • All
Stabilization Mode	Enables and disables stabilization mode. Note: Only available on stabilized variants of the T-Series cameras.	<ul style="list-style-type: none"> • On (default) • Off
Point Mode	Enables and disables point mode.	<ul style="list-style-type: none"> • On • Off (default)
Ball Down Mode	This options should be enables when the camera is mounted upside down in the 'ball down' configuration.	<ul style="list-style-type: none"> • On • Off (default)
High Power Standby	This option controls the amount of power used to hold the camera in position while it is in standby mode. With the setting enabled the camera will consume more power, but will help ensure that the camera is held in place in rough seas.	<ul style="list-style-type: none"> • On (default) • Off
High Power Torque	This option controls the amount of power used to hold the camera steady when in use. With the setting enabled the camera will consume more power, but will help ensure that the camera is held in place in rough seas. The High Power Torque mode may be useful for power boats that operate at higher speeds and experience high impact environments, and can accept higher power consumption.	<ul style="list-style-type: none"> • On (default) • Off
JCU Icon	Shows or hides the on-screen JCU connected icon.	<ul style="list-style-type: none"> • On (default) • Off
PC Icon	Shows or hides the on-screen PC connected icon.	<ul style="list-style-type: none"> • On (default) • Off
Restore Factory Defaults	Enables you to restore the camera's settings to factory default values.	
Calibrate platform	The calibrate platform option re-initializes the pan and tilt mechanism in the thermal camera.	

Note: The thermal camera menu options available are dependant on the software version of your multifunction display and thermal camera. If options are different than listed above please refer to the manual that accompanied your thermal camera and / or the installation and operations handbook which accompanied your multifunction display.

20.7 High power and high torque modes

Camera State	Camera setting	Dual payload	Single payload
Standby	<ul style="list-style-type: none"> • High Power Mode ON • High Torque Mode ON 	22 W	17.4 W
Standby	<ul style="list-style-type: none"> • High Power Mode OFF • High Torque Mode ON 	8 W	7.4 W
Standby	<ul style="list-style-type: none"> • High Power Mode ON • High Torque Mode OFF 	13 W	13 W
Awake	<ul style="list-style-type: none"> • High Power Mode OFF • High Torque Mode OFF 	8 W	7.4 W
Awake	<ul style="list-style-type: none"> • High Power Mode ON or OFF • High Torque Mode ON 	30 W	19.4 W
Awake	<ul style="list-style-type: none"> • High Power Mode ON or OFF • High Torque Mode OFF 	20 W	16.5 W

20.8 Pan and tilt camera — old camera interface

The thermal camera application menu options for a pan and tilt thermal camera with the old camera interface are shown below.

Activate Camera	Brings the thermal camera out of standby mode. (only available when camera is in standby.)
Pause Image	<ul style="list-style-type: none"> • On • Off (default)
Camera Home	Select to return the camera to its home position.
Image Options	Select to display the Image Options sub-menu. <ul style="list-style-type: none"> • Color <ul style="list-style-type: none"> – Red – Greyscale – Glowbow – Rainbow – Fusion • Scene <ul style="list-style-type: none"> – Night Running – Night Docking – Day Running – Man Overboard • Thermal / Visible • Reverse video • Rear View • Surveillance
Adjust Contrast	Select to display the Adjust Contrast sub-menu. <ul style="list-style-type: none"> • Contrast • Brightness • Color
Standby	Select to place the camera in to standby mode. (only available when camera is activated.)
Camera Set-up	Select to display the Camera Set-up menu. <ul style="list-style-type: none"> • Set Home Position • Camera menu — (Onscreen display (OSD) menu) • Align Camera

Camera Set-up menu

Set Home Position	Sets the camera's current position as the Camera Home position.
Camera menu	Provides access to the camera's onscreen display (OSD) menu options.
Align Camera	Enables changes to camera's horizontal alignment.

Note: The thermal camera menu options available are dependant on the software version of your multifunction display and thermal camera. If options are different than listed above please refer to the manual that accompanied your thermal camera and / or the installation and operations handbook which accompanied your multifunction display.

Note: It may be possible to update your camera to the new camera interface. Please contact your Raymarine dealer for details.

OSD menu options

Setup menus

The setup menus provide a range of tools and settings to configure the thermal camera.

The menus can be accessed from any controller on the system. The menus are overlaid onto the video image.

Note: The on-screen menus only appear on the thermal camera image. They are not available when viewing the visible light image (on dual payload models).

Menus available

Enable Point Mode / Disable Point Mode	Selecting Enable Point mode will turn point mode on, selecting disable point mode will turn point mode off. Only applies to models with mechanical stabilization.
Video Setup	This menu is used to set the video configuration options.
Set Symbology	Settings associated with the status icons.
User Programmable Button	Configure the USER button on the JCU.

System Setup	Settings to optimize operation for this particular system / installation.
About / Help	Helpful information and restore to factory defaults setting.
Exit	Cancel on-screen menu.

Video setup menu

Menu item / Description	Settings / Operation
Set Thermal Color Default	This saves the current color setting as the default value.
Set Reverse Video or Set Video Polarity	This toggles the infrared image between white-hot (or red-hot if viewing a color image) and black-hot.
Enable / Disable Color Thermal Video	Enable or disable the thermal color palettes: <ul style="list-style-type: none"> • Enabled – Greyscale, Red, Sepia, Rainbow and Fusion palettes are available. • Disabled – Only Greyscale and Red palettes are available.
Display Test Pattern	Use the display test pattern when setting up the color / contrast settings for your particular display or monitor. You can switch through the 4 test patterns available.
Exit	

Set symbology menu

Menu item / Description	Settings / Operation
Enable / Disable PC Icon	<ul style="list-style-type: none"> • Enabled – The PC icon is displayed whenever a PC is detected on the network. • Disabled – The PC icon is not displayed.
Enable / Disable JCU Icon	<ul style="list-style-type: none"> • Enabled – The JCU icon is displayed whenever a JCU is detected on the network. • Disabled – The JCU icon is not displayed.
Display All Icons	Selecting this menu item enables all available icons.
Display Minimal Icons	<p>Selecting this menu item reduces the icon activity:</p> <ul style="list-style-type: none"> • Position, Zoom, Rearview, Pause, Stabilization disabled and Point Mode enabled icons are unaffected. • Home and Scene icons are displayed only momentarily. • Other icons are not shown.
Hide All Icons	<p>Selecting this option hides all icons except for:</p> <ul style="list-style-type: none"> • Position indicator • Rearview mode enabled • Stabilization disabled • Point mode enabled
Exit	Returns to the main menu.

Surveillance mode menu

Menu item / Description	Settings / Operation
Scan Width	<p>This setting determines the distance that the camera pans left and right when in surveillance mode. Select from:</p> <ul style="list-style-type: none"> • Narrow — The camera will scan approximately 20° left and right of the center (40° total). • Medium — The camera will scan approximately 40° left and right of the center (80° total). Or, • Wide The camera will scan approximately 80° left and right of the center (160° total).
Scan Speed	<p>This option determines the speed at which the camera pans left and right when in surveillance mode. Select between:</p> <ul style="list-style-type: none"> • Slow • Medium • Fast
Exit	

System Setup menu

Menu item / Description	Settings / Operation
Enable / Disable Ball-Down Installation	This menu option should be enabled when the camera is mounted upside down in the “ball-down” configuration.
Enable / Disable Twist-to-Pan mode	<p>This menu option changes the JCU controls pan and zoom functions as follows:</p> <p>Enabled — Pan the camera by rotating the Puck clockwise or counterclockwise, zoom in and out by pushing the puck in and pulling it out. (This is default operation of the JCU).</p> <p>Disabled — Pan the camera by moving the Puck left or right, zoom in and out by rotating the Puck clockwise and counterclockwise.</p>
Enable / Disable High Power Standby	<p>This option controls the amount of power used to hold the camera in position while it is in Standby mode. The enabled setting will consume more power, but will help ensure that the camera is held in place in rough seas.</p> <div style="border: 1px solid black; padding: 5px;"> <p>Note: If the camera moves when in standby (due to shock or vibration), then the Position indicator or Home setting may need realigning (reset the camera to realign).</p> </div>
Enable / Disable High Motor Torque	<p>This option controls the amount of power used to hold the camera steady when in use. The enabled setting will consume more power, but help ensure that the camera is held in place in rough seas.</p> <p>The High Motor Torque mode may be useful for power boats that operate at higher speeds and experience high impact environments, and can accept higher power consumption.</p> <div style="border: 1px solid black; padding: 5px;"> <p>Note: If the camera moves due to shock or vibration, then the Position indicator or Home setting may need realigning (reset the camera to realign).</p> </div>
Enable / Disable Rearview Mode	When this option is enabled the camera image is reversed and you will see a mirror image on the display.
Enable / Disable Stabilization	When this option is enabled horizontal and vertical stabilization is turned on. Only applies to T470SC and T473SC.

Menu item / Description	Settings / Operation
Set Stow Position	This option sets the current position as the Stow position. The camera moves to the stow position whenever it is turned off or put into Standby mode.
Name Camera	Use this option to name the camera.
Surveillance mode	This options enables you to set the scan width and speed when in surveillance mode.
Exit	Exit to main menu.

High power / High torque power use

Camera State	Camera setting	Dual payload	Single payload
Standby	<ul style="list-style-type: none"> High Power Mode ON High Torque Mode ON 	22 W	17.4 W
Standby	<ul style="list-style-type: none"> High Power Mode OFF High Torque Mode ON 	8 W	7.4 W
Standby	<ul style="list-style-type: none"> High Power Mode ON High Torque Mode OFF 	13 W	13 W
Awake	<ul style="list-style-type: none"> High Power Mode OFF High Torque Mode OFF 	8 W	7.4 W
Awake	<ul style="list-style-type: none"> High Power Mode ON or OFF High Torque Mode ON 	30 W	19.4 W
Awake	<ul style="list-style-type: none"> High Power Mode ON or OFF High Torque Mode OFF 	20 W	16.5 W

User Programmable Button menu

Use this menu to set up the **USER** button on the JCU.

Menu item / Description	USER button operation
Search settings	The USER button will set the camera scene to Search mode.
Switch Thermal / VIS Video (Dual payload models only)	The USER button will switch between Thermal and Low Light camera images.
Hide / Show All Icons	The USER button will toggle between Show and Hide icon settings.
Reverse Video	The USER button will toggle between the White-hot and Black-hot (reverse) thermal image.
Rearview Mode	The USER button will toggle Rearview mode on and off.
Surveillance Mode	The USER button will toggle Surveillance mode on and off.
Point Mode	The USER button will toggle Point Mode on and off.
Exit	Returns to the main menu.

Chapter 21: Thermal camera application — fixed mount cameras

Chapter contents

- [21.1 Thermal camera application overview on page 262](#)
- [21.2 Thermal camera image on page 262](#)
- [21.3 Controls overview on page 263](#)
- [21.4 Camera control on page 264](#)
- [21.5 Image adjustments on page 264](#)
- [21.6 Fixed mount camera menu on page 266](#)

21.1 Thermal camera application overview

The thermal camera application enables you to control a connected thermal camera and display its image on your multifunction display.

Thermal imaging (also known as infrared) cameras enable you to see clearly in low-light and no-light conditions. For example, a thermal camera can help you navigate at night or identify obstacles in areas of low visibility or even total darkness.

The thermal application enables you to:

- **Control the camera:**
 - Zoom (range).
 - Pause the camera image.
- **Adjust the camera image:**
 - Color palette.
 - Scene presets.
 - Brightness.
 - Contrast.
 - Color.
 - Video polarity (reverse video color).

Displaying the thermal camera application

With the home screen displayed:

1. Select a page icon that includes the thermal camera application.

The thermal camera application is displayed.

Note: If the home screen does NOT include a page icon that features the thermal camera application you will need to create a new page icon featuring the thermal camera application.

21.2 Thermal camera image

The thermal camera provides a video image which is shown on your display.



The video feed provides:

- Thermal image.
- Status icons / system information.





You should take time to familiarize yourself with the thermal image. This will help you to make the most of your system:

- Consider every object you view in terms of how it will look “thermally” as opposed to how it looks to your eye. For example look for changes caused by the heating effect of the sun. These are particularly evident right after sunset.
- Experiment with white-hot and black-hot (reverse video) modes.
- Experiment by looking for hot objects (such as people) compared to the colder surroundings.
- Experiment with the camera for daytime viewing. The camera can provide improved daytime viewing in environments where traditional video camera performance suffers, such as in shadows or backlit scenes.

Thermal camera status icons

The thermal camera image includes icons to show the current status of the camera.

Icon	Description
	Camera paused.
	Scene preset mode for night conditions.
	Scene preset mode for daytime conditions.
	Scene preset mode for night docking.
	Scene preset mode for identifying people or objects in the water.
	Rear-view mode — image is flipped horizontally.
	Zoom setting: 2x zoom.

Icon	Description
	Zoom setting: 4x zoom.
	Single active controller on network.
	Multiple active controllers on network.
	PC / laptop detected on network.

21.3 Controls overview

The thermal camera application is available on compatible Raymarine multifunction displays and systems. It includes controls for the thermal camera.

Rotary control	Zoom image in / out.
OK	Confirm menu selection.
Joystick	Navigate menus.
CANCEL / Back	Cancel selection.
RANGE IN / OUT	Zoom image in / out.

FFC (Flat Field Correction)

Periodically the camera will perform a Flat Field Correction (FFC). This will fine tune the thermal image to suit the current ambient temperature.

The FFC operation is indicated by a momentary pause and a green rectangle displayed in the upper left of the thermal video image.

21.4 Camera control

Power up and standby

When the breaker connecting power to the camera is switched on, the camera will run a boot up sequence lasting for about 1 minute, after which the camera will be in **Standby** mode.

In order for the camera to operate, you must bring the camera out of standby mode using the camera controls.

Thermal camera standby

Standby mode can be used to temporarily suspend the thermal camera's functions when the camera is not needed for a prolonged period.

When in standby mode the camera does not provide a live video image.

Enabling and disabling thermal camera standby

With the thermal camera application displayed:

1. Select **Menu**.
2. Use the **Standby** menu item to switch the camera in and out of standby mode.

Note: You can also use any of the camera controls in the thermal camera application to “wake” the camera from standby mode.

Pausing the thermal camera image

With the thermal camera application displayed:

1. Select **Menu**.
2. Select **Pause Image**.

21.5 Image adjustments

Adjusting the thermal camera image





With the thermal camera application displayed:

1. Select **Menu**.
2. Select **Adjust Contrast**.
3. Select the Contrast, Brightness, or Color option as appropriate.
The relevant numeric adjust control is displayed.
4. Adjust the value as required.
5. Select **Back** or **Ok** to confirm the new value.

Thermal camera scene presets

Scene presets enable you to quickly select the best image setting for the current environmental conditions.

During normal operation the thermal camera automatically adjusts itself to provide a high-contrast image optimized for most conditions. The Scene presets provide 4 additional settings that may provide better imagery in certain conditions. The 4 modes are:

	Night Running — scene preset mode for night conditions.
	Day Running — scene preset mode for daytime conditions.
	Night Docking — scene preset mode for night docking.
	Search — scene preset mode for identifying people or objects in the water.

Although the preset names indicate their intended use, varying environmental conditions might make another setting more preferable. For example, the night running scene preset might also be useful while in a harbor. You may find it beneficial to experiment with the different scene presets to discover the best preset to use for different conditions.

Changing the thermal camera scene preset

With the thermal camera application displayed:

1. Select **Menu**.
2. Select **Image Options**.
3. Use the **Scene** menu item to switch between the available scene presets, as appropriate.

Thermal camera color modes

A range of color modes are available to help you distinguish objects on-screen in different conditions.

Changing the color mode switches the thermal camera image between a greyscale mode and 1 or more color modes. There are 5 color modes available.

The factory default color mode is white, which may improve your night vision. This default mode can be changed if required using the camera's on-screen **Video Setup** menu.

Note: If you have the Disable Color Thermal Video option selected in the camera's on-screen **Video Setup** menu, only 2 color modes are available — greyscale and red.

Changing the thermal camera color mode

With the thermal camera application displayed:

1. Select **Menu**.
2. Select **Image Options**.
3. Use the **Colour** menu item to switch between the available color palettes, as appropriate.

Thermal camera reverse video

You can reverse the polarity of the video image to change the appearance of objects on-screen.

The reverse video option (video polarity) switches the thermal image from white-hot (or red-hot if the color mode setting is active) to black-hot. The difference between white-hot and black-hot is shown below:

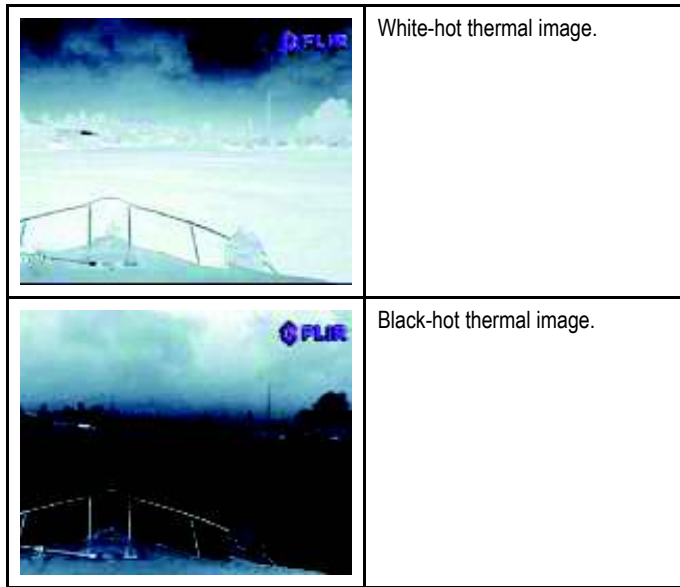

You may find it useful to experiment with this option to find the best setting to suit your needs.

Enabling thermal camera reverse video

With the thermal camera application displayed:

1. Select **Menu**.
2. Select **Image Options**.
3. Select **Reverse Video**.

Thermal camera rear view mode

The rear view mode flips the video image horizontally, providing a “mirror image”.

This is useful for example in instances where the camera is rear-facing and you are viewing the image on a forward-facing monitor.

Enabling thermal camera rear view mode

With the thermal camera application displayed:

1. Select **Menu**.
2. Select **Image Options**.
3. Select **Rear View**.

21.6 Fixed mount camera menu

The thermal camera application menu options for a fixed mount thermal camera are shown below.

Activate Camera	Brings the thermal camera out of standby mode. (only available when camera is in standby.)
Pause Image	<ul style="list-style-type: none"> • On • Off (default)
Image Options	<p>Select to display the Image Options sub-menu.</p> <ul style="list-style-type: none"> • Color <ul style="list-style-type: none"> – Red – Greyscale – Glowbow – Rainbow – Fusion • Scene <ul style="list-style-type: none"> – Night Running – Night Docking – Day Running – Man Overboard • Reverse video • Rear View
Adjust Contrast	<p>Select to display the Adjust Contrast sub-menu.</p> <ul style="list-style-type: none"> • Contrast • Brightness • Color
Standby	Select to place the camera in to standby mode. (only available when camera is activated.)
Camera Set-up	<p>Select to display the Camera Set-up menu.</p> <ul style="list-style-type: none"> • Default Color • Icon Level • Ball Down Mode • High Power Standby • JCU Icon • PC Icon • Restore Factory Defaults

Camera Set-up menu

Default Color	Enables selection of default color palette.	<ul style="list-style-type: none"> • Red • Greyscale • Glowbow • Rainbow • Fusion
Icon Level	Enables selection of level of icons displayed on-screen.	<ul style="list-style-type: none"> • None • Minimal • All
Ball Down Mode	This options should be enables when the camera is mounted upside down in the 'ball down' configuration.	<ul style="list-style-type: none"> • On • Off (default)
High Power Standby	This option controls the amount of power used to hold the camera in position while it is in standby mode. With the setting enabled the camera will consume more power, but will help ensure that the camera is held in place in rough seas.	<ul style="list-style-type: none"> • On (default) • Off

JCU Icon	Shows or hides the on-screen JCU connected icon.	<ul style="list-style-type: none"> • On (default) • Off
PC Icon	Shows or hides the on-screen PC connected icon.	<ul style="list-style-type: none"> • On (default) • Off
Restore Factory Defaults	Enables you to restore the camera's settings to factory default values.	

Note: The thermal camera menu options available are dependant on the software version of your multifunction display and thermal camera. If options are different than listed above please refer to the manual that accompanied your thermal camera and / or the installation and operations handbook which accompanied your multifunction display.

Chapter 22: Camera application

Chapter contents

- [22.1 Camera application overview on page 270](#)
- [22.2 Camera cycling on page 271](#)
- [22.3 Naming camera / video feeds on page 271](#)
- [22.4 Adjusting the video image on page 272](#)
- [22.5 Selecting the aspect ratio on page 272](#)
- [22.6 Selecting a location to store recordings on page 273](#)
- [22.7 Record and playback on page 273](#)
- [22.8 Taking photos on page 274](#)

22.1 Camera application overview

You can view a camera or a video feed which is connected directly to your multifunction display using the video input(s), or IP camera feeds which are available on your network.

The Camera application can be used to:

- Display live camera feeds.
- Automatically cycle through available camera feeds.
- If supported by the camera, adjust the brightness, contrast, color and aspect ratio of the video image.
- Record a live IP camera feed.
- Playback recorded IP camera footage.
- View 1 camera feed whilst recording a second IP camera feed.
- Open a different application whilst recording an IP camera feed.
- Take photos of an IP camera feed.
- View images.

Note: Recording and picture taking functions are only available on IP camera feeds.



1	Camera feed number – indicates the current feed and number of available feeds.
2	Recording status – indicates that the camera application is recording and the current elapsed time.
3	Camera name – indicates the name of the camera that is currently displayed.
4	Recording – indicates if the camera application is recording and which feed is being recorded.
5	Menu – Opens the Camera application main menu.
6	Cycle – indicates if the feed cycling is turned on or off.
7	*Record video – temporary onscreen icon to Start/stop recording.
8	*Take Photo – temporary onscreen icon to take a photo.

Note: * Only available on touchscreen displays.

Note: Your multifunction display must be powered up before power is applied to any networked IP cameras, this is to enable your multifunction display to assign the IP camera(s) a valid IP address.

Note: If your IP camera(s) are not detected by your multifunction display, try power cycling the IP camera(s) whilst leaving your multifunction display powered up.

Note: For information on connecting the camera / video source and compatible video formats, refer to the [Chapter 4 Cables and connections](#) section.

Changing the camera / video feed

On a New a Series or New e Series display, if more than 1 feed is available you can change which feed is displayed on the screen using touch.

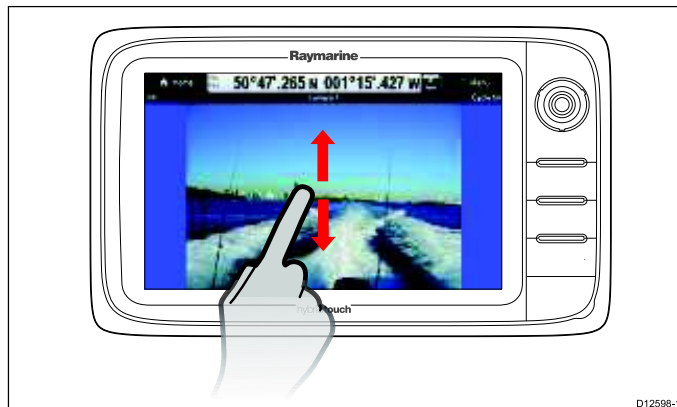

From the Camera application.

1. Touch and swipe your finger up to move to the next video feed.
2. Touch and swipe your finger down to display the previous video feed.

Changing the camera / video feed

On a New c Series or New e Series display, if more than 1 feed is available you can change which feed is displayed on the screen using the Joystick.

From the Camera application

1. Move the **Joystick Down** to display the next video feed.
2. Move the **Joystick Up** to display the previous video feed.

Changing the camera / video feed using the menu

On all display variants, when more than 1 feed is available, you can change which feed is displayed on the screen using the menu.

From the Camera application with a camera / video feed displayed:

1. Select **Menu**.
2. Select **Camera**.
3. Select the camera feed you want to display on the screen.

22.2 Camera cycling

When multiple camera / video feeds are available the camera application can be set up to automatically cycle through the available feeds at a specified time interval.

With camera cycling turned on the camera application will cycle through the available video input(s) on the display and available networked IP camera feeds. The feeds will be cycled in the order they appear in the Camera selection menu: **Menu > Camera**. Direct video input feeds will appear first and then any networked IP camera feeds. When the final feed in the list has been displayed the camera application will loop back to the first feed in the list.

Camera cycling will cycle through the multifunction displays available video input(s) even if no feed is connected to the input(s). Where no feed is present on a video input, during cycling the video input feed will appear as a blue screen. You can choose whether or not the video input(s) appear during camera cycling.

The time interval that each feed is displayed for, before switching to the next feed can be adjusted.

Turning on camera cycling

To turn on the camera cycling feature follow the steps below.

From the camera application:

1. Select **Menu**.
2. Select **Camera Cycling**.
3. Select **Camera Cycling** so that On is highlighted.

Selecting Camera Cycling will switch cycling On and Off.

When the menu is closed the camera application will cycle through all available feeds at the defined time interval.

Setting the time interval for camera cycling

The time interval that each video feed is displayed for can be set by following the steps below.

From the camera application, with Camera cycling turned on:

1. Select **Menu**.
2. Select **Camera Cycling**.
3. Select **Cycle interval**.

The cycle interval numeric adjust control is displayed.

4. Adjust the setting to the required time interval.

During camera cycling each feed is displayed for the time specified before changing to the next feed.

Showing or hiding video input feeds during camera cycling

By default your multifunction displays video input(s) are shown during cycling, even if no feed is connected to the input(s). You can choose whether video input(s) appear during camera cycling by following the steps below.

From the camera application:

1. Select **Menu**.
2. Select **Camera Cycling**.
3. Select the **Include <Camera Name>** option for the video input you want to Show or Hide.

Selecting **Include <Camera Name>** option will switch between showing or hiding the video input during camera cycling.

Note: In the steps above **<Camera Name>** represents the default feed name provided by the connected device or the custom name which can be assigned to the feed.

Turning off camera cycling

You can turn off camera cycling using the methods detailed below.

From the camera application, with camera cycling turned on:

1. Select **Menu > Camera Cycling > Camera Cycling** so that Off is highlighted, or
2. Change the camera / video feed manually as described earlier in this section.

22.3 Naming camera / video feeds

To help distinguish between camera feeds each feed can be named.

From the Camera application:

1. Select the feed you want to name so that it is displayed on the screen.
2. Select **Menu**.
3. Select **Adjust**.
4. Select **Edit Name**.

The onscreen keyboard is displayed.

5. Enter the name you want the feed to be called.
6. Select **SAVE** to save the new name for the feed.

The name of the feed is displayed in the camera application's status bar.

22.4 Adjusting the video image

If supported by your connected camera / video input device or networked IP camera, you can adjust the image settings.

With a video feed displayed in the Camera application:

1. Select **Menu**.
2. Select **Adjust**.
3. Select **Contrast**, **Brightness**, or **Color**, as appropriate.

The numeric adjust control is displayed.

4. Adjust the level to the required setting.

22.5 Selecting the aspect ratio

If supported by your connected camera / video input device or networked IP camera, you can manually change the aspect ratio between 4:3 and 16:9.

From the camera application with a feed displayed:

1. Select **Menu**.
2. Select **Adjust**.
3. Select **Aspect ratio** so that 4:3 or 16:9 is selected as required.

22.6 Selecting a location to store recordings

In order to record, playback or capture a still image of IP camera feeds you must select the location you want to save to.

If saving to a memory card ensure that a memory card with sufficient space is inserted into the relevant card reader slot.

Note: Do not save files to cartography chart memory cards.

From the Camera application:

1. Select **Menu**.
2. Select **Set-up**.
3. Select **Save Files to:**.
4. Select the location from the list:
 - SD1
 - SD2
 - Internal (default)

SD1 and SD2 will only be selectable if a memory card is inserted into the relevant slot.

Note: If your multifunction display only has 1 card reader slot then only SD1 and Internal is displayed.

22.7 Record and playback

The Camera application can be used to record live IP camera feeds from a connected IP camera. The recording can then be played back at any time.

The camera application records IP camera feeds in .mp4 format which can be saved to a memory card or to the display's internal storage.

The Camera application titlebar displays the name of the feed being recorded and a recording timer is displayed onscreen that shows the elapsed time.

Recording an IP camera feed

To record the feed from an IP camera follow the steps below.

From the Camera application:

1. Select **Menu**.
2. Select **Videos**.
3. Select **Record**.

The recording will start.



Whilst the camera application is recording you can use your multifunction display as normal e.g. view a different camera feed, go back to the Homescreen, or open a different application. The selected feed will continue to record until stopped or until the memory of the selected location is full.

Note: On a touchscreen display you can also start a recording using the onscreen icons. Refer to [Onscreen icons](#).

Stop recording

Recording can be stopped at any time.

From the Camera application:

1. Select **Menu**.
2. Select **Videos**.
3. Select **Stop**.

The File is saved and the Video Saved confirmation dialog is displayed.

4. Select **OK** to confirm, **Play** to playback the recorded file or **Delete** to delete the file.

The confirmation dialog will automatically close after 5 seconds.

Playing back a video file

You can playback video clips using the Camera application.

From the Camera application:

1. Select **Menu**.
2. Select **Videos**.
3. Select **View**.

The My Files browser is opened.

4. Locate the Video file you want to view.

Video files stored on internal storage are saved in **Internal > User Data > Video files**.

Video files stored on memory card are saved in **SD Card # > Raymarine > Video files**.

5. Select the Video file.

The file options dialog is displayed.

6. Select **Play Video**.

The Video file is played.

You can also playback video clips from the My Data menu from the Homescreen: **Homescreen > My Data > Images and Videos**.

Moving and copying video files

You can copy and move files between your display's internal storage and memory cards using the steps below.

Ensure you have a memory card inserted in the card reader.

From the Camera application:

1. Select **Menu**.
2. Select **Videos**.
3. Select **View**.

The My Files browser is opened.

4. Locate the relevant video file.

Video files stored on internal storage are saved in **Internal > User Data > Video files**.

Video files stored on memory card are saved in **SD Card # > Raymarine > Video files**.

5. Select the video file.
The file options dialog is displayed.
6. Select **Move** or **Copy**.
7. Confirm the location you want to move or copy the file to.
A progress indicator is displayed e.g.:





When the operation is complete a confirmation pop-up message is displayed.

8. Select **OK**.

22.8 Taking photos

When a camera feed from an IP camera is displayed you can capture a still image.

Photos can be taken using the following methods:

 <p>Capture</p>	<p>Capture — Immediate image capture.</p>
 <p>Timer</p>	<p>Timer — You can select the image to be taken in 5, 10 or 30 seconds after selection.</p>
 <p>Remote</p>	<p>Remote — You can use a wireless remote control (e.g. the RCU-3) to take the photo.</p>

Taking a photo

To take a photo of what is currently displayed in the Camera application follow the steps below.

If saving to a memory card ensure that a memory card with sufficient space is inserted into the relevant card reader slot.

From the Camera application, with an IP camera feed displayed:

1. Select **Menu**.
2. Select **Photos**.
3. Select **Capture**.

The photo is saved and a confirmation dialog is displayed showing a preview of the picture taken.



4. Select **OK** to confirm.
5. Select **View** to view the picture fullscreen.
6. Select **Delete** to delete the picture.

Note: On a touchscreen display you can also take a photo using the onscreen icons. Refer to [Onscreen icons](#).

Taking a photo using the timer

To take a photo after a defined interval follow the steps below.

If saving to a memory card ensure that a memory card with sufficient space is inserted into the relevant card reader slot.

From the Camera application:

1. Select **Menu**.
2. Select **Photos**.
3. Select **Timer**.
4. Select **Time Delay**.

A list of time intervals is displayed:

- 5 s
- 10 s
- 30 s

5. Select a time interval from the list.

6. Select **Start Timer**.
The photo will be taken after the time delay specified has elapsed. A confirmation dialog is then displayed showing a preview of the photo taken.
7. Select **OK** to confirm.
8. Select **View** to view the photo fullscreen.
9. Select **Delete** to delete the photo.

Taking a photo using a remote control

To take a photo using a Raymarine wireless remote control as the trigger follow the steps below.

If saving to a memory card ensure that a memory card with sufficient space is inserted into the relevant card reader slot.

1. Ensure that your wireless Raymarine remote control is paired to the multifunction display and working.
2. From the Camera application, select **Menu**.
3. Select **Photos**.
4. Select **Remote**.
The Remote dialog is displayed.
5. Press any button on the connected remote control to take a photo.
The photo is saved and a confirmation dialog is displayed showing a preview of the photo.
6. Select **OK** to confirm.
7. Select **View** to view the photo fullscreen.
8. Select **Delete** to delete the photo.

Viewing photos

You can view the photos you have taken by following the steps below.

From the Camera application:

1. Select **Menu**.
2. Select **Photos**.
3. Select **View**.
The My Files browser is opened.
4. Locate the photo you want to view.

Photos stored on internal storage are saved in **Internal > User Data > Image files**.

Photos stored on memory card are saved in **SD Card # > Raymarine > Image files**.

5. Select the file.
The file options dialog is displayed.
6. Select **View Image**.
The photo is displayed onscreen.

You can also view images from the My Data menu from the Homescreen: **Homescreen > My Data > Images and Videos**.

Moving and copying Photos

You can copy and move files between your display's internal storage and memory cards using the steps below.

Ensure you have a memory card inserted in the card reader.

From the Camera application:

1. Select **Menu**.
2. Select **Photos**.
3. Select **View**.
The My Files browser is opened.
4. Locate the relevant photo.

Photos stored on internal storage are saved in **Internal > User Data > Image files**.

Photos stored on memory card are saved in **SD Card # > Raymarine > Image files**.

5. Select the file.
The file options dialog is displayed.

6. Select **Move** or **Copy**.
7. Confirm the location you want to move or copy the file to.
A progress indicator is displayed e.g.:

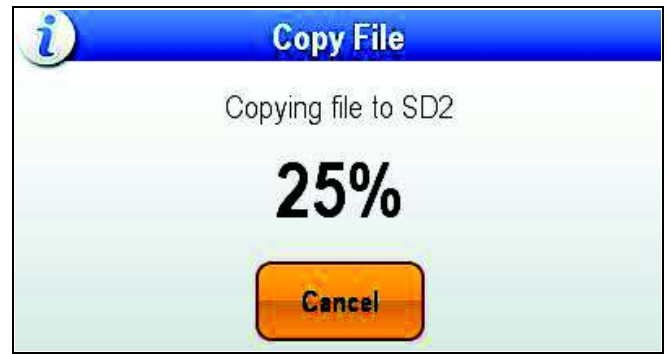

When the operation is complete a confirmation pop-up message is displayed.

8. Select **OK**.

Onscreen icons

On Touchscreen multifunction displays you can touch anywhere on the screen to display the onscreen icons

The onscreen icons can be used to start / stop recording or to take a picture.

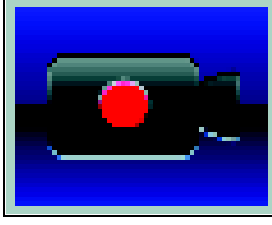
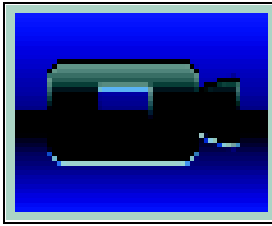
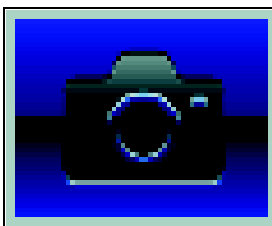
	Record icon
	Stop Recording icon
	Take Photo icon

The onscreen icons will close after 5 seconds.

Using the onscreen icons

1. Select the **Record icon** to start recording.
2. Select the **Stop recording icon** to stop the recording.
3. Select the **Take Photo icon** to capture a still image.

Chapter 23: Fusion link application

Chapter contents

- [23.1 Fusion link overview on page 278](#)
- [23.2 Media sources on page 279](#)
- [23.3 Browsing music on page 281](#)
- [23.4 Selecting shuffle and repeat functions on page 281](#)
- [23.5 Adjusting volume levels for each zone on page 282](#)
- [23.6 Selecting the zone to control on page 282](#)
- [23.7 Adjusting the tone controls on page 283](#)
- [23.8 Selecting the system to control on page 283](#)
- [23.9 Menu options on page 284](#)

23.1 Fusion link overview

The multifunction display can control a connected 700 series Fusion entertainment system.



1	Fusion menu options and track lists.
2	Shuffle and Repeat icons.
3	Track / media specific details and controls.
4	Zone volume control.
5	Zone selector.
6	Media source.
7	Media controls (See below).

Note: Album artwork is only available when using an iPod.

Media controls

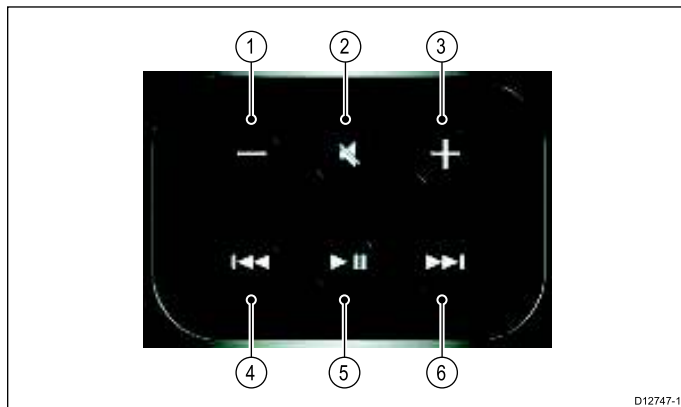

1	Volume Down.
2	Mute / Unmute.
3	Volume Up.
4	<ul style="list-style-type: none"> • Single press — Skips back to the beginning of the current track, subsequent presses will skip backwards through the available tracks. • Press and hold — Scans the current track backwards in 10 seconds intervals.
5	Play / Pause current track.
6	<ul style="list-style-type: none"> • Single press — Skips forward to the next track, subsequent presses will skip forwards through the available tracks. • Press and hold — Scans the current track forwards in 10 seconds intervals.

The Fusion link application can be used to:

- Browse available media sources.
- Adjust the volume level.
- Mute and Unmute the volume.
- Adjust the tone controls (Bass, Middle, and Treble).
- Skip backwards and forwards through tracks.
- Scan backwards and forwards through the current track.

- Play / Pause the current track.
- Select the zone to be controlled. (For information on setting up zones refer to the manual that accompanied your Fusion entertainment system.
- Set Shuffle and Repeat functions.

Accessing the Fusion link application

If more than one Fusion entertainment system is connected to your system then you can choose which system the Fusion link application will control.

1. Select the **FUSION link** page icon from the homescreen.
A list of connected Fusion entertainment systems is displayed.
2. Select the system you want to control.

23.2 Media sources

The layout and controls available are determined by the selected media source.

iPod

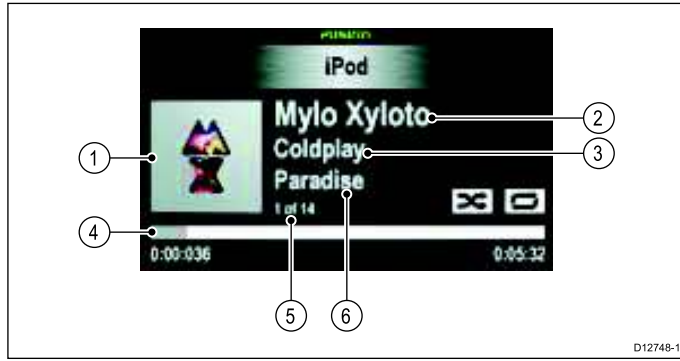

1	Album artwork.
2	Track title.
3	Artist.
4	Track progress.
5	Track number.
6	Album title.

Menu options available for iPods are as follows:

- Browse music.
- Repeat.
- Shuffle.
- Tone Controls.
- Select Fusion System.

USB

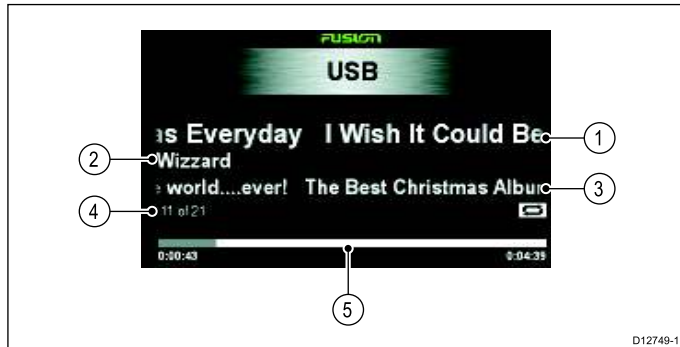

1	Track title.
2	Artist.
3	Album title.
4	Track number.
5	Track progress.

Menu options available for USB devices are as follows:

- Browse music.
- Repeat.
- Shuffle.
- Tone Controls.
- Select Fusion System.

DVD

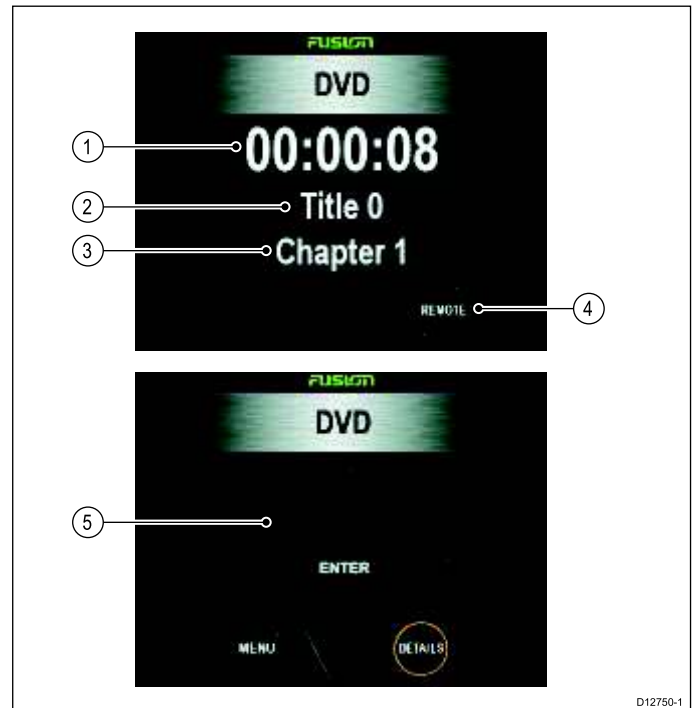

1	Time elapsed.
2	Title.
3	Chapter.
4	Remote button.
5	DVD remote controls including: <ul style="list-style-type: none"> • Directional keypad. • Enter. • Menu. • Details.

Menu options available for DVD devices are as follows:

- Tone Controls.
- Select Fusion System.

AM / FM radio

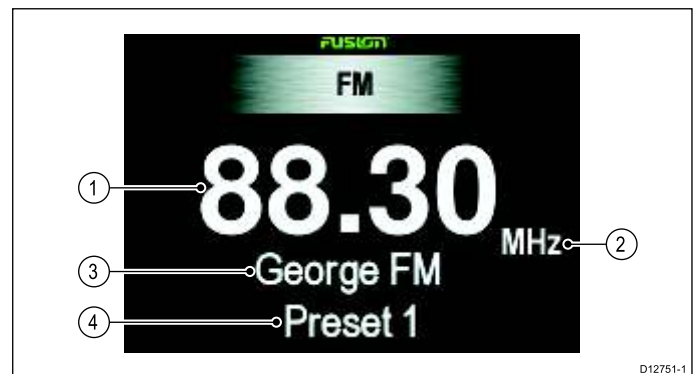

1	Frequency.
2	Frequency type.
3	Channel name.
4	Preset name.

Menu options available for the Radio are as follows:

- Preset.
- Tone Controls.
- Select Fusion System.

VHF

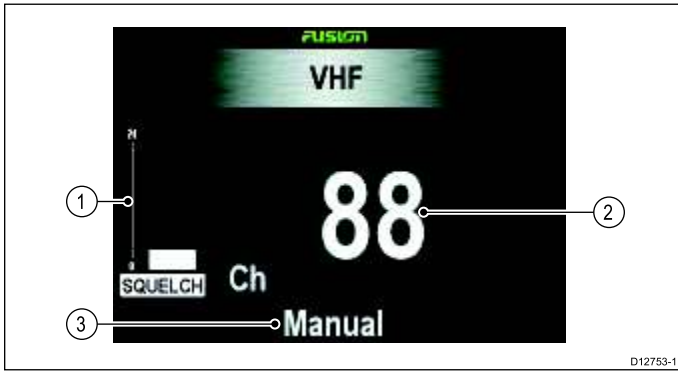

D12753-1

1	Squelch control.
2	Channel.
3	Manual / Auto status.

Menu options available for VHF radios are as follows:

- Preset.
- Scan.
- Tone Controls.
- Select Fusion System.

AUX



D12754-1

1	Input gain.
---	-------------

Menu options available for AUX devices are as follows:

- Tone Controls.
- Select Fusion System.

Satellite radio



D12752-1

1	Track name.
2	Artist.
3	Channel details.

Note: The Fusion head unit must be used to control a satellite receiver connected to a fusion media system. Current track information and channel details are displayed on the Fusion application.

Selecting a media source

You can select which media source you want to control.



From the Fusion link application:

1. Select **Src:**.
A list of media sources is displayed.
2. Select the relevant media source.

23.3 Browsing music

You can browse the music available on your connected iPod or USB device.

From the Fusion link application:

1. Select the **Menu** icon.
2. Select **Browse Music**.
The media device name is displayed.
3. Select the media device.
The contents of the device are displayed.
4. Browse the available folders by selecting on them.
5. Select the **Back** icon to move back up the folder structure.
6. Select the track that you want to listen to.
The main screen is displayed and the track will begin to play.

23.4 Selecting shuffle and repeat functions

You can set the Fusion link application to repeat the selected folder or to shuffle the play order.

From the Fusion link application:

1. Select the **Menu** icon.
2. Select **Repeat** to switch the repeat folder function on or off.
3. Select **Shuffle** to switch the shuffle function on or off.

23.5 Adjusting volume levels for each zone

The volume level for each zone can be adjusted individually or you can adjust all zones at the same time.

From the Fusion link application:

1. Select **Vol:**.

The zone volume control is displayed.

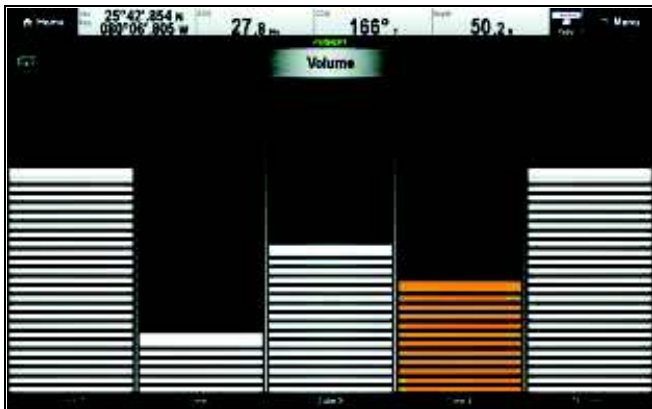

2. Select the relevant zone.
3. Adjust the volume level to the required setting.
4. Select the **Back** icon to go back to the main screen.

Note: Adjusting the All Zones level will adjust all of the zones at the same time.

23.6 Selecting the zone to control

You can select which zone the main screen will control.

From the Fusion link application:

1. Select **Zone:**.

The zone selection bar is displayed.



2. Select the zone you want to control.
3. The volume controls on the main screen will now control the volume level of the selected zone.

23.7 Adjusting the tone controls

The Bass, Middle, and Treble tone controls can be adjusted.

From the Fusion link application:

1. Select the **Menu** icon.
2. Select **Tone Controls**.
3. Select either Bass, Middle, or Treble.
4. Adjust the level to the required setting.
5. Select **Back** to go back to the menu options.
6. Select **Back** from the menu options to go back to the main screen.

23.8 Selecting the system to control

Where more than one Fusion entertainment system is connected you can select which system the Fusion link application will control.

From the Fusion link application:

1. Select the **Menu** icon.
2. Select **Select Fusion system**.
A list of available systems is displayed.
3. Select the system you want to control.

The Fusion link application will now control the selected system.

23.9 Menu options

Menu option	Media sources	Description
Browse Music	<ul style="list-style-type: none">• iPod.• USB.	Enables browsing of music stored on the device.
Repeat	<ul style="list-style-type: none">• iPod.• USB.	<ul style="list-style-type: none">• Off• Folder — Repeats all songs in the current folder.
Shuffle	<ul style="list-style-type: none">• iPod.• USB.	Switches track shuffle on and off.
Tone Controls	<ul style="list-style-type: none">• All devices.	Enables adjustment of the following tone controls: <ul style="list-style-type: none">• Bass.• Middle.• Treble.
Select Fusion system	<ul style="list-style-type: none">• All devices.	Enables you to select the Fusion entertainment system you want to control.
Preset	<ul style="list-style-type: none">• AM / FM Radio.• VHF Radio.	Enables selection and saving of channels as presets.
Scan	<ul style="list-style-type: none">• VHF Radio.	Enables scanning of saved channels.

Chapter 24: Weather application (North America only)

Chapter contents

- [24.1 Weather application overview on page 286](#)
- [24.2 Weather application set up on page 286](#)
- [24.3 Weather application display overview on page 287](#)
- [24.4 Weather map navigation on page 290](#)
- [24.5 Weather context menu on page 290](#)
- [24.6 Weather information on page 291](#)
- [24.7 Weather reports on page 291](#)
- [24.8 Animated weather graphics on page 292](#)
- [24.9 Weather application menu options on page 293](#)
- [24.10 Glossary of weather terms on page 294](#)

24.1 Weather application overview

The weather application overlays historical, live, and forecasted weather graphics on a world map.

The weather application can only be used in North America and its coastal waters.

The weather application graphics and their associated weather data enable you to determine the actual conditions in the vicinity of your vessel, or at a particular location.

Weather forecasts and warnings, detailing both current and predicted conditions, are regularly updated in the weather application.

Note: For types of warnings, watches, and advisories, refer to the NOAA website at www.nws.noaa.gov

Disclaimer — advisory only

The weather information is subject to service interruptions and may contain errors or inaccuracies and consequently should not be relied upon exclusively. You are urged to check alternate weather information sources prior to making safety related decisions. You acknowledge and agree that you shall be solely responsible for use of the information and all decisions taken with respect thereto. By using this service, you release and waive any claims against Sirius Satellite Radio Inc., WSI, Navcast Incorporated, and Raymarine with regard to this service.

If you do not have the subscription agreement, you may view a copy on the internet at www.sirius.com/marineweather

24.2 Weather application set up

A number of steps must be completed before you can use the weather application for the first time.

- Your multifunction display must be connected to a Raymarine Sirius weather receiver.
- Identify your Raymarine Sirius weather receiver's electronic serial number (ESN). This information can be obtained from the homescreen **Set-up** menu by selecting the device from the select devices page: **Set-up > Maintenance > Diagnostics > Select Device >**
- Using your ESN contact SiriusXM (www.siriusxm.com) to subscribe for Sirius Marine Weather (www.siriusxm.com/marineweather). When viewing the multifunction display's weather application, the ESN may be accessed from the following menu: **Menu > Sirius ESN**.
- You must be navigating within US coastal waters.
- Your multifunction display must obtain a GPS fix on your vessels location.
- You must specify the weather graphics that you want to display in the weather application.

Accessing the weather application

To access the weather application on your multifunction display follow the step below:

From the homescreen:

1. Select the **Weather** icon:



24.3 Weather application display overview

The weather application displays a range of graphics to indicate weather conditions and forecast information.

The following diagram illustrates the main features of the weather application display:

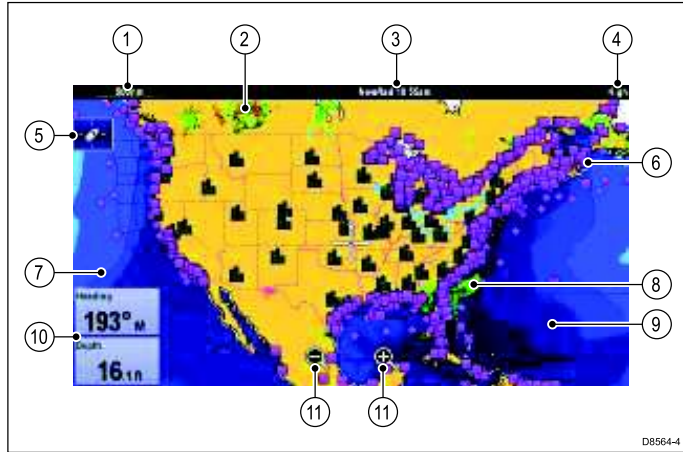

Item	Description
1	Range
2	Canadian radar
3	Animation and time / date
4	Signal strength
5	Find ship icon
6	Surface observation stations
7	Wave heights
8	NOWRad
9	Marine zones
10	Data overlay cells
11	On-screen Range in and out icons (Touchscreen displays only)

Weather symbols

The weather application uses a range of graphics and symbols to represent different weather conditions and forecasts.

Symbol	Description
	Storm cast (dark blue) arrows indicating direction and speed of a storm.
	Wave height <ul style="list-style-type: none"> • Highest waves (red) • Intermediate waves (greens) • Lowest waves (blues)
	Canadian radar (dark greens, yellow, orange and red)

Symbol	Description
	Lightning — a lightning symbol is shown at each cloud-to-ground strike: <ul style="list-style-type: none"> • Light (recorded in last 10–15 minutes.) • Medium (recorded in last 5–10 minutes.) • Dark (recorded in last 0–5 minutes.) More recent strikes are overlaid over older symbols.
	Wind — Wind symbols show the current wind direction and strength and can be displayed as either an arrow or a wind barb. Wind arrows indicate speed — the larger the arrow, the greater (stronger) the wind speed. Wind barbs give a more precise indication of wind speed as shown in the wind speed symbols section.
	Sea surface temperature (green, yellow and orange) <ul style="list-style-type: none"> • Blue — coldest • green • yellow • orange and red — warmest
	Surface observation stations (pink) — Current or historical weather data can be viewed at surface observation stations. Not all data is available for all stations.
	Cities — The city symbols enables you to access details of city weather forecasts. Up to 3 forecasts are displayed for each city.
	NOWRad <ul style="list-style-type: none"> • Rain (green, yellow and red.) • Snow (blues) • Mixture (pinks)

Storm tracking symbols

The weather application uses a range of symbols to represent different types of storm tracks. The storm tracking function enables you to monitor significant storms in the area.

Examples of significant storms include tropical disturbances, depressions, storms and cyclones, hurricanes, typhoons, and super typhoons.

The weather map displays the track that the storm has taken, its current and forecasted position, the wind radii (current position only), direction, and speed of travel.

Storm tracks are highlighted on the weather map in the form of symbols, as shown below.

Historical (grey)	Current (red)	Forecast (orange)	Description
			Hurricane (Category 1–5)
			Tropical storm
			Tropical disturbance, tropical depression

When a symbol is selected, additional storm information can be accessed by the context menu:

- Storm's name and type.
- Date and time.
- Position, direction and speed.
- Pressure and maximum wind speed and gusts.

Surface pressure symbols

The weather application uses a range of symbols to represent different surface pressure conditions.

Symbol	Description
	High / low pressure (blue and red)
	Warm front (red)
	Cold front (blue)
	Occluded front (purple)
	Stationary front (red-blue)
	Trough (brown)
	Squall line (red)
	Dry line (red)
	Isobars (grey)

Surface observation station symbols

The weather application uses a range of symbols to represent different types of surface observation station.

Symbol	Description
	Buoy station
	C-MAN (Coastal-marine automated network)
	WSI (Weather services international)
	NWS (National weather service)

Wind speed symbols

The weather application uses a range of symbols to represent different wind speeds.

Symbol	Speed	Symbol	Speed	Symbol	Speed
	3–7 kts		8–12 kts		13–17 kts
	18–22 kts		23–27 kts		28–32 kts
	33–37 kts		38–42 kts		43–47 kts
	48–52 kts		53–57 kts		58–62 kts
	63–67 kts		68–72 kts		73–77 kts
	78–82 kts		83–87 kts		88–92 kts
	93–97 kts		98–102 kts		etc.

Wave information symbols

The weather application uses a range of graphics and symbols to represent different types of wave information.

Symbol	Description
	Wave height — Waves are shown in 16 shades of color from: <ul style="list-style-type: none"> • Reds — Highest waves • Greens — Intermediate waves • Blues — Lowest waves
	Wave period — wave periods are shown using shades of blue, the darker the shade the shorter gap between successive waves. The wave period detail can be accessed by the context menu View Data option.
	Wave direction — direction of waves is indicated by blue arrows.

NOWRad precipitation color codes

NOWRad displays the type and level of precipitation:

Color code	Precipitation type	Reflectivity Intensity
Light green	Rain	(15 to 19 dBz)
Medium green	Rain	(20 to 29 dBz)
Dark Green	Rain	(30 to 39 dBz)
Yellow	Rain	(40 to 44 dBz)
Orange	Rain	(45 to 49 dBz)
Light red	Rain	(50 to 54 dBz)
Dark red	Rain	(55+ dBz)
Light blue	Snow	(5 to 19 dBz)
Dark blue	Snow	(20+ dBz)
Light pink	Mixed	(5 to 19 dBz)
Dark pink	Mixed	(20+ dBz)

Canadian radar precipitation color codes

Canadian radar shows the intensity of precipitation for Canada. Unlike NOWRad, Canadian radar does not show the precipitation type.

Color code	Intensity in mm per hour
Transparent (nothing shown at very low precipitation)	0.00 to 0.20 mm/hr
Light green	0.21 to 1.00 mm/hr
Medium green	1.01 to 4.00 mm/hr
Dark green	4.01 to 12.00 mm/hr
Yellow	12.01 to 24.00 mm/hr
Orange	24.01 to 50.00 mm/hr
Light red	50.01 to 100 mm/hr
Dark red	100.01+ mm/hr

Reflectivity intensity to rainfall correlation

You can use the table below to correlate reflectivity intensity in dBz to estimated rainfall in millimeters per hour or inches per hour.

Reflectivity Intensity	Rainfall (mm/hr)	Rainfall (in/hr)
5	0.0749	0.0029
10	0.1538	0.0059
15	0.3158	0.0123
20	0.6484	0.0253
25	1.332	0.0519
30	2.734	0.1066
35	5.615	0.219
40	11.53	0.4497
45	23.68	0.9235
50	48.62	1.8963
55	99.85	3.8949
60	205.05	7.9975
65	401.07	15.6424
70	864.68	33.723
75	1775.65	69.252
80	3646.33	142.21

Reflectivity Intensity	Rainfall (mm/hr)	Rainfall (in/hr)
85	7487.83	292.03
90	15376.51	599.69
95	31575.91	1231.46
100	64841.98	2528.84
105	133154.6	5193.03
110	273436.4	10664.02

Selecting weather graphics

From the weather application:

1. Select **Menu**.
2. Select **Display Graphics**.
The display graphics list is displayed.
3. Select each graphic you want to Show or Hide.
4. Selecting a graphic will switch between Show or Hide.

Note: The Wind Vector graphic options are Arrow or Barb.

24.4 Weather map navigation

You can move around the weather map and place waypoints.

When you open the weather application, a world map is displayed. If the system has a position fix for your vessel, the map will be centred on your location. As in the chart application, use the cursor to move around the map and view different locations, and the **Range Control** to zoom in and out. Use the **WPT** button to place waypoints.

Note: Waypoints are not displayed in the weather application, to view waypoints you will need to have an active chart application or radar application displayed.



Locating your vessel

The vessel icon can be repositioned to the center of the screen by following the steps below.

1. Select the Find Ship icon:  located on the left hand side of the screen.

24.5 Weather context menu

The weather application includes a context menu which provides positional data and the option to view weather reports from the cursor location.

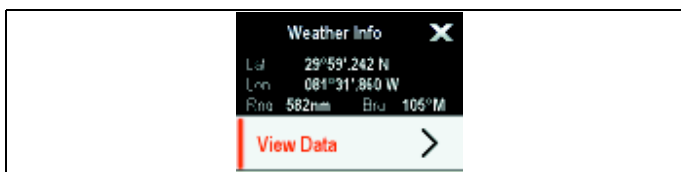

The context menu provides the following positional data for the cursor location in relation to your vessel:

- Latitude
- Longitude
- Range
- Bearing

Depending on the item or location selected on screen the context menu provides the following options:

- **View Report** — Only available when a city is selected.
- **View Data** — Not available when a city is selected.
- **View Full Report** — Only available when an observation station is selected.

Accessing the context menu

You can access the context menu by following the steps below.

1. Non-touchscreen and HybridTouch displays:
 - i. Selecting a location, object or target on-screen and pressing the **Ok** button.
2. HybridTouch and Touch only displays:
 - i. Selecting an object or target on-screen.
 - ii. Selecting and holding on a location on-screen.

24.6 Weather information

You can view weather information for:

- a specific location
- a surface observation station (when displayed)
- Cities (when displayed)

Viewing weather data at a specific location

You can view weather details at a particular location on the world map regardless of the display graphics being shown in your weather application.

From the weather application:

1. Select the location you wish to view weather details for.
The context menu is displayed.
2. Select **View Data**.
A weather information page is displayed.

Weather information page

When selecting **View Data** from the weather context menu the following information is displayed:

- Zone description
- Zone ID
- Precipitation intensity
- Precipitation type
- Sea surface temperature
- Wind speed
- Wind form
- Wave height
- Wave period
- Wave direction

Viewing weather station reports

You can view surface observation station reports by following the steps below:

From the weather application, with surface observation stations displayed:

1. Select a surface observation station.
The weather context menu is displayed.
2. Select **View Full Report**.
The station report is displayed.

Station report

Surface observation station reports contain the following information (when available)

- Station ID, name, type, bearing, time and date
- Air temperature
- Visibility
- Sea pressure
- Wind speed and form
- Sea temperature
- Wave information

Viewing city weather forecasts

You can view weather forecasts for a particular city by following the steps below:

From the weather application, with cities displayed:

1. Select a city.
The weather context menu is displayed.
2. Select **View Report**.
The City forecast is displayed. Up to 3 forecasts are shown.

Weather application (North America only)

24.7 Weather reports

You can view a number of different weather reports to give you a comprehensive view of the weather.

Your multifunction display shows weather reports for:

- Tropical statements.
- Marine warnings.
- Marine zone forecasts.
- Watchbox warnings.

Tropical statements

Tropical statements provide information on tropical weather conditions. This information may not be available in all areas.

Marine warnings

You can display a report for the current marine warnings in the US coastal or near shore areas, or for the zone around your cursor or vessel.

Marine zone forecasts

These forecasts cover:

- US coastal weather forecasts, offshore forecasts and high seas forecasts, or
- Great lakes forecasts and near shore forecasts, or
- Canadian coastal weather forecasts.

Watchbox warnings

When a tornado or thunderstorm warning is received within the specified alert range of your vessel, the system generates a watchbox alert. This alert provides information on the type of warning and validity period. The full watchbox report text is also displayed.

Displaying weather reports

From the weather application:

1. Select **Menu**.
2. Select **View Report**.
3. Select either **Tropical Statements**, **Marine Warnings**, **Marine Zone Forecasts**, or **Watchbox Warnings**.

The relevant report, warning, or statement is displayed.

Changing the position of forecasts on the weather map

From the weather application:

1. Select **Menu**.
2. Select **View Report**.
3. Select **Report At**.

Selecting report at will switch between reports from Ship location or Cursor location.

Note: You cannot change the position of Tropical Statements or Watchbox Warnings.

Watchbox alert box

The watchbox alert box is a red polygon which shows the location where severe weather is occurring.

The watchbox alert box shall be displayed if the weather application is displayed, watchbox alerts are On and the watchbox alert area is within the specified range from your vessel, or set to All.

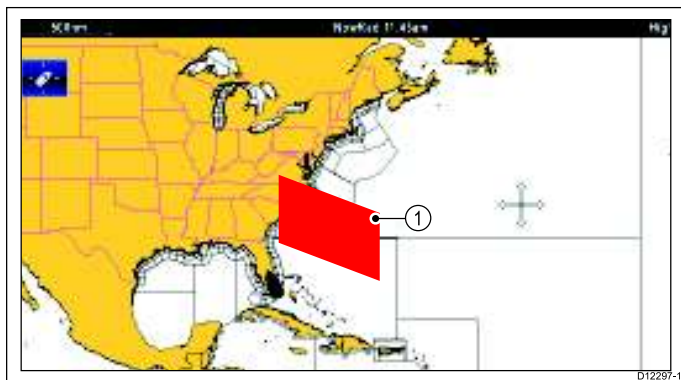

Item	Description
1	Watchbox alert box

Viewing watchbox alerts

You can view a watchbox alert at any time by following the steps below:

From the weather application with a watchbox alert box displayed.

1. Select the watchbox alert box.
The context menu is displayed.
2. Select **View Data**.
The watchbox alert message is displayed.

Setting watchbox alert range

You can specify the range from your vessel that you wish to receive watchbox alerts from.

From the weather application:

1. Select **Menu**.
2. Select **Watchbox Alerts**.
3. Select the required range, All, or Off if you do not want to receive watchbox alerts.
 - Selecting a range will display watchbox warnings occurring within the specified range.
 - Selecting All will display all watchbox warning regardless of range from your vessel.
 - Selecting Off will stop watchbox alerts.

Note: When the watchbox alert setting is set to Off watchbox reports will still be received but you will not be alerted.

24.8 Animated weather graphics

You can view animated weather graphics to provide an indication of changing weather patterns.

The animated weather option enables you to view an animation from the current time for:

- NOWRad — weather radar
- Wind
- Waves
- Pressure — surface pressure

Running a weather animation

From the weather application:

1. Select **Menu**.
2. Select **Animate Weather**.
3. Select **Animate**.
A list of animation is displayed.
4. Select the type of animation from the list.
5. Select **Play** so the On is displayed.
Selecting play will switch between on and off.



Note: You cannot display information (by moving the cursor over a symbol) when animation is running. The Range and Rotary controls do however remain operable provided the PAUSE option has not been selected. Ranging / panning will cause the animation to restart.

Note: The animation will be switched to Off if the animation menu is closed.

24.9 Weather application menu options

The following options are available from the weather application menu:

Menu item	Description	Options
Find Ship	Selecting Find Ship will reset the display to show your vessel in the center of the screen.	
Display Graphics	The Display Graphics menu allows to choose what graphics to Show or Hide in the weather application.	Display Graphics <ul style="list-style-type: none"> • Canadian Radar • Cities • Lightning • Marine Zones • NOWRad • Sea Surface Temperature • Storm Cast • Storm Tracks • Surface Pressure • Surface Observation Stations • Wind • Wind Vector — Arrow or Barb • Watchbox • Wave Height • Wave Period • Wave Direction
Animate Weather	The Animate Weather menu contains the following sub-menus: <ul style="list-style-type: none"> • Animate • Play • Pause • Adjust Range 	Animate: <ul style="list-style-type: none"> • NOWRad • Wind • Wave • Pressure Play: <ul style="list-style-type: none"> • On • Off Pause: <ul style="list-style-type: none"> • On • Off Adjust Range Adjust Range allows you to use the Range Control to zoom in and out.
View Report	The View Report menu allows you to view the different types of weather reports received. You can also select the location of the report.	Report At <ul style="list-style-type: none"> • Ship • Cursor View Report <ul style="list-style-type: none"> • Tropical Statements • Marine Warnings • Marine Zone Forecasts • Watchbox Warnings

Menu item	Description	Options
Watchbox Alert	The Watchbox Alerts menu allows you to turn alerts Off, or select a range.	Alert Range <ul style="list-style-type: none"> • Off • 50 nm • 150 nm • 300 nm • 500 nm • All <div style="border: 1px solid black; padding: 5px; margin-top: 10px;"> Note: Unit of measurement is dependant upon unit set-up choices. </div>
Data Overlay Set-up	Allows you to set up and display/hide up to 2 data cells in the bottom left corner of the screen: <ul style="list-style-type: none"> • Data Cell 1 • Select Data Category • Data Cell 2 • Select Data Category 	Data Cell 1 <ul style="list-style-type: none"> • On • Off Select Data Category Allows selection of a data type by category. Data Cell 2 <ul style="list-style-type: none"> • On • Off Select Data Category Allows selection of a data type by category.
Sirius User ID	This option will display your registered Sirius User ID.	

24.10 Glossary of weather terms

Term	Definition
Cold front	The boundary between two different air masses where cold air pushes warm air out of the way and brings colder weather.
Cyclone	A large area of low atmospheric pressure, characterized by inward spiralling winds. A "low" also called a "depression". Also the name used for a hurricane in the Indian Ocean and Western Pacific.
Depression	An area of low pressure. Also called a cyclone.
Dry line	A region where there is a strong gradient in dew point temperatures. It is often found in a region where strong thunderstorms develop.
Forecast	Something that tells us what the weather is probably going to be like.
Front	The boundary between two masses of air with different temperatures (i.e. a mass of cold air and a mass of warm air).
High	Also known as an 'anticyclone' an area of high atmospheric pressure with a system of winds rotating outwards. This usually means dry weather. It is the opposite of a 'low'.
High Pressure	A mass of air that presses down strongly on the surface of the Earth because it is being cooled and is therefore more dense.
Hurricane	<p>A violent, spiralling storm that forms over the Atlantic Ocean, with winds over 120 kph. Such storms usually have a lifespan of several days. Also known as a typhoon or tropical cyclone. There are 5 levels of hurricane:</p> <ul style="list-style-type: none"> • Category 1— Winds 74–95 mph (64–82 kt or 119–153 km/hr). Storm surge generally 4–5 ft above normal. No real damage to building structures. Damage primarily to unanchored mobile homes, shrubbery, and trees. Some damage to poorly constructed signs. Also, some coastal road flooding and minor pier damage. • Category 2— Winds 96–110 mph (83–95 kt or 154–177 km/hr). Storm surge generally 6–8 feet above normal. Some roofing material, door, and window damage of buildings. Considerable damage to shrubbery and trees with some trees blown down. Considerable damage to mobile homes, poorly constructed signs, and piers. Coastal and low lying escape routes flood 2–4 hours before arrival of the hurricane centre Small craft in unprotected anchorages break moorings. • Category 3— Winds 111–130 mph (96–113 kt or 178–209 km/hr). Storm surge generally 9–12 ft above normal. Some structural damage to small residences and utility buildings with a minor amount of curtain wall failures. Damage to shrubbery and trees with foliage blown off trees and large trees blown down. Mobile homes and poorly constructed signs are destroyed. Low lying escape routes are cut by rising water 3–5 hours before arrival of the centre of the hurricane. Flooding near the coast destroys smaller structures with larger structures damaged by battering from floating debris. Terrain continuously lower than 5 ft above mean sea level may be flooded inland 8 miles (13 km) or more. Evacuation of low lying residences with several blocks of the shoreline may be required. • Category 4— Winds 131–155 mph (114–135 kt or 210–249 km/hr). Storm surge generally 13–18 ft above normal. More extensive curtain wall failures with some complete roof structure failures on small residences. Shrubs, trees, and all signs are blown down. Complete destruction of mobile homes. Extensive damage to doors and windows. Low lying escape routes may be cut by rising water 3–5 hours before arrival of the centre of the hurricane. Major damage to lower floors of structures near the shore. Terrain lower than 10 ft above sea level may be flooded requiring massive evacuation of residential areas as far inland as 6 miles (10 km). • Category 5— Winds greater than 155 mph (135 kt or 249 km/hr). Storm surge generally greater than 18 ft above normal. Complete roof failure on many residences and industrial buildings. Some complete building failures with small utility buildings blown over or away. All shrubs, trees, and signs blown down. Complete destruction of mobile homes. Severe and extensive window and door damage. Low lying escape routes are cut by rising water 3–5 hours before arrival of the centre of the hurricane. Major damage to lower floors of all structures located less than 15 ft above sea level and within 500 yards of the shoreline. Massive evacuation of residential areas on low ground within 5–10 miles (8–16 km) of the shoreline may be required.
Isobar	A line on a weather map linking areas with equal air pressure.
Lightning	Discharge of static electricity in the atmosphere, usually between the ground and a storm cloud.
Low	Also called a 'depression' this region of low pressure can mean wet weather.
Low Pressure	A mass of air that presses down only weakly on the surface of the Earth's surface as it is warmed and it therefore less dense.
Millibar	A unit used to measure atmospheric pressure.
Occluded Front	An area where warm air is pushed upwards as a cold front overtakes a warm front and pushes underneath it.
Precipitation	Moisture that is released from the atmosphere as rain, drizzle, hail, sleet or snow, as well as dew and fog.
Pressure Centre	A region of high or low pressure.
Squall line	A non-frontal band, or line, of thunderstorms.
Super typhoon	A typhoon that reaches maximum sustained 1 minute surface winds of at least 65 m/s (130 kt, 150 mph). This is the equivalent of a strong category 4 or 5 hurricane in the Atlantic basin or a category 5 severe tropical cyclone in the Australian basin.
Tornado	A funnel shaped whirlwind which extends to the ground from storm clouds.
Tropical cyclone	A low pressure system that generally forms in the tropics. The cyclone is accompanied by thunderstorms and, in the Northern Hemisphere, a counterclockwise circulation of winds near the earth's surface.
Tropical depression	An organized system of clouds and thunderstorms with a defined surface circulation and maximum sustained winds of 38 mph (33 kt) or less.
Tropical storm	An organized system of strong thunderstorms with a defined surface circulation and maximum sustained winds of 39–73 mph (34–63 kt).
Tropics	An area on the Earth's surface that lies between 30° north and 30° south of the equator.
Trough	An elongated area of relatively low atmospheric pressure, usually extending from the centre of a low pressure region.

Term	Definition
Typhoon	The name for a tropical storm originating in the Pacific Ocean, usually the China Sea. They are basically the same as the hurricanes of the Atlantic Ocean and the cyclones of the Bay of Bengal.
Wave cyclone	A storm or low pressure centre that moves along a front.
Wave period	The period is the time gap between successive waves and the longer the period the faster the waves travel.

Chapter 25: Sirius audio application (North America only)

Chapter contents

- [25.1 Sirius audio overview on page 298](#)

25.1 Sirius audio overview

A connected, compatible Raymarine Sirius marine weather / satellite radio receiver can be controlled using the Sirius audio application.

Note: A Sirius subscription is required to enable use of a Sirius marine weather / satellite radio receiver.

To enable volume controls the Raymarine Sirius marine weather / satellite radio receiver also needs to be connected to a vessel entertainment system. Volume control is achieved using a combination of the multifunction display controls and the vessel entertainment system controls.

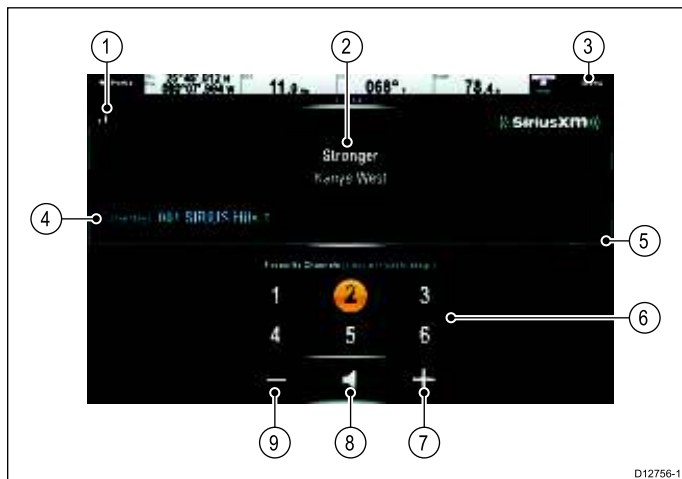

1	Signal strength (Between 0 and 3 bars).
2	Track name and Artist name.
3	Menu — The menu is used to browse available satellite radio channels.
4	Station details.
5	Sirius receiver ID.
6	Favorite channels.
7	Volume up.
8	Mute / Unmute.
9	Volume down.

The Sirius audio application can be used to:

- Browse available radio channels.
- Switch radio channel.
- Assign channels as favorites.
- Change the volume level.
- Mute the volume.

Note: Sirius satellite radio is only available in North America.

Accessing the Sirius audio application

1. Select the **Sirius Audio** page icon from the homescreen.

Changing the channel

You can view a list of available satellite radio channels and select the station you want to listen to.

From the Sirius Audio application:

1. Select **Menu**.
2. Select **Select channel**.

The Channel browser is displayed.



3. Select the relevant channel from the list.

Adding favorites

You can programme up to 6 favorite channels in the Sirius audio application. To save the current channel as a favorite follow the steps below.

1. Switch to the channel you want to save as a favorite.
2. When the channel is displayed onscreen select and hold on a favorite channel number (1 to 6) for 2 seconds.

The radio channel is now assigned as a favorite.

Using the volume controls

The Sirius audio application can be used to control the volume of your Sirius audio receiver.

With the Sirius audio application displayed:

1. Select the **Volume up** or **Volume down** icon to change the volume level, or
2. Select the **Mute icon** to mute and un-mute the audio.

Chapter 26: Mobile applications

Chapter contents

- [26.1 Raymarine mobile apps on page 300](#)
- [26.2 Enabling Wi-Fi on page 301](#)
- [26.3 Enabling mobile apps on page 301](#)
- [26.4 Setting up Wi-Fi security on page 302](#)
- [26.5 Selecting a Wi-Fi channel on page 302](#)

26.1 Raymarine mobile apps

Raymarine mobile apps enable viewing and control of your multifunction display via a compatible mobile device, using a Wi-Fi connection.

Raymarine currently offers the following mobile apps:

- **RayView**
- **RayRemote**
- **RayControl**

Note: Your multifunction display must have software version V3.15 or later in order to use mobile apps.

RayView

This app enables you to stream what you see on your multifunction display to a compatible smartphone or tablet device, using a Wi-Fi connection.

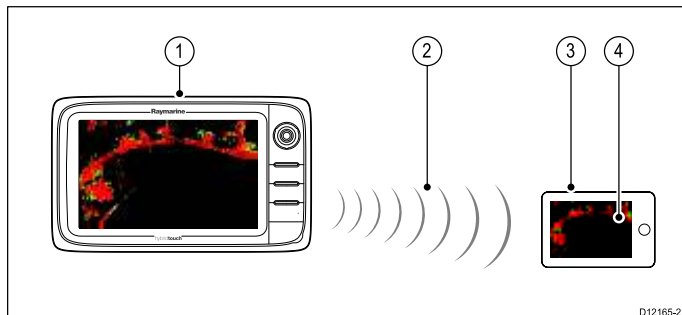

1. Multifunction display.
2. Wi-Fi connection (1 way – streaming only).
3. Compatible device.
4. “RayView” video streaming app.

RayControl

— This app enables you to stream and remotely control your multifunction display from a compatible tablet device, using a Wi-Fi connection.

Note: For safety reasons pilot controls and power button options are not available remotely.

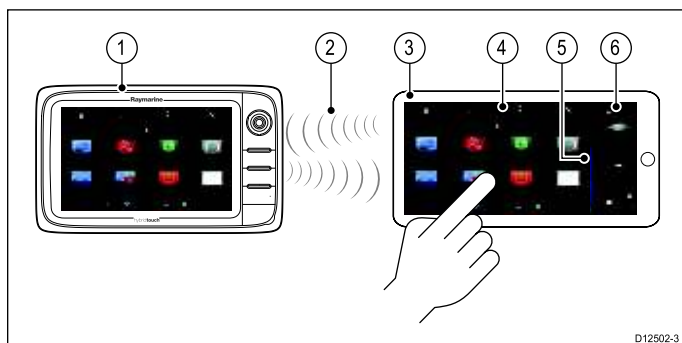

1. Multifunction display.
2. Wi-Fi connection (2 way – streaming and remote control).
3. Compatible tablet.
4. “RayControl” streaming and remote control app.
5. “RayControl” controls access (Touch the arrow to access controls).
6. “RayControl” remote controls

RayRemote

This app enables you to stream or control your multifunction display remotely from a compatible smartphone, using a Wi-Fi connection.

Note: RayRemote is able to switch between displaying the remote controls or the video stream.

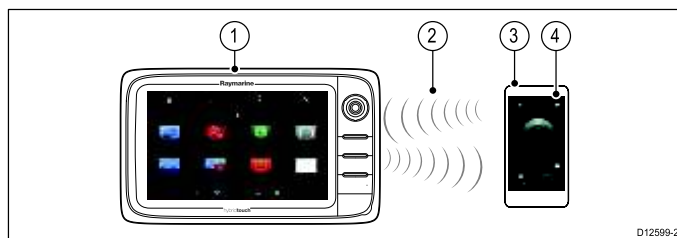

1. Multifunction display.
2. Wi-Fi connection (2 way – streaming or remote control).
3. Compatible smartphone.
4. RayRemote app

To use Raymarine mobile apps you must first:

- Download and install the required app from the relevant app store.
- Enable Wi-Fi in the System Settings on the multifunction display.
- Enable Wi-Fi on your compatible device.
- Select the Raymarine Wi-Fi connection from the list of available Wi-Fi networks on your compatible device.
- Enable the relevant type of connection (i.e. Viewing or Remote Control) in the System Settings on the multifunction display.

Mobile app compatibility

The Raymarine mobile apps are compatible with the following devices.

Device	Operating system
iPhone 4 or later	iOS
iPad 2 or later	iOS
Android smartphone	Android V2.2.2 or greater with 1GHz or greater processor
Android tablet	Android V2.2.2 or greater with 1GHz or greater processor
Kindle Fire	Android \ amazon

26.2 Enabling Wi-Fi

With the homescreen displayed:

1. Select **Set-up**.
2. Select **System Settings**.
3. Select **Wireless Connections**.
4. Select **Wi-Fi > ON**.

26.3 Enabling mobile apps

Raymarine mobile apps must be enabled on your multifunction display before you can stream video or remote control your multifunction display via a tablet or smartphone device.

With the homescreen displayed:

1. Select **Set-up**.
2. Select **System Settings**.
3. Select **Wireless Connections**.
4. Select **Mobile apps**.
5. Select **Viewing only** to enable video streaming only, or
6. Select **Remote Control** to enable remote control and video streaming using.
7. Launch the relevant Raymarine mobile app on your tablet or smartphone device and follow the on-screen instructions.

26.4 Setting up Wi-Fi security

You can encrypt the Wi-Fi connection on the multifunction display to prevent unauthorized devices from accessing the connection. The default encryption is WPA2.

With the homescreen displayed:

1. Select **Set-up**.
2. Select **System Settings**.
3. Select **Wireless Connections**.
4. Select **Wi-Fi > On**.
5. Select **Wi-Fi Name** and specify the SSID. This should be a memorable word and must be unique to each multifunction display in your system.
By default the SSID is the serial number of the multifunction display.
6. Select **Wi-Fi Security** and specify the type of encryption you want to use — None, WPA only, WPA2 only (default), or WPA/WPA2.

Note:

- Raymarine strongly recommends the use of the **WPA2** security setting.
- Selecting **None** for your Wi-Fi Security will leave your Wi-Fi open and allow anyone with a Wi-Fi enabled device access to your system.

7. It is recommended that the default **Wi-Fi Passphrase** is NOT changed.

Note: Once Wi-Fi security is set up on the multifunction display you must specify the same SSID and password credentials on your iPhone or iPad before wireless video streaming can be used.

Changing the default passphrase

It is recommended that the default passphrase is not changed, however if you do need to change the passphrase follow the steps below:

From the Wireless Connections menu: **Set-up > System Settings > Wireless Connections**

1. Select **Wi-Fi Passphrase**.
The on-screen keyboard will be displayed, showing the current passphrase.
2. Use **DEL** to delete the current passphrase.
3. Enter a new passphrase.

Note: Ensure the passphrase you choose is 'strong' by using a combination of upper/lower case letters, numbers and special characters. The passphrase can be between 8 and 63 characters in length with longer passphrases being more secure.

4. Select **SAVE** to save the new passphrase.

26.5 Selecting a Wi-Fi channel

By default the multifunction display automatically selects an available Wi-Fi channel. If you're experiencing difficulties with wireless video streaming it may be necessary to manually specify a Wi-Fi channel for both the multifunction display and the device you want to stream video to.

With the homescreen displayed:

1. Select **Set-up**.
2. Select **System Settings**.
3. Select **Wireless Connections**.
4. Select **Wi-Fi > On**.
5. Select **Wi-Fi Channel**.
6. Select one of the listed channels.

Chapter 27: Customizing your display

Chapter contents

- [27.1 Language selection on page 304](#)
- [27.2 Boat details on page 305](#)
- [27.3 Units set-up on page 306](#)
- [27.4 Time and Date set-up on page 307](#)
- [27.5 Display preferences on page 308](#)
- [27.6 Databar and databox overview on page 310](#)
- [27.7 List of data items on page 311](#)
- [27.8 System set-up menus on page 318](#)

27.1 Language selection

The system can operate in the following languages:

English (US)	English (UK)	Arabic
Bulgarian	Chinese	Croatian
Czech	Danish	Dutch
Finnish	French	German
Greek	Icelandic	Italian
Japanese	Korean	Norwegian
Polish	Portuguese (Brazilian)	Russian
Slovenian	Spanish	Swedish
Turkish		

With the Homescreen displayed:

1. Select **Customize**.
2. Select **Language**.
3. Select your language from the list of languages.

27.2 Boat details

You can customize various settings to make them specific to your vessel.

Menu item	Description	Options
Boat Type	<p>You can change the appearance of the vessel in the chart application. Select the option that most closely resembles the type and size of your vessel.</p> <div style="border: 1px solid black; padding: 5px; margin: 5px 0;"> <p>Note: When boat type is selected during the initial set up of the multifunction display the boat type shall determine the datapage configuration in the data application.</p> </div>	<ul style="list-style-type: none"> • Power Cruiser 1 (default) • Power Cruiser 2 • Power Cruiser 3 • Inboard Speed Boat • Outboard Speed Boat • Workboat • RIB • Sail Cruiser • Race Sail • Catamaran • Sport Fishing • Pro Fishing
Num. of Engines	Allows you to specify the number of engines your vessel has. This setting determines the number of engines shown in the engine data application.	• 1 to 5
Num. of Fuel Tanks	Allows you to specify the number of fuel tanks your vessel has. This setting determines the number of fuel tanks available in the Data application.	• 1 to 5
Num. of Batteries	Allows you to specify the number of batteries your vessel has. This setting determines the number of batteries available in the Data application.	• 1 to 5
Total Fuel Capacity	Allows you to specify the total fuel capacity of your vessel, this is required in order to enable the fuel manager function.	• 0 to 9999 units.

Customizing the vessel icon

With the homescreen displayed:

1. Select **Customize**.
2. Select **Boat Details**.
3. Select **Boat Type**.
4. Select the icon that most closely resembles your vessel type and size.

27.3 Units set-up

You can specify your preference for the units of measurement that will be used in all applications.

Menu item	Description	Options
Distance Units	The units of measure that will be used in all applications for the display of all values related to distance.	<ul style="list-style-type: none"> • Nautical Miles • NM & m (major units = Nautical Miles, minor units = meters) • Statute Miles • Kilometers
Speed Units	The units of measure that will be used in all applications for the display of all values related to speed.	<ul style="list-style-type: none"> • Knots • MPH (Miles Per Hour) • KPH (Kilometers Per Hour)
Depth Units	The units of measure that will be used in all applications for the display of all values related to depth.	<ul style="list-style-type: none"> • Feet • Meters • Fathoms
Temperature Units	The units of measure that will be used in all applications for the display of all values related to temperature.	<ul style="list-style-type: none"> • Fahrenheit • Celsius
Pressure Units	The units of measure that will be used in all applications for the display of all values related to pressure.	<ul style="list-style-type: none"> • Bar • PSI • Kilopascals
Volume Units	The units of measure that will be used in all applications for the display of all values related to volume.	<ul style="list-style-type: none"> • US Gallons • Imperial Gallons • Liters
Economy Units	The units of measure that will be used in all applications for the display of all values related to fuel usage.	<ul style="list-style-type: none"> • Distance per Volume • Volume per Distance • Liters per 100 km
Wind Speed Units	The units of measure that will be used in all applications for the display of all values related to wind speed.	<ul style="list-style-type: none"> • Knots • Metres per second

Specifying preferred units of measurement

1. Select **Customize**.
2. Select **Units Set-up**.
3. Select the type of measurement you want to change (for example, Distance Units).
4. Select the preferred type of unit (for example, Statute Miles).

27.4 Time and Date set-up

You can specify your preference for the way that time and date will appear in all applications.

Menu item	Description	Options
Date Format	Allows you to specify the preferred format for the display of date information in all applications.	<ul style="list-style-type: none">• MM:DD:YY (Month, Day, Year)• DD:MM:YY (Day, Month, Year)
Time Format	Allows you to specify the preferred format for the display of time information in all applications.	<ul style="list-style-type: none">• 12hr• 24hr
Local Time: UTC	Allows you to specify the local time zone that will be used, in terms of an offset from UTC (Universal Coordinated Time), in 0.5 hour increments.	<ul style="list-style-type: none">• -13 to +13 hours (in 0.5 hour increments)

27.5 Display preferences

You can specify your preference for general display behavior.

Menu item	Description	Options
Starting page	Allows you to select what page the display opens at start up.	<ul style="list-style-type: none"> • Homescreen (default) • Last page — After power up the last used page is displayed. • Choose page — After power up the page selected is displayed.
Key Beep	An audible sound can be made each time a button is pressed or the touchscreen is used.	<ul style="list-style-type: none"> • ON (default) • OFF
Cursor Autohide	If set to On, the cursor will be automatically hidden after a period of no movement. If set to Off, the cursor will persist on the screen until moved.	<ul style="list-style-type: none"> • ON • OFF (default)
Range Controls	<p>On New e Series and gS Series displays you can specify whether the Chart, Radar and Weather application display the onscreen range in and range out icons.</p> <div style="border: 1px solid black; padding: 5px;"> <p>Note:</p> <ul style="list-style-type: none"> • Onscreen range controls are not available on non-touchscreen displays. • Onscreen range controls cannot be hidden on touch only displays. </div>	<ul style="list-style-type: none"> • Show (default) • Hide
Context Menu	(Touchscreen displays only) Determines how the context menu is accessed using touch	<ul style="list-style-type: none"> • Touch (default) — touching a chart object opens the context menu. • Hold — Touch and holding on a chart object opens the context menu.
Pilot Control Bar	<p>Allows you to enable and disable the pilot bar on each display individually, when connected to an SPX or SeaTalk autopilot.</p> <div style="border: 1px solid black; padding: 5px;"> <p>Note: For evolution autopilots the Pilot Bar option is in the Pilot Set-up page.</p> </div>	<ul style="list-style-type: none"> • Shown • Hidden
Shared Brightness	You can set up shared brightness groups (or “zones”) to adjust the brightness on multiple units simultaneously.	<p>Share Brightness</p> <ul style="list-style-type: none"> • ON (default) • OFF <p>Brightness Group</p> <ul style="list-style-type: none"> • Helm 1 (default) • Helm 2 • Cockpit • Flybridge • Mast • Group 1 • Group 2 • Group 3 • Group 4 • Group 5
Screenshot File	<p>Enables you to specify the default memory card slot for screen capture images.</p> <div style="border: 1px solid black; padding: 5px;"> <p>Note: This option is only available on displays with multiple card reader slots.</p> </div>	<ul style="list-style-type: none"> • MicroSD 1 • MicroSD 2

Onscreen range controls

You can enable and disable onscreen range controls on New e Series and gS Series displays by following the steps below.

From the homescreen:

1. Select **Customize**.
2. Select **Display Preferences**.

3. Select **Range Controls**.

Selecting Range Controls will switch between showing and hiding the onscreen range controls.

Shared brightness

You can set up shared brightness groups to adjust the brightness on multiple units simultaneously.

The following units are compatible with shared brightness groups:

- New a Series
- New c Series.
- New e Series.
- gS Series
- i50
- i60
- i70
- p70 / p70R pilot controllers
- ST70
- ST70+

Once compatible units are added to a shared brightness group, any brightness adjustment made to any of the units in the group is also reflected in all other units in that group. An on-screen single brightness control is available for controlling any units in the brightness group:



Multiple brightness groups can be configured. This can reflect the physical location of the units on your vessel if required. For example, the units at your helm can be set to one group, and the units on the flybridge can be set to a different group. In this example, any brightness adjustments made to a unit at the helm would be automatically reflected in the other units at the helm but not on the flybridge.

The shared brightness function requires the following:

- All units must be compatible with the shared brightness function (see list of compatible units above).
- Before a unit can respond to a shared brightness adjustment it must be assigned to the relevant **Brightness Group**.
- A single unit can only belong to one brightness group at any one time.
- The **Share brightness** setting must be set to On for all units in the brightness group.
- When setting up a brightness group an initial **Sync brightness** operation must be performed, with all the displays in that group powered on, to configure the display brightness of all units in the group.

Setting up shared brightness

With the homescreen displayed:

Customizing your display

1. Select **Customize**.
2. Select **Display Preferences**.
3. Select **Shared Brightness**.
4. Select the On option for the **Shared brightness** menu item.
5. Select **Brightness Group**.
6. Select an appropriate brightness group.
7. Repeat the process for the other displays you want in the brightness group. If the display is not a multifunction display, refer to the documentation that accompanies the unit for instructions on setting-up shared brightness.
8. Once all required displays have been added to the same brightness group, select **Sync Brightness** on the multifunction display.
A shared brightness message is displayed.
9. Ensure all displays in the brightness group are powered on.
10. Select **Sync**.
When completed a message is displayed confirming that shared brightness has been configured.

Once shared brightness has been successfully configured, changing the brightness of any display in that brightness group will automatically change the brightness of all displays in that group.

27.6 Databar and databox overview

You can customize the data displayed in the databar and onscreen databoxes.

Customizable data is displayed in the databar, extended databar (HybridTouch displays only) or databoxes. The databar, extended databar and databoxes are available in all applications.

These areas of the screen are illustrated and described below:

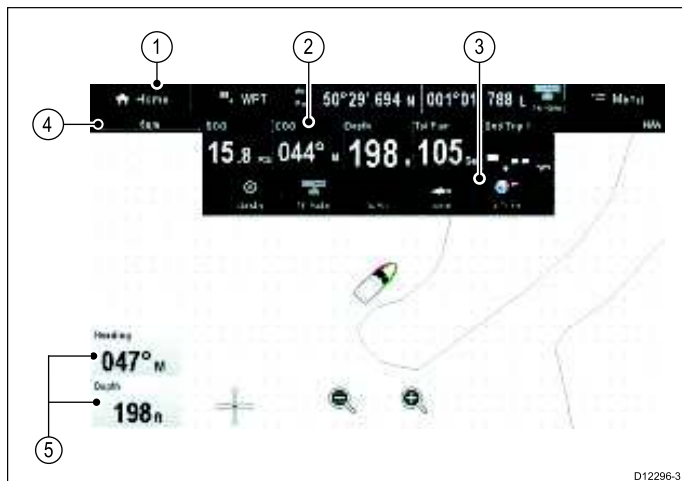

1. **Databar** — displayed at the top of the screen in all applications. The databar contains cells that can be customized to display data from a wide range of categories. The databar can also be hidden to provide
2. **Expanded Databar** — (Touchscreen displays only) displayed when you touch the databar. The extended databar can be displayed. The expanded databar is displayed until the screen is touched again.
3. **Status icons** — You can display the status icons below the expanded databar. This provides status information for externally connected equipment:
4. **Status Bar** — Permanently displayed in all applications. The status bar contains information on the currently selected settings of the application displayed onscreen.
5. **Databoxes** — up to 2 databoxes can be displayed. Each box can display one item of data from the available data categories. Data is permanently displayed onscreen.

The databar can be set to auto-hide so that only the Status bar is visible onscreen.

Auto-hide the databar

On multifunction displays that have a touchscreen, the databar that is displayed at the top of all applications pages can be set to auto-hide. This provides a larger screen area for the application pages.

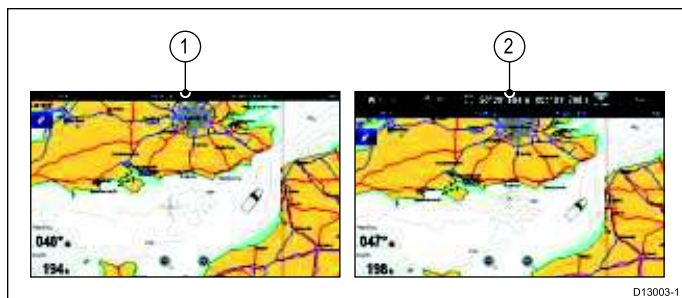

From the Homescreen:

1. Select **Customize**.
2. Select **Databar Set-up**.
3. Select **Auto-Hide** so that On is selected.

When viewing application pages the databar will now auto-hide after 10 seconds. You can view the databar again by touching the databar with your finger.

Customizing databoxes in the chart application

To switch databoxes on and off and to select data to display follow the steps below.

From the Chart application menu:

1. Select **Presentation**.
2. Select **Overlay**.
3. Select **Databoxes**.
4. Select **Databox 1 > On**.
5. Select **Databox 2 > On**.
6. Choose the **Select Data** option for the relevant databox.
7. Select the category that reflects the type of data you want to display in the databox. For example, Depth data.
8. Select the data item.
The data you selected is displayed onscreen in the appropriate databox.

Customizing Databoxes

In the Radar, Fishfinder, or Weather application:

1. Select **Menu**.
2. Select **Presentation**.
3. Select **Databoxes**.
4. Select **Databox 1 > ON**.
5. Select **Databox 2 > ON**.
6. Choose the **Select Databox 1** or **Select Databox 2** menu item, as appropriate.
7. Select the category that reflects the type of data you want to display in the databox. For example, Depth data.
8. Select the data item.
The data you selected is displayed onscreen in the appropriate databox.

Customizing the databar

From the homescreen:

1. Select **Customize**.
2. Select **Databar Set-up**.
3. Select **Edit Databar**.
4. In the databar, select the cell that you want to change.
The Select Data Category menu will be displayed.
5. Select the category that reflects the type of data you want to display in the cell. For example, Depth data.
6. Select the data item.
The data you selected is displayed on-screen in the appropriate cell.
7. Select **Home** or **Back** when completed.

Displaying status icons in the databar

Touchscreen multifunction displays enable you to display status icons in the databar.



























From the homescreen:















































1. Select **Customize**.
2. Select **Databar Set-up**.
3. Select **Status Icon Bar** so that On is highlighted.
The status icons are now displayed below the expanded databar.

































27.7 List of data items































Categories of data available to display in the data application, databoxes, databar, and expanded databar are shown below. Dial graphics are not available in databoxes or databars.





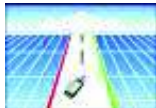



































The following table shows the data items available by category.



































Data Category	Description	Data Item	Data application Graphics			
Battery**	Battery status	Battery Amps				
		Battery Temperature				
		Battery Voltage				
Boat	Types of data generated by your vessel. For example, tank levels.	Rate of Turn				
		Heel Angle				
		Trim Tabs (Data application only.)				
Depth	Depth data.	Depth				
		Maximum Depth				
		Minimum Depth				
Distance	Types of data related to distance travelled by your vessel. For example, trip distance.	Log & Trip				
		Log				
		Trip				
		Ground Log and Trip				
		Ground Log				
		Ground Trip 1				
		Ground Trip 2				
		Ground Trip 3				
		Ground Trip 4				











Data Category	Description	Data Item	Data application Graphics			
Engine**	Types of data generated by engines. For example, oil pressure.	RPM				
		RPM & Speed				
		Coolant Temperature				
		Coolant Pressure				
		Oil Temperature				
		Oil Pressure				
		Oil Pressure & Coolant Temperature				
		Transmission Oil Temperature				
		Transmission Oil Pressure				
		Transmission Gear				
		Boost Pressure				
		Fuel Pressure				
		Fuel Flow Rate				
		Fuel Flow (Inst)				
		Fuel Flow (Avg)				
		Engine Hours				
		Engine Trim				
		Alternator				
Engine Load						

Data Category	Description	Data Item	Data application Graphics			
Fuel**	Types of data related to the fuel system. For example, fuel levels.	Fuel Level (%)				
		Total Fuel (vol)				
		Fuel Flow Total				
		Economy				
		Estimated Fuel Remaining				
		Distance to Empty				
		Time to Empty				
		Fuel Used (Trip)				
		Fuel Used (Season)				
Environment	Environmental-related data. For example, air temperature.	Pressure				
		Air Temperature				
		Minimum Air Temperature				
		Maximum Air Temperature				
		Drift				
		Set				
		Set & Drift				
		Apparent Wind Chill				
		True Wind Chill				
		Humidity				
		Dew Point				
		Sunset / Sunrise				
		Water Temperature				
		Minimum Water Temperature				

Data Category	Description	Data Item	Data application Graphics			
		Maximum Water Temperature				
GPS	GPS-related data. For example, vessel position.	Vessel Position				
		COG & SOG				
		COG				
		SOG				
		Maximum SOG				
		Average SOG				
Heading	Heading-related data. For example, locked heading.	Heading				
		Heading and Speed (Data application only.)				
		Locked Heading				
		Locked Heading Error				
		LH Error and LH (Data application only.)				
		Tack Heading				
		Compass (Data application only.)				
Navigation	Types of data related to navigation. For example, bearing to waypoint.	Cursor Position (Only available in the Databar and data overlay.)				
		Cursor info (Only available in the Databar and data overlay.)				
		Cross Track Error				
		Rolling Road (Data application only.)				
		Waypoint Info				
		Active Waypoint Name				
		Target Position				

Data Category	Description	Data Item	Data application Graphics			
		Bearing to Waypoint				
		BTW & DTW (Data application only.)				
		Course Made Good				
		CMG & DMG				
		CMG & VMG (Data application only.)				
		Distance to Waypoint				
		Distance Made Good				
		Waypoint ETA				
		Waypoint TTG				
		Route ETA				
		Route TTG				
		Pilot	Pilot-related data. For example, rudder.	Rudder Angle		
Speed	Speed-related data. For example, VMG (Velocity Made Good) to Waypoint.	Speed				
		Maximum Speed				
		Average Speed				
		Speed and SOG				
		VMG to Windward				
		VMG to Waypoint				
Tanks**	Data related to water tanks	Fresh Water (%)				
		Grey Water (%)				
		Black Water (%)				
		Live Well (%)				

Data Category	Description	Data Item	Data application Graphics			
Time	Time-related data. For example, local time.	Local Time				
		Local Date				
Wind	Wind-related data. For example, VMG (Velocity Made Good) to Windward.	AWA				
		Maximum AWA				
		Minimum AWA				
		AWS				
		Maximum AWS				
		Minimum AWS				
		TWA				
		Maximum TWA				
		Minimum TWA				
		TWS				
		Maximum TWS				
		Minimum TWS				
		TWD				
		Cardinal Wind				
		Ground Wind				
		Beaufort				
		AWA and TWA				
		AWA & AWS				
		AWA (CH) and AWS				
		AWA and VMG				

Data Category	Description	Data Item	Data application Graphics			
		TWA & TWS				
		TWA (CH) and TWS				
		TWA and VMG				
		GWD and Beaufort				
		GWD & GWS				
None						

Note: *Dials and graphical representations are only available from the Data application. Databar and data cell overlays can only display digital items.

Note: **The Battery, Engine, Fuel and Tanks menus will display 1 set of data items per configured device (e.g. if the system has been configured with 3 engines then 3 sets of engine data items will be displayed).

27.8 System set-up menus

The system set-up menus enable you to configure your display and connected external devices.

The following menus are available:

Menu item	Description	Notes
Touch-Lock	<p>Enables you to lock the touchscreen of a touch only display when the display is paired with a remote keypad.</p> <div style="border: 1px solid black; padding: 2px; margin-bottom: 5px;"> <p>Note: This option is not available on touch-only displays which do not have a remote keypad connected.</p> </div> <div style="border: 1px solid black; padding: 2px;"> <p>Note: This option is not available on displays which have physical buttons.</p> </div>	<ul style="list-style-type: none"> • ON • OFF (default)
Alarms	Enables you to configure all the different types of alarms produced by the display and connected equipment.	
Fuel Manager	Displays the Fuel manager page	
Pilot Controls	Displays the Pilot Control dialog.	Only available when a Raymarine autopilot is detected on the system and Autopilot Control is set to On.
Pilot Response	<p>Enables selection of the pilot response level when connected to an Evolution autopilot.</p> <div style="border: 1px solid black; padding: 2px;"> <p>Note: Pilot Response is not available on SPX and SeaTalk autopilots.</p> </div>	<ul style="list-style-type: none"> • Leisure • Cruise • Performance
Audio Controls	<p>Displays the audio controls pop-up.</p> <div style="border: 1px solid black; padding: 2px;"> <p>Note: Not available on non-touch displays.</p> </div>	Only available when connected to an audio device via bluetooth.
Ground Trip Resets	Resets the chosen ground trip distance counter to zero.	
System Settings	Enables you to configure the settings for external devices connected to the display.	
Maintenance	Provides diagnostic information. Also enables you to designate the data master and reset the display to factory settings.	

Alarms menu

Menu item	Description	Options
MOB Data Type	Determines whether Position or Dead Reckoning (DR) data is displayed. Assuming that your vessel and the MOB are subject to the same tide and wind effects, the Dead Reckoning setting normally gives a more accurate course.	<ul style="list-style-type: none"> • Dead Reckoning • Position (default)
Alarm Clock	When set to On, an alarm is triggered at the time you specify for the Alarm Clock Time setting.	<p>Alarm Clock</p> <ul style="list-style-type: none"> • Off (default) • On <p>Alarm Clock Time</p> <ul style="list-style-type: none"> • 00:00 (default) • 00.01 to 24:00 hrs
Anchor Drift	When set to On, the Anchor Drift alarm is triggered when your vessel drifts from your anchor position by more than the distance you specify for the Anchor Drift Range setting.	<p>Anchor Drift</p> <ul style="list-style-type: none"> • Off (default) • On <p>Anchor Drift Range</p> <ul style="list-style-type: none"> • 0.01 — 9.99 nm (or equivalent units)
Countdown Timer	When set to On, counts down the time period you specify for the Timer Period setting, and triggers an alarm when zero is reached.	<p>Countdown Timer</p> <ul style="list-style-type: none"> • Off (default) • On <p>Timer Period</p> <ul style="list-style-type: none"> • 00h00m (default) • 00h01m to 99h59m
AIS Targets	When set to On, the alarm for Dangerous Targets is enabled. This option is only available when an AIS unit is detected. Refer to the AIS section for details.	<p>Dangerous Targets</p> <ul style="list-style-type: none"> • On (default) • Off
Engine Alarms	When set to On then warning alarms from connected engine management systems will be displayed on the multifunction display.	<p>Engine Alarms</p> <ul style="list-style-type: none"> • On (default) • Off
Fishfinder Deep	<p>If this option is set to On, an alarm is triggered when the depth exceeds the value that you specify. This option is only available when a sonar module is detected.</p> <div style="border: 1px solid black; padding: 5px; margin-top: 10px;"> <p>Note: The Fishfinder Deep alarm limit cannot be set to a value less than the Shallow Limit.</p> </div>	<p>Fishfinder Deep</p> <ul style="list-style-type: none"> • Off (default) • On <p>Deep Limit</p> <ul style="list-style-type: none"> • 2 ft (or equivalent units) to the maximum of the transducer range
Fishfinder Shallow	<p>If this option is set to On, an alarm is triggered when the depth drops below the value that you specify. This option is only available when a sonar module is detected.</p> <div style="border: 1px solid black; padding: 5px; margin-top: 10px;"> <p>Note: The Fishfinder Shallow alarm limit cannot be set to a value greater than the Deep Limit.</p> </div>	<p>Fishfinder Shallow</p> <ul style="list-style-type: none"> • Off (default) • On <p>Shallow Limit</p> <ul style="list-style-type: none"> • 2 ft (or equivalent units) to the maximum of the transducer range
Fish	<p>If the Fish alarm and fish depth limits alarm are set to On, a warning sounds is triggered if any target meets the sensitivity level and is within the Shallow Fish Limit and Deep Fish Limit that you specify. The following items are available in the sub-menu:</p> <ul style="list-style-type: none"> • Fish — Switches fish alarm On and Off. • Fish Sensitivity — If the Fish alarm is set to On, an alarm is triggered when the fish return strength reaches the sensitivity that you specify. • Fish Depth Limits — Switches depth limits On and Off. • Shallow Fish Limit — Specifies the lower value for the Fish Alarm Depth Limit. 	<p>Fish</p> <ul style="list-style-type: none"> • Off (default) • On <p>Fish Sensitivity</p> <ul style="list-style-type: none"> • 1 to 10 <p>Fish Depth Limits</p> <ul style="list-style-type: none"> • On • Off (default) <p>Shallow Fish Limit</p>

Menu item	Description	Options
	<ul style="list-style-type: none"> • Deep Fish Limit — Specifies the upper value for the Fish Alarm Depth Limit. 	<ul style="list-style-type: none"> • 2 ft (or equivalent units) to the maximum of the transducer range <p>Deep Fish Limit</p> <ul style="list-style-type: none"> • 2 ft (or equivalent units) to the maximum of the transducer range
Fuel Manager	In the fuel manager alarm options you can switch the low fuel warning alarm on or off and specify the fuel level at which the alarm is triggered.	<p>Low Fuel</p> <ul style="list-style-type: none"> • On • Off (default) <p>Fuel Level</p> <ul style="list-style-type: none"> • 0 to 99999
Guard Zone	The Guard Zone feature in the radar application triggers an alarm when a target is within a specified zone. You can adjust the sensitivity of the alarm. Ensure that the sensitivity is not set too low, or targets may be missed and the alarm will not be triggered.	<p>Guard Zone Sensitivity</p> <ul style="list-style-type: none"> • 1% to 100%
Off Track	When set to On, during active navigation an alarm is triggered when your vessel steers off-track more than the value you specify for the Off Track XTE setting.	<p>Off Track Alarm</p> <ul style="list-style-type: none"> • Off (default) • On <p>Off Track XTE</p> <ul style="list-style-type: none"> • 0.01 to 9.99 nm (or equivalent units)
Water Temperature	When set to On, triggers an alarm when the water temperature is equal to or lower than the limit you specify for the Lower Temp Limit or equal to or greater than the limit you specify for the Upper Temp Limit setting.	<p>Water Temperature</p> <ul style="list-style-type: none"> • Off (default) • On <p>Lower Temp Limit</p> <ul style="list-style-type: none"> • 60 degrees fahrenheit (or equivalent units) • -09.9 to +99.7 degrees fahrenheit (or equivalent units) <p>Upper Temp Limit</p> <ul style="list-style-type: none"> • 75 degrees fahrenheit (or equivalent units) • -09.7 to 99.9 degrees fahrenheit (or equivalent units)
Waypoint Arrival	When you arrive at a waypoint, an alarm is triggered. This setting allows you to specify the distance from the target waypoint at which the alarm is triggered. The units used for this setting are based on the units you specify for distance in the Units Set-up menu.	0.01 to 9.99 nm (or equivalent units)

Ground trip resets menu

This menu enables you to reset the chosen ground trip distance counter to zero.

Menu item	Description
Ground Trip 1 Reset	Resets the ground trip 1 distance counter to zero.
Ground Trip 2 Reset	Resets the ground trip 2 distance counter to zero.
Ground Trip 3 Reset	Resets the ground trip 3 distance counter to zero.
Ground Trip 4 Reset	Resets the ground trip 4 distance counter to zero.

System settings menu

Menu item	Description	Options
Autopilot Control	Enables and disables autopilot controls from your multifunction display.	<ul style="list-style-type: none"> On Off
DSC Alerts	Enables and disables DSC radio alerts on your multifunction display.	<ul style="list-style-type: none"> On Off
GPS Set-up	Provides GPS setting options.	<ul style="list-style-type: none"> View Satellite Status Differential GPS COG/SOG Filter Restart GPS
Internal GPS	Switches the multifunction displays internal GPS On or Off. Note: The Internal GPS option is not available on the e165 multifunction display.	<ul style="list-style-type: none"> On Off
Data Sources	Enables selection of preferred sources of data for connected equipment. Note: The Data Sources menu is only available on displays set as Data Master.	<ul style="list-style-type: none"> GPS GPS Datum Time and Date Heading Depth Speed Wind
External Devices	Enables set-up of compatible externally connected devices.	Refer to the <i>External devices menu</i> section of the manual.
Wireless Connections	Provides access to the Wi-Fi and bluetooth connection options.	Refer to the <i>Wireless connections menu</i> section of the manual.
NMEA Set-up	Enables you to configure settings for NMEA devices.	Refer to the <i>NMEA set-up menu</i> section of the manual.
System Preferences	Enables you to configure system settings	Refer to the <i>System preferences menu</i> section of the manual.
Simulator	Switches simulator mode On or Off.	<ul style="list-style-type: none"> Off On On (Demo movie)

GPS setup

The GPS setup options enable you to configure a GPS receiver.

The Global Positioning System (GPS) is used to position your vessel on the chart. You can set up your GPS receiver and check its status from the GPS Status option in the **System Settings** menu. For each tracked satellite, the screen provides the following information:

- Satellite number.
- Signal strength bar.
- Status.
- Azimuth angle.
- Elevation angle.
- A sky-view to show the position of tracked satellites.

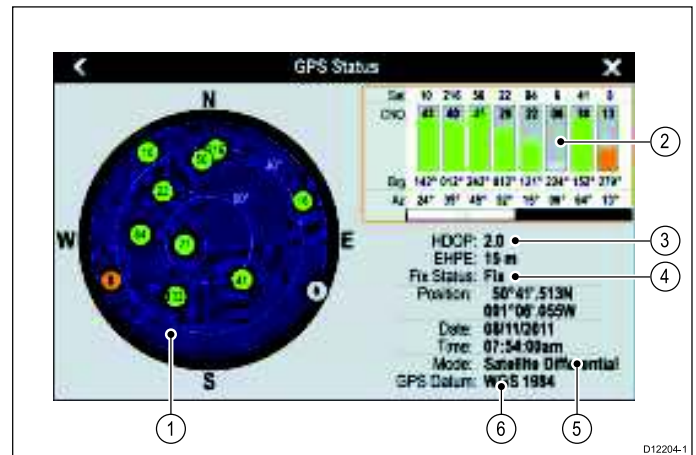

Item	Description
1	Sky view — a visual representation of the position of tracked satellites.
2	Satellite status — displays the signal strength and status of each satellite identified in the sky view diagram on the left of the screen. The colored bars have the following meanings: <ul style="list-style-type: none"> Grey = searching for satellite. Green = satellite in use. Orange = tracking satellite.
3	Horizontal Dilution of Position (HDOP) — a measure of GPS accuracy, calculated from a number of factors including satellite geometry, system errors in the data transmission and system errors in the GPS receiver. A higher figure signifies a greater positional error. A typical GPS receiver has an accuracy of between 5 and 15 m. As an example, assuming a GPS receiver error of 5 m, an HDOP of 2 would represent an error of approximately 15 m. Please remember that even a very low HDOP figure is NO guarantee that your GPS receiver is providing an accurate position. If in doubt, check the displayed vessel position in the chart application against your actual proximity to a known charted object. Estimated Horizontal Position Error (EHPE) — a measure of GPS accuracy, this indicates that your position is within a circle radius of the stated size 67% of the time.
4	Fix status — indicates the actual mode the GPS receiver is reporting (No Fix, Fix, D Fix or SD Fix).
5	Mode — the mode currently selected by the GPS receiver.
6	Datum — The GPS receiver's datum setting affects the accuracy of the vessel position information displayed in the chart application. In order for your GPS receiver and multifunction display to correlate accurately with your paper charts, they must be using the same datum.

The accuracy of the GPS receiver depends on the parameters detailed above, especially the azimuth and elevation angles which are used in triangulation to calculate your position.

Multiple data sources (MDS) overview

Installations that include multiple instances of data sources can cause data conflicts. An example is an installation featuring more than one source of GPS data.

MDS enables you to manage conflicts involving the following types of data:

- GPS Position.
- Heading.
- Depth.
- Speed.
- Wind.

Typically this exercise is completed as part of the initial installation, or when new equipment is added.

If this exercise is NOT completed the system will automatically attempt to resolve data conflicts. However, this may result in the system choosing a source of data that you do not want to use.

If MDS is available the system can list the available data sources and allow you to select your preferred data source. For MDS to be available all products in the system that use the data sources listed above must be MDS-compliant. The system can list any products that are NOT compliant. It may be necessary to upgrade the software for these non-compliant products to make them compliant. Visit the Raymarine website (www.raymarine.com) to obtain the latest software for your products. If MDS-compliant software is not available and you do NOT want the system to automatically attempt to resolve data conflicts, any non-compliant product(s) can be removed or replaced to ensure the entire system is MDS-compliant.

Data sources menu

This menu enables you to select the external sensors and devices that will provide data to the display.

Auto / manual selection

Each dialog enables you to view and select your preferred data source. selection of data source can be manual or set to automatic:

- **Auto** — the display will automatically select a device and attempt to resolve any data conflicts that may occur where there is more than one source of data for that particular data source (for example, multiple GPS receivers).
- **Manual** — once the display has performed a search for connected devices you can manually select the preferred device from the list.

Note: Selecting the **Auto** option may result in the system choosing a source of data that you do not want to use.

Device selection

Menu item	Description
GPS	Enables you to search for any externally-connected GPS devices, and select the one you want to use.
GPS Datum	In order for your GPS receiver and multifunction display to correlate accurately with your paper charts, they must be using the same datum. This option enables you to choose the data source for this datum.
Time and Date	Enables you to select the device you want to use for the time and date information used by the display.
Heading	Enables you to select the device you want to use for heading data.
Depth	Enables you to select the device you want to use for depth data.
Speed	Enables you to select the device you want to use for speed data.
Wind	Enables you to select the device you want to use for wind data.

External devices menu

This menu enables you to configure the external devices connected to the display.

Menu item	Description	Notes
Pilot Set-up	When connected to an Evolution autopilot this option allows you to enable and disable pilot control and the pilot bar. You can also access certain pilot settings and modes.	
Fishfinder Set-up	Enables you to select an external transducer and configure the options for the unit, such as depth offset. Also enables you to configure the options for an internal or external sonar module.	For an explanation of these options refer to the <i>Transducer set-up menu options</i> described in the Fishfinder section of this document.
Radar Set-up	Enables you to make radar scanner adjustments, such as tune adjust and time transmit.	For an explanation of these options refer to the <i>Radar set-up menu options</i> described in the Radar section of this document.
AIS Unit Set-up	Enables you to configure additional functions for AIS units, such as Silent Mode. This menu item is only available when an AIS unit is detected or when Simulator mode is On.	For an explanation of these options refer to the <i>AIS menu options</i> described in the AIS section of this document.
Remote Control	Enables you to customize certain controls for Raymarine Bluetooth remote control units (for example, RCU-3).	For an explanation of these options refer to the <i>Remote Control</i> section of this document.
Transducers Set-up	Displays a list of connected transducers which you can select and calibrate.	
Weather Set-up	Enables you to select the bus your weather receiver is connected to: <ul style="list-style-type: none"> • SeaTalk^{hs} • SeaTalk^{ng} 	
Switch Panel Set-up	Enables you to install and uninstall Switch Panel configuration files.	
External Keypad	Enables you to pair and unpair remote keypads.	
Engines Set-up	Enables you to run the engine identification wizard	For an explanation of these options refer to <i>Engine identification wizard</i> section of this document.

Connections menu

This menu enables you to connect wireless Bluetooth and Wi-Fi devices to the display.

Menu item	Description	Options
Bluetooth	Enable or disable Bluetooth on the display.	<ul style="list-style-type: none"> • On • Off (default)
Wi-Fi	Enable or disable Wi-Fi on the display.	<ul style="list-style-type: none"> • On • Off (default)
Connection Manager	<p>Provides a list of Bluetooth devices in range. When you highlight a connection in the list and press OK, the following options are available:</p> <ul style="list-style-type: none"> • Unpair / Forget this device — Disconnect the device and remove it from the connection list. If you unpair a device in this way you must re-pair the device if you want to connection it again to the multifunction display. • Audio Control — If this option is set to On, you can control the audio for a compatible wireless media player, from the multifunction display. 	<ul style="list-style-type: none"> • Unpair / Forget this device • Audio control On / Off.
New Bluetooth Connection	Selecting this menu item initiates the Bluetooth pairing process. This is necessary for connecting a wireless remote control unit or media player device to the multifunction display.	
Wi-Fi Name	Enables you to specify an SSID (WiFi Name) for connecting WiFi devices using an encrypted connection. If you want to prevent unauthorized devices from connecting to your display you must specify the same SSID for both the multifunction display and the wireless device you want to connect to the display.	
Wi-Fi Security	You can encrypt the WiFi connection on the multifunction display to prevent unauthorized devices from accessing the connection. This menu item enables you to select the type of WPA (WiFi Protected Access) encryption you want to use. WPA2 provides stronger security than WPA.	<ul style="list-style-type: none"> • None • WPA Only • WPA 2 Only. (default) • WPA / WPA2.
Wi-Fi Passphrase	Enables you to specify a password for the WiFi connection. If you want to prevent unauthorized devices from connecting to your display you must specify the same password for both the multifunction display and the wireless device you want to connect to the display.	
Wi-Fi Channel	By default the multifunction display automatically selects an available WiFi channel. If you're experiencing difficulties with wireless video streaming it may be necessary to manually specify a WiFi channel for both the multifunction display and the device you want to stream video to.	<ul style="list-style-type: none"> • 1 (default) • 2 • 3 • 4 • 5 • 6 • 7 • 8 • 9 • 10 • 11
Mobile apps	<p>Enables you to select the type of mobile app in use:</p> <ul style="list-style-type: none"> • Viewing only — RayView • Remote Control — RayRemote or RayControl 	<ul style="list-style-type: none"> • Off (default) • Viewing only • Remote Control

NMEA Set-up menu

This menu enables you to configure settings for NMEA devices.

Menu item	Description	Options
Bridge NMEA Heading	If set to ON, NMEA heading data will be bridged onto the SeaTalk data bus, and will be sent to all NMEA-connected devices. If set to OFF, NMEA heading data will NOT be bridged onto the SeaTalk bus. An example of a use for this setting is when using MARPA with an external fast heading sensor, in which case you should set this option to OFF to ensure that all NMEA-connected units receive heading data from the external heading sensor.	<ul style="list-style-type: none"> • On • Off (default)
NMEA Output Settings	Allows you to enable or disable the individual NMEA "sentences" that are sent by the multifunction display to any devices connected the NMEA output port.	<ul style="list-style-type: none"> • APB • BWC • BWR • DBT • DPT • GGA • GLL • GSA • GSV • MTW • MWV • RMA • RMB • RMC • RSD • RTE • TTM • VHW • VLW • VTG • WPL • ZDA
NMEA Input Port 1	Enables you to specify the appropriate port speed for the equipment connected to NMEA Input port 1. Use the AIS 38400 option for AIS receivers.	<ul style="list-style-type: none"> • NMEA 4800 • AIS 38400
NMEA Input Port 2	Enables you to specify the appropriate port speed for the equipment connected to NMEA Input port 2. Use the AIS 38400 option for AIS receivers.	<ul style="list-style-type: none"> • NMEA 4800 • AIS 38400

System preferences menu

Menu item	Description	Options
Bearing mode	Determines how all bearing and heading data is displayed in. This does not affect how the chart or radar displays are drawn.	<ul style="list-style-type: none"> • True (default) • Magnetic
Variation Source	This setting compensates for the naturally occurring offset of the earth's magnetic field. When set to Auto, the system automatically compensates, and displays the compensation value in brackets. To enter your own compensation value, use the Manual option, then specify the value using the Manual Variation setting (see below). This value is also transmitted to any other connected Raymarine instruments.	<ul style="list-style-type: none"> • Auto (compensation value displayed) (default) • Manual
Manual Variation	When the Variation Source menu item is set to Manual (see above), you use the Manual Variation setting to specify the compensation value that you want to use.	<ul style="list-style-type: none"> • Range: 0 to 30 degrees, East or West •
System Datum	<p>In order for your GPS receiver and multifunction display to correlate accurately with your paper charts, they must be using the same datum.</p> <p>The default datum for your multifunction display is WGS1984. If this is not the datum used by your paper charts, you can change the datum used by your multifunction display.</p> <p>When you change the datum for your multifunction display, the chart grid will subsequently move according to the new datum, and the latitude / longitude of the cartographic features will also change accordingly. Your multifunction display will attempt to set up any GPS receiver to the new datum, as follows:</p> <ul style="list-style-type: none"> • The internal GPS receiver will automatically correlate each time you change the datum. • If you have a Raymarine GPS receiver using SeaTalk or SeaTalk^{ng}, it will automatically correlate each time you change the datum on the multifunction display. • If you have a Raymarine GPS receiver using NMEA 0183, or a third-party GPS receiver, you must correlate it separately. <p>It may be possible to use your multifunction display to correlate an NMEA 0183 GPS receiver. From the homescreen go to Set-up > System settings > GPS Set-up > View Satellite Status. If the datum version is displayed, it may be possible to change it. From the homescreen go to Set-up > System settings > Data Sources > GPS Datum.</p> <div style="border: 1px solid black; padding: 5px;"> <p>Note: Raymarine recommends that you check the displayed vessel position in the chart application against your actual proximity to a known charted object. A typical GPS has an accuracy of between 5 and 15 m.</p> </div>	

Maintenance menu

This menu provides access to systems settings reset and diagnostics.

Menu item	Description	Options
Touchscreen Alignment	<p>If the touchscreen is misaligned to your touch, you can realign it to improve the accuracy. Realignment involves a simple exercise to align an on-screen object with your touch. For best results, perform this exercise when your vessel is anchored or moored.</p> <div style="border: 1px solid black; padding: 5px; margin-top: 10px;"> <p>Note: The Touchscreen alignment option is not required on New c Series displays.</p> </div>	
Data Master	<p>Any system containing more than one networked multifunction display must have a designated data master. The data master is the display which serves as a primary source of data for all displays, it also handles all external sources of information.</p>	
System Settings Reset	<p>This option resets your menu options, datapages, and databar settings to factory default. It will NOT affect your waypoints, routes, or tracks data.</p>	<ul style="list-style-type: none"> • Yes • No
System Settings and Data Reset	<p>In addition to the settings reset detailed above, performing a settings and data reset will also remove ALL waypoints, routes, and tracks data.</p>	<ul style="list-style-type: none"> • Yes • No
Diagnostics	<p>Diagnostics provides detailed information on the multifunction display and connected devices. The range of information available includes product serial number, software version, and network status. When you select the Diagnostics menu item the multifunction display scans for any connected equipment and enables you to select the product you want to view. You can also save the diagnostics information to a memory card. This is particularly useful for sending detailed information to Raymarine Customer Support in the event of a technical issue.</p> <p>The Interfaces option allows you to view statistics and buffer information for NMEA 0183 ports 1 and 2 and SeaTalk^{ng}.</p> <p>The Sirius options allows you to view received messages, memory and errors.</p>	<ul style="list-style-type: none"> • Select Device • Sirius • Save Logs • Erase Logs • Interfaces

Diagnostics menu

If you encounter problems with your multifunction display or peripheral devices you can use the Diagnostics menu to view information about your device and connected equipment.

Select Device	Enables you to view a list of all devices connected to the SeaTalk ^{hs} network. You can also select an item in the list to view further details for that device.	<ul style="list-style-type: none"> • Device • Serial No. • Network • Software
Sirius	If connected to a Sirius weather receiver this option enables you to view Sirius weather statistics.	
Save Logs	Allows you to save error logs to a MicroSD card for troubleshooting purposes.	
Erase Logs	Selecting this option will erase any crash logs on the device.	
Interfaces	Enables viewing of statistics and viewing and recording of buffers on NMEA inputs and the SeaTalk ^{ng} bus. On multifunction displays with multiple MicroSD card slots you can also choose which MicroSD card slot the buffer will be recorded to.	<ul style="list-style-type: none"> • NMEA 1 • NMEA 2 • SeaTalk^{ng} • Record File

Chapter 28: Maintaining your display

Chapter contents

- [28.1 Service and maintenance on page 332](#)
- [28.2 Cleaning on page 332](#)

28.1 Service and maintenance

This product contains no user serviceable components. Please refer all maintenance and repair to authorized Raymarine dealers. Unauthorized repair may affect your warranty.

Routine equipment checks

Raymarine strongly recommends that you complete a number of routine checks to ensure the correct and reliable operation of your equipment.

Complete the following checks on a regular basis:

- Examine all cables for signs of damage or wear and tear.
- Check that all cables are securely connected.

28.2 Cleaning

Best cleaning practices.

When cleaning this product:

- Do NOT wipe the display screen with a dry cloth, as this could scratch the screen coating.
- Do NOT use abrasive, or acid or ammonia based products.
- Do NOT use a jet wash.

Cleaning the display case

The display unit is a sealed unit and does not require regular cleaning. If it is necessary to clean the unit, follow this basic procedure:

1. Switch off the power to the display.
2. Wipe the display with a clean, soft cloth (a microfibre cloth is ideal).
3. If necessary, use a mild detergent to remove grease marks.

Note: Do NOT use solvents or detergents on the screen itself.

Note: In certain conditions, condensation may appear inside the display screen. This will not harm the unit, and can be cleared by powering on the display for a short time.

Cleaning the display screen

A coating is applied to the display screen. This makes it water repellent, and prevents glare. To avoid damaging this coating, follow this procedure:

1. Switch off the power to the display.
2. Rinse the screen with fresh water to remove all dirt particles and salt deposits.
3. Allow the screen to dry naturally.
4. If any smears remain, very gently wipe the screen with a clean microfibre cleaning cloth (available from an opticians).

Cleaning the sun cover

The supplied sun cover features an adhesive surface. In certain conditions unwanted contaminants may stick to this surface. To avoid damaging the monitor display, clean the sun cover regularly following this procedure:

1. Carefully remove the sun cover from the display.
2. Rinse the sun cover with fresh water to remove all dirt particles and salt deposits.
3. Allow the sun cover to dry naturally.

Chapter 29: Troubleshooting

Chapter contents

- [29.1 Troubleshooting on page 334](#)
- [29.2 Power up troubleshooting on page 335](#)
- [29.3 Radar troubleshooting on page 336](#)
- [29.4 GPS troubleshooting on page 337](#)
- [29.5 Sonar troubleshooting on page 338](#)
- [29.6 Thermal camera troubleshooting on page 339](#)
- [29.7 System data troubleshooting on page 340](#)
- [29.8 Video troubleshooting on page 341](#)
- [29.9 Wi-Fi troubleshooting on page 342](#)
- [29.10 Bluetooth troubleshooting on page 343](#)
- [29.11 Touchscreen troubleshooting on page 344](#)
- [29.12 Miscellaneous troubleshooting on page 345](#)

29.1 Troubleshooting

The troubleshooting information provides possible causes and corrective action required for common problems associated with marine electronics installations.

All Raymarine products are, prior to packing and shipping, subjected to comprehensive test and quality assurance programs. However, if you experience problems with the operation of your product this section will help you to diagnose and correct problems in order to restore normal operation.

If after referring to this section you are still having problems with your unit, please contact Raymarine Technical Support for further advice.

29.2 Power up troubleshooting

Problems at power up and their possible causes and solutions are described here.

Problem	Possible causes	Possible solutions
The system (or part of it) does not start up.	Power supply problem.	Check relevant fuses and breakers.
		Check that the power supply cable is sound and that all connections are tight and free from corrosion.
		Check that the power source is of the correct voltage and sufficient current.

29.3 Radar troubleshooting

Problems with the radar and their possible causes and solutions are described here.

Problem	Possible causes	Possible solutions
No Data or No scanner message	Radar scanner power supply	Check that the scanner power supply cable is sound and that all connections are tight and free from corrosion.
		Check relevant fuses and breakers.
		Check power source is of the correct voltage and sufficient current (using voltage booster if appropriate).
	SeaTalk ^{hs} / RayNet network problem	Check that the Scanner is correctly connected to a Raymarine network switch or SeaTalk ^{hs} crossover coupler (as applicable).
		Check the status of the Raymarine network switch.
		Check that SeaTalk ^{hs} / RayNet cables are free from damage.
Software mismatch between equipment may prevent communication.	Contact Raymarine technical support.	
Switch at scanner pedestal in OFF position	Ensure scanner pedestal switch is in ON position.	
Radar will not initialize (Voltage control module (VCM) stuck in "sleep mode")	Intermittent or poor power connection	Check power connection at VCM. (Voltage at input = 12 / 24 V, Voltage at output = 40 V)
The bearing of a target on the radar screen is incorrect.	The radar bearing alignment requires correcting.	Check and adjust radar bearing alignment.

29.4 GPS troubleshooting

Problems with the GPS and their possible causes and solutions are described here.

Problem	Possible causes	Possible solutions
"No Fix" GPS status icon is displayed.	Geographic location or prevailing conditions preventing satellite fix.	Check periodically to see if a fix is obtained in better conditions or another geographic location.
	GPS connection fault.	Ensure that external GPS connections and cabling are correct and fault free.
	External GPS antenna in poor position. For example: <ul style="list-style-type: none">• Below decks.• Close proximity to transmitting equipment such as VHF radio.	Ensure GPS antenna has a clear view of the sky.
	GPS installation problem.	Refer to the installation instructions.

Note: A GPS Status screen is available within the display. This provides satellite signal strength and other relevant information.

29.5 Sonar troubleshooting

Problems with the sonar and their possible causes and solutions are described here.

Problem	Possible causes	Possible solutions
Sonar data not available on multifunction display.	Unit power supply fault.	Check the unit power supply and cables.
	Other unit fault.	Refer to the instructions supplied with the unit.
	SeaTalk ^{hs} / RayNet network problem.	Check that the unit is correctly connected to a Raymarine network SeaTalk ^{hs} switch or crossover coupler (as applicable).
		Check the status of the Raymarine network switch (if applicable).
		Check that SeaTalk ^{hs} / RayNet cables are free from damage.
Software mismatch between equipment may prevent communication.	Contact Raymarine technical support.	
Problematic depth readings or sonar image.	Gain or Frequency settings may be inappropriate for present conditions.	Check the sonar presets, gain and frequency settings.
	Unit power supply fault	Check the voltage from the power supply, if this is too low it can affect the transmitting power of the unit.
	Unit cable fault.	Ensure that the power, transducer and all other cables to the unit are properly connected and free from damage.
	Transducer fault	Check that the transducer is mounted correctly and is clean.
		If you have a transom-mount transducer, check that the transducer hasn't kicked up due to hitting an object.
	Other unit fault.	Refer to the instructions supplied with the unit.
	Vessel stationary	Fish arches are not displayed if the vessel is stationary, fish will appear on the display as straight lines.
	High vessel speed	Turbulence around the transducer may be confusing the unit.
	Scroll speed set to zero	Adjust scroll speed
Incorrect speed reading	Paddle wheel fault	Check that the paddle wheel is clean.
	No speed offset set	Add speed offset.
	Incorrect calibration	Re-calibrate equipment

29.6 Thermal camera troubleshooting

Problems with the thermal camera and their possible causes and solutions are described here.

Problem	Possible causes	Possible solutions
Video not displayed.	Camera is in Standby mode.	The camera will not display video if it is in Standby mode. Use the camera controls (either the thermal camera application or JCU) to “wake” the camera from standby.
	Problem with the thermal camera video connections.	<ul style="list-style-type: none"> • Check thermal camera video cables are sound and properly connected. • Ensure that the video is connected into video input 1 at the multifunction display or GVM. • Ensure that the correct video input is selected at the display.
	Problem with power supply to the camera or JCU (if used as the primary controller)	<ul style="list-style-type: none"> • Check the power connections to the camera and JCU / PoE injector (if used). • Ensure that the power switch / breaker is on. • Check the fuse / breaker state.
Cannot control thermal camera from Raymarine display or keyboard.	Thermal camera application is not running.	Ensure the thermal camera application is running on the multifunction display (as oppose to the video application which does not have camera controls).
Erratic or unresponsive controls.	Network problem.	Check that the controller and thermal camera are correctly connected to the network. (Note: This may be a direct connection or via a Raymarine network switch.)
		Check the status of the Raymarine network switch.
		Check that SeaTalk ^{hs} / RayNet cables are free from damage.
	Control conflict, e.g. caused by multiple users at different stations.	Ensure that no other controllers are in use at the same time.
Problem with the controller.	Check power / network cabling to the controller and PoE injector (PoE only used with optional Joystick Control Unit).	
	Check other controllers if available. If other controllers are operating this will eliminate the possibility of a more fundamental camera fault.	
Cannot switch between thermal and visible (VIS / IR) video image .	Camera is not a dual payload model.	Only “dual payload” (dual lens) thermal cameras support VIS / IR switching.
	VIS / IR cable not connected.	Ensure that the VIS / IR cable is connected from the camera to the Raymarine system. (The IR-only cable does not support switching).
Noisy image.	Poor quality or faulty video cable.	Ensure that the video cable is no longer than necessary. The longer the cable is (or the smaller the wire gauge / thickness), the more severe the losses become. Use only high quality shielded cable suitable for a marine environment.
	Cable is picking up electromagnetic interference (EMI) from another device.	<ul style="list-style-type: none"> • Ensure you are using a high quality shielded cable. • Ensure proper cable separation, for example do not run data and power cables in close proximity with each other.
Image too dark or too light.	Display brightness is set too low.	Use the brightness controls at the display to adjust accordingly.
	The contrast or brightness settings in the thermal camera application are set too low.	Use the appropriate menu in the thermal camera application to adjust the contrast and brightness of the image.
	The Scene Mode is not appropriate for the current conditions.	A particular environment may benefit from a different Scene Mode setting. For example, a very cold background (such as the sky) could cause the camera to use a wider temperature range than appropriate. Use the SCENE button.
Image freezes momentarily.	FFC (Flat Field Correction).	The image will pause momentarily on a periodic basis during the Flat Field Correction (FFC) cycle. Just prior to the FFC, a small green square will appear in the upper left corner of the screen.
Image is inverted (upside down).	Camera “Ball down” setting is incorrect.	Ensure that the Ball down setting within the thermal camera system setup menu is set correctly.

29.7 System data troubleshooting

Aspects of the installation can cause problems with the data shared between connected equipment. Such problems, their possible causes and solutions are described here.

Problem	Possible causes	Possible solutions
Instrument, engine or other system data is unavailable at all displays.	Data is not being received at the display.	Check the data bus (e.g. SeaTalk ^{ng}) wiring and connections.
		Check the overall integrity of the data bus (e.g. SeaTalk ^{ng}) wiring.
		If available refer to the reference guide for the data bus (e.g. SeaTalk ^{ng} reference manual).
	Data source (e.g. ST70 instrument or engine interface) is not operating.	Check the source of the missing data (e.g. ST70 instrument or engine interface).
		Check the power to the SeaTalk bus.
		Refer to the manufacturer's handbook for the equipment in question.
Software mismatch between equipment may prevent communication.	Contact Raymarine technical support.	
Instrument or other system data is missing from some but not all displays.	Network problem.	Check that all required equipment is connected to the network.
		Check the status of the Raymarine network Switch.
		Check that SeaTalk ^{hs} / RayNet cables are free from damage.
	Software mismatch between equipment may prevent communication.	Contact Raymarine technical support.

29.8 Video troubleshooting

Problems with the video inputs and their possible causes and solutions are described here.

Problem	Possible causes	Possible solutions
No signal message on screen (video image not displayed)	Cable or connection fault	Check that the connections are sound and free from corrosion.

29.9 Wi-Fi troubleshooting

Aspects of the installation can cause problems with the data shared between wireless devices. Such problems, their possible causes and solutions are described here.

Problem	Possible causes	Possible solutions
No wireless connection.	Tablet / smartphone does not have a wireless connection established with the multifunction display.	Ensure that Wi-Fi is enabled on the multifunction display (Homescreen: > Set-Up > System Settings > Wireless Connections > Wi-Fi > On).
		Ensure that the "Wi-Fi" option is enabled on the iPhone (available from the phone's Settings menu).
		Ensure that the Raymarine connection is selected as the Wi-Fi network. If a passcode has been specified for the multifunction display's Wi-Fi connection ensure that the same passcode is entered into the iPhone when prompted.
No Raymarine app on device.	Tablet / smartphone does not have Raymarine app installed and running.	Download the required Raymarine app from the relevant application store.
		Start the Raymarine app on your device.
	Mobile applications are NOT enabled on the multifunction display.	Enable "Viewing only" or "Remote Control" (Homescreen: > Set-Up > System Settings > Wireless Connections > Mobile Apps).
Raymarine app runs slowly or not at all.	Device not compatible with Raymarine app.	Recommended device requirements: <ul style="list-style-type: none"> • iOS Devices = Best performance achieved on iPhone 4 or later and iPad 2 or later. • Android/Kindle Fire = Best performance achieved with 1GHz processor and better and running 2.2.2. or later.
	MFD software incompatible with mobile application.	Ensure your MFD contains software application version 3.15 or later.
No waypoint / routes synchronization with Navionics Marine app.	Smartphone / tablet does not have "Navionics Marine" app installed and running.	Download the "Navionics Marine" app from the relevant app store.
	Chart application is not running on the multifunction display.	Start the "Navionics Marine" app on the device.
	Chart application is not running on the multifunction display.	Start the chart application on the multifunction display.
Weak or intermittent Wi-Fi signal.	Interference from other wireless devices in the vicinity.	Multiple wireless devices running simultaneously (such as laptops, phones, and other wireless devices) can sometimes cause wireless signal conflicts. Temporarily disable each wireless device in turn until you have identified the device causing the interference.
Smartphone / tablet can no longer connect to the internet or receive e-mails after using a Raymarine mobile app.	Device still connected to the multifunction display.	Ensure the access point on your device is switched back to your previous access point (e.g. the marina Wi-Fi).

29.10 Bluetooth troubleshooting

Aspects of the installation can cause problems with the data shared between wireless devices. Such problems, their possible causes and solutions are described here.

Problem	Possible causes	Possible solutions
No wireless connection.	iPhone does not have a Bluetooth connection established with the multifunction display.	Ensure that Bluetooth is enabled on the multifunction display (Homescreen: > Set-Up > System Settings > Connections > Bluetooth > On).
		Ensure that the "Bluetooth" option is enabled on the iPhone (available from the phone's Settings / General menu).
		Ensure that the Bluetooth device is paired with the multifunction display that you want to use it with. To do this: Homescreen: > Set-Up > System Settings > Connections > New Bluetooth Connection .
No media player control.	Media player device is not compatible with the Bluetooth 2.1+ EDR power class 1.5 (supported profile: AVRCP 1.0) or higher.	Check the Bluetooth compatibility with the device manufacturer. If the device is not Bluetooth 2.1+ EDR power class 1.5 (supported profile: AVRCP 1.0) compatible then it is not suitable for wireless use with the multifunction display.
	"Audio Control" is NOT enabled on the multifunction display.	Enable "Audio Control" (Homescreen: > Set-Up > System Settings > Connections > Connections Manager > Audio Control > On).
Weak or intermittent Bluetooth signal.	Interference from other wireless devices in the vicinity.	Multiple wireless devices running simultaneously (such as laptops, phones, and other wireless devices) can sometimes cause wireless signal conflicts. Temporarily disable each wireless device in turn until you have identified the device causing the interference.

29.11 Touchscreen troubleshooting

Problems with the touchscreen and their possible causes and solutions are described here.

Problem	Possible causes	Possible solutions
Touchscreen does not operate as expected.	Touch lock is enabled.	Use the Joystick to turn off the touch lock on the home screen.
	Screen is not being operated with bare fingers, for example gloves are being worn.	Bare fingers must make contact with the screen for correct operation. Alternatively you may use conductive gloves.
	Touchscreen requires calibration.	Use the setup menus to calibrate the touchscreen.
	Saltwater deposits on the screen.	Carefully clean and dry the screen in accordance with the instructions provided.

29.12 Miscellaneous troubleshooting

Miscellaneous problems and their possible causes and solutions are described here.

Problem	Possible causes	Possible solutions
Display behaves erratically: <ul style="list-style-type: none"> • Frequent unexpected resets. • System crashes or other erratic behavior. 	Intermittent problem with power to the display.	Check relevant fuses and breakers.
		Check that the power supply cable is sound and that all connections are tight and free from corrosion.
		Check that the power source is of the correct voltage and sufficient current.
	Software mismatch on system (upgrade required).	Go to www.raymarine.com and click on support for the latest software downloads.
	Corrupt data / other unknown issue.	Perform a factory reset. <div style="border: 1px solid black; padding: 5px; margin-top: 5px;"> <p>Important: This will result in the loss of any settings and data (such as waypoints) stored on the product. Save any important data to a memory card before resetting.</p> </div>

Chapter 30: Technical support

Chapter contents

- [30.1 Raymarine customer support on page 348](#)
- [30.2 Third-party support on page 348](#)

30.1 Raymarine customer support

Raymarine provides a comprehensive customer support service. You can contact customer support through the Raymarine website, telephone and e-mail. If you are unable to resolve a problem, please use any of these facilities to obtain additional help.

Web support

Please visit the customer support area of our website at:

www.raymarine.com

This contains Frequently Asked Questions, servicing information, e-mail access to the Raymarine Technical Support Department and details of worldwide Raymarine agents.

Telephone and e-mail support

In the USA:

- **Tel:** +1 603 324 7900
- **Toll Free:** +1 800 539 5539
- **E-mail:** support@raymarine.com

In the UK, Europe, and the Middle East:

- **Tel:** +44 (0)13 2924 6777
- **E-mail:** ukproduct.support@raymarine.com

In Southeast Asia and Australia:

- **Tel:** +61 (0)29479 4800
- **E-mail:** aus.support@raymarine.com

Product information

If you need to request service, please have the following information to hand:

- Product name.
- Product identity.
- Serial number.
- Software application version.
- System diagrams.

You can obtain this product information using the menus within your product.

Viewing product information

With the homescreen displayed:

1. Select **Set-up**.
2. Select **Maintenance**.
3. Select **Diagnostics**.
4. Select **Select Device**.
5. Select the relevant product from the list.
6. Select **Show All Data**.

30.2 Third-party support

Contact and support details for third-party suppliers can be found on the appropriate websites.

Fusion

www.fusionelectronics.com

Navionics

www.navionics.com

Sirius

www.sirius.com

Chapter 31: Technical specification

Chapter contents

- [31.1 Technical specification on page 350](#)

31.1 Technical specification

Physical specifications

	gS95	gS125	gS165
Dimensions	<ul style="list-style-type: none"> Width: 246.8 mm (9.7 in.) Height: 188.2 mm (7.4 in.) Depth (NOT including cables): 77 mm (3 in.) Depth (including cables): 168 mm (6.6 in.) 	<ul style="list-style-type: none"> Width: 311.8 mm (12.3 in.) Height: 237.1 mm (9.3 in.) Depth (NOT including cables): 78 mm (3 in.) Depth (including cables): 169 mm (6.7 in.) 	<ul style="list-style-type: none"> Width: 383.2 mm (15 in.) Height: 284.7 mm (11.2 in.) Depth (NOT including cables): 77 mm (3 in.) Depth (including cables): 168 mm (6.6 in.)
Weight (bare unit)	3 Kg (6.63 lbs)	3.9 Kg (8.6 lbs)	5.2 Kg (11.5 lbs)

Power specification

Nominal supply voltage	12 V dc to 24 V dc
Operating voltage range	10.8 V dc to 31.2 V dc
Fuse / Breakers	In-line fuse (fitted within power cable) <ul style="list-style-type: none"> 15 A. (Standard 20 mm glass fuse)
Power consumption (without PoE)	gS95 <ul style="list-style-type: none"> Full brightness: 20 W Max PowerSave mode: 5 W Max gS125 <ul style="list-style-type: none"> Full brightness: 30 W Max PowerSave mode: 5 W Max gS165 <ul style="list-style-type: none"> Full brightness: 60 W Max PowerSave mode: 5 W Max
Power consumption (with PoE)	gS95 <ul style="list-style-type: none"> Full brightness: 54 W Max PowerSave mode: 40 W Max gS125 <ul style="list-style-type: none"> Full brightness: 65 W Max PowerSave mode: 40 W Max gS165 <ul style="list-style-type: none"> Full brightness: 96 W Max PowerSave mode: 40 W Max <div style="border: 1px solid black; padding: 5px; margin-top: 10px;"> Note: Figures with PoE represent a full load of 20 W PoE) </div>
LEN (Refer to Seataalk^{®9} reference manual for further information).	1

Environmental specification

Environmental specifications below apply to all display variants

Operating temperature	-25 °C to +55 °C (-13 °F to 131 °F)
Storage temperature	-30 °C to +70 °C (-22 °F to 158 °F)

Relative humidity	Maximum 75%
Waterproof rating	IPX6

Display specification

	gS95	gS125	gS165
Size	9 in.	12.1 in.	15.4 in.
Type	TFT backlit LED	TFT backlit LED	TFT backlit LED
Color depth	24-bit	24-bit	24-bit
Resolution	800 x 480 pixels (WVGA)	1280 x 800 pixels (WVGA)	1280 x 800 pixels (WVGA)
Aspect Ratio	16:9	16:9	16:9
Maximum allowable wrongly illuminated pixels	8	8	8

Data connections

Wired connections

NMEA 0183	2x NMEA 0183 ports: <ul style="list-style-type: none"> NMEA port 1: Input and output, 4800 / 38400 baud NMEA port 2: Input only, 4800 / 38400 baud
Network (SeaTalk^{h5})	3 x SeaTalk ^{h5} port. 10 / 100 / 1000 Mbits/s. RayNet type connection.
SeaTalk^{®9}	1 x SeaTalk ^{®9} connection.
Remote Card Reader	1 x Remote Card Reader connection.
Alarm	1 x Alarm output.

Wireless connections

Wi-Fi	802.11 b / g
Bluetooth	AVRCP 2.1+ EDR power class 1.5

Video specification

Format	PAL or NTSC
Connector type	<ul style="list-style-type: none"> 1 x HDMI output. 2 x composite video inputs.
Output resolution	720p (fixed)

Electronic chart specification

Embedded electronic charts	<ul style="list-style-type: none"> LightHouse Charts world base map. Navionics world base map.
Compatible LightHouse charts	<ul style="list-style-type: none"> Vector — LightHouse charts Raster — LightHouse charts
Compatible Navionics chart cards	<ul style="list-style-type: none"> Navionics Ready to Navigate Navionics Silver Navionics Gold Navionics Gold+ Navionics Platinum Navionics Platinum+ Navionics Fish'N Chip Navionics Hotmaps

Note:

Refer to the Raymarine website (www.raymarine.com) for the latest list of supported charts.

Conformance specification

Conformance certification applies to all display variants

Conformance	<ul style="list-style-type: none">• NMEA 2000 certification• WiFi Alliance certification• Bluetooth certification• Europe: 1999/5/EC• Australia and New Zealand: C-Tick, Compliance Level 2• FCC 47CFR part 15• Industry Canada RSS210
--------------------	--

Chapter 32: Spares and accessories

Chapter contents

- [32.1 gS Series accessories on page 354](#)
- [32.2 gS Series spares on page 354](#)
- [32.3 Network hardware on page 355](#)
- [32.4 Network cables on page 355](#)
- [32.5 Network cable types on page 356](#)
- [32.6 SeaTalk^{ng} cabling components on page 356](#)
- [32.7 SeaTalk^{ng} cables and accessories on page 357](#)
- [32.8 SeaTalk accessories on page 358](#)

32.1 gS Series accessories

The following accessories are available for gS Series displays.



Description	Part number
RMK-9 remote keypad	A80217
RCR-2 Remote Card Reader	A80218
5 m (16.4 ft) gS Series Video out cable (HDMI)	A80219
2 m 6.6 ft) gS Series Video In / Alarm Out cable	A80235
gS95 Mounting kit	A80220
gS125 Mounting kit	A80263
gS165 Mounting kit	A80264
1.5 m (4.9 ft) Straight power and data cable	R62379
1.5 m (4.9 ft) Right angled power and data cable	R70029

32.2 gS Series spares

The following accessories are available for gS Series displays.

Description	Part number
gS95 suncover	R70180
gS125 suncover	R70181
gS165 suncover	R70182
Card reader door	R70183
Card reader fitting kit	R70184

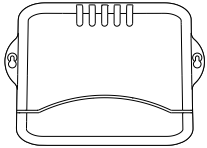
32.3 Network hardware

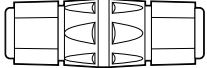
Item	Part number	Notes
HS5 RayNet network switch 	A80007	5-port switch for network connection of multiple devices featuring RayNet connectors. Equipment with RJ45 SeaTalk ^{hs} connectors can also be connected using suitable adapter cables.
RJ45 SeaTalk ^{hs} network switch 	E55058	8-port switch for network connection of multiple SeaTalk ^{hs} devices featuring RJ45 connectors.
RJ45 SeaTalk ^{hs} crossover coupler 	E55060	<ul style="list-style-type: none"> Enables direct connection of RJ45 SeaTalk^{hs} devices to smaller systems where a switch is not required. Enables the connection of RJ45 SeaTalk^{hs} devices to a HS5 RayNet network switch (in conjunction with suitable adapter cables). Enables 2 RJ45 SeaTalk^{hs} cables to be connected together to extend the length of the cabling. Recommended for internal installations.
Ethernet RJ45 coupler 	R32142	<ul style="list-style-type: none"> Enables direct connection of RJ45 SeaTalk^{hs} devices to smaller systems where a switch is not required. Enables the connection of RJ45 SeaTalk^{hs} devices to a HS5 RayNet network switch (in conjunction with suitable adapter cables). Enables 2 RJ45 SeaTalk^{hs} cables to be connected together to extend the length of the cabling. Recommended for external installations.

32.4 Network cables

RayNet to RayNet cables

Cable	Part number
400 mm (1.3 ft) RayNet (F) to RayNet (F) cable	A80161
2 m (6.56 ft) RayNet (F) to RayNet (F) cable	A62361
5 m (16.4 ft) RayNet (F) to RayNet (F) cable	A80005
10 m (32.8 ft) RayNet (F) to RayNet (F) cable	A62362
20 m (65.6 ft) RayNet (F) to RayNet (F) cable	A80006
100 mm (3.9 in) RayNet (M) to RayNet (M) cable	A80162
RayNet right-angled coupler	A80262
RayNet cable puller 5-pack	R70014

RayNet adapter cables

Cable	Part number
1 m (3.28 ft) RayNet (F) to RJ45 SeaTalk ^{hs} (M) cable	A62360
3 m (9.84 ft) RayNet (F) to RJ45 SeaTalk ^{hs} (M) cable	A80151
10 m (32.8 ft) RayNet (F) to RJ45 SeaTalk ^{hs} (M) cable	A80159
400 mm (1.3 ft) RayNet (F) to RJ45 SeaTalk ^{hs} (F) cable	A80160
100 mm (3.9 in) RayNet (F) to RJ45 (F) cable	A80247
350 mm (13.78 in) RayNet (M) to RJ45 SeaTalk ^{hs} (M) cable	A80272
3 m (9.84 ft) RayNet (F) to RJ45 SeaTalk ^{hs} (M) cable	A80276

32.5 Network cable types

There are 2 types of SeaTalk^{hs} network cable — “patch” and “network”.

- **Patch** — for connecting the following devices to a Raymarine network switch:
 - Thermal camera via PoE injector.
 - Additional Raymarine network switch.
 - PC or laptop using Voyager planning software.
- **Network** — for connecting the following devices to a Raymarine network switch:
 - Sonar Module.
 - SR100 Sirius weather receiver.
 - Additional compatible Raymarine multifunction displays.

SeaTalk^{hs} network cables

Cable	Part number
1.5 m (4.9 ft) SeaTalk ^{hs} network cable	E55049
5 m (16.4 ft) SeaTalk ^{hs} network cable	E55050
10 m (32.8 ft) SeaTalk ^{hs} network cable	E55051
20 m (65.6 ft) SeaTalk ^{hs} network cable	E55052

SeaTalk^{hs} patch cables

Cable	Part number
1.5 m (4.9 ft) SeaTalk ^{hs} patch cable	E06054
5 m (16.4 ft) SeaTalk ^{hs} patch cable	E06055
10 m (32.8 ft) SeaTalk ^{hs} patch cable	E06056
15 m (49.2 ft) SeaTalk ^{hs} patch cable	A62136
20 m (65.6 ft) SeaTalk ^{hs} patch cable	E06057

32.6 SeaTalk^{ng} cabling components

SeaTalk^{ng} cabling components and their purposes.

Connection / Cable	Notes
Backbone cable (various lengths)	The main cable carrying data. Spurs from the backbone are used to connect SeaTalk ^{ng} devices.
T-piece connector	Used to make junctions in the backbone to which devices can then be connected.
Terminator	Required at either end of the backbone.
Inline terminator	Used to connect a spur cable directly to the end of a backbone; useful for longer cable runs.
Spur cable	Used to connect devices to the backbone. Devices may be daisy chained or connected directly to the T-pieces.
SeaTalk ^{ng} 5-way connector	Used to branch, split, or make additional connections in SeaTalk or SeaTalk ^{ng} networks.
Blanking plug	Inserted into unused spur connector positions in a 5-way connector or T-piece.

32.7 SeaTalk^{ng} cables and accessories

SeaTalk^{ng} cables and accessories for use with compatible products.

Description	Part No	Notes
SeaTalk ^{ng} starter kit	T70134	Includes: <ul style="list-style-type: none"> • 1 x 5 Way connector (A06064) • 2 x Backbone terminator (A06031) • 1 x 3 m (9.8 ft) spur cable (A06040) • 1 x Power cable (A06049)
SeaTalk ^{ng} Backbone Kit	A25062	Includes: <ul style="list-style-type: none"> • 2 x 5 m (16.4 ft) Backbone cable (A06036) • 1 x 20 m (65.6 ft) Backbone cable (A06037) • 4 x T-piece (A06028) • 2 x Backbone terminator (A06031) • 1 x Power cable (A06049)
SeaTalk ^{ng} 0.4 m (1.3 ft) spur	A06038	
SeaTalk ^{ng} 1 m (3.3 ft) spur	A06039	
SeaTalk ^{ng} 3 m (9.8 ft) spur	A06040	
SeaTalk ^{ng} 5 m (16.4 ft) spur	A06041	
SeaTalk ^{ng} 0.4 m (1.3 ft) elbow spur	A06042	
SeaTalk ^{ng} 0.4 m (1.3 ft) backbone	A06033	
SeaTalk ^{ng} 1 m (3.3 ft) backbone	A06034	
SeaTalk ^{ng} 3 m (9.8 ft) backbone	A06035	
SeaTalk ^{ng} 5 m (16.4 ft) backbone	A06036	
SeaTalk ^{ng} 9 m (29.5 ft) backbone	A06068	
SeaTalk ^{ng} 20 m (65.6 ft) backbone	A06037	
SeaTalk ^{ng} to bare ends 1 m (3.3 ft) spur	A06043	
SeaTalk ^{ng} to bare ends 3 m (9.8 ft) spur	A06044	
SeaTalk ^{ng} Power cable	A06049	
SeaTalk ^{ng} Terminator	A06031	
SeaTalk ^{ng} T-piece	A06028	Provides 1 x spur connection
SeaTalk ^{ng} 5-way connector	A06064	Provides 3 x spur connections
SeaTalk ^{ng} backbone extender	A06030	
SeaTalk to SeaTalk ^{ng} converter kit	E22158	Allows the connection of SeaTalk devices to a SeaTalk ^{ng} system.

Description	Part No	Notes
SeaTalk ^{ng} Inline terminator	A80001	Provides direct connection of a spur cable to the end of a backbone cable. No T-piece required.
SeaTalk ^{ng} Blanking plug	A06032	
ACU / SPX SeaTalk ^{ng} spur cable 0.3 m (1.0 ft)	R12112	Connects an SPX course computer or an ACU to a SeaTalk ^{ng} backbone.
SeaTalk (3 pin) to SeaTalk ^{ng} adaptor cable 0.4 m (1.3 ft)	A06047	
SeaTalk to SeaTalk ^{ng} spur 1 m (3.3 ft) spur	A22164	
SeaTalk2 (5 pin) to SeaTalk ^{ng} adaptor cable 0.4 m (1.3 ft)	A06048	
DeviceNet adaptor cable (Female)	A06045	Allows the connection of NMEA 2000 devices to a SeaTalk ^{ng} system.
DeviceNet adaptor cable (Male)	A06046	Allows the connection of NMEA 2000 devices to a SeaTalk ^{ng} system.
DeviceNet adaptor cable (Female) to bare ends.	E05026	Allows the connection of NMEA 2000 devices to a SeaTalk ^{ng} system.
DeviceNet adaptor cable (Male) to bare ends.	E05027	Allows the connection of NMEA 2000 devices to a SeaTalk ^{ng} system.

32.8 SeaTalk accessories

SeaTalk cables and accessories for use with compatible products.

Description	Part No	Notes
3-way SeaTalk junction box	D244	
1 m (3.28 ft) SeaTalk extension cable	D284	
3 m (9.8 ft) SeaTalk extension cable	D285	
5 m (16.4 ft) SeaTalk extension cable	D286	
9 m (29.5 ft) SeaTalk extension cable	D287	
12 m (39.4 ft) SeaTalk extension cable	E25051	
20 m (65.6 ft) SeaTalk extension cable	D288	

Appendix A NMEA 0183 sentences

The display supports the following NMEA 0183 sentences. These are applicable to NMEA 0183 and SeaTalk protocols.

Sentence	Description	Transmit	Receive
AAM	Waypoint arrival alarm sentence		•
APB	Autopilot sentence 'B'	•	•
BWC	Bearing and distance to waypoint	•	•
BWR	Bearing and distance to waypoint — Rhumb	•	•
DBT	Depth below transducer	•	•
DPT	Depth	•	•
DSC	Digital selective calling information sentence		•
DSE	Distress sentence expansion		•
DTM	Datum reference sentence		•
GBS	GPS satellite fault detection data sentence		•
GGA	GPS System fix data	•	•
GLC	Geographic position loran C sentence		•
GLL	Geographic position latitude longitude	•	•
GSA	GPS DOP and active satellites	•	•
GSV	GPS satellites in view	•	•
HDG	Heading deviation and variation sentence		•
HDT	Heading true sentence		•
HDM	Heading magnetic sentence		•
MDA	Meteorological composite sentence		•
MSK	MSK receiver interface sentence		•
MSS	MSK receiver signal status sentence		•
MTW	Water temperature	•	•
MWV	Wind speed and angle	•	•
RMB	Recommended minimum navigation information	•	•
RMC	Recommended minimum specific GNSS data	•	•
RSD	Radar system data	•	•
TTM	Tracked target message	•	•
VHW	Water speed and heading	•	•
VLW	Distance travelled through the water	•	•
VTG	Course over ground and ground speed	•	•
XTE	Cross track error measured sentence		•
ZDA	Time and date	•	•

Appendix B NMEA data bridging

NMEA data bridging allows data that exists on the display's NMEA 2000 bus to be repeated to NMEA 0183 devices, and vice versa.

An example of NMEA data bridging is in a system that includes a third-party GPS receiver connected to the NMEA 0183 Input of a Raymarine display. The GPS data messages transmitted by the GPS receiver are repeated to any appropriate devices connected to the display's NMEA 2000 bus. Bridging only occurs when the data is being transmitted by an NMEA 0183 device that is not already being transmitted by a NMEA 2000 device, and vice versa.

For a list of data messages (PGN sentences) that are bridged between NMEA 2000 and NMEA 0183, refer to the list of supported NMEA 2000 sentences provided in this document.

Appendix C NMEA 2000 sentences

The display supports the following NMEA 2000 sentences. These are applicable to NMEA 2000, SeaTalk^{ng} and SeaTalk 2 protocols.

Message number	Message description	Transmit	Receive	Bridged to NMEA 0183
59392	ISO Acknowledgment	•	•	
59904	ISO Request	•	•	
60928	ISO Address Claim	•	•	
126208	NMEA - Request group function	•	•	
126464	PGN List – Transmit/Receive PGN's Group function	•	•	
126992	System time	•	•	
126996	Product information	•	•	
127237	Heading/Track Control		•	
127245	Rudder		•	
127250	Vessel heading	•	•	•
127251	Rate of Turn	•	•	
127257	Attitude	•	•	
127258	Magnetic Variation	•		
127488	Engine parameters, rapid update		•	
127489	Engine parameters, dynamic		•	
127493	Transmission parameters, dynamic		•	
127496	Trip parameters, Vessel		•	
127497	Trip parameters, Engine		•	
127498	Engine parameters, static		•	
127505	Fluid level		•	
127508	Battery status		•	
128259	Speed, water referenced	•	•	•
128267	Water depth	•	•	•
128275	Distance log	•	•	•
129025	Position, rapid update	•	•	•
129026	COG & SOG, rapid update	•	•	•
129029	GNSS position data	•	•	•
129033	Time and date	•	•	•
129038	AIS Class A Position Report		•	
129039	AIS Class B Position Report		•	
129040	AIS Class B Extended Position Report		•	
129041	AIS Aids to Navigation (AToN) report		•	
129044	Datum	•	•	•
129283	Cross track error	•	•	•
129284	Navigation data	•	•	•
129291	Set and drift, rapid update	•	•	•
129301	Time to or from mark		•	
129539	GNSS DOPs		•	
129540	GNSS Sats in view	•	•	
129542	GNSS pseudorange noise statistics		•	
129545	GNSS RAIM output		•	
129550	GNSS differential correction receiver interface		•	
129551	GNSS differential correction receiver signal		•	
129793	AIS UTC and Date Report		•	

Message number	Message description	Transmit	Receive	Bridged to NMEA 0183
129794	AIS Class A Static and Voyage Related Data		•	
129798	AIS SAR aircraft position report		•	
129801	AIS Addressed Safety Related Message		•	
129802	AIS Safety Related Broadcast Message		•	
129808	DSC call information		•	
129809	AIS class B "CS" static data report part A		•	
129810	AIS class B "CS" static data report part B		•	
130306	Wind data	•	•	•
130310	Environmental parameters	•	•	•
130311	Environmental parameters		•	•
130312	Temperature		•	
130313	Humidity		•	
130314	Actual pressure		•	
130576	Small craft status		•	
130577	Direction data	•	•	•
130578	Vessel speed components		•	

PGN 127489 - Support engine alarms

The following engine alarms are supported.

Engine Error
Check Engine
Over Temperature
Low Oil Pressure
Low Oil Level
Low Fuel Pressure
Low System Voltage
Low Coolant Level
Water Flow
Water in Fuel
Charge Indicator
High Boost Pressure
Rev Limit Exceeded
EGR System
Throttle Position Sensor
Engine Emergency Stop Mode
Warning Level 1
Warning Level 2
Power Reduction
Maintenance Needed
Engine Comm Error
Sub or Secondary Throttle
Neutral Start Protect
Engine Shutting Down
unknown error

Appendix D Connectors and pinouts

Power, data, and video connector

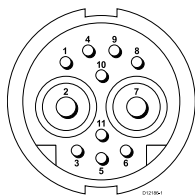

Item	Remarks
Identification	PWR / NMEA / Video
Connector type	11 pin twist-lock
Current source to network	No current sourced for external devices
Current sink from network	<ul style="list-style-type: none"> PSU: Main Power input. NMEA: No power required for interface. Video: No power required for interface.

Power, data and video cable cores and colors

Signal	Pin	AWG	Color
BATT+	2	16	Red
BATT-	7	16	Black
SCREEN	10	26	Black
NMEA1 TX+	8	26	Yellow
NMEA1 TX-	9	26	Brown
NMEA1 RX+	1	26	White
NMEA1 RX-	4	26	Green
NMEA2 RX+	3	26	Orange / White
NMEA2 RX-	11	26	Orange / Green
VIDEO IN	6	RG179 coaxial	
VIDEO RTN	5	Screen	

Network connector

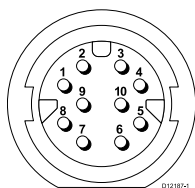

Item	Remarks
Identification	Network
Connector type	RJ45 (with suitable waterproofing)
Current source to network	No current sourced for external devices
Current sink from network	No power required for interface

Pin	Signal
1	Rx+
2	Rx-
3	Not connected
4	Not connected
5	Tx+
6	Tx-

Pin	Signal
7	Not connected
8	Not connected
9	Screen
10	Not connected

Note: Use only Raymarine RayNet cables when connecting SeaTalk^{hs} devices.

SeaTalk^{ng} connector

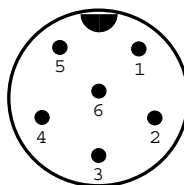

Item	Remarks
Identification	ST2/NMEA2000
Connector type	STNG
Current source to network	No current sourced for external devices
Current sink from network	<160mA (Interface drive only)

Pin	Signal
1	+12V
2	0V
3	Screen
4	CanH
5	CanL
6	SeaTalk (not connected)

Note: Use only Raymarine cables when connecting to SeaTalk^{ng}

Video in / Alarm out connector

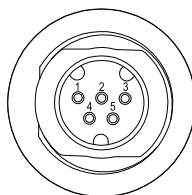

Pin 1	Alarm +
Pin 2	Alarm -
Pin 3	Purple
Pin 4	Video Screen
Pin 5	Video Core

Appendix E Switch panel application

Vessel control and monitoring systems

When integrated with a vessel control and monitoring system your multifunction display can provide monitoring and controls for your power circuits, breakers, switches and equipment.

The Switch Panel application can be used to:

- Show the status of power circuits, breakers, switches and other equipment.
- Apply power to each circuit individually.
- Reset tripped breakers.
- Control power to individual equipment.
- Alert users to a tripped circuit.

Vessel control and monitoring system connection

The multifunction display can connect to and control an EmpirBus NXT vessel control and monitoring system.

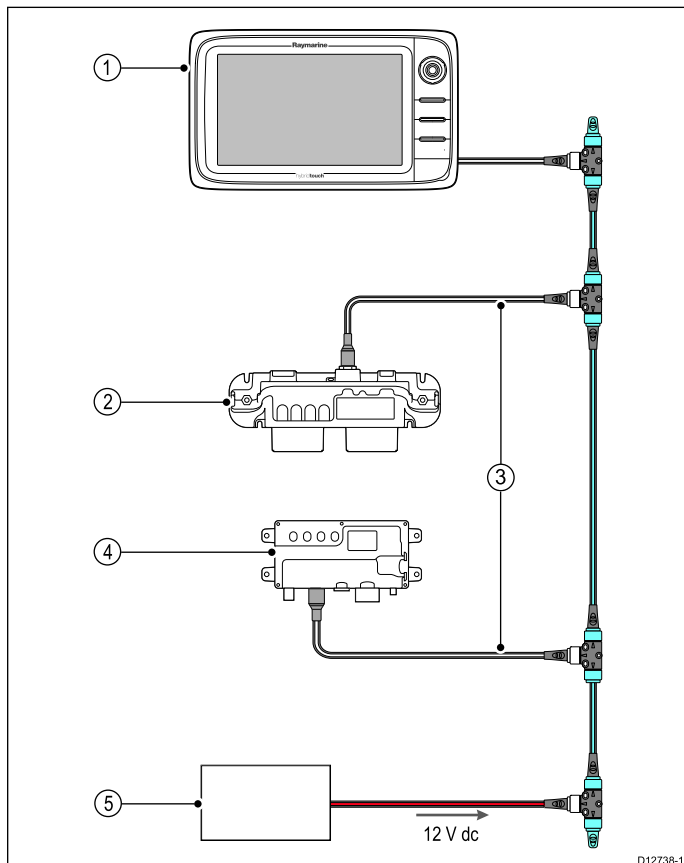

1	Raymarine multifunction display.
2	EmpirBus NXT DCM (dc module).
3	SeaTalkng to DeviceNet adaptor cable.
4	EmpirBus NXT MCU (Master control unit).
5	12 V dc supply into backbone.

Note: Ensure your vessel control and monitoring system has been installed in accordance with the instructions provided with the system.

Switch panel configuration

The switch panel application must be configured. A Configuration file can be obtained from the system supplier.

Loading a configuration file

The switch panel application will only be available when a valid configuration file has been loaded.

1. Obtain the configuration file from the system supplier.
2. Save the configuration file to the root directory of your memory card.

3. Insert the memory card into the card reader on your multifunction display.
4. From the homescreen select **Set-up**.
5. Select **System Settings**.
6. Select **External Devices**.
7. Select **Switch Panel Set-up**.
8. Select **Install Config File**.
9. If prompted select the memory card slot that contains your configuration file.
The file browser is opened.
10. Select the configuration file.
11. Select **OK**.

You can now add the Switch panel application from the Customize menu on the homescreen.

Note: If your multifunction display only has 1 card slot then step 9 is skipped.

Switch panel overview

The switch panel application is used to monitor and control compatible vessel control and monitoring systems. The pages and page layouts and vessel schematics are configured at installation and are unique for each vessel. The images below are examples.

Example 1 — Switch panel mode page



If configured a Mode page provides controls to switch between pre-configured modes.

In the example above selecting a mode icon will place the system into the selected mode.

You can cycle through available pages to monitor or control switches and configured groups of switches.

Example 2 — Vessel controls page

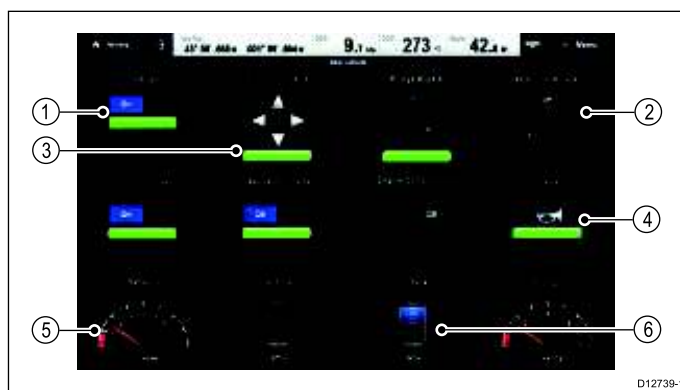

1	Toggle switch.
2	Rotary (multi-state) switch.
3	Position control switch.
4	Momentary switch.
5	Data item (dial gauge).
6	Data item (tank level).

Using the switches on a Touchscreen



This only applies to HybridTouch displays.

From the switch panel application:

1. **Toggle switch** — Select the switch to switch on or off.
2. **Rotary control** — Selecting the rotary control will cycle through its available states.
3. **Position Control** — Select and hold on a direction to move.
4. **Momentary switch** — Select the switch to activate.
5. **Dimmer switch** — Select and then drag the control to adjust the value.

Using the switches

From the switch panel application:

1. Use the **Joystick** to highlight the relevant switch.
2. **Toggle switch** — Press **Ok** to switch on or off.
3. **Rotary control** — Pressing **Ok** will cycle through its available states.
4. **Position Control** — Press **Ok** and use the **Joystick** to move direction.
5. **Momentary switch** — Press **Ok** to activate.
6. **Dimmer switch** — Press **Ok** on the switch and use the **Rotary Control** to adjust the value, then select **back** to exit adjust mode.

Resetting a tripped circuit

When a circuit is tripped a pop-up message will be displayed on-screen providing details of the tripped circuit and options, the circuit will also be identified as tripped in the switch panel pages.

1. With a tripped circuit pop-up message displayed select **Reset** to reset the tripped circuit, or
2. Select the switch on a switch panel page to reset the tripped switch.

Note: Performing multiple resets risks causing damage to your system so if a trip persists check the main circuits.

Appendix F Software releases

Raymarine regularly updates its multifunction display software to introduce improvements, additional hardware support and user interface features. The table below details some of the important enhancements and which software revision they were introduced with.

Software version	Applicable product manual	Multifunction displays compatibility	Changes
LightHouse II — V10.xx	81344-3	gS95, gS125, gS165	<p>New Fishfinder application</p> <ul style="list-style-type: none"> • Support for multiple active sonar modules on the network • Ability to display multiple sonar channels simultaneously using splitscreen pages • Ability to create custom sonar channel profiles • New sonar module specific Fishfinder simulator • Corrected (reversed) TVG control on CP450C to match all sonar modules • Switch panel alarms can now be enabled/disabled globally across the network • Added horizontal splitscreen template for 5.7 and 7 inch MFDs • Added support for Navionics Sonar Log depth recording • Added support for Navionics Plotter Sync mobile chart updates • Updated SiriusXM NOAA Marine Zone Boundaries updates for April 1st 2014 • AIS dangerous target alarm defaults to Off in Simulator mode and cannot be enabled. • Added additional language support for Czech and Slovenian
LightHouse II — V9.45	81344-2	gS95, gS125, gS165	<ul style="list-style-type: none"> • LightHouse II Graphics refresh • Added hide databar option • Added support for LightHouse charts • Waypoint management improvements • Chart and Radar application menu improvements • Added support for multiple sonars • Added estimated time of arrival for Routes • Added NM & m to distance units • Added digital widget to Switch panel app • Added support for DSC over NMEA 2000. • Added support for Navionics Gold chip encryption. • Updated Japanese limitations of use statement
V8.52	81344-2	gS95, gS125, gS165	<ul style="list-style-type: none"> • Added support for ECI-100 (Engine Identification Wizard)
V7.43	81344-1	gS95, gS125, gS165	<ul style="list-style-type: none"> • First release for gS Series.

Raymarine[®]
A FLIR COMPANY