



Instruction Manual

Model

2166A

Multipoint
Digital Thermometer

LIMITED WARRANTY

The JOHN FLUKE MFG. CO., INC., warrants each instrument it manufactures to be free from defects in material and workmanship under normal use and service for the period of one year from date of purchase. This warranty extends only to the original purchaser. This warranty shall not apply to fuses, disposable batteries (rechargeable type batteries are warranted for 90 days), or any product or parts which have been subject to misuse, neglect, accident or abnormal conditions of operations.

In the event of failure of a product covered by this warranty, John Fluke Mfg. Co., Inc., will repair and calibrate an instrument returned to an authorized Service Facility within one year of the original purchase; provided the warrantor's examination discloses to its satisfaction that the product was defective. The warrantor may, at its option, replace the product in lieu of repair. With regard to any instrument returned within one year of the original purchase, said repairs or replacement will be made without charge. If the fault has been caused by misuse, neglect, accident or abnormal conditions of operations, repairs will be billed at a nominal cost. In such case, an estimate will be submitted before work is started, if requested.

ANY IMPLIED WARRANTIES OF MERCHANTABILITY OR FITNESS SHALL BE LIMITED TO A PERIOD OF TWELVE MONTHS FROM THE DATE OF PURCHASE. THE FOREGOING WARRANTY IS IN LIEU OF ALL OTHER WARRANTIES, EXPRESS OR IMPLIED, INCLUDING BUT NOT LIMITED TO ANY IMPLIED WARRANTY OF MERCHANTABILITY, FITNESS OR ADEQUACY FOR ANY PARTICULAR PURPOSE OR USE. JOHN FLUKE MFG. CO., INC. SHALL NOT BE LIABLE FOR ANY SPECIAL, INCIDENTAL OR CONSEQUENTIAL DAMAGES, WHETHER IN CONTRACT, TORT OR OTHERWISE.

NOTE: Some states do not allow limitations on how long an implied warranty lasts, or the exclusion or limitation of incidental or consequential damages, so the above limitations or exclusion may not apply to you. This warranty gives you specific legal rights, and you may also have other rights which vary from state to state.

If any fault develops, the following steps should be taken:

1. Notify the John Fluke Mfg. Co., Inc. or nearest Service facility, giving full details of the difficulty, and include the Model number, type number, and serial number. On receipt of this information, service data or shipping instructions will be forwarded to you.
2. On receipt of the shipping instructions, forward the instrument, transportation prepaid. Repairs will be made at the Service Facility and the instrument returned, transportation prepaid.

SHIPPING TO MANUFACTURER FOR REPAIR OR ADJUSTMENT

All shipments of John Fluke Mfg. Co., Inc., instruments should be made via United Parcel Service or "Best Way" prepaid. The instrument should be shipped in the original packing carton; or if it is not available, use any suitable container that is rigid and of adequate size. If a substitute container is used, the instrument should be wrapped in paper and surrounded with at least four inches of excelsior or similar shock-absorbing material.

CLAIM FOR DAMAGE IN SHIPMENT TO ORIGINAL PURCHASER

The instrument should be thoroughly inspected immediately upon original delivery to purchaser. All material in the container should be checked against the enclosed packing list. The manufacturer will not be responsible for shortages against the packing sheet unless notified immediately. If the instrument is damaged in any way, a claim should be filed with the carrier immediately. (To obtain a quotation to repair shipment damage, contact the nearest Fluke Technical Center.) Final claim and negotiations with the carrier must be completed by the customer.

The John Fluke Mfg. Co., Inc. will be happy to answer all application or use questions, which will enhance your use of this instrument. Please address your requests or correspondence to: JOHN FLUKE MFG. CO., INC., P.O. Box 43210, MOUNTLAKE TERRACE, WASHINGTON 98043, Atten: Sales Dept. For European Customers: FLUKE (Nederland) B.V., Zevenheuvelenweg 53, Tilburg, The Netherlands.

* For European customers, Air Freight prepaid.

John Fluke Mfg. Co., Inc. • P.O. Box 43210 • Mountlake Terrace, Washington 98043

Change/Errata Information

Issue No: 2 4/78

This change/errata contains information necessary to ensure the accuracy of the following manual. Enter the corrections in the manual in the order given.

MANUAL

Title: MODEL 2166A MULTIPOINT DIGITAL THERMOMETER
Print Date: APRIL 1976
Rev and Date: 1 - 2/77

C/E PAGE EFFECTIVITY

Page No.	Print Date
1	4/78

CHANGE #1-11434

On page 5-6, add CR4 to reference designators CR6 thru CR15, and change total quantity from 10 to 11.

On page 5-7, change the stock number, supply code, and part numbers for Q27 and Q28 from:

272237, 07263, 2N4946

to:

477331, 04713, MPSU01A

On page 8-3, add diode CR4 between the +5 and +6.8V dc power supply outputs; cathode to +6.8V, anode to +5V.

CHANGE #2-11563

Rev H-1

On page 5-8, make the following changes:

Change the U1 entry from:

IC, dual opnl ampl; 404087; 49956; RC4739DP; 1; 1

To:

Op amp pcb assy; 488379; 89536; 488379

Add the following new entry (socket for U1):

XU1; Socket; IC, 14-pin DIP; 276527; 89536; 276527; 1; 1

Rev J

On page 5-8, change the entry for U1 from:

IC, dual opnl ampl; 404087; 49956; RC4739DP; 1; 1

To:

IC, dual opnl ampl, 8-pin DIP; 478032; 04713; MC4558NCPI; 1; 1

Section 1

Introduction & Specifications

1-1. INTRODUCTION

1-2. The Model 2166A Multipoint Digital Thermometer is a portable four-digit, manual-scan, thermocouple thermometer capable of measuring any 1 of 10 possible like-type thermocouple inputs and resolving 1°C or 1°F over a temperature range of -200 to $+2328^{\circ}\text{C}$ or -328 to $+3999^{\circ}\text{F}$. It features switch selection of temperature ($^{\circ}\text{C}/^{\circ}\text{F}$) and thermocouple channel (1-10), a four digit LED display, reference junction compensation (to eliminate the need for an ice bath reference junction), the choice of any one of eight thermocouple types (J, K, T, E, R, S, B or C) as the input device, dual-slope measurement techniques, digital linearization of thermocouple inputs, and power inputs for both ac line and external 12V dc operation. Several options and accessories are also available for use with the 2166A.

1-3. Front panel switch controls include a push-button power switch (ON/OFF), a push-button temperature select switch ($^{\circ}\text{C}/^{\circ}\text{F}$), and a 10-position rotary switch for selecting the desired thermocouple. The rotary switch is labeled CHANNEL Select and the thermocouple inputs are identified as 1 through 10.

1-4. The front-panel display consists of five, seven-segment, high-intensity LED's, and features leading zero suppression. Four of the LED's are used to display numeric data, including a minus sign for negative temperature indications. The fifth LED displays the selected $^{\circ}\text{C}$ or $^{\circ}\text{F}$ scale character. An open-thermocouple detector causes the display to blink when an open circuit is sensed at any one of the selected thermocouple input terminals.

1-5. A plug-in module at the rear of the 2166A provides 10 pairs of screw-type input terminals for attaching individual thermocouples to the desired channels. These terminals are an integral part of an isothermal block and serve as the reference junction for the reference junction compensator. (The reference junction compensator provides the physical and electrical equivalent of, and eliminates the need for, an ice bath junction at 0°C or 32°F .)

NOTE

All thermocouples connected to the input terminals must be of the same type.

1-6. The actual measurement range of the 2166A is determined by the type of thermocouples being used as the input devices. Any one of eight thermocouple types can be used; J, K, T, E, R, S, B or C. To ensure the proper linearization of the selected thermocouple input, a corresponding linearization program must be selected on the interior of the unit. Selection is accomplished by installing a type select pcb which corresponds to the input thermocouple. A single type select pcb is supplied with the unit to match the thermo-

Table 1-1. 2166A ACCESSORIES

MODEL NO.	DESCRIPTION
C80	Carrying Case
C86	Carrying Case
P20J	J-Type Thermocouple Probe
P20K	K-Type Thermocouple Probe
P20T	T-Type Thermocouple Probe
M00-100-714	Front Panel Dust Cover
M00-200-611	Rack Mounting Kit, Offset
M00-200-612	Rack Mounting Kit, Center
M00-200-613	Rack Mounting Kit, Side-by-Side
2160A-7016	J-Type Select PCB
2160A-7017	K-Type Select PCB
2160A-7019	E-Type Select PCB
2160A-7018	T-Type Select PCB
2160A-7012	R-Type Select PCB
2160A-7013	S-Type Select PCB
2160A-7014	B-Type Select PCB
2160A-7015	C-Type Select PCB
2160A-7022	Interface Cable

couple specified at the time of purchase. The remaining pcb's are individually available as accessories and are described in Table 1-1.

1-7. Accessories and options available for use with the 2166A are listed and described in Tables 1-1 and 1-2, respectively. Both options are field installable. Either one, but not both, of the options can be installed in a unit. Detailed information concerning each option and accessory is given in Section 6 of this manual, Option and Accessory Information.

1-8. The 2166A is designed to operate from either ac line power or an external 12V dc source. A choice of any one of three line power configurations are available: 100V ac,

Table 1-2. 2166A OPTIONS

OPTION NUMBER	DESCRIPTION
-02	Digital Output Unit
-04	Analog Output Unit

50 to 440 Hz; 115V ac, 50 to 440 Hz; and 230V ac, 50 to 440 Hz. Specify the required configuration at the time of purchase.

1-9. SPECIFICATIONS

1-10. Specifications for the 2166A are given in Table 1-3.

Table 1-3. SPECIFICATIONS

ELECTRICAL	
Compatible Thermocouple Types	Unit can be calibrated to operate with any one of the following thermocouple types: J, K, T, E, R, S, B or C
Measurement Method	Dual-slope integration over a 100 ms period
Zero Drift	None. Automatic zero correction
Reading Rate	2.5 readings per second
°C to °F Conversion	Switch selectable
Input Characteristics	
Input Connections	Screw terminals on isothermal connector
Input Circuit	Two-wire isolated per channel, 10-channel, switch selectable
Input Impedance	> 100 MΩ
Input Current	< 500 pA
Source Impedance	≤ 5kΩ. 5kΩ causes <0.2°C (.36°F) error with k thermocouple
Overload	Display flashes when input voltage exceeds full-scale temperature range
Open Input	Display flashes to indicate open at input terminals
Maximum Input Voltage	130V dc or 130V ac (rms) between any pair of inputs
Maximum Input Voltage (without damage)	400V dc or ac peak continuously between inputs or between either input and ground
Maximum Common Mode Voltage (without damage)	400V dc or ac peak
Common Mode Rejection	≥ 120 dB @ 50, 60, 400 Hz ±0.1% with 1kΩ source impedance unbalance
Normal Mode Rejection	≥ 60 dB @ 50, 60, 400 Hz ±0.1%
Accuracy	See Table 1 for °C specifications and Table 2 for °F specifications
Response Time to Rated Accuracy	< 2.0 seconds
Linearization	Digital with eight selectable programs in LSI ROM
Linearization Programs	
J, K, T and E	32 straight line segments for positive inputs and 16 for negative inputs

Table 1-3. SPECIFICATIONS (Cont.)

Reference Junction Compensation

20 to 30°C (68 to 86°F)

J, K, T, E 0.025 degrees per degree

0 to 20°C, 30 to 50°C (32 to 68°F, 86 to 122°F)

J, K 0.032 degrees per degree

T, E 0.045 degrees per degree

Temperature Coefficient 0.005% of reading per °C

Internal Temperature Rise ≤ 8°C (14.4°F)

Table 1. ACCURACY SPECIFICATIONS °C

THERMOCOUPLE TYPE	TEMPERATURE RANGE °C	RESOLUTION AND REPEATABILITY (±C)	APPLICABLE TEMPERATURE RANGE °C	MAXIMUM ERROR INCLUDING NBS CONFORMITY (±°C)*				
				CALIBRATION ACCURACY	20 min. to 24 hrs. 23 to 27°C	90 Days 20 to 30°C	1 Year 15 to 35°C	NBS CONFORMITY (±°C)
J	-200 to 778	1	-200 to 0	1	1	1.5	1.5	.19
			0 to 778	1	1	1	1.5	.15
K	-200 to 1356	1	-200 to 0	1	1	1.5	2	.20
			0 to 1356	1	1	1.5	2	.18
T	-200 to 400	1	-200 to 0	1	1	1.5	2	.19
			0 to 400	1	1	1	1	.15
E	-200 to 1000	1	-200 to 0	1	1	1.5	2	.17
			0 to 1000	1	1	1	1.5	.18
R	0 to 1778	1	0 to 1778	1.5	1.5	2.5	3	.26
S	0 to 1778	1	0 to 1778	1.5	1.5	2	3	.22
B	533 to 1844	1	533 to 1844	1.5	1.5	2	2.5	.29
C	0 to 2328	1	0 to 2328	2	2	3	3	.36

* Includes reference junction and conformity errors. Excludes thermocouple errors.

Table 1-3. SPECIFICATIONS (Cont.)

Table 2 ACCURACY SPECIFICATIONS °F

THERMOCOUPLE TYPE	TEMPERATURE RANGE °F	RESOLUTION AND REPEATABILITY (± °F)	APPLICABLE TEMPERATURE RANGE °F	MAXIMUM ERROR INCLUDING NBS CONFORMITY (± °F)*				NBS CONFORMITY (± °F)
				CALIBRATION ACCURACY	20 min. to 24 hrs. 72 to 82°F	90 Days 68 to 86°F	1 Year 59 to 95°F	
J	-328 to 1432	1	-328 to 32 32 to 1432	1.5	2	2	3	0.27
				1.5	1.5	1.5	2.5	0.2
K	-328 to 2472	1	-328 to 32 32 to 2472	2	2	2.5	3	0.28
				1.5	1.5	2.5	3.5	0.26
T	-328 to 752	1	-328 to 32 32 to 752	2	2	2.5	3.5	0.3
				1.5	1.5	1.5	2	0.2
E	-328 to 1832	1	-328 to 32 32 to 1832	2	2	2.5	3.5	0.25
				1.5	1.5	2	3	0.25
R	32 to 3232	1	32 to 3232	2.5	2.5	4	5	0.4
S	32 to 3232	1	32 to 3232	2.5	2.5	4	5	0.33
B	1032 to 3352	1	1032 to 3352	2.5	2.5	4	4.5	0.45
C	32 to 3999	1	32 to 3999	3	3	5	5.5	0.58

*Includes reference junction and conformity errors. Excludes thermocouple errors.

GENERAL

Type of Display LED, 0.56 in high.

Power Requirements

Line Operation 115V ac ±10%, 50 to 440 Hz, 8W. 100V ac and 230V ac version are also available.

External DC Source 11 to 15V dc @ 400 mA

Size 2.52 in (H) x 8.55 in (W) x 9.9 in (D) (6.40 cm x 21.72 cm x 25.15 cm). See Figure 1-1.

Weight 3 lbs. 4 oz. (1.47 kg)

Table 1-3. SPECIFICATIONS, Cont.

ENVIRONMENTAL	
Temperature	
Operating	0 to 50°C (32 to +122°F)
Storage	-40 to 75°C (-40 to 167°F)
Humidity	
0 to 50°C (32 to 122°F)	80% non-condensing
0 to 35°C (32 to 95°F)	90% non-condensing
Shock and Vibration	Meets requirements of MIL Standard 810

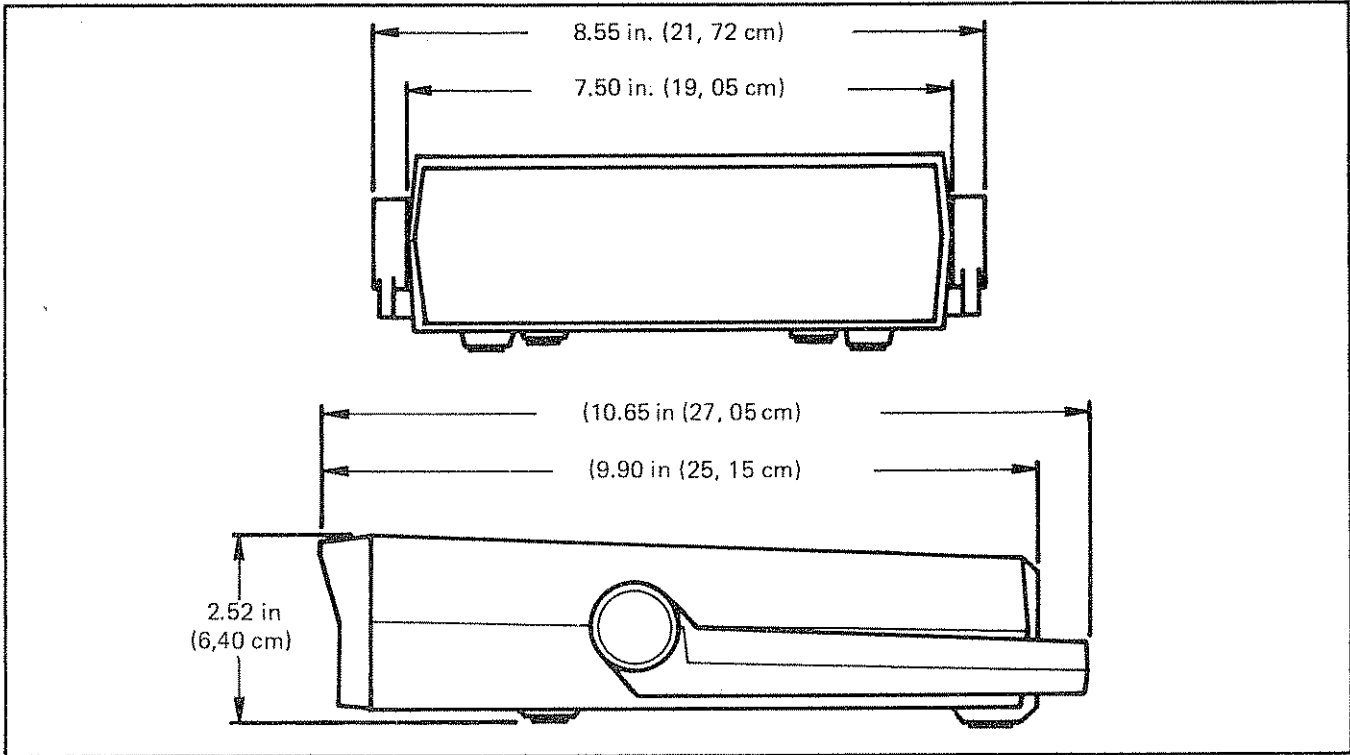

Figure 1-1. OUTLINE DRAWING



static awareness



A Message From
John Fluke Mfg. Co., Inc.

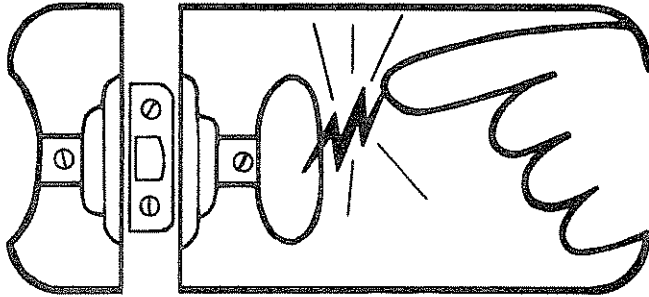

Some semiconductors and custom IC's can be damaged by electrostatic discharge during handling. This notice explains how you can minimize the chances of destroying such devices by:

1. Knowing that there is a problem.
2. Learning the guidelines for handling them.
3. Using the procedures, and packaging and bench techniques that are recommended.

The Static Sensitive (S.S.) devices are identified in the Fluke technical manual parts list with the symbol "⊗".

The following practices should be followed to minimize damage to S.S. devices.

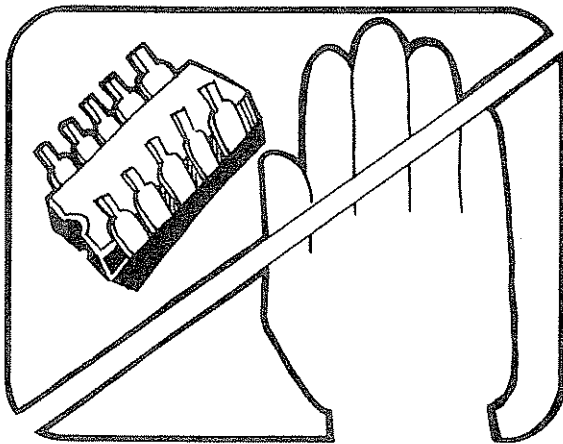

1. MINIMIZE HANDLING

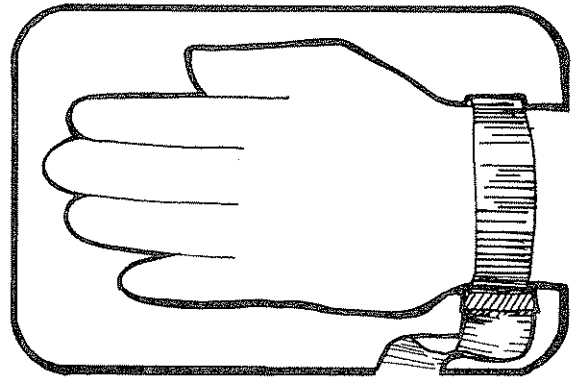

3. DISCHARGE PERSONAL STATIC BEFORE HANDLING DEVICES

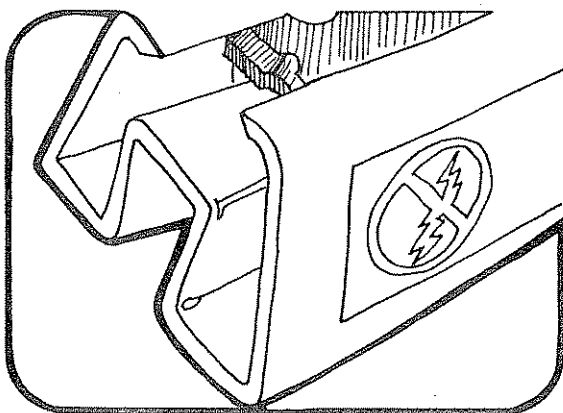

2. KEEP PARTS IN ORIGINAL CONTAINERS UNTIL READY FOR USE.

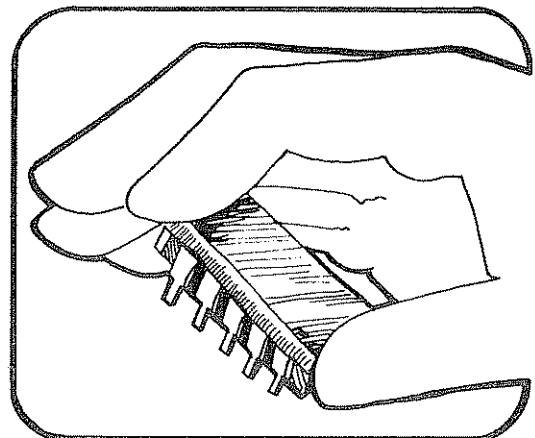

4. HANDLE S.S. DEVICES BY THE BODY

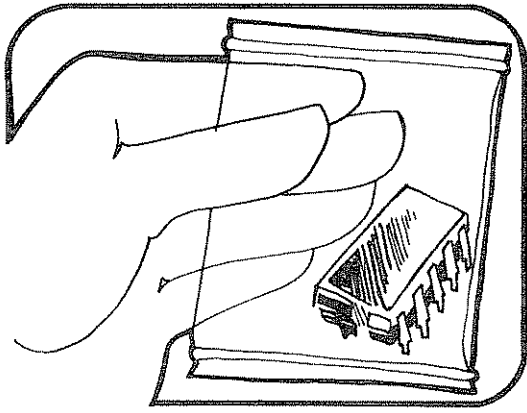

5. USE ANTI-STATIC CONTAINERS FOR HANDLING AND TRANSPORT

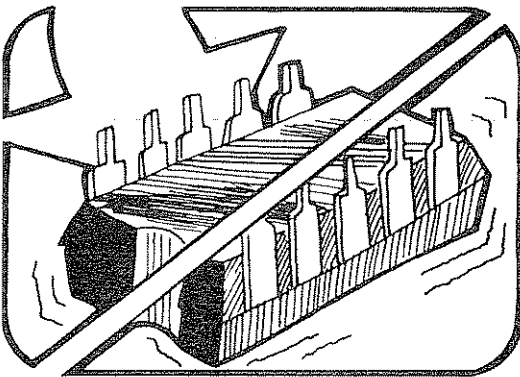

6. DO NOT SLIDE S.S. DEVICES OVER ANY SURFACE

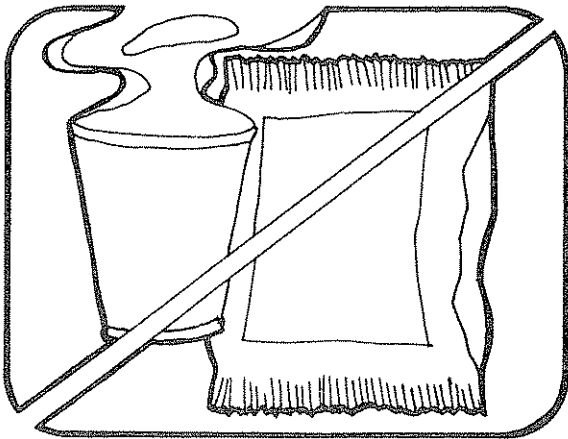

7. AVOID PLASTIC, VINYL AND STYRAFOAM IN WORK AREA

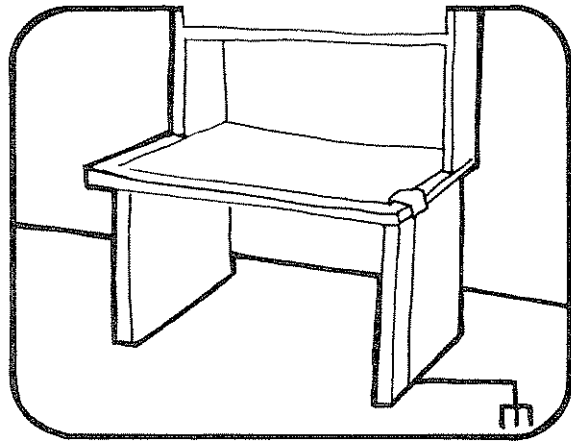

8. HANDLE S.S. DEVICES ONLY AT A STATIC-FREE WORK STATION

9. ONLY ANTI-STATIC TYPE SOLDER-SUCKERS SHOULD BE USED.

10. ONLY GROUNDED TIP SOLDERING IRONS SHOULD BE USED.

Anti-static bags, for storing S.S. devices or pcbs with these devices on them, can be ordered from the John Fluke Mfg. Co., Inc.. See section 5 in any Fluke technical manual for ordering instructions. Use the following part numbers when ordering these special bags.

John Fluke Part No.	Bag Size
453522	6" x 8"
453530	8" x 12"
453548	16" x 24"
454025	12" x 15"

Section 2

Operating Instructions

WARNING!

Due to the possible presence of lethal voltages, the procedures in paragraphs 2-21 and 2-27 should be performed by qualified personnel only.

2-1. INTRODUCTION

2-2. This section of the manual contains information regarding installation and operation of the Model 2166A Multi-point Digital Thermometer. It is recommended that the contents of this section be read and understood before any attempt is made to operate the instrument. Should any difficulties arise during operation, please contact your nearest Fluke Technical Service Center, or the John Fluke Mfg. Co., Inc., P.O. Box 43210, Mountlake Terrace, WA 98043, Tel. (206) 774-2211. A list of Technical Service Centers is located in Section 7 of this manual.

2-3. SHIPPING INFORMATION

2-4. The 2166A is packaged and shipped in a foam-packed container. Upon receipt of the instrument, a thorough inspection should be made to reveal any possible shipping damage. Special instructions for inspection and claims are included in the shipping carton.

2-5. If reshipment of the instrument is necessary, the original container should be used. If the original container is not available, a new one can be obtained from the John Fluke Mfg. Co., Inc. Please reference the instrument model number when requesting a new shipping container.

2-6. INPUT POWER

2-7. The 2166A can be operated from either ac line power or an external 12V dc source. The unit is energized when either or both sources are connected to their proper input terminals, and the front-panel POWER switch is set to ON.

2-8. AC Line Voltage

2-9. The 2166A is factory wired to operate from one of three ac line voltages. These are: 100V ac, 50 to 440 Hz; 115V ac, 50 to 440 Hz; and 230V ac, 50 to 440 Hz. Before connecting the 2166A to the ac line, check to ensure that the instrument is wired to accommodate the local line voltage. A decal on the underside of the unit defines the particular line voltage required to operate the instrument.

2-10. The rear panel ac input connector is a three-prong, U-ground connector which permits the instrument to be connected, via the power cord, to the appropriate line voltage. The offset prong on this connector is connected to the 2166A power supply, and should be connected through the power cord to a high quality earth ground.

2-11. External 12V dc Source

2-12. The external 12V dc source connects to two screw terminals provided on the rear of the 2166A. The decal on the bottom of the unit defines their location and polarity. The external source should be capable of supplying at least 400 mA at 11V dc.

2-13. RACK INSTALLATION

2-14. The 2166A is designed for field and bench-top use or for installation in a standard 19-inch equipment rack using an accessory rack-mounting kit. Kits are available for left, right, center or side-by-side mounting of the 2166A. Information about the rack mounting accessories is given in Section 6 of this manual, Option and Accessory Information.

2-15. OPERATING FEATURES

2-16. The location of all 2166A controls, indicators and connectors are shown in Figure 2-1, and described in Table 2-1.

2-17. OPERATING NOTES

2-18. The following paragraphs describe various conditions which should be considered before operating the 2166A.

2-19. Option Information

2-20. Supplementary operating instructions are necessary when operating a 2166A which is equipped with one of the available options. Detailed information regarding the operation of each available option is given in Section 6 of this manual, Option and Accessory Information

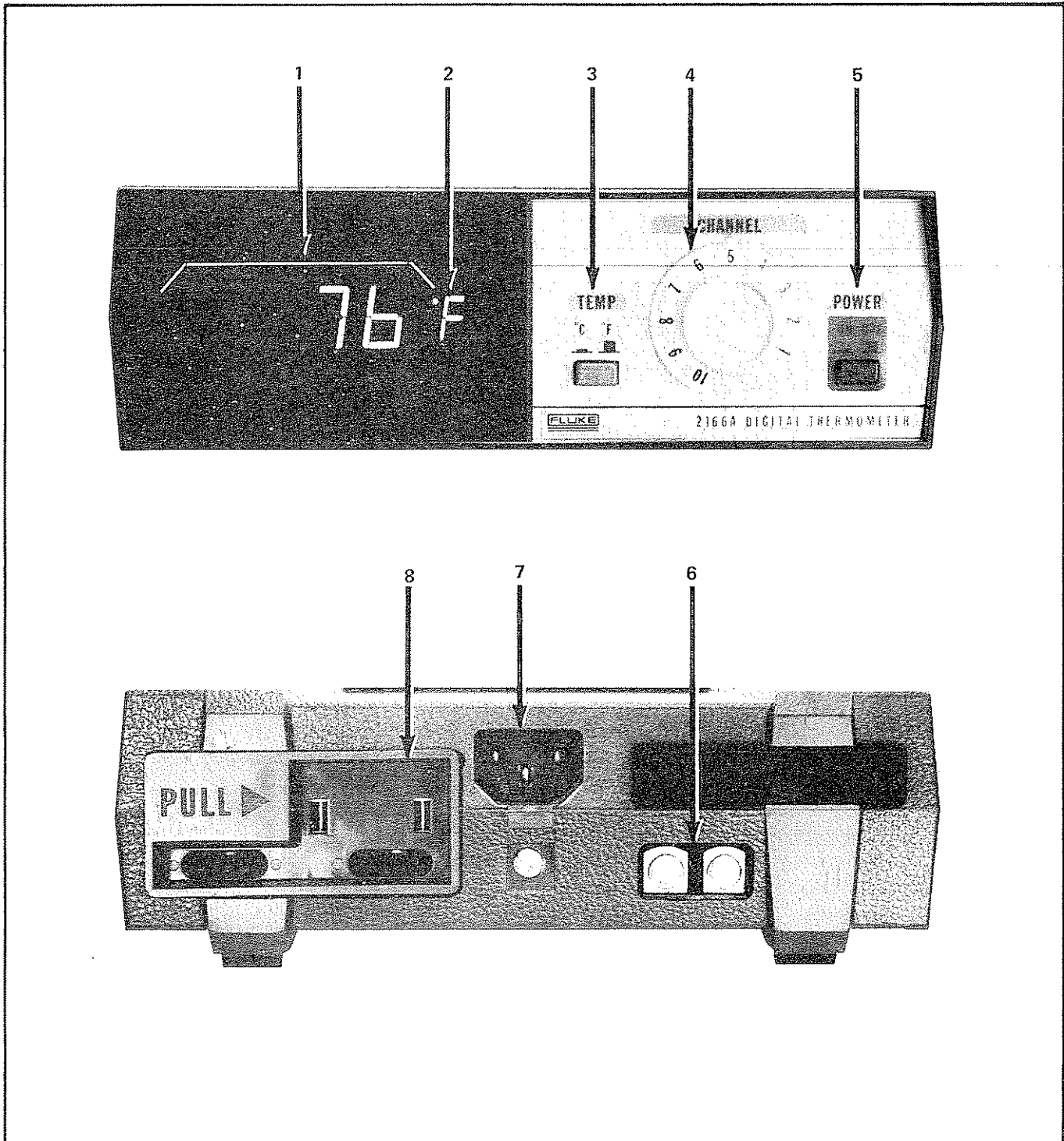

Figure 2-1. 2166A CONTROLS, INDICATORS AND CONNECTORS

Table 2-1. 2166A CONTROLS, INDICATORS AND CONNECTORS

REF. NO.	NAME	FUNCTION
1	Digital Display	Displays a four digit readout of the measured input temperature. Leading-zero suppression is also included. A minus sign is displayed for negative temperature measurements. The absence of a polarity sign indicates a positive temperature measurement.
2	Temperature Scale Indicator	Displays the temperature scale represented by the digital display data; °C or °F.
3	TEMP Scale Switch	Selects the temperature scale for the digital display. When the switch is depressed (IN), the °C scale is selected. The °F scale is selected when the switch is released (OUT).
4	CHANNEL SELECT Switch	Selects 1 of 10 possible thermocouple inputs to be used as the thermometer input. The temperature of the selected thermocouple is continuously read and displayed.
5	POWER Switch	Switches the 2166A on or off regardless of the input power source. The instrument is turned-on when the switch is depressed.
6	External 12V dc Input	Provides screw-type input terminals for connecting an external 12V dc power source. The 12V dc connections are not required when the unit is being operated from ac line power.
7	Input Power Connector	Provides the means of connecting the instrument through a power cord to ac line power. Line power is not required when the unit is being operated from an external 12V dc source.
8	Multipoint Input Module	Provides 10 pairs of screw-type input terminals for connecting up to 10 of the same type thermocouples. Slots are provided at the rear of the drawer for strain relief of the thermocouple bundles.

2-21. Fuse Replacement

2-22. The ac line-input section of the 2166A power supply is fuse protected. The fuse is located on the interior of the unit near the power transformer. To access the fuse, disconnect the unit from line power, remove the rear-panel retaining screw located beneath the ac line connector, and pull the case from the instrument. When replacement is necessary, use an MDL (Slo-blo) 1/8A fuse.

2-23. Overload and Open Thermocouple Indication

2-24. The front panel display, in addition to providing a measurement reading, is designed to serve as an overrange or open thermocouple indicator. When the measurement range of the input thermocouple is exceeded, or when the thermocouple inputs are open circuited, the display will blink. The blinking indication does not mean that the instrument is being exposed to a damaging input condition.

2-25. Thermocouple Connections

2-26. The 2166A is capable of monitoring the temperature of 1 of 10 thermocouple probes of the same type. The

probes connect to the unit through a plug-in Multipoint Input Module as shown in Figure 2-2. Ten pairs of screw-type terminals are provided for completing the thermocouple input connections. Each set of terminals is identified by a channel number from 1 to 10 and the attached thermocouple probe assumes that channel number. A particular channel is selected and measured by setting the front panel CHANNEL Select switch to the corresponding channel number.

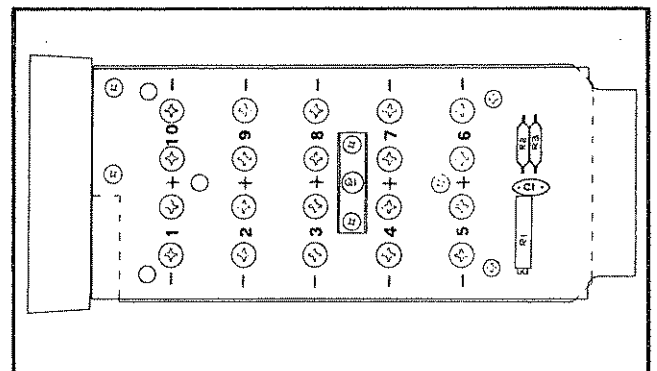

Figure 2-2. MULTIPPOINT INPUT MODULE

2-27. Thermocouple Compatibility

2-28. The 2166A is designed to operate in conjunction with a selected type of thermocouple probe. A decal on the bottom of the unit identifies the compatible thermocouple type. When necessary, the 2166A can be modified in the field to accommodate any one of the following thermocouple types: J, K, T, E, R, S, B or C. Use the following procedure to change thermocouple types:

- a. Refer to Table 1-1 in Section 1 of this manual and order the type select pcb which corresponds to the desired thermocouple type. These pcb's are low-cost items and can be purchased from any one of the John Fluke Technical Service Centers (See Section 7) or from the John Fluke Mfg. Co., Inc.
- b. Disconnect the 2166A from line power.

- c. Remove any ribbon-cable connectors that may be attached to the rear of the 2166A.
- d. Disconnect the power cord from the rear of the unit.
- e. Remove the rear-panel screw located just below the power input connector.
- f. Pull the 2166A front panel and pcb assembly out the front of the plastic case.
- g. Unplug and remove the currently installed type select pcb from the position shown in Figure 2-3, and install the new pcb in its place.

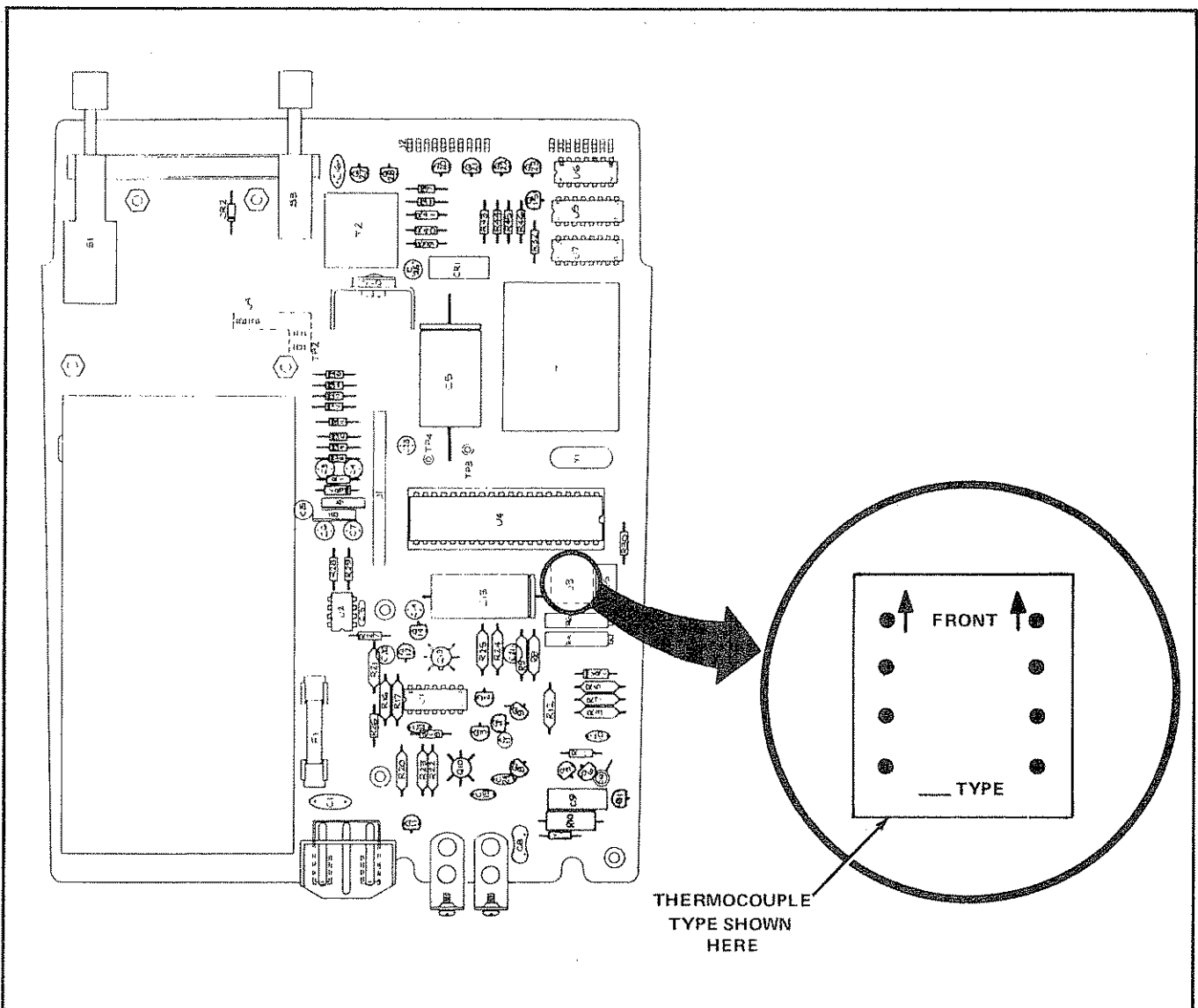

Figure 2-3. TYPE SELECT PCB, LOCATION AND INSTALLATION DETAILS

NOTE

The thermocouple type is etched on the type select pcb's. When properly installed the arrows on the pcb point toward the digital display.

- h. Place a piece of tape over the thermocouple type indications on the bottom-side decal, and mark the new thermocouple type on it.
- i. Connect the unit to line power, and complete the routine calibration procedure given in Section 4 (Maintenance) of this manual.
- j. Install the unit in its case.

2-29. OPERATION

2-30. With reference to previous paragraphs in this section, use the following procedure to operate the 2166A:

- a. Refer to the decal on the bottom of the unit and determine the compatible thermocouple type.
- b. Locate the Multipoint Input Module on the rear of the unit.
- c. Place your forefinger in the recess marked by the arrow and pull the drawer straight out the rear of the unit.

- d. Guide the thermocouple probe connections through one of the module's rear panel openings and connect them to the desired thermocouple channel input terminals, 1 through 10. A total of 10 thermocouples (all the same type) can be simultaneously connected in this manner. Mark each probe so that it can be readily associated with its corresponding channel, 1-10.
- e. Reposition the module in the 2166A and press it firmly into position.
- f. Connect the unit to the appropriate line power, as defined on the bottom-decal, or to an external 12V dc source.
- g. Energize the 2166A by depressing the POWER switch.
- h. Determine the thermocouple probe to be monitored and set the CHANNEL Select switch to the corresponding channel.
- i. Set the TEMP switch to the desired temperature scale, °C or °F.
- j. Refer to Section 6 of this manual for instructions concerning the operation of the -02 and -04 Options.
- k. Expose the thermocouple assigned to the selected channel to a temperature within its specified range (See bottom decal). The probe temperature will be displayed on the front panel.

