

14+
AGES

Air Cushion Ship



Instruction Manual

RC Function:

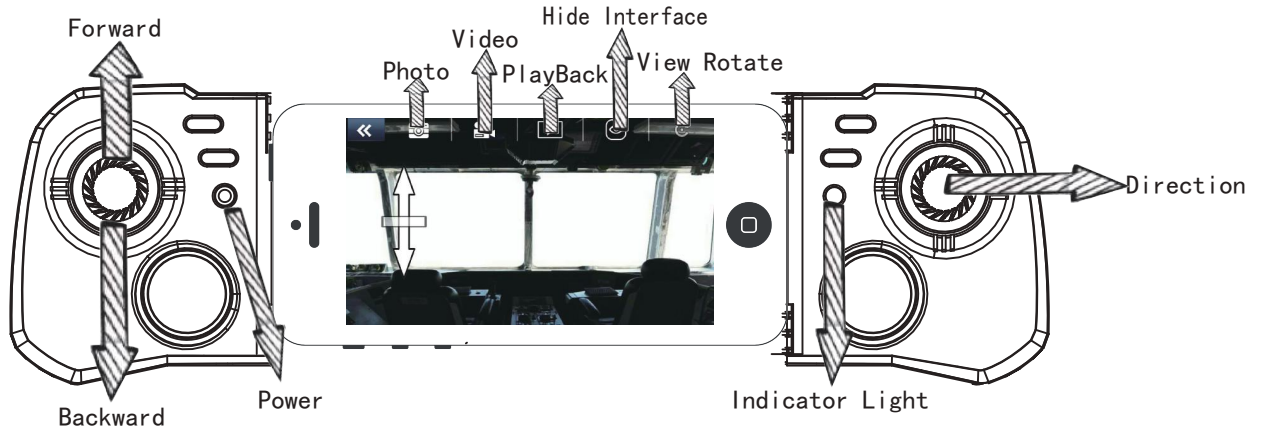

9.6VBatteries

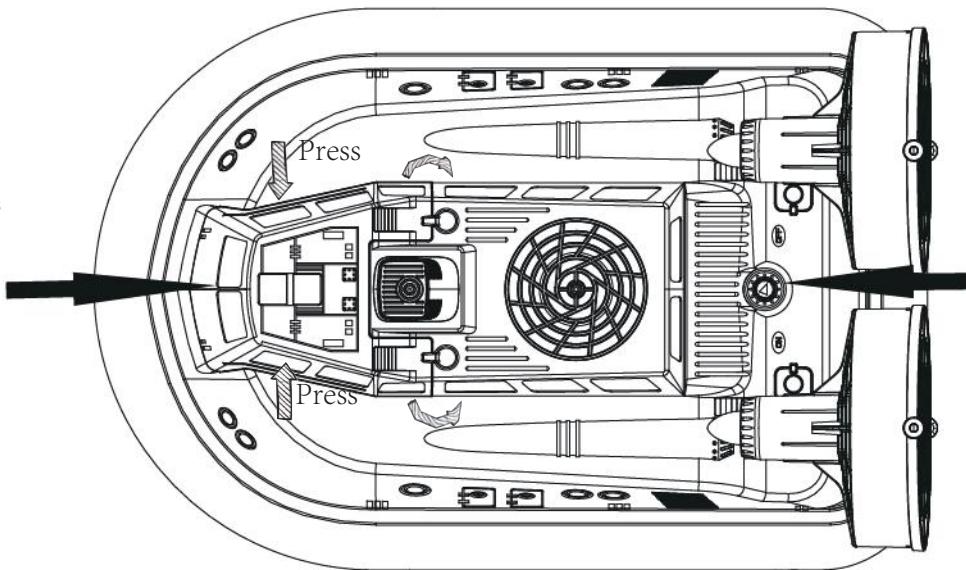
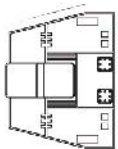

ROTATE

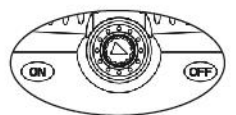

*Please do not charge the battery immediately. It is better that let the battery stand by for several minutes before charging.

*The indicator light on USB will blink in red during charging. Then it will stop blink after finishing charging and the charging time is around 4-6 hours

*The battery will be calorific when charging.

*The battery will recover 90% capacity after charging for 4 hours normally.



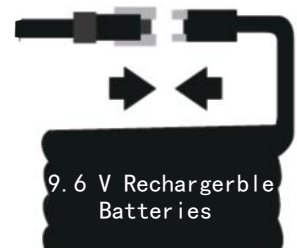







Battery
Interface

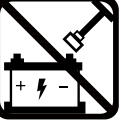

Discard the battery in accordance with the use of national or regional waste cleanup act recycling, do not arbitrarily discarded in order to avoid pollution of the environment.



★ **WARNING!**

 <p>*Please use this product in the shallow water with the adult guardianship.</p>	 <p>*Do not touch the motors to avoid scald.</p>
 <p>*The product contains small parts which can lead to eating or possible choking .</p>	 <p>*Please stop using the remote control in the rang of 5000M in the airport to ensure the aeronautical radio environment safety.</p>
 <p>*Please do not insert the antenna to the battery box or the power output socket.</p>	 <p>*Do not touch the rotating parts to avoid causing harm to the body.</p>
 <p>*Do not touch the motors to avoid scald.</p>	 <p>*Please stop using the remote control when and where has issued the radio control order.</p>
 <p>*Please use this product on the smooth ground or in the calm shallow water.</p>	 <p>*Please do not sink the product completely in water. Pay attention that the product is incomplete waterproof design.</p>
 <p>*It is necessary to regularly check the charger, wire plug, shell and other component. And please stop using the product until the repair if you found any damage.</p>	

Battery Considerations:

- * **9.6V rechargeable battery for the ship.**
- * As the polarity shown in the battery compartment of battery box, please correctly load batteries.
- * Non-rechargeable battery can not be charged.
- * It is necessary for the adult guardianship when charging the rechargeable battery.
- * Take out the battery from the model when charging.
- * Do not mix old and new batteries or different types of batteries.
- * Please choose the battery we suggest or the same type of battery.
- * The exhaustion of battery should be promptly removed. Please also remove the battery if do not use this product in a long time.
- * Please do not short-circuit the power terminal.
- * Please do not connect to the power supply which are higher than the suggested power supply.
- * Please do use the suggested configuration of the charge. And the charger is not a toy.
- * **The battery will recover 90% capacity after charging for 4 hours normally.**

Parameter

Product Code: YL-088	Size:40*30*16
Operation Time: About 10 min	Speed:5-7Km/h
Control Mode:2.4GHz Remote Control & Mobile Control	

Instruction

*Remote Control

- 1、 Load the batteries into the RC (AAA Battery*4). Pay attention to the polarity.
- 2、 Turn on the remote control by press the power button for 3 s.
- 3、 Connect the plug of ship and battery. Then turn on the power switch.
- 4、 Push the left joystick forward, the air cushion ship will run forward. Pull the throttle backward, the ship will go backward.
- 5、 The right joystick will control the direction.
- 6、 The air cushion ship will alarm when the power voltage is lower than 8V. (The thrust fans will rotate discontinuity). Please control the ship come back in time. The air cushion ship will not execute instruction when the power voltage is below 7V.

⚠ **Warning:** Do not release left or right part of remote control suddenly to avoid clamping hands.

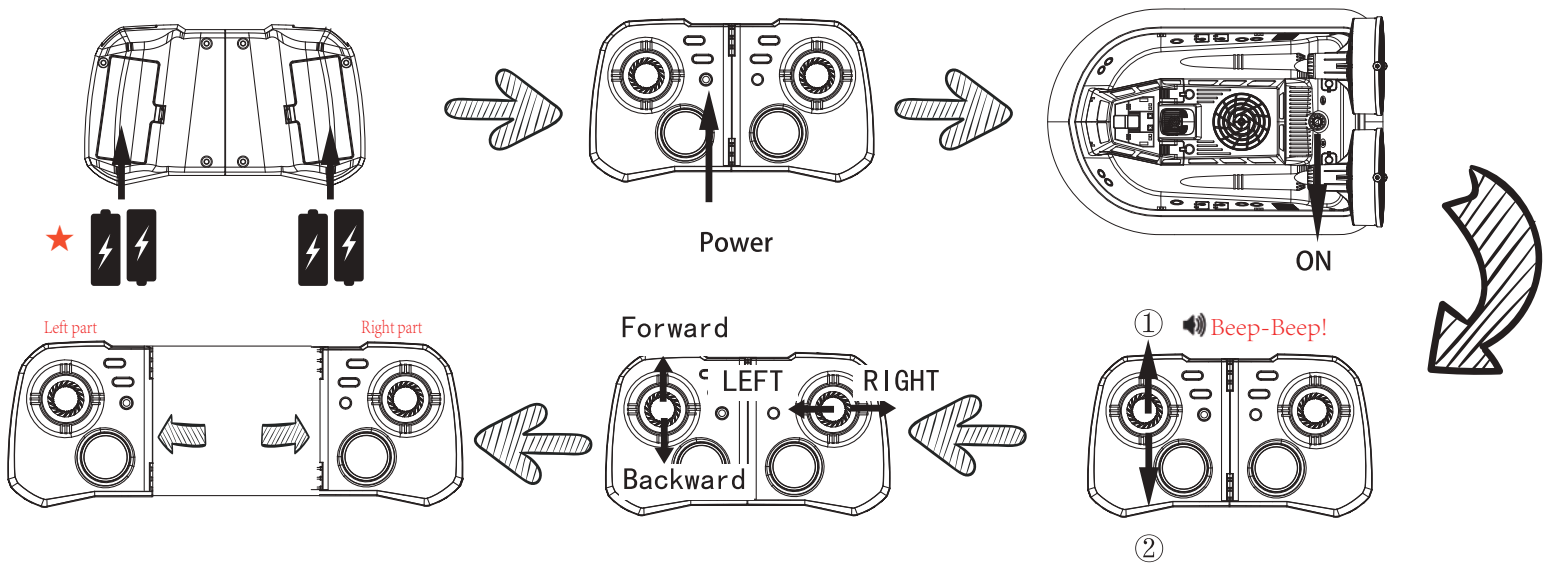

*Mobile APP Control

- 1、 Please download the APP.
- 2、 Turn on the air cushion ship.
- 3、 Connect WIFI SSID: FPV_WIFI_xxxxxx. (No password)
- 4、 Click to enter the APP.
- 5、 The joystick on screen will be hidden if there is no operation or touch.
- 6、 Click the Hide interface and then the cockpit view will hide.
- 7、 The air cushion ship will alarm when the power voltage is lower than 8V. (The thrust fans will rotate discontinuity). Please control the ship come back in time. The air cushion ship will not execute instruction when the power voltage is below 7V.
- 8、 Pay attention to avoid the mobile phone connecting to another WIFI automatically during the operation. It is suggested play this product in the area where less WIFI-interference.



App Store



Google Play

Operator Interface:

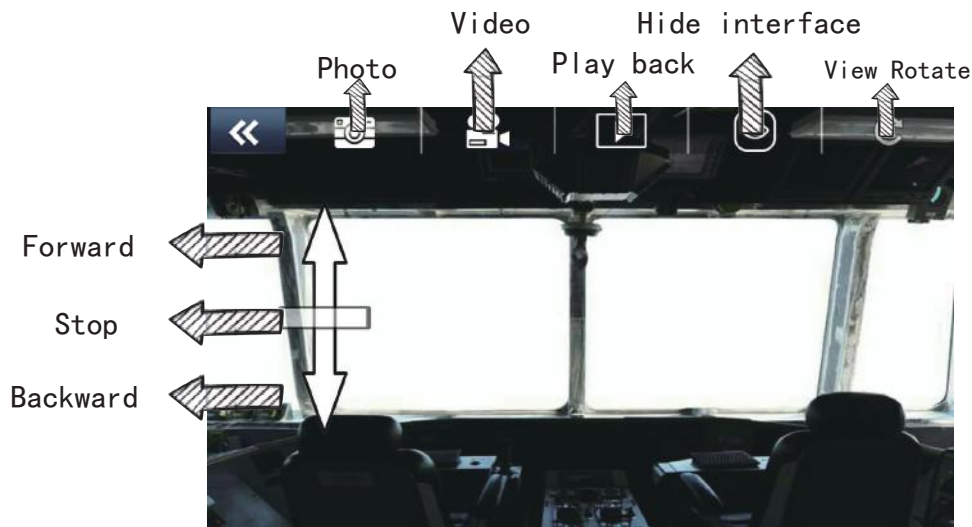

1. Push the throttle stick and then the thrust fans will control the air cushion ship run forward according to the control variables. The thrust fans will stop when the user release the throttle stick.
2. Pull the throttle stick backward and then the thrust fans will control the air cushion ship run backward according to the control variables. The thrust fans will stop when the user release the throttle stick.
3. The air cushion ship will enter the gyro direction mode automatically when the user control it by Mobile APP. Please keep the mobile phone horizontally.
4. The remote control is the priority when turn on the RC and mobile phone simultaneously. The APP on mobile phone can control the photo, video and files except throttle or direction.
5. Please turn off the remote control when the air cushion ship is out of control. Then turn on the remote control again, the air cushion ship will re-connect automatically.
6. The control distance of this product is 20 m. Please pay attention to the control range of the air cushion ship and do not drive it out of this distance to avoid losing control.

FCC STATEMENT

This device complies with Part 15 of the FCC Rules. Operation is subject to the following two conditions:

- (1) This device may not cause harmful interference, and
- (2) This device must accept any interference received, including interference that may cause undesired operation.

Warning: Changes or modifications not expressly approved by the party responsible for compliance could void the user's authority to operate the equipment.

NOTE: This equipment has been tested and found to comply with the limits for a Class B digital device, pursuant to Part 15 of the FCC Rules. These limits are designed to provide reasonable protection against harmful interference in a residential installation. This equipment generates uses and can radiate radio frequency energy and, if not installed and used in accordance with the instructions, may cause harmful interference to radio communications. However, there is no guarantee that interference will not occur in a particular installation. If this equipment does cause harmful interference to radio or television reception, which can be determined by turning the equipment off and on, the user is encouraged to try to correct the interference by one or more of the following measures:

Reorient or relocate the receiving antenna.

Increase the separation between the equipment and receiver.

Connect the equipment into an outlet on a circuit different from that to which the receiver is connected.

Consult the dealer or an experienced radio/TV technician for help.

FCC Radiation Exposure Statement

This equipment complies with FCC radiation exposure limits set forth for an uncontrolled environment. This equipment should be installed and operated with minimum distance 20cm between the radiator & your body

