

User Manual
FIP12/FIP12W
V1.0

Revision Record:

Version	Date	Author	Firmware Version	Applicability
V1.0	2016-01-08	Sherry	V1.0	

Table of Contents

1	<i>Introduction</i>	7
1.1	Thanks for Purchasing FIP12/FIP12W	7
1.2	Package Contents	7
2	<i>Installing</i>	8
2.1	Assembling the Phone and Connecting to the Network	8
2.2	Mounting the Phone to the Wall	8
2.3	Turning on the Phone	8
2.4	Connect to the Internet	9
2.4.1	Via Wired.....	9
2.4.2	Via Wireless.....	9
3	<i>Get Familiar with FIP12/FIP12W</i>	12
3.1	Front Panel	12
3.2	Rear Panel	14
3.3	LEDs Indicator	14
3.4	Get Familiar with LCD	14
4	<i>Menu</i>	16
4.1	Items	16
4.2	How to configuration from Menu	21
5	<i>Using Basic Phone Function</i>	22
5.1	Using the Handset/ Speakerphone/ Headset	22
5.1.1	Using the Handset	22
5.1.2	Using the Speakerphone.....	22
5.1.3	Using the Headset	Error! Bookmark not defined.
5.2	Making Telephone Call	22
5.2.1	Place a Call.....	22
5.2.2	Using Redial Button	22
5.2.3	Dialing from Phonebook	22
5.2.4	Dialing from Call History	23
5.2.5	Using Speed Dial	23
5.2.6	Using Dial Plan	23
5.2.7	Using Delayed hotline.....	24
5.2.8	Answering a Telephone Call.....	24
5.3	Adjusting Call Volume	25
5.4	Black List	25

5.5	Muting a Call.....	Error! Bookmark not defined.
5.6	Placing a Call on Hold.....	26
5.7	Three Way Conference Calls.....	26
5.8	Attended Transfer	26
5.9	Unattended Transfer	27
5.10	Forwarding Calls	27
5.11	Call Waiting	28
5.12	Ending a Call.....	28
5.13	Viewing and Returning Missed Calls.....	28
5.14	Text Message	29
5.14.1	Sending Message.....	29
5.14.2	Reading Message	30
5.15	DND (Do Not Disturb).....	30
6	<i>Using Advanced Phone Functions</i>	31
6.1	Speed Dials	31
6.2	BLF (Busy Lamp Field).....	31
6.3	Shortcut Key.....	32
6.4	Pickup	33
6.5	Call Park.....	34
6.6	MSG	35
6.6.1	Enable and configuration MSG.....	35
6.6.2	Using MSG	36
6.7	Changing the LCD Screen Contrast	36
6.8	Changing Your Ring Tone.....	36
6.9	Setting Your Phone's Date and Time.....	36
6.10	Rebooting Your Phone	37
6.11	Factory default.....	37
7	<i>CONFIGURATION</i>	38
7.1	Web-based Configuration	38
7.2	Login	38
7.3	Webpage	39
7.4	Status.....	41
7.4.1	Basic.....	41
7.4.2	LAN Host.....	42

7.4.3	Syslog.....	42
7.5	Network	43
7.5.1	WAN.....	43
7.5.1.1	Internet Port (WAN).....	43
7.5.2	LAN.....	45
7.5.3	MAC Clone.....	47
7.5.4	VPN.....	47
7.5.5	DMZ.....	48
7.5.6	Wireless.....	49
7.5.6.1	Wireless Settings.....	49
7.5.6.2	Wireless Connection.....	50
7.5.7	DDNS Setting.....	50
7.5.8	Routing.....	51
7.6	SIP Account.....	51
7.6.1	Line 1.....	51
7.6.1.1	Basic.....	51
7.6.1.2	Audio Configuration.....	52
7.6.1.3	Supplementary Services Subscription.....	53
7.6.1.4	Advanced.....	53
7.6.2	Line 2.....	54
	The parameters of Line2 is same as Line1 except the value of Line Enable	54
7.6.3	SIP Settings.....	54
7.6.3.1	SIP Parameters.....	55
7.6.3.2	NAT Traversal.....	55
7.6.4	VoIP QoS.....	55
7.7	Phone.....	56
7.7.1	Preference.....	56
7.7.1.1	Preference.....	56
7.7.1.2	Regional.....	56
7.7.1.3	Call Forward.....	57
7.7.1.4	Miscellaneous.....	57
7.7.2	Multi-Functional Key.....	58
7.7.3	Dial Plan.....	60
7.7.3.1	Parameters and Settings.....	60
7.7.3.2	Dial Plan Syntactic.....	62
7.7.3.3	Example.....	63
7.7.4	Phone Book.....	64
7.7.4.1	Black List.....	66
7.7.5	Call Log.....	68
7.7.5.1	Redial List.....	68
7.7.5.2	Answered Calls.....	69
7.7.5.3	Missed Call.....	69

7.8	Administration	69
7.8.1	Management	70
7.8.1.1	Time/Date	70
7.8.1.2	Password Reset	71
7.8.1.3	Web Access	72
7.8.1.4	System Log Setting	73
7.8.1.5	Factory Defaults	74
7.8.2	Firmware Upgrade	74
7.8.3	Provision	74
7.8.4	SNMP	76
7.8.5	TR069	76
7.8.6	Diagnosis	77
7.8.7	Operation Mode	78
8	Trouble Shooting	78
8.1	No Operation after Power On	78
8.2	Long Time Stop at “Initializing Network”	78
8.3	No Dial Tone	78
8.4	Can not Make a Call	79
8.5	Can not Receive Any Phone Call	79
8.6	No Voice during an Active Call	79
8.7	Can not connect to the configuration Website	79
8.8	Forget the Password	80

1 Introduction

1.1 Thanks for Purchasing FIP12/FIP12W

Thank you for purchasing FIP12/FIP12W. The FIP12/FIP12W which has 4 lines is a full-featured VoIP (Voice over Internet Protocol) phone that provides voice communication over an IP network.

This phone functions not only much like a traditional phone, allowing to place and receive calls and enjoy other features that traditional phone has, but also it own many data services which you could not expect from traditional telephone.

This guide will help you easily use the various features and services available on your phone.

The FIP12/FIP12W, which has a 3dBi internal antenna for 802.11n 1T1R, supports wireless.

1.2 Package Contents

Your package includes the following:

- ◆ One FIP12/FIP12W IP Phone Unit
- ◆ Handset and handset cord
- ◆ Headset
- ◆ One universal power adapter
- ◆ One Ethernet cable
- ◆ Wall-mounting screw pack

2 Installing

2.1 Assembling the Phone and Connecting to the Network

- 1) Plug one end of the coiled phone cord into the left side of the phone base.
- 2) Plug the other end of the handset cord into the jack at the bottom of the handset.
- 3) If you are using an external power source, push the power cord into the power supply, and plug the power supply into the phone base unit.

Note: Use only the power supply that came with the phone.

- 4) Plug the Ethernet cable into **Internet port** in the rear side of the base station. Plug the other end of the Ethernet cable into your already prepared network connection.

2.2 Mounting the Phone to the Wall

- 1) Complete the assembly instructions.
- 2) Attach two appropriate screws to the wall. Leave 1/4 distance from the wall. This allows you to slide the mounting brackets on to the screws.

Push down slightly to lock the phone in place.

2.3 Turning on the Phone

This section assumes that the correct connections have been made.

- 1) Check whether the Internet port is well connected.
- 2) Plug the AC power adapter into the electrical outlet.
Note: Use only the adapter that came with the phone.
- 3) The LCD will firstly display “**Welcome**” and all of the lights on the phone will flash.
- 4) Next, the LCD display “**Initializing Network**”.
- 5) After the sequence, the phone will display date & time, lines status for the phone, and FIP12/FIP12W is started normally.

Note: If the phone does not provide this screen, re-confirm installation and connections. If these are incorrect, try unplugging the phone and plugging it back in again. If you still don't see the display, then contact your Phone Administrator or service provider.

2.4 Connect to the Internet

You can connect the FIP12/FIP12W to the Internet via wired and via wireless.

2.4.1 Via Wired

Step 1. Check FIP12/FIP12W have powered on correctly.

Step 2. Plug the Ethernet cable into **Internet port** in the rear side of the base station. Plug the other end of the Ethernet cable into your already prepared network connection.

Step 3. After the sequence, the IP Address of Internet port will appear at the bottom of the LCD.

2.4.2 Via Wireless (FIP12 do not support wireless)

You can configuration wireless from LCD menu and from webpage.

From LCD menu:

Step 1. Press the  button, and then select **13Wireless** using the **UP and DOWN button**.

Step 2. Choose **2Wireless Connection** and you can view the wireless then FIP12/FIP12W can connect to.

Step 3. Highlight one network using the **UP and DOWN button**, and press the **softkey button under link** to connect.

Note: If the Wi-Fi need authentication, choose the authentication and fill in the password.

Step 4. Press the **softkey button under ok** to confirm connecting.

Step 5. If the AP has connected, the wireless icon in LCD will display linked.

From webpage:

Step 1. Login the web and then open **Network/Wireless** webpage.

[Status](#) | [Network](#) | [SIP Account](#) | [Phone](#) | [Administration](#)

[WAN](#) | [LAN](#) | [MAC Clone](#) | [VPN](#) | [DMZ](#) | [Wireless](#) | [DDNS](#) | [Routing](#)

Wireless Settings

Wireless Settings

Country Region: EU(1-13)

Internet Connection Type: Automatic Configuration - DHCP

DNS Type: Auto

Primary DNS: 0 . 0 . 0 . 0

Second DNS: 0 . 0 . 0 . 0

Wireless Connection

Wireless Connection

Connection Status: Disconnected

SSID	Authentication	Encryption	Status
FLYINGVOICE_IP542N	WPAPSK	AES	
Wireless_AP081658	WPAPSK	AES	
BJ_JRHY	WPA1PSK/WPA2PSK	AES	
t-broadF2F9	WPA1PSK/WPA2PSK	AES	

Step 2.Highlight one Wi-Fi and the words will get larger, following is one example:

SSID	Authentication	Encryption
anyway	OPEN	NONE
E3CALL_SZ	WPA1PSK/WPA2PSK	TKIP/AES
T	home	TKIP/AES

[Connect](#) [Refresh](#)

Step 3.Press the [Connect](#) button to connect to the E3CALL_SZ.

Step 4.If the Wi-Fi need authentication, choose the authentication and fill in the password, then choose the [OK](#) button to connection

SSID	Authentication	Encryption
anyway	OPEN	NONE
E3CALL_SZ	WPA1PSK/WPA2PSK	TKIP/AES
T	home	TKIP/AES

Authentication:

Encryption: TKIP AES

Password:

Step 5.If the AP have connected, then connection status will change like following picture and the icon of wireless will display linked.

Wireless Connection

Connection Status: Connected (AP: E3CALL_SZ[00:21:F2:01:37:31])

3 Get Familiar with FIP12/FIP12W

3.1 Front Panel

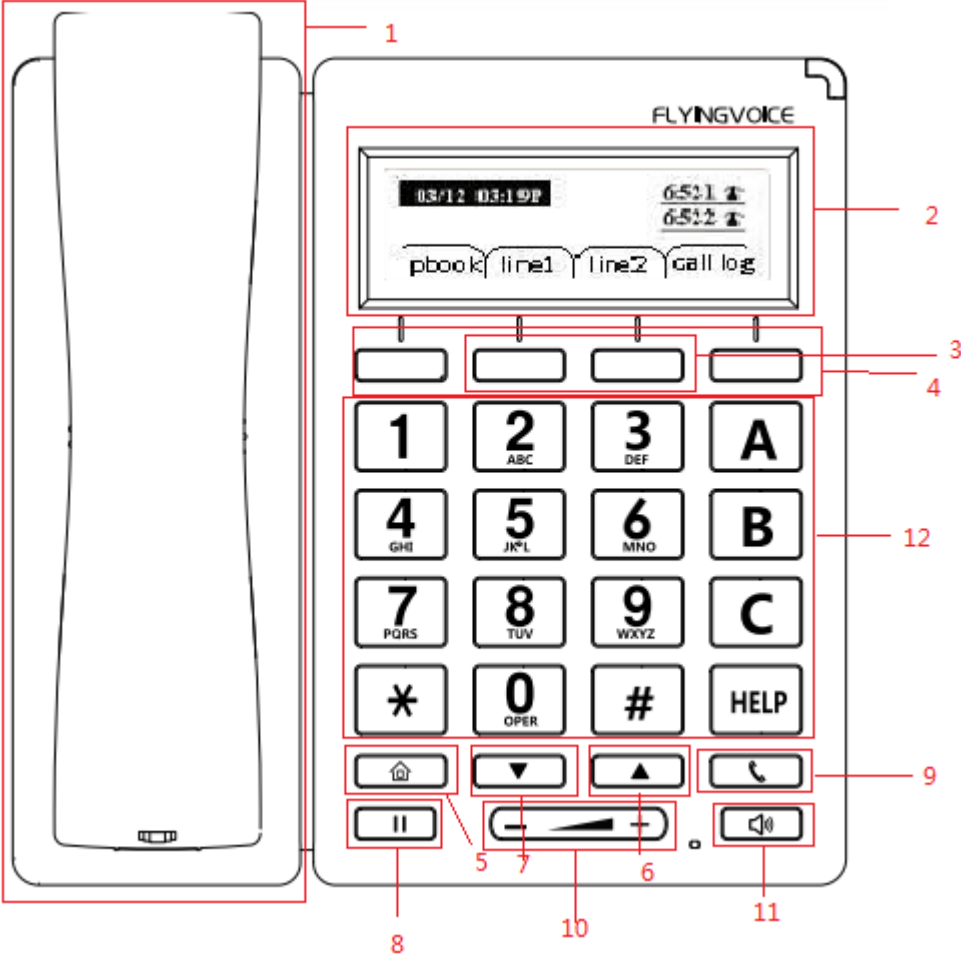
Front Panel	No.	Part Name	Description of function
 <p>Picture 1</p>	1	Handset top cradle	For the placement of handset (Receiver end)
		Hook switch	For hang-up and hang-off of handset
		Cradle latch	To prevent the handset from dropping when it is wall-mounted.
		Handset bottom cradle	For the placement of handset (Transmitter end)
		Handset cord port	RJ-11 jack on the left side of the IP phone
		Headset wire port	RJ-11 jack on the bottom of the handset
		Headset	To mount mouthpiece and earpiece on the single handle.
	2	LCD screen	The LCD screen is for displaying your settings, such as phone number, line status and so on.
	3	Line Keys	<p>In standby: These keys are used as line keys; you can press the line button to select the corresponding line, and then user can make call or do other functions. The LEDs under the keys used to display the status of each extension, please refer to 3.3 LCD indicator</p>

	4	Soft keys	These keys are used as soft keys. These can be used for item selection or control on the LCD screen. The softkey' function depends on their corresponding content displayed on the LCD at that time.
	5	Menu	Press it to access to menu items: such as phonebook, multi-functional key, and call history and so on.
	6	UP	To scroll up or turn up the volume
	7	DOWN	To scroll down or turn down the volume
	8	Hold	The Hold key is used to hold the current call, press it again to release the hold function.
	9	Redial	The Redial key is used to redial the last dialed number automatically.
	10	volume	Add or reduce the volume
	11	Handsfree	Press it to use Handsfree
	12	Numeric Keypad	Enters numeric digits for initiating a call or for entering configuration information.

3.2 Rear Panel

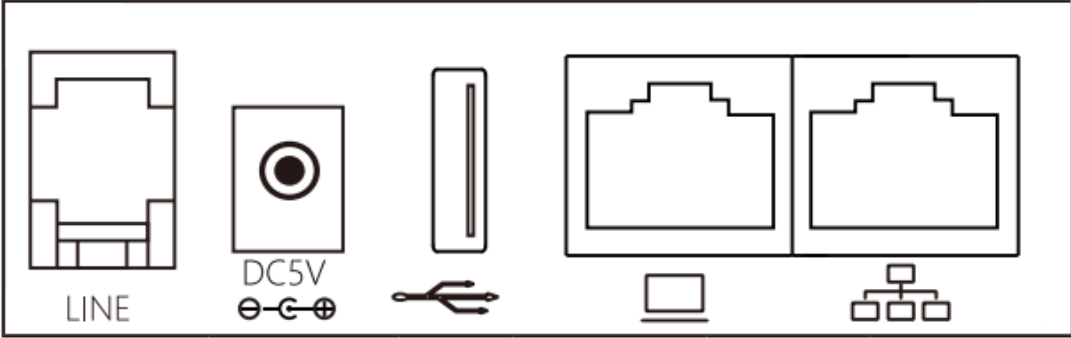
Rear Panel	Part Name	Description of function
	Line	Connect to PSTN
	USB	Use the USB for storage
	DC 5V	Power port
	PC	Connects to a PC.
	Internet	Connects to the Ethernet switch, router or Internet.

3.3 LEDs Indicator

	Color	Status	Description
LED	●	ON	The phone is in the initialization process.
	●	Blink(300 ms)	Telephone is ringing (any line).
	●	Blink (1 second)	The phone receives the short message or voice information.
	○	OFF	The phone is in power-off / free / busy / call on hold / mute calls status

3.4 Get Familiar with LCD

LCD	Name	Description of function
-----	------	-------------------------

	<p>Date</p>	<p>To display the current date.</p> <p>Date format is mm/dd</p>
	<p>Time</p>	<p>To display the current time.</p> <p>Time format is mm:ss (A or P)</p>
	<p>Phone Numbers</p>	<p>To display the phone number of lines.</p>
	<p>Lines</p>	<p>To display the status of lines.</p> <p>The icon means unregistered.</p> <p>The icon mean registered.</p>
	<p>Softkey Function</p>	<p>To display the current softkey function.</p>
	<p>Softkey Buttons</p>	<p>You can use the softkey button to highlight the item displayed on the LCD screen and then configuration.</p> <p>One button directs to one softkey function, the blue line in the left picture displays the corresponding relationship.</p>

4 Menu

User can use **MENU**, **soft key** and  button to browse, modify and configuration the phonebook, multi-functional keys, network, accounts, factory default and so on.

4.1 Items

The table below lists Menu items which FIP12/FIP12W included:

Main menu (LCD display)	Menu Items (LCD display)	Submenu Items (LCD display)	Explanation
1Phonebook	1.1NewEntry		User can view, add, edit, and delete phonebook using the five softkey. User can also make call, and send text message directly using the five softkey. The Max records are 100.
3Call History	3.1RedialList		To list the latest 100 records of called call, answered call and missed calls.
	3.2Answered Calls		
	3.3Missed Calls		
4Text Message	4.1SEND		User can send message according to prompt.
	4.2Recived Box		To list the latest 100 records of received message and sent message.
	4.3SentBox		
5BlackList	5.1NewEntry		To configuration the blacklist, max record is 100.
6Preferences	6.1Call Waiting		To enable or disable call waiting
	6.2Auto Answer		To enable or disable auto answer.



7Ring Tone	7.1Bell Type1		Choose the ring tone from Bell Type1- Bell Type15.
	7.2Bell Type2		
	7.3Bell Type3		
	7.4Bell Type4		
	7.5Bell Type5		
	7.6Bell Type6		
	7.7Bell Type7		
	7.8Bell Type8		
	7.9Bell Type9		
	7.1Bell Type10		
8Volume Setting			To turn up or turn down volume.
9Accounts (need password)	9.1Line 1	9.1.1Account Enable	To enable/disable line1.
		9.1.2Password	To set password of line1.
		9.1.3Account	To set account of line1.
		9.1.4Display Name	To set display name of line1.
		9.1.5Phone Number	To set the phone number of line1.
		9.1.6SIP Domain Name	To set the SIP domain name or domain name of line1.
		9.1.7SIP Server	To set the SIP server IP address of line1.
		9.1.8SIP Server Port	To set the SIP server port of line1.
		9.1.9Outbound Proxy	To set the outbound proxy IP address or domain name of line1.

		9.1.10Outbound Proxy Port	To set the outbound proxy port of line1.
	9.2Line 2	Same to 9.1	
10Call Forward	10.1CFWD AllNumber		To set the destination phone number of CFWD AllNumber
	10.2CFWD Busy Number		To set the destination phone number of CFWD Busy Number
	10.3CFWD No AnsNumber		To set the destination phone number of CFWD No AnsNumber
	10.4CFWD No AnsDelay		To set the destination phone number of CFWD No AnsDelay
11Time/Date	11.1Time(H:m:s)		
	11.2Date(m/d/y)		
12Voice Mail	12.1Line 1	12.1.1MWI Enable	To enable or disable voice mail of line1
		12.1.2Voice Mail Number	To set the voice mail number of line1.
	12.2Line 2	Same to 12.1	
13Network	13.1WAN Connection Type		To view the current Internet port's connection type, or to change the Internet port connection type from Static, DHCP and PPPoE.
	13.2CurrentIP		To view the current Internet port IP address, or to change the Internet port IP address.

	13.3CurrentNetmask		To view the Current Netmask, or to change the Current Netmask.
	13.4CurrentGateway		To view the Current Gateway, or to change the Current Gateway.
	13.5DNS1		To view the DNS1, or to change the DNS1.
	13.6DNS2		To view the DNS2, or to change the DNS2.
	13.7Enable WAN Login		To enable or disable user login webpage from Internet port.
	13.8Web Port		To view the Web Port, or to change the Web Port.
	13.9SIP QoS		To view the SIP QoS, or to change the SIP QoS.
	13.1RTP QoS		To view the RTP QoS, or to change the RTP QoS.
	13.11Data QoS		To view the Data QoS, or to change the Data QoS.
	13.12VLANID		To view the VLANID, or to change the VLANID.
	13.13802.1p Priority		To view the802.1p Priority, or to change the802.1p Priority.
14Wireless	14.1Wireless Settings	14.1.1WifiConnection Type	Choose the connection type from Static and DHCP
		14.1.2CurrentIP	To view the current Internet port IP address, or to change the Internet port IP address.
		14.1.3CurrentNetmask	To view the Current Netmask, or to change the Current Netmask.
		14.1.4CurrentGateway	To view the Current Gateway, or to change the Current Gateway.
		14.1.5DNS1	To view the DNS1, or to change the DNS1.
		14.1.6DNS2	To view the DNS2, or to change the DNS2.
	14.2Wireless	AP	To display the name of all APs.

	Connection		
15Product INFO	15.1Product Name		To view the current information of Product Name, Software Version, Hardware Version and MAC Address.
	15.2Software Version		
	15.3Hardware Version		
	15.4MAC Address		
16Status	16.1Account1Status		To view the current information about the status of account1/2/3/4/5.
	16.2Account2Status		
17Reboot			To reboot FIP12/FIP12W.
18Factory Default			To set FIP12/FIP12W factory default.
19Set Password			To reset password. The password of LCD is same as the one of Webpage. Default is null.
20LCD Contrast			To view and change the contrast of LCD.
21Login/Logout			Press it to logout LCD. FIP12/FIP12W will memory the password if user has input the password when access to 9Accounts and FIP12/FIP12W will not request the password if user access to it again. Press 20Login/Logout to erase memory, and then user should input password when user access to 9Accounts again.

4.2 How to configuration from Menu

- 1) When the phone is on-hook, press the  button to enter Main menu.
- 2) Use the **Numeric Keypad** to input the digit or character
- 3) Press the **en softkey button** to change the input method between digit, capital letter and small letter.
- 4) Use the **up** and **down softkey button** to scroll up and scroll down. Configuration the item or sub-item according to the prompt.
- 5) Press the **ok softkey button** to confirm.
- 6) Press the **save softkey button** to save changes.
- 7) Press  button or **delChr softkey button** to delete one digit or a character.
- 8) Press the **cancel softkey button** to cancel changes and back to the up level.
- 9) The password which need when access to Accounts item is the same as the one of admin mode when login Web, default is null.

5 Using Basic Phone Function

5.1 Using the Handset/ Speakerphone/ Headset

5.1.1 Using the Handset

To place and answer calls using the handset, simply lift the handset.

5.1.2 Using the Speakerphone

To place and answer calls using the speaker, press the **speaker** button. The green light behind the button will illuminate.

5.2 Making Telephone Call

5.2.1 Place a Call

You can place a call by:

Step 1. Lifting the handset and dialing phone number, followed by the # or wait 5 seconds, FIP12/FIP12W will dial out the phone number

Step 2. Connect the headset, press the headset button and dial phone number, followed by the # or wait 5 seconds, FIP12/FIP12W will dial out the phone number

Step 3. Press the speaker button and dial phone number, followed by the # or wait 5 seconds, FIP12/FIP12W will dial out the phone number

5.2.2 Using Redial Button

To redial the last number called:

Lift the handset or press speakerphone or press headset, and then press the **redial** button; the number will be automatically dialed.

5.2.3 Dialing from Phonebook

Adding a phonebook

Below are the steps to add a phonebook in menu, User can also add phonebooks from you PC using FIP12/FIP12W Web Interface,

Step 1.Press  button access to the menu items, and use the softkey button to choose **1.Phonebook**

Step 2.Add one phonebook according to the prompt, press the **en softkey button** to change the input method between digit, capital letter and small letter.

Using phonebook:

Press  button to access to the menu items, and use the softkey button to choose **1.Phonebook**, and then highlight the phonebook you want to call, press the **dial softkey button** to make call immediately.

5.2.4 Dialing from Call History

Press  button access to the menu items, and use the **up** and **down button** to choose **3.Call History**, and then highlight the phone number you want to call, press the **dial softkey button** to dial immediately.

5.2.5 Using Speed Dial

Adding a speed dial:

Below are the steps to add a speed dial from menu, User can also set speed dial from you PC using FIP12/FIP12W Web Interface.

Step 1.Press  button access to the menu items, and use the **up** and **down button** to choose **2. Multi-Function Key**

Step 2.Configuration one **Multi-Function Key** to speed dial according to the prompt.

Making speed dial:

Press the Multi-Function Key corresponding to speed dial to make call immediately.

5.2.6 Using Dial Plan

Adding one dial plan:

Step 1.Open **Phone/Dial Plan** webpage

Step 2. Add one dial plan, user can refer to 7.6.3 Dial Plan

Using dial plan to make call:

Dial the phone number according to one dial plan.

5.2.7 Using Delayed hotline

Add the delayed hotline from **SIP Account/Account1/2** webpage, **User** column, below is one example:

Step 1. Open **SIP Account/Account1/2** webpage, **User** column

Step 2. Fill in the delayed hotline number, user can also add the delayed time.

Example 1: Delayed Hot Line: set the delayed hotline number is 111.

Example 2: Delayed Hot Line: set the delayed hotline number is 111 and delayed time is 4 seconds.

5.2.8 Answering a Telephone Call

When a call is incoming, the associated line button will flash and the phone will ring.

You can receive the call by:

Step 1. Pressing the corresponding line button or

Step 2. Pressing the speakerphone, or

Step 3. Lifting the handset, or

Step 4. Auto-answer: if auto-answer is enabling, FIP12/FIP12W will answer the phone automatically when there is a call incoming

Enable auto-answer: press  button to access to the menu items, then use the **up** and **down button** to choose **6 Reference**, set auto-answer enable according to the prompt.

Note: user can also enable auto-answer in **Phone/Preference** webpage, **miscellaneous** column.

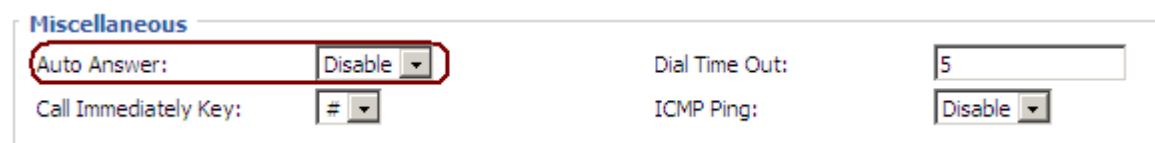

Miscellaneous

Auto Answer:	Disable	Dial Time Out:	5
Call Immediately Key:	#	ICMP Ping:	Disable

5.3 Adjusting Call Volume

From menu:

Step 1. Press  button, and then choose **volume**.

Step 2. Press **up** and **down button** to turn up or turn down volume.

Using multi-functional key:

Step 1. Choose two multi-functional key (assuming the two multi-functional keys are Exp Key 1 and Exp Key 2), and configuration as follows:

Current Key Board Basic Board ▼

Key	Type	Mode	Line	Phone Number	Pickup Code
Exp Key 1	Shortcut Key ▼	Volume+ ▼	<input type="text"/>	<input type="text"/>	<input type="text"/>
Exp Key 2	Shortcut Key ▼	Volume- ▼	<input type="text"/>	<input type="text"/>	<input type="text"/>

Step 2. Press **Save Settings** to save changes and user can see the corresponding LED is solid green.

Step 3. Press the **Exp Key1** button to turn up volume, press the **Exp Key 2** button to turn down volume.

5.4 Black List

If user added a black list, FIP12/FIP12W will forbid the phone number incoming.

Adding a black list:

There are two ways to add black list, one is from menu, and the other is from your PC to use FIP12/FIP12W's webpage.

From menu:

Step 1. Press  button, and then choose **5black list**.

Step 2. Choose **NewEntry**, and then add one black list according to the prompt.

From Webpage:

Step 1. Log on the web, open **Phone/Phonebook** webpage, **Black List** column.

Step 2.Refer to the **7.6.4.1 Black List** to add blacklist.

5.5 Placing a Call on Hold

When FIP12/FIP12W is during one active call:

Step 1.Pressing the  button to put the active call on hold, then you will hear a dial tone, the remote party will hear the hold music

Step 2.User can input the phone number to make call

Step 3.Pressing the  button again to release the previously Hold state and resume the bi-directional media.

5.6 Three Way Conference Calls

Step 1.To initiate a conference call, press the  button during an active call and the first call is placed on hold, and you will hear a dial tone.

Step 2.Dial the second person's telephone number

Step 3.After the second person answers the call, press **CONF softkey button** to start the conference call; all three parties will be participating in a conference call.

Note: If you hang up firstly, the other two parties will be disconnected; if one party hangs up firstly, you can go on talking with the other party.

5.7 Attended Transfer

You call the person to whom you are transferring the call and speak to them before transferring the call:

Step 1.To initiate a transfer; press the  button during an active call. This places the first call on hold and you will hear a dial tone.

Step 2.Dial the second person's telephone number.

Step 3.When the second person answers, you can have a private conversation with the second person without the first person hearing it.

Step 4.To connect the call to the second person, press the **XFER softkey button** to complete the transfer. You will be disconnected from the call.

Step 5.If you hang up during the call with the second person before pressing **XFER softkey button**, the transfer is not completed; this only ends

the call with the second person, and you can press the  button to continue the first call.

5.8 Unattended Transfer

You can transfer an active call to a third party without announcement.

Step 1.To initiate an unattended (blind) transfer; press the **XFER softkey button** during an active call. The first call is placed on hold and you will hear a dial tone.

Step 2.Now dial the second person's telephone number with immediately ending char “#”, FIP12/FIP12W will transfer phone automatically and you will be disconnected from the call.

5.9 Forwarding Calls

You can forward all calls, forward calls when the phone is busy or forward calls when there is no answer.

Below are the steps to configuration call forward from menu. You can also set call forwarding options from your PC using the IP Phone Web Interface.

From menu:

Step 1.Press the  button.

Step 2.Select **10Call Forward** and choose one type of call forwarding.

- CFWD All Number—Forwards all calls to a single number immediately when there is an incoming call.
- CFWD Busy Number—Forwards all calls to another number when the phone is busy.
- CFWD No Ans Number—Forwards calls to another number if there's no answer at your phone.
- CFWD No Ans Delay—the seconds to delay forwarding calls, if there is no answer at your phone.

Step 3.Fill in the call forwarding number.

Step 4.Press the **save softkey button** to save changes.

5.10 Call Waiting

Before using call waiting, you should enable it firstly, and default is enabling.

During an active call:

Step 1.If call waiting is enabled, call waiting alerts you with ringing if there is another call is incoming, and the associate line button will change to red blinking, press the line key of the second call to answer the second call with the first call holding, pressing the line button of the first call to back to the first call with the second call holding.

Step 2.If the call waiting is off, new calls would be rejecting and the new caller will hear busy tone when you are on another call.

Enable Call Waiting:

You can turn call waiting on or off from menu in **Menu/6References** item.

And user can also enable call waiting by using your PC to open **SIP Account/Account X (1/2)** webpage, **User** column.

5.11 Ending a Call

To end a handset call, hang up the handset.

To end a speakerphone call, press the speaker button.

To end a headset call, press the headset button.

5.12 Viewing and Returning Missed Calls

The LCD screen on your IP phone will notify you like the following picture if a call came in that was unanswered.

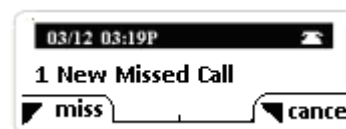

To return a missed call:

- If the LCD screens shows a missed call:

Step 1.press the **softkey button under miss** to view the call.

Step 2. Press the **softkey button under dial** to return the missed call.

- If the LCD screen does not show a missed call, you can return a call from the Missed Call list:

Step 1. Press the  button.

Step 2. Then selects **3Call History**.

Step 3. Then selects **Missed Calls**.

Step 4. Choose the call you want to return and press Dial.

To view a list of all missed calls:

- If the LCD screen shows a missed call, press the **softkey button under miss** to view a list of missed calls.
- If the LCD screen does not show a missed call:

Step 1. Press the  button.

Step 2. Then selects **3Call History**.

Step 3. Then selects **Missed Calls**.

5.13 Text Message

5.13.1 Sending Message

Step 1. Press  button, and then choose **4Text Message** by using the **up button** or the **down button**.

Step 2. Press the **select softkey button** to enter to **1SEND** item.

Step 3. Press the **select softkey button** to edit message.

Note: When inputting text, use the **en softkey button** to change the input method among numbers, capital and lowercase English letters, **en** stands lower case, **EN** stands capital letter, and **num** stands digit

Step 4. Press the **ok softkey button** to input **receivers' phone number**.

Note: FIP12/FIP12W support group mails, user can send one message to 10 friends or family one a time;

Press the **ok softkey button** to access to configuration the next receiver's phone number;

You can select one number in phonebook by pressing the **pbook softkey button**.

If user has configuration the phone numbers which you want to send, press the **ok softkey button** twice to access to the next item (**Sender number**).

Step 5. Set Sender phone number, default is line1's phone number.

Step 6. Press the **select softkey button** to start sending message.

5.13.2 Reading Message

Step 1. Press  button, and then choose **4Text Message** by using the **up button** or the **down button**.

Step 2. Press the **select softkey button** to enter to **2Recived Box** item or **Sent Box** item.

Note: In Received Box are messages have received from others including new messages and old messages. The ones in Sent Box are messages have sent out.

Step 3. Press the **select softkey button** to access to the next item. Choose the message you want to read by using the **up button** or the **down button**.

5.14 DND (Do Not Disturb)

Use the Do Not Disturb feature to prevent incoming calls from ringing your phone.

To enable Do Not Disturb, use the softkey under the Not disturb.

6 Using Advanced Phone Functions

6.1 Speed Dials

Creating Speed Dials:

Following are the steps to creating speed dials in webpage; you can also creating it from LCD Menu.

Step 1. Access to web, and then open **Phone/Multi-Functional Key** webpage

Step 2. Then configures one Exp key to speed dial, and then choose the line and fill in the phone number. The following picture is a setting example:

Key	Type	Mode	Line	Expansion	Pickup Code
Exp Key1	Disable				
Exp Key2	Disable				
Exp Key3	Disable				
Exp Key4	Disable				

Step 3. Press **Save Settings** button to save changes and then press **Reboot** button to make changes effective.

Using Speed Dials:

Step 1. Press the configured Exp Key 1 to call 111 or press Exp Key 2 to call 112 immediately.

6.2 BLF (Busy Lamp Field)

Your system administrator may configure your phone so that you can monitor other user's phones from your phone. User can create BLF from **Menu/Multi-functional key** or from your PC in **Phone/Multi-Functional Key** webpage.

If this feature is configured, some multi-functional key buttons on your phone are assigned to display the status of another user's phone. For example, if your one multi-functional key is configured to display Bob's phone line, the associate multi-functional key shows you the status of

his phone line:

- ◆ Green: Line is idle.
- ◆ Red (steady): Line is active or in use.
- ◆ Red (blinking): Line is ringing.



In addition, if you have configured the pickup code in BLF, you can press the same multi-functional button to pick up a ringing call at his extension.

The example below describes the steps to configuration the pickup in BLF from Webpage, user can also configuration from **MENU**.

Configure the pickup code in BLF:

Step 1. Access to web, and then open **Phone/Multi-Functional Key** webpage

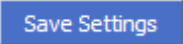
Step 2. Then configures one Exp key to BLF, and set **Pickup Code** (you can get the pickup code from your administrator). The following picture is a setting example based on Asterisk

Step 3. Press  button to save changes and then press  button to make changes effective.

Key	Type	Mode	Line	Expansion	Pickup Code
Exp Key 1	BLF		Line 2	003	*8

To pick up a ringing call:

Step 1. Assuming a ringing call at **003** and the associate LED is blinking.

Step 2. Press **line2 button**, and then press the **Exp key 1** button to pickup the call.

6.3 Shortcut Key

The steps below described how to configuration the shortcut key from Webpage, user can also configuration from **MENU**.

Creating Shortcut Key:

Step 1. Access to web, and then open **Phone/Multi-Functional Key** webpage

Step 2. Then configures the Exp keys to shortcut key, and set as you need. The following picture is a setting example:

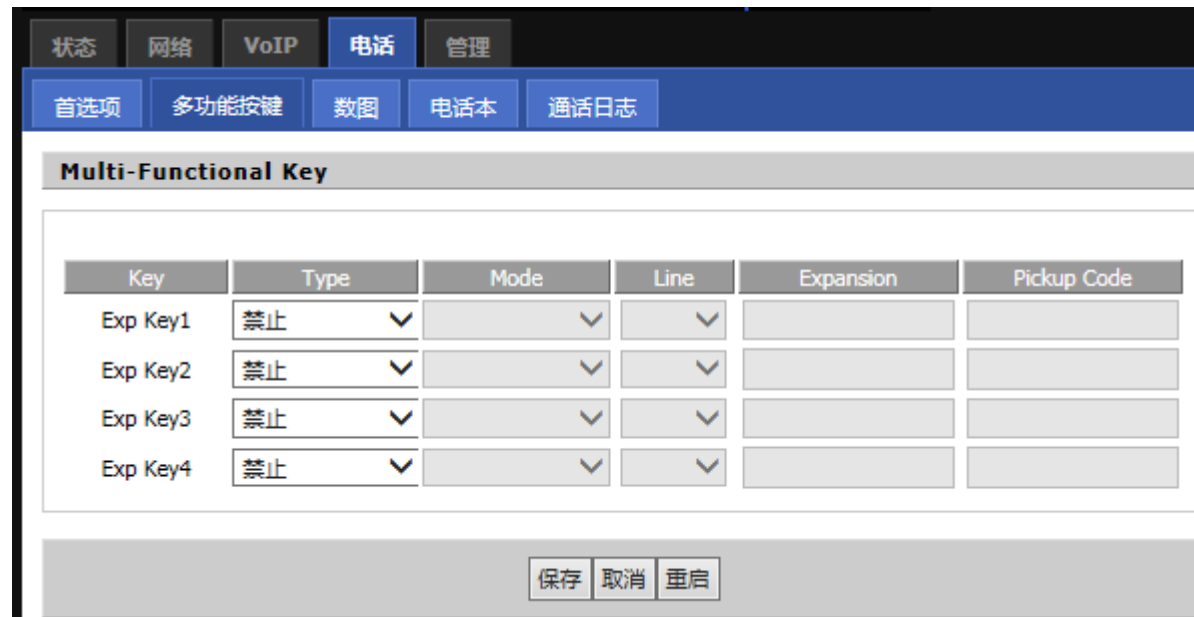

Step 3. Press **Save Settings** button to save changes and then press **Reboot** button to make changes effective.

Using shortcut Key:

Press the Exp Key 1, then the LCD will display the phonebook item immediately, and user can configuration it, the steps are same as configuration from menu.

Press the next Exp Keys, and the LCD will display the corresponding item immediately, and user can also configuration it.

6.4 Pickup

The function of pickup is similar to the speed dial.

The example below describes the steps to configuration the pickup from Webpage, user can also configuration from **MENU**.

Adding pickup:

Step 1. Log in the web, open **Phone/Multi-functional Key** webpage.

Step 2. Choose one Exp key (assuming is Exp Key 3), and configuration as follows, user can refer to **7.6.2 Multi-functional Key**:

Exp Key 3

Step 3. Press **Save Settings** button to save changes and then press **Reboot** button to make changes effective.

Using pickup:

Press the **Exp Key 3** button (the configured multi-functional key) to ring 010235689 quickly.

6.5 Call Park

Call Park is a feature of some telephone systems that allows a person to put a call on hold at one telephone set and continue the conversation from any other telephone set.

During an active call, pressing one preprogrammed multi-functional key button to transfer the current telephone conversation to an unused extension number and immediately puts the conversation on hold. The telephone system will then display the extension number of the parked call so that the call can later be retrieved.

If no one picks up the parked call within the set time, the telephone system may ring back the parked call. This transfers the parked call back to the person who originally parked the call.

The example below describes the steps to configuration the call park from Webpage, user can also configuration from **MENU**.

Adding Call Park:

Step 1. View the parking settings in server, below is an example in **TrixBOS**

Parking Lot Configuration

Parking Lot Options

Enable Parking Lot Feature	<input checked="" type="checkbox"/>
Parking Lot Extension:	<input type="text" value="70"/>
Number of Slots:	<input type="text" value="8"/>
Parking Timeout:	<input type="text" value="45 seconds"/>
Parking Lot Context:	<input type="text" value="parkedcalls"/>

Step 2. Log in the web, open **Phone/Multi-functional Key** webpage.

Step 3. Choose one Exp key (assuming is Exp Key 6), and configuration as follows, user can refer to **7.6.2 Multi-functional Key**:

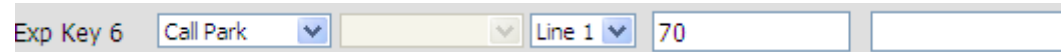

Step 4. Press **Save Settings** button to save changes and then press **Reboot** button to make changes effective.

Using Call Park:

Step 1. During an active call (assuming party 1 (FIP12/FIP12W)'s phone number is 6221, party 2's phone number is 111)

Step 2. Party 1 press the **Exp Key 6** button (the configured multi-functional key) to park the current conversation and listen the voice prompt patiently,

Step 3. Party 3 dialing **71** using another phone to retrieve the call with party 2.

6.6 MSG

Voice Mail service must be available on your network to use this feature.

6.6.1 Enable and configuration MSG

There are two ways to enable MSG, one is from menu, and the other is from your PC to use FIP12/FIP12W's webpage.

From Menu:

Step 1. Press **Menu** button to enter menu items and then choose **12Voice Mail**

Step 2. Highlight the line you want to configuration, and then select it

Step 3. And then use the **softkey buttons** to configuration it according to the prompt



Step 4. Press the **save softkey button** to save the changes

From Webpage:

Step 1. Log into Web, open **Account X(1/2)/User webpage**.

Step 2. Enable **MWI Enable** and fill in the **Voice Mailbox Numbers** (get the number from your phone administrator), below is a settings example based on Asterisk.

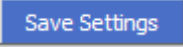
User			
Supplementary Services			
Call Waiting:	Enable		
Dial Prefix:		Delayed Hot Line:	
MWI Enable:	Enable	Voice Mailbox Numbers:	*97

Step 3. Press  button to save changes, then the notice **Please REBOOT to make the changes effective!** will appear, press  button to make changes effective.

6.6.2 Using MSG

To access you voice mail box, press the **MSG** button.

Then user can listen to the new voice mail or old voice mail or reply voice mail according to the voice prompt.

6.7 Changing the LCD Screen Contrast

Step 1. Press the  button, scroll to **19LCD Contrast**, and press the **Select softkey button** to access.

Step 2. Use the **up** and **down buttons** to adjust the screen contrast. Press the **Up** button to increase the contrast. Press the **Down** button to decrease the contrast.

Step 3. Press the **save softkey button** to save.

6.8 Changing Your Ring Tone

To change a ring tone:

Step 1. Press the  button.

Step 2. Select **7 Ring Tone**.

Step 3. Use the **up** and **down buttons** to highlight the ring tone. Press the **select softkey button** to choose the highlighted ringtone.

6.9 Setting Your Phone's Date and Time

The date and time for your phone normally come from the phone server. However, if you need to change some date and time

parameters, you can follow these steps:

Step 1. Press the  button, select **Time/Date**.

Step 2. Choose **date** to adjust date; enter the date in the following format: **mm/dd/yy**.

Step 3. Choose **time** to adjust time; enter the time in the following format: **hh/mm/ss**.

Step 4. Press the **ok softkey button** to save the changes.

6.10 Rebooting Your Phone

This setting is to configure and troubleshoot the network. You should not change these settings unless directed to by your Administrator as this can negatively affect your phone's function.

To reboot your phone:

Step 1. Press the  button.

Step 2. Scroll to **16Reboot**; press the **select softkey button** to access to reboot item.

Step 3. Then a notice “**Confirm System Reboot**” will appear, press the **ok softkey button** to confirm rebooting.

6.11 Factory default

There two ways to make factory default: in menu and using website.

In menu:

Press  button and choose **17factory Default**, then a notice will appear, press the **ok softkey button** to continue.

Using Website:

Step 1. Access to website, open **Administration/Management** webpage;

Step 2. Press the **factory default** button at the bottom of the webpage;

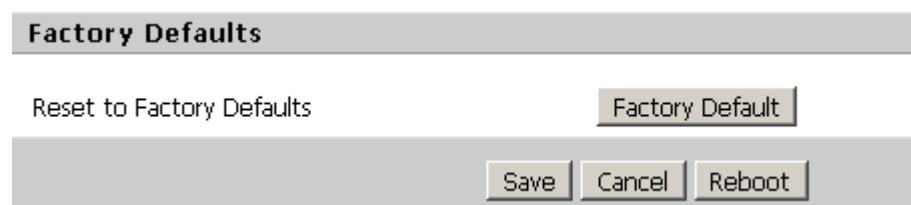

Step 3.Waiting about 5 seconds, the red notice **Please REBOOT to make the changes effective!** will appear, and then press **Reboot** button to reboot FIP12/FIP12W.

Note: If you choose factory default, you will return the phone to the original factory settings and will erase all current settings, including the directory and call logs.

7 CONFIGURATION

7.1 Web-based Configuration

This section will show you how to configure your FIP12/FIP12W using the web-based configuration interface. The default network settings are the following:

Default Internet Connection Type: **DHCP**

Default PC Port Connection Type: **Bridge**

Default user name of admin mode: **admin**

Default user name of user mode: **user**

Default password of Web: **(null)**

Default Web login port: **8080**

Web Idle Timeout: **5 min**

Username	<input type="text"/>	
Password	<input type="password"/>	<input type="button" value="Login"/>

7.2 Login

To access the phone through a web browser

Step 1.Setup FIP12/FIP12W correctly

Step 2.Lookup the Internet IP Address in the left side of LCD

Step 3. Enter “**http://Internet IP Address:8080**” in the address field of the browser.



Step 4. Type “**admin**” or “**user**” for the User Name, click on the **Login** button to access the configuration page

There are two levels of web configuration: one “user” ID level that can view just some portion in the web, and the other “admin” ID level that can view and configure all settings in the web-based configuration interface. To use “admin” ID for login, please contact your administrator, supplier or service provider.

7.3 Webpage

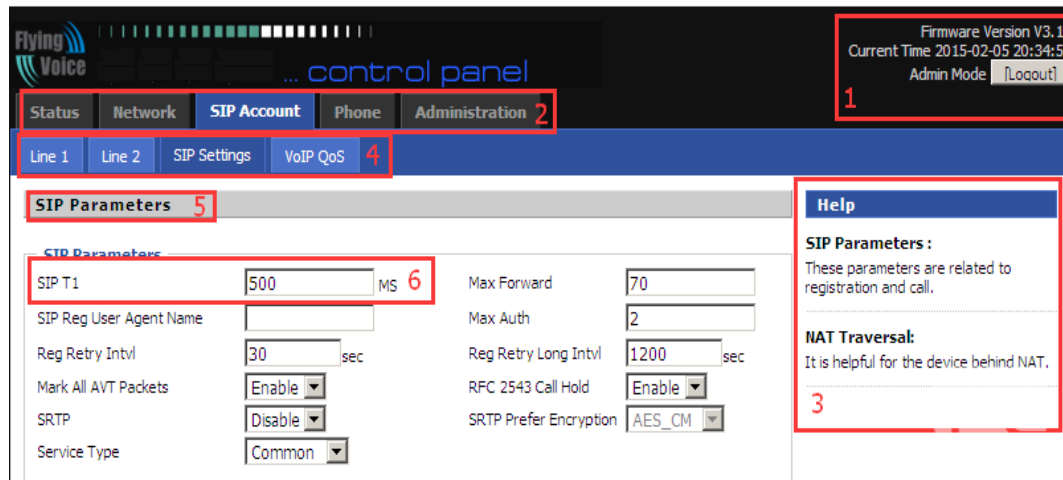
No.	Name	Description
1	main information	Display the firmware version, DSP version, Current Time, and administration mode. Press Logout button to logout.
2	navigation bar	Click navigation bar, many sub-navigation bar will appear in the place 4.
3	Help	Display the main information for configuration; user can get help from it directly.
4	sub-navigation bar	Click sub-navigation bar to enter to configuration webpage
5	configuration title	The configuration title
6	configuration bars	The configuration bars
		◆ Every time making some changes, user



		<p>should press the button to confirm and save the changes.</p> <p>◆ After pressing the button, the red <i>Please REBOOT to make the changes effective!</i> will appear to notice user to reboot.</p>
	<p></p>	<p>To cancel the changes.</p>
	<p></p>	<p>Press it to reboot FIP12/FIP12W</p>

7.4 Status

7.4.1 Basic

This webpage displays the basic status of your FIP12/FIP12W, including the information about product information, SIP account status, network status, VPN status, PC port status and system status.

Click **Refresh** button to refresh the status.

The screenshot shows the 'Flying Voice' control panel interface. At the top right, it displays 'Firmware Version V3.10', 'Current Time 2015-03-02 15:50:03', and 'Admin Mode' with a 'Logout' button. The main navigation bar includes 'Status', 'Network', 'SIP Account', 'Phone', and 'Administration'. Below this, there are sub-tabs for 'Basic', 'LAN Host', and 'Syslog'. The 'Status' page is divided into several sections:

- Product Information:** A table listing details such as Product Name (IP622W), Internet(WAN) MAC Address (00:21:F2:08:9C:59), PC(LAN) MAC Address (00:21:F2:08:9C:58), Hardware Version (V1.2), Loader Version (V2.57), Firmware Version (V3.10(201502040020)), and Serial Number (FLY4814C000298).
- Line Status:** A table showing Line 1 Status as 'Registered 622' and Line 2 Status as 'Disable'.
- Network Status:** A section for 'Internet Port Status' with a table of parameters: Connection Type (DHCP), IP Address (192.168.10.101), Subnet Mask (255.255.255.0), Default Gateway (192.168.10.1), Primary DNS (192.168.10.1), Secondary DNS (8.8.8.8), WAN Port Status (100Mbps Full), and WIFI Port Status (Disconnected).
- TR069_VOICE_INTERNET Vlan Status:** A table with similar network parameters as the Internet Port Status section.
- VPN Status:** A table showing VPN Type as 'Disable', Initial Service IP, and Virtual IP Address.
- PC Port Status:** A table showing IP Address (192.168.1.1), Subnet Mask (255.255.255.0), and Port Status (100Mbps Full).
- System Status:** A table showing Current Time (2015-03-02 15:50:03) and Elapsed Time (4 hours, 7 mins).

A 'Refresh' button is located at the bottom center of the page.

7.4.2 LAN Host

This page displays the status about the client which connected to the FIP12/FIP12W's LAN port

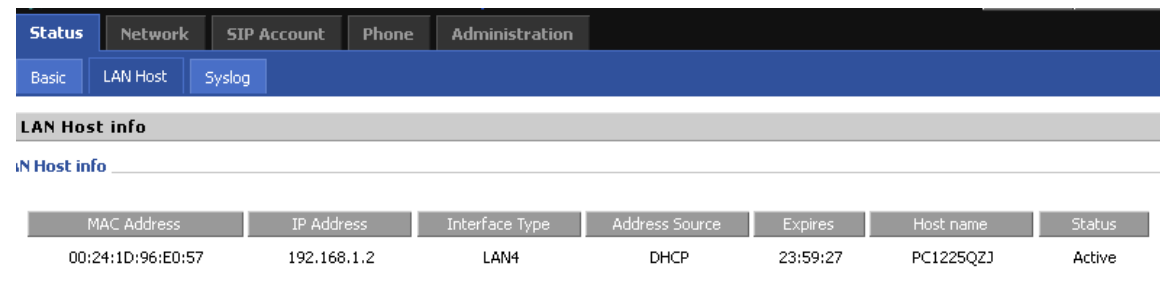

The screenshot shows a web interface with a navigation bar at the top containing tabs for Status, Network, SIP Account, Phone, and Administration. Below this is a sub-navigation bar with tabs for Basic, LAN Host, and Syslog. The main content area is titled "LAN Host info" and contains a table with the following data:

MAC Address	IP Address	Interface Type	Address Source	Expires	Host name	Status
00:24:1D:96:E0:57	192.168.1.2	LAN4	DHCP	23:59:27	PC1225QZJ	Active

7.4.3 Syslog

This page displays the log of system.

User can press **Clear** button to clear all information,

Click **Refresh** button to refresh syslog.

Click **Save** button to save syslog.

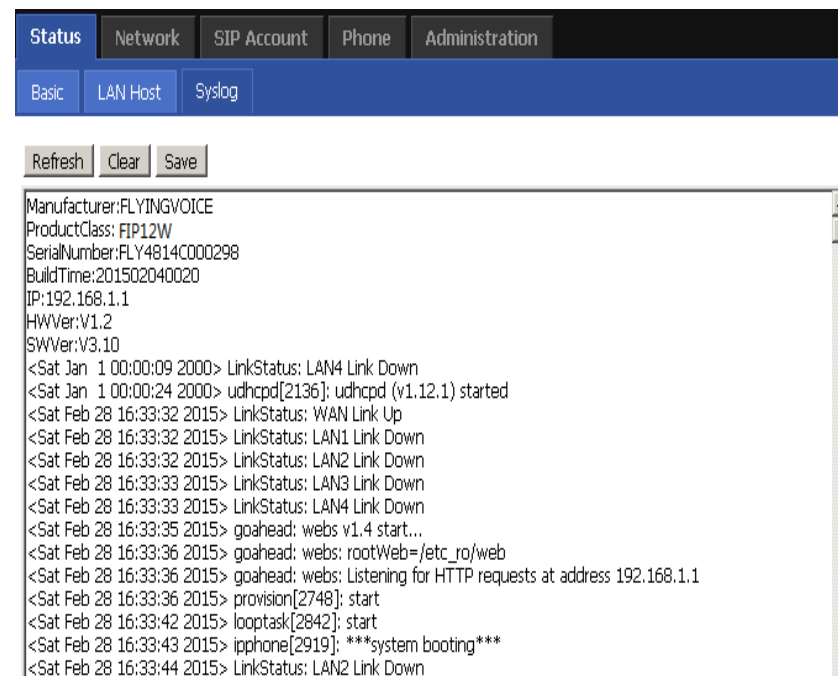

The screenshot shows a web interface with a navigation bar at the top containing tabs for Status, Network, SIP Account, Phone, and Administration. Below this is a sub-navigation bar with tabs for Basic, LAN Host, and Syslog. The main content area contains three buttons: Refresh, Clear, and Save. Below the buttons is a text area displaying the following syslog output:

```
Manufacturer:FLYINGVOICE
ProductClass: FIP12W
SerialNumber:FLY4814C000298
BuildTime:201502040020
IP:192.168.1.1
HWVer:V1.2
SWVer:V3.10
<Sat Jan 1 00:00:09 2000> LinkStatus: LAN4 Link Down
<Sat Jan 1 00:00:24 2000> udhcpd[2136]: udhcpd (v1.12.1) started
<Sat Feb 28 16:33:32 2015> LinkStatus: WAN Link Up
<Sat Feb 28 16:33:32 2015> LinkStatus: LAN1 Link Down
<Sat Feb 28 16:33:32 2015> LinkStatus: LAN2 Link Down
<Sat Feb 28 16:33:33 2015> LinkStatus: LAN3 Link Down
<Sat Feb 28 16:33:33 2015> LinkStatus: LAN4 Link Down
<Sat Feb 28 16:33:35 2015> goahead: webs v1.4 start...
<Sat Feb 28 16:33:36 2015> goahead: webs: rootWeb=/etc_ro/web
<Sat Feb 28 16:33:36 2015> goahead: webs: Listening for HTTP requests at address 192.168.1.1
<Sat Feb 28 16:33:36 2015> provision[2748]: start
<Sat Feb 28 16:33:42 2015> looptask[2842]: start
<Sat Feb 28 16:33:43 2015> ipphone[2919]: ***system booting***
<Sat Feb 28 16:33:44 2015> LinkStatus: LAN2 Link Down
```

7.5 Network

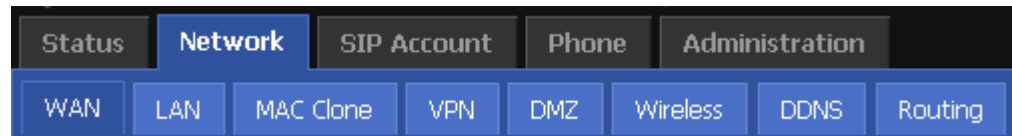

7.5.1 WAN

User can configuration the parameters of Internet Port, PC port and Network Address Server Settings (DHCP). The details are as follows:

7.5.1.1 Internet Port (WAN)

Static:

In static mode, user should fill in the values of IP Address, Subnet Mask, Default Gateway, Primary DNS and Second DNS got from your administration.

Webpage	Field Name	Description	
	Internet Connection Type	Choose Static IP.	
	IP Address	The IP address of Internet port	
	Subnet Mask	The subnet mask of Internet port.	
	Default Gateway	The default gateway of Internet port.	
	Primary DNS	The primary DNS of Internet port.	
	Second DNS	The second DNS of Internet port.	

DHCP:

In DHCP mode, IP phone is a DHCP client.

IP phone will get the IP Address, Subnet Mask and Default Gateway from the DHCP server.

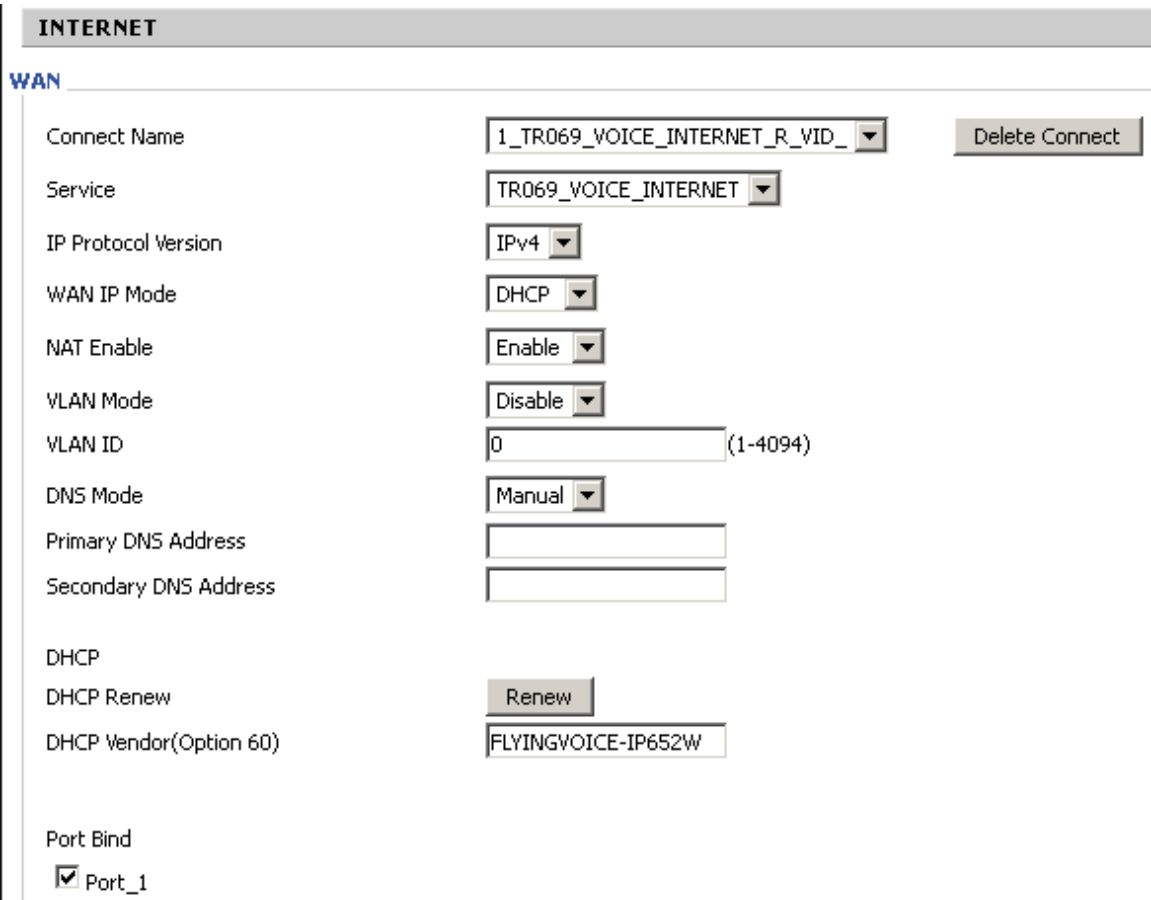
Webpage	Field Name	Description
	Internet Connection Type	Choose Automatic Configuration-DHCP.
	DNS type	<p>Choose DNS type from Manual and Automatic</p> <ul style="list-style-type: none"> ◆ In Manual: user should set the Primary DNS and Second DNS manually. ◆ In Automatic: IP Phone will get the Primary DNS and Second DNS from DHCP Server automatically.

PPPoE:

Webpage	Field Name	Description
	Internet	Choose PPPoE.





INTERNET		Connection Type	
WAN		PPPoE Account	Fill in the PPPoE account which get from Internet Service Provider
Connect Name	1_TR069_VOICE_INTERNET_R_VID_ <input type="button" value="Delete Connect"/>	PPPoE Password	Fill in the PPPoE account get from Internet Service Provider
Service	TR069_VOICE_INTERNET	PPPoE Auto-Dial	If or not enable PPPoE Auto-Dial.
IP Protocol Version	IPv4	DNS Type	Choose DNS type from Manual and Automatic ◆ In Manual: user should set the Primary DNS and Second DNS manually. ◆ In Automatic: IP Phone will get the Primary DNS and Second DNS from DHCP Server automatically.
WAN IP Mode	PPPoE	Primary DNS	The primary DNS of Internet port.
NAT Enable	Enable	Second DNS	The second DNS of Internet port.
VLAN Mode	Disable		
VLAN ID	0 (1-4094)		
DNS Mode	Auto		
Primary DNS Address			
Secondary DNS Address			
PPPoE Account			
PPPoE Password			
Confirm Password			
Service Name			
	Leave empty to autodetect		
Operation Mode	Keep Alive		
Keep Alive Redial Period(0-3600s)	5		
Port Bind			
<input checked="" type="checkbox"/> Port_1			

7.5.2 LAN

Status	Network	SIP Account	Phone	Administration		
WAN	LAN	MAC Clone	VPN	DMZ	Wireless	Routing
PC Port(LAN)						
PC Port(LAN)						
Local IP Address	<input type="text" value="192.168.1.1"/>					
Local Subnet Mask	<input type="text" value="255.255.255.0"/>					
Local DHCP Server	Enable <input type="button" value="v"/>					
DHCP Start Address	192.168.1. <input type="text" value="2"/>					
DHCP End Address	192.168.1. <input type="text" value="254"/>					
DNS Mode	Auto <input type="button" value="v"/>					
Primary DNS	<input type="text" value="192.168.1.1"/>					
Secondary DNS	<input type="text" value="192.168.10.1"/>					
Client Lease Time(0-86400s)	<input type="text" value="86400"/>					
<input type="button" value="DHCP Client List"/>						
DHCP Static Allotment						
	NO.	MAC	IP Address			
	1	<input type="text"/>	<input type="text"/>			
	2	<input type="text"/>	<input type="text"/>			
	3	<input type="text"/>	<input type="text"/>			
DNS Proxy	Enable <input type="button" value="v"/>					

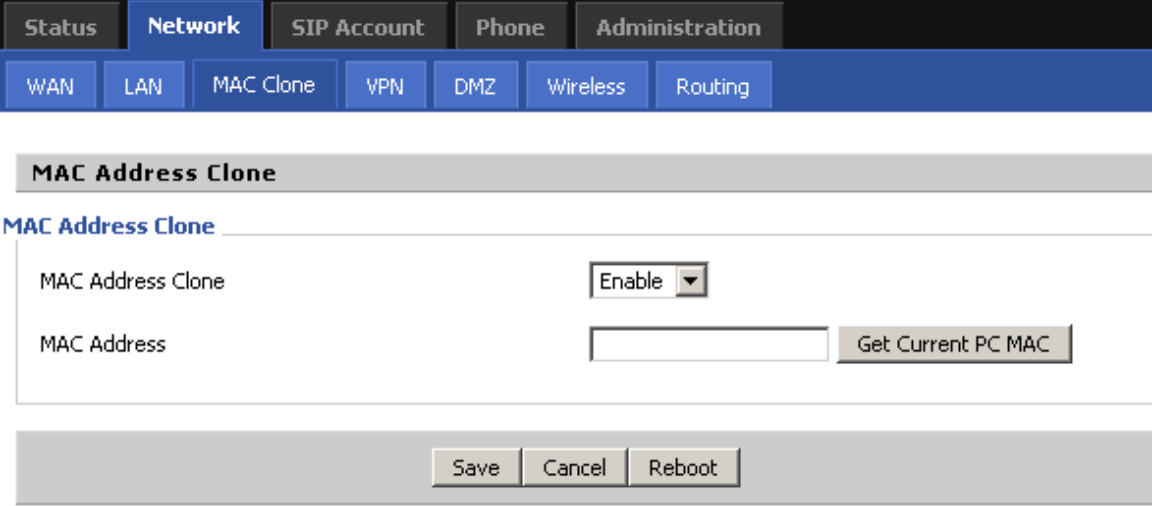
Field Name	Description
Local IP Address	Enter the IP address of the router on the local area network, all the IP addresses of the computers which are in the router's LAN must be in the same network segment with this address, and the default gateway of the computers must be this IP address. (The default is 192.168.1.1)
Local Subnet Mask	Enter the subnet mask to determine the size of the network (default is 255.255.255.0/24)
Local DHCP Server	If or not enable Local DHCP Server
DHCP Start Address	Enter a valid IP address as a starting IP address of the DHCP server, and if the router's LAN IP address is 192.168.1.1, starting IP address can be 192.168.1.2 or greater, but should be less than the ending IP address.
DHCP End Address	Enter a valid IP address as an end IP address of the DHCP server.
DNS Mode	Select DNS mode, options are Auto and Manual: <ol style="list-style-type: none"> 1. When DNS mode is Auto, the device under LAN port will automatically obtains the preferred DNS and alternate DNS. 2. When DNS mode is Manual, the user should manually configure the preferred DNS and alternate DNS
Primary DNS	Enter the preferred DNS address.
Secondary DNS	Enter the secondary DNS address.
Client Lease Time	This option defines how long the address will be assigned to the computer within the network. In that period, the server does not assign the IP address to the other computer.
DNS Proxy	Enable or disable; If enabled, the device will forward the DNS request of LAN-side network to the WAN side network

7.5.3 MAC Clone

Webpage	Description
	<p>MAC is the hardware address of network equipment. Sometimes, network providers may bind network account with the network equipment's MAC address. So you may not pass the provider's authentication when you use a new FIP12/FIP12W. In this case, you can use MAC Clone to copy your PC's MAC address to FIP12/FIP12W's Internet port.</p> <p>MAC is an important parameter for network equipments, so you should make sure that the MAC is right, in order to prevent to make FIP12/FIP12W unusable.</p> <p>You can login FIP12/FIP12W's Web via PC port if you are incautious to make it wrong. And then cloning the right MAC or resume the default settings.</p> <p>Step 1 Press  button to get the PC's MAC address</p> <p>Step 2 Press  to save the changes</p> <p>Step 3. Press  to cancel MAC address clone.</p> <p>Step 4. Press Reboot to reboot FIP12/FIP12W.</p>

7.5.4 VPN

A Virtual Private Network (VPN) is the extension of a private network that encompasses links across shared or public networks like the Internet. In short, by VPN technology, you can send data between two computers across a shared or public network in a manner that emulates the properties of a point-to-point private link.

Webpage	Field Name	Description
	VPN Enable	If or not enable VPN. And user can choose the VPN mode from PPTP and L2TP.
	Initial Service IP	VPN server IP address
	User Name	The user name for authentication
	Password	Password for authentication
	VPN As Default Route	Set the VPN as default route

7.5.5 DMZ

FIP12/FIP12W provides a facility DMZ Host that maps ALL unsolicited data on any protocol to a single host in the LAN. Regular web surfing and other such Internet activities from other clients will continue to work without inappropriate interruption. DMZ Host allows a defined internal user to be totally exposed to the Internet, which usually helps some special applications such as Netmeeting or Internet Games etc.

Webpage	Field Name	Description
	DMZ Enable	If or not enable DMZ
	DMZ Host IP Address	set the IP address of DMZ host

7.5.6 Wireless

7.5.6.1 Wireless Settings

Static:

In static mode, user should fill in the values of IP Address, Subnet Mask, Default Gateway, Primary DNS and Second DNS got from your administration.

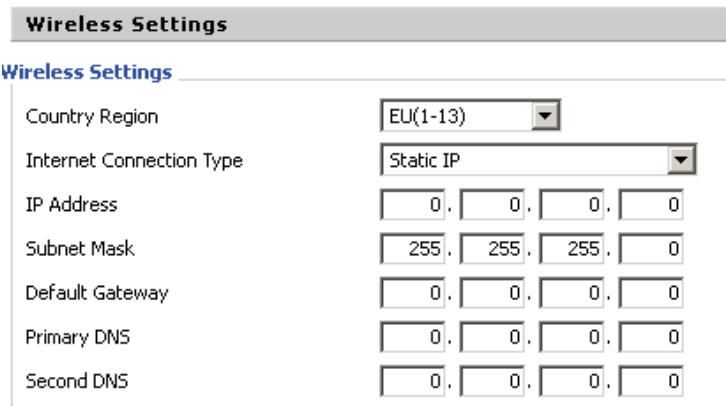
Webpage	Field Name	Description
	Internet Connection Type	Choose Static IP.
	IP Address	The IP address of Internet port
	Subnet Mask	The subnet mask of Internet port.
	Default Gateway	The default gateway of Internet port.
	Primary DNS	The primary DNS of Internet port.
	Second DNS	The second DNS of Internet port.



DHCP:

In DHCP mode, IP phone is a DHCP client.

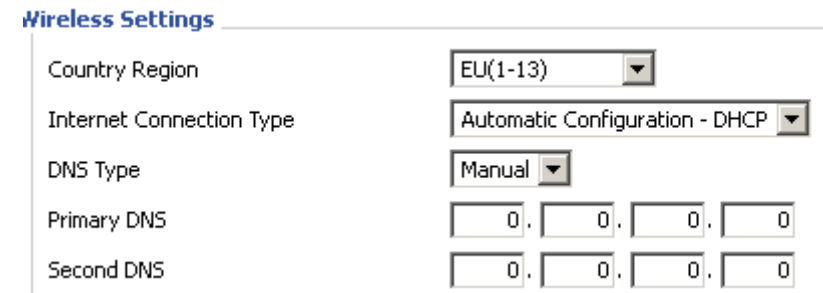
IP phone will get the IP Address, Subnet Mask and Default Gateway from the DHCP server from AP.

Webpage	Field Name	Description
	Internet Connection Type	Choose Automatic Configuration-DHCP.
	DNS type	Choose DNS type from Manual and Automatic <ul style="list-style-type: none"> ◆ In Manual: user should set the Primary DNS and Second DNS manually. ◆ In Automatic: IP Phone will get the Primary DNS and Second DNS from DHCP Server automatically.

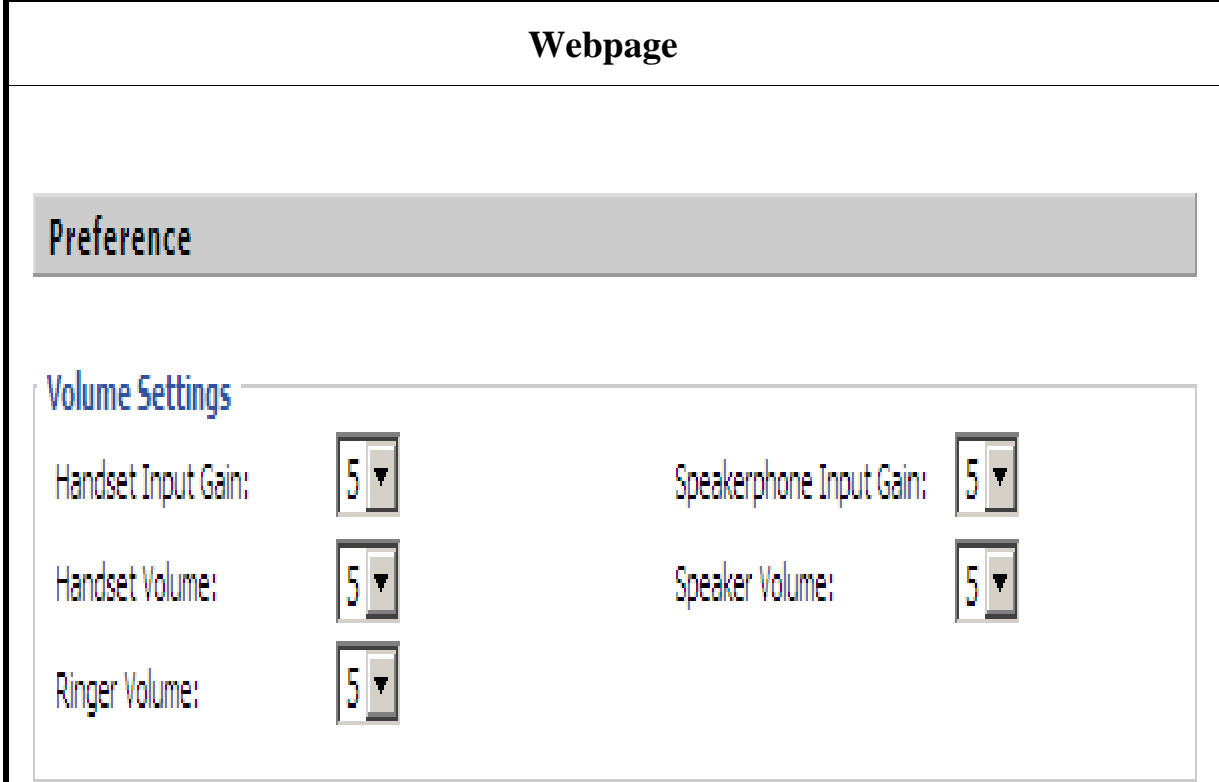
7.5.6.2 Wireless Connection

Webpage	Field Name	Description
	Connection Status	Display the current connection status, and the name of connected AP appear in the brackets if the wireless is connected.
	SSID	The SSID name of all searched AP.
	Authentication	Display the authentication type of the AP
	Encryption	Display the encryption type of the AP
	Status	Display the status of the AP. The icon  stands for the IP542N have connected to the AP. The icon  stands for the signal strength of the AP.

7.5.7 DDNS Setting

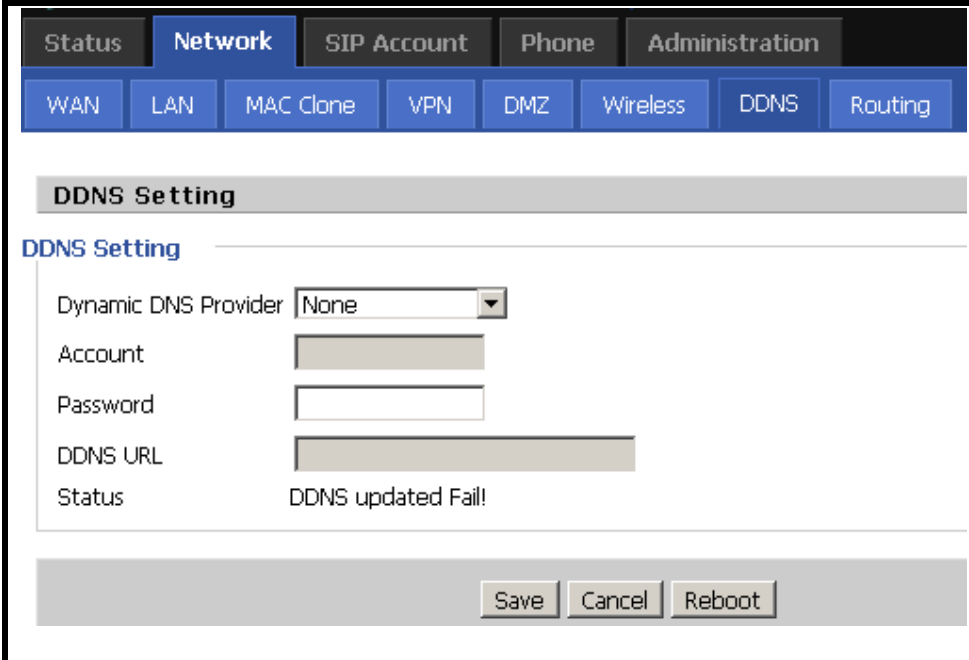
Webpage	Field Name	Description
	Dynamic DNS Provider	DDNS is enabled and select a DDNS service provider
	Account	Enter the DDNS service account
	Password	Enter the DDNS service account password
	DDNS URL	Enter the DDNS domain name or IP address
	Status	See if DDNS is successfully upgraded

7.5.8 Routing

Field Name	Description
Destination	Destination address
Host/Net	Both Host and Net selection
Gateway	Gateway IP address
Interface	LAN/WAN/Custom three options, and add the corresponding address
Comment	Comment

7.6 SIP Account

7.6.1 Line 1

In this webpage, users can configuration the information about SIP account1, including the following 4 parts: Basic, Audio Configuration, Supplementary Service Subscription and Advanced.

Following is the description about that.

7.6.1.1 Basic

Set the basic information provided by your VOIP Service Provider, such as Phone Number, Account, password, SIP Proxy and so on.

Webpage	Field Name	Description
<p style="text-align: center;">Preference</p> <hr/> <p>Volume Settings</p> <p>Handset Input Gain: <input type="text" value="5"/> Speakerphone Input Gain: <input type="text" value="5"/></p> <p>Handset Volume: <input type="text" value="5"/> Speaker Volume: <input type="text" value="5"/></p> <p>Ringer Volume: <input type="text" value="5"/></p>	Line Enable	If or not enable Line 1
	Peer to Peer	If or not enable PEER to PEER ◆ If enable, SIP-1 will not send register request to SIP server; ◆ In System Status, SIP-1 Status is Registered; ◆ SIP-1 can make call out, but others can not call SIP-1.
	Proxy DNS Type	Choose DNS type from A Type and DNS SRV.
	Use VPN	If or not enable VPN
	Domain Name	The domain of SIP Server
	SIP Server	The IP address of SIP Server
	SIP Port	The port which SIP Server supports for VOIP service, default is 5060
	Outbound Proxy	Outbound Proxy IP or domain name
	Outbound Port	Outbound Proxy's Service port
	Display Name	The number will display in callee
	Phone Number	Number of telephone provided by SIP Proxy
	Account	SIP account provided by SIP Proxy
	Password	SIP password provided by SIP Proxy

7.6.1.2 Audio Configuration

Select the audio Codec you want to use.

Webpage	Field Name	Description
<p style="text-align: center;">Audio Configuration</p> <hr/> <p>Codec Setup</p> <p>Audio Codec Type 1: <input type="text" value="G.711U"/> Audio Codec Type 2: <input type="text" value="G.711A"/></p> <p>Audio Codec Type 3: <input type="text" value="G.729"/> Audio Codec Type 4: <input type="text" value="G.722"/></p> <p>Audio Codec Type 5: <input type="text" value="G.723"/> G.723 Coding Speed: <input type="text" value="5.3k bps"/></p> <p>Packet Cycle(ms): <input type="text" value="20ms"/> Silence Supp: <input type="text" value="Disable"/></p> <p>Echo Cancel: <input type="text" value="Enable"/> Auto Gain Control: <input type="text" value="Enable"/></p>	Audio Codec Type1	Choose the audio codec type from G.711U, G.711A, G.722, G.729, G.723
	Audio Codec Type2	Choose the audio codec type from G.711U, G.711A, G.722, G.729, G.723
	Audio Codec Type3	Choose the audio codec type from G.711U, G.711A, G.722, G.729, G.723
	Audio Codec	Choose the audio codec type from G.711U,

	Type4	G.711A, G.722, G.729, G.723
	Audio Codec Type5	Choose the audio codec type from G.711U, G.711A, G.722, G.729, G.723
	G.723 Coding Speed	Choose the speed of G.723 from 5.3kbps and 6.3kbps
	Packet Cycle	The RTP packet cycle time
	Silence Supp	If or not enable silence
	Echo Cancel	If or not enable echo cancel

7.6.1.3 Supplementary Services Subscription

Webpage	Field Name	Description
<p style="text-align: center;">Supplementary Service Subscription</p> <p>Supplementary Services</p> <p>Call Waiting <input type="button" value="Enable"/> Hot Line <input type="text"/></p> <p>MWI Enable <input type="button" value="Enable"/> Voice Mailbox Numbers <input type="text"/></p> <p>MWI Subscribe Enable <input type="button" value="Disable"/></p>	Call Waiting	If or not enable Call waiting.
	Hot Line	Fill in the hotline number. Pickup handset or press speaker/headset button, FIP12/FIP12W will dial out the hotline number automatically.
	MWI Enable	If or not enable MWI (message waiting indicate).
	Voice Mailbox Numbers	Fill in the voice mailbox phone number
	MWI Subscribe Enable	If or not enable MWI subscribe

7.6.1.4 Advanced

Webpage	Field Name	Description																														
<div style="border: 1px solid black; padding: 5px;"> <p>Advanced</p> <p>Advanced Setup</p> <table style="width: 100%; border-collapse: collapse;"> <tr> <td style="width: 50%; vertical-align: top;"> Domain Name Type: <input type="text" value="Enable"/> </td> <td style="width: 50%; vertical-align: top;"> Carry Port Information: <input type="text" value="Disable"/> </td> </tr> <tr> <td>Signal Port: <input type="text" value="5060"/></td> <td>DTMF Type: <input type="text" value="RFC2833"/></td> </tr> <tr> <td>RFC2833 Payload(>=96): <input type="text" value="101"/></td> <td>Register Refresh Interval(sec): <input type="text" value="3600"/></td> </tr> <tr> <td>RTP Port: <input type="text" value="0"/> (=0 auto select)</td> <td>Cancel Message Enable: <input type="text" value="Disable"/></td> </tr> <tr> <td>Session Refresh Time(sec): <input type="text" value="0"/></td> <td>Refresher: <input type="text" value="UAC"/></td> </tr> <tr> <td>Prack Enable: <input type="text" value="Disable"/></td> <td>SIP OPTIONS Enable: <input type="text" value="Disable"/></td> </tr> <tr> <td>Keep-alive Interval(10-60s): <input type="text" value="15"/></td> <td>Anonymous Call: <input type="text" value="Disable"/></td> </tr> <tr> <td>Anonymous Call Block: <input type="text" value="Disable"/></td> <td>Proxy DNS Type: <input type="text" value="A Type"/></td> </tr> <tr> <td>Use OB Proxy In Dialog: <input type="text" value="Disable"/></td> <td>Reg Subscribe Enable: <input type="text" value="Disable"/></td> </tr> <tr> <td>Dial Prefix: <input type="text"/></td> <td>User Type: <input type="text" value="IP"/></td> </tr> <tr> <td>Hold Method: <input type="text" value="ReINVITE"/></td> <td>Request-URI User Check: <input type="text" value="Disable"/></td> </tr> <tr> <td>Only Recv Request From Server: <input type="text" value="Disable"/></td> <td>Server Address: <input type="text"/></td> </tr> <tr> <td>SIP Received Detection: <input type="text" value="Disable"/></td> <td>VPN: <input type="text" value="Disable"/></td> </tr> <tr> <td>Country Code: <input type="text"/></td> <td>Remove Country Code: <input type="text" value="Disable"/></td> </tr> <tr> <td>Caller ID Header: <input type="text" value="FROM"/></td> <td></td> </tr> </table> </div>	Domain Name Type: <input type="text" value="Enable"/>	Carry Port Information: <input type="text" value="Disable"/>	Signal Port: <input type="text" value="5060"/>	DTMF Type: <input type="text" value="RFC2833"/>	RFC2833 Payload(>=96): <input type="text" value="101"/>	Register Refresh Interval(sec): <input type="text" value="3600"/>	RTP Port: <input type="text" value="0"/> (=0 auto select)	Cancel Message Enable: <input type="text" value="Disable"/>	Session Refresh Time(sec): <input type="text" value="0"/>	Refresher: <input type="text" value="UAC"/>	Prack Enable: <input type="text" value="Disable"/>	SIP OPTIONS Enable: <input type="text" value="Disable"/>	Keep-alive Interval(10-60s): <input type="text" value="15"/>	Anonymous Call: <input type="text" value="Disable"/>	Anonymous Call Block: <input type="text" value="Disable"/>	Proxy DNS Type: <input type="text" value="A Type"/>	Use OB Proxy In Dialog: <input type="text" value="Disable"/>	Reg Subscribe Enable: <input type="text" value="Disable"/>	Dial Prefix: <input type="text"/>	User Type: <input type="text" value="IP"/>	Hold Method: <input type="text" value="ReINVITE"/>	Request-URI User Check: <input type="text" value="Disable"/>	Only Recv Request From Server: <input type="text" value="Disable"/>	Server Address: <input type="text"/>	SIP Received Detection: <input type="text" value="Disable"/>	VPN: <input type="text" value="Disable"/>	Country Code: <input type="text"/>	Remove Country Code: <input type="text" value="Disable"/>	Caller ID Header: <input type="text" value="FROM"/>		Domain name Mode	If or not use domain name in the SIP URI
	Domain Name Type: <input type="text" value="Enable"/>	Carry Port Information: <input type="text" value="Disable"/>																														
	Signal Port: <input type="text" value="5060"/>	DTMF Type: <input type="text" value="RFC2833"/>																														
	RFC2833 Payload(>=96): <input type="text" value="101"/>	Register Refresh Interval(sec): <input type="text" value="3600"/>																														
	RTP Port: <input type="text" value="0"/> (=0 auto select)	Cancel Message Enable: <input type="text" value="Disable"/>																														
	Session Refresh Time(sec): <input type="text" value="0"/>	Refresher: <input type="text" value="UAC"/>																														
	Prack Enable: <input type="text" value="Disable"/>	SIP OPTIONS Enable: <input type="text" value="Disable"/>																														
	Keep-alive Interval(10-60s): <input type="text" value="15"/>	Anonymous Call: <input type="text" value="Disable"/>																														
	Anonymous Call Block: <input type="text" value="Disable"/>	Proxy DNS Type: <input type="text" value="A Type"/>																														
	Use OB Proxy In Dialog: <input type="text" value="Disable"/>	Reg Subscribe Enable: <input type="text" value="Disable"/>																														
	Dial Prefix: <input type="text"/>	User Type: <input type="text" value="IP"/>																														
	Hold Method: <input type="text" value="ReINVITE"/>	Request-URI User Check: <input type="text" value="Disable"/>																														
	Only Recv Request From Server: <input type="text" value="Disable"/>	Server Address: <input type="text"/>																														
SIP Received Detection: <input type="text" value="Disable"/>	VPN: <input type="text" value="Disable"/>																															
Country Code: <input type="text"/>	Remove Country Code: <input type="text" value="Disable"/>																															
Caller ID Header: <input type="text" value="FROM"/>																																
	Carry Port Information	If or not carry Port information in the SIP URI.																														
	Signal Port	The local port of SIP protocol, default is 5060																														
	DTMF Type	Choose the DTMF type from IN_band, RFC2833 and SIP INFO.																														
	RFC2833 Payload (>=96)	User can use the default setting																														
	Register Refresh Interval	The interval between two normal Register messages. You can use the default setting.																														
	RTP Port	Set the port to send RTP. IP Phone will select one idle port for RTP if you set "0", otherwise use the value user set.																														
	Cancel Message Enable	When you set enable, an unregistered message will be sent before registration, while you set disable, unregistered message will not be sent before registration. You should set the option for different Proxy.																														
	Prack Enable	If or not enable prack.																														
	SIP Ping Enable	If this option enable, IP Phone will send SIP-PING to Server periodically instead of sending hello packet. The send interval is Keep-alive interval.																														
	Keep-alive interval (10-60s)	The interval that IP Phone will send an empty packet to Proxy.																														

7.6.2 Line 2

The parameters of Line2 is same as Line1 except the value of Line 0.

7.6.3 SIP Settings



7.6.3.1 SIP Parameters

SIP Parameters			
SIP Parameters			
SIP T1	<input type="text" value="500"/> MS	Max Forward	<input type="text" value="70"/>
SIP Reg User Agent Name	<input type="text"/>	Max Auth	<input type="text" value="2"/>
Reg Retry Intvl	<input type="text" value="30"/> sec	Reg Retry Long Intvl	<input type="text" value="1200"/> sec
Mark All AVT Packets	<input type="button" value="Enable"/>	RFC 2543 Call Hold	<input type="button" value="Enable"/>
SRTP	<input type="button" value="Disable"/>	SRTP Prefer Encryption	<input type="button" value="AES_CM"/>
Service Type	<input type="button" value="Common"/>		
Response Status Code Handling			
Retry Reg RSC	<input type="text"/>		

7.6.3.2 NAT Traversal

Webpage	Field Name	Description
<div style="border: 1px solid black; padding: 5px;"> <p>NAT Traversal</p> <p>NAT Traversal</p> <p>NAT Traversal <input type="button" value="Disable"/></p> <p>NAT Refresh Interval(sec) <input type="text" value="60"/></p> <p>STUN Server Address <input type="text"/></p> <p>STUN Server Port <input type="text" value="3478"/></p> </div>	NAT Traversal	If or not enable NAT. FIP12/FIP12W supports STUN traversal, choose “STUN” in the “NAT Traversal Mode” if you want traverse NAT/Firewall.
	STUN Server IP	STUN server IP address, default is stun.fwdnet.net
	NAT Refresh Interval (sec)	the interval to refresh
	Port	STUN port

7.6.4 VoIP QoS

QoS Settings	Field Name	Description
Layer 3 QoS SIP QoS(0-63) <input type="text" value="0"/> RTP QoS(0-63) <input type="text" value="0"/>	SIP /RTP QoS	The default value is 0,you can set a range of values is 0~63

7.7 Phone

User can configuration volume, call forward, multi-functional key, dial plan, phonebook and call log.

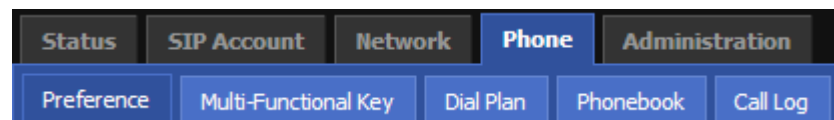

7.7.1 Preference

User can configuration the value of ring volume, speakerphone volume, handset volume and so on.

7.7.1.1 Preference

Webpage	Field Name	Description
	Handset Input Gain	Adjust the handset input gain from 0-7
	Handset Volume Gain	Adjust the output gain from 0-7
	Speakerphone Input Gain	Adjust the speakerphone input gain from 0-7
	Speaker Volume	Adjust the speaker volume form 0-7
	Ringer Volume	Adjust the ringer volume form 0-7.

7.7.1.2 Regional

Webpage	Field Name	Description
<p>Regional</p> <p>Tone Type: <input type="text" value="US"/></p> <p>Min Jitter Delay(ms): <input type="text" value="0"/> Max Jitter Delay(ms): <input type="text" value="80"/></p> <p>Hook-On Tone Delay(Sec): <input type="text" value="4"/> Ringing Time(Sec): <input type="text" value="60"/></p>	Tone Type	Choose tone type form China, US, Hong Kong and KR.
	Min Jitter Delay (ms)	The Min value of FIP12/FIP12W's jitter delay, FIP12/FIP12W's jitter is an adaptive jitter mechanism.
	Max Jitter Delay (ms)	The Max value of FIP12/FIP12W's jitter delay, FIP12/FIP12W's jitter is an adaptive jitter mechanism.
	Hook-On Tone Delay (sec)	How long FIP12/FIP12W will delay to sound hook-on tone when call party end call.
	Ringing Time(Sec)	How long FIP12/FIP12W will ring

7.7.1.3 Call Forward

Webpage	Field Name	Description
<p>Call Forward</p> <p>Cfwd All Dest: <input type="text"/> Cfwd Busy Dest: <input type="text"/></p> <p>Cfwd No Ans Dest: <input type="text"/> Cfwd No Ans Delay: <input type="text" value="20"/></p>	Cfwd All Dest	The phone number which will be forwarded to. IP Phone will forward all calls to the phone number immediately when there is an incoming call.
	Cfwd Busy Dest	The phone number which will be forwarded to when line is busy.
	Cfwd No Ans Dest	The phone number which will be forwarded to when there's no answer at your phone.
	Cfwd No Ans Delay	The seconds to delay forwarding calls, if there is no answer at your phone.

7.7.1.4 Miscellaneous

Webpage	Field Name	Description
	Auto Answer	If or not enable auto answer. If enable, FIP12/FIP12W will auto answer all incoming call immediately.
	Dial Time Out	How long FIP12/FIP12W to sound dial out tone when FIP12/FIP12W dialing number.

<div style="border: 1px solid black; padding: 5px;"> <p>Miscellaneous</p> <p>Auto Answer: <input type="text" value="Disable"/></p> <p>Call Immediately Key: <input type="text" value="#"/></p> <p>Dial Time Out: <input type="text" value="5"/></p> <p>ICMP Ping: <input type="text" value="Disable"/></p> </div>	Call Immediately Key	Choose call immediately key form * or #.
	ICMP Ping	If or not enable ICMP Ping. If enable this option, FIP12/FIP12W will ping the SIP Server every interval time, otherwise, It will send “hello” empty packet to the SIP Server.

7.7.2 Multi-Functional Key

Step 1.Choose one **Exp Key** from the Exp Key 1...4.

Step 2.Choose one **function type** from **speed dial**, **BLF**, **shortcut key**, **call pickup** and **call park**.

Step 3.Set the other corresponding parameters.

Step 4.Press **Save Settings** button to save changes, press **Cancel Changes** button to cancel changes.

Below is an example:

<table border="1"> <thead> <tr> <th>Key</th> <th>Type</th> <th>Mode</th> <th>Line</th> <th>Expansion</th> <th>Pickup Code</th> </tr> </thead> <tbody> <tr> <td>Exp Key 1</td> <td>Speed Dial</td> <td></td> <td>Auto</td> <td>111</td> <td></td> </tr> <tr> <td>Exp Key 2</td> <td>Speed Dial</td> <td></td> <td>Line 1</td> <td>111</td> <td></td> </tr> <tr> <td>Exp Key 3</td> <td>Speed Dial</td> <td></td> <td>Line 2</td> <td>111</td> <td></td> </tr> <tr> <td>Exp Key 4</td> <td>BLF</td> <td></td> <td>Line 1</td> <td>111</td> <td>*8</td> </tr> </tbody> </table>						Key	Type	Mode	Line	Expansion	Pickup Code	Exp Key 1	Speed Dial		Auto	111		Exp Key 2	Speed Dial		Line 1	111		Exp Key 3	Speed Dial		Line 2	111		Exp Key 4	BLF		Line 1	111	*8	<p>Adding speed dial:</p> <p>Step 1.Choose one Exp Key to configuration</p> <p>Step 2.Select the speed dial from the drop down list</p> <p>Step 3.Choose the Line from auto (the first line registered), line1, line2</p> <p>Step 4.Fill the phone number in Expansion</p> <p>Step 5.Press Save to save changes and you can see the status of corresponding LED is solid green.</p> <p>Step 6.Press Reboot button to make changes effective.</p> <p>If set properly, press the corresponding key to make call immediately, and the status of LED is solid red.</p> <p>Adding BLF:</p>
Key	Type	Mode	Line	Expansion	Pickup Code																															
Exp Key 1	Speed Dial		Auto	111																																
Exp Key 2	Speed Dial		Line 1	111																																
Exp Key 3	Speed Dial		Line 2	111																																
Exp Key 4	BLF		Line 1	111	*8																															

- Step 1. Choose one Exp Key to configuration
- Step 2. Select the BLF from the drop down list
- Step 3. Choose the Line from line1, line2.
- Step 4. Fill the monitored phone number in Expansion
- Step 5. Fill the pickup code in **Pickup Code** if user wants to pickup the call when there is a new call coming in monitored phone.
- Step 6. Press to save changes.
- Step 7. Press button to make changes effective.

Adding shortcut key:

- Step 1. Choose one Exp Key to configuration
- Step 2. Select the shortcut key from the drop down list
- Step 3. Select the mode from the phonebook, call history, text message, volume+, volume- and login/logout in the drop down list.
- Step 4. Press to save changes and you can see the status of corresponding LED is solid green.
- Step 5. Press button to make changes effective.

If set properly, press the corresponding button to access to phonebook, call history, text message, volume+, volume- and login/logout menu directly.

Adding Call Pickup:

- Step 1. Choose one Exp Key to configuration
- Step 2. Select the call pickup from the drop down list

Step 3. Choose the Line from line1, line2.

Step 4. Fill the phone number in Expansion

Step 5. Press to save changes and you can see the status of corresponding LED is solid green.

Step 6. Press button to make changes effective.

In idle, press the corresponding button to make call immediately.

Adding call park:

Step 1. Choose one Exp Key to configuration

Step 2. Select the **Call Park** from the drop down list in type

Step 3. Choose the Line from line1, line2.

Step 4. Fill the pickup extension code in Expansion

Step 5. Press to save changes and you can see the status of corresponding LED is solid green.

Step 6. Press button to make changes effective.

7.7.3 Dial Plan

7.7.3.1 Parameters and Settings

Webpage	Field Name	Description
	Dial Plan	If or not enable dial rule.
	Line	Choose the call mode from line1, line2.
	Digit Map	Fill in the sequence used to match input number

Picture 1

The syntactic, please refer to the following **Dial Plan Syntactic**

Action	Choose the dial plan mode from Deny and Dial Out. Deny means FIP12/FIP12W will reject the matched number, while Dial Out means FIP12/FIP12W allow dial out the matched number.
Move Up	Press it to move up.
Move Down	Press it to move down.

No.	Line	Digit Map	Action	Move Up	Move Down	
1	Line1	<9:010>2010110	Dial Out	▲	▼	<input type="checkbox"/>
2	Line2	<5,:><:241333>8101	Dial Out	▲	▼	<input type="checkbox"/>
3	Line1	<[4-6]:>22x<:333>	Dial Out	▲	▼	<input type="checkbox"/>
4	Line2	<9,8,:>711	Dial Out	▲	▼	<input type="checkbox"/>
5	Line1	<[2-5],:5>622.	Deny	▲	▼	<input type="checkbox"/>

Picture 2

Steps :

Adding one dial plan:

Step 1. Enable Dial Plan

Step 2. Click **Add** button, and the configuration table like Picture 1 will appear

Step 3. Fill in the value of parameters.

Step 4. Press **OK** button to end configuration.

Step 5. Press **Save Settings** button to save changes.

Editing one dial plan:

Step 1. Enable Dial plan

Step 2. Choose one dial plan

Step 3. Click **Edit** button, and the configuration table like

	<p>Picture 2 will appear</p> <p>Step 4. Change the value of parameters.</p> <p>Step 5. Press OK button to end configuration.</p> <p>Step 6. Press Save Settings button to save changes.</p> <p>Deleting one dial plan:</p> <p>Step 1. Enable Dial plan</p> <p>Step 2. Choose one dial plan</p> <p>Step 3. Click Delete button to delete the dial plan</p>
--	---------------------------------------------------------------------------------------------------------------------------------------------------------------------------------------------------------------------------------------------------------------------------------------------------------------------------------------------------------------------------------------

7.7.3.2 Dial Plan Syntactic

No.	String	Description
1	0 1 2 3 4 5 6 7 8 9 * #	Legal characters
2	X	Lowercase letter x stands for one legal character
3	[sequence]	To match one character form sequence. For example: <ul style="list-style-type: none"> • [0-9]: match one digit form 0 to 9 • [23-5*]: match one character from 2 or 3 or 4 or 5 or *
4	x.	Match to $x^0, x^1, x^2, x^3, \dots, x^n$ For example: "01.": can match "0", "01", "011", "0111",, "01111..."
5	<diald: substituted>	Replace diald with substituted. For example: <8:1650>123456: input is "85551212", output is "16505551212"

6	x,y	<p>Make outside dial tone after dialing “x”, stop until dialing character “y”</p> <p>For example:</p> <p>“9,1xxxxxxxxx”:FIP12/FIP12W make outside dial tone after inputting “9”, stop tone until inputting “1”</p> <p>“9,8,010x”: make outside dial tone after inputting “9”, stop tone until inputting “0”</p>
7	T	<p>Set the delayed time.</p> <p>For example:</p> <p>“<9:111>T2”: FIP12/FIP12W will dial out the matched number “111” after 2 seconds.</p>

7.7.3.3 Example

No.	Line	Digit Map	Action	Move Up	Move Down	
1	Line1	<:010>#12<#:;%23>2	Dial Out	▲	▼	<input type="checkbox"/>
2	Line2	<5,:><:241333>8101	Dial Out	▲	▼	<input type="checkbox"/>
3	Line1	<[4-5]:>22xxxx<:333>	Dial Out	▲	▼	<input type="checkbox"/>
4	Line2	<2-3,:5:>622.	Dial Out	▲	▼	<input type="checkbox"/>
5	Line1	777x.8	Deny	▲	▼	<input type="checkbox"/>

- 1. Example 1**
Using line 1, if user dials **#12#2**, FIP12/FIP12W will call **010#12%232** immediately.

- 2. Example 2**
Using line 2, if user dials **5,8101**, FIP12/FIP12W will call **2413338101** immediately,
And FIP12/FIP12W will make outside dial tone after inputting “5”, stop tone until inputting “8”.

- 3. Example 3**
Using line 1, if user dials **422xxxx** or **522xxxx**, FIP12/FIP12W will call **22xxxx333** immediately.

4. Example 4

Using line 2, if user dials **2,622** or **2,6222** or **2,62222** or **2.622222** or **3.622222**,

FIP12/FIP12W will call **5622** or **56222** or **562222** or **5622222** or **5622222** immediately.

And FIP12/FIP12W will make outside dial tone after inputting “2” or “3”, stop tone until inputting “6”.

5. Example 5

Using line 1, if user dials **777x8**, FIP12/FIP12W will reject the phone number out.

7.7.4 Phone Book

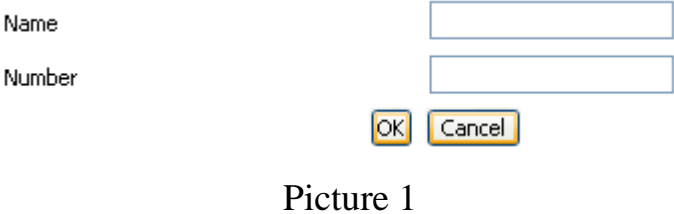
Webpage	Field Name	Description
	Name	Input the name
	Number	Input the phone number



Picture 2

Name	<input type="text" value="tom"/>
Number	<input type="text" value="113"/>
	<input type="button" value="OK"/> <input type="button" value="Cancel"/>

Picture 3

Steps :

Adding one phone book:

Step 1. Click **Add** button, and the configuration table like

Picture 1 will appear

Step 2. Fill in the value of parameters.

Step 3. Press **OK** button to end configuration.

Step 4. Press **Save Settings** button to save changes.

Editing one phone book:

Step 1. Choose one phone book

Step 2. Click **Edit** button, and the configuration table like

Picture 3 will appear

Step 3. Change the value of parameters.

Step 4. Press **OK** button to end configuration.

Step 5. Press **Save Settings** button to save changes.

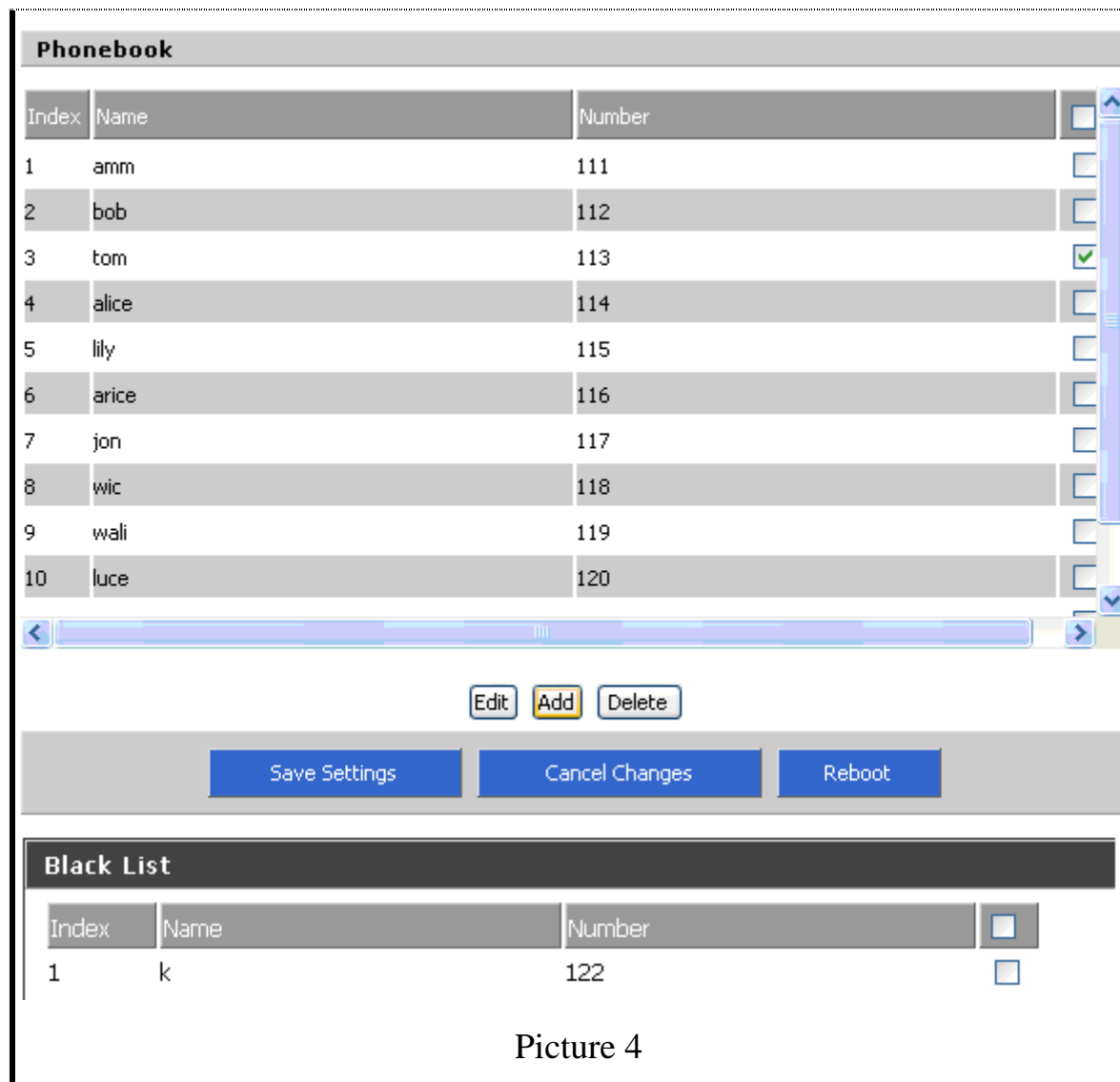

Deleting one phone book:

Step 1. Choose one phone book

Step 2. Click **Delete** button to delete the phone book

Move one phone book to Black list:

Step 1. Choose one phone book

Step 2. Click **Move to blacklist** button to delete the phone book

7.7.4.1 Black List

Webpage	Field Name	Description
<p>Picture 1</p>	Name	Input the name
	Number	Input the phone number

Black List			
Index	Name	Number	<input type="checkbox"/>
1	k	122	<input type="checkbox"/>
2	w	123	<input checked="" type="checkbox"/>
3	q	124	<input type="checkbox"/>
4	r	125	<input type="checkbox"/>

Name

Number

Picture 2

Steps :

Adding one Black List:

Step 1. Click **Add** button, then the configuration table like

Picture 1 will appear

Step 2. Fill in the value of parameters.

Step 3. Press **OK** button to end configuration.

Step 4. Press **Save Settings** button to save changes.

Editing one Black List:

Step 1. Choose one black list

Step 2. Click **Edit** button, and the configuration table like

Picture 2 will appear

Step 3. Change the value of parameters.

Step 4. Press **OK** button to end configuration.

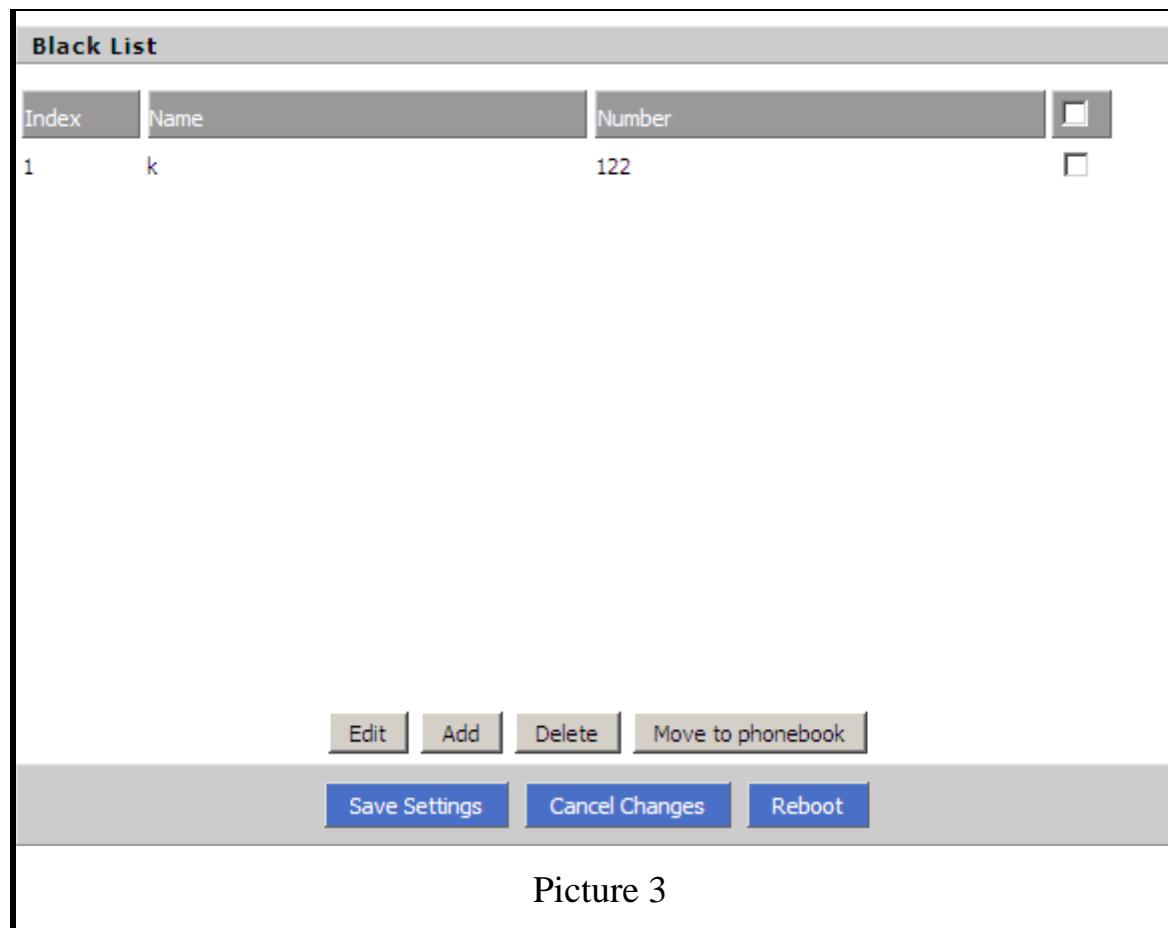

Step 5. Press **Save Settings** button to save changes.

Deleting one Black List:

Step 1. Choose one black list

Step 2. Click **Delete** button to delete the black list

Moving one Black List to phonebook:

Step 1. Choose one black list

Step 2. Click **Move to phonebook** button to move the black list to the phonebook

7.7.5 Call Log

To view the call log information such as redial list (incoming call), answered call and missed call.

7.7.5.1 Redial List

Redial List				
Index	Name	Number	Start Time	Duration
1	111	111	04/19 10:51	00:00:01
2	6526	6526	04/18 12:14	00:00:04
3	6	6	04/18 12:14	00:00:00
4	6527	6527	01/01 00:03	00:00:04
5	6526	6526	04/18 12:07	00:00:05
6	6526	6526	01/01 00:03	00:00:05
7	6526	6526	04/18 12:01	00:00:06
8	111	111	04/18 12:01	00:00:01
9	6526	6526	04/18 12:00	00:00:01
10	6	6	04/18 12:00	00:00:01
11	6526	6526	04/18 12:00	00:00:01
12	6526	6526	04/18 12:00	00:00:01
13	010	010	04/18 11:01	00:00:02

7.7.5.2 Answered Calls

Answered Calls				
Index	Name	Number	Start Time	Duration
1	222	222	04/19 12:29	00:00:18
2	111	111	04/19 12:20	00:00:39
3	222	222	04/19 12:19	00:00:12
4	222	222	04/19 12:17	00:00:08
5	111	111	04/19 11:55	00:04:00
6	111	111	04/19 11:52	00:02:59
7	111	111	04/19 11:11	00:01:01
8	111	111	04/19 10:52	00:00:18
9	111	111	04/19 10:52	00:00:05
10	111	111	04/19 10:51	00:00:20
11	6526	6526	04/18 12:14	00:00:04
12	6526	6526	04/18 12:07	00:00:06
13	6526	6526	04/18 12:00	00:00:06

7.7.5.3 Missed Call

Missed Calls				
Index	Name	Number	Start Time	Duration
1	456	456	03/25 19:06	00:00:01
2	456	456	03/25 19:06	00:00:00
3	456	456	03/25 19:05	00:00:01
4	456	456	03/25 19:05	00:00:01
5	456	456	03/25 19:05	00:00:01

7.8 Administration

Use can manage the FIP12/FIP12W in these six webpage; you can configuration the Time/Date, password, web access, system log and so on.



7.8.1 Management

You can configuration the value of Time/Date, password, web access, and system log and so on.

7.8.1.1 Time/Date

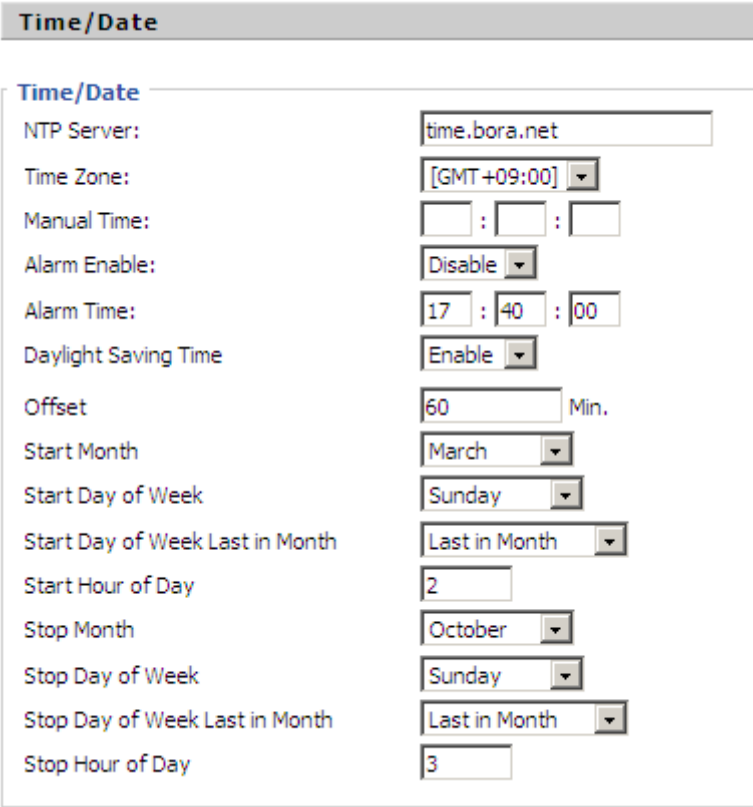
Webpage	Field Name	Description
 <p>The screenshot shows a 'Time/Date' configuration page with the following fields: NTP Server (text input: time.bora.net), Time Zone (dropdown: [GMT +09:00]), Manual Time (time input: : :), Alarm Enable (dropdown: Disable), Alarm Time (time input: 17 : 40 : 00), Daylight Saving Time (dropdown: Enable), Offset (text input: 60 Min.), Start Month (dropdown: March), Start Day of Week (dropdown: Sunday), Start Day of Week Last in Month (dropdown: Last in Month), Start Hour of Day (text input: 2), Stop Month (dropdown: October), Stop Day of Week (dropdown: Sunday), Stop Day of Week Last in Month (dropdown: Last in Month), and Stop Hour of Day (text input: 3).</p>	NTP Server	Fill in the NTP server IP address or Domain name
	Time Zone	Choose the time zone
	Manual Time	Adjust time by manual
	Alarm Enable	If or not enable alarm
	Alarm Time	Set alarm time
	Daylight Saving Time	If or not enable daylight saving time.
	Offset	Offset time, “-60” means advancing 60miniter, “60” means delaying 60minite
	Start Month	Choose starting month
	Start Day of Week	Choose starting day
	Start Day of Week Last in Month	Choose starting week
	Start Hour of Day	Choose starting hour
	Stop Month	Choose stopping month
	Stop Day of Week	Choose stopping day
	Stop Day of Week Last in Month	Choose stopping week
Stop Hour of Day	Choose stopping the function hour	
<p data-bbox="320 1585 917 1668">Alarm Enable: <input type="button" value="Enable"/></p> <p data-bbox="320 1630 917 1668">Alarm Time: <input type="text" value="17"/> : <input type="text" value="40"/> : <input type="text" value="00"/></p> <p data-bbox="556 1711 688 1749">Picture 1</p>	<p data-bbox="1126 1585 1223 1624">Steps:</p>	

Daylight Saving Time	Enable
Offset	60 Min.
Start Month	March
Start Day of Week	Sunday
Start Day of Week Last in Month	Last in Month
Start Hour of Day	2
Stop Month	October
Stop Day of Week	Sunday
Stop Day of Week Last in Month	Last in Month
Stop Hour of Day	3

Picture 2

Alarm:

- Step 1. Enable alarm
- Step 2. Set alarm time, like Picture 1.
- Step 3. Press **Save Settings** button to save changes and then press **Reboot** button to active changes.

Daylight Saving Time:

- Step 1. Enable Daylight Saving Time.
- Step 2. Set value of offset, like Picture 2
- Step 3: Set starting Month/Week/Day/Hour in **Start Month/Start Day of Week Last in Month/Start Day of Week/Start Hour of Day**, analogously set stopping Month/Week/Day/Hour in **Stop Month/Stop Day of Week Last in Month/Stop Day of Week/Stop Hour of Day**.
- Step 5. Press **Saving Settings** button to save and press **Reboot** button to active changes.

7.8.1.2 Password Reset



Webpage	Field Name	Description
	User Type	Choose the user type from admin and user.
	Original Password	Input original password
	New Password	Input the new password
	Password Confirm	Input the new password again

<div style="border: 1px solid #ccc; padding: 5px; margin-bottom: 10px;"> <p style="background-color: #f0f0f0; margin: 0; padding: 2px;">Password Reset</p> </div> <div style="border: 1px solid #ccc; padding: 5px;"> <p>Password Reset</p> <p>User Type: <input type="text" value="admin"/></p> <p>Original Password: <input type="text"/></p> <p>New Password: <input type="text"/></p> <p>Confirm Password: <input type="text"/></p> </div>	<p>Change the password of admin mode:</p> <p>Steps:</p> <p>Step 1. Choose the admin from the drop-down list.</p> <p>Step 2. Input original password, default setting is null.</p> <p>Step 3. Input a new password twice time in New Password and Confirm Password.</p> <p>Change the password of user mode:</p> <p>Step 1. Choose the user from the drop-down list.</p> <p>Step 2. Input original password, default setting is null.</p> <p>Note: In admin mode, you can change the user password directly without the password of user mode.</p> <p>Step 3. Input a new password twice time in New Password and Confirm Password.</p>
--------------------------------------------------------------------------------------------------------------------------------------------------------------------------------------------------------------------------------------------------------------------------------------------------------------------------------------------------------------------------------------------------------------------------------------------------------------	--------------------------------------------------------------------------------------------------------------------------------------------------------------------------------------------------------------------------------------------------------------------------------------------------------------------------------------------------------------------------------------------------------------------------------------------------------------------------------------------------------------------------------------------------------------------------------------------------------------------------------------------------------------------------------------------

7.8.1.3 Web Access

Webpage	Field Name	Description
<div style="border: 1px solid #ccc; padding: 5px; margin-bottom: 10px;"> <p style="background-color: #f0f0f0; margin: 0; padding: 2px;">Web Access:</p> </div> <div style="border: 1px solid #ccc; padding: 5px;"> <p>Web Access:</p> <p>WAN Interface Login: <input type="text" value="Enable"/></p> <p>Web Login Port: <input type="text" value="8080"/></p> <p>Web Idle Timeout: <input type="text" value="5"/> Min.</p> </div>	WAN Interface Login	If or not enable user login WEB via Internet port. If enable, user can access Web to administration.
	Web Login Port	Set the port which used to login WEB via Internet port and PC port, Default is 8080, that is why URL should have 8080.
	Web Idle Timeout	Set the web idle timeout time. The web page can be logged out after Web Idle Timeout without any operation.

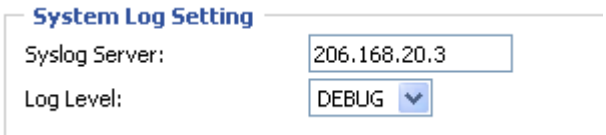
7.8.1.4 System Log Setting

Webpage	Field Name	Description
 <p>Picture 1</p>	SysLog Server	Set the SysLog Server IP address or domain name for FIP12/FIP12W.
 <p>Picture 2</p>  <p>Picture 3</p>		<p>FIP12/FIP12W support local and remote Syslog.</p> <p>In local:</p> <p>Step 1. Set syslog server null and choose one kind of Log Level, like Picture 1.</p> <p>Step 2. Press Saving Settings button to save and press Reboot button to active changes.</p> <p>Step 3. User can view syslog in Status/Syslog webpage.</p> <p>In remote:</p> <p>Step 1. Fill in syslog server IP address or domain name</p> <p>Step 2. Choose one kind of Log Level, like Picture 2.</p> <p>Step 3. Press Saving Settings button to save and press Reboot button to active changes.</p> <p>Step 4. User can view syslog in syslog server, and you can also view the syslog in Status/Syslog webpage.</p>

7.8.1.5 Factory Defaults

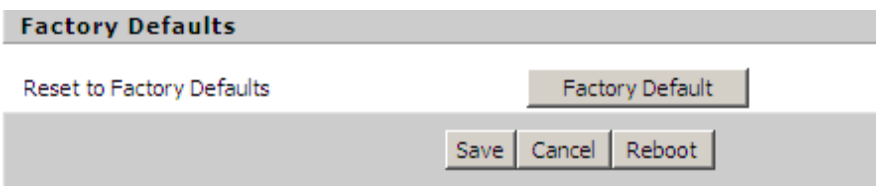
Webpage	Field Name	Description
		Press Factory Default button to set FIP12/FIP12W default.

7.8.2 Firmware Upgrade

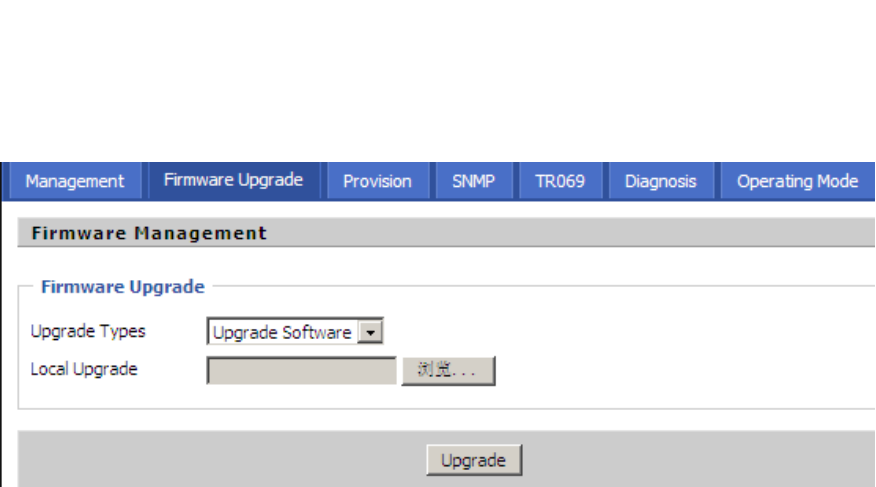
Webpage	Description
	<p>Steps:</p> <p>Step 1. Choose a upgrade file type from Upgrade Software, Upgrade Ring Voice, Upgrade Dial Plan and Upgrade Config File</p> <p>Step 2. Press <input type="button" value="browser"/> to browser the upgrade file.</p> <p>Step 3. Press <input type="button" value="Update"/> to start upgrading, LCD will display the notice when upgrading.</p> <p>Step 4. Login web and then check the firmware whether well upgraded by viewing the firmware version in Status/Basic webpage.</p>

7.8.3 Provision

- 1) Provisioning allow FIP12/FIP12W auto-upgrading or auto-configuring
- 2) FIP12/FIP12W supports 3 ways to provision: TFTP, HTTP and HTTPS.
 - ◆ Before testing or using TFTP, user should have tftp server and upgrading file and configuring file.
 - ◆ Before testing or using HTTP, user should have http server and upgrading file and configuring file.

- ◆ Before testing or using HTTPS, user should have https server and upgrading file and configuring file and CA Certificate file(should same as https server's) and Client Certificate file and Private key file

- 3) User can uploading CA Certificate file and Client Certificate file and Private Key file in Equipment Manage/Cert Manage page.
- 4) Details please refer to document Provision_User Manual_en_v1.1.doc

Field Name	Description
Provision Enable	If or not enable provision.
Resync on Reset	If or not enable resync after restart
Resync Random Delay(sec)	Set the maximum delay for request the synchronization file, default is 40.
Resync Periodic(sec)	If the last resync was failure, FIP12/FIP12W will retry resync after the “Resync Error Retry Delay ” time, default is 3600s.
Resync Error Retry Delay(rec)	Set the periodic time for resync, default is 3600s.
Forced Resync Delay(sec)	If it's time to resync, but FIP12/FIP12W is busy now, in this case, FIP12/FIP12W will wait for a period time, the longest is “Forced Resync Delay”, default is 14400s, when the time over, FIP12/FIP12W will forced to resync.
Resync After Upgrade	If or not enable firmware upgrade after resync, by default it is enabled.
Resync From SIP	If or not enable resync from SIP.
Option 66	It is used for In-house provision mode only. When use TFTP with option 66 to realize provisioning, user must input right configuration file name in IP542N's webpage. When disable Option 66 , this parameter has no effect.
Config File Name	It is used for In-house provision mode only. When use TFTP with option 66 to realize provisioning, user must input right configuration file name in the webpage. When disable Option 66 , this parameter has no effect.
Profile Rule	URL of profile provision file Note that the specified file path is relative to the TFTP server's virtual root directory.

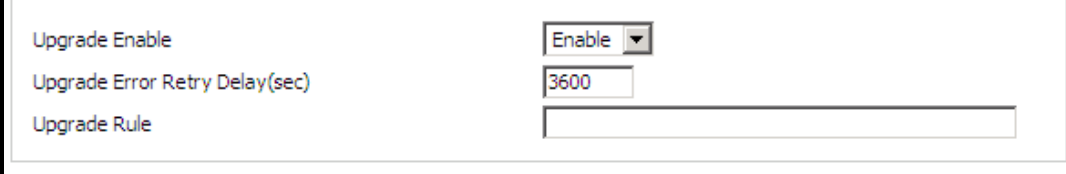
Firmware Upgrade	Field Name	Description
	Upgrade Enable	If or not enable firmware upgrade via provision.
	Upgrade Error Retry Delay(sec)	If the last upgrade fails, FIP12/FIP12W will try upgrading again after “Upgrade Error Retry Delay” period, default is 3600s.
	Upgrade Rule	URL of upgrade file

7.8.4 SNMP

Management Firmware Upgrade Provision SNMP TR069 Diagnosis Operating Mode	Field Name	Description
<p>Please REBOOT to make the changes effective!</p> <p>SNMP Configuration</p> <p>SNMP Configuration</p> <p>SNMP Service: Disable</p> <p>Trap Server Address: </p> <p>Read Community Name: public</p> <p>Write Community Name: private</p> <p>Trap Community: trap</p> <p>Trap period interval(sec): 300</p>	SNMP Service	If or not enable SNMP.
	Trap Server Address	Enter the trap server address.
	Read Community Name	String, as an express password between management progress and agent progress.
	Write Community Name	String, as an express password between management progress and agent progress.
	Trap Community	The community field in trap.
	Trap period interval(sec)	The interval of sending trap.

7.8.5 TR069

Webpage	Field Name	Description
<p>Management Firmware Upgrade Provision SNMP TR069 Diagnosis Operating Mode</p> <p>TR069 Configuration</p> <p>ACS</p> <p>TR069 Enable: Disable</p> <p>CWMP: Enable</p> <p>ACS URL: </p> <p>User Name: </p> <p>Password: </p> <p>Periodic Inform Enable: Enable</p>	TR069 Enable	If or not enable TR069
	CWMP	If or not enable TR069
	ACS URL	The URL of TR069 server
	User Name	The FIP12/FIP12W's user name for connecting to TR069 server
	Password	The FIP12/FIP12W's password for connecting to TR069 server
	Periodic Inform Enable	If or not enable periodic information
	Periodic Inform	The interval to send information to

<div style="border: 1px solid black; padding: 5px;"> <p>Connect Request</p> <p>User Name <input type="text"/></p> <p>Password <input type="password"/></p> <hr/> <p style="text-align: center;"> <input type="button" value="Save"/> <input type="button" value="Cancel"/> <input type="button" value="Reboot"/> </p> </div>	Interval	TR069 server
	User Name	The TR069 server's user name for connecting to FIP12/FIP12W
	Password	The TR069 server's password for connecting to FIP12/FIP12W
	SSL Key	Fill in SSL key.

7.8.6 Diagnosis

In this page, user can do ping test and traceroute test to diagnose the device's connection status.

<div style="border: 1px solid black; padding: 5px;"> <p>Ping Test</p> <p>Ping Test</p> <p>Dest IP/Host Name <input type="text"/></p> <p>WAN Interface <input type="text" value="1_TR069_VOICE_INTERNET_R_VID_"/></p> <pre>PING www.baidu.com (115.239.210.26): 56 data bytes 64 bytes from 115.239.210.26: seq=0 ttl=54 time=43.979 ms 64 bytes from 115.239.210.26: seq=1 ttl=54 time=53.875 ms 64 bytes from 115.239.210.26: seq=2 ttl=54 time=45.226 ms 64 bytes from 115.239.210.26: seq=3 ttl=54 time=49.534 ms 64 bytes from 115.239.210.26: seq=4 ttl=54 time=49.045 ms --- www.baidu.com ping statistics --- 5 packets transmitted, 5 packets received, 0% packet loss round-trip min/avg/max = 43.979/48.331/53.875 ms</pre> <p style="text-align: center;"> <input type="button" value="Apply"/> <input type="button" value="Cancel"/> </p> </div>	<p>1. Ping Test</p> <p>Enter the destination IP or host name, and then click Apply, device will perform ping test.</p>
<div style="border: 1px solid black; padding: 5px;"> <p>Traceroute Test</p> <p>Traceroute Test</p> <p>Dest IP/Host Name <input type="text"/></p> <p>WAN Interface <input type="text" value="1_TR069_VOICE_INTERNET_R_VID_"/></p> <pre>traceroute to 192.168.20.1 (192.168.20.1), 30 hops max, 38 byte packets 1 192.168.20.1 (192.168.20.1) 1.074 ms 0.862 ms 0.918 ms</pre> <p style="text-align: center;"> <input type="button" value="Apply"/> <input type="button" value="Cancel"/> </p> </div>	<p>2. Traceroute Test</p> <p>Enter the destination IP or host name, and then click Apply, device will perform traceroute test.</p>

7.8.7 Operation Mode

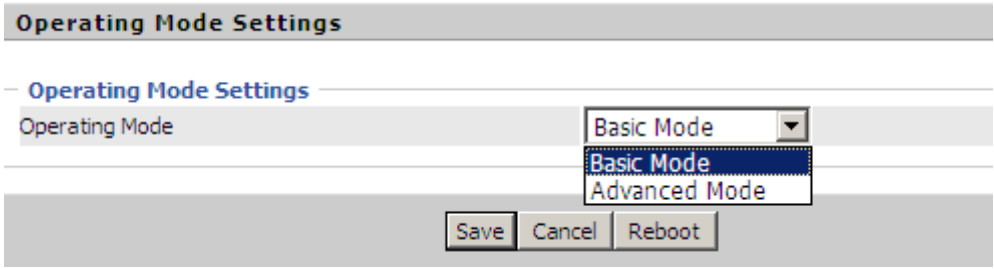
	Choose the Operation Mode as Basic Mode or Advance Mode.
------------------------------------------------------------------------------------	----------------------------------------------------------

8 Troubleshooting

This section provides solutions to problems that can occur during the installation and operation of the IP phone. Read the following descriptions if you are having problems.

8.1 No Operation after Power On

Solution:

Check if the power adapter is properly connected.

If applicable, check if the PoE (Power over Ethernet) switch behind the IP phone is set correctly.

8.2 Long Time Stop at “Initializing Network”

Solution:

Check if the Ethernet cable is properly connected.

Check if the DHCP server is working normally.

Check if the connection between the DHCP Server and FIP12/FIP12W is properly connected.

8.3 No Dial Tone

Solution:

Check if the handset cord is properly connected.

8.4 Can not Make a Call

Solution:

Check the status of your SIP registration status or contact your administrator, supplier, or ITSP for more information or assistance.

8.5 Can not Receive Any Phone Call

Solution:

Check the status of your SIP registration status, or contact your administrator, supplier, or ITSP for more information or assistance.

8.6 No Voice during an Active Call

Solution:

Check if the servers support the current audio codec type, or contact your administrator, supplier, or ITSP for more information or assistance.

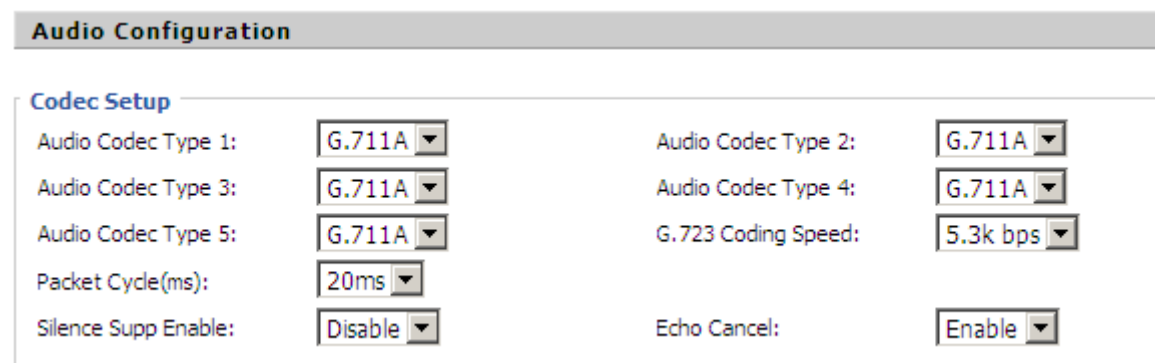

The screenshot shows the 'Audio Configuration' section of a web interface. Under the 'Codec Setup' heading, there are several dropdown menus for configuring audio settings. The settings are as follows:

Setting	Value
Audio Codec Type 1:	G.711A
Audio Codec Type 2:	G.711A
Audio Codec Type 3:	G.711A
Audio Codec Type 4:	G.711A
Audio Codec Type 5:	G.711A
G.723 Coding Speed:	5.3k bps
Packet Cycle(ms):	20ms
Silence Supp Enable:	Disable
Echo Cancel:	Enable

8.7 Can not connect to the configuration Website

Solution:

Check if the Ethernet cable is properly connected.

Check if the URL is right wrote, the format of URL is: **http:// the Internet port IP address: 8080, 8080** must be added.

Check if your firewall/NAT settings are correct.

Check if the version of IE is IE8, or use other browser such as Firefox or Mozilla, or contact your administrator, supplier, or ITSP for more information or assistance.

8.8 Forget the Password

Default password of website and menu is null.

If user changed the password and then forgot, you can not access to the configuration website or the menu items which need password.

Solution:

Factory default: press  button and choose **16Factory Default**, then a notice will appear, choose **OK** by using the corresponding softkey button.

If you choose factory default, you will return the phone to the original factory settings and will erase ALL current settings, including the directory and call logs.

Changes or modifications not expressly approved by the party responsible for compliance could void the user's authority to operate the equipment.

This equipment has been tested and found to comply with the limits for a Class B digital device, pursuant to Part 15 of the FCC Rules. These limits are designed to provide reasonable protection against harmful interference in a residential installation. This equipment generates, uses and can radiate radio frequency energy and, if not installed and used in accordance with the instructions, may cause harmful interference to radio communications. However, there is no guarantee that interference will not occur in a particular installation.

If this equipment does cause harmful interference to radio or television reception, which can be determined by turning the equipment off and on, the user is encouraged to try to correct the interference by one or more of the following measures:

- Reorient or relocate the receiving antenna.
- Increase the separation between the equipment and receiver.
- Connect the equipment into an outlet on a circuit different from that to which the receiver is connected.
- Consult the dealer or an experienced radio/TV technician for help.

This equipment complies with FCC radiation exposure limits set forth for an uncontrolled environment. This equipment should be installed and operated with minimum distance 20cm between the radiator and your body. This transmitter must not be co-located or operating in conjunction with any other antenna or transmitter.

Thank You!

Beijing Flying Voice Technology Limited

Beijing	Shenzhen
Add: C1603,Caizhi International Building,18 East Zhongguancun Road,Haidian District Beijing ZIP code:100176 Tel: +86-10-67885285	Add: Room102, 1F East, Bldg 3#, Minqi Park, Pingshan, Xili, Nanshan Districe, Shenzhen, China ZIP code:518052 Tel: +86-755-26099365