



fordowner.com



ford.ca

FOCUS ELECTRIC



November 2014
First Printing
Owner's Manual
Focus Electric
Litho in U.S.A.



FM5J19A321 DA



The information contained in this publication was correct at the time of going to print. In the interest of continuous development, we reserve the right to change specifications, design or equipment at any time without notice or obligation. No part of this publication may be reproduced, transmitted, stored in a retrieval system or translated into any language in any form by any means without our written permission. Errors and omissions excepted.

© Ford Motor Company 2014

All rights reserved.

Part Number: 20141023165258

Table of Contents

Introduction

About This Manual.....	5
Symbols Glossary.....	5
Data Recording.....	7
California Proposition 65.....	9
Perchlorate.....	9
Ford Credit.....	9
Replacement Parts Recommendation.....	9
Special Notices.....	10
Mobile Communications Equipment.....	10

Environment

Protecting the Environment.....	11
---------------------------------	----

At a Glance

Front Exterior Overview.....	12
Rear Exterior Overview.....	13
Vehicle Interior Overview.....	14
Instrument Panel Overview.....	15

Child Safety

General Information.....	17
Installing Child Seats.....	18
Booster Seats.....	24
Child Seat Positioning.....	26
Child Safety Locks.....	27

Safety Belts

Principle of Operation.....	29
Fastening the Safety Belts.....	30
Safety Belt Height Adjustment.....	32
Safety Belt Warning Lamp and Indicator Chime.....	33
Safety Belt Minder.....	33
Child Restraint and Safety Belt Maintenance.....	35

Personal Safety System™

Personal Safety System™.....	36
------------------------------	----

Supplementary Restraints System

Principle of Operation.....	37
Driver and Passenger Airbags.....	38
Front Passenger Sensing System.....	39
Side Airbags.....	41
Driver Knee Airbag.....	42
Side Curtain Airbags.....	43
Crash Sensors and Airbag Indicator.....	44
Airbag Disposal.....	45

Keys and Remote Controls

General Information on Radio Frequencies.....	46
Remote Control.....	46
Replacing a Lost Key or Remote Control.....	49

MyKey™

Principle of Operation.....	50
Creating a MyKey.....	51
Clearing All MyKeys.....	52
Checking MyKey System Status.....	53
Using MyKey With Remote Start Systems.....	54
MyKey Troubleshooting.....	55

Locks

Locking and Unlocking.....	57
Manual Liftgate.....	61
Keyless Entry.....	62

Security

Passive Anti-Theft System.....	64
Anti-Theft Alarm.....	65

Table of Contents

Steering Wheel

Adjusting the Steering Wheel.....	67
Audio Control.....	67
Voice Control.....	68
Cruise Control.....	68
Information Display Control.....	68

Wipers and Washers

Windshield Wipers.....	70
Windshield Washers.....	70
Rear Window Wiper and Washers.....	71

Lighting

General Information.....	72
Lighting Control.....	72
Autolamps.....	73
Instrument Lighting Dimmer.....	74
Headlamp Exit Delay.....	74
Daytime Running Lamps.....	74
Direction Indicators.....	75
Interior Lamps.....	75
Ambient Lighting.....	76

Windows and Mirrors

Power Windows.....	77
Exterior Mirrors.....	78
Interior Mirror.....	79
Sun Visors.....	80

Instrument Cluster

Gauges.....	81
Warning Lamps and Indicators.....	83
Audible Warnings and Indicators.....	85

Information Displays

General Information.....	86
Information Messages.....	92

Climate Control

Automatic Climate Control.....	100
Hints on Controlling the Interior Climate.....	101
Heated Windows and Mirrors.....	102
Cabin Air Filter.....	103
Remote Start.....	103

Seats

Sitting in the Correct Position.....	104
Head Restraints.....	104
Manual Seats.....	106
Power Seats.....	106
Rear Seats.....	107
Heated Seats.....	109

Auxiliary Power Points

Auxiliary Power Points.....	110
-----------------------------	-----

Storage Compartments

Center Console.....	111
Overhead Console.....	111

Starting and Stopping the Electric Motor

Starting the Electric Motor.....	112
Switching Off the Electric Motor.....	113

High Voltage Battery

General Information.....	115
Charging the High Voltage Battery.....	115
High Voltage Battery Cut-Off Switch.....	120

Transmission

Automatic Transmission.....	122
-----------------------------	-----

Brakes

General Information.....	124
--------------------------	-----

Table of Contents

Hints on Driving With Anti-Lock Brakes.....	125	Hazard Warning Flashers.....	148
Parking Brake.....	125	Jump Starting the Vehicle.....	148
Hill Start Assist.....	125	Collision, Damage or Fire Event.....	150
Traction Control		Post-Crash Alert System.....	151
Principle of Operation.....	127	Customer Assistance	
Using Traction Control.....	127	Getting the Services You Need.....	152
Stability Control		In California (U.S. Only).....	153
Principle of Operation.....	128	The Better Business Bureau (BBB) Auto Line Program (U.S. Only).....	154
Parking Aids		Utilizing the Mediation/Arbitration Program (Canada Only).....	154
Rear Parking Aid.....	129	Getting Assistance Outside the U.S. and Canada.....	155
Rear View Camera.....	130	Ordering Additional Owner's Literature.....	156
Cruise Control		Reporting Safety Defects (U.S. Only).....	156
Principle of Operation.....	133	Reporting Safety Defects (Canada Only).....	157
Using Cruise Control.....	133	Fuses	
Driving Aids		Fuse Specification Chart.....	158
Steering.....	134	Changing a Fuse.....	168
Load Carrying		Maintenance	
Rear Under Floor Storage.....	135	General Information.....	169
Load Limit.....	135	Opening and Closing the Hood.....	169
Towing		Under Hood Overview.....	170
Towing a Trailer.....	143	Coolant Check.....	171
Transporting the Vehicle.....	143	Brake Fluid Check.....	173
Towing the Vehicle on Four Wheels.....	143	Washer Fluid Check.....	173
Driving Hints		Changing the 12V Battery.....	173
Breaking-In.....	145	Checking the Wiper Blades.....	175
Cold Weather Precautions.....	145	Changing the Wiper Blades.....	175
Driving Through Water.....	145	Adjusting the Headlamps.....	176
Floor Mats.....	145	Removing a Headlamp.....	177
Roadside Emergencies		Changing a Bulb.....	178
Roadside Assistance.....	147	Bulb Specification Chart.....	181

Table of Contents

Vehicle Care

General Information.....	182
Cleaning Products.....	182
Cleaning the Exterior.....	182
Waxing.....	183
Cleaning the Engine.....	183
Cleaning the Windows and Wiper Blades.....	184
Cleaning the Interior.....	184
Cleaning the Instrument Panel and Instrument Cluster Lens.....	184
Cleaning Leather Seats.....	185
Repairing Minor Paint Damage.....	186
Cleaning the Alloy Wheels.....	186
Vehicle Storage.....	186

Wheels and Tires

Temporary Mobility Kit.....	189
Tire Care.....	201
Using Snow Chains.....	216
Tire Pressure Monitoring System.....	216
Changing a Road Wheel.....	220
Lug Nuts.....	221

Capacities and Specifications

Motorcraft Parts.....	222
Vehicle Identification Number.....	223
Vehicle Certification Label.....	223
Transmission Code Designation.....	224
Capacities and Specifications.....	225

Audio System

General Information.....	227
Audio Unit - Vehicles With: Sony Audio System.....	228
Media Hub.....	230

MyFord Touch™

General Information.....	231
--------------------------	-----

Settings.....	240
Entertainment.....	254
Phone.....	271
Electric Vehicle Information.....	278
Information.....	292
Climate.....	301
Navigation.....	304
MyFord Touch™ Troubleshooting.....	314

Accessories

Accessories.....	321
------------------	-----

Appendices

End User License Agreement.....	323
---------------------------------	-----

Extended Service Plan (ESP)

Extended Service Plan (ESP).....	345
----------------------------------	-----

Scheduled Maintenance

General Maintenance Information.....	347
Normal Scheduled Maintenance.....	350
Scheduled Maintenance Record.....	351

Introduction

ABOUT THIS MANUAL

Thank you for choosing Ford. We recommend that you take some time to get to know your vehicle by reading this manual. The more that you know about it, the greater the safety and pleasure you will get from driving it.

WARNING



Driving while distracted can result in loss of vehicle control, crash and injury. We strongly recommend that you use extreme caution when using any device that may take your focus off the road. Your primary responsibility is the safe operation of your vehicle. We recommend against the use of any hand-held device while driving and encourage the use of voice-operated systems when possible. Make sure you are aware of all applicable local laws that may affect the use of electronic devices while driving.

Note: This manual describes product features and options available throughout the range of available models, sometimes even before they are generally available. It may describe options not fitted to the vehicle you have purchased.

Note: Some of the illustrations in this manual may show features as used in different models, so may appear different to you on your vehicle.

Note: Always use and operate your vehicle in line with all applicable laws and regulations.

Note: Pass on this manual when selling your vehicle. It is an integral part of your vehicle.

This manual may qualify the location of a component as left-hand side or right-hand side. The side is determined when facing forward in the seat.

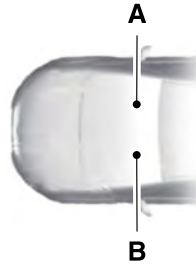

E154903

- A Right-hand side.
- B Left-hand side.

SYMBOLS GLOSSARY

These are some of the symbols you may see on your vehicle.



Safety alert



See Owner's Manual



Air conditioning system



Anti-lock braking system



Avoid smoking, flames or sparks



Battery



Battery acid



Brake fluid - non petroleum based

Introduction



Brake system



Cabin air filter



Check fuel cap



Child safety door lock or unlock



Child seat lower anchor



Child seat tether anchor



Cruise control



Do not open when hot



Engine air filter



Engine coolant



Engine coolant temperature



Engine oil



Explosive gas



Fan warning



Fasten safety belt



Front airbag



Front fog lamps



Fuel pump reset



Fuse compartment



Hazard warning flashers



Heated rear window



Heated windshield



Interior luggage compartment release



Jack



Keep out of reach of children



Lighting control



Low tire pressure warning



Maintain correct fluid level



Note operating instructions

Introduction



Panic alarm



Parking aid



Parking brake



Power steering fluid



Power windows front/rear



Power window lockout



Service engine soon



Side airbag



Shield the eyes



Stability control



Windshield wash and wipe

DATA RECORDING

Service Data Recording

Service data recorders in your vehicle are capable of collecting and storing diagnostic information about your vehicle. This potentially includes information about the performance or status of various systems and modules in the vehicle, such as engine, throttle, steering or brake

systems. In order to properly diagnose and service your vehicle, Ford Motor Company, Ford of Canada, and service and repair facilities may access or share among them vehicle diagnostic information received through a direct connection to your vehicle when diagnosing or servicing your vehicle. Additionally, when your vehicle is in for service or repair, Ford Motor Company, Ford of Canada, and service and repair facilities may access or share among them data for vehicle improvement purposes. For U.S. only (if equipped), if you choose to use the SYNC Vehicle Health Report, you consent that certain diagnostic information may also be accessed electronically by Ford Motor Company and Ford authorized service facilities, and that the diagnostic information may be used for any purpose. See **MyFord Touch™** (page 231).

Event Data Recording

This vehicle is equipped with an event data recorder. The main purpose of an event data recorder is to record, in certain crash or near crash-like situations, such as an airbag deployment or hitting a road obstacle; this data will assist in understanding how a vehicle's systems performed. The event data recorder is designed to record data related to vehicle dynamics and safety systems for a short period of time, typically 30 seconds or less.

The event data recorder in this vehicle is designed to record such data as:

- **How various systems in your vehicle were operating;**
- **Whether or not the driver and passenger safety belts were buckled/fastened;**
- **How far (if at all) the driver was depressing the accelerator and/or the brake pedal; and**

Introduction

- **How fast the vehicle was traveling; and**
- **Where the driver was positioning the steering wheel.**

This data can help provide a better understanding of the circumstances in which crashes and injuries occur.

Note: *Event data recorder data is recorded by your vehicle only if a non-trivial crash situation occurs; no data is recorded by the event data recorder under normal driving conditions and no personal data or information (e.g., name, gender, age, and crash location) is recorded (see limitations regarding 911 Assist and Traffic, directions and Information privacy below). However, parties, such as law enforcement, could combine the event data recorder data with the type of personally identifying data routinely acquired during a crash investigation.*

To read data recorded by an event data recorder, special equipment is required, and access to the vehicle or the event data recorder is needed. In addition to the vehicle manufacturer, other parties, such as law enforcement, that have such special equipment, can read the information if they have access to the vehicle or the event data recorder. Ford Motor Company and Ford of Canada do not access event data recorder information without obtaining consent, unless pursuant to court order or where required by law enforcement, other government authorities or other third parties acting with lawful authority. Other parties may seek to access the information independently of Ford Motor Company and Ford of Canada.

Note: *Including to the extent that any law pertaining to Event Data Recorders applies to SYNC or its features, please note the following: Once 911 Assist (if equipped) is enabled (set ON), 911 Assist may, through any paired and connected cell phone, disclose to emergency services that the vehicle has been in a crash involving the deployment of an airbag or, in certain vehicles, the activation of the fuel pump shut-off. Certain versions or updates to 911 Assist may also be capable of being used to electronically or verbally provide to 911 operators the vehicle location (such as latitude and longitude), and/or other details about the vehicle or crash or personal information about the occupants to assist 911 operators to provide the most appropriate emergency services. If you do not want to disclose this information, do not activate the 911 Assist feature. See MyFord Touch™ (page 231).*

Additionally, when you connect to Traffic, Directions and Information (if equipped, U.S. only), the service uses GPS technology and advanced vehicle sensors to collect the vehicle's current location, travel direction, and speed ("vehicle travel information"), only to help provide you with the directions, traffic reports, or business searches that you request. If you do not want Ford or its vendors to receive this information, do not activate the service. For more information, see Traffic, Directions and Information, Terms and Conditions. See MyFord Touch™ (page 231).

Introduction

CALIFORNIA PROPOSITION 65

WARNING



Some constituents of engine exhaust, certain vehicle components, certain fluids contained in vehicles and certain products of component wear contain or emit chemicals known to the State of California to cause cancer and birth defects or other reproductive harm.

PERCHLORATE

Certain components in your vehicle such as airbag modules, safety belt pretensioners and remote control batteries may contain perchlorate material. Special handling may apply for service or vehicle end of life disposal. For more information visit:

Web Address
www.dtsc.ca.gov/hazardouswaste/perchlorate

FORD CREDIT

(U.S. Only)

Ford Credit offers a full range of financing and lease plans to help you acquire your vehicle. If you have financed or leased your vehicle through Ford Credit, thank you for your business.

For your convenience we offer a number of ways to contact us, as well as to help manage your account.

Phone: 1-800-727-7000

For more information regarding Ford Credit, as well as to access Account Manager, please go to www.fordcredit.com.

REPLACEMENT PARTS RECOMMENDATION

Your vehicle has been built to the highest standards using quality parts. We recommend that you demand the use of genuine Ford and Motorcraft parts whenever your vehicle requires scheduled maintenance or repair. You can clearly identify genuine Ford and Motorcraft parts by looking for the Ford, FoMoCo or Motorcraft branding on the parts or their packaging.

Scheduled Maintenance and Mechanical Repairs

One of the best ways for you to make sure that your vehicle provides years of service is to have it maintained in line with our recommendations using parts that conform to the specifications detailed in this Owner's Manual. Genuine Ford and Motorcraft parts meet or exceed these specifications.

Collision Repairs

We hope that you never experience a collision, but accidents do happen. Genuine Ford replacement collision parts meet our stringent requirements for fit, finish, structural integrity, corrosion protection and dent resistance. During vehicle development we validate these parts deliver the intended level of protection as a whole system. A great way to know for sure you are getting this level of protection is to use genuine Ford replacement collision parts.

Introduction

Warranty on Replacement Parts

Genuine Ford and Motorcraft replacement parts are the only replacement parts that benefit from a Ford Warranty. Damage caused to your vehicle as a result of the failure of non-Ford parts may not be covered by the Ford Warranty. For additional information, refer to the terms and conditions of the Ford Warranty.

SPECIAL NOTICES

New Vehicle Limited Warranty

For a detailed description of what is covered and what is not covered by your vehicle's New Vehicle Limited Warranty, refer to the Warranty Manual that is provided to you along with your Owner's Manual.

Special Instructions

For your added safety, your vehicle is fitted with sophisticated electronic controls.

WARNINGS



You risk death or serious injury to yourself and others if you do not follow the instruction highlighted by the warning symbol. Failure to follow the specific warnings and instructions could result in personal injury.



Front seat mounted rear-facing child or infant seats should **NEVER** be placed in front of an active passenger airbag.

On-board Diagnostics (OBD-II)

Your vehicle's On-board Diagnostics (OBD-II) system has a data port for diagnostics, repair and reprogramming services with diagnostic scan tools. Installing a non-Ford-approved aftermarket OBD plug-in device that uses the port during normal driving, for example

remote insurance company monitoring, remote vehicle diagnostics, telematics or engine reprogramming, may cause interference or damage to vehicle systems. We do not recommend or endorse the use of any non-Ford-approved aftermarket OBD plug-in devices. The vehicle Warranty may not cover damage caused by any non-Ford-approved aftermarket OBD plug-in device.

MOBILE COMMUNICATIONS EQUIPMENT

Using mobile communications equipment is becoming increasingly important in the conduct of business and personal affairs. However, you must not compromise your own or others' safety when using such equipment. Mobile communications can enhance personal safety and security when appropriately used, particularly in emergency situations. Safety must be paramount when using mobile communications equipment to avoid negating these benefits. Mobile communication equipment includes, but is not limited to, cellular phones, pagers, portable email devices, text messaging devices and portable two-way radios.

WARNING



Driving while distracted can result in loss of vehicle control, crash and injury. We strongly recommend that you use extreme caution when using any device that may take your focus off the road. Your primary responsibility is the safe operation of your vehicle. We recommend against the use of any hand-held device while driving and encourage the use of voice-operated systems when possible. Make sure you are aware of all applicable local laws that may affect the use of electronic devices while driving.

Environment

PROTECTING THE ENVIRONMENT

You must play your part in protecting the environment. Correct vehicle usage and the authorized disposal of waste, cleaning and lubrication materials are significant steps toward this aim.

At a Glance

FRONT EXTERIOR OVERVIEW

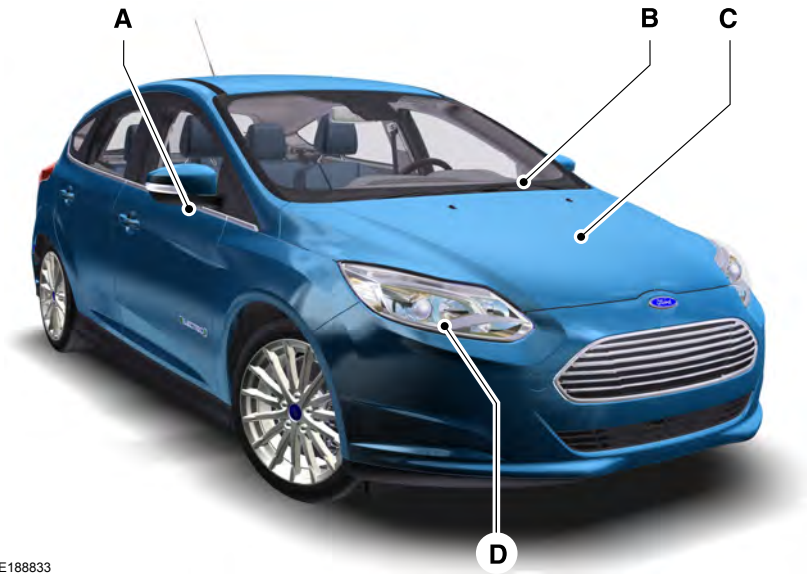

E188833

- A See **Locking and Unlocking** (page 57).
- B See **Changing the Wiper Blades** (page 175).
- C See **Maintenance** (page 169).
- D See **Changing a Bulb** (page 178).

At a Glance

REAR EXTERIOR OVERVIEW

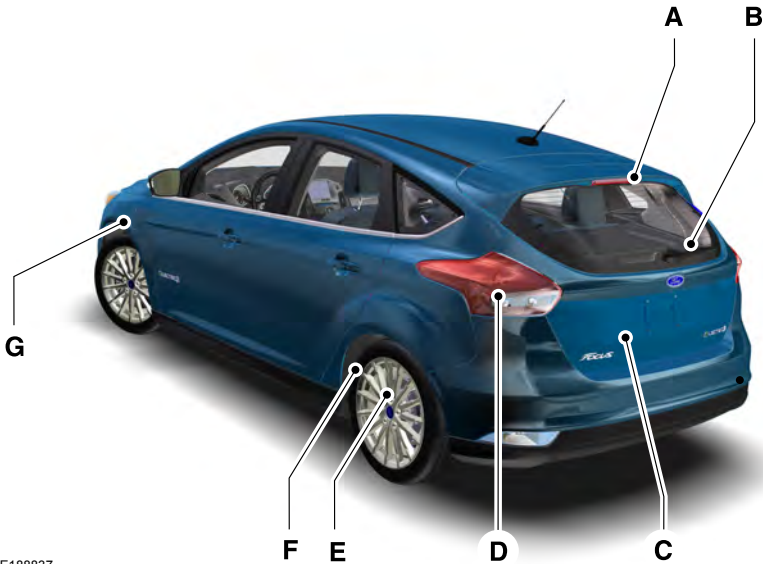

E188837

- A See **Changing a Bulb** (page 178).
- B See **Changing the Wiper Blades** (page 175).
- C See **Temporary Mobility Kit** (page 189).
- D See **Changing a Bulb** (page 178).
- E See **Changing a Road Wheel** (page 220).
- F See **Wheels and Tires** (page 189).
- G Charge port. See **High Voltage Battery** (page 115).

At a Glance

VEHICLE INTERIOR OVERVIEW

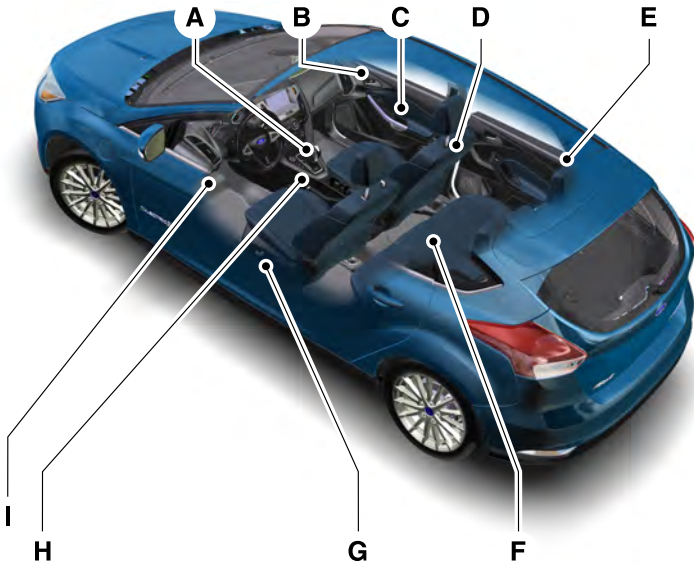

E188836

- A See **Transmission** (page 122).
- B See **Locking and Unlocking** (page 57).
- C See **Power Windows** (page 77).
- D See **Head Restraints** (page 104).
- E See **Fastening the Safety Belts** (page 30).
- F See **Rear Seats** (page 107).
- G See **Manual Seats** (page 106). See **Power Seats** (page 106).
- H See **Parking Brake** (page 125).
- I See **Opening and Closing the Hood** (page 169).

At a Glance

INSTRUMENT PANEL OVERVIEW

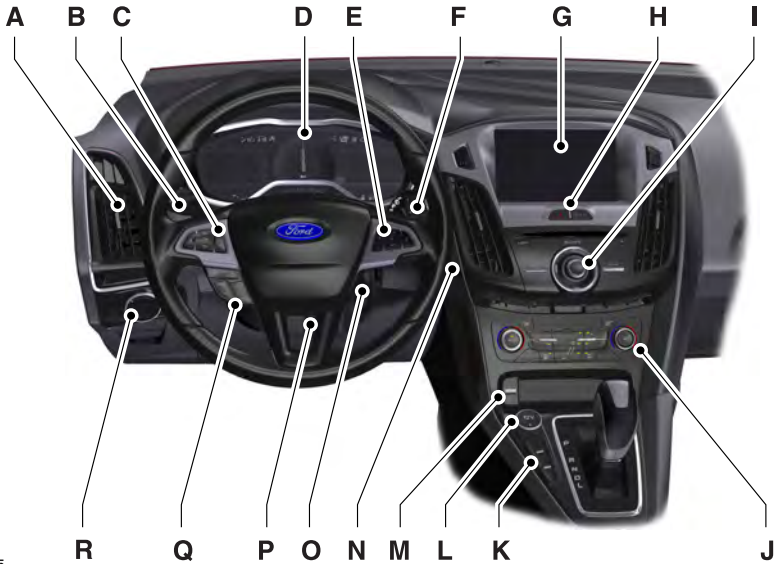

E188835

- A Air vents.
- B Direction indicators. See **Direction Indicators** (page 75).
- C Information display control. See **Information Display Control** (page 68).
- D Instrument cluster. See **Instrument Cluster** (page 81).
- E Information display control. See **MyFord Touch™** (page 231).
- F Wiper lever. See **Wipers and Washers** (page 70).
- G Information and entertainment display. See **MyFord Touch™** (page 231).
- H Hazard flasher switch. See **Hazard Warning Flashers** (page 148).
- I Audio unit. See **Audio Unit** (page 228).
- J Climate controls. See **Climate Control** (page 100).
- K Parking aid switch. See **Parking Aids** (page 129).
- L Auxiliary power point. See **Auxiliary Power Points** (page 110).
- M Media hub. See **Media Hub** (page 230).

At a Glance

- N Keyless start button. See **Starting the Electric Motor** (page 112).
- O Audio control. See **Audio Control** (page 67). Voice control. See **Voice Control** (page 68).
- P Steering wheel adjustment. See **Adjusting the Steering Wheel** (page 67).
- Q Cruise control switches. See **Using Cruise Control** (page 133).
- R Lighting control. See **Lighting** (page 72).

Child Safety

GENERAL INFORMATION

See the following sections for directions on how to properly use safety restraints for children.

WARNINGS



Always make sure your child is secured properly in a device that is appropriate for their height, age and weight. Child safety restraints must be bought separately from your vehicle. Failure to follow these instructions and guidelines may result in an increased risk of serious injury or death to your child.



All children are shaped differently. The recommendations for safety restraints are based on probable child height, age and weight thresholds from National Highway Traffic Safety Administration and other safety organizations, or are the minimum requirements of law. Ford recommends checking with a NHTSA Certified Child Passenger Safety Technician (CPST) and consult your pediatrician to make sure your child seat is appropriate for your child, and

WARNINGS

is compatible with and properly installed in your vehicle. To locate a child seat fitting station and CPST, contact the NHTSA toll free at 1-888-327-4236 or go to <http://www.nhtsa.dot.gov>. In Canada, check with your local St. John Ambulance office for referral to a CPST or for further information, contact your provincial ministry of transportation, locate your local St. John Ambulance office by searching for St. John Ambulance on the internet, or Transport Canada at 1-800-333-0371 (<http://www.tc.gc.ca>). Failure to properly restrain children in safety seats made especially for their height, age, and weight may result in an increased risk of serious injury or death to your child.



Do not leave children or animals unattended in the vehicle. On hot days, the temperature in the trunk or vehicle interior can rise very quickly. Exposure of people or animals to these high temperatures for even a short time can cause death or serious heat-related injuries, including brain damage. Small children are particularly at risk.

Child Safety

Recommendations for Safety Restraints for Children

Child	Child size, height, weight, or age	Recommended restraint type
Infants or toddlers	Children weighing 40 lb (18 kg) or less (generally age four or younger).	Use a child safety seat (sometimes called an infant carrier, convertible seat, or toddler seat).
Small children	Children who have outgrown or no longer properly fit in a child safety seat (generally children who are less than 4 ft. 9 in. (1.45 m) tall, are greater than age four and less than age 12, and between 40 lb (18 kg) and 80 lb (36 kg) and upward to 100 lb (45 kg) if recommended by your child restraint manufacturer).	Use a belt-positioning booster seat.
Larger children	Children who have outgrown or no longer properly fit in a belt-positioning booster seat (generally children who are at least 4 ft. 9 in. (1.45 m) tall or greater than 80 lb (36 kg) or 100 lb (45 kg) if recommended by child restraint manufacturer).	Use a vehicle safety belt having the lap belt snug and low across the hips, shoulder belt centered across the shoulder and chest, and seat back upright.

- You are required by law to properly use safety seats for infants and toddlers in the United States and Canada.
- Many states and provinces require that small children use approved booster seats until they reach age eight, a height of 4 feet 9 inches (1.45 meters) tall, or 80 pounds (36 kilograms). Check your local and state or provincial laws for specific requirements about the safety of children in your vehicle.
- When possible, always properly restrain children 12 years of age and under in a rear seating position of your vehicle. Accident statistics suggest that children are safer when properly restrained in the rear seating positions than in a front seating position. See **Front Passenger Sensing System** (page 39).

INSTALLING CHILD SEATS

Child Seats



E142594

Child Safety

Use a child safety seat (sometimes called an infant carrier, convertible seat, or toddler seat) for infants, toddlers, or children weighing 40 pounds (18 kilograms) or less (generally age four or younger).

Using Lap and Shoulder Belts

WARNINGS



Airbags can kill or injure a child in a child seat. Never place a rear-facing child seat in front of an active airbag. If you must use a forward-facing child seat in the front seat, move the seat upon which the child seat is installed all the way back.



Airbags can kill or injure a child in a child seat. Children 12 and under should be properly restrained in the rear seat whenever possible.



Depending on where you secure a child restraint, and depending on the child restraint design, you may block access to certain safety belt buckle assemblies and LATCH lower anchors, rendering those features potentially unusable. To avoid risk of injury, occupants should only use seating positions where they are able to be properly restrained.

When installing a child safety seat with combination lap and shoulder belts:

- Use the correct safety belt buckle for that seating position.
- Insert the belt tongue into the proper buckle until you hear a snap and feel it latch. Make sure the tongue is securely fastened in the buckle.
- Keep the buckle release button pointing up and away from the safety seat, with the tongue between the child seat and the release button, to prevent accidental unbuckling.

- Place the vehicle seat upon which the child seat will be installed in the upright position.
- Put the safety belt in the automatic locking mode. See Step 5. This vehicle does not require the use of a locking clip.

Perform the following steps when installing the child seat with combination lap and shoulder belts:

Note: *Although the child seat illustrated is a forward facing child seat, the steps are the same for installing a rear facing child seat.*



E142528

1. Position the child safety seat in a seat with a combination lap and shoulder belt.



E142529

2. Pull down on the shoulder belt and then grasp the shoulder belt and lap belt together.

Child Safety



E142530

3. While holding the shoulder and lap belt portions together, route the tongue through the child seat according to the child seat manufacturer's instructions. Be sure the belt webbing is not twisted.



E142875

5. To put the retractor in the automatic locking mode, grasp the shoulder portion of the belt and pull downward until all of the belt is pulled out.

Note: *The automatic locking mode is available on the front passenger and rear seats.*

6. Allow the belt to retract to remove slack. The belt will click as it retracts to indicate it is in the automatic locking mode.
7. Try to pull the belt out of the retractor to make sure the retractor is in the automatic locking mode (you should not be able to pull more belt out). If the retractor is not locked, unbuckle the belt and repeat Steps 5 and 6.

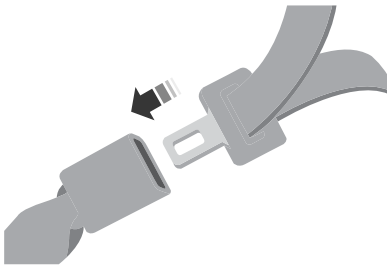

E142531

4. Insert the belt tongue into the proper buckle (the buckle closest to the direction the tongue is coming from) for that seating position until you hear a snap and feel the latch engage. Make sure the tongue is latched securely by pulling on it.



E142533

Child Safety

- Remove remaining slack from the belt. Force the seat down with extra weight, for example, by pressing down or kneeling on the child restraint while pulling up on the shoulder belt in order to force slack from the belt. This is necessary to remove the remaining slack that will exist once the extra weight of the child is added to the child restraint. It also helps to achieve the proper snugness of the child seat to your vehicle. Sometimes, a slight lean toward the buckle will additionally help to remove remaining slack from the belt.
- Attach the tether strap (if the child seat is equipped).

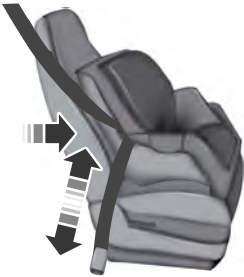

E142534

- Before placing the child in the seat, forcibly move the seat forward and back to make sure the seat is securely held in place. To check this, grab the seat at the belt path and attempt to move it side to side and forward and back. There should be no more than 1 inch (2.5 centimeters) of movement for proper installation.

Ford recommends checking with a NHTSA Certified Child Passenger Safety Technician to make certain the child restraint is properly installed. In Canada, check with your local St. John Ambulance office for referral to a Certified Passenger Seat Technician.

Using Lower Anchors and Tethers for Children (LATCH)

WARNINGS



Never attach two child safety seats to the same anchor. In a crash, one anchor may not be strong enough to hold two child safety seat attachments and may break, causing serious injury or death.



Depending on where you secure a child restraint, and depending on the child restraint design, you may block access to certain safety belt buckle assemblies or LATCH lower anchors, rendering those features potentially unusable. To avoid risk of injury, occupants should only use seating positions where they are able to be properly restrained.

The LATCH system is composed of three vehicle anchor points: two lower anchors located where the seatback and seat cushion meet (called the seat bight) and one top tether anchor located behind that seating position.

LATCH compatible child safety seats have two rigid or webbing mounted attachments that connect to the two lower anchors at the LATCH equipped seating positions in your vehicle. This type of attachment method eliminates the need to use safety belts to attach the child seat, however the safety belt can still be used to attach the child seat. For forward-facing child seats, the top tether strap must also be attached to the proper top tether anchor, if a top tether strap has been provided with your child seat.

Child Safety

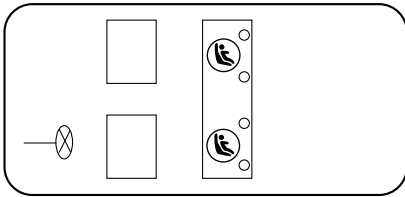

E142535

Your vehicle has LATCH lower anchors for child seat installation at the seating positions marked with the child seat symbol.

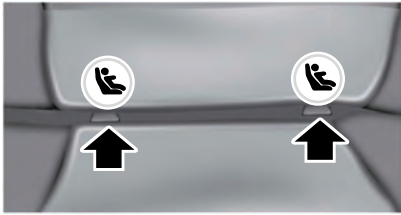

E169083

The LATCH anchors are located at the rear section of the rear seat between the cushion and seatback above the symbols as shown. Follow the child seat manufacturer's instructions to properly install a child seat with LATCH attachments. Follow the instructions on attaching child safety seats with tether straps.

Attach LATCH lower attachments of the child seat only to the anchors shown.

Use of Inboard Lower Anchors from the Outboard Seating Positions (Center Seating Use)

WARNING

 The standardized spacing for LATCH lower anchors is 11 inches (28 centimeters) center to center. Do not use LATCH lower anchors for the center seating position unless the child seat manufacturer's instructions permit and specify using anchors spaced at least as far apart as those in this vehicle.

The lower anchors at the center of the second row rear seat are spaced 18 inches (46 centimeters) apart. A child seat with rigid LATCH attachments cannot be installed at the center seating position. LATCH compatible child seats (with attachments on belt webbing) can only be used at this seating position provided that the child seat manufacturer's instructions permit use with the anchor spacing stated. Do not attach a child seat to any lower anchor if an adjacent child seat is attached to that anchor.

Each time you use the safety seat, check that the seat is properly attached to the lower anchors and tether anchor, if applicable. Tug the child seat from side to side and forward and back where it is secured to your vehicle. The seat should move less than one inch when you do this for a proper installation.

If the safety seat is not anchored properly, the risk of a child being injured in a crash greatly increases.

Child Safety

Combining Safety Belt and LATCH Lower Anchors for Attaching Child Safety Seats

When used in combination, either the safety belt or the LATCH lower anchors may be attached first, provided a proper installation is achieved. Attach the tether strap afterward, if included with the child seat.

Using Tether Straps



Many forward-facing child safety seats include a tether strap which extends from the back of the child safety seat and hooks to an anchoring point called the top tether anchor. Tether straps are available as an accessory for many older safety seats.

Contact the manufacturer of your child seat for information about ordering a tether strap, or to obtain a longer tether strap if the tether strap on your safety seat does not reach the appropriate top tether anchor in your vehicle.

The rear seats of your vehicle are equipped with built-in tether strap anchors located on the back panel of the rear seat.

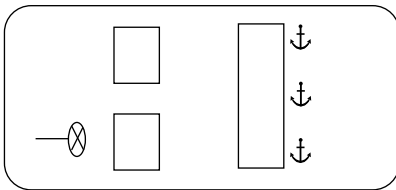

E142537

The tether strap anchors in your vehicle are in the following positions (shown from top view):

Attach the tether strap only to the appropriate tether anchor as shown. The tether strap may not work properly if attached somewhere other than the correct tether anchor.

Once the child safety seat has been installed using either the safety belt, the lower anchors of the LATCH system, or both, you can attach the top tether strap.

If you install a child seat with rigid LATCH attachments, do not tighten the tether strap enough to lift the child seat off the vehicle seat cushion when the child is seated in it. Keep the tether strap just snug without lifting the front of the child seat. Keeping the child seat just touching the vehicle seat gives the best protection in a severe crash.

Perform the following steps to install a child safety seat with tether anchors:

1. Route the child safety seat tether strap over the back of the seat. For outboard seating positions, route the tether strap under the head restraint and between the head restraint posts. For the center seating position, route the tether strap over the top of the head restraint. If needed, the head restraints can also be removed. See **Head Restraints** (page 104).



E164077

2. Locate the correct anchor for the selected seating position.

Child Safety



E187965

3. Rotate the tether hook, then move the hook under the anchor.



E187966

4. Clip the tether strap to the anchor as shown. If the tether strap is clipped incorrectly, the child safety seat may not be retained properly in the event of a crash.
5. Tighten the child safety seat tether strap according to the manufacturer's instructions.

If the safety seat is not anchored properly, the risk of a child being injured in a crash greatly increases.

If your child restraint system is equipped with a tether strap, and the child restraint manufacturer recommends its use, Ford also recommends its use.

BOOSTER SEATS

WARNING

 Never place, or allow a child to place, the shoulder belt under a child's arm or behind the back because it reduces the protection for the upper part of the body and may increase the risk of injury or death in a crash.

Use a belt-positioning booster seat for children who have outgrown or no longer properly fit in a child safety seat (generally children who are less than 4 feet 9 inches (1.45 meters) tall, are greater than age four (4) and less than age twelve (12), and between 40 pounds (18 kilograms) and 80 pounds (36 kilograms) and upward to 100 pounds (45 kilograms) if recommended by your child restraint manufacturer). Many state and provincial laws require that children use approved booster seats until they reach age eight, a height of 4 feet 9 inches (1.45 meters) tall, or 80 pounds (36 kilograms).

Booster seats should be used until you can answer YES to ALL of these questions when seated without a booster seat:

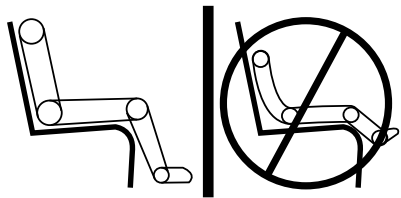

E142595

- Can the child sit all the way back against their vehicle seat back with knees bent comfortably at the edge of the seat cushion?
- Can the child sit without slouching?

Child Safety

- Does the lap belt rest low across the hips?
- Is the shoulder belt centered on the shoulder and chest?
- Can the child stay seated like this for the whole trip?

Always use booster seats in conjunction with your vehicle lap and shoulder belt.

Types of Booster Seats



E68924

- Backless booster seats

If your backless booster seat has a removable shield, remove the shield. If a vehicle seating position has a low seat back or no head restraint, a backless booster seat may place your child's head (as measured at the tops of the ears) above the top of the seat. In this case, move the backless booster to another seating position with a higher seat back or head restraint and lap and shoulder belts, or consider using a high back booster seat.



E70710

- High back booster seats

If, with a backless booster seat, you cannot find a seating position that adequately supports your child's head, a high back booster seat would be a better choice.

Children and booster seats vary in size and shape. Choose a booster that keeps the lap belt low and snug across the hips, never up across the stomach, and lets you adjust the shoulder belt to cross the chest and rest snugly near the center of the shoulder. The following drawings compare the ideal fit (center) to a shoulder belt uncomfortably close to the neck and a shoulder belt that could slip off the shoulder. The drawings also show how the lap belt should be low and snug across the child's hips.

Child Safety



E142596



E142597

If the booster seat slides on the vehicle seat upon which it is being used, placing a rubberized mesh sold as shelf or carpet liner under the booster seat may improve this condition. Do not introduce any item thicker than this under the booster seat. Check with the booster seat manufacturer's instructions.

CHILD SEAT POSITIONING

WARNINGS



Airbags can kill or injure a child in a child seat. Never place a rear-facing child seat in front of an active airbag. If you must use a forward-facing child seat in the front seat, move the vehicle seat upon which the child seat is installed all

WARNINGS

the way back. When possible, all children age 12 and under should be properly restrained in a rear seating position. If all children cannot be seated and restrained properly in a rear seating position, properly restrain the largest child in the front seat.



Always carefully follow the instructions and warnings provided by the manufacturer of any child restraint to determine if the restraint device is appropriate for your child's size, height, weight, or age. Follow the child restraint manufacturer's instructions and warnings provided for installation and use in conjunction with the instructions and warnings provided by your vehicle

Child Safety

WARNINGS

manufacturer. A safety seat that is improperly installed or utilized, is inappropriate for your child's height, age, or weight or does not properly fit the child may increase the risk of serious injury or death.



Never let a passenger hold a child on his or her lap while your vehicle is moving. The passenger cannot protect the child from injury in a crash, which may result in serious injury or death.



Never use pillows, books, or towels to boost a child. They can slide around and increase the likelihood of injury or death in a crash.

WARNINGS



Always restrain an unoccupied child seat or booster seat. These objects may become projectiles in a crash or sudden stop, which may increase the risk of serious injury.



Never place, or allow a child to place, the shoulder belt under a child's arm or behind the back because it reduces the protection for the upper part of the body and may increase the risk of injury or death in a crash.



To avoid risk of injury, do not leave children or pets unattended in your vehicle.

Recommendations for attaching child safety restraints for children

Restraint Type	Combined weight of child and child seat	Use any attachment method as indicated below by X				
		LATCH (lower anchors and top tether anchor)	LATCH (lower anchors only)	Safety belt and top tether anchor	Safety belt and LATCH (lower anchors and top tether anchor)	Safety belt only
Rear facing child seat	Up to 65 lb (29.5 kg)		X			X
Rear facing child seat	Over 65 lb (29.5 kg)					X
Forward facing child seat	Up to 65 lb (29.5 kg)	X		X	X	
Forward facing child seat	Over 65 lb (29.5 kg)			X	X	

Note: The child seat must rest tightly against the vehicle seat upon which it is installed. It may be necessary to lift or remove the head restraint. See **Seats** (page 104).

CHILD SAFETY LOCKS

When these locks are set, the rear doors cannot be opened from the inside.

Child Safety



E112197

The childproof locks are located on the rear edge of each rear door and must be set separately for each door.

Left-Hand Side

Turn counterclockwise to lock and clockwise to unlock.

Right-Hand Side

Turn clockwise to lock and counterclockwise to unlock.

Safety Belts

PRINCIPLE OF OPERATION

WARNINGS



Always drive and ride with your seat back upright and the lap belt snug and low across the hips.



To reduce the risk of injury, make sure children sit where they can be properly restrained.



Never let a passenger hold a child on his or her lap while your vehicle is moving. The passenger cannot protect the child from injury in a crash.



All occupants of your vehicle, including the driver, should always properly wear their safety belts, even when an airbag supplemental restraint system is provided. Failure to properly wear your safety belt could seriously increase the risk of injury or death.



It is extremely dangerous to ride in a cargo area, inside or outside of a vehicle. In a crash, people riding in these areas are more likely to be seriously injured or killed. Do not allow people to ride in any area of your vehicle that is not equipped with seats and safety belts. Be sure everyone in your vehicle is in a seat and using a safety belt properly.



In a rollover crash, an unbelted person is significantly more likely to die than a person wearing a safety belt.



Each seating position in your vehicle has a specific safety belt assembly which is made up of one buckle and one tongue that are designed to be used as a pair. 1) Use the shoulder belt on the outside shoulder only. Never wear the shoulder belt under the arm. 2) Never swing the safety belt around your neck over the inside shoulder. 3) Never use a single belt for more than one person.

WARNINGS



When possible, all children 12 years old and under should be properly restrained in a rear seating position. Failure to follow this could seriously increase the risk of injury or death.



Safety belts and seats can become hot in a vehicle that has been closed up in sunny weather; they could burn a small child. Check seat covers and buckles before you place a child anywhere near them.



Front and rear seat occupants, including pregnant women, should wear safety belts for optimum protection in an accident.

All seating positions in your vehicle have lap and shoulder safety belts. All occupants of the vehicle should always properly wear their safety belts, even when an airbag supplemental restraint system is provided.

The safety belt system consists of:

- lap and shoulder safety belts.
- shoulder safety belt with automatic locking mode, (except driver safety belt).
- height adjuster at the front outboard seating positions.
- safety belt pretensioner at the front outboard seating positions.
- belt tension sensor at the front outboard passenger seating position.



- Safety belt warning light and chime.



Safety Belts

- Crash sensors and monitoring system with readiness indicator.

The safety belt pretensioners at the front seating positions are designed to tighten the safety belts when activated. In frontal and near-frontal crashes, the safety belt pretensioners may be activated alone or, if the crash is of sufficient severity, together with the front airbags. The pretensioners may also activate when a side curtain airbag is deployed.

FASTENING THE SAFETY BELTS

The front outboard and rear safety restraints in the vehicle are combination lap and shoulder belts.



E142587

1. Insert the belt tongue into the proper buckle (the buckle closest to the direction the tongue is coming from) until you hear a snap and feel it latch. Make sure the tongue is securely fastened in the buckle.

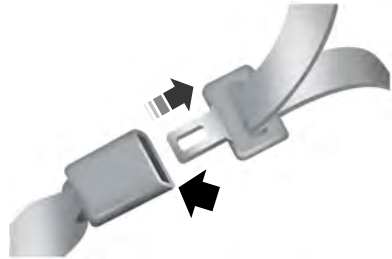

E142588

2. To unfasten, press the release button and remove the tongue from the buckle.

Using Safety Belts During Pregnancy

WARNING



Always ride and drive with your seatback upright and the safety belt properly fastened. The lap portion of the safety belt should fit snug and be positioned low across the hips. The shoulder portion of the safety belt should be positioned across the chest. Pregnant women should also follow this practice. See the following figure.

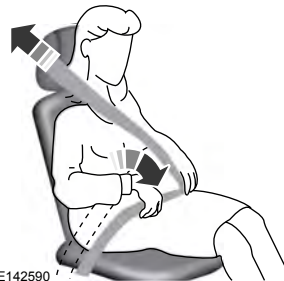

E142590

Safety Belts

Pregnant women should always wear their safety belt. The lap belt portion of a combination lap and shoulder belt should be positioned low across the hips below the belly and worn as tight as comfort will allow. The shoulder belt should be positioned to cross the middle of the shoulder and the center of the chest.

Safety Belt Locking Modes

WARNINGS



After any vehicle crash, the safety belt system at all passenger seating positions must be checked by an authorized dealer to verify that the automatic locking retractor feature for child seats is still functioning properly. In addition, all safety belts should be checked for proper function.



The belt and retractor assembly must be replaced if the safety belt assembly automatic locking retractor feature or any other safety belt function is not operating properly when checked by an authorized dealer. Failure to replace the belt and retractor assembly could increase the risk of injury in crashes.

All safety restraints in the vehicle are combination lap and shoulder belts. The driver safety belt has the first type of locking mode. The front outboard passenger and rear seat safety belts have both types of locking modes described as follows:

Vehicle Sensitive Mode

This is the normal retractor mode, which allows free shoulder belt length adjustment to your movements and locking in response to vehicle movement. For example, if the driver brakes suddenly or turns a corner sharply, or the vehicle receives an impact of about 5 mph (8 km/h) or more, the combination safety belts will lock to help reduce forward movement of the driver and passengers.

In addition, the retractor is designed to lock if the webbing is pulled out too quickly. If this occurs, let the belt retract slightly and pull webbing out again in a slow and controlled manner.

Automatic Locking Mode

In this mode, the shoulder belt is automatically pre-locked. The belt will still retract to remove any slack in the shoulder belt. The automatic locking mode is not available on the driver safety belt.

When to Use the Automatic Locking Mode

This mode should be used any time a child safety seat, except a booster, is installed in passenger front or rear seating positions. Children 12 years old and under should be properly restrained in a rear seating position whenever possible. See **Child Safety** (page 17).

Safety Belts

How to Use the Automatic Locking Mode



E142591

1. Buckle the combination lap and shoulder belt.
2. Grasp the shoulder portion and pull downward until the entire belt is pulled out.

Allow the belt to retract. As the belt retracts, you will hear a clicking sound. This indicates the safety belt is now in the automatic locking mode.

How to Disengage the Automatic Locking Mode

Unbuckle the combination lap and shoulder belt and allow it to retract completely to disengage the automatic locking mode and activate the vehicle sensitive (emergency) locking mode.

Safety Belt Extension Assembly

WARNING



Do not use extensions to change the fit of the shoulder belt across the torso.

If the safety belt is too short when fully extended, a safety belt extension assembly can be obtained from an authorized dealer.

Use only extensions manufactured by the same supplier as the safety belt. Manufacturer identification is on a label located either at the end of the webbing or on the retractor behind the trim. Also, use the safety belt extension only if the safety belt is too short for you when fully extended.

SAFETY BELT HEIGHT ADJUSTMENT

WARNING



Position the safety belt height adjuster so that the belt rests across the middle of your shoulder. Failure to adjust the safety belt properly could reduce the effectiveness of the safety belt and increase the risk of injury in a crash.

Adjust the height of the shoulder belt so the belt rests across the middle of your shoulder.



E183582

To adjust the shoulder belt height:

1. Press the button and slide the height adjuster up or down.

Safety Belts

2. Release the button and pull down on the height adjuster to make sure it is locked in place.

SAFETY BELT WARNING LAMP AND INDICATOR CHIME



This lamp illuminates and an audible warning will sound if the driver's safety belt has not been fastened when the vehicle's ignition is turned on.

Conditions of operation

If...	Then...
The driver's safety belt is not buckled before the ignition switch is turned to the on position...	The safety belt warning light illuminates 1-2 minutes and the warning chime sounds 4-8 seconds.
The driver's safety belt is buckled while the indicator light is illuminated and the warning chime is sounding...	The safety belt warning light and warning chime turn off.
The driver's safety belt is buckled before the ignition switch is turned to the on position...	The safety belt warning light and indicator chime remain off.

SAFETY BELT MINDER

Belt-Minder™

This feature supplements the safety belt warning function by providing additional reminders that intermittently sound a tone and illuminate the safety belt warning light when you are in the driver seat or you have a front seat passenger and a safety belt is unbuckled.

The system uses information from the front passenger sensing system to determine if a front seat passenger is present and therefore potentially in need of a warning. To avoid activating the Belt-Minder feature for objects you place in the front passenger seat, only the front seat passengers receive warnings as determined by the front passenger sensing system.

If the Belt-Minder warnings expire (warnings for about five minutes) for one passenger (driver or front passenger), the other passenger can still cause the Belt-Minder feature to turn on.

Safety Belts

If...	Then...
You and the front seat passenger buckle your safety belts before you switch the ignition on or less than 1-2 minutes elapse after you switch the ignition on...	The Belt-Minder feature will not activate.
You or the front seat passenger do not buckle your safety belts before your vehicle reaches at least 6 mph (9.7 km/h) and 1-2 minutes elapse after you switch the ignition on...	The Belt-Minder feature activates, the safety belt warning light illuminates and a warning tone sounds for 6 seconds every 25 seconds, repeating for about 5 minutes or until you and the front seat passenger buckle your safety belts.
The safety belt for the driver or front passenger is unbuckled for about 1 minute while the vehicle is traveling at least 6 mph (9.7 km/h) and more than 1-2 minutes elapse after you switch the ignition on...	The Belt-Minder feature activates, the safety belt warning light illuminates and a warning tone sounds for 6 seconds every 25 seconds, repeating for about 5 minutes or until you and the front seat passenger buckle your safety belts.

Deactivating and Activating the Belt-Minder Feature

WARNING



While the system allows you to deactivate it, this system is designed to improve your chances of being safely belted and surviving an accident. We recommend you leave the system activated for yourself and others who may use the vehicle.

Note: *The driver and front passenger warnings switch on and off independently. When you perform this procedure for one seating position, do not buckle the other position as this will terminate the process.*

Read Steps 1 - 4 thoroughly before proceeding with the programming procedure.

Before following the procedure, make sure that:

- The parking brake is set.
 - The transmission is in park (P).
 - The ignition is off.
 - The driver and front passenger safety belts are unbuckled.
1. Switch the ignition on. Do not start the vehicle (Ready to Drive light must not be lit).
 2. Wait until the safety belt warning light turns off (about one minute). Once you start Step 3, you must complete the procedure within 60 seconds.
 3. For the seating position you are switching off, buckle then unbuckle the safety belt four times at a moderate speed, ending in the unbuckled state. After Step 3, the safety belt warning light turns on.

Safety Belts

4. While the safety belt warning light is on, buckle and then unbuckle the safety belt. After Step 4, the safety belt warning light flashes for confirmation.
 - This will switch the feature off for that seating position if it is currently on.
 - This will switch the feature on for that seating position if it is currently off.

CHILD RESTRAINT AND SAFETY BELT MAINTENANCE

Inspect the vehicle safety belts and child safety seat systems periodically to make sure they work properly and are not damaged. Inspect the vehicle and child seat safety belts to make sure there are no nicks, tears or cuts. Replace if necessary. All vehicle safety belt assemblies, including retractors, buckles, front safety belt buckle assemblies, buckle support assemblies (slide bar-if equipped), shoulder belt height adjusters (if equipped), shoulder belt guide on seat back (if equipped), child safety seat LATCH and tether anchors, and attaching hardware, should be inspected after a crash. Read the child restraint manufacturer's instructions for additional inspection and maintenance information specific to the child restraint.

Ford Motor Company recommends that all safety belt assemblies in use in vehicles involved in a crash be replaced. However, if the crash was minor and an authorized dealer finds that the belts do not show damage and continue to operate properly, they do not need to be replaced. Safety belt assemblies not in use during a crash should also be inspected and replaced if either damage or improper operation is noted.

Properly care for safety belts. See **Vehicle Care** (page 182).

Personal Safety System™

The Personal Safety System provides an improved overall level of frontal crash protection to front seat occupants and is designed to help further reduce the risk of airbag-related injuries. The system is able to analyze different occupant conditions and crash severity before activating the appropriate safety devices to help better protect a range of occupants in a variety of frontal crash situations.

The Vehicle Personal Safety System consists of:

- Driver and passenger dual-stage airbag supplemental restraints.
- Front seat outboard safety belts with pretensioners, energy management retractors and safety belt usage sensors.
- Driver seat position sensor.
- Front passenger sensing system.
- Passenger airbag off and on indicator lamp.
- Front crash severity sensors.
- Restraints control module with impact and safing sensors.
- Restraint system warning light and backup tone.
- The electrical wiring for the airbags, crash sensors, safety belt pretensioners, front safety belt usage sensors, driver seat position sensor, front passenger sensing system and indicator lights.

How Does the Personal Safety System Work?

The Personal Safety System can adapt the deployment strategy of the safety devices according to crash severity and occupant conditions. A collection of crash and occupant sensors provides information to the restraints control module. During a crash, the restraints control module may deploy the safety belt pretensioners, one or both stages of the dual-stage airbags based on crash severity and occupant conditions.

Supplementary Restraints System

PRINCIPLE OF OPERATION

WARNINGS

 Airbags do not inflate slowly or gently, and the risk of injury from a deploying airbag is the greatest close to the trim covering the airbag module.

 All occupants of your vehicle, including the driver, should always properly wear their safety belts, even when an airbag supplemental restraint system is provided. Failure to properly wear your safety belt could seriously increase the risk of injury or death.

 Always transport children 12 years old and under in the back seat and always properly use appropriate child restraints. Failure to follow this could seriously increase the risk of injury or death.

 Never place your arm over the airbag module as a deploying airbag can result in serious arm fractures or other injuries.

 Airbags can kill or injure a child in a child seat. Never place a rear-facing child seat in front of an active airbag. If you must use a forward-facing child seat in the front seat, move the seat upon which the child seat is installed all the way back.

 Do not attempt to service, repair, or modify the airbag supplemental restraint systems or its fuses as you could be seriously injured or killed. Contact your authorized dealer as soon as possible.

 Several airbag system components get hot after inflation. To reduce the risk of injury, do not touch them after inflation.

 If the airbag has deployed, the airbag will not function again and must be replaced immediately. If the airbag is not replaced, the unrepaired area will increase the risk of injury in a crash.

The airbags are a supplemental restraint system and are designed to work with the safety belts to help protect the driver and right front passenger from certain upper body injuries. Airbags do not inflate slowly; there is a risk of injury from a deploying airbag.

Note: *You will hear a loud bang and see a cloud of harmless powdery residue if an airbag deploys. This is normal.*

The airbags inflate and deflate rapidly upon activation. After airbag deployment, it is normal to notice a smoke-like, powdery residue or smell the burnt propellant. This may consist of cornstarch, talcum powder (to lubricate the bag) or sodium compounds (for example, baking soda) that result from the combustion process that inflates the airbag. Small amounts of sodium hydroxide may be present which may irritate the skin and eyes, but none of the residue is toxic.

While the system is designed to help reduce serious injuries, contact with a deploying airbag may also cause abrasions or swelling. Temporary hearing loss is also a possibility as a result of the noise associated with a deploying airbag. Because airbags must inflate rapidly and with considerable force, there is the risk of death or serious injuries such as fractures, facial and eye injuries or internal injuries, particularly to occupants who are not properly restrained or are otherwise out of position at the time of airbag deployment. Thus, it is extremely important that occupants be properly restrained as far away from the airbag module as possible while maintaining vehicle control.

Routine maintenance of the airbags is not required.

Supplementary Restraints System

DRIVER AND PASSENGER AIRBAGS

WARNINGS



Never place your arm or any objects over an airbag module. Placing your arm over a deploying airbag can result in serious arm fractures or other injuries. Objects placed on or over the airbag inflation area may cause those objects to be propelled by the airbag into your face and torso causing serious injury.



Airbags can kill or injure a child in a child seat. Never place a rear-facing child seat in front of an active airbag. If you must use a forward-facing child seat in the front seat, move the seat upon which the child seat is installed all the way back.

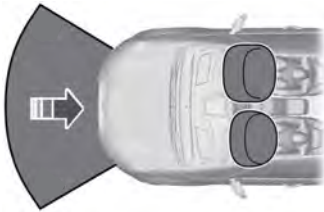

E151127

The driver and front passenger airbags will deploy during significant frontal and near frontal crashes.

The driver and passenger front airbag system consists of:

- Driver and passenger airbag modules.
- Front passenger sensing system.



• Crash sensors and monitoring system with readiness indicator. See **Crash Sensors and Airbag**

Indicator (page 44).

Proper Driver and Front Passenger Seating Adjustment

WARNING



National Highway Traffic Safety Administration (NHTSA) recommends a minimum distance of at least 10 inches (25 centimeters) between an occupant's chest and the driver airbag module.

To properly position yourself away from the airbag:

- Move your seat to the rear as far as you can while still reaching the pedals comfortably.
- Recline the seat slightly (one or two degrees) from the upright position.

After all occupants have adjusted their seats and put on safety belts, it is very important that they continue to sit properly. A properly seated occupant sits upright, leaning against the seat back, and centered on the seat cushion, with their feet comfortably extended on the floor. Sitting improperly can increase the chance of injury in a crash event. For example, if an occupant slouches, lies down, turns sideways, sits forward, leans forward or sideways, or puts one or both feet up, the chance of injury during a crash is greatly increased.

Children and Airbags

WARNING



Airbags can kill or injure a child in a child seat. Never place a rear-facing child seat in front of an active airbag. If you must use a forward-facing child seat in the front seat, move the seat upon which the child seat is installed all the way back.

Supplementary Restraints System



E142846

Children must always be properly restrained. Accident statistics suggest that children are safer when properly restrained in the rear seating positions than in the front seating position. Failure to follow these instructions may increase the risk of injury in a crash.

FRONT PASSENGER SENSING SYSTEM

WARNINGS



Even with Advanced Restraints Systems, children 12 and under should be properly restrained in a rear seating position. Failure to follow this could seriously increase the risk of injury or death.



Sitting improperly out of position or with the seatback reclined too far can take off weight from the seat cushion and affect the decision of the front passenger sensing system, resulting in serious injury or death in a crash. Always sit upright against your seatback, with your feet on the floor.



To reduce the risk of possible serious injury: Do not stow objects in the seatback map pocket (if equipped) or hang objects off the seatback if a child is in the front passenger seat. Do not place objects underneath the front passenger

WARNINGS

seat or between the seat and the center console (if equipped). Check the passenger airbag off indicator lamp for proper airbag status. Failure to follow these instructions may interfere with the passenger seat sensing system.



Any alteration or modification to the front passenger seat may affect the performance of the front passenger sensing system which could seriously increase the risk of injury or death.

This system works with sensors that are part of the front passenger seat and safety belt to detect the presence of a properly-seated occupant and determine if the front passenger frontal airbag should be enabled (may inflate) or not.



E188175

The front passenger sensing system uses a passenger airbag status indicator that illuminates indicating that the front passenger frontal airbag is either ON (enabled) or OFF (disabled).

The indicator lamp is located in the center stack of the instrument panel.

Note: *The passenger airbag status indicator OFF and ON indicator lamps illuminate for a short period of time when the ignition is first turned on to confirm it is functional.*

Supplementary Restraints System

The front passenger sensing system is designed to disable (will not inflate) the front passenger frontal airbag when the front passenger seat is unoccupied, or a rear facing infant seat, a forward-facing child restraint, or a booster seat is detected. Even with this technology, parents are **strongly** encouraged to always properly restrain children in the rear seat. The sensor also turns off the passenger front airbag and seat-mounted side airbag when the passenger seat is empty.

- When the front passenger sensing system disables (will not inflate) the front passenger frontal airbag, the passenger airbag status indicator illuminates the OFF lamp and stays lit to remind you that the front passenger frontal airbag is disabled.
- If the child restraint has been installed and the passenger airbag status indicator illuminates the ON lamp, then turn the vehicle off, remove the child restraint from the vehicle and reinstall the restraint following the child restraint manufacturer's instructions.

The front passenger sensing system is designed to enable (may inflate) the front passenger's frontal airbag anytime the system senses that a person of adult size is sitting properly in the front passenger seat.

- When the front passenger sensing system enables the front passenger frontal airbag (may inflate), the passenger airbag status indicator illuminates the ON lamp and remains illuminated.

If a person of adult size is sitting in the front passenger seat, but the airbag off indicator lamp is lit, it is possible that the person is not sitting properly in the seat. If this happens:

- Turn the vehicle off and ask the person to place the seatback in the full upright position.
- Have the person sit upright in the seat, centered on the seat cushion, with the person's legs comfortably extended.
- Restart the vehicle and have the person remain in this position for about two minutes. This allows the system to detect that person and enable the passenger's frontal airbag.
- If the indicator OFF lamp remains lit even after this, the person should be advised to ride in the rear seat.

Occupant	Passenger airbag status indicator	Passenger airbag
Empty	OFF: Lit	Disabled
	ON: Unlit	
Child	OFF: Lit	Disabled
	ON: Unlit	
Adult	OFF: Unlit	Enabled
	ON: Lit	

Supplementary Restraints System

After all occupants have adjusted their seats and put on safety belts, it is very important that they continue to sit properly. A properly seated occupant sits upright, leaning against the seatback, and centered on the seat cushion, with their feet comfortably extended on the floor. Sitting improperly can increase the chance of injury in a crash event. For example, if an occupant slouches, lies down, turns sideways, sits forward, leans forward or sideways, or puts one or both feet up, the chance of injury during a crash is greatly increased.

If you think that the status of the passenger airbag indicator lamp is incorrect, check for the following:

- Objects lodged underneath the seat.
- Objects between the seat cushion and the center console.
- Objects hanging off the seatback.
- Objects stowed in the seatback map pocket.
- Objects placed on the occupant's lap.
- Cargo interference with the seat.
- Other passengers pushing or pulling on the seat.
- Rear passenger feet and knees resting or pushing on the seat.

The conditions listed above may cause the weight of a properly seated occupant to be incorrectly interpreted by the front passenger sensing system. The person in the front passenger seat may appear heavier or lighter due to the conditions described in the list above.



Make sure the front passenger sensing system is operating properly. See **Crash Sensors and Airbag Indicator** (page 44).

If the airbag readiness lamp is lit, do the following:

The driver or adult passengers should check for any objects that may be lodged underneath the front passenger seat or cargo interfering with the seat.

If objects are lodged or cargo is interfering with the seat, please take the following steps to remove the obstruction:

- Pull the vehicle over.
- Turn the vehicle off.
- Driver or adult passengers should check for any objects lodged underneath the front passenger seat or cargo interfering with the seat.
- Remove the obstruction(s) (if found).
- Restart the vehicle.
- Wait at least two minutes and verify that the airbag readiness lamp is no longer illuminated
- If the airbag readiness lamp remains illuminated, this may or may not be a problem due to the front passenger sensing system.

Do not attempt to repair or service the system. Take your vehicle immediately to an authorized dealer.

If it is necessary to modify an advanced front airbag system to accommodate a person with disabilities, contact the Ford Customer Relationship Center. See **Getting the Services You Need** (page 152).

SIDE AIRBAGS

WARNINGS



Do not place objects or mount equipment on or near the airbag cover, on the side of the seatbacks (of the front seats), or in front seat areas that may come into contact with a deploying airbag. Failure to follow these instructions may increase the risk of personal injury in the event of a crash.

Supplementary Restraints System

WARNINGS



Do not use accessory seat covers. The use of accessory seat covers may prevent the deployment of the side airbags and increase the risk of injury in an accident.



Do not lean your head on the door. The side airbag could injure you as it deploys from the side of the seatback.



Do not attempt to service, repair, or modify the airbag, its fuses or the seat cover on a seat containing an airbag as you could be seriously injured or killed. Contact your authorized dealer as soon as possible.



If the side airbag has deployed, the airbag will not function again. The side airbag system (including the seat) must be inspected and serviced by an authorized dealer. If the airbag is not replaced, the unrepaired area will increase the risk of injury in a crash.

The side airbags are located on the outboard side of the seatbacks of the front seats. In certain sideways crashes, the airbag on the side affected by the crash will be inflated. The airbag was designed to inflate between the door panel and occupant to further enhance the protection provided occupants in side impact crashes.



E152533

The system consists of the following:

- A label or embossed side panel indicating that side airbags are fitted to your vehicle.
- Side airbags located inside the driver and front passenger seatbacks.
- Front passenger sensing system.



Crash sensors and monitoring system with readiness indicator. See **Crash Sensors and Airbag Indicator** (page 44).

Note: *The passenger sensing system will deactivate the passenger seat-mounted side airbag if it detects an empty passenger seat.*

The design and development of the side airbag system included recommended testing procedures that were developed by a group of automotive safety experts known as the Side Airbag Technical Working Group. These recommended testing procedures help reduce the risk of injuries related to the deployment of side airbags.

DRIVER KNEE AIRBAG

A driver's knee airbag is located under the instrument panel. During a crash, the restraints control module may activate the driver's knee airbag based on crash severity and occupant conditions. Under certain crash and occupant conditions, the driver's knee airbag may deploy but the driver's front airbag may not activate. As with front and side airbags, it is important to be properly seated and restrained to reduce the risk of death or serious injury.





Make sure the knee airbag is operating properly. See **Crash Sensors and Airbag Indicator** (page 44).

Supplementary Restraints System

SIDE CURTAIN AIRBAGS

WARNINGS

 Do not place objects or mount equipment on or near the headliner at the siderail that may come into contact with a deploying side curtain airbag. Failure to follow these instructions may increase the risk of personal injury in the event of a crash.

 Do not lean your head on the door. The side curtain airbag could injure you as it deploys from the headliner.

 Do not attempt to service, repair, or modify the side curtain airbags, its fuses, the A, B, or C pillar trim, or the headliner on a vehicle containing side curtain airbags. Contact your authorized dealer as soon as possible.

 All occupants of the vehicle including the driver should always wear their safety belts even when an airbag supplemental restraint system and side curtain airbag is provided. Failure to properly wear your safety belt could seriously increase the risk of injury or death.

 To reduce risk of injury, do not obstruct or place objects in the deployment path of the side curtain airbag.

 If the side curtain airbags have deployed, the side curtain airbags will not function again. The side curtain airbags (including the A, B and C pillar trim and headliner) must be inspected and serviced by an authorized dealer. If the side curtain airbag is not replaced, the unrepaired area will increase the risk of injury in a crash.

In certain sideways crashes, the side curtain airbag on the side affected by the crash will be inflated. The side curtain airbags are mounted to the roof side-rail sheet metal, behind the headliner, above each row of seats. The side curtain airbags are designed to inflate between the side window area and occupants to further enhance protection provided in side impact crashes.

The system consists of the following:

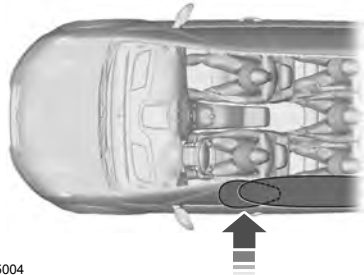

E75004

- Side curtain airbags located above the trim panels over the front and rear side windows identified by a label or wording on the headliner or roof-pillar trim.
- A flexible headliner which opens above the side doors to allow side air curtain deployment.



- Crash sensors and monitoring system with readiness indicator. See **Crash Sensors and Airbag Indicator** (page 44).

Children 12 years old and under should always be properly restrained in the back seats. The side curtain airbags will not interfere with children restrained using a properly installed child or booster seat because it is designed to inflate downward from the headliner above the doors along the side window opening.

Supplementary Restraints System

The design and development of the side curtain airbags included recommended testing procedures that were developed by a group of automotive safety experts known as the Side Airbag Technical Working Group. These recommended testing procedures help reduce the risk of injuries related to the deployment of side curtain airbags.

CRASH SENSORS AND AIRBAG INDICATOR

WARNING



Do not modify the front end of your vehicle. Modifying or adding equipment to the front end of your vehicle, including frame, bumper, front end body structure or tow hooks, may affect the performance of the airbag system, increasing the risk of injury.

Your vehicle has a collection of crash and occupant sensors. These provide information to the restraints control module which will deploy the front safety belt pretensioners, driver airbag, driver knee airbag, passenger airbag, seat mounted side airbags, and the side curtain airbags. Based on the type of crash, frontal impact or side impact, the restraints control module will deploy the appropriate safety devices.

The restraints control module also monitors the readiness of the above safety devices plus the crash and occupant sensors. The readiness of the safety system is indicated by a warning lamp in the instrument cluster or by a backup tone if the warning lamp is not working. Routine maintenance of the airbag is not required.

A difficulty with the system is indicated by one or more of the following:



The lamp will not illuminate immediately when you switch the ignition on.

- The lamp will either flash or remain on.
- A series of five beeps will be heard. The tone pattern will repeat periodically until the problem, the lamp or both are repaired.

If any of these things happen, even intermittently, have the supplemental restraint system checked by an authorized dealer immediately. Unless serviced, the system may not function correctly in the event of a crash.

The safety belt pretensioners and the front airbag supplemental restraint system are designed to deploy when your vehicle sustains longitudinal deceleration sufficient to cause the restraints control module to deploy a safety device.

The fact that the safety belt pretensioners or front airbags did not deploy for both front seat occupants in a crash does not mean that something is wrong with the system. It means the restraints control module determined that the crash conditions were not appropriate to deploy these safety devices.

- The design of the front airbags is to deploy only in frontal and near-frontal crashes (not rollovers, side impacts or rear impacts) unless the crash causes sufficient longitudinal deceleration.
- The design of the safety belt pretensioners is to deploy in frontal and near-frontal crashes, and may also deploy when a side curtain airbag deploys.

Supplementary Restraints System

- The knee airbag may deploy based on crash severity and occupant conditions.
- The design of the side airbags and side curtain airbags is to deploy in certain side impact crashes. These devices may deploy in other types of crashes if your vehicle experiences sufficient sideways motion or deformation.

AIRBAG DISPOSAL

Contact your authorized dealer as soon as possible. Airbags must be disposed of by qualified personnel.

Keys and Remote Controls

GENERAL INFORMATION ON RADIO FREQUENCIES

This device complies with Part 15 of the FCC Rules and with Industry Canada license-exempt RSS standard(s). Operation is subject to the following two conditions: (1) This device may not cause harmful interference, and (2) This device must accept any interference received, including interference that may cause undesired operation.

Note: *Changes or modifications not expressly approved by the party responsible for compliance could void the user's authority to operate the equipment. The term IC before the radio certification number only signifies that Industry Canada technical specifications were met.*

The typical operating range for your transmitter is approximately 33 feet (10 meters). Vehicles with the remote start feature will have a greater range. One of the following could cause a decrease in operating range:

- weather conditions
- nearby radio towers
- structures around the vehicle
- other vehicles parked next to your vehicle

The radio frequency used by your remote control can also be used by other short distance radio transmissions, for example amateur radios, medical equipment, wireless headphones, remote controls and alarm systems. If the frequencies are jammed, you will not be able to use your remote control. You can lock and unlock the doors with the key.

Note: *Make sure to lock your vehicle before leaving it unattended.*

Note: *If you are in range, the remote control will operate if you press any button unintentionally.*

Note: *The remote control contains sensitive electrical components. Exposure to moisture or impact may cause permanent damage.*

REMOTE CONTROL

Intelligent Access Key (If Equipped)



E138616

The intelligent access keys operate the power locks and the remote start system. The key must be in your vehicle to use the push button start.

Key Blade

The intelligent access key also contains a removable key blade that you can use to unlock your vehicle.



E142431

Slide the release on the back of the transmitter, then pull the blade out.

Keys and Remote Controls



E138618

Note: Your vehicle keys came with a security label that provides important key cut information. Keep the label in a safe place for future reference.

Programming a New Remote Control

To program an additional remote control See **Security** (page 64).

Changing the Remote Control Battery

The remote control uses one coin-type three-volt lithium battery CR2032 or equivalent.



Make sure that you dispose of old batteries in an environmentally friendly way.

Seek advice from your local authority about recycling old batteries.

1. Remove the key blade from the transmitter.



E142432

2. Twist a thin coin under the tab hidden behind the key blade head to remove the battery cover.



E138622

3. Remove the old battery.
4. Insert a new battery with the **+** facing downward. Press the battery down to make sure it is fully in the housing.
5. Reinstall the battery housing cover onto the transmitter and install the key blade.

Note: Do not wipe off any grease on the battery terminals or on the back surface of the circuit board.

Note: Replacing the battery does not delete the transmitter from your vehicle. The transmitter should operate normally.

Locating Your Vehicle

Press the lock button on the key twice within three seconds. The horn sounds and the direction indicators flash. We recommend you use this method to locate your vehicle, rather than using the panic alarm.

The horn sounds twice and the direction indicators do not flash if:

- Locking was not successful.
- Any door or the liftgate is open.
- The hood is open on vehicles with an anti-theft alarm or remote start.

Keys and Remote Controls

Sounding the Panic Alarm (If Equipped)



Press the button to activate the alarm. Press the button again or switch your vehicle on to deactivate it.

Note: *The panic alarm only operates when your vehicle is switched off.*

Remote Start



The remote start button is on the transmitter.

This feature allows you to start your vehicle from the outside. The transmitter has an extended operating range.

Vehicles with automatic climate control can be configured to operate when your vehicle is remote started. See **Automatic Climate Control** (page 100).

Many states and provinces have restrictions for the use of remote start. Check your local and state or provincial laws for specific requirements regarding remote start systems.

The remote start system does not work if any of the following occur:

- Your vehicle is switched on.
- The alarm system activates.
- You turn off the feature.
- The hood is open.
- The transmission is not in park (P).
- Your vehicle battery has no charge.
- The powertrain fault indicator was on the last time you drove your vehicle.

Remote Starting your Vehicle

Note: *You must press each button within three seconds of each other. If you do not follow this sequence, your vehicle does not start remotely, the direction indicators do not flash twice and the horn does not sound.*

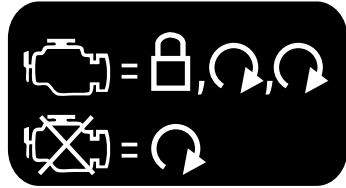

E138626

The label on your transmitter details the starting procedure.

To remote start your vehicle:

1. Press the lock button to lock all the doors.
2. Press the remote start button twice. The direction indicators flash twice.

The horn sounds if the system fails to start, unless quiet start is on. Quiet start runs the blower fan at a slower speed to reduce noise. You can switch the feature on or off using the information display. See (page 86).

The power windows do not work during remote start and the radio does not turn on automatically.

The parking lamps remain on and your vehicle runs for 5, 10 or 15 minutes, depending on the setting.

Note: *If you remote start your vehicle with an intelligent access transmitter, you must press the **START STOP** button on the instrument panel once while applying the brake pedal before driving your vehicle.*

Extending the Remote Start Running Time

To extend the remote start running time duration of your vehicle during remote start, repeat steps 1 and 2 while your vehicle is running. For example, if your vehicle had been running from the first remote start for 5 minutes, your vehicle

Keys and Remote Controls

continues to run now for a total of 20 minutes. If the duration is set to 10 minutes, the duration extends by another 10 minutes. You can extend the remote start running time duration to a maximum of 30 minutes.

Wait at least five seconds before remote starting after you switch your vehicle off.

Turning Your Vehicle Off After Remote Starting



Press the button once. The parking lamps turn off.

You may have to be closer to your vehicle than when starting due to ground reflection and the added noise of the running vehicle.

You can turn the remote start system on or off using the information display. See (page 86).

REPLACING A LOST KEY OR REMOTE CONTROL

You can purchase replacement keys or remote controls from an authorized dealer. Authorized dealers can program remote controls for your vehicle. See **Passive Anti-Theft System** (page 64).

To re-program the passive anti-theft system see an authorized dealer.

PRINCIPLE OF OPERATION

MyKey allows you to program keys with restricted driving modes to promote good driving habits. All but one of the keys can be activated with these restricted modes.

Any keys that remain unprogrammed are referred to as administrator keys or admin keys. They can be used to:

- Create a MyKey.
- Program configurable MyKey settings.
- Clear all MyKey features.

When you have created a MyKey, you can access the following information by using the information display to determine:

- How many admin keys and MyKeys are programmed to your vehicle.
- The total distance your vehicle traveled with a MyKey.

Note: *Switch the ignition on to use the system.*

Note: *All MyKeys are programmed to the same settings. You cannot program them individually.*

Note: *For vehicles equipped with a push-button start, when both a MyKey and an admin key are present, the admin key will be recognized by the vehicle while switching the vehicle on to start.*

Non-configurable Settings

The following settings cannot be changed by an admin key user:

- Safety belt reminder. You cannot disable this feature. The audio system will mute when the front seat passengers' safety belts are not fastened.
- Early low charge. The low-charge warning activates earlier, giving the MyKey user more time to recharge.
- Driver assist features, if equipped on your vehicle, are forced on: parking aid.

Configurable Settings

With an admin key, you can configure certain MyKey settings when you first create a MyKey and before you recycle the key or restart the engine. You can also change the settings afterward with an admin key.

- A vehicle speed limit can be set. Warnings will be shown in the display followed by an audible tone when your vehicle reaches the set speed. You cannot override the set speed by fully depressing the accelerator pedal or by setting cruise control.

WARNING



Do not set MyKey maximum speed limit to a limit that will prevent the driver from maintaining a safe speed considering posted speed limits and prevailing road conditions. The driver is always responsible to drive in accordance with local laws and prevailing conditions. Failure to do so could result in accident or injury.

- Various vehicle speed minders can be set. Once you select a speed, it will be shown in the display, followed by an audible tone when the preselected vehicle speed is exceeded.
- Audio system maximum volume of 45%. A message will be shown in the display when you attempt to exceed the limited volume. Also, the speed-sensitive or compensated automatic volume control will be disabled.
- Always on setting. When this is selected, you will not be able to turn off AdvanceTrac or traction control (if your vehicle is equipped with these features).

CREATING A MYKEY

Use the information display to create a MyKey:

1. Insert the key you want to program into the ignition. If your vehicle is equipped with a push-button start, place the intelligent access transmitter into the backup position. The location of your backup position is in another chapter. See **Starting the Electric Motor** (page 112).
2. Switch the vehicle on.
3. Access the main menu through the information display controls. Use the arrow keys to get to the following menu selections:

Message	Action and Description
Settings	Press the OK button or the right arrow key.
MyKey	Press the OK button or the right arrow key.
Create MyKey	Press the OK button or the right arrow key.

When prompted, hold the **OK** button until you see a message informing you to label this key as a MyKey. The key will be restricted at the next start.

MyKey is successfully created. Make sure you label it so you can distinguish it from the admin keys.

You can also program configurable settings for the key(s). See **Programming/Changing Configurable Settings**.

Programming/Changing Configurable Settings

Use the information display to access your configurable MyKey settings by doing the following:

1. Switch the vehicle on using an admin key.
2. Use the arrow keys to get to the following menu selections:

Message	Action and Description
Settings	Press the OK button or the right arrow key.
MyKey	Press the OK button or the right arrow key.

Note: You can clear or change your MyKey settings at any time during the same key cycle as you created the MyKey. Once you have switched the vehicle off, however, you will need an admin key to change or clear your MyKey settings.

Note: When you make any changes to your MyKey settings, you change the settings for every MyKey. You cannot make individual changes to apply to certain MyKeys.

To clear all MyKeys of all MyKey settings, press the left arrow button to access the main menu and scroll to:

Message	Action and Description
Settings	Press the OK button.
MyKey	Press the OK button.
Clear MyKey	Press and hold the OK button until the following message displays.
All MyKeys Cleared	

Note: When you clear your MyKeys, you remove all restrictions and return all MyKeys to their original admin key status.

CLEARING ALL MYKEYS

You can clear or change your MyKey settings using the information display control on the steering wheel. See **Information Displays** (page 86).

Switch the ignition on using an admin key or fob.

CHECKING MYKEY SYSTEM STATUS

You can find information on programmed MyKey(s) using the information display control on the steering wheel. See **Information Displays** (page 86).

To find information on a programmed MyKey(s), press the left arrow button to access the main menu and scroll to:

Message	Description
Information	Press the OK button.
MyKey	Press the OK button.
MyKey Info	Press the OK button.
Select one of the following:	
MyKey Dist.	Tracks the distance when drivers use a MyKey. The only way to delete the accumulated distance is by using an admin key to clear your MyKeys. If the distance does not accumulate as expected, then the intended user is not using the MyKey, or an admin key user recently cleared and then recreated a MyKey.
{0} MyKeys	Indicates the number of MyKeys programmed to your vehicle. Use this feature to detect how many MyKeys you have for your vehicle and determine when a MyKey has been deleted.
{0} Admin Keys	Indicates how many admin keys are programmed to your vehicle. Use this feature to determine how many unrestricted keys you have for your vehicle, and detect if an additional MyKey has been programmed.

USING MYKEY WITH REMOTE START SYSTEMS

Vehicles With Ford-Approved Aftermarket Remote Start Systems

When using a Ford-approved aftermarket remote start system, the vehicle recognizes the remote start system transmitter as an additional admin key. It is the vehicle's default setting.

When you start your vehicle with a Ford-approved aftermarket remote start system transmitter, the system shuts the vehicle off after you open the door or shift your vehicle into gear. This is intentional. When you restart your vehicle, it reads the intelligent access key status instead of the remote start system transmitter status.

With a Ford-approved aftermarket remote start system, it is possible to program all intelligent access keys as MyKeys unintentionally. If this happens, then the remote start system transmitter is the admin key. If you want to have only one intelligent access key as a MyKey, or do not want to have any MyKeys, then you need to use your remote start system transmitter to clear all MyKeys. In that case, follow these steps:

1. Enter your vehicle and close all doors.
2. Start your vehicle using your remote start system transmitter.
3. See **Clearing All MyKeys** (page 52). Follow Steps 1-3.

After clearing your MyKeys, you can create a new MyKey. See **Creating a MyKey** (page 51).

Note: *With push-button start, you cannot program the remote start system transmitter as a MyKey. Always treat the remote start system transmitter as you would any other admin key.*

Vehicles With Non-Ford-Approved Aftermarket Remote Start Systems

MyKey is not compatible with non-Ford-approved aftermarket remote start systems. If you choose to install a remote start system, see an authorized dealer for a Ford-approved remote start system.

The following information may help if you choose to install a non-Ford-approved remote start system. The actions provided below do not make MyKey compatible with non-Ford-approved remote start systems, but may help you retain some MyKey functions.

When using a non-Ford-approved remote start system, the vehicle may recognize the remote start system as an additional admin key with its associated privileges. If you restart the vehicle bypowering it off and waiting a few seconds, and then powering the vehicle back on, you may retain some MyKey functions. This action forces your vehicle to read the intelligent access key instead of the remote start system transmitter and then uses the MyKey associated privileges.

Note: *The MyKey system status menu display may include the remote start system as an additional key in the total count of programmed keys. See **Checking MyKey System Status** (page 53).*

With a non-Ford-approved aftermarket remote start system, it is possible to program all intelligent access keys as MyKeys unintentionally. If this happens, then the remote start system transmitter is the admin key. If you want to have only one intelligent access key as a MyKey, or do not want to have any MyKeys, then you need to use your remote start system transmitter to clear all MyKeys. In that case, follow these steps:

1. Enter your vehicle and close all doors.

2. Start your vehicle using your non-Ford-approved remote start system transmitter.
3. See **Clearing All MyKeys** (page 52). Follow Steps 1-3.

After clearing your MyKeys, you can create a new MyKey. See **Creating a MyKey** (page 51).

Note: *With push-button start, you cannot program the remote start system transmitter as a MyKey. Always treat the remote start system transmitter as you would any other admin key.*

MYKEY TROUBLESHOOTING

Condition	Potential Causes
I cannot create a MyKey.	<p>The transmitter used to start the vehicle is not an admin key.</p> <p>The transmitter used to start the vehicle is the only admin key. There always has to be at least one admin key.</p> <p>The transmitter is not in its backup position. See Starting the Electric Motor (page 112).</p> <p>The passive anti-theft system is disabled or in unlimited mode.</p> <p>The vehicle has been started using a remote start system transmitter that is not an admin key. See Using MyKey With Remote Start Systems (page 54).</p>
I cannot program the configurable settings.	<p>The transmitter used to start your vehicle is not an admin key.</p> <p>There are no MyKeys programmed to your vehicle. See Creating a MyKey (page 51).</p> <p>The vehicle has been started using a remote start system transmitter that is not an admin key. See Using MyKey With Remote Start Systems (page 54).</p>
I cannot clear the MyKeys.	<p>The transmitter used to start your vehicle is not an admin key.</p> <p>There are no MyKeys programmed to your vehicle. See Creating a MyKey (page 51).</p> <p>The vehicle has been started using a remote start system transmitter that is not an admin key. See Using MyKey With Remote Start Systems (page 54).</p>
I lost the only admin key.	Purchase a new transmitter from an authorized dealer.

MyKey™

Condition	Potential Causes
I lost a key.	Program a spare transmitter. See Passive Anti-Theft System (page 64).
I accidentally programmed all keys as MyKeys.	The vehicle has a remote start system transmitter that is recognized as an admin key. Clear all MyKeys by using the remote start transmitter. See Using MyKey With Remote Start Systems (page 54). The vehicle's system does not recognize any programmed MyKeys. See Creating a MyKey (page 51).
MyKey total includes one additional key.	An unknown transmitter has been created as a MyKey. The vehicle has a remote start system. See Using MyKey With Remote Start Systems (page 54).
Admin key total includes one additional key.	An unknown transmitter has been programmed to the vehicle as an admin key. The vehicle has a remote start system. See Using MyKey With Remote Start Systems (page 54).
The MyKey distance does not accumulate.	The MyKey is not being used by the intended user. The MyKeys have been cleared and the MyKey system has been reset.
No MyKey functions with the transmitter.	An admin transmitter is present at vehicle start. There are no MyKeys programmed to your vehicle. See Creating a MyKey (page 51).

Locks

LOCKING AND UNLOCKING

You can use the power door lock control or the remote control to lock and unlock your vehicle.

Power Door Locks

The power door lock control is on the driver and front passenger door panels.

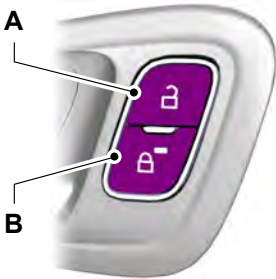

E184784

- A Unlock.
- B Lock.

Door Lock Indicator

An LED on each door window trim illuminates when you lock the door.

They will remain illuminated for up to five minutes after you switch your vehicle off.

Door Lock Switch Inhibitor

When you electronically lock your vehicle, the power door lock switch will no longer operate after approximately 11 seconds.

You must unlock your vehicle with the remote control or keyless keypad, or switch your vehicle on, to restore function to these switches.

Rear Door Unlocking and Opening

Pull the interior door handle twice to unlock and open a rear door.

Remote Control

You can use the remote control at any time.

The liftgate release button will only work when the vehicle speed is less than 4 mph (7 km/h).

Unlocking the Doors (Two-Stage Unlock)



Press the button to unlock the driver door. Press the button again within three seconds to unlock all doors. The direction indicators will flash.

Press and hold both the lock and unlock buttons on the remote control for three seconds to change between driver door or all doors unlock mode. The direction indicators will flash twice to indicate a change to the unlocking mode. Driver door unlock mode will only unlock the driver door when you press the unlock button once. All door unlock mode will unlock all doors when you press the unlock button once. The unlocking mode applies to the remote control, keyless entry keypad and intelligent access.

Locking the Doors



Press the button to lock all doors. The direction indicators will flash. Press the button again within three seconds to confirm that all the doors are closed. The doors will lock again, the horn will sound and the direction indicators will flash if all the doors and the liftgate are closed.

Mislock

If any door or the liftgate is open, or if the hood is open on vehicles with an anti-theft alarm or remote start, the horn will sound twice and the direction indicators will not flash.

Locks

Opening the Liftgate



Press twice within three seconds to unlatch the liftgate.

Make sure to close and latch the liftgate before driving your vehicle. An unlatched liftgate may cause objects to fall out or block your view.

Closing the Liftgate

The liftgate will not fully close if an intelligent access key is located inside the luggage compartment with the doors locked.

Note: If a second passive key is located within the liftgate detection range, the liftgate can be fully closed.

Activating Intelligent Access (If Equipped)

The system will not function if:

- Your vehicle battery has no charge.
- The intelligent access key battery has no charge.
- The intelligent access key frequencies are jammed.

Note: If the system does not function, use the key blade to lock and unlock your vehicle. See **Keys and Remote Controls** (page 46).

The system allows you to unlock, operate and lock your vehicle without using a key or remote control.



E78276

You must have the intelligent access key within 4.9 ft (1.5 m) of your vehicle.

Note: The system may not function if the passive key is close to metal objects or electronic devices, for example keys or a cell phone.

At a Door

Pull an exterior door handle to unlock and open the door. Do not touch the lock sensor on the front of the handle.

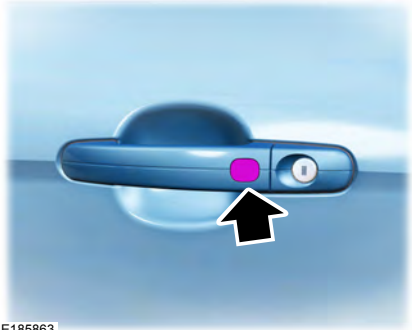

E185863

The locking sensors are on the front door handles.

Touch the locking area on the front of the door handle to lock your vehicle. There will be a brief delay before you can unlock your vehicle again.

Locks

Note: Keep the door handle clean to make sure the system operates correctly.

Note: Your vehicle does not automatically lock. If you do not touch a locking sensor your vehicle will remain unlocked.

At the Liftgate



E144402

Press the release button above the license plate to unlatch the liftgate.

Smart Unlocks for Intelligent Access Keys (If Equipped)

This helps to prevent you from locking your key inside the passenger compartment or rear cargo area.

When you electronically lock your vehicle with any door open, transmission in park (P) and your vehicle switched off, the system will search for an intelligent access key in the passenger compartment after you close the last door. If the system finds a key, all of the doors will immediately unlock and the horn sounds twice, indicating that a key is inside.

You can override the smart unlock feature and intentionally lock the intelligent access key inside your vehicle. To do this, lock your vehicle after you have closed all the doors by:

- Using the keyless entry keypad.
- Pressing the lock button on another intelligent access key.
- Touching the locking area on the front of the door handle with another intelligent access key in your hand.

When you open one of the front doors and lock your vehicle using the power door lock control, all doors will lock then unlock if:

- Your vehicle is switched on.
- Your vehicle is switched off and the transmission is not in park (P).

Disabled Intelligent Access Keys

Passive keys left inside your vehicle when locked are disabled.

You cannot use a disabled passive key to switch your vehicle on.

You will reactivate disabled passive keys when you switch your vehicle on using a valid key.

Autolock Feature

The autolock feature will lock all the doors when:

- All doors are closed.
- Your vehicle is switched on.
- You shift into any gear putting your vehicle in motion.
- Your vehicle reaches a speed greater than 4 mph (7 km/h).

Locks

Autounlock Feature

The autounlock feature will unlock all the doors when:

- Your vehicle is switched on, all the doors are closed and your vehicle has been in motion at a speed greater than 4 mph (7 km/h).
- Your vehicle comes to a stop and you switch your vehicle off or to accessory.
- You open the driver door within 10 minutes of switching your vehicle off or to accessory.

Note: *If you electronically lock your vehicle after you switch your vehicle off with the driver door closed, the doors will not autounlock.*

Enabling or Disabling Autolock and Autounlock

You can enable or disable the autolock and autounlock features independently of each other.

To enable or disable autolock, do the following:

1. Switch your vehicle on.
2. Press the power door unlock control three times.
3. Switch your vehicle off.
4. Press the power door unlock control three times.
5. Switch your vehicle on. The horn sounds indicating your vehicle is in programming mode.
6. Press the power door unlock control and within five seconds, press the power door lock control. The horn sounds once if disabled or twice if enabled.
7. Switch your vehicle off. The horn sounds indicating programming is complete.

To enable or disable autounlock, do the following:

1. Switch your vehicle on.
2. Press the power door unlock control three times.
3. Switch your vehicle off.
4. Press the power door unlock control three times.
5. Switch your vehicle on. The horn sounds indicating your vehicle is in programming mode.
6. Press the power door lock control and within five seconds, press the power door unlock control. The horn sounds once if disabled or twice if enabled.
7. Switch your vehicle off. The horn sounds indicating programming is complete.

Illuminated Entry

The interior lamps and select exterior lamps illuminate when you unlock the doors with the remote entry system.

The lamps turn off if:

- Your vehicle is switched on.
- You press the remote control lock button.
- 25 seconds have elapsed.

The lamps will not turn off if:

- You switch them on with the lighting control.
- Any door is open.

Illuminated Exit

The lamps will turn off if all the doors remain closed and:

- 25 seconds have elapsed.
- You press the **START/STOP** button.

Locks

Battery Saver

If you leave the courtesy lamps, dome lamps or headlamps on, the battery saver will turn them off 10 minutes after you switch your vehicle off.

Accessory Mode Battery Saver for Intelligent Access Keys (If Equipped)

If you leave your vehicle switched on and the electric motor is not running, the battery saver will turn the power off when it detects a certain amount of battery drain, or after 45 minutes have elapsed.

Opening the Liftgate

With the Remote Control



Press twice within three seconds to unlatch the liftgate.

From Outside Your Vehicle



E144402

Press the release button above the license plate to unlatch the liftgate. Your vehicle must be unlocked or have an intelligent access transmitter within 4.9 ft (1.5 m) of the liftgate.

MANUAL LIFTGATE

WARNING



It is extremely dangerous to ride in a cargo area, inside or outside of a vehicle. In a crash, people riding in these areas are more likely to be seriously injured or killed. Do not allow people to ride in any area of your vehicle that is not equipped with seats and safety belts. Make sure everyone in your vehicle is in a seat and properly using a safety belt. Failure to follow this warning could result in serious personal injury or death.

Note: Be careful when opening or closing the liftgate in a garage or other enclosed area to avoid damaging the liftgate.

Note: Do not hang anything, for example a bike rack, from the glass or liftgate. This could damage the liftgate and its components.

Note: Do not leave the liftgate open while driving. This could damage the liftgate and its components.

Opening the Liftgate

Manually

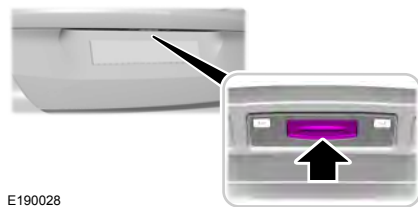

E190028

Press the release button above the license plate to unlatch the liftgate.

With the Remote Control



Press the button twice within three seconds.

Locks

Closing the Liftgate



E155976

A handle is located inside the liftgate to help with closing.

KEYLESS ENTRY (If Equipped)

SECURICODE™ KEYLESS ENTRY KEYPAD

The keypad is located near the driver window. It is invisible until touched and then it lights up so you can see and touch the appropriate buttons.

Note: *If you enter your entry code too fast on the keypad, the unlock function may not work. Enter your entry code again more slowly.*

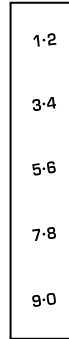

E138637

You can use the keypad to do the following:

- Lock or unlock the doors.
- Program and erase user codes.
- Arm and disarm the anti-theft alarm.

You can operate the keypad with the factory-set five-digit entry code. The code is on the owner's wallet card in the glove box and is available from an authorized dealer. You can also program up to five of your own five-digit personal entry codes.

Programming a Personal Entry Code

1. Enter the factory-set five-digit code.
2. Press **1-2** on the keypad within five seconds.
3. Enter your personal five-digit code. You must enter each number within five seconds of each other.
4. Press **1-2** on the keypad to save personal code 1.

The doors lock then unlock to confirm that programming was successful.

Locks

To program additional personal entry codes, repeat Steps 1-3, then for Step 4:

- Press **3•4** to save personal code 2.
- Press **5•6** to save personal code 3.
- Press **7•8** to save personal code 4.
- Press **9•0** to save personal code 5.

Hints:

- Do not set a code that uses five of the same number.
- Do not use five numbers in sequential order.
- The factory-set code works even if you have set your own personal code.

Erasing a Personal Code

1. Enter the factory-set five-digit code.
2. Press and release **1•2** on the keypad within five seconds.
3. Press and hold **1•2** for two seconds. You must do this within five seconds of completing step 2.

All personal codes erase and only the factory-set five-digit code works.

Anti-Scan Feature

The keypad goes into an anti-scan mode if you enter the wrong code seven times. This mode turns off the keypad for one minute and the keypad lamp flashes.

The anti-scan feature turns off after any of the following occur:

- One minute of keypad inactivity.
- You press the unlock button on the remote control.
- You switch your vehicle on.
- You unlock the vehicle using intelligent access.

Locking and Unlocking the Doors

Locking All Doors

Press and hold **7•8** and **9•0** on the keypad simultaneously with the driver door closed. You do not need to enter a code first.

Unlocking All Doors

Enter the factory-set code or your personal code, then press **3•4** on the keypad within five seconds.

Unlocking Only the Driver Door

Enter the factory-set or your personal five-digit code. You must press each number within five seconds of each other. The interior lamps illuminate.

Note: *All doors unlock if the two-stage unlocking feature is turned off. See **Locking and Unlocking** (page 57).*

Security

PASSIVE ANTI-THEFT SYSTEM

Note: *The system is not compatible with non-Ford aftermarket remote start systems. Use of these systems may result in vehicle starting problems and a loss of security protection.*

Note: *Metallic objects, electronic devices or a second coded key on the same key chain may result in vehicle starting problems, especially if they are too close to the key when starting your vehicle. Prevent these objects from touching the coded key when starting your vehicle. If your vehicle fails to start, switch your vehicle off, move all objects on the key chain away from the key and start your vehicle.*

Note: *Do not leave a duplicate coded key in your vehicle. Always take your keys and lock all doors when leaving your vehicle.*

SecuriLock

The system helps prevent your vehicle from starting unless you use a coded key programmed to your vehicle. A message may appear in the information display.

If your vehicle fails to start, the system may have a fault. Contact an authorized dealer. A message may appear in the information display.

Automatic Arming

The system arms when you switch your vehicle off.

Automatic Disarming

The system disarms when you switch your vehicle on with a coded key.

Replacement Keys

Note: *Your vehicle comes with two keys.*

The intelligent access key functions as a programmed key that operates the driver door lock and turns on the intelligent access with push button start system, as well as a remote control.

If your intelligent access keys are lost or stolen and you do not have an extra coded key, you need to have your vehicle towed to an authorized dealer. You need to erase the key codes from your vehicle and program new coded keys.

Store a spare intelligent access key away from your vehicle in a safe place. Contact an authorized dealer to purchase additional spare or replacement keys.

Programming a Spare Intelligent Access Key

You must have two previously programmed coded keys and the new unprogrammed key readily accessible. Contact an authorized dealer to have the spare key programmed if two previously programmed keys are not available.

Make sure that your vehicle is switched off before beginning this procedure. Make sure that you close all the doors before beginning and that they remain closed throughout the procedure. Carry out all steps within 30 seconds of starting the sequence. Stop and wait for at least one minute before starting again if you carry out any steps out of sequence.

Note: *You can program a maximum of eight coded keys to your vehicle.*

Read and understand the entire procedure before you begin.

Security

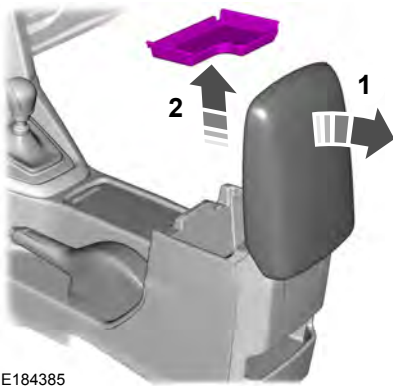

E184385

1. Open the floor console storage compartment lid.
2. Remove the tray.

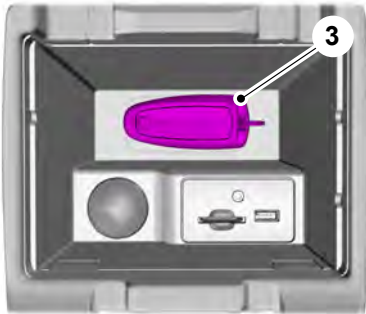

E184386

3. Place the first programmed intelligent access key flat on the symbol at the bottom of the floor console storage compartment.
4. Press the **START STOP** button.
5. Wait five seconds and then press the **START STOP** button again.
6. Remove the intelligent access key.

7. Within 10 seconds, place a second programmed intelligent access key flat on the symbol.
8. Press the **START STOP** button.
9. Wait five seconds and then press the **START STOP** button again.
10. Remove the intelligent access key.
11. Within 10 seconds, place the unprogrammed intelligent access key flat on the symbol.
12. Press the **START STOP** button.

Programming is now complete. Check that the remote control functions operate and your vehicle starts with the new intelligent access key.

If programming was unsuccessful, wait 10 seconds and repeat Steps 1 through 12. If programming remains unsuccessful, have your vehicle checked by an authorized dealer.

ANTI-THEFT ALARM

The system will warn you of an unauthorized entry to your vehicle. It will be triggered if any door, the luggage compartment or the hood is opened without using the key, remote control or keyless entry keypad.

The direction indicators will flash and the horn will sound if unauthorized entry is attempted while the alarm is armed.

Take all remote controls to an authorized dealer if there is any potential alarm problem with your vehicle.

Arming the Alarm

The alarm is ready to arm when there is not a key in your vehicle. Electronically lock your vehicle to arm the alarm.

Security

Disarming the Alarm

Disarm the alarm by any of the following actions:

- Unlock the doors or luggage compartment with the remote control or keyless entry keypad.
- Switch your vehicle on or start your vehicle.
- Use a key in the driver door to unlock your vehicle, then switch your vehicle on within 12 seconds.

Note: *Pressing the panic button on the remote control will stop the horn and signal indicators, but will not disarm the system.*

Steering Wheel

ADJUSTING THE STEERING WHEEL

WARNING



Do not adjust the steering wheel when your vehicle is moving.

Note: Make sure that you are sitting in the correct position. See **Sitting in the Correct Position** (page 104).



E95178

1. Unlock the steering column.
2. Adjust the steering wheel to the desired position.



E95179

3. Lock the steering column.

AUDIO CONTROL

Select the required source on the audio unit.

You can operate the following functions with the control:

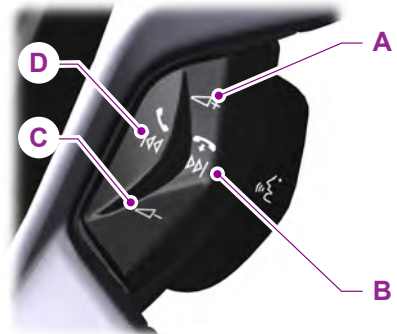

E129463

- A Volume up
- B Seek up or next

Steering Wheel

- C Volume down
- D Seek down or previous

Seek, Next or Previous

Press the seek button to:

- tune the radio to the next or previous stored preset
- play the next or the previous track.

Press and hold the seek button to:

- tune the radio to the next station up or down the frequency band
- seek through a track.

VOICE CONTROL



E129464

Pull the control to select or deselect voice control. See **MyFord Touch™** (page 231).

CRUISE CONTROL



E142437

See **Cruise Control** (page 133).

INFORMATION DISPLAY CONTROL



E130248

See **Information Displays** (page 86).

Steering Wheel

Multimedia Controls



E145434

Use the arrows on the right side of the steering wheel to navigate through the information display menus. Press **OK** to make a selection.

Wipers and Washers

WINDSHIELD WIPERS

Note: Fully defrost the windshield before you switch the windshield wipers on.

Note: Make sure you switch the windshield wipers and vehicle power off before using an automatic car wash.

Note: If streaks or smears appear on the windshield, clean the windshield and the wiper blades. See **Checking the Wiper Blades** (page 175). If that does not resolve the issue, install new wiper blades. See **Changing the Wiper Blades** (page 175).

Note: Do not operate the wipers on a dry windshield. This may scratch the glass, damage the wiper blades or cause the wiper motor to burn out. Always use the windshield washers before wiping a dry windshield.

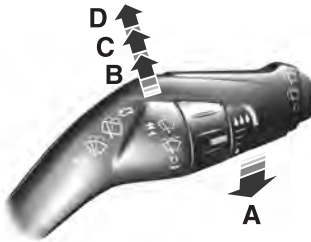

E197525

- A Single wipe.
- B Intermittent wipe.
- C Normal wipe.
- D High-speed wipe.

Note: Move to position **O** marked on the wiper lever to switch off.

Intermittent Wipe

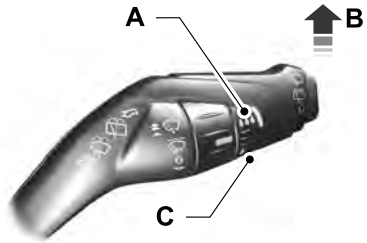

E197526

- A Short-wipe interval.
- B Intermittent wipe.
- C Long-wipe interval.

Push the wiper lever up to switch the wipers on, and then use the rotary control to adjust the intermittent wipe interval.

Speed Dependent Wipers (If Equipped)

When your vehicle speed increases, the interval between wipes decreases.

WINDSHIELD WASHERS

Note: Do not operate the washers when the washer reservoir is empty. This may cause the washer pump to overheat.



E197528

Wipers and Washers

To operate the washers and spray the windshield, pull the lever toward you. When you release the lever, the wipers will operate for a short time.

REAR WINDOW WIPER AND WASHERS

Rear Window Wiper

Note: Make sure you switch the rear window wiper and ignition off before using an automatic car wash.



E197647

- A Intermittent wipe.
- B Low speed wipe.
- C Off.

Press the top of the button to switch intermittent wipe on. Press the top of the button again to switch low speed wipe on. Press the bottom of the button to switch the rear window wiper off.

When you switch on the front wipers and move the gearshift lever to reverse (R), rear intermittent wipe automatically turns on.

Rear Window Washer



E197529

Push the lever away from you to operate the rear window washer. When you release the lever, wiping continues for a short period of time.

Lighting

GENERAL INFORMATION

Condensation in Lamp Assemblies

Exterior lamps have vents to accommodate normal changes in air pressure.

Condensation can be a natural by-product of this design. When moist air enters the lamp assembly through the vents, there is a possibility that condensation can occur when the temperature is cold. When normal condensation occurs, a fine mist can form on the interior of the lens. The fine mist eventually clears and exits through the vents during normal operation.

Clearing time may take as long as 48 hours under dry weather conditions.

Examples of acceptable condensation are:

- The presence of a fine mist (no streaks, drip marks or large droplets).
- A fine mist covers less than 50% of the lens.

Examples of unacceptable condensation are:

- A water puddle inside the lamp.
- Streaks, drip marks or large droplets present on the interior of the lens.

If you see any unacceptable condensation, have your vehicle checked by an authorized dealer.

LIGHTING CONTROL



E142449

- A Off
- B Parking lamps, instrument panel lamps, license plate lamps and tail lamps
- C Headlamps

High Beams



E162679

Push the lever forward to switch the high beams on.

Push the lever forward again or pull the lever toward you to switch the high beams off.

Lighting

Headlamp Flasher



E162680

Pull the lever toward you slightly and release it to flash the headlamps.

AUTOLAMPS

WARNING



The autolamps switch position may not activate the headlamps in all low visibility conditions, such as daytime fog. Always ensure that your headlamps are switched to auto or on, as appropriate, during all low visibility conditions. Failure to do so may result in a crash.

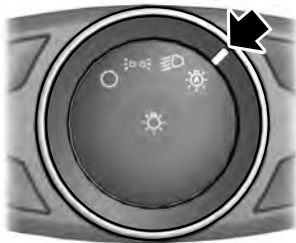

E142451

When the lighting control is in the autolamps position, the headlamps automatically turn on in low light situations or when the wipers activate.

If equipped, the following also activate when the lighting control is in the autolamps position and you switch them on in the information display:

- Configurable daytime running lamps.
- Automatic high beam control.
- Adaptive headlamp control.

The headlamps remain on for a period of time after you power off your vehicle. Use the information display controls to adjust the period of time that the headlamps remain on. See **Information Displays** (page 86).

Note: *With the headlamps in the autolamps position, you cannot switch the high beam headlamps on until the autolamps system turns the low beam headlamps on.*

Windshield Wiper Activated Headlamps

The windshield wiper activated headlamps turn on within 10 seconds when you switch the windshield wipers on and the lighting control is in the autolamps position. They turn off approximately 60 seconds after you switch the windshield wipers off.

The headlamps will not turn on by wiper activation:

- During a mist wipe.
- When the wipers are on to clear washer fluid during a wash condition.
- If the wipers are in intermittent mode.

Note: *If you switch autolamps and autowipers on, the headlamps will automatically turn on when the windshield wipers continuously operate.*

INSTRUMENT LIGHTING DIMMER

Note: You disable the manual dimmer when you adjust the setting to Auto Dimming in the information display. See **Information Displays** (page 86).

Note: If you disconnect the battery or it becomes discharged, the illuminated components will switch to the maximum setting.



E161902

Press repeatedly or press and hold until you reach the desired level.

HEADLAMP EXIT DELAY

After you power off your vehicle, you can switch the headlamps on by pulling the direction indicator lever toward you. You will hear a short tone. The headlamps switch off automatically after three minutes with any door open or 30 seconds after the last door has been closed. You can cancel this feature by pulling the direction indicator toward you again or by powering off your vehicle.

DAYTIME RUNNING LAMPS

WARNING



The daytime running lamps system does not activate the rear lamps and may not provide adequate lighting during low visibility driving conditions. Also, the autolamps switch position may not activate the headlamps in all low visibility conditions, such as daytime fog. Make sure the headlamps are switched to auto or on, as appropriate, during all low visibility conditions. Failure to do so may result in a crash.

Type 1 - Conventional (Non-Configurable)

The daytime running lamps turn on when:

1. The ignition is switched to the on position.
2. The transmission is not in park (P) for vehicles with automatic transmissions or the parking brake is released for vehicles with manual transmissions.
3. The lighting control is in the off, parking lamp or autolamps positions.
4. The headlamps are off.

Type 2 - Configurable

Switch the daytime running lamps on or off using the information display controls. See **Information Displays** (page 86).

The daytime running lamps turn on when:

1. They are switched on in the information display. See **Information Displays** (page 86).
2. The ignition is switched to the on position.
3. The transmission is not in park (P) for vehicles with automatic transmissions or the parking brake is released for vehicles with manual transmissions.

Lighting

- The lighting control is in the autolamps position.
- The headlamps are off.

The other lighting control switch positions do not activate the daytime running lamps, and you can use them to temporarily override autolamp control.

When switched off in the information display, the daytime running lamps are off in all lighting control switch positions.

DIRECTION INDICATORS



E162681

Push the lever up or down to use the direction indicators.

Note: Tap the lever up or down to make the direction indicators flash three times to indicate a lane change.

INTERIOR LAMPS

The lamps turn on when:

- You open any door.
- You press a remote control button.
- You press the buttons on the map lamps.

Front Interior Lamps (If Equipped)

Note: Press the door function switch to switch off interior lights when you open any door. The indicator lamp illuminates amber when the door function is off. When the door function is off and you open a door, the courtesy and door lamps stay off. Press the switch again to switch the door function back on. The indicator lamp illuminates white when the door function is on. When the door function is on and you open a door, the courtesy and door lamps switch on.

Center Mounted Lamp



E139420

- A Left-hand side map lamp.
- B Right-hand side map lamp.
- C Door function switch.
- D All lamps on switch.

Lighting

Side Mounted Lamp

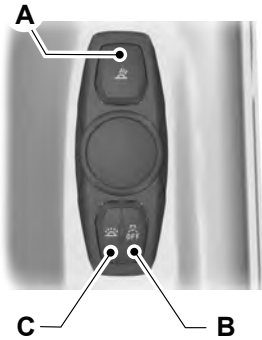

E139419

- A Map lamp.
- B Door function switch.
- C All lamps on switch.

Rotate B past the first detent to switch on and adjust to the desired brightness.

Press A to cycle through the color choices.

Press C to switch on all interior lamps and the ambient lighting. Press C again to switch off the interior lamps and return the ambient lighting to the previously selected color.

The ambient lighting turns on when:

- You power on your vehicle.
- You switch the headlamps on.

The ambient lighting remains on until you power off your vehicle and:

- You lock your vehicle.
- The accessory delay timer expires.

AMBIENT LIGHTING (If Equipped)

The ambient lighting system illuminates the interior with a choice of several colors. The ambient lighting control is located in the overhead console.

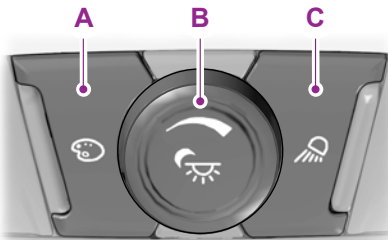

E142456

- A Color palette.
- B Control knob.
- C Search mode.

Windows and Mirrors

POWER WINDOWS

WARNINGS

 Do not leave children unattended in your vehicle and do not let them play with the power windows. They may seriously injure themselves.

 When closing the power windows, you should verify they are free of obstructions and make sure that children and pets are not in the proximity of the window openings.



E70848

Press the control to open the window.

Lift the control to close the window.

Note: You may hear a pulsing noise when just one of the windows is open. Lower the opposite window slightly to reduce this noise.

One-Touch Down

Press the control fully and release it. Press again or lift it to stop the window.

One-Touch Up

Lift the control fully and release it. Press or lift it again to stop the window.

Window Lock



E70850

Press the control to lock or unlock the rear window controls. It lights when the rear window controls lock.

Bounce-Back

The window stops automatically while closing. It reverses some distance if there is an obstacle in the way.

Overriding the Bounce-Back Feature

WARNING

 When you override the bounce-back feature the window will not reverse if it detects an obstacle. Take care when closing the windows to avoid personal injury or damage to your vehicle.

Proceed as follows to override this protection feature when there is a resistance, for example in winter:

1. Close the window twice until it reaches the point of resistance and let it reverse.

Windows and Mirrors

2. Close the window a third time to the point of resistance. You disabled the bounce-back feature and you can now close the window manually. The window travels past the point of resistance and you can close it fully.

Contact an authorized dealer as soon as possible if the window does not close after the third attempt.

Resetting the Bounce-Back Feature

WARNING



The bounce-back feature remains turned off until you reset the memory.

If you have disconnected the battery, you must reset the bounce-back memory separately for each window.

1. Lift and hold the control until the window is fully closed.
2. Release the control.
3. Lift and hold the control again for a few seconds.
4. Release the control.
5. Lift and hold the control again for a few seconds.
6. Release the control.
7. Press and hold the control until the window is fully open.
8. Lift and hold the control until the window is fully closed.
9. Release the control.
10. Open the window and then try to close it automatically.
11. Repeat the procedure if the window does not close automatically.

Accessory Delay

You can use the window controls for several minutes after switching off the ignition or until opening either front door.

EXTERIOR MIRRORS

Power Exterior Mirrors

WARNING



Do not adjust the mirrors when your vehicle is moving.

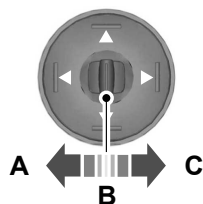

E70846

- A Left-hand mirror
- B Off
- C Right-hand mirror

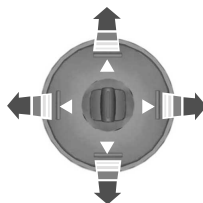

E70847

Press the arrows to adjust the mirror.

Fold-Away Exterior Mirrors

Push the mirror toward the door window glass. Make sure that you fully engage the mirror in its support when returning it to its original position.

Windows and Mirrors

Heated Exterior Mirrors

See **Heated Windows and Mirrors** (page 102).

Integrated Blind Spot Mirrors

WARNING



Objects in the blind spot mirror are closer than they appear.

Blind spot mirrors have an integrated convex mirror built into the upper outboard corner of the exterior mirrors. They are designed to increase your visibility along the side of your vehicle.

Check the main mirror first before a lane change, then check the blind spot mirror. If no vehicles are present in the blind spot mirror and the traffic in the adjacent lane is at a safe distance, signal that you intend to change lanes. Glance over your shoulder to verify traffic is clear and carefully change lanes.

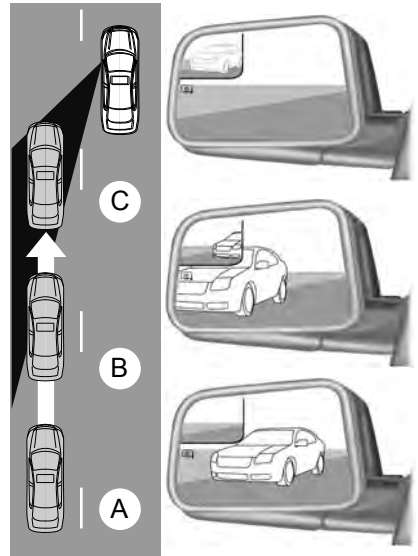

E138665

The image of the approaching vehicle is small and near the inboard edge of the main mirror when it is at a distance. The image becomes larger and begins to move outboard across the main mirror as the vehicle approaches (A). The image will transition from the main mirror and begin to appear in the blind spot mirror as the vehicle approaches (B). The vehicle will transition to your peripheral field of view as it leaves the blind spot mirror (C).

INTERIOR MIRROR

WARNING



Do not adjust the mirror when your vehicle is moving.

Windows and Mirrors

Note: Do not clean the housing or glass of any mirror with harsh abrasives, fuel or other petroleum or ammonia-based cleaning products.

You can adjust the interior mirror to your preference. Some mirrors also have a second pivot point. This lets you move the mirror head up or down and from side to side.

Pull the tab below the mirror toward you to reduce glare at night.

SUN VISORS

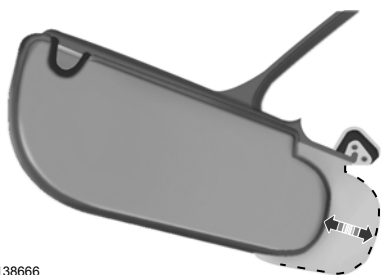

E138666

Rotate the sun visor toward the side window and extend it rearward for extra shade.

Illuminated Vanity Mirror

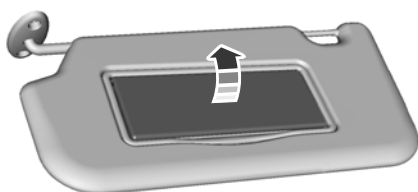

E162197

Lift the cover to switch the lamp on.

Instrument Cluster

GAUGES

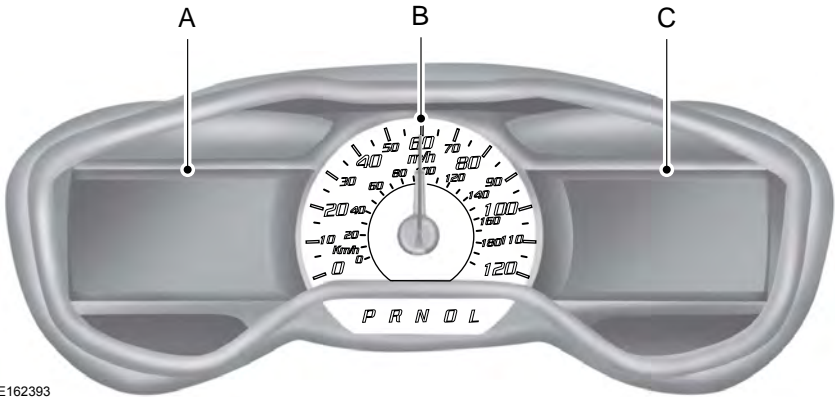

E162393

- A Left Information Display.
- B Speedometer.
- C Right Information Display.

Common Displays

Note: You can switch some features on and off through the information display.

Battery Gauge

The high voltage battery gauge appears on the right side of the left information display screen. This provides State of Charge, Range Estimate and Regen Display.

Instrument Cluster

- **State of Charge** - The state of charge for the high voltage battery is shown as a colored fill. The fill color is normally blue. When a low battery condition is reached the fill turns amber. When the battery is depleted the fill turns red. See the Information Messages section for details on associated Low Battery and Depleted Battery warnings.
- **Distance to Empty** - The Range Estimate in the Battery Gauge is personalized to your key. This is the estimated distance your vehicle can travel before needing a recharge. The Range Estimate is based on your typical energy usage while driving. This includes your Drive Habits as well as your use of accessories such as Climate Control. Your Range Estimate may change immediately when you change your Climate Control settings.
- **Regen Display** - A circular arrow symbol appears in the center of the Battery Gauge when energy is being recaptured through the regenerative braking system.

Brake Coach Display

The Brake Coach appears after your vehicle has come to a stop. It coaches you to brake in a manner which maximizes the amount of energy returned through the regenerative braking system. The percent displayed is an indication of the regenerative braking efficiency with 100% representing the maximum amount of energy recovery. If desired, this feature can be disabled in the Display section of the Settings menu.

Trip Summary and Lifetime Summary

These summaries display after switching off your vehicle. The Trip Summary appears first, followed by the Lifetime Summary. You can toggle between these displays using the up and down arrow keys on the left hand steering wheel controls.

Trip Summary data is from the last power cycle, while Lifetime Summary data is cumulative from the last Lifetime Summary reset done through the Settings menu in the information display.

Trip Summary:

- **Distance** - The total distance traveled, and regen distance are displayed. Regen distance is the estimated range gained from energy recaptured through regenerative braking.
- **Energy Used** - The total kilowatt hours and average watt hours per unit of distance are displayed. The average watt hours per mi (km) will be shown in blue if less than (better than) the lifetime average watt hours per mi (km).
- **Brake Score** - The percentage of braking energy recaptured and returned to the high voltage battery through regenerative braking. The brake score will be shown in blue if greater than (better than) the lifetime brake score.

Lifetime Summary:

- **Distance** - The total regen distance, which is the estimated range gained from energy recaptured through regenerative braking.
- **Energy Used** - The average watt hours per mi (km).
- **Brake Score** - The average percentage of braking energy recaptured and returned to the high voltage battery through regenerative braking.

Instrument Cluster

WARNING LAMPS AND INDICATORS

The following warning lamps and indicators alert you to a vehicle condition that may become serious. Some lamps illuminate when you start your vehicle to make sure they work. If any lamps remain on after starting your vehicle, refer to the respective system warning lamp for further information.

Note: *Some warning indicators appear in the information display and operate the same as a warning lamp but do not illuminate when you start your vehicle*

Anti-Lock Braking System Warning Lamp



If it illuminates when you are driving, this indicates a malfunction. You will continue to have the normal braking system (without anti-lock braking system) unless the brake system warning lamp is also illuminated. Have your vehicle checked by an authorized dealer.

Battery Warning Lamp



If it illuminates when driving, this indicates a malfunction. Switch off all unnecessary electrical equipment. Have your vehicle checked by an authorized dealer immediately.

Brake System Warning Lamp



It will illuminate when you engage the parking brake with the vehicle on.

If it illuminates when you are driving, check that the parking brake is not engaged. If the parking brake is not engaged, this indicates low brake fluid level or a brake system malfunction. Have your vehicle checked by an authorized dealer immediately.

WARNING



Driving your vehicle with the warning lamp on is dangerous. A significant decrease in braking performance may occur. It will take you longer to stop your vehicle. Have your vehicle checked by your authorized dealer immediately. Driving extended distances with the parking brake engaged can cause brake failure and the risk of personal injury.

Cruise Control Indicator



It will illuminate when you switch this feature on.

Direction Indicator



Illuminates when the left or right direction indicator or the hazard warning flasher is turned on. If the indicators stay on or flash faster, check for a burnt out bulb.

Door Ajar



Displays when the vehicle is on and any door is not completely closed.

Motor Coolant Temperature



Lights when the motor coolant temperature is high. Stop your vehicle as soon as possible, power it down and let it cool.

Instrument Cluster

Fasten Safety Belt Warning Lamp



It will illuminate and a chime will sound to remind you to fasten your safety belt. See **Safety Belt Minder** (page 33).

Front Airbag Warning Lamp



If the warning lamp does not illuminate during start up, remains on or flashes, the system may be disabled. Have your vehicle checked by an authorized dealer.

High Beam Indicator



It will illuminate when you switch the high beam headlamps on. It will flash when you use the headlamp flasher.

Liftgate Ajar



Lights when the liftgate is not completely closed.

Limited Performance



Amber: Indicates limited vehicle performance due to a cold or hot battery. A corresponding message displays.

Red: Indicates severely limited vehicle performance due to a cold or hot battery. This is accompanied by a corresponding message. Drive with caution. Keep your vehicle plugged in when not in use to maintain battery temperature.

Low Battery



Lights when the battery level is low. You may also see a message suggesting you reduce your usage of the climate system.

Low Tire Pressure Warning



Lights when your tire pressure is low. If the lamp remains on at start up or when driving, check your tire pressure as soon as possible.

It also lights momentarily when you switch on your vehicle to confirm the lamp is functional. If it does not light when you switch on your vehicle, or begins to flash at any time, have the system checked by an authorized dealer.

Low Washer Fluid



Lights when the windshield washer fluid is low.

Headlamp and Parking Lamp Indicator



It will illuminate when you switch the headlamps or parking lamps on.

Powertrain Fault



Lights when the system detects a powertrain or high-voltage charge system fault. If the indicator stays on or continues to come on, contact an authorized dealer as soon as possible.

Ready to Drive



Lights after you power your vehicle on and it is ready to drive. A corresponding message may display stating ready to drive.

Instrument Cluster

Stability Control Warning Lamp



Lights when the system is active. If it remains on or does not light when you power your vehicle on, this indicates a malfunction. During a malfunction, the system turns off. Have the system checked by an authorized dealer immediately. See (page 128).

Stability Control Off Indicator



Lights when you switch the system off. It goes out when you switch the system back on or when you power off your vehicle. See (page 128).

Stop Safely



Indicates an electrical component fault or failure that causes your vehicle to shutdown or enter into a limited operating mode. A message may also display.

Vehicle Plugged in



Lights after you plug in your vehicle. A corresponding message may display after attempting to power on your vehicle.

AUDIBLE WARNINGS AND INDICATORS

Keyless Warning Alert

The horn will sound twice when you exit your vehicle with the intelligent access key and your vehicle is in RUN, indicating your vehicle is still on.

Headlamps On Warning Chime

Sounds when you remove the key from the ignition and open the driver's door and you have left the headlamps or parking lamps on.

Parking Brake On Warning Chime

Sounds when you have left the parking brake on and drive your vehicle. If the warning chime remains on after you have released the parking brake, have the system checked by your authorized dealer immediately.

Information Displays

GENERAL INFORMATION

WARNING



Driving while distracted can result in loss of vehicle control, crash and injury. We strongly recommend that you use extreme caution when using any device that may take your focus off the road. Your primary responsibility is the safe operation of your vehicle. We recommend against the use of any hand-held device while driving and encourage the use of voice-operated systems when possible. Make sure you are aware of all applicable local laws that may affect the use of electronic devices while driving.

You can control various systems on your vehicle using the information display controls on the steering wheel.

The information display shows the corresponding information.

Left Information Display Controls

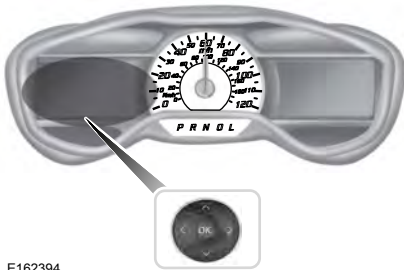

E162394

- Press the up and down arrow buttons to scroll through and highlight the options within a menu.
- Press the right arrow button to enter a sub-menu.

- Press the left arrow button to exit a menu.
- Press and hold the left arrow button at any time to return to the main menu display (escape button).
- Press the **OK** button to choose and confirm settings or messages.

Main menu

From the main menu bar on the left side of the information display, you can choose from the following categories:



Display Mode



Trip 1 & 2



Energy



Information



Settings

Display Mode



Use the up or down arrow buttons to choose between the following display options.

Note: The cluster will remember the menu level 2 state when you change the power button state from the RUN to the OFF position.

Information Displays

Display Mode				
Budget Text View	Options	Budget Text or Help		
Budget View		Gauge Scale, Budget Text or Help		
Range View		Surplus Graphic, Budget Text or Help		
MyView		Gauge Scale - check enabled or uncheck disabled		
		Budget Text - check enabled or uncheck disabled		
		Change MyView	Budget Text	Budget View
			Range View	Budget + Avg
			Accessory Power	Accessory Power
			Trip 1	Trip 1
			Trip 2	Trip 2
		Energy History	Energy Coach	
	Energy Coach	Blank		
	Blank			
	Help			

Budget Text View

Contains basic information to help you reach your next charging destination or to achieve your vehicle range estimate.

- Charge pt: is the distance remaining to the next charge point you identified using the Navigation system.
- Surplus: is the available range beyond your identified charge point (current Range Estimate shown on Battery Gauge minus Charge pt distance).

If you don't enter a charge point, you will see:

- Budget: is set to the Range Estimate at the point of departure. This will count down with the odometer.
- Status: is your performance against your Budget (current Range Estimate shown on Battery Gauge minus Budget distance). A positive Status indicates you are using less energy than typical and have extended your Range Estimate by the distance shown.

Budget view

Helps you manage your energy use.

Information Displays

Your current energy use is the white line that moves up and down in the Budget Gauge. A higher line means you are using more energy (lower is better). Your energy use includes input from the accelerator pedal as well as the accessories, such as Climate Control.

The Budget is shown by the blue cup shape around the Budget Gauge. As long as your current energy use is within the cup, you are staying within your budget. Your Budget represents the maximum energy usage you can maintain in order to achieve your vehicle range estimate, or reach your intended charge point. Driving for extended periods outside of the Budget Cup reduces your budget and could put you at risk of not reaching your intended charge point.

Range view

Shows your range relative to your charge point as well as performance to your budget.

A blue charge point icon means you have a Surplus. If an E appears to the left of an amber charge point icon, then you are projected to run out of charge prior to reaching your charge point.

Current performance to your budget is represented by the glow of the car icon: more Blue = better performance to budget, more Amber = worse.

The optional Surplus Graphic displays available range beyond your charge point.

If you didn't enter your charge point through the Navigation system, your budget will be set to the range estimate at the start of your trip. The gauge will show your estimated distance to E (empty) along with your current performance to budget. The optional Surplus Graphic is not available in this case.

MyView

You can choose what to display in this view. Selecting **Change MyView** in the options menu allows you to scroll through two columns of content choices.

- Press the up or down arrow to view content.
- Press **OK** to save your selected content.

Unique content available in MyView:

- Accessory Power - Indicates electrical power demands from your vehicle's accessory systems. Accessories use power but do not contribute to propelling your vehicle. The gauge separately displays power demand in kilowatts (kW) for climate and other accessories. Climate includes the power being used by high voltage climate control components such as the electric A/C compressor and the electric heater. Other includes all power being used by the low voltage accessories (cabin fans, headlights, heated seats, etc.).
- Budget + Avg - The white pointers on the outside of the budget gauge indicate your average watt hours per mi (km) since you last charged your vehicle. Immediately after charging the white pointers will start out at the top of the gauge, as you begin driving they will reflect your average energy use.

Note: *The trip data cannot be reset in MyView.*

Trip 1 & 2



Use the arrow buttons to choose between the following.

Information Displays

Trip 1 & 2				
Trip distance	Standard	Enhanced	Budget Text	Help
	X	X	X	
XXX Wh/mi (km) – Energy used per unit of distance	—	X	—	
XX.X kWh –Energy used	—	X	—	
Elapsed trip time	X	X	X	
Budget Text	—	—	X	
Total Odometer	X	X	X	

Note: Press and hold OK to reset the currently displayed trip information.

- Trip distance — Shows your accumulated trip distance.
- XXX Wh/mi (km) — Shows the average Energy (watt-hours) used per unit of distance for a given trip.
- XX.X kWh — Shows the total Energy (kilowatt-hours) used for a given trip.
- Elapsed trip time — The timer stops when you turn off your vehicle and restarts when you restart your vehicle.

- Budget Text — Shows the distance to your next charge point and the surplus distance available, or your budget and status if you didn't identify a charge point through the navigation system.
- Total Odometer — Displays the total distance your vehicle has traveled. This value can not be reset.

Energy



Use the arrow buttons to choose the desired energy display.

Energy		
Energy History	Options	Time intervals or Help
Energy Coach		Help

Information Displays

- Energy History - This view from left to right starts with the Budget View gauge and adds historical Energy Use and Budget data. The data is represented as an average for time intervals of either 1, 2 or 6 minutes, with the leftmost interval being the most recent. Total time for the five intervals is shown at the bottom of the view. Interval time can be selected in the Options menu. Intervals shown in grey color are from the previous drive.
- Energy Coach - This view provides a comparison of your recent Acceleration, Braking and Cruising behavior to what is recommended for most efficient use of energy under present conditions. The horizontal bars fill from left to right with best efficiency (and Blue color) shown as at least half full. When the bars are less than half full, the color is Amber, suggesting that a change in behavior is needed to achieve better energy efficiency.

Info



In this mode, you can view different vehicle system information and perform a system check.

Information	
Tutorial	Find your way...
	Brake Coach
	Display Mode
	Trip 1 & 2
	Energy
	Surplus
MyKey	MyKeys (Number of MyKeys programmed)
	Admin Keys (Number of admin keys)
	MyKey Miles (km) (Distance traveled using a programmed MyKey)

Information Displays

Information	
Driver Alert	Displays the associated driver alert graphic.
XX Warnings	Displays the number of warnings that need immediate attention in red. You can only view the warnings from the System Check menu. View them immediately by pressing OK and then OK again to enter system check. Use the up and down arrows to scroll through the warnings.
System Check	All active warnings will display first if applicable. The system check menu may appear different based upon equipment options and current vehicle status. Use the up/down arrow buttons to scroll through the list.

Settings



In this mode, you can configure different driver setting choices.

Note: Some items are optional and may not appear.

Note: Some MyKey items will only appear if a MyKey is set.

Settings					
Driver Assist	Traction Ctrl	On or Off			
	Home Range warn	On or Off			
	Rear Park Aid	On or Off			
Vehicle	Lighting	Auto Light Rain	On or Off		
		Home Light	Manual or select time interval		
	Remote Start	Climate Control	Heater - A/C	Auto or Last Settings	
			Front Defrost	Auto or Off	
			Rear Defrost	Auto or Off	
	Duration	5, 10 or 15 minutes			
	Quiet Start	On or Off			
	System	Enable or Disable			

Information Displays

Settings			
	Tire Mobility Kit	Select number of years	
MyKey	Create MyKey	Hold OK to Create MyKey	
	Traction Control	Always On or User Selectable	
	Max Speed	Choose desired speed or off	
	Speed Minder	Choose desired speed or off	
	Volume Limiter	On or Off	
	Clear MyKeys	Hold OK to Clear All MyKeys	
Display	Language	Select the desired language	
	Units	Distance	Miles or km
		Temperature	Fahrenheit (°F) or Celsius (°C)
	Brake Coach	On or Off	
	Regen Display	On or Off	
	Lifetime Summary	Hold OK to Reset	

INFORMATION MESSAGES

Note: Depending on the vehicle options equipped with your vehicle, not all of the messages will display or be available. Certain messages may be abbreviated or shortened depending upon which cluster type you have.



E130248

Information Displays

Press the OK button to acknowledge and remove some messages from the information display. Other messages will be removed automatically after a short

time.

Certain messages need to be confirmed before you can access the menus.

AdvanceTrac®

Message	Action
Service AdvanceTrac	The system has detected a condition that requires service. Contact an authorized dealer as soon as possible.

Alarm

Message	Action
Vehicle Alarm To Stop Alarm, Start Vehicle.	Alarm triggered due to unauthorized entry. See Passive Anti-Theft System (page 64).

Battery and Charging System (High Voltage)

Message	Action
Vehicle Plugged In ? Yes No	Your vehicle needs confirmation it is unplugged before allowing to power on. You must make sure your vehicle is unplugged and you respond to the message prompt before powering on your vehicle.
Ready to Drive	Your vehicle is ready to drive.
Unplug Prior to Starting Vehicle	Your vehicle detects it is still plugged in and you attempt to start it.
Elec system overvoltage Stop safely	Stop your vehicle as soon as it is safe to do so and power it off. Contact an authorized dealer.
Battery low See manual	Warning of a low 12-volt battery condition. Turn off all unneeded electrical accessories. Contact an authorized dealer.
Low Battery	The estimated range is 10 mi (16 km) or 15 mi (24 km) for MyKey. Your vehicle needs to be charged soon.
Low Battery Reduce Climate use for more range	The estimated range is 10 mi (16 km) or 15 mi (24 km) for MyKey and the climate system is in use. Turn off unneeded climate system operation to increase your vehicle range.

Information Displays

Message	Action
Depleted Battery Stop safely now	The estimated range is 0 mi (0 km). Stop your vehicle in a safe place. Your vehicle must be charged.
Reduce Climate Use for More Range	High climate usage may make it difficult to stay within your energy budget.
Limited Performance Due to cold battery	Cold battery temperatures is affecting your vehicle performance.
Severely Limited Performance Due to cold battery	Your vehicle performance is severely affected by cold battery temperatures. Drive with caution. Keep your vehicle plugged in when not in use to maintain proper battery temperature.
Limited Performance Due to hot battery	Hot battery temperature is affecting your vehicle performance.
Severely Limited Performance Due to hot battery	Your vehicle performance is severely affected by hot battery temperatures. Drive with caution. Keep your vehicle plugged in when not in use to maintain proper battery temperature.
Approaching Range Limit to Return Home	You have not specified a charge point through your vehicle Mytouch system and your vehicle range will soon be less than what is needed to return Home. Your Home address must be specified through your vehicle Mytouch system to enable this feature.
Stop Safely Now	The stop safely hazard warning lamp is illuminated. This indicates an electrical component fault or failure that will cause your vehicle to shut down or enter into limited operating mode.
Outside Air Temperature High Plug Vehicle in When not in use	The ambient temperature is hot. Plug in your vehicle to cool the high voltage battery for optimum performance.
Outside Air Temperature Low Plug Vehicle in When not in use	The ambient temperature is cold. Plug in your vehicle to warm the high voltage battery for optimum performance.
Ready to Drive Budget set to {distance imperial:###0} mi	Your vehicle is ready to drive and you have not specified your next charge point through your vehicle navigation system. Your budget is set for the current vehicle range estimate.
Budget set to {distance imperial:###0} mi	Your budget is reset because you have reached your charge point destination, or you no longer have a charge point destination identified through your vehicle navigation system. Your budget is set for the current vehicle range estimate.

Information Displays

Doors

Message	Action
X Door Ajar	Displays when the door(s) listed is not completely closed.
Liftgate Ajar	Displays when the liftgate is not completely closed.

Hill Start Assist

Message	Action
Hill Start Assist Not Available	Displays when hill start assist is not available. Contact an authorized dealer. See Hill Start Assist (page 125).

Keys and Intelligent Access

Message	Action
Starting System Fault	This message is displayed when there is a problem with your vehicle's starting system. See your authorized dealer for service.
Key Inside vehicle	Displays to remind you that the key is in the luggage compartment. See Starting the Electric Motor (page 112).
Key Not Inside vehicle	Displayed when a valid key is not detected within the vehicle. See Starting the Electric Motor (page 112).
No Key Detected	Displayed if the key is not detected by the system. See Starting the Electric Motor (page 112).
Accessory Power is Active	Displayed when your vehicle is in the Accessory ignition state.
To START Press Brake	Displayed as a reminder to press the brake while starting the vehicle.
Place Key in Backup Location	Displayed as needed by the system for proper function.

Information Displays

Lighting

Message	Action
Brake lamp Bulb fault	Displays when the brake lamp bulb has burned out. Contact an authorized dealer.
Low beam Bulb fault	Displays when the low beam headlamp bulb has burned out. Contact an authorized dealer.
Headlamp fault Service req'd	Displays when an electrical system problem occurs with the headlamp system. Contact an authorized dealer.

Maintenance

Message	Action
Brake fluid level low Service now	Indicates the brake fluid level is low and the brake system should be inspected immediately. See Maintenance (page 169).
Brake system fault Stop safely	Displays when the brake system needs servicing. Stop your vehicle in a safe place. Contact an authorized dealer.
Motor Coolant Over Temperature	Displays when the motor coolant temperature is excessively high.
Service Tire Mobility Kit	Displayed when the kit needs service. See your authorized dealer.
See Manual	Informs you that the powertrain needs service due to a powertrain malfunction.
Washer Fluid Level Low	Displays when the washer fluid is low and needs to be refilled. See Maintenance (page 169).

MyKey

Message	Action
MyKey Active Drive Safely	Displays when MyKey is active.
Speed Limited to xx MPH/km/h	Displays when starting the vehicle and MyKey is in use and the MyKey speed limit is on.
Near Vehicle Top Speed	Displays when a MyKey is in use and the MyKey speed limit is on and the vehicle speed is approaching 80 mph (130 km/h).

Information Displays

Message	Action
Vehicle at Top Speed of MyKey Setting	Displays when a MyKey is in use and the MyKey speed limit is reached.
Check Speed Drive Safely	Displays when MyKey is active.
Buckle Up to Unmute Audio	Displays when a MyKey is in use and Belt- Minder is activated.
MyKey Park Aid Cannot be Deactivated	Displays when a MyKey is in use and park aid is activated.

Park Aid

Message	Action
Check Park Aid	The system has detected a condition that requires service. Contact an authorized dealer.
Rear Park Aid On Off	Displays the park aid status.

Park Brake

Message	Action
Park Brake Engaged	Displays when the parking brake is set, the engine is running and the vehicle is driven more than 3 mph (5 km/h). If the warning stays on after the parking brake is released, contact an authorized dealer.

Information Displays

Power Steering

Message	Action
Service Power Steering	The power steering system has detected a condition that requires service. Contact an authorized dealer.
Service Power Steering Now	The power steering system has detected a condition within the power steering system that requires service immediately. Contact an authorized dealer.
Power Steering Assist Fault	The power steering system has disabled power steering assist due to a system error. Contact an authorized dealer.
Steering fault Service now	The power steering system has detected a condition that requires service. Contact an authorized dealer.
Steering loss Stop safely	The power steering system has detected a condition within the power steering system that requires service immediately. Contact an authorized dealer.

Remote Start

Message	Action
Remote Start Active	Displayed when the remote start system is active.

Tire Pressure Monitoring System

Message	Action
Low Tire Pressure	One or more tires on your vehicle has low tire pressure. See Tire Pressure Monitoring System (page 216).
Tire Pressure Monitor Fault	The tire pressure monitoring system is malfunctioning. If the warning stays on or continues to come on, contact an authorized dealer. See Tire Pressure Monitoring System (page 216).
Tire Pressure Sensor Fault	A tire pressure sensor is malfunctioning, or your spare tire is in use. For more information on how the system operates under these conditions. See Tire Pressure Monitoring System (page 216). If the warning stays on or continues to come on, contact an authorized dealer as soon as possible.

Information Displays

Transmission

Message	Action
Transmission Not in Park	A reminder to shift into park.

Climate Control

AUTOMATIC CLIMATE CONTROL

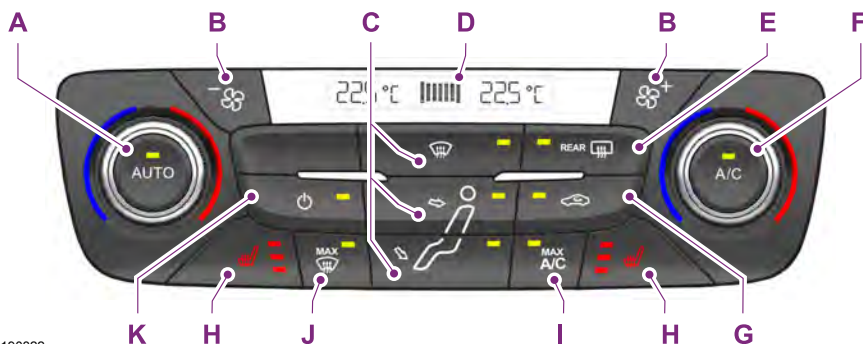

E190322

- A **AUTO:** Press the button to switch on automatic operation. Adjust to select the desired temperature. Fan speed, air distribution, air conditioning operation, and outside or recirculated air are automatically adjusted to heat or cool the vehicle to maintain the desired temperature. You can also turn off dual zone mode by pressing and holding the button for greater than two seconds.
- B **Fan speed control:** Adjusts the volume of air circulated in the vehicle.
- C **Air distribution control:** Adjust the control to turn airflow from the windshield, instrument panel, or footwell vents on or off. You can distribute air through any combination of these vents.
Note: At least one of these buttons illuminates when the system is on.
- D **Climate control display:** The display shows the set temperatures and the fan speed.
- E **Heated rear window:** Press the button to switch the heated rear window on and off. See **Heated Windows and Mirrors** (page 102).
- F **A/C:** Press the button to switch the air conditioning on or off. Air conditioning cools your vehicle using outside air. To improve the time to reach a comfortable temperature in hot weather, drive with the windows open until you feel cold air through the air vents.
- G **Recirculated air:** Press the button to switch between outside air and recirculated air. The air currently in the passenger compartment recirculates. This can reduce the time needed to cool the interior and reduce unwanted odors from entering your vehicle.
- H **Heated seats (if equipped):** Press the button to switch the heated seats on and off. See **Heated Seats** (page 109).

Climate Control

- I **MAX A/C:** Press the button for maximum cooling. Recirculated air flows through the instrument panel vents, air conditioning automatically turns on and the fan automatically adjusts to the highest speed.
- J **MAX Defrost:** Press the button to switch on defrost. Outside air flows through the windshield vents, air conditioning automatically turns on, and fan automatically adjusts to the highest speed. You can also use this setting to defrost and clear the windshield of a thin covering of ice. The heated rear window also automatically turns on when you select maximum defrost.
- K **Power:** Press the button to switch the system on and off. When the system is off, it prevents outside air from entering the vehicle.

Temperature Control



E183686

You can set a temperature between 60°F (15.5°C) and 85°F (29.5°C). If you select LO, the system is set to permanent cooling. If you select HI, the system is set to permanent heating.

Note: *If you select LO or HI, the system does not maintain a stable temperature.*

Single Zone Temperature Control

In this mode, the climate control system links the temperature settings for both the driver's side and passenger's side. If you adjust the setting using the rotary control on the driver's side, the system adjusts the temperature to the same setting on the passenger's side.

To switch back to single zone control from dual zone, press and hold **AUTO** for a few seconds. The passenger's side temperature switches to the driver's side temperature setting.

Dual Zone Temperature Control

Select a temperature for the passenger's side using the rotary control on the passenger's side. Single zone temperature control automatically switches off. The temperature on the driver's side remains unchanged. You can now adjust the driver's side and passenger's side temperatures independently. The display shows the temperature settings for each side.

HINTS ON CONTROLLING THE INTERIOR CLIMATE

General Hints

Note: *Prolonged use of recirculated air may cause the windows to fog up.*

Note: *To reduce humidity build-up inside your vehicle, do not drive with the system switched off or with recirculated air always switched on.*

Note: *Do not place objects under the front seats as this may interfere with the airflow to the rear seats.*

Climate Control

Note: Remove any snow, ice, or leaves from the air intake area at the base of the windshield.

Note: To improve air conditioning when starting your vehicle, drive with the windows slightly open for two to three minutes.

Recommended Settings for Cooling

1. Press the **AUTO** button.
2. Adjust the temperature control to the desired setting.

Side Window Defogging in Cold Weather

1. Select air distribution through the floor vent.
2. Select air distribution through the panel vent.
3. Select **A/C**.
4. Adjust the temperature control to the desired setting.
5. Adjust the outer panel vents toward the side windows.

Note: To increase airflow to the outer panel vents, close the vents in the middle of the instrument panel.

Improving Vehicle Drive Range

Your vehicle is equipped with a high voltage electric compressor and a high voltage electric heater. You can increase your driving range by minimizing the amount of energy expended to cool or heat the interior during the drive.

Pre-condition the interior temperature during vehicle charging reduces the battery energy use on the interior comfort and improves range.

Note: Your vehicle may not always reach the set cabin temperature due to charging and ambient temperature conditions.

Hot and cold temperatures make your vehicle use more energy to achieve and maintain a comfortable interior temperature. Park the vehicle in the shade or in a parking structure when hot, and in a garage when cold.

Consider partially opening a window (or windows) to let fresh air circulate, if weather conditions permit. You can achieve maximum energy savings by switching the climate system off. Do this only if conditions exist for safe vehicle operation.

Reduce fan speed.

Set the **AUTO** temperature a couple degrees cooler than you normally do on cold days and a couple degrees higher on hot days. Use the heated seats on cold days to increase interior comfort.

Switch the air conditioning off in mild temperatures or low humidity conditions.

Defrost mode automatically turns the air conditioning on to dehumidify the air, and cannot be switched off. If defogging or defrosting is not necessary, select a non-defrost mode and disengage air conditioning to extend vehicle range.

Air conditioning and heating functions are automatically switched off (unless in defrost mode) when driving distance to empty is zero miles (zero km). The interior fan will continue to operate.

HEATED WINDOWS AND MIRRORS

Heated Rear Window

Note: Make sure the vehicle is running before operating the heated windows.

Climate Control



Press the button to clear the heated rear window of thin ice and fog. The heated rear window will automatically turn off after a short period of time. Start the vehicle before you switch the heated rear window on.

Do not use razor blades or other sharp objects to clean or remove decals from the inside of the heated rear window. The vehicle warranty does not cover damage caused to the heated rear window grid lines.

Heated Exterior Mirrors



When you switch the heated rear window on, the heated exterior mirrors will automatically turn on.

Note: Do not remove ice from the mirrors with a scraper or adjust the mirror glass when it is frozen in place.

Note: Do not clean the mirror housing or glass with harsh abrasives, fuel or other petroleum-based cleaning products.

CABIN AIR FILTER

Your vehicle is equipped with a cabin air filter, which gives you and your passengers the following benefits:

- It improves your driving comfort by reducing particle concentration.
- It improves the interior compartment cleanliness.
- It protects the climate control components from particle deposits.

Note: Make sure you have a cabin air filter installed at all times. This prevents foreign objects from entering the system. Running the system without a filter in place could result in degradation or damage to the system.

Replace the filter at regular intervals. See **Scheduled Maintenance** (page 347).

For additional cabin air filter information, or to replace the filter, see an authorized dealer.

REMOTE START

You can switch this feature on or off and adjust the settings using the information display.

The system adjusts the interior temperature depending on your chosen settings during remote start.

You cannot adjust the climate control setting during remote start operation. When you switch the ignition on the climate control system returns to the previous settings.

When you switch the ignition on, you may have to switch the following features back on:

- Heated seats.
- Heated rear window.
- Heated exterior mirrors.

Note: You can control the system through SYNC using an applicable phone app. See your phones user manual or visit www.SYNCMYRide.com.

Seats

SITTING IN THE CORRECT POSITION

WARNINGS



Do not recline the seat backrest too far as this can cause the occupant to slide under the safety belt, resulting in serious injury in the event of a crash.



Sitting improperly, out of position or with the seat backrest reclined too far, can result in serious injury or death in the event of a crash. Always sit upright against your seat backrest, with your feet on the floor.



Do not place objects higher than the seat backrest to reduce the risk of serious injury in the event of a crash or during heavy braking.

- Adjust the head restraint so that the top of it is level with the top of your head and as far forward as possible. Make sure that you remain comfortable.
- Keep sufficient distance between yourself and the steering wheel. We recommend a minimum of 10 inches (25 centimeters) between your breastbone and the airbag cover.
- Hold the steering wheel with your arms slightly bent.
- Bend your legs slightly so that you can press the pedals fully.
- Position the shoulder strap of the safety belt over the center of your shoulder and position the lap strap tightly across your hips.

Make sure that your driving position is comfortable and that you can maintain full control of your vehicle.

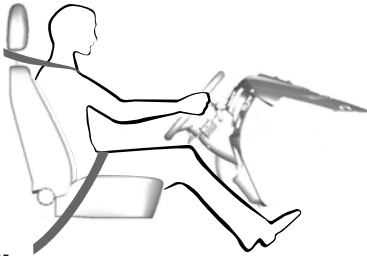

E68595

When you use them properly, the seat, head restraint, safety belt and airbags will provide optimum protection in the event of a crash.

We recommend that you follow these guidelines:

- Sit in an upright position with the base of your spine as far back as possible.
- Do not recline the seat backrest more than 30 degrees.

HEAD RESTRAINTS

WARNINGS



To minimize the risk of neck injury in the event of a crash, the driver and passenger occupants should not sit in or operate the vehicle, until the head restraint is placed in its proper position. The driver should never adjust the head restraint while the vehicle is in motion.



The adjustable head restraint is a safety device. Whenever possible, it should be installed and properly adjusted when the seat is occupied. Failure to adjust the head restraint properly could reduce its effectiveness during certain impacts.



Install the head restraint properly to help minimize the risk of neck injury in the event of a crash.

Seats

Note: Adjust the seatback to an upright driving position before adjusting the head restraint. Adjust the head restraint so that the top of it is level with the top of your head and as far forward as possible. Make sure that you remain comfortable. If you are extremely tall, adjust the head restraint to its highest position.

Front seat and rear seat outboard head restraints

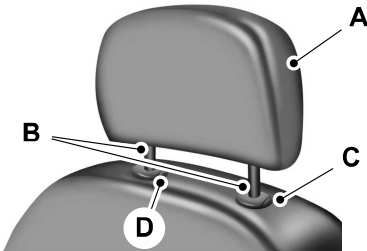

E138642

Rear center head restraint

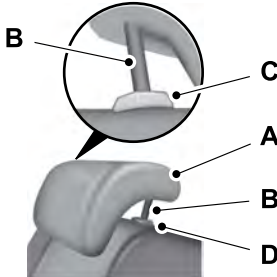

E198013

The head restraints consist of:

- A An energy absorbing head restraint.
- B Two steel stems.
- C Guide sleeve adjust and release button.
- D Guide sleeve unlock and remove button.

Adjusting the Head Restraint

Raising the Head Restraint

Pull the head restraint up.

Lowering the Head Restraint

1. Press and hold button C.
2. Push the head restraint down.

Removing the Head Restraint

1. Pull the head restraint up until it reaches its highest position.
2. Press and hold buttons C and D.
3. Pull the head restraint up.

Note: For the front head restraints, you may need to use a key or similar object to release the head restraint. Press the key into the guide sleeve unlock and remove button to release the head restraint.

Installing the Head Restraint

Align the steel stems into the guide sleeves and push the head restraint down until it locks.

Tilting Head Restraints

The front head restraints tilt for extra comfort. To tilt the head restraint, do the following:

Seats



E144727

1. Adjust the seatback to an upright driving or riding position.
2. Pivot the head restraint forward toward your head to the desired position.

After the head restraint reaches the forward-most tilt position, pivoting it forward again will then release it to the rearward, un-tilted position.

MANUAL SEATS

WARNINGS



Do not adjust the driver seat or seatback when your vehicle is moving. Adjusting your seatback while your vehicle is in motion may cause loss of control of your vehicle.



Rock the seat backward and forward after releasing the lever to make sure that it is fully engaged.

The manual front seats may consist of:



E197725

- A A bar to move the seat backward and forward.
- B A lever to adjust the height of the seat.
- C A lever to adjust the angle of the seatback.

POWER SEATS

WARNINGS



Do not adjust the driver seat or seatback when your vehicle is moving. Adjusting your seatback while your vehicle is in motion may cause loss of control of your vehicle.



Reclining the seatback can cause an occupant to slide under the seat's safety belt, resulting in severe personal injuries in the event of a crash.

Seats

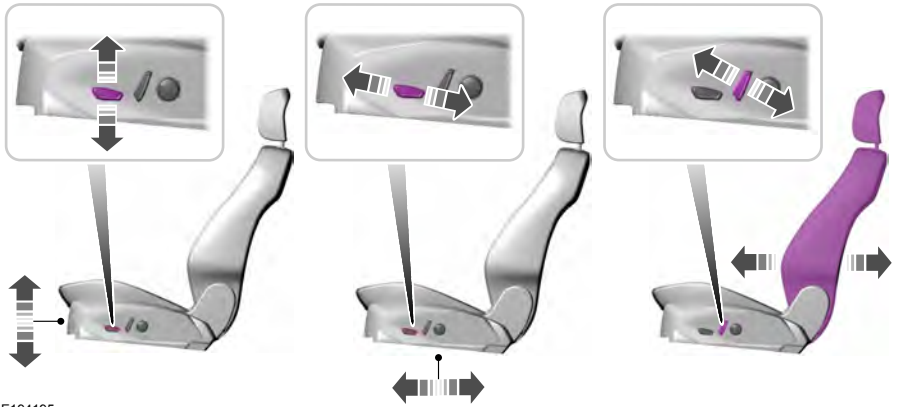

Power Lumbar (If Equipped)



REAR SEATS

Folding the Seatback

Note: Before lowering the seatback(s), remove the outboard head restraints. See **Head Restraints** (page 104).

Note: Your vehicle may have split seatbacks that must be folded individually.

1. Press the unlock buttons down.
2. Push the seatback forward.

Seats

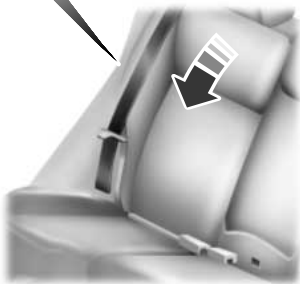

E165362

3. Stow the safety belt in the belt stowage clip. This will prevent the safety belt from getting caught in the seat latch.



E184203

When raising the seatback(s), make sure you hear the seat latch into place and that no red portion is visible on the release button on both sides.

Flip Up Seat Cushions

WARNING



Before returning the seatback to its original position, make sure that cargo or any objects are not trapped behind the seatback. Make sure that the safety belt is not laying on the seat latch. After returning the seatback to its original position, pull on the seatback to make sure that it has fully latched. An unlatched seat may become dangerous in the event of a sudden stop or crash.

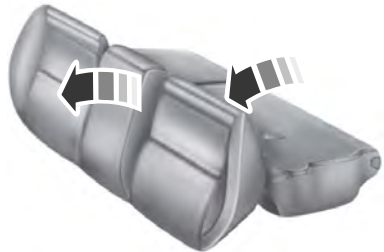

E184204

For additional cargo space, flip the seat cushions up before folding the seatback. This feature is only available on vehicles with a split folding seatback.

HEATED SEATS

WARNING



People who are unable to feel pain to their skin because of advanced age, chronic illness, diabetes, spinal cord injury, medication, alcohol use, exhaustion or other physical conditions, must exercise care when using the heated seat. The heated seat may cause burns even at low temperatures, especially if used for long periods of time. Do not place anything on the seat that insulates against heat, such as a blanket or cushion. This may cause the heated seat to overheat. Do not puncture the seat with pins, needles or other pointed objects. This may damage the heating element which may cause the heated seat to overheat. An overheated seat may cause serious personal injury.

Do not do the following:

- Place heavy objects on the seat.
- Operate the heated seat if water or any other liquid spills on the seat. Allow the seat to dry thoroughly.
- Operate the heated seats unless the vehicle is powered to Ready to Drive. Doing so can deplete the 12-volt battery.



E146941

Press the heated seat symbol to cycle through the various heat settings and off. More indicator lights indicate warmer settings.

Auxiliary Power Points

12 Volt DC Power Point

WARNING



Do not plug optional electrical accessories into the cigar lighter socket. Incorrect use of the lighter can cause damage not covered by your warranty, and can result in fire or serious injury.

Note: After starting your vehicle, you can use the socket to power 12-volt appliances with a maximum current rating of 20 amps.

After you switch your vehicle off, the power supply works only for a maximum of 30 minutes.

Note: Do not insert objects other than an accessory plug into the power point. This damages the outlet and can blow the fuse.

Note: Do not hang any type of accessory or accessory bracket from the plug.

Note: Do not use the power point over the vehicle capacity of 12 volt DC 180 watt or a fuse may blow.

Note: Do not use the power point for operating a cigar lighter element.

Note: Incorrect use of the power point can cause damage not covered by your warranty.

Note: Always keep the power point caps closed when not in use.

Run the vehicle for full capacity use of the power point.

To prevent the battery from running out of charge:

- Do not use the power point longer than necessary after switching the vehicle off.
- Do not leave devices plugged in overnight or when your vehicle is in park (P) for extended periods.

Location

You may find power points in the following locations:

- On the center console
- In the center console.

Storage Compartments

CENTER CONSOLE

Stow items in the cupholder carefully as items may become loose during hard braking, acceleration or crashes, including hot drinks which may spill.

Available console features include:

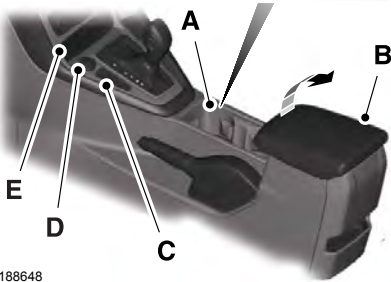
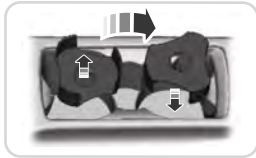

E188648

- A Cupholder with grips and height adjuster. To use, flip the removable inset piece.
- B Storage compartment with auxiliary power point and media hub.
- C Parking aid and cardholder.
- D Auxiliary power point.
- E USB port.

OVERHEAD CONSOLE



E131605

Press near the rear edge of the door to open it.

Starting and Stopping the Electric Motor

STARTING THE ELECTRIC MOTOR

Keyless Starting

Note: The system may not function if the passive key is close to metal objects or electronic devices, for example keys or a cell phone.

Note: A valid passive key must be located inside your vehicle to switch the ignition on and start your vehicle.

Note: Passive keys left inside your vehicle when locked are disabled. A message may appear in the information display indicating that there is no key detected when you try to start your vehicle. Press the unlock button on the remote control to enable it, and then start your vehicle.

Ignition Modes



E166822

The keyless starting system has three modes:

- **Off:** Turns the ignition off. Without applying the brake pedal, press and release the power button once when the ignition is in the on mode, or when the vehicle is on but not moving.
- **On:** All electrical circuits are operational and the warning lamps and indicators illuminate. Without applying the brake pedal, press and release the power button once from off mode.
- **Start:** Starts your vehicle. Press the brake pedal, and then press the power button for a couple of seconds. The green ready to drive indicator lamp illuminates in the instrument cluster when your vehicle is ready to drive.

Starting Your Vehicle

Before starting your vehicle, check the following:

- Make sure all the occupants have fastened their safety belts.
- Make sure the headlamps and electrical accessories are off.
- Make sure the parking brake is on.
- Make sure the gearshift lever is in park (P).

Note: Do not touch the accelerator pedal.

1. Fully depress the brake pedal.
2. Press the power button.

Note: You will not hear any engine noise.

The system does not function if:

- The passive key frequencies are jammed.
- The key battery has no charge.

If you are unable to start your vehicle, follow the steps below.

Starting and Stopping the Electric Motor

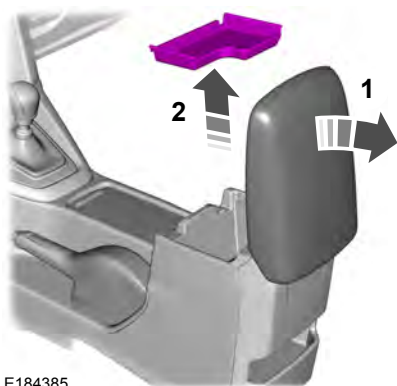

E184385

1. Open the floor console storage compartment lid.
2. Remove the tray.

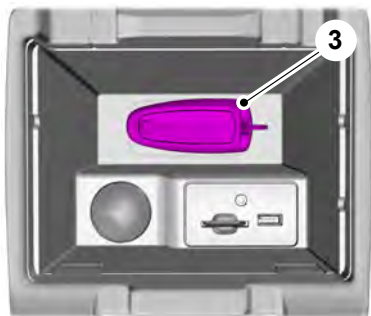

E184386

3. Place the key flat on the symbol at the bottom of the floor console storage compartment.
4. With the key in this position, press the brake pedal, then press the power button to switch the ignition on and start your vehicle.

Fast Restart

The fast restart feature allows you to restart your vehicle within 10 seconds of switching it off, even if it does not detect a valid passive key.

Within 10 seconds of switching your vehicle off, press the brake pedal and press the power button. After 10 seconds, you can no longer start your vehicle if it does not detect a valid passive key.

Once your vehicle has started, it remains running until you press the power button, even if it does not detect a valid passive key. If you open and close a door while your vehicle is running, the system searches for a valid passive key. You cannot start your vehicle if the system does not detect a valid passive key within 10 seconds.

SWITCHING OFF THE ELECTRIC MOTOR

WARNING



Switching off the electric motor when your vehicle is still moving will result in a loss of brake and steering assistance. The steering will not lock, but higher effort will be required. With the ignition switched off some electrical circuits, warning lamps and indicators may also be off. Failure to follow this warning could result in serious personal injury or death.

When your vehicle is not moving and the electric motor is on or the ignition is in accessory mode, press and release the power button without pressing the brake pedal. This will shut off the electric motor and all electrical accessories.

Starting and Stopping the Electric Motor

When your vehicle is moving, press the power button three times within two seconds or press and hold for at least one second. Move the transmission selector lever to position **N** and use the brakes to bring your vehicle to a safe stop. When your vehicle has come to a complete stop, move the transmission selector lever to position **P**.

High Voltage Battery

GENERAL INFORMATION

WARNINGS



This battery pack shall only be serviced by an authorized electric vehicle technician. Improper handling can result in personal injury or death.



Your vehicle consists of various high voltage components and wiring. All high voltage cables are labeled and covered with a solid orange covering or orange striped tape. Do not touch these components. Failure to follow this warning could result in serious personal injury or death.

The high voltage battery system is a high voltage, lightweight lithium-ion battery which has two individual packs. One pack is located in the rear cargo area behind the second row seats, the other is located underneath the vehicle. The high voltage battery system uses an advanced active liquid heating and cooling system to regulate high voltage battery temperature and help maximize the life of the high voltage battery.

Note: *The high voltage battery does not require regular service maintenance.*

Note: *The high voltage battery will experience gradual capacity loss with time and usage. This is normal.*

CHARGING THE HIGH VOLTAGE BATTERY

WARNINGS



Do not use the 120 volt convenience cord with an extension cord, two-prong adapter, surge protector, timer or other adapter.



In Canada, do not use the 120 volt convenience cord in commercial garages.

WARNINGS



This equipment has arcing or sparking parts, do not expose to flammable vapors. Position this equipment at least 18 inches (80 millimeters) above the floor.



The AC wall plug must fit firmly into the AC outlet. If the connection feels loose, worn or the AC outlet is damaged, please have a qualified electrician replace the AC outlet. Using a convenience cord with a worn outlet may cause burns, property damage and increase the risk of electric shock.

Charging Equipment

Your vehicle is equipped with a standard 120 volt convenience cord. Lift the load floor carpet in the rear of your vehicle to access the 120 volt convenience cord.

Note: *The 120 volt convenience cord allows you to charge the high voltage battery using a standard 120 volt household outlet. It takes approximately 18 hours to completely charge an empty battery using the standard 120 volt convenience cord.*

We recommend upgrading to the optional 240 volt charging station for faster more efficient charging.

Note: *The electrical source must meet certain requirements for the high-voltage batteries to charge. The AC outlet must be a three-prong 110-120 volt AC outlet that is properly grounded, 15–20 amps (or greater) and in good condition. You must use a dedicated line, which means you cannot have other appliances connected to the same circuit. If you do not use dedicated circuit, the circuit breaker could trip or open. If you do not have a dedicated circuit, contact a licensed professional electrician for proper installation.*

High Voltage Battery

Make sure that the 120 volt convenience cord is completely unwound before charging. Always plug the cord into the AC outlet before connecting the charging coupler into the charge port on your vehicle.

120 Volt Convenience Cord

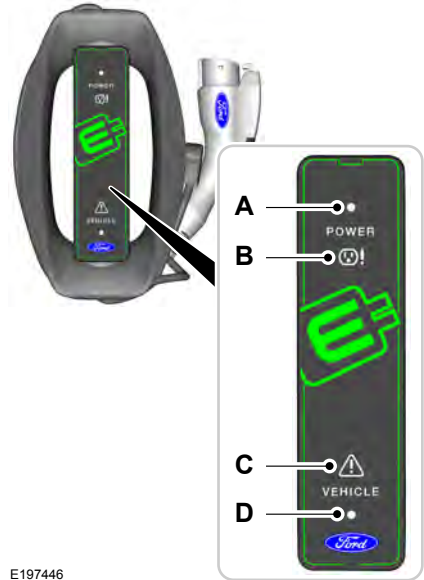

E197446

- A. Power.
- B. Check outlet (if equipped).
- C. Fault.
- D. Vehicle.

Note: When the convenience cord is plugged into an outlet, use the following table to determine your vehicle charge status. If the **POWER** indicator light is off after plugging in the convenience cord, use a different outlet.

High Voltage Battery

Convenience Cord LED Indicators			Status
Check Outlet (If Equipped)	Fault	Vehicle	
Off	Off	Off	The convenience cord is not connected to your vehicle.
Off	Off	On	The convenience cord is connected, but your vehicle is not charging.
Off	Off	Blink	Your vehicle is charging.
Off	Blink	Off	Ground Fault Circuit Interrupter (GFCI) Fault Detected. The convenience cord is retrying to charge.
Off	On	Off	Ground Fault Circuit Interrupter (GFCI) Fault Detected. The convenience cord has exhausted its retry attempts. Your vehicle is not charging, or there is an internal fault in the charging equipment.
Blink	Off	Off	The convenience cord detected a high temperature at the AC plug and is waiting for the AC plug to return to a normal operating temperature.*
Blink	Off	On	The convenience cord detected a high temperature at the AC plug. The AC plug has returned to a normal operating temperature. Your vehicle is ready to charge at a reduced current.*
Blink	Off	Blink	The convenience cord detected a high temperature at the AC plug. The AC plug has returned to a normal operating temperature. Your vehicle is charging at a reduced current.*
Blink	On	Off	The convenience cord detected a high temperature at the AC plug. Your vehicle is not charging. The convenience cord has exhausted its retry attempts.*

*Have the outlet checked by a qualified electrician and make sure the AC plug fits firmly into the outlet. Contact an authorized EV certified dealer if problem persists.

High Voltage Battery

Charge Port

The charge port is located between the front left-hand side door and the front left-hand side wheel well. Press the indentation on the charge port door to open and close it.

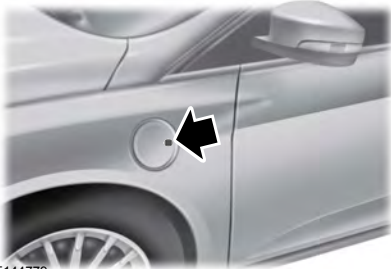

E144779

Note: Do not force the charge port door open or closed. Forcing the door open or closed damages the charge port.

You can modify the light ring illumination settings. The light ring located around the charge port indicates the charge status of the high voltage battery in your vehicle. Divided into four quadrants, the charge port light ring displays the state of charge in 25 percent increments.

You can press the unlock button on your key fob to view the charge status of your vehicle. Based on which quadrants light, you can determine the current state of charge. If the charge is below 25 percent, the light ring does not light. Do not forget to press the lock button on your key fob to re-lock your vehicle.

The light ring also displays the current state of charge when opening the doors.

The cord acknowledgment feature activates when you initiate a charge cycle. The four light quadrants each individually flash in a clockwise motion, starting with the top right-hand side light and ending with the top left-hand side, two times confirming that the system detects the charging coupler.

Charging

Note: Your vehicle must be in park (P) to charge.

To charge your high voltage battery:

1. Put your vehicle in park (P) and switch off your vehicle.
2. Press the indentation on the charge port door to open it.
3. Plug the charging coupler into the charge port on your vehicle. Make sure the button clicks confirming you have completely engaged the coupler.



E144780

4. Verify that the cord acknowledgment feature activates. The cord acknowledgment feature activates when you initiate a charge cycle.
5. If using a 240 volt charging station, follow the instructions on the charge station to begin the charging process.

High Voltage Battery

The light ring located around the charge port indicates the charge status of the high voltage battery in your vehicle:

- When the top right-hand side quadrant is pulsing, the charge is between 0-25 percent.
- When the top right-hand side quadrant is on and the bottom right-hand quadrant is pulsing, the charge is between 25-50 percent.
- When both right-hand side quadrants are on and the bottom left-hand side quadrant is pulsing, the charge is between 50-75 percent.
- When three quadrants are on and the top left-hand side quadrant is pulsing, the charge is between 75-100 percent.
- When all the lights on the light ring are on, the charge is complete.

Note: The light ring will turn off one minute after reaching a full charge.

Locking the Charging Coupler

Note: To lock the charging coupler, you need a padlock or a combination lock with a shackle diameter of 0.2 in (5 mm) or less. Also, the straight portion of the shackle must be 1.0 in (25.4 mm) or longer.

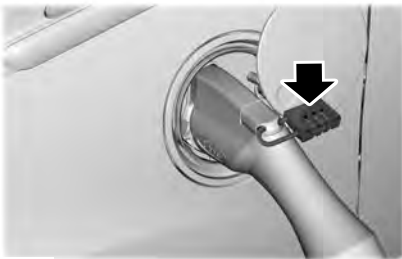

E172036

1. Insert the lock through the hole in the charging coupler button.
2. Lock the padlock or combination lock.

Waiting to Charge

Note: See charge settings in the MyFord Touch section. See **MyFord Touch™** (page 231).

When you select Value Charge, charging may not begin upon plugging in. The vehicle may delay charging to take advantage of off-peak electricity rates. The vehicle will optimize the charge schedule to be complete by the next GO Time.

When waiting to charge (not actively charging), the light ring will indicate the present state of charge of the high voltage battery as follows:

- When the top right quadrant light is off, the charge is between 0-25 percent.
- When the top right quadrant light is on and the bottom right quadrant is off, the charge is between 25-50 percent.
- When both right side quadrant lights are on and the bottom left quadrant is off, the charge is between 50-75 percent.
- When three quadrant lights are on and the top left quadrant is off, the charge is between 75-100 percent.
- When all lights on the entire ring are on, the charge is 100 percent.

Note: When the vehicle is waiting to charge, the light ring will turn off one minute after displaying the present state of charge. When the vehicle automatically begins charging, the light ring will turn on and display how far along the charge is per the section above.

Note: If the system detects a vehicle charging system fault at any point in a charge cycle, the entire light ring will flash continuously for one minute and then turn off. If this happens, unplug the charging coupler and then plug it back into the charge port receptacle. If the problem persists, contact an authorized dealer.

High Voltage Battery

You can modify the light ring lighting conditions. See Charge Port Light Ring Settings in the MyFord Touch section. See **MyFord Touch™** (page 231).

Disconnecting the Charging Coupler

Note: Do not pull the wall plug from the wall while the vehicle is charging. Doing so may damage the outlet and the cord.

1. Remove the lock from the charging coupler button.
2. Press the button on the charging coupler.
3. While holding the button, remove the charging coupler from the charge port receptacle on your vehicle.

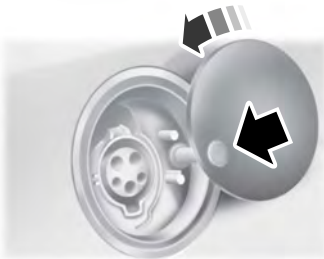

E144781

4. Close the charge port door by pressing the indentation on the charge port door. Continue pressing the indentation while the door rotates counterclockwise and closes.

Convenience Charging and MyFord Mobile

Use the MyFord Mobile app to set up the charging convenience features. Visit myfordmobile.com for more complete information and to set up your MyFord Mobile account.

Your vehicle has the following features to improve your charging experience.

Value Charge

The vehicle schedules charging at the lowest available utility rates. Contact your utility company to see what rates are available.

Charge Now

Fully charge your vehicle at the quickest rate. The vehicle starts charging immediately after you connect the charging plug into the vehicle.

My GO Time

Setting My GO times through the MyFord Mobile application allows you to set charging schedules and cabin preconditioning settings so your vehicle is ready to drive when you are. By setting a My GO time the vehicles charge can be completed before your next set drive time. A calendar view allows you to program two My GO Times per day for each of the seven days of the week. Remember, your vehicle must be plugged in for My GO time to work.

Cabin Preconditioning

Get the most miles out of every charge by preconditioning your vehicle while it's still plugged in and charging. Use your smart phone to set the cabin temperature and departure time before you leave so you use energy from your home wall outlet instead of your battery to heat or cool your vehicle.

HIGH VOLTAGE BATTERY CUT-OFF SWITCH

The high voltage shut off operation shuts off power from the high-voltage battery after a collision, or if your vehicle receives a substantial physical jolt.

To reactivate your vehicle after either event, perform the following steps:

High Voltage Battery

1. Press the **START/STOP** button to power off your vehicle.
2. Press the brake pedal and press the **START/STOP** button.
3. If your vehicle is not powered after this sequence, repeat steps 1 and 2 up to two more times.

Note: *During this process, your vehicle detects if the electrical system is safe and reactivates. Once your vehicle determines the electrical system safe, you can start your vehicle as you would normally by pressing the brake in combination with the **START/STOP** button.*

Note: *In the event your vehicle does not reactivate after the third power cycle, contact an authorized dealer.*

Transmission

AUTOMATIC TRANSMISSION

Single Speed Automatic Transmission

WARNING



Always set the parking brake fully and make sure you shift the gearshift lever to park (P). Switch the ignition off and remove the key whenever you leave your vehicle.

The single speed transmission is built specifically to handle the high rotational speed range of an electric motor.

Gearshift Lever Positions



E157387

- P Park.
- R Reverse.
- N Neutral.
- D Drive.
- L Low.

Press the button on the gearshift lever to change to each position.

The gearshift lever position appears in the information display.

Park (P)

In this position, power is not transmitted to the drive wheels and the transmission is locked. You can start the electric motor with the gearshift lever in this position.

Reverse (R)

With the gearshift lever in reverse (R), the vehicle moves backward. Always come to a complete stop before shifting into and out of reverse (R).

Neutral (N)

In this position, power is not transmitted to the drive wheels but the transmission is not locked. You can start the electric motor with the gearshift lever in this position.

Drive (D)

The normal position for driving your vehicle. The transmission operates in a single gear built specifically to handle the electric motor output.

Low (L)

Use this position for maximum motor braking, for example when driving down a steep hill. You can select this position at any vehicle speed.

Brake-Shift Interlock

WARNINGS



Do not drive your vehicle until you verify that the brake lamps are working.



When performing this procedure, you will be taking the vehicle out of park which means the vehicle can roll freely. To avoid unwanted vehicle movement, always fully set the parking brake prior to performing this procedure. Use wheel chocks if appropriate.

Transmission

WARNINGS



If the parking brake is fully released, but the brake warning lamp remains illuminated, the brakes may not be working properly. See your authorized dealer.

In the event of an electrical malfunction or if the vehicle battery has no charge, use the following procedure to shift the gearshift lever from the park (P) position.

Apply the parking brake and switch the ignition off before carrying out this procedure.

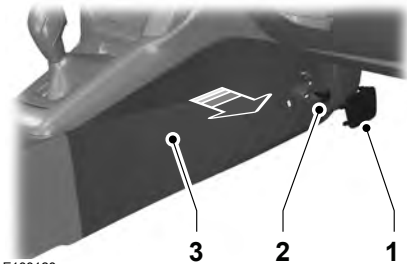

E133128

1. Using a suitable tool, carefully pry off and remove the passenger side access cover.
2. Remove the retaining clip.
3. Remove the center console side panel.

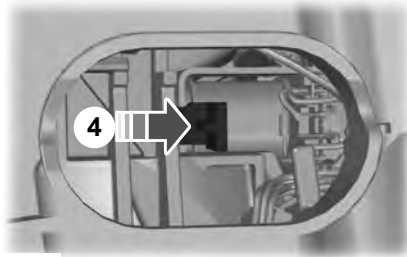

E133129

Note: The lever is white.

4. Apply the brake pedal. Using a suitable tool rotate the lever forward while pulling the gearshift lever out of the park (P) position and into the neutral (N) position.
5. Install components in the reverse order of removal.

Note: Contact an authorized dealer as soon as possible if this procedure is used.

If Your Vehicle Gets Stuck In Mud or Snow

If your vehicle is stuck in mud or snow, shift between drive (D) and reverse (R) pressing lightly on the accelerator pedal in each gear. Stop between shifts in a steady pattern to rock your vehicle.

Note: Do not rock your vehicle if the electric motor is not at normal operating temperature or damage to the transmission may occur.

Note: Excessive rocking may eventually cause a loss of power, as your vehicle protects against overheating or damage.

Brakes

GENERAL INFORMATION

Note: Occasional brake noise is normal. If a metal-to-metal, continuous grinding or continuous squeal sound is present, the brake linings may be worn-out. Have the system checked by an authorized dealer. If the vehicle has continuous vibration or shudder in the steering wheel while braking, have it checked by an authorized dealer.

Note: Brake dust may accumulate on the wheels, even under normal driving conditions. Some dust is inevitable as the brakes wear and does not contribute to brake noise. See **Cleaning the Alloy Wheels** (page 186).



See **Warning Lamps and Indicators** (page 83).

Wet brakes result in reduced braking efficiency. Gently press the brake pedal a few times when driving from a car wash or standing water to dry the brakes.

Brake Over Accelerator

In the event the accelerator pedal becomes stuck or entrapped, apply steady and firm pressure to the brake pedal to slow the vehicle and reduce engine power. If you experience this condition, apply the brakes and bring your vehicle to a safe stop. Move the transmission to park (P), switch the engine off and apply the parking brake. Inspect the accelerator pedal for any interference. If none are found and the condition persists, have your vehicle towed to the nearest authorized dealer.

Brake Assist

Brake assist detects when you brake heavily by measuring the rate at which you press the brake pedal. It provides maximum braking efficiency as long as you press the pedal. Brake assist can reduce stopping distances in critical situations.

Anti-lock Brake System

This system helps you maintain steering control during emergency stops by keeping the brakes from locking.



This lamp momentarily illuminates when you turn the ignition on. If the light does not illuminate during start up, remains on or flashes, the system may be disabled. Have the system checked by an authorized dealer. If the anti-lock brake system is disabled, normal braking is still effective.



If the brake warning lamp illuminates when you release the parking brake, have the system checked by an authorized dealer.

Regenerative Braking System

This feature is used to simulate the engine braking of an internal combustion engine and assist the standard brake system while recovering some of the energy of motion and storing it in the battery to improve the range of your vehicle. The standard brake system is designed to fully stop the car if regenerative braking is not available. During regenerative braking, the motor is spun as a generator to create electrical current. This recharges the battery and slows the vehicle. In effect, once the accelerator pedal is released, the motor changes from an energy user to an energy producer.

When the accelerator pedal is released or the brake pedal is applied, the brake controller automatically detects the amount of deceleration requested and optimizes how much of the deceleration will be produced by regenerative braking. The remaining portion is generated by

Brakes

standard friction braking. When the battery is almost fully charged, the amount of regenerative braking is limited to avoid overcharging, and the requested deceleration is produced by standard friction braking alone.

Regenerative braking does not take the place of the standard friction brakes; it only assists them. Regenerative braking has also been designed to interact with the anti-lock brake system. Regenerative braking is disabled when the anti-lock brake system is activated or the battery is fully charged.

HINTS ON DRIVING WITH ANTI-LOCK BRAKES

Note: *When the system is operating, the brake pedal will pulse and may travel further. Maintain pressure on the brake pedal. You may also hear a noise from the system. This is normal.*

The anti-lock braking system will not eliminate the risks when:

- You drive too closely to the vehicle in front of you.
- Your vehicle is hydroplaning.
- You take corners too fast.
- The road surface is poor.

PARKING BRAKE

WARNING



Always set the parking brake fully and make sure you shift the gearshift lever to park (P). Switch the ignition off and remove the key whenever you leave your vehicle.

Note: *Do not press the release button while pulling the lever up.*

To apply the parking brake:

1. Press the foot brake pedal firmly.
2. Pull the parking brake lever up to its fullest extent.

Note: *If you park your vehicle on a hill and facing uphill, shift the gearshift lever to park (P) and turn the steering wheel away from the curb.*

Note: *If you park your vehicle on a hill and facing downhill, shift the gearshift lever to park (P) and turn the steering wheel toward the curb.*

To release the parking brake:

1. Press the brake pedal firmly.
2. Pull the lever up slightly.
3. Press the release button and push the lever down.

HILL START ASSIST

WARNINGS



The system does not replace the parking brake. When you leave your vehicle, always apply the parking brake and shift the transmission into park (P) for automatic transmission or first gear for manual transmission.



You must remain in your vehicle once you have activated the system.



During all times, you are responsible for controlling your vehicle, supervising the system and intervening, if required.



If the engine is revved excessively, or if a malfunction is detected, the system will be deactivated.

The system makes it easier to pull away when your vehicle is on a slope without the need to use the parking brake.

Brakes

When the system is active, your vehicle will remain stationary on the slope for two to three seconds after you release the brake pedal. This allows you time to move your foot from the brake to the accelerator pedal. The brakes are released automatically once the engine has developed sufficient drive to prevent your vehicle from rolling down the slope. This is an advantage when pulling away on a slope, for example from a car park ramp, traffic lights or when reversing uphill into a parking space.

The system will activate automatically on any slope that will cause significant vehicle rollback. For vehicles with a manual transmission, you can switch this feature off using the information display. See **Information Displays** (page 86). The system will remain on or off depending on how it was last set.

Note: *The system only functions when you bring your vehicle to a complete stop. Shift into reverse (R) when facing downhill and first gear (1) when facing uphill.*

Note: *There is no warning lamp to indicate the system is either on or off.*

Using Hill Start Assist

1. Press the brake pedal to bring your vehicle to a complete standstill. Keep the brake pedal pressed.
2. If the sensors detect that your vehicle is on a slope, the system will activate automatically.
3. When you remove your foot from the brake pedal, your vehicle will remain on the slope without rolling away for about two or three seconds. This hold time will automatically be extended if you are in the process of driving off.
4. Drive off in the normal manner. The brakes will release automatically.

Traction Control

PRINCIPLE OF OPERATION

The traction control system helps avoid drive wheel spin and loss of traction.

If your vehicle begins to slide, the system applies the brakes to individual wheels and, when needed, reduces engine power at the same time. If the wheels spin when accelerating on slippery or loose surfaces, the system reduces engine power in order to increase traction.

USING TRACTION CONTROL

If your vehicle is stuck in mud or snow, switching traction control off may be beneficial, this allows the wheels to spin.

You can switch this feature on or off using the vehicle settings menu in the information display or by pressing the button on the instrument panel.

Switching the System Off Using the Information Display Controls

(If Equipped)

Your vehicle comes with this feature already enabled. You can switch this feature on or off using the vehicle settings menu in the information display. See (page 86).

Switching the System Off Using a Switch (If Equipped)

The button is located on the instrument panel. See **Instrument Panel Overview** (page 15).

Press the button to switch the system off. You will see a message in conjunction with an illuminated icon in the display. Press the button again to switch the system back on.

When you switch the traction control system off, stability control remains fully active.

System Warning Lamps and Messages

WARNING



If the warning lamp remains illuminated or does not illuminate when you switch the ignition on, this indicates a malfunction. During a malfunction the system will switch off. Have the system checked immediately. Operating your vehicle with the system disabled could lead to the loss of vehicle control, vehicle rollover, personal injury or death.



The warning lamp temporarily illuminates when you start the engine. It will flash when the system is active.



The warning lamp temporarily illuminates when you start the engine. It will illuminate when you switch the system off.

When you switch the system off or on, a message appears in the information display showing system status.

Stability Control

PRINCIPLE OF OPERATION

WARNINGS



Vehicle modifications involving braking system, aftermarket roof racks, suspension, steering system, tire construction and wheel and tire size may change the handling characteristics of the vehicle and may adversely affect the performance of the AdvanceTrac system. In addition, installing any stereo loudspeakers may interfere with and adversely affect the AdvanceTrac system. Install any aftermarket stereo loudspeaker as far as possible from the front center console, the tunnel, and the front seats in order to minimize the risk of interfering with the AdvanceTrac sensors. Reducing the effectiveness of the AdvanceTrac system could lead to an increased risk of loss of vehicle control, vehicle rollover, personal injury and death.



Remember that even advanced technology cannot defy the laws of physics. It's always possible to lose control of a vehicle due to inappropriate driver input for the conditions. Aggressive driving on any road condition can cause you to lose control of your vehicle increasing the risk of personal injury or property damage. Activation of the AdvanceTrac system is an indication that at least some of the tires have exceeded their ability to grip the road; this could reduce the operator's ability to control the vehicle potentially resulting in a loss of vehicle control, vehicle rollover, personal injury and death. If your AdvanceTrac system activates, SLOW DOWN.

The AdvanceTrac Control system helps you keep control of your vehicle when on a slippery surface. The electronic stability control portion of the system helps avoid skids and lateral slides. The traction control system helps avoid drive wheel spin and loss of traction. See **Using Traction Control** (page 127).

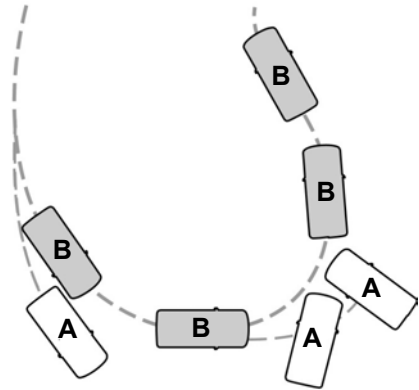

E72903

- A Vehicle without AdvanceTrac skidding off its intended route.
- B Vehicle with AdvanceTrac maintaining control on a slippery surface.

Parking Aids

REAR PARKING AID (If Equipped)

WARNINGS



The parking aid system can only assist you to detect objects when your vehicle is moving at parking speeds. Take care when using the system to avoid personal injury.



The parking aid system may not prevent contact with small or moving objects that are close to the ground. The parking aid system gives an audible warning when it detects a large object helping to avoid damage to your vehicle. To help avoid personal injury you must take care when using the parking aid system.



Traffic control systems, inclement weather, air brakes and external motors and fans may affect correct operation of the sensing system; this may include reduced performance or a false alerts.

Parking aid automatically turns on when you shift into reverse (R). When your vehicle approaches an object, a warning tone sounds. When your vehicle moves closer to an object, the warning tone repeat rate will increase. The warning tone sounds continuously when an object is 12 in (30 cm) or less from the rear bumper.



E130178

Rear Sensing System

When the parking aid system produces an audible warning, the audio system may reduce the set volume to a predetermined level.

Note: Some add-on equipment can cause reduced performance or a false alert. For example, large trailer hitches, bike or surfboard racks.

Note: Keep the sensors free from snow, ice and large accumulations of dirt. If the sensors are blocked system accuracy may be affected. Do not clean the sensors with sharp objects.

Note: If your vehicle sustains damage leaving the sensors misaligned, this will cause inaccurate measurements or false alerts.

- A Sensor coverage area is up to 71 in (180 cm) from the rear bumper.

Note: There is decreased coverage at the outer corners.

The system will detect objects when you shift into reverse (R) and:

- Your vehicle is moving backward at low speed.
- Your vehicle is stationary but an object is approaching the rear of your vehicle at a low speed.
- Your vehicle is moving backward at low speed and an object is approaching the rear of your vehicle at a low speed.

Note: If your vehicle remains stationary for two seconds the audible tone will mute. If your vehicle moves backward, you will hear the tone again.

Parking Aids

Press the parking aid button to switch the system off. If a fault is present in the system, a warning message appears in the information display and does not allow you to switch the system on.

REAR VIEW CAMERA

WARNINGS



The rear view camera system is a reverse aid supplement device that still requires the driver to use it in conjunction with the interior and exterior mirrors for maximum coverage.



Objects that are close to either corner of the bumper or under the bumper, might not be seen on the screen due to the limited coverage of the camera system.



Back up as slow as possible since higher speeds might limit your reaction time to stop your vehicle.



Use caution when using the rear video camera and the luggage compartment door is ajar. If the luggage compartment door is ajar, the camera will be out of position and the video image may be incorrect. All guidelines disappear when the luggage compartment door is ajar.



Use caution when turning camera features on or off. Make sure your vehicle is not moving.

The rear view camera system provides a video image of the area behind your vehicle.

During operation, lines appear in the display which represent your vehicle's path and proximity to objects behind your vehicle.



E142435

The camera is located on the luggage compartment door.

Using the Rear View Camera System

The rear view camera system displays what is behind your vehicle when you place the transmission in reverse (R).

Note: *The reverse sensing system is not effective at speeds above 7 mph (12 km/h) and may not detect certain angular or moving objects.*

The system uses three types of guides to help you see what is behind your vehicle:

- Active guidelines: Show the intended path of your vehicle when reversing.
- Fixed guidelines: Show the actual path your vehicle is moving in while reversing in a straight line. This can be helpful when backing into a parking space or aligning your vehicle with another object behind you.
- Centerline: Helps align the center of your vehicle with an object (for example, a trailer).

Note: *If the transmission is in reverse (R) and the luggage compartment is ajar, no rear view camera features display.*

Parking Aids

Note: When towing, the camera only sees what is towed behind your vehicle. This might not provide adequate coverage as it usually provides in normal operation and some objects might not be seen. In some vehicles, the guidelines may disappear once the trailer tow connector is engaged.

The camera may not operate correctly under the following conditions:

- Nighttime or dark areas if one or both reverse lamps are not operating.
- Mud, water or debris obstructs the camera's view. Clean the lens with a soft, lint-free cloth and non-abrasive cleaner.
- The rear of your vehicle is hit or damaged, causing the camera to become misaligned.

Camera Guidelines

Note: Active guidelines are only available when the transmission is in reverse (R).

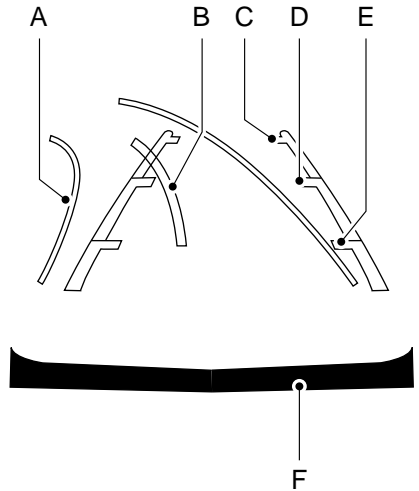

E142436

- A Active guidelines
- B Centerline
- C Fixed guideline: Green zone
- D Fixed guideline: Yellow zone
- E Fixed guideline: Red zone
- F Rear bumper

Active guidelines only show with fixed guidelines. To use active guidelines, turn the steering wheel to point the guidelines toward an intended path. If the steering wheel position changes while reversing, your vehicle might deviate from the original intended path.

The fixed and active guidelines fade in and out depending on the steering wheel position. The active guidelines do not display when the steering wheel position is straight.

Parking Aids

Always use caution while reversing. Objects in the red zone are closest to your vehicle and objects in the green zone are farther away. Objects are getting closer to your vehicle as they move from the green zone to the yellow or red zones. Use the side view mirrors and rear view mirror to get better coverage on both sides and rear of your vehicle.

Manual Zoom

WARNING



When manual zoom is on, the full area behind your vehicle may not show. Be aware of your surroundings when using the manual zoom feature.

Note: *Manual zoom is only available when the transmission is in reverse (R).*

Note: *When you enable manual zoom, only the centerline is shown.*

Selectable settings for this feature are Zoom in (+) and Zoom out (-). Press the symbol in the camera screen to change the view. The default setting is Zoom OFF.

This allows you to get a closer view of an object behind your vehicle. The zoomed image keeps the bumper in the image to provide a reference. The zoom is only active while the transmission is in reverse (R).

Camera System Settings

To access any of the rear view camera system settings, make the following selections in the multifunctional display when the transmission is not in reverse (R):

- With Touch Screen: Settings > Vehicle > Camera Settings
- Without Touch Screen: Menu > Camera Settings

Enhanced Park Aids or Park Pilot (If Equipped)

Selectable settings for this feature are ON and OFF.

The system uses red, yellow and green highlights that appear on top of the video image when any of the sensing systems detect an object.

Rear Camera Delay

Selectable settings for this feature are ON and OFF.

The default setting for the rear camera delay is OFF.

When shifting the transmission out of reverse (R) and into any gear other than park (P), the camera image remains in the display until:

- Your vehicle speed sufficiently increases.
- You shift your vehicle into park (P).
- 10 seconds of time elapse.

Cruise Control

PRINCIPLE OF OPERATION

Cruise control lets you maintain a set speed without keeping your foot on the accelerator pedal. You can use cruise control when your vehicle speed is greater than 20 mph (30 km/h).

USING CRUISE CONTROL

WARNINGS



Do not use cruise control on winding roads, in heavy traffic or, when the road surface is slippery. This could result in loss of vehicle control, serious injury or death.



When you are going downhill, your vehicle speed may increase above the set speed. The system will not apply the brakes but a warning displays.



E142437

The cruise controls are on the steering wheel.

Switching Cruise Control On

Press and release **ON**.



The indicator appears in the instrument cluster.

Setting the Cruise Speed

1. Drive to desired speed.
2. Press and release **SET+**.
3. Take your foot off the accelerator pedal.

Note: *The indicator will change color.*

Note: *Cruise control will disengage if the vehicle speed decreases more than 10 mph (16 km/h) below the set speed while driving uphill.*

Changing the Set Speed

- Press the accelerator or brake pedal until you reach the desired speed. Press and release **SET+**.
- Press and hold **SET+** or **SET-**. Release the control when you reach the desired speed.
- Press and release **SET+** or **SET-**. The set speed will change in approximately 3 mph (5 km/h) increments.

Note: *If you accelerate by pressing the accelerator pedal, the set speed will not change. When you release the accelerator pedal, your vehicle returns to the speed that you previously set.*

Canceling the Set Speed

Press and release **CAN** or tap the brake pedal. You will not erase the set speed.

Resuming the Set Speed

Press and release **RES**.

Switching Cruise Control Off

Press and release **OFF** when the system is in stand by mode or switch the ignition off.

Note: *You will erase the set speed if you switch the system off.*

Driving Aids

STEERING

Electric Power Steering

WARNING



The electric power steering system has diagnostic checks that continuously monitor the system. If a fault is detected, a message displays in the information display. Stop your vehicle as soon as it is safe to do so. Switch the ignition off. After at least 10 seconds, switch the ignition on and watch the information display for a steering system warning message. If a steering system warning message returns, have the system checked by an authorized dealer.

Your vehicle has an electric power steering system. There is no fluid reservoir. No maintenance is required.

If your vehicle loses electrical power while you are driving, electric power steering assistance is lost. The steering system still operates and you can steer your vehicle manually. Manually steering your vehicle requires more effort.

Extreme continuous steering may increase the effort required for you to steer your vehicle. This increased effort prevents overheating and permanent damage to the steering system. You do not lose the ability to steer your vehicle manually. Typical steering and driving maneuvers allow the system to cool and return to normal operation.

Steering Tips

If the steering wanders or pulls, check for:

- Correct tire pressures.
- Uneven tire wear.
- Loose or worn suspension components.

- Loose or worn steering components.
- Improper vehicle alignment.

Note: *A high crown in the road or high crosswinds may also make the steering seem to wander or pull.*

Adaptive Learning

The electronic power steering system adaptive learning helps correct road irregularities and improves overall handling and steering feel. It communicates with the brake system to help operate advanced stability control and accident avoidance systems. Additionally, whenever the battery is disconnected or a new battery installed, you must drive your vehicle a short distance before the system relearns the strategy and reactivates all systems.

Load Carrying

REAR UNDER FLOOR STORAGE

Cargo Management System (If Equipped)



E188928

The system is located in the floor of the cargo area. Lift the handle to open.

LOAD LIMIT

Vehicle Loading - with and without a Trailer

This section will guide you in the proper loading of your vehicle, trailer or both, to keep your loaded vehicle weight within its design rating capability, with or without a trailer. Properly loading your

vehicle will provide maximum return of vehicle design performance. Before loading your vehicle, familiarize yourself with the following terms for determining your vehicle's weight ratings, with or without a trailer, from the vehicle's Tire Label or Safety Compliance Certification Label:

Base Curb Weight - is the weight of the vehicle including full fluids and all standard equipment. It does not include passengers, cargo, or optional equipment.

Vehicle Curb Weight - is the weight of your new vehicle when you picked it up from your authorized dealer plus any aftermarket equipment.

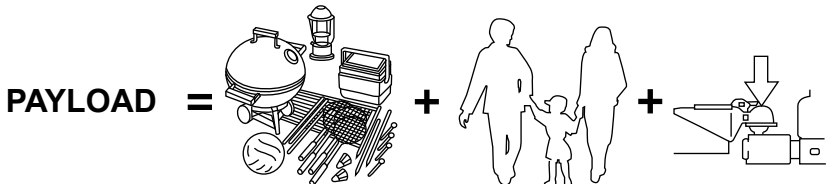

E143816

Load Carrying

Payload - is the combined weight of cargo and passengers that the vehicle is carrying. The maximum payload for your vehicle can be found on the Tire Label on the B-Pillar or the edge of the driver door (vehicles exported outside the US and Canada may not have a Tire Label). Look for **“THE COMBINED WEIGHT OF OCCUPANTS AND CARGO SHOULD NEVER EXCEED XXX kg OR XXX lb.”** for maximum payload. The payload listed on the Tire Label is the maximum payload for the vehicle as built by the assembly plant. If you install any aftermarket or

authorized-dealer installed equipment on the vehicle, you must subtract the weight of the equipment from the payload listed on the Tire Label in order to determine the new payload.

WARNING

 The appropriate loading capacity of your vehicle can be limited either by volume capacity (how much space is available) or by payload capacity (how much weight the vehicle should carry). Once you have reached the maximum payload of your vehicle, do not add more cargo, even if there is space available. Overloading or improperly loading your vehicle can contribute to loss of vehicle control and vehicle rollover.

Example only:



TIRE AND LOADING INFORMATION

SEATING CAPACITY	TOTAL 5	FRONT 2	REAR 3
------------------	---------	---------	--------

The combined weight of occupants and cargo should never exceed : **XXX kg or XXX lbs.**

TIRE	SIZE	COLD TIRE PRESSURE	SEE OWNERS MANUAL FOR ADDITIONAL INFORMATION
FRONT	LT225/75R 16.5E	200 KPA, 29 PSI	
REAR	LT225/75R 16.5E	200 KPA, 29 PSI	
SPARE	T145/80D16 P225/60R17	420 KPA, 60 PSI 200 KPA, 29 PSI	

XXXXXXXXXXXXXXXX

E142516

Load Carrying

TIRE AND LOADING INFORMATION RENSEIGNEMENTS SUR LES PNEUS ET LE CHARGEMENT				
SEATING CAPACITY NOMBRE DE PLACES		TOTAL 5	FRONT AVANT 2	REAR ARRIÈRE 3
The combined weight of occupants and cargo should never exceed Le poids total des occupants et du chargement ne doit jamais dépasser				492 kg or 1085 lbs.
TIRE PNEU	SIZE DIMENSIONS	COLD TIRE PRESSURE PRESSION DES PNEUS A FROID		SEE OWNER'S MANUAL FOR ADDITIONAL INFORMATION VOIR LE MANUEL DE L'USAGER POUR PLUS DE RENSEIGNEMENTS
FRONT AVANT	P235/70R16	240 KPA, 35 PSI		
REAR ARRIÈRE	P235/70R16	240 KPA, 35 PSI		
SPARE DE SECOURS	T145/90R17	415 KPA, 60 PSI		

E142517

CARGO

=



+

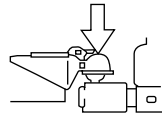

E143817

Cargo Weight - includes all weight added to the Base Curb Weight, including cargo and optional equipment. When towing, trailer tongue load or king pin weight is also part of cargo weight.

GAW (Gross Axle Weight) - is the total weight placed on each axle (front and rear) including vehicle curb weight and all payload.

GAW (Gross Axle Weight Rating) - is the maximum allowable weight that can be carried by a single axle (front or rear). These numbers are shown on the Safety Compliance Certification Label. The label shall be affixed to either the door hinge pillar, door-latch post, or the door edge that meets the door-latch post, next to the driver's seating position. **The total load on each axle must never exceed its Gross Axle Weight Rating.**

Load Carrying

Note: For trailer towing information refer to the RV and Trailer Towing Guide available at an authorized dealer.

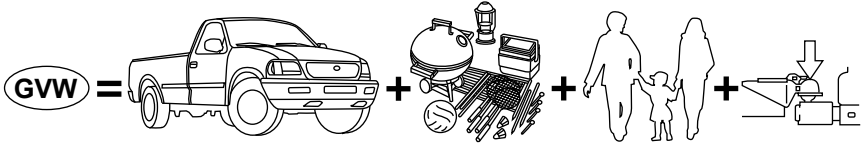

E143818

GVW (Gross Vehicle Weight) - is the Vehicle Curb Weight, plus cargo, plus passengers.

GVWR (Gross Vehicle Weight Rating) - is the maximum allowable weight of the fully loaded vehicle (including all options, equipment, passengers and cargo). It is shown on the

Example only:

Safety Compliance Certification Label. The label shall be affixed to either the door hinge pillar, door-latch post, or the door edge that meets the door-latch post, next to the driver's seating position. **The Gross Vehicle Weight must never exceed the Gross Vehicle Weight Rating.**

MFD. BY FORD MOTOR CO.

DATE: XX/XX		GVWR: XXXXXLB/ XXXXXKG	
FRONT GAWR: XXXXL		REAR GAWR: XXXXLB	
XXXXKG	WITH	XXXXKG	WITH
XXXX/XXXXXXXX	TIRES	XXXX/XXXXXXXX	TIRES
XXXX.XX	RIMS	XXXX.XX	RIMS
AT XXX kPa/XX	PSI COLD	AT XXX kPa/XX	PSI COLD

THIS VEHICLE CONFORMS TO ALL APPLICABLE FEDERAL MOTOR VEHICLE SAFETY STANDARDS IN EFFECT ON THE DATE OF MANUFACTURE SHOWN ABOVE.

VIN: XXXXXXXXXXXXXXXXXXXX XXXXX
XXXXX

TYPE: XXX

EXT PNT:	XX	RC:	XX	DSO:	
WB	INT TR	TP/PS	AXLE	TR	SPR
XXX	XX	X	XX	X	XX

XXXXXXXXXXXXXXXX XXX XXXX-XXXXXX-XX

E142523

Load Carrying

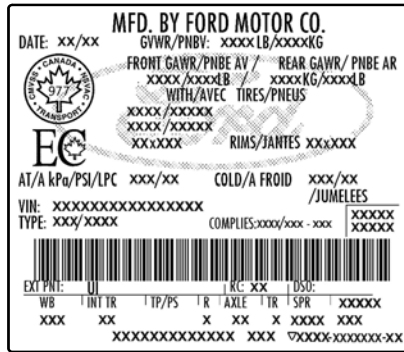

E142524

WARNING



Exceeding the Safety Compliance Certification Label vehicle weight rating limits could result in substandard vehicle handling or performance, engine, transmission and/or structural damage, serious damage to the vehicle, loss of control and personal injury.

$$\text{GCW} = \text{GVW} +$$

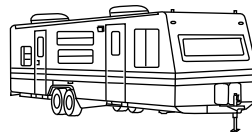

E143819

GCW (Gross Combined Weight) - is the Gross Vehicle Weight plus the weight of the fully loaded trailer.

GCWR (Gross Combined Weight Rating) - is the maximum allowable weight of the vehicle and the loaded trailer, including all cargo and passengers, that the vehicle can handle without risking damage. (Important: The towing vehicle's braking system is rated

Load Carrying



for operation at Gross Vehicle Weight Rating, not at Gross Combined Weight Rating.) Separate functional brakes should be used for safe control of towed vehicles and for trailers where the Gross Combined Weight of the towing vehicle plus the trailer exceed the Gross Vehicle Weight Rating of the towing vehicle. **The Gross Combined Weight must never exceed the Gross Combined Weight Rating.**

Maximum Loaded Trailer Weight - is the highest possible weight of a fully loaded trailer the vehicle can tow. It assumes a vehicle with mandatory options, driver and front passenger weight (150 pounds [68 kilograms] each), no cargo weight (internal or external) and a tongue load of 10–15% (conventional trailer) or king pin weight of 15–25% (fifth wheel trailer). Consult an authorized dealer (or the RV and Trailer Towing Guide available at an authorized dealer) for more detailed information.

Tongue Load or Fifth Wheel King Pin Weight - refers to the amount of the weight that a trailer pushes down on a trailer hitch.

Examples: For a 5000 pound (2268 kilogram) conventional trailer, multiply 5000 by 0.10 and 0.15 to obtain a proper tongue load range of 500 to 750 pounds (227 to 340 kilograms). For an 11500 pound (5216 kilogram) fifth wheel trailer, multiply by 0.15 and 0.25 to obtain a proper king pin load range of 1725 to 2875 pounds (782 to 1304 kilograms).

WARNINGS

-  Do not exceed the GVWR or the GAWR specified on the Safety Compliance Certification Label.
-  Do not use replacement tires with lower load carrying capacities than the original tires because they may lower the vehicle's GVWR and GAWR limitations. Replacement tires with a higher limit than the original tires do not increase the GVWR and GAWR limitations.
-  Exceeding any vehicle weight rating limitation could result in serious damage to the vehicle and/or personal injury.

Steps for determining the correct load limit:

1. Locate the statement "The combined weight of occupants and cargo should never exceed XXX kg or XXX lb." on your vehicle's placard.

Load Carrying

- Determine the combined weight of the driver and passengers that will be riding in your vehicle.
- Subtract the combined weight of the driver and passengers from XXX kg or XXX lb.
- The resulting figure equals the available amount of cargo and luggage load capacity. For example, if the “XXX” amount equals 1,400 lb. and there will be five 150 lb. passengers in your vehicle, the amount of available cargo and luggage load capacity is 650 lb. $(1400 - 750 (5 \times 150) = 650 \text{ lb.})$
- Determine the combined weight of luggage and cargo being loaded on the vehicle. That weight may not safely exceed the available cargo and luggage load capacity calculated in Step 4.
- If your vehicle will be towing a trailer, load from your trailer will be transferred to your vehicle. Consult this manual to determine how this reduces the available cargo and luggage load capacity of your vehicle.

The following gives you a few examples on how to calculate the available amount of cargo and luggage load capacity:

*Suppose your vehicle has a 1400-pound (635-kilogram) cargo and luggage capacity. You decide to go golfing. Is there enough load capacity to carry you, four of your friends and all the golf bags? You and four friends average 220 pounds (99 kilograms) each and the golf bags weigh approximately 30 pounds (13.5 kilograms) each. The calculation would be: $1400 - (5 \times 220) - (5 \times 30) = 1400 - 1100 - 150 = 150$ pounds. Yes, you have enough load capacity in your vehicle to transport four friends and your golf bags. In metric units, the calculation would be: $635 \text{ kilograms} - (5 \times 99 \text{ kilograms}) - (5 \times 13.5 \text{ kilograms}) = 635 - 495 - 67.5 = 72.5$ kilograms.

*Suppose your vehicle has a 1400-pound (635-kilogram) cargo and luggage capacity. You and one of your friends decide to pick up cement from the local home improvement store to finish that patio you have been planning for the past two years. Measuring the inside of the vehicle with the rear seat folded down, you have room for twelve 100-pound (45-kilogram) bags of cement. Do you have enough load capacity to transport the cement to your home? If you and your friend each weigh 220 pounds (99 kilograms), the calculation would be: $1400 - (2 \times 220) - (12 \times 100) = 1400 - 440 - 1200 = -240$ pounds. No, you do not have enough cargo capacity to carry that much weight. In metric units, the calculation would

Load Carrying

be: 635 kilograms - (2 x 99 kilograms) - (12 x 45 kilograms) = 635 - 198 - 540 = -103 kilograms. You will need to reduce the load weight by at least 240 pounds (104 kilograms). If you remove three 100-pound (45-kilogram) cement bags, then the load calculation would be: 1400 - (2 x 220) - (9 x 100) = 1400 - 440 - 900 = 60 pounds. Now you have the load capacity to transport the cement and your friend home. In metric units, the calculation would be: 635 kilograms - (2 x 99 kilograms) - (9 x 45 kilograms) = 635 - 198 - 405 = 32 kilograms.

The above calculations also assume that the loads are positioned in your vehicle in a manner that does not overload the Front or the Rear Gross Axle Weight Rating specified for your vehicle on the Safety Compliance Certification Label. The label shall be affixed to either the door hinge pillar, door-latch post, or the door edge that meets the door-latch post, next to the driver's seating position.

Towing

TOWING A TRAILER

WARNING



Never tow a trailer with your vehicle. This powertrain is not designed to tow.

TRANSPORTING THE VEHICLE

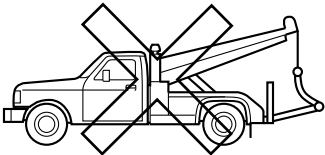
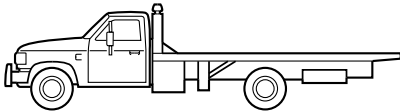
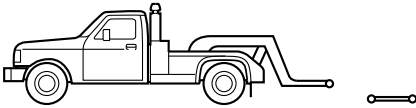

E143886

If you need to have your vehicle towed, contact a professional towing service or, if you are a member of a roadside assistance program, your roadside assistance service provider.

It is recommended that your vehicle be towed with a wheel lift and dollies or flatbed equipment. Do not tow with a slingbelt. Ford Motor Company has not approved a slingbelt towing procedure. If the vehicle is towed incorrectly, or by any other means, vehicle damage may occur.

Ford Motor Company produces a towing manual for all authorized tow truck operators. Have your tow truck operator refer to this manual for proper hook-up and towing procedures for your vehicle.

You can tow your vehicle from the front with wheel lift equipment to raise the front wheels off the ground. We recommend that you place the rear wheels on a dolly to prevent damage to the rear of your vehicle.

You can tow your vehicle from the rear with wheel lift equipment.

Note: *You must place the front wheels on a dolly to prevent damage to the transmission.*

TOWING THE VEHICLE ON FOUR WHEELS

Emergency Towing

If your vehicle becomes inoperable (without access to wheel dollies, car-hauling trailer, or flatbed transport vehicle), it can be flat-towed (all wheels on the ground, regardless of the powertrain and transmission configuration) under the following conditions:

- Tow only in the forward direction.
- The transmission in neutral (N). If you cannot move the transmission into neutral (N), you may need to override it. See **Automatic Transmission** (page 122).
- Maximum speed is 35 mph (56 km/h).
- Maximum distance is 50 miles (80 kilometers).

Towing

Recreational Towing

Follow these guidelines if you have a need for recreational (RV) towing. An example of recreational towing would be towing your vehicle behind a motorhome. We designed these guidelines to prevent damage to your transmission.

Do not tow your vehicle with any wheels on the ground, as vehicle or transmission damage may occur. It is recommended to tow your vehicle with all four wheels off the ground, for example when using a car-hauling trailer. Otherwise, you cannot tow your vehicle.

Driving Hints

BREAKING-IN

You need to break in new tires for approximately 300 mi (480 km). During this time, your vehicle may exhibit some unusual driving characteristics.

Avoid hard accelerations and driving too fast during the first 1000 mi (1,600 km).

COLD WEATHER PRECAUTIONS

The functional operation of some components and systems can be affected at temperatures below -13°F (-25°C).

DRIVING THROUGH WATER

WARNING



Do not drive through flowing or deep water as you may lose control of your vehicle.

Note: *Driving through standing water can cause vehicle damage.*

Note: *Engine damage can occur if water enters the air filter.*

Before driving through standing water, check the depth. Never drive through water that is higher than the bottom of the front rocker area of your vehicle.

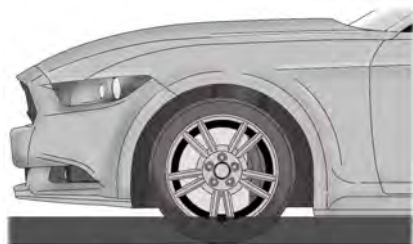

E176360

When driving through standing water, drive very slowly and do not stop your vehicle. Your brake performance and traction may be limited. After driving through water and as soon as it is safe to do so:

- Lightly press the brake pedal to dry the brakes and to check that they work.
- Check that the horn works.
- Check that the exterior lights work.
- Turn the steering wheel to check that the steering power assist works.

FLOOR MATS

WARNINGS



Always use floor mats that are designed to fit the foot well of your vehicle. Only use floor mats that leave the pedal area unobstructed. Only use floor mats that are firmly secured to retention posts so that they cannot slip out of position and interfere with the pedals or impair safe operation of your vehicle in other ways.



Pedals that cannot move freely can cause loss of vehicle control and increase the risk of serious personal injury.







Always make sure that the floor mats are properly attached to the retention posts in the carpet that are supplied with your vehicle. Floor mats must be properly secured to both retention posts to make sure mats do not shift out of position.



Never place floor mats or any other covering in the vehicle foot well that cannot be properly secured to prevent them from moving and interfering with the pedals or the ability to control the vehicle.

Driving Hints

WARNINGS

-  Never place floor mats or any other covering on top of already installed floor mats. Floor mats should always rest on top of vehicle carpeting surface and not another floor mat or other covering. Additional floor mats or any other covering will reduce the pedal clearance and potentially interfere with pedal operation.
-  Check attachment of floor mats on a regular basis. Always properly reinstall and secure floor mats that have been removed for cleaning or replacement.
-  Always make sure that objects cannot fall into the driver foot well while the vehicle is moving. Objects that are loose can become trapped under the pedals causing a loss of vehicle control.
-  Failure to properly follow floor mat installation or attachment instructions can potentially cause interference with pedal operation causing a loss of vehicle control.



To install floor mats, position the floor mat so that the eyelet is over the retention post and press down to lock in.

To remove the floor mat, reverse the installation procedure.

Roadside Emergencies

ROADSIDE ASSISTANCE

Vehicles Sold in the United States: Getting Roadside Assistance

To fully assist you should you have a vehicle concern, Ford Motor Company offers a complimentary roadside assistance program. This program is separate from the New Vehicle Limited Warranty. The service is available:

- 24 hours a day, seven days a week.
- For the coverage period listed on the Roadside Assistance Card included in your Owner's Manual portfolio.

Roadside Assistance covers:

- A flat tire change with a good spare, if provided with the vehicle (except vehicles supplied with a tire inflation kit).
- Battery jump start.
- Lock-out assistance (key replacement cost is the customer's responsibility).
- Fuel delivery — independent service contractors, if not prohibited by state, local or municipal law, shall deliver up to 2 gal (7.6 L) of gasoline or 5 gal (18.9 L) of diesel fuel to a disabled vehicle. Roadside Assistance limits fuel delivery service to two no-charge occurrences within a 12-month period.
- Winch out — available within 100 ft (30.5 m) of a paved or county maintained road, no recoveries.
- Towing — independent service contractors, if not prohibited by state, local or municipal law, shall tow Ford eligible vehicles to an authorized dealer within 35 mi (56 km) of the disablement location or to the nearest

authorized dealer. If a member requests a tow to an authorized dealer that is more than 35 mi (56 km) from the disablement location, the member shall be responsible for any mileage costs in excess of 35 mi (56 km).

Roadside Assistance includes up to \$200 for a towed trailer if the disabled eligible vehicle requires service at the nearest authorized dealer. If the towing vehicle is operational but the trailer is not, then the trailer does not qualify for any roadside services.

Vehicles Sold in the United States: Using Roadside Assistance

Complete the roadside assistance identification card and place it in your wallet for quick reference. This card is in the owner's information portfolio in the glove compartment.

United States Ford vehicle customers who require Roadside Assistance, call 1-800-241-3673.

If you need to arrange roadside assistance for yourself, Ford Motor Company reimburses a reasonable amount for towing to the nearest dealership within 35 mi (56 km). To obtain reimbursement information, United States Ford vehicle customers call 1-800-241-3673. Customers need to submit their original receipts.

Vehicles Sold in Canada: Getting Roadside Assistance

Canadian customers who require roadside assistance, call 1-800-665-2006.

Vehicles Sold in Canada: Using Roadside Assistance

For your convenience, you may complete the roadside assistance identification card found in the centerfold of your warranty guide and retain for future reference.

Roadside Emergencies

Canadian roadside coverage and benefits may differ from the U.S. coverage. If you require more information, please refer to the coverage section of your warranty guide, call us in Canada at 1-800-665-2006, or visit our website at www.ford.ca.

Sykes Assistance Services Corporation administers the Roadside Assistance program. You must receive covered services in Canada or the continental United States. Coverage extends to vehicles that use public, non-seasonal, annually traveled roadways. Roadside Assistance coverage does not extend to vehicles involved in cross-country driving, logging, autocross and any other form of off-road use. Well maintained roads and surfaces help ensure safe travel for the supplier, and allow their representatives to perform service as per the standard operating procedures.

In Remote Locations

If our supplier cannot take your vehicle by road to the nearest authorized dealership, transportation by rail or water may be necessary. The program covers a tow to the dock or rail terminal and also to the dealership at the end of the trip.

For rail or water transportation, however, contact your authorized dealer to confirm if you are eligible for additional coverage before you authorize or pay for the service.

Call the Ford Roadside Assistance at 1-800-665-2006 for additional information.

HAZARD WARNING FLASHERS

Note: *If used when the vehicle is not running, the battery will lose charge. There may be insufficient power to restart your vehicle.*



The hazard warning button is located on the instrument panel. Use it when your vehicle is creating a safety hazard for other motorists.

- Press the button to turn on the hazard warning function, and the front and rear direction indicators will flash.
- Press the button again to turn them off.

JUMP STARTING THE VEHICLE

WARNINGS



Connect batteries with only the same nominal voltage. Failure to follow this warning could result in serious personal injury.



Always use booster cables with insulated clamps and adequate size cable. Failure to follow this warning could result in serious personal injury.

Note: *This procedure is only for the 12 volt under hood battery.*

Note: *Your vehicle has a 12 volt battery that is easily accessible under the hood. The 12 volt battery controls the switches and contacts that engage the high voltage battery. Do not jump start the high voltage battery using a standard 12 volt battery. You must tow your vehicle to an authorized dealer if the high voltage battery does not accept a regular charge.*

Note: *Do not attempt to push start your vehicle. You may cause transmission damage.*

Note: *Do not disconnect the 12 volt battery from your vehicle electrical system.*

Roadside Emergencies

To Connect the Booster Cables

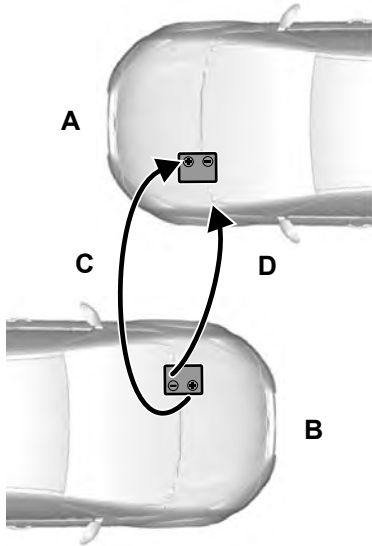

E102925

- A Vehicle with low charge battery
- B Booster battery vehicle
- C Positive connection cable
- D Negative connection cable

WARNINGS



Do not connect directly to the negative (-) terminal of the battery with low charge. A spark may cause an explosion of the gases that surround the battery or a surge within the battery.



Make sure that the cables are clear of any moving parts. Failure to follow this warning could result in serious personal injury or death.

1. Position the vehicles so that they do not touch one another.

2. Switch off the electric motor and any electrical equipment.
3. Connect the positive (+) terminal of vehicle B with the positive (+) terminal of vehicle A (cable C). Battery positions may vary.

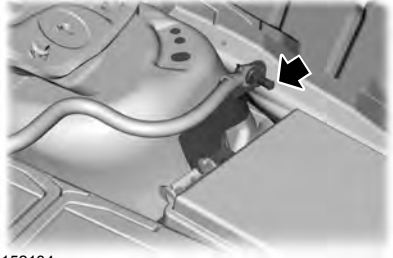

E152134

4. Connect the negative (-) terminal of vehicle B to the ground connection of vehicle A (cable D).

To Start Your Vehicle

1. Run the engine of vehicle B at a moderately high speed.
2. Move the transmission selector lever of vehicle A to position **P**.
3. Switch on the ready to drive mode. See **Starting the Electric Motor** (page 112).
4. Run both vehicles for a minimum of three minutes before disconnecting the cables.

Note: Do not switch the headlamps on when disconnecting the cables. The peak voltage could blow the bulbs.

Disconnect the cables in the reverse order.

Roadside Emergencies

COLLISION, DAMAGE OR FIRE EVENT

Guidance for Ford Motor Company Electric and Hybrid-Electric Vehicles Equipped With High Voltage Batteries

(Vehicle Owner/Operator/General Public) Electric and Hybrid-Electric Vehicle Considerations

In the event of damage or fire involving an electric vehicle (EV) or hybrid-electric vehicle (HEV):

- Always assume the high-voltage battery and associated components are energized and fully charged.
- Exposed electrical components, wires and high-voltage batteries present potential high-voltage shock hazards.
- Venting/off-gassing high-voltage battery vapors are potentially toxic and flammable.
- Physical damage to the vehicle or high-voltage battery may result in immediate or delayed release of toxic, flammable gases and fire.

Vehicle Information and General Safety Practices

- Know the make and model of your vehicle.
- Review the owner's manual and become familiar with your vehicle's safety information and recommended safety practices.
- Do not attempt to repair damaged electric and hybrid-electric vehicles yourself. Contact an authorized Ford Dealer or vehicle manufacturer representative for service.

Crashes

A crash or impact significant enough to require an emergency response for conventional vehicles would also require the same response for an electric or hybrid-electric vehicle.

If possible

- Move your car to a safe, nearby location and remain on the scene.
- Roll down the windows before shutting your vehicle off.
- Place your vehicle in Park, set the parking brake, turn off the vehicle, activate the hazard lights, and move your key(s) at least 16 feet (5 meters) away from the vehicle.

Always

- Call 911 if assistance is needed and advise that an electric or hybrid-electric vehicle is involved.
- Do not touch exposed electrical components or the engine compartment, as a shock hazard may exist.
- Avoid contact with leaking fluids and gases, and remain out of the way of oncoming traffic until emergency responders arrive.
- When emergency responders arrive, tell them that the vehicle involved is an electric vehicle or hybrid vehicle.

Fires

As with any vehicle, call 911 immediately if you see sparks, smoke or flames coming from the vehicle.

- Exit the vehicle immediately.
- Advise 911 that an electric or hybrid-electric vehicle is involved.

Roadside Emergencies

- As with any vehicle fire, do not inhale smoke, vapors or gas from the vehicle, as they may be hazardous.
- Remain a safe distance from the vehicle and try to stay clear of the smoke.
- Stay out of the roadway and stay out of the way of any oncoming traffic while awaiting the arrival of emergency responders.

Post-Incident

- Do not store a severely damaged vehicle with a lithium-ion battery inside a structure or within 50 feet (15 meters) of any structure or vehicle.
- Make sure that passenger and cargo compartments remain ventilated (i.e. open window, door or trunk).
- For vehicles in the United States, notify Ford Motor Company 1-800-392-3673 (then follow the prompts on the voice response menu), an authorized Ford dealer or service center as soon as possible as there may be other steps to secure and discharge the high-voltage battery.
- For vehicles in Canada, notify Ford Motor Company 1-800-565-3673 (then follow the prompts on the voice response menu), an authorized Ford dealer or service center as soon as possible as there may be other steps to secure and discharge the high-voltage battery.
- Call 911 if you observe leaking fluids, sparks, smoke or flames, or hear gurgling or bubbling from the high-voltage battery.

POST-CRASH ALERT SYSTEM

The system flashes the direction indicators and sounds the horn (intermittently) in the event of a serious impact that deploys an airbag (front, side, side curtain or Safety Canopy) or the safety belt pretensioners.

The horn and indicators will turn off when:

- You press the hazard control button.
- You press the panic button on the remote entry transmitter (if equipped).
- Your vehicle runs out of power.

Customer Assistance

GETTING THE SERVICES YOU NEED

Warranty repairs to your vehicle must be performed by an authorized dealer. While any authorized dealer handling your vehicle line will provide warranty service, we recommend you return to your selling authorized dealer who wants to ensure your continued satisfaction.

Please note that certain warranty repairs require special training and equipment, so not all authorized dealers are authorized to perform all warranty repairs. This means that, depending on the warranty repair needed, you may have to take your vehicle to another authorized dealer.

A reasonable time must be allowed to perform a repair after taking your vehicle to the authorized dealer. Repairs will be made using Ford or Motorcraft® parts, or remanufactured or other parts that are authorized by Ford.

Away From Home

If you are away from home when your vehicle needs service, contact the Ford Customer Relationship Center or use the online resources listed below to find the nearest authorized dealer.

In the United States:

Mailing address

Ford Motor Company
Customer Relationship Center
P.O. Box 6248
Dearborn, MI 48121

Telephone

1-800-392-3673 (FORD)
(TDD for the hearing impaired:
1-800-232-5952)

Online

Additional information and resources are available online at www.fordowner.com

These are some of the items that can be found online:

- U.S. dealer locator by Dealer Name, City/State or Zip Code.
- Owner Manuals.
- Maintenance Schedules.
- Recalls.
- Ford Extended Service Plans.
- Ford Genuine Accessories.
- Service specials and promotions.

In Canada:

Mailing address

Customer Relationship Centre
Ford Motor Company of Canada, Limited
P.O. Box 2000
Oakville, Ontario L6K 0C8

Telephone

1-800-565-3673 (FORD)

Online

www.ford.ca

Twitter

@FordServiceCA (English Canada)
@FordServiceQC (Quebec)

Additional Assistance

If you have questions or concerns, or are unsatisfied with the service you are receiving, follow these steps:

1. Contact your Sales Representative or Service Advisor at your selling/servicing authorized dealer.
2. If your inquiry or concern remains unresolved, contact the Sales Manager, Service Manager or Customer Relations Manager.
3. If you require assistance or clarification on Ford Motor Company policies, please contact the Ford Customer Relationship Center.

Customer Assistance

In order to help us serve you better, please have the following information available when contacting a Customer Relationship Center:

- Vehicle Identification Number.
- Your telephone number (home and business).
- The name of the authorized dealer and city where located.
- The vehicle's current odometer reading.

In some states, you must directly notify Ford in writing before pursuing remedies under your state's warranty laws. Ford is also allowed a final repair attempt in some states.

In the United States, a warranty dispute must be submitted to the BBB AUTO LINE before taking action under the Magnuson-Moss Warranty Act, or to the extent allowed by state law, before pursuing replacement or repurchase remedies provided by certain state laws. This dispute handling procedure is not required prior to enforcing state created rights or other rights which are independent of the Magnuson-Moss Warranty Act or state replacement or repurchase laws.

IN CALIFORNIA (U.S. ONLY)

California Civil Code Section 1793.2(d) requires that, if a manufacturer or its representative is unable to repair a motor vehicle to conform to the vehicle's applicable express warranty after a reasonable number of attempts, the manufacturer shall be required to either replace the vehicle with one substantially identical or repurchase the vehicle and reimburse the buyer in an amount equal to the actual price paid or payable by the consumer (less a reasonable allowance for consumer use). The consumer has the right to choose whether to receive a refund or replacement vehicle.

California Civil Code Section 1793.22(b) presumes that the manufacturer has had a reasonable number of attempts to conform the vehicle to its applicable express warranties if, within the first 18 months of ownership of a new vehicle or the first 18000 miles (29 000 km), whichever occurs first:

1. Two or more repair attempts are made on the same non-conformity likely to cause death or serious bodily injury OR
2. Four or more repair attempts are made on the same nonconformity (a defect or condition that substantially impairs the use, value or safety of the vehicle) OR
3. The vehicle is out of service for repair of nonconformities for a total of more than 30 calendar days (not necessarily all at one time).

In the case of 1 or 2 above, the consumer must also notify the manufacturer of the need for the repair of the nonconformity at the following address:

Ford Motor Company
16800 Executive Plaza Drive
Mail Drop 3NE-B
Dearborn, MI 48126

You are required to submit your warranty dispute to BBB AUTO LINE before asserting in court any rights or remedies conferred by California Civil Code Section 1793.22(b). You are also required to use BBB AUTO LINE before exercising rights or seeking remedies created by the Federal Magnuson-Moss Warranty Act, 15 U.S.C. sec. 2301 et seq. If you choose to seek redress by pursuing rights and remedies not created by California Civil Code Section 1793.22(b) or the Magnuson-Moss Warranty Act, resort to BBB AUTO LINE is not required by those statutes.

Customer Assistance

THE BETTER BUSINESS BUREAU (BBB) AUTO LINE PROGRAM (U.S. ONLY)

Your satisfaction is important to Ford Motor Company and to your dealer. If a warranty concern has not been resolved using the three-step procedure outlined earlier in this chapter in the Getting the Services you need section, you may be eligible to participate in the BBB AUTO LINE program.

The BBB AUTO LINE program consists of two parts – mediation and arbitration. During mediation, a representative of the BBB will contact both you and Ford Motor Company to explore options for settlement of the claim. If an agreement is not reached during mediation or you do not want to participate in mediation, and if your claim is eligible, you may participate in the arbitration process. An arbitration hearing will be scheduled so that you can present your case in an informal setting before an impartial person. The arbitrator will consider the testimony provided and make a decision after the hearing.

Disputes submitted to the BBB AUTO LINE program are usually decided within forty days after you file your claim with the BBB. You are not bound by the decision, and may reject the decision and proceed to court where all findings of the BBB Auto Line dispute, and decision, are admissible in the court action. Should you choose to accept the BBB AUTO LINE decision, Ford is then bound by the decision, and must comply with the decision within 30 days of receipt of your acceptance letter.

BBB AUTO LINE Application: Using the information provided below, please call or write to request a program application. You will be asked for your name and address, general information about your new vehicle, information about your warranty concerns, and any steps you have

already taken to try to resolve them. A Customer Claim Form will be mailed that will need to be completed, signed and returned to the BBB along with proof of ownership. Upon receipt, the BBB will review the claim for eligibility under the Program Summary Guidelines.

You can get more information by calling BBB AUTO LINE at 1-800-955-5100, or writing to:

**BBB AUTO LINE
3033 Wilson Boulevard, Suite 600
Arlington, Virginia 22201**

BBB AUTO LINE applications can also be requested by calling the Ford Motor Company Customer Relationship Center at 1-800-392-3673.

Note: *Ford Motor Company reserves the right to change eligibility limitations, modify procedures, or to discontinue this process at any time without notice and without obligation.*

UTILIZING THE MEDIATION/ARBITRATION PROGRAM (CANADA ONLY)

For vehicles delivered to authorized Canadian dealers. In those cases where you continue to feel that the efforts by Ford of Canada and the authorized dealer to resolve a factory-related vehicle service concern have been unsatisfactory, Ford of Canada participates in an impartial third party mediation/arbitration program administered by the Canadian Motor Vehicle Arbitration Plan (CAMVAP).

The CAMVAP program is a straight forward and relatively speedy alternative to resolve a disagreement when all other efforts to produce a settlement have failed. This procedure is without cost to you and is designed to eliminate the need for lengthy and expensive legal proceedings.

Customer Assistance

In the CAMVAP program, impartial third-party arbitrators conduct hearings at mutually convenient times and places in an informal environment. These impartial arbitrators review the positions of the parties, make decisions and, when appropriate, render awards to resolve disputes. CAMVAP decisions are fast, fair, and final as the arbitrator's award is binding on both you and Ford of Canada.

CAMVAP services are available in all Canadian territories and provinces. For more information, without charge or obligation, call your CAMVAP Provincial Administrator directly at 1-800-207-0685 or visit www.camvap.ca.

GETTING ASSISTANCE OUTSIDE THE U.S. AND CANADA

Before exporting your vehicle to a foreign country, contact the appropriate foreign embassy or consulate. These officials can inform you of local vehicle registration regulations and where to find unleaded fuel.

If you cannot find unleaded fuel or can only get fuel with an anti-knock index lower than is recommended for your vehicle, contact our Customer Relationship Center.

The use of leaded fuel in your vehicle without proper conversion may damage the effectiveness of your emission control system and may cause engine knocking or serious engine damage. Ford Motor Company or Ford of Canada is not responsible for any damage caused by use of improper fuel. Using leaded fuel may also result in difficulty importing your vehicle back into the United States.

If your vehicle must be serviced while you are traveling or living in Asia-Pacific Region, Sub-Saharan Africa, U.S. Virgin Islands, Central America, the Caribbean, and Israel, contact the nearest authorized dealer. If the authorized dealer cannot help you, contact:

FORD MOTOR COMPANY
Customer Relationship Center
1555 Fairlane Drive
Fairlane Business Park #3
Allen Park, Michigan 48101
U.S.A.
Telephone: (313) 594-4857
Fax: (313) 390-0804
Email: expcac@ford.com

For customers in Guam, the Commonwealth of the Northern Mariana Islands (CNMI), America Samoa, and the U.S. Virgin Islands, please feel free to call our Toll-Free Number: (800) 841-FORD (3673).

If your vehicle must be serviced while you are traveling or living in Puerto Rico, contact the nearest authorized dealer. If the authorized dealer cannot help you, contact:

FORD MOTOR COMPANY
Customer Relationship Center
1555 Fairlane Drive
Fairlane Business Park #3
Allen Park, Michigan 48101
U.S.A.
Telephone: (800) 841-FORD (3673)
FAX: (313) 390-0804
Email: prcac@ford.com
www.ford.com.pr

If your vehicle must be serviced while you are traveling or living in the Middle East, contact the nearest authorized dealer. If the authorized dealer cannot help you, contact:

Customer Assistance

FORD MOTOR COMPANY
Customer Relationship Center
1555 Fairlane Drive
Fairlane Business Park #3
Allen Park, Michigan 48101
U.S.A.
Telephone: +971 4 3326084
Toll-Free Number of the Kingdom of Saudi
Arabia: 800 8971409
Local Telephone Number of Kuwait:
24810575
FAX: +971 4 3327299
Email: menacac@ford.com
www.me.ford.com

If you buy your vehicle in North America and then relocate to any of the above locations, register your vehicle identification number (VIN) and new address with Ford Motor Company Export Operations & Global Growth Initiatives by emailing expcac@ford.com.

If you are in another foreign country, contact the nearest authorized dealer. In the event your inquiry is unresolved, communicate your concern with the dealership's Sales Manager, Service Manager or Customer Relations Manager. If you require additional assistance or clarification, please contact the respective Customer Relationship Center as previously listed.

**Customers in the U.S. should call
1-800-392-3673.**

ORDERING ADDITIONAL OWNER'S LITERATURE

To order the publications in this portfolio, contact Helm, Incorporated at:

HELM, INCORPORATED
47911 Halyard Drive
Plymouth, Michigan 48170
Attention: Customer Service

Or to order a free publication catalog, call toll free: 1-800-782-4356

Monday-Friday 8:00 a.m. - 6:00 p.m. EST
Helm, Incorporated can also be reached by their website:

www.helminc.com

(Items in this catalog may be purchased by credit card, check or money order.)

Obtaining a French Owner's Manual

French Owner's Manual can be obtained from your authorized dealer or by contacting Helm, Incorporated using the contact information listed previously in this section.

REPORTING SAFETY DEFECTS (U.S. ONLY)



E142557

If you believe that your vehicle has a defect which could cause a crash or could cause injury or death, you should immediately inform the National Highway Traffic Safety Administration (NHTSA) in addition to notifying Ford Motor Company.

If NHTSA receives similar complaints, it may open an investigation, and if it finds that a safety defect exists in a group of vehicles, it may order a recall and remedy campaign. However, NHTSA cannot become involved in individual problems between you, your dealer, or Ford Motor Company.

Customer Assistance

To contact NHTSA, you may call the Vehicle Safety Hotline toll-free at 1-888-327-4236 (TTY: 1-800-424-9153); go to <http://www.safercar.gov>; or write to:

Administrator
1200 New Jersey Avenue,
Southeast
Washington, D.C. 20590

You can also obtain other information about motor vehicle safety from <http://www.safercar.gov>.

REPORTING SAFETY DEFECTS (CANADA ONLY)

If you believe that your vehicle has a defect which could cause a crash or could cause injury or death, you should immediately inform Transport Canada.

Transport Canada Contact Information	
Website	http://www.tc.gc.ca/eng/roadsafety/menu.htm
Phone	1-800-333-0510

Fuses

FUSE SPECIFICATION CHART

Pre-Fuse Box

Your vehicle has a pre-fuse box located in the electric motor compartment on the

front of the 12 volt battery box. It is connected to the 12 volt battery positive terminal. This fuse box contains several high current fuses. If replacement of these high current fuses is required, contact an authorized dealer.

Fuse	Fuse rating	Circuits protected
F1	80A	Electronic power assist steering.
F2	150A	12 volt battery charge.
F3	100A	Power distribution box.
F4	50A	Body control module (KL30A supply).
F5	70A	High voltage battery coolant element one and two.
F6	70A	Load compartment fuse box.
F7	-	Not used.
F8	50A	Electric fan control module.
F9	50A	Body control module (KL30B supply).
F10	40A	High voltage battery coolant element three.

Electric Motor Compartment Fuse Box

WARNING



To reduce risk of electrical shock, always replace the cover to the power distribution box before reconnecting the battery or refilling fluid reservoirs. Always disconnect the 12 volt battery before servicing high current fuses.

This fuse box contains several high current fuses that protect your vehicle's main electrical systems from overloads.

If the 12 volt battery is disconnected and reconnected, some features need to be reset.

Fuses

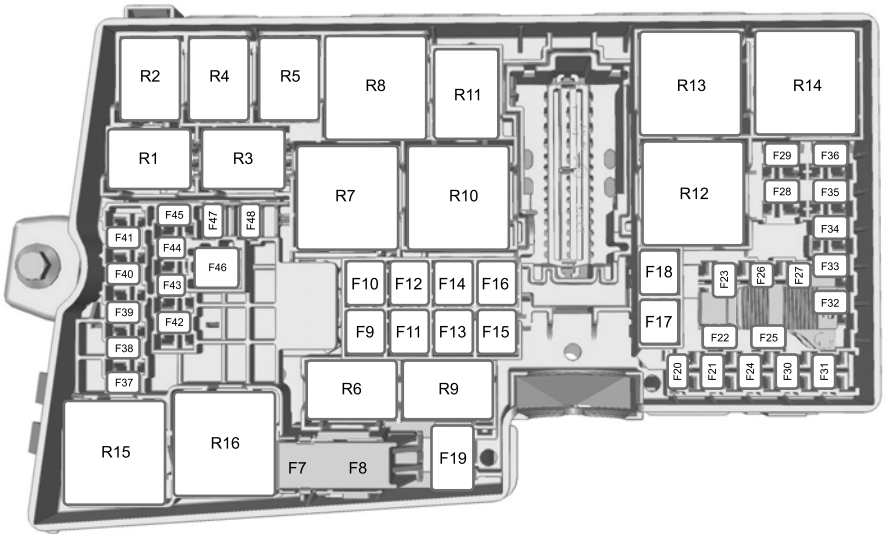

E129925

Lift the release lever at the rear of the cover to remove it.

Fuse	Fuse rating	Circuits protected
F7	40A**	Anti-lock brake system. Stability control (KL30V).
F8	30A**	Anti-lock brake system. Stability control (KL30P).
F9	-	Not used.
F10	40A**	Blower motor module.
F11	40A**	Brake vacuum pump.
F12	40A**	Electric motor control relay.
F13	40A**	Battery charging control module.
F14	40A**	Coolant heater one.

Fuses

Fuse	Fuse rating	Circuits protected
F15	30A**	Body control module (KL30C supply).
F16	40A**	Coolant heater two.
F17	-	Not used.
F18	20A**	Windshield wiper.
F19	5A*	Anti-lock brake system. Stability control (KL15).
F20	15A*	Horn.
F21	5A*	Stop lamp switch.
F22	15A*	Battery monitoring system.
F23	5A*	Relay coils.
F24	5A*	Lighting control switch module.
F25	-	Not used.
F26	10A*	Powertrain control module.
F27	15A*	Charge port light ring.
F28	5A*	Vacuum pump monitor.
F29	-	Not used.
F30	5A*	Transmission control module (12V supply).
F31	10A*	Smart data link/on-board diagnostic connector.
F32	10A*	Coolant valve. Air conditioning solenoid. Chiller solenoid.
F33	10A*	Powertrain control module/A/C compressor PSR feedback.
F34	15A*	High voltage battery.
F35	-	Not used.

Fuses

Fuse	Fuse rating	Circuits protected
F36	20A*	Coolant pump.
F37	5A*	Vehicle audible signal for pedestrians.
F38	15A*	Powertrain control module (KL15 supply).
F39	-	Not used.
F40	5A*	Electronic power assist steering.
F41	20A*	Body control module (KL15 supply).
F42	-	Not used.
F43	15A*	Daytime running light.
F44	-	Not used.
F45	-	Not used.
F46	-	Not used.
F47	-	Not used.
F48	5A*	Mechanical relay coil fuse.

*Mini fuses

**Cartridge fuses

Relay	Relay Type	Circuit switched
R1	-	Not used.
R2	Micro relay	Horn.
R3	-	Not used.
R4	Micro relay	High voltage battery.
R5	-	Not used.
R6	-	Not used.
R7	Power relay	Coolant heater element three.
R8	Power relay	Coolant heater element one and two.

Fuses

Relay	Relay Type	Circuit switched
R9	-	Not used.
R10	Mini relay	Brake vacuum pump.
R11	-	Not used.
R12	Power relay	Electronic fan control module.
R13	Mini relay	Blower motor.
R14	Mini relay	Electric motor control.
R15	Power relay	Brake vacuum pump mechanical relay.
R16	Power relay	Ignition.

Fuses

Passenger Compartment Fuse Box

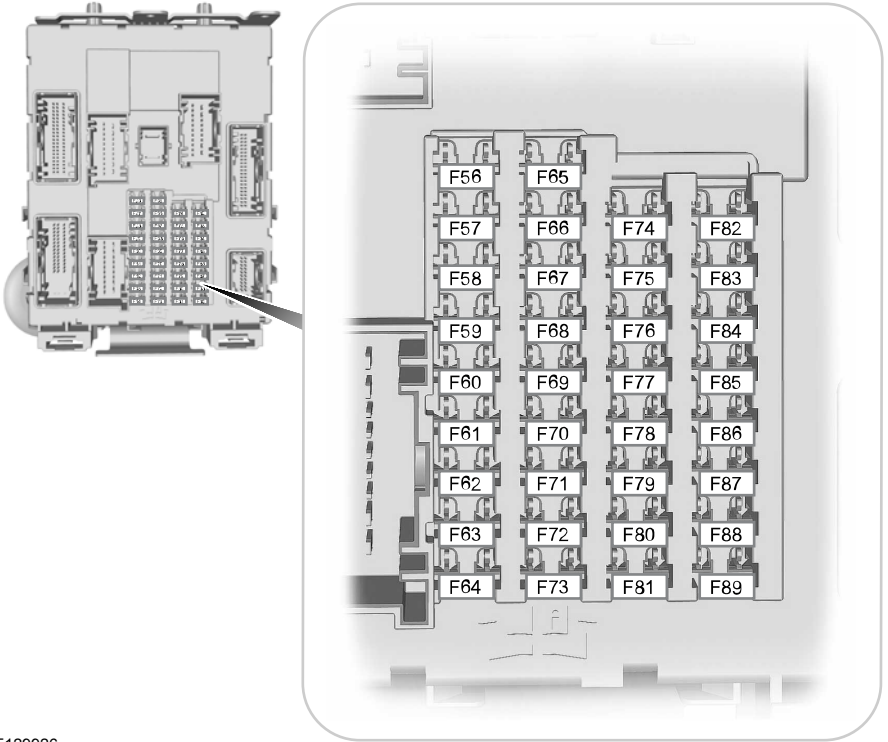

E129926

Fuse	Fuse rating	Circuits protected
F56	-	Not used.
F57	-	Not used.
F58	-	Not used.
F59	-	Not used.
F60	10A	Interior lamp. Driver door switch pack. Glove compartment lamp.

Fuses

Fuse	Fuse rating	Circuits protected
		Ambient lighting lamp.
F61	20A	Front cigar lighter socket. Rear auxiliary power points.
F62	-	Not used.
F63	-	Not used.
F64	-	Not used.
F65	10A	Luggage compartment lid release.
F66	-	Not used.
F67	7.5A	Global positioning sensor. SYNC.
F68	-	Not used.
F69	5A	Instrument panel cluster.
F70	-	Not used.
F71	7.5A	Air conditioning.
F72	7.5A	Steering wheel control module.
F73	7.5A	Smart data link module.
F74	15A	High beam headlamp.
F75	-	Not used.
F76	10A	Reversing lamp.
F77	20A	Washer pump.
F78	5A	Ignition switch. Push button ignition switch.
F79	15A	Audio unit. Hazard flasher switch. Door lock buttons.
F80	-	Not used.
F81	5A	Radio frequency receiver.
F82	20A	Washer pump (ground).
F83	20A	Central locking (ground).

Fuses

Fuse	Fuse rating	Circuits protected
F84	20A	Driver door unlock (ground). Double locking ground (ground).
F85	7.5A	Heated seats switch.
F86	10A	Restraint system. Passenger airbag deactivation system.
F87	-	Not used.
F88	-	Not used.
F89	-	Not used.

Luggage Compartment Fuse Box

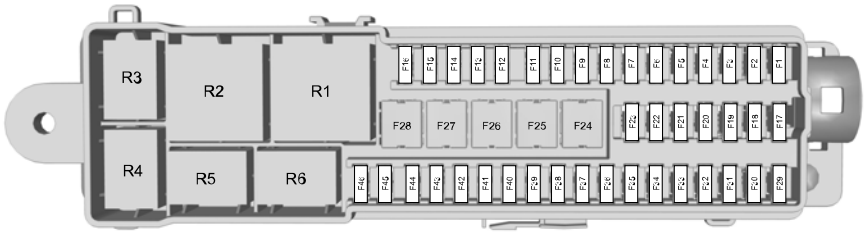

E129927

Fuse	Fuse rating	Circuits protected
F1	5A*	Cellphone passport module.
F2	-	Not used.
F3	5A*	Keyless vehicle door handles.
F4	25A*	Front power window (left). Central locking (front left). Power folding mirror (left). Heated exterior mirror (left).
F5	25A*	Front power window (right). Central locking (front right).

Fuses

Fuse	Fuse rating	Circuits protected
		Power folding mirror (right). Heated exterior mirror (right).
F6	25A*	Rear left door module (KL30 supply).
F7	25A*	Rear right door module (KL30 supply).
F8	5A*	Ignition relay.
F9	25A*	Driver power seat.
F10	25A*	Heated rear window.
F11	5A*	High voltage battery (12V B+).
F12	-	Not used.
F13	-	Not used.
F14	-	Not used.
F15	-	Not used.
F16	-	Not used.
F17	-	Not used.
F18	-	Not used.
F19	-	Not used.
F20	-	Not used.
F21	-	Not used.
F22	-	Not used.
F23	-	Not used.
F24	-	Not used.
F25	-	Not used.
F26	-	Not used.
F27	-	Not used.
F28	-	Not used.
F29	5A*	High voltage battery (12V B+).

Fuses

Fuse	Fuse rating	Circuits protected
F30	5A*	Parking aid module.
F31	-	Not used.
F32	-	Not used.
F33	15A	Rear wiper motor.
F34	15A*	Heated seat (driver).
F35	15A*	Heated seat (front passenger).
F36	-	Not used.
F37	-	Not used.
F38	-	Not used.
F39	-	Not used.
F40	-	Not used.
F41	-	Not used.
F42	-	Not used.
F43	-	Not used.
F44	-	Not used.
F45	-	Not used.
F46	-	Not used.

*Mini fuses

**Cartridge fuses

Relay	Relay Type	Circuit switched
R1	Power relay	Rear KL15E.
R2	Mini relay	Heated rear window.
R3	Micro relay	Rear window wiper.

Fuses

Relay	Relay Type	Circuit switched
R4	-	Not used.
R5	-	Not used.
R6	-	Not used.

CHANGING A FUSE

Fuses

WARNING



Always replace a fuse with one that has the specified amperage rating. Using a fuse with a higher amperage rating can cause severe wire damage and could start a fire.

E142430

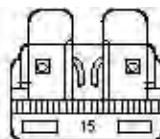

If electrical components in the vehicle are not working, a fuse may have blown. Blown fuses are identified by a broken wire within the fuse. Check the appropriate fuses before replacing any electrical components.

Standard Fuse Amperage Rating and Color

Fuse rating	Color			
	Micro fuses	Dual micro fuses	M-type fuses	J-type fuses
5A	Tan	Tan	-	-
7.5A	Brown	Brown	-	-
10A	Red	Red	-	-
15A	Blue	Blue	Grey	-
20A	Yellow	-	Light Blue	Blue
25A	White	-	White	White
30A	Green	-	Pink	Pink
40A	-	-	Green	Green
50A	-	-	-	Red
60A	-	-	-	Yellow

Maintenance

GENERAL INFORMATION

Have your vehicle serviced regularly to help maintain its roadworthiness and resale value. There is a large network of Ford authorized repairers that are there to help you with their professional servicing expertise. Authorized repairers are best qualified to service your vehicle properly and expertly, with a wide range of highly specialized tools.

In addition to regular servicing, we recommend that you carry out the following checks.

WARNINGS



Switch the ignition off before touching or attempting adjustment of any kind.



Do not touch the electronic ignition system parts after you have switched the ignition on or when the electric motor is running. The system operates at high voltage.



Keep your hands and clothing clear of the electric motor cooling fan. Under certain conditions, the fan may continue to run for several minutes after you have switched the electric motor off.



Make sure that you fit filler caps securely after carrying out maintenance checks.

High Voltage Information

WARNING



Exposure to high voltage could result in severe personal injury or death. High voltage components must be serviced by a trained service technician.

Your vehicle consists of various high voltage components and wiring. All of the high voltage power flows through specific wiring assemblies which are labeled as such or are covered with a solid orange convolute or orange stripe tape. Do not come in contact with these components.

Daily Checks

- Exterior lamps.
- Interior lamps.
- Warning lamps and indicators.

Weekly Checks

- Brake fluid level.
- Washer fluid level.
- Tire pressures (when cold).
- Tire condition.

Monthly Checks

- Coolant level. See **Coolant Check** (page 171).
- Pipes, hoses and reservoirs for leaks.
- Air conditioning operation.
- Parking brake operation.
- Horn operation.
- Tightness of lug nuts. See **Lug Nuts** (page 221).

OPENING AND CLOSING THE HOOD

1. Inside the vehicle, pull the hood release handle located under the left-hand side of the instrument panel.

Maintenance



E142457

2. Go to the front of your vehicle and locate the secondary release lever under the front of the hood, left of center, and push it to your right-hand side to release.

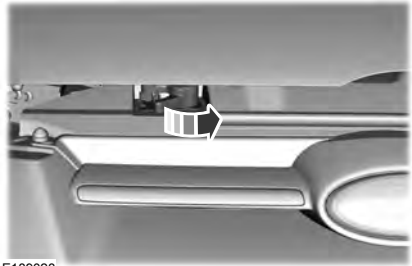

E189028

3. Lift the hood and support it with the prop rod.
4. To close the hood, remove the support rod from the catch and secure correctly.
5. Lower the hood and allow it to drop under its own weight for the last 8 in to 12 in (20 cm to 30 cm).

Note: Make sure the hood is fully closed.

UNDER HOOD OVERVIEW

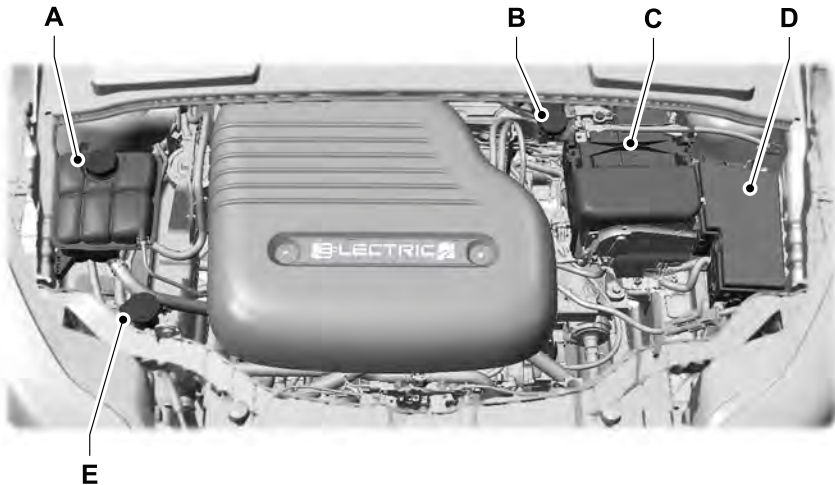

E198695

Maintenance

- A Coolant reservoir. See **Coolant Check** (page 171).
- B Brake fluid reservoir. See **Brake Fluid Check** (page 173).
- C 12 volt battery. See **Changing the 12V Battery** (page 173).
- D Electric motor compartment fuse box. See **Fuses** (page 158).
- E Windshield washer fluid reservoir. See **Washer Fluid Check** (page 173).

COOLANT CHECK

WARNINGS



Do not add coolant when the electric motor is hot. Steam and scalding liquids released from a hot cooling system can cause severe burns. You could receive burns if you spill coolant on hot motor parts. Failure to follow this warning could result in serious personal injury.



Do not put coolant in the windshield washer fluid container. If sprayed on the windshield, coolant could make it difficult to see through the windshield. Failure to follow this warning could result in serious personal injury or death.



To reduce the risk of personal injury, make sure the electric motor is cool before unscrewing the coolant pressure relief cap. The cooling system is under pressure; steam and hot liquid can come out forcefully when the cap is loosened slightly. Failure to follow this warning could result in serious personal injury.



Do not add coolant further than the MAX mark.

When the electric motor is cold, check the level and concentration of the coolant in the reservoir at the intervals listed in the scheduled maintenance information.

Note: Make sure that the coolant level is between the MIN and MAX marks on the coolant reservoir.

Note: Coolant expands when it is hot. The level may extend beyond the MAX mark.

Note: If the level is at the MIN mark, below the MIN mark or empty, add coolant immediately.

Maintain coolant concentration within 48% to 50%, which equates to a freeze point between -30°F (-34°C) and -34°F (-37°C).

Note: For best results, coolant concentration should be tested with a refractometer such as Robinair Coolant and Battery Refractometer 75240. We do not recommend the use of hydrometers or coolant test strips for measuring coolant concentrations.

Note: It is very important to use prediluted coolant meeting the Ford specification in order to avoid plugging the small coolant passageways. Use of concentrated coolant and water may cause coolant passageway plugging and void the warranty. See **Capacities and Specifications** (page 225).

Note: Automotive fluids are not interchangeable; do not use coolant, antifreeze or windshield washer fluid outside of its specified function and vehicle location.

Adding Coolant

Note: Do not use stop leak pellets or cooling system sealants or additives as they can cause damage to the cooling and heating systems. This damage would not be covered under your vehicle warranty.

Maintenance

Note: *During normal vehicle operation, the coolant may change color from orange to pink or light red.*

As long as the coolant is clear and uncontaminated, this color change does not indicate that the coolant has degraded, nor does it require that qualified personnel drain the coolant, flush the system or replace the coolant.

Do not mix different colors or types of coolant in your vehicle. Make sure the correct coolant is used. Mixing of coolants may harm your cooling system. The use of an improper coolant may harm the electric motor or cooling system components and may invalidate the vehicle warranty.

In case of emergency, you can add a large amount of water without coolant in order to reach a vehicle service location. In this instance, qualified personnel:

1. Must drain the cooling system.
2. Chemically clean the coolant system with Motorcraft Premium Cooling System Flush.
3. Refill with coolant as soon as possible.

Water alone, without coolant, can cause vehicle damage from corrosion, overheating, freezing or plugging.

Do not use the following as a coolant substitute:

- Alcohol.
- Methanol.
- Brine.
- Any coolant mixed with alcohol or methanol antifreeze or coolant.

Alcohol and other liquids can cause vehicle damage from overheating or freezing.

Do not add extra inhibitors or additives to the coolant. These can be harmful and compromise the corrosion protection of the coolant.

Whenever coolant has been added, the coolant level in the coolant reservoir should be checked the next few times you drive the vehicle. If necessary, add enough prediluted coolant to bring the coolant level to the correct level.

When adding coolant:

1. Unscrew the cap slowly. Any pressure will escape as you unscrew the cap.
2. Add prediluted coolant meeting the Ford specification. See **Capacities and Specifications** (page 222).
3. Check the coolant level in the coolant reservoir the next few times you drive your vehicle.
4. If necessary, add enough prediluted coolant to bring the coolant level to the proper level.

Recycled Coolant

Ford Motor Company does not recommend the use of recycled coolant since a Ford-approved recycling process is not yet available.

Used coolant should be disposed of in an appropriate manner. Follow your community's regulations and standards for recycling and disposing of automotive fluids.

Severe Climates

If you drive in extremely cold climates:

- It may be necessary to have a Ford authorized dealer increase the coolant concentration above 50%.
- A coolant concentration of 60% provides improved freeze point protection. Coolant concentrations above 60% decrease the overheat protection characteristics of the coolant and may cause vehicle damage.

Maintenance

If you drive in extremely hot climates:

- It may be necessary to have a Ford authorized dealer decrease the coolant concentration to 40%.
- A coolant concentration of 40% provides improved overheat protection. Coolant concentrations below 40% will decrease the freeze and corrosion protection characteristics of the coolant and may cause vehicle damage.

Vehicles driven year-round in non-extreme climates should use prediluted coolant for optimum cooling system and vehicle protection.

BRAKE FLUID CHECK

WARNINGS

 Do not use any fluid other than the recommended brake fluid as this will reduce brake efficiency. Use of incorrect fluid could result in the loss of vehicle control, serious personal injury or death.

 Only use brake fluid from a sealed container. Contamination with dirt, water, petroleum products or other materials may result in brake system damage or failure. Failure to adhere to this warning could result in the loss of vehicle control, serious personal injury or death.

 Do not allow the fluid to touch your skin or eyes. If this happens, rinse the affected areas immediately with plenty of water and contact your physician.

 A fluid level between the **MAX** and **MIN** lines is within the normal operating range and there is no need to add fluid. A fluid level not in the normal operating range could compromise the performance of the system. Have your vehicle checked immediately.



E170684

Only use fluid that meets Ford specifications.

WASHER FLUID CHECK

When adding fluid, use a mixture of washer fluid and water to help prevent freezing in cold weather and improve the cleaning capability. For information on fluid dilution, refer to the product instructions.

Note: *The reservoir supplies the front and rear washer systems.*

CHANGING THE 12V BATTERY

WARNINGS

 Batteries normally produce explosive gases which can cause personal injury. Therefore, do not allow flames, sparks or lighted substances to come near the battery. When working near the battery, always shield your face and protect your eyes. Always provide correct ventilation.

 When lifting a plastic-cased battery, excessive pressure on the end walls could cause acid to flow through the vent caps, resulting in personal injury and damage to the vehicle or battery. Lift the battery with a battery carrier or with your hands on opposite corners.

Maintenance

WARNINGS



Keep batteries out of reach of children. Batteries contain sulfuric acid. Avoid contact with skin, eyes or clothing. Shield your eyes when working near the battery to protect against possible splashing of acid solution. In case of acid contact with skin or eyes, flush immediately with water for a minimum of 15 minutes and get prompt medical attention. If acid is swallowed, call a physician immediately.



Battery posts, terminals and related accessories contain lead and lead compounds. Wash hands after handling.

Your vehicle is fitted with a Motorcraft maintenance-free battery, which normally does not require additional water.

Note: After cleaning or replacing the battery, make sure you reinstall the battery cover or shield.

When a battery replacement is required, you should replace the battery with a Ford recommended replacement battery that matches the electrical requirements of the vehicle.

Note: Contact an authorized dealer for low voltage battery access, testing or replacement.

To make sure the battery management system works correctly, do not connect an electrical device ground connection directly to the low voltage battery negative post. This can cause inaccurate measurements of the battery condition and potential incorrect system operation.

Note: If you add electrical accessories or components to the vehicle, it may adversely affect the low voltage battery performance and durability. This may also affect the performance of other electrical systems in the vehicle.

For longer, trouble-free operation, keep the top of the battery clean and dry.

If you see any corrosion on the battery or terminals, remove the cables from the terminals and clean with a wire brush. You can neutralize the acid with a solution of baking soda and water.

A computer electronically controls your vehicle. The power of the low voltage battery maintains the memory of some settings, for example, clock setting or radio presets. When the low voltage battery is disconnected and then connected, these settings erase.

To restore the settings, do the following:

1. Apply the parking brake.
2. Shift into park (P).
3. Switch off all accessories.
4. Press the brake pedal and start your vehicle.
5. Reset the clock.
6. Reset the bounce-back feature. See **Power Windows** (page 77).
7. Reset the radio station presets. See **Audio System** (page 227).

Make sure that you dispose of old batteries in an environmentally friendly way. Seek advice from your local authority about recycling old batteries.

If storing your vehicle for more than 30 days without recharging the battery, we recommend that you disconnect the battery cables to maintain battery charge for quick starting.

Maintenance

CHECKING THE WIPER BLADES



E142463

Run the tip of your fingers over the edge of the blade to check for roughness.

Clean the wiper blades with washer fluid or water applied with a soft sponge or cloth.

CHANGING THE WIPER BLADES

Note: If streaks or smears appear on the windshield, clean the windshield and the wiper blades. See **Cleaning the Windows and Wiper Blades** (page 184). If that does not resolve the issue, install new wiper blades.

Service Position

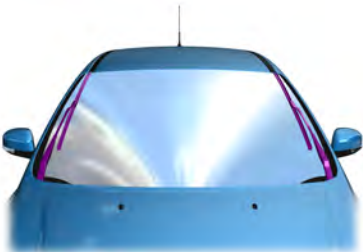

E75184

Set the windshield wipers in the service position to change the wiper blades. The windshield wipers return to the starting position when you switch the ignition on.

Note: You can use the service position in winter to provide easier access to the wiper blades for freeing them from snow and ice. Make sure the windshield is free from snow and ice before you switch the ignition on.

1. Switch the ignition on.



E129986

2. Switch the ignition off and press and hold the wiper lever in position A within three seconds.
3. Release the wiper lever when the windshield wipers reach the service position.

Changing the Windshield Wiper Blades

1. Pull the wiper blade and arm away from the glass.

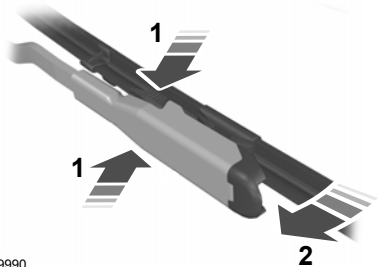

E129990

Note: Make sure that the wiper arm does not spring back against the glass when the wiper blade is not attached.

2. Press the locking buttons together.

Maintenance

3. Rotate and remove the wiper blade.
4. Install in the reverse order.

Note: Make sure that the wiper blade locks into place.

Changing the Rear Window Wiper Blade

1. Lift the wiper arm.

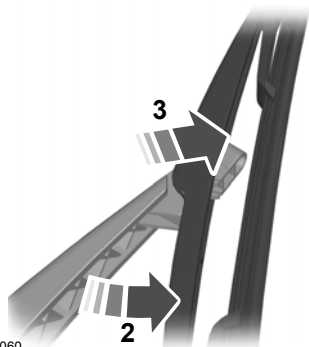

E130060

Note: Make sure that the wiper arm does not spring back against the glass when the wiper blade is not attached.

2. Slightly rotate the wiper blade.
3. Disengage the wiper blade from the wiper arm.
4. Remove the wiper blade.
5. Install in the reverse order.

Note: Make sure that the wiper blade locks into place.

ADJUSTING THE HEADLAMPS

Vertical Aim Adjustment

If your vehicle has been involved in a crash, have the aim of the headlamp beam checked by an authorized dealer.

Headlamp Aiming Target

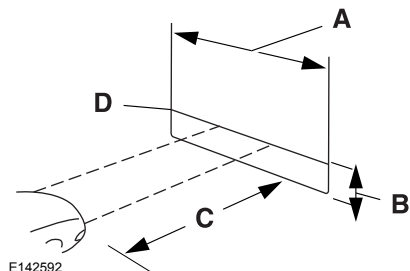

E142592

- A 8 ft (2.4 m)
- B Ground to the center of the headlamp low beam bulb
- C 25 ft (7.6 m)
- D Horizontal reference line

Vertical Aim Adjustment Procedure

1. Park your vehicle on level ground approximately 25 ft (7.6 m) from a wall or screen.
2. Measure the distance from the ground to the center of the headlamp low beam bulb and mark an 8 ft (2.4 m) long horizontal reference line on the wall or screen at this height.

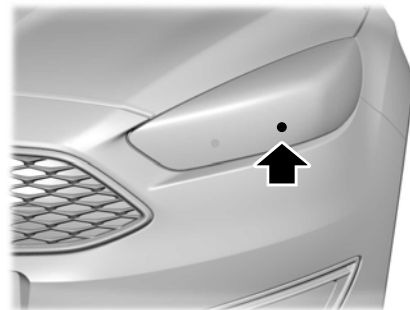

E199411

Maintenance

Note: There may be an identifying mark on the lens to help you locate the center of the bulb.

Note: To see a clearer light pattern while adjusting one headlamp, you may want to block the light from the other headlamp.

3. Switch on the low beam headlamps and open the hood.



E142465

4. On the wall or screen you will observe a flat zone of high intensity light located at the top of the beam pattern. If the top edge of the flat zone of high intensity light is not on the horizontal reference line, adjust the aim of the headlamp beam.

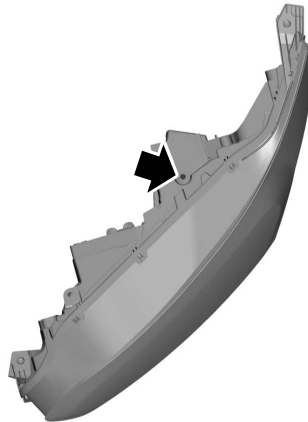

E164485

5. Locate the vertical adjuster on each headlamp. Use a suitable tool, for example a screwdriver or hexagonal socket, to turn the adjuster clockwise or counterclockwise to adjust the vertical aim of the headlamp. The horizontal edge of the brighter light should touch the horizontal reference line.
6. Close the hood and switch off the lamps.

Horizontal Aim Adjustment

The horizontal aim of the headlamp beam on your vehicle is not adjustable.

REMOVING A HEADLAMP

1. Open the hood. See **Opening and Closing the Hood** (page 169).

Maintenance

CHANGING A BULB

WARNING

 Handle a halogen headlamp bulb carefully and keep out of children's reach. Grasp the bulb by only its plastic base and do not touch the glass. The oil from your hand could cause the bulb to break the next time the headlamps are operated.

Note: *If you accidentally touch the bulb, you should clean it with rubbing alcohol.*

Replacing HID Headlamp Bulbs

Your vehicle has high intensity discharge lamps. These lamps operate at a high voltage. Contact an authorized dealer.

Replacing Headlamp Bulbs

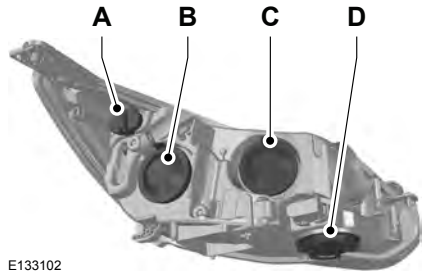

E133102

- A. Side marker bulb.
- B. Low beam headlamp bulb.
Contact and authorized dealer for replacement.
- C. High beam headlamp bulb.
Contact and authorized dealer for replacement.
- D. Direction indicator bulb.

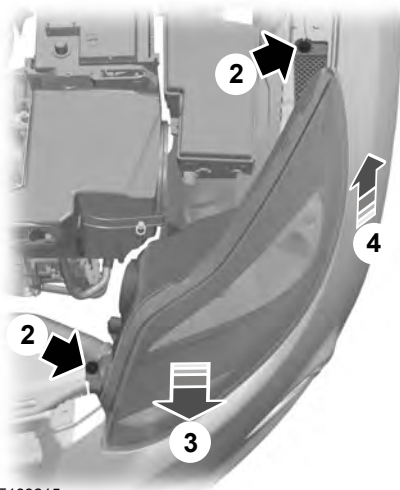

E133215

- 2. Remove the screws.
- 3. Pull the headlamp as far as possible towards the front of the vehicle to disengage it from the lower fixing point.
- 4. Lift the outer side of the headlamp and remove it.

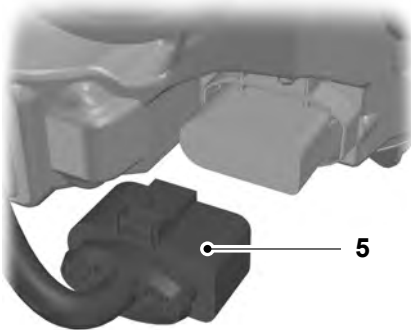

E133750

- 5. Disconnect the electrical connector.

Maintenance

Replacing Direction Indicator Bulbs

1. Remove the headlamp. See **Removing a Headlamp** (page 177).

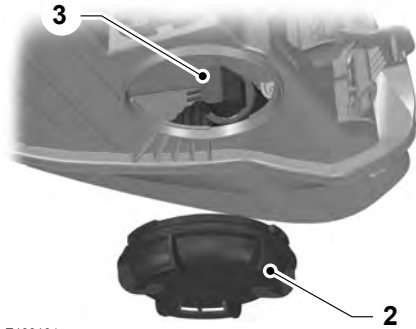

E133104

2. Remove the cover.
3. Turn the bulb holder counterclockwise and remove it.
4. Gently press the bulb into the bulb holder, turn it counterclockwise and remove it.

Replacing Side Marker Bulb

1. Remove the headlamp. See **Removing a Headlamp** (page 177).

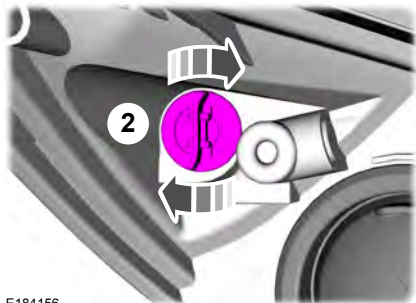

E184156

2. Twist to remove the cover.
3. Remove the bulb holder.

4. Remove the bulb.

Replacing Rear Lamp Bulbs

Accessing the Rear, Brake, Side Marker, Direction Indicator and Reverse Bulbs



E133111

1. Remove the trim panel.

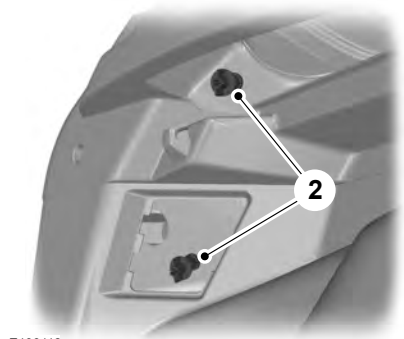

E133112

2. Remove the wing nuts and detach the clip.
3. Remove the lamp.

Maintenance

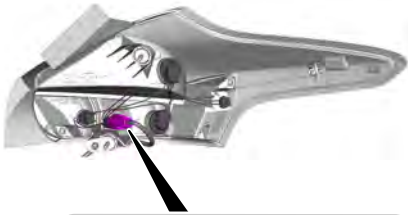

E184158

4. Disconnect the electrical connector.
5. Remove the lamp and unclip the bulb holder.
6. Gently press the bulb into the bulb holder, turn it counterclockwise and remove it.

Replacing the Rear, Brake, Side Marker, Direction Indicator and Reverse Bulbs

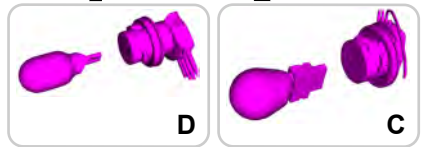
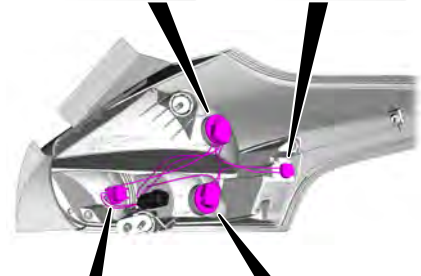
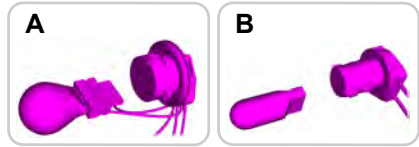

E184159

- A. Brake and rear lamp bulb.
 - B. Side marker lamp bulb.
 - C. Direction indicator bulb.
 - D. Reverse lamp bulb.
1. Remove the lamp and unclip the bulb holder.
 2. Gently press the bulb into the bulb holder, turn it counterclockwise and remove it.

Replacing LED Rear Lamp Bulbs (if Equipped)

These lamps have LED bulbs. Contact an authorized dealer.

Maintenance

Replacing Licence Plate and High Mounted Brake Lamp Bulbs

These lamps have LED bulbs. Contact an authorized dealer.

BULB SPECIFICATION CHART

Replacement bulbs are specified in the chart below. Headlamp bulbs must be marked with an authorized "D.O.T." for North America to ensure lamp performance, light brightness and pattern and safe visibility. The correct bulbs will not damage the lamp assembly or void the lamp assembly warranty and will provide quality bulb burn time.

Function	Trade number
* Headlamp high/low beam (HID)	D8S
* Sidemarker - front	LED
* Park lamp - front	LED
Direction indicator - front	PY21W
Direction indicator - rear	3757 NAK
Brake lamp	3157K
* Rear lamp	LED
Backup lamp	921
* License plate lamp	LED
* High-mount brake lamp	LED
* Interior lamps	LED

* To replace these lamps, contact an authorized dealer.

To replace all instrument panel lights, contact an authorized dealer.

Vehicle Care

GENERAL INFORMATION

Your Ford or Lincoln authorized dealer has many quality products available to clean your vehicle and protect its finishes.

CLEANING PRODUCTS

For best results, use the following products or products of equivalent quality:

- Motorcraft Bug and Tar Remover (ZC-42)
- Motorcraft Custom Bright Metal Cleaner (ZC-15)
- Motorcraft Detail Wash (ZC-3-A)
- Motorcraft Dusting Cloth (ZC-24)
- Motorcraft Engine Shampoo and Degreaser (U.S. only) (ZC-20)
- Motorcraft Engine Shampoo (Canada only) (CXC-66-A)
- Motorcraft Multi-Purpose Cleaner (Canada only) (CXC-101)
- Motorcraft Premium Glass Cleaner (Canada only) (CXC-100)
- Motorcraft Premium Quality Windshield Washer Fluid (Canada only) [CXC-37-(A, B, D or F)]
- Motorcraft Premium Windshield Wash Concentrate with Bitterant (U.S. only) (ZC-32-B2)
- Motorcraft Professional Strength Carpet & Upholstery Cleaner (ZC-54)
- Motorcraft Premium Leather and Vinyl Cleaner (ZC-56)
- Motorcraft Spot and Stain Remover (U.S. only) (ZC-14)
- Motorcraft Ultra-Clear Spray Glass Cleaner (ZC-23)
- Motorcraft Wheel and Tire Cleaner (ZC-37-A)

CLEANING THE EXTERIOR

Wash your vehicle regularly with cool or lukewarm water and a neutral pH shampoo, we recommend Motorcraft Detail Wash.

- Never use strong household detergents or soap, for example dish washing or laundry liquid. These products can discolor and spot painted surfaces.
- Never wash your vehicle when is hot to the touch, or during strong or direct sunlight.
- Dry your vehicle with a chamois or soft terry cloth towel to eliminate water spotting.
- Immediately remove fuel spillages, bird droppings, insect deposits and road tar. These may cause damage to your vehicle's paintwork or trim over time. We recommend Motorcraft Bug and Tar Remover.
- Remove any exterior accessories, for example antennas, before entering a car wash.

Note: *Suntan lotions and insect repellents can damage painted surfaces. If these substances come in contact with your vehicle, wash the affected area as soon as possible.*

Exterior Chrome Parts

- Apply a high quality-cleaning product to bumpers and other chrome parts. Follow the manufacturer's instructions. We recommend Motorcraft Custom Bright Metal Cleaner.
- Do not apply the cleaning product to hot surfaces. Do not leave the cleaning product on chrome surfaces longer than the time recommended.
- Using other non-recommended cleaners can result in severe and permanent cosmetic damage.

Vehicle Care

Note: *Never use abrasive materials, for example steel wool or plastic pads as they can scratch the chrome surface.*

Note: *Do not use chrome cleaner, metal cleaner or polish on wheels or wheel covers.*

Exterior Plastic Parts

For routine cleaning we recommend Motorcraft Detail Wash. If tar or grease spots are present, we recommend Motorcraft Bug and Tar Remover.

Stripes or Graphics (If Equipped)

Do not use a commercial or high-pressure sprayer on the surface or edge of stripes and graphics. This can damage them and cause the edges to peel away from the vehicle surface.

Underbody

Flush the complete underside of your vehicle frequently. Keep body and door drain holes free of debris or foreign material.

WAXING

Regular waxing is necessary to protect your car's paint from the elements. We recommend that you wash and wax the painted surface once or twice a year.

When washing and waxing, park your vehicle in a shaded area out of direct sunlight. Always wash your vehicle before applying wax.

- Use a quality wax that does not contain abrasives.
- Follow the manufacturer's instructions to apply and remove the wax.
- Apply a small amount of wax in a back-and-forth motion, not in circles.

- Do not allow wax to come in contact with any non-body (low-gloss black) colored trim. The wax will discolor or stain the parts over time.
 - Roof racks.
 - Bumpers.
 - Grained door handles.
 - Side moldings.
 - Mirror housings.
 - Windshield cowl area.
- Do not apply wax to glass areas.
- After waxing, your car's paint should feel smooth, and be free of streaks and smudges.

CLEANING THE ENGINE

Engines are more efficient when they are clean because grease and dirt buildup keep the engine warmer than normal.

When washing:

- Take care when using a power washer to clean the engine. The high-pressure fluid could penetrate the sealed parts and cause damage.
- Do not spray a hot engine with cold water to avoid cracking the engine block or other engine components.
- Spray Motorcraft Engine Shampoo and Degreaser on all parts that require cleaning and pressure rinse clean. In Canada, use Motorcraft Engine Shampoo.
- Never wash or rinse the engine while it is hot or running; water in the running engine may cause internal damage.

Vehicle Care

- Never wash or rinse any ignition coil, spark plug wire or spark plug well, or the area in and around these locations.
- Cover the battery, power distribution box, and air filter assembly to prevent water damage when cleaning the engine.

CLEANING THE WINDOWS AND WIPER BLADES

Car wash chemicals and environmental fallout can result in windshield and wiper blade contamination. Dirty windshield and wipers will result in poor windshield wiper operation. Keep the windshield and wiper blades clean to maintain windshield wiper performance.

To clean the windshield and wiper blades:

- Clean the windshield with a non-abrasive glass cleaner.
- For windshields contaminated with tree sap, chemicals, wax or bugs, clean the entire windshield using steel wool (no greater than 0000 grade) in a circular motion and rinse with water.
- Clean the wiper blades with isopropyl rubbing alcohol or windshield washer concentrate.

Note: Do not use razor blades or other sharp objects to clean or remove decals from the inside of the heated rear window. The vehicle warranty does not cover damage caused to the heated rear window grid lines.

CLEANING THE INTERIOR

WARNINGS



Do not use cleaning solvents, bleach or dye on the vehicle's safety belts, as these actions may weaken the belt webbing.

WARNINGS



On vehicles equipped with seat-mounted airbags, do not use chemical solvents or strong detergents. Such products could contaminate the side airbag system and affect performance of the side airbag in a collision.

For fabric, carpets, cloth seats, safety belts and seats equipped with side airbags:

- Remove dust and loose dirt with a vacuum cleaner.
- Remove light stains and soil with Motorcraft Professional Strength Carpet & Upholstery Cleaner.
- If grease or tar is present on the material, spot-clean the area first with Motorcraft Spot and Stain Remover. In Canada, use Motorcraft Multi-Purpose Cleaner.
- If a ring forms on the fabric after spot cleaning, clean the entire area immediately (but do not oversaturate) or the ring will set.
- Do not use household cleaning products or glass cleaners, which can stain and discolor the fabric and affect the flame retardant abilities of the seat materials.

CLEANING THE INSTRUMENT PANEL AND INSTRUMENT CLUSTER LENS

WARNING



Do not use chemical solvents or strong detergents when cleaning the steering wheel or instrument panel to avoid contamination of the airbag system.

Vehicle Care

Note: Follow the same procedure as cleaning leather seats for cleaning leather instrument panels and leather interior trim surfaces. See **Cleaning Leather Seats** (page 185).

Clean the instrument panel and cluster lens with a clean, damp and soft cloth, then use a clean, dry and soft cloth to dry these areas.

- Avoid cleaners or polishes that increase the gloss of the upper portion of the instrument panel. The dull finish in this area helps protect you from undesirable windshield reflection.
- Do not use any household cleaning products or glass cleaners as these may damage the finish of the instrument panel, interior trim and cluster lens.
- Wash or wipe your hands clean if you have been in contact with certain products such as insect repellent and suntan lotion to avoid possible damage to the interior painted surfaces.
- Do not allow air fresheners and hand sanitizers to spill onto interior surfaces. If a spill occurs, wipe off immediately. Your warranty may not cover these damages.

If a staining liquid like coffee or juice has been spilled on the instrument panel or on interior trim surfaces:

1. Wipe up spilled liquid using a clean, soft cloth as quickly as possible.
2. Use Motorcraft Premium Leather and Vinyl Cleaner or a commercially available leather cleaning product for automotive interiors. Test any cleaner or stain remover on an inconspicuous area.
3. Alternatively, wipe the surface with a clean, soft cloth and a mild soap and water solution. Dry the area with a clean, soft cloth.

4. If necessary, apply more soap and water solution or cleaning product to a clean, soft cloth and press it onto the soiled area. Allow this to set at room temperature for 30 minutes.
5. Remove the soaked cloth, then with a clean, damp cloth, use a rubbing motion for 60 seconds on the soiled area.
6. Dry the area with a clean, soft cloth.

CLEANING LEATHER SEATS (If

Equipped)

Note: Follow the same procedure as cleaning leather seats for cleaning leather instrument panels and leather interior trim surfaces.

For routine cleaning, wipe the surface with a soft, damp cloth and a mild soap and water solution. Dry the area with a clean, soft cloth.

For cleaning and removing spots and stains such as dye transfer, use Motorcraft Premium Leather and Vinyl Cleaner or a commercially available leather cleaning product for automotive interiors.

Note: Test any cleaner or stain remover on an inconspicuous area.

You should:

- Remove dust and loose dirt with a vacuum cleaner.
- Clean and treat spills and stains as soon as possible.

Do not use the following products as these may damage the leather:

- Oil and petroleum or silicone-based leather conditioners.
- Household cleaners.

Vehicle Care

- Alcohol solutions.
- Solvents or cleaners intended specifically for rubber, vinyl and plastics.

Note: Do not use Motorcraft Premium Leather and Vinyl Cleaner ZC-56 on Lincoln Black Label, Presidential or Reserve Leathers because it can damage those and other semi-aniline leather seating fabrics. It can also damage surround microfiber accent surfaces. To clean Lincoln Black Label, Presidential or Reserve Leathers, first vacuum the seats to remove loose dirt. Then wipe the leather with a clean soft cloth dampened with lukewarm water and a mild soap. Wiper the leather again with a slightly damp cloth to remove soap residue, and dry with a soft cloth. To maintain the leather's resiliency, it should be cleaned whenever soiled.

REPAIRING MINOR PAINT DAMAGE

Authorized dealers have touch-up paint to match your vehicle's color. Your vehicle color code is printed on a sticker on the front, left-hand side door jamb. Take your color code to your authorized dealer to make sure you get the correct color.

Before repairing minor paint damage, use a cleaner such as Motorcraft Bug and Tar Remover to remove particles such as bird droppings, tree sap, insect deposits, tar spots, road salt and industrial fallout.

Always read the instructions before using cleaning products.

CLEANING THE ALLOY WHEELS (If Equipped)

Note: Do not apply a cleaning chemical to warm or hot wheel rims and covers.

Note: Some automatic car washes may cause damage to the finish on your wheel rims and covers.

Note: Industrial-strength or heavy-duty cleaners in combination with brush agitation to remove brake dust and dirt, could wear away the clear coat finish over a period time.

Note: Do not use hydrofluoric acid-based or high caustic-based wheel cleaners, steel wool, fuels or strong household detergents.

Note: If you intend parking your vehicle for an extended period after cleaning the wheels with a wheel cleaner, drive your vehicle for a few minutes before doing so. This will reduce the risk of increased corrosion of the brake discs.

Alloy wheels and wheel covers are coated with a clear coat paint finish. To maintain their condition we recommend that you:

- Clean the wheels weekly using Motorcraft Wheel and Tire Cleaner. Apply using manufacturer's instructions.
- Use a sponge to remove heavy deposits of dirt and brake dust accumulation.
- Rinse thoroughly with a strong stream of water when you have completed the cleaning process.
- To remove tar and grease, use Motorcraft Bug and Tar Remover.

VEHICLE STORAGE

If you plan on storing your vehicle for 30 days or more, read the following maintenance recommendations to make sure your vehicle stays in good operating condition.

Vehicle Care

We engineer and test all motor vehicles and their components for reliable, regular driving. Under various conditions, long-term storage may lead to degraded engine performance or failure unless you use specific precautions to preserve engine components.

General

- Store all vehicles in a dry, ventilated place.
- Protect from sunlight, if possible.
- If you store vehicles outside, they require regular maintenance to protect against rust and damage.

Body

- Wash your vehicle thoroughly to remove dirt, grease, oil, tar or mud from exterior surfaces, rear-wheel housing and the underside of front fenders.
- Periodically wash your vehicle if you store it in exposed locations.
- Touch-up exposed or primed metal to prevent rust.
- Cover chrome and stainless steel parts with a thick coat of auto wax to prevent discoloration. Re-wax as necessary when you wash your vehicle.
- Lubricate all hood, door and luggage compartment hinges and latches with a light grade oil.
- Cover interior trim to prevent fading.
- Keep all rubber parts free from oil and solvents.

Electric Motor

- Start your vehicle every 15 days for a minimum of 15 minutes. Run at fast idle with the climate controls set to defrost until your vehicle reaches normal operating temperature.

Fuel System

- Fill the fuel tank with high-quality fuel until the first automatic shutoff of the fuel pump nozzle.

Cooling System

- Protect against freezing temperatures.
- When removing your vehicle from storage, check coolant fluid level. Confirm that there are no cooling system leaks and that fluid is at the recommended level.

12V Battery

- Check and recharge as necessary. Keep connections clean.
- If storing your vehicle for more than 30 days without recharging the battery, we recommend that you disconnect the battery cables to maintain battery charge for quick starting.

Note: *It is necessary to reset memory features if you disconnect the battery cables.*

We recommend the following options for your plug-in vehicle:

- Leave your vehicle plugged in. The 12V battery maintains power if left plugged in. However, this periodically uses electricity from the household outlet.
- Connect a battery charger to your 12V battery and leave it on a continuous, slow charge.
- Disconnect the 12V battery. If your 12V battery is located in the luggage compartment, do not fully shut the luggage compartment after disconnecting the 12V battery. Only leave the luggage compartment open if your vehicle is stored in a locked location.

Vehicle Care

Brakes

- Make sure the brakes and parking brake release fully.

Tires

- Maintain recommended air pressure.

Miscellaneous

- Make sure you cover all linkages, cables, levers and pins under your vehicle with grease to prevent rust.
- Move vehicles at least 25 ft (7.5 m) every 15 days to lubricate working parts and prevent corrosion.

Removing Vehicle From Storage

When your vehicle is ready to come out of storage, do the following:

- Wash your vehicle to remove any dirt or grease film build-up on window surfaces.
- Check windshield wipers for any deterioration.
- Check under the hood for any foreign material that may have collected during storage such as mice or squirrel nests.
- Check the exhaust for any foreign material that may have collected during storage.
- Check tire pressures and set tire inflation per the Tire Label.
- Check brake pedal operation. Drive your vehicle 15 ft (4.5 m) back and forth to remove rust build-up.
- Check fluid levels (including coolant and gas) to make sure there are no leaks, and fluids are at recommended levels.
- If you remove the 12-volt battery, clean the cable ends and inspect.

Contact an authorized dealer if you have any concerns or issues.

Wheels and Tires

TEMPORARY MOBILITY KIT

(Type 1)

Note: *The temporary mobility kit contains enough sealant compound in the canister for one tire repair only. See an authorized dealer for replacement sealant canisters.*

The kit is located in the luggage compartment.

The kit consists of an air compressor to reinflate the tire and a canister of sealing compound that will effectively seal most punctures caused by nails or similar objects. This kit provides a temporary tire repair allowing you to drive your vehicle up to 120 mi (200 km) at a maximum speed of 50 mph (80 km/h) to reach a tire service location.

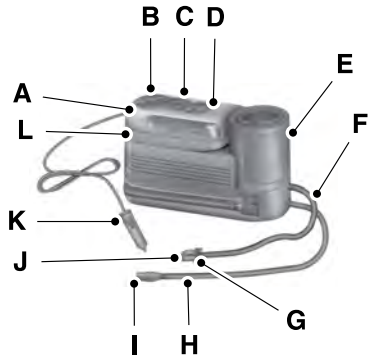

E144618

- A Air compressor (inside).
- B Selector switch.
- C On and off button.
- D Air pressure gauge.
- E Sealant bottle and canister.
- F Sealant filling clear tube.
- G Tire valve connector.
- H Air compressor hose.
- I Yellow cap tool.
- J Air hose-tire valve connector.
- K Accessory power plug.
- L Casing and housing.

Wheels and Tires

General Information

WARNING



Failure to follow these guidelines could result in an increased risk of loss of vehicle control, injury or death.

Note: Do not use the kit if you have severely damaged a tire. Only seal punctures located within the tire tread with the kit.

Do not attempt to repair punctures larger than 1.4 inches (6.4 millimeters) or damage to the tire's sidewall. The tire may not completely seal.

Loss of air pressure may adversely affect tire performance. For this reason:

Note: Do not drive the vehicle above 50 mph (80 km/h).

Note: Do not drive further than 120 mi (200 km). Drive only to the closest authorized Ford dealer or tire repair shop to have your tire inspected.

- Drive carefully and avoid abrupt steering maneuvers.
- Periodically monitor tire inflation pressure in the affected tire. If the tire is losing pressure, have the vehicle towed.
- Read the information in the Tips for Use of the Kit section to make sure of safe operation of the kit and your vehicle.

Tips for Use of the Kit

To ensure safe operation of the kit:

- Read all instructions and cautions fully.
- Before operating the kit, make sure your vehicle is safely off the road and away from moving traffic. Switch on the hazard lights.
- Always set the parking brake to make sure the vehicle does not move unexpectedly.

- Do not remove any foreign objects, such as nails or screws, from the tire.
- When using the kit, leave the engine running (only if the vehicle is outdoors or in a well-ventilated area) so the compressor does not drain the vehicle's battery.
- Do not allow the compressor to operate continuously for more than 15 minutes; this will help prevent the compressor from overheating.
- Never leave the kit unattended when it is operating.
- Sealant compound contains latex. Those with latex sensitivities should use appropriate precautions to avoid an allergic reaction.
- Keep the kit away from children.
- Only use the kit when the ambient temperature is between -22°F (-30°C) and 158°F (70°C).
- Only use the sealing compound before the use by date. Locate the use by date on the lower right hand corner of the label on the sealant canister (bottle). Check the use by date regularly and replace the canister after four years.
- Do not store the kit unsecured inside the passenger compartment of the vehicle as it may cause injury during a sudden stop or crash. Always store the kit in its original location.
- After sealant use, an authorized dealer must replace the tire pressure monitoring system sensor and valve stem on the wheel.
- When inflating a tire or other objects, use the black air hose only. Do not use the transparent hose, which is designed for sealant application only.
- Operating the kit could cause an electrical disturbance in radio, CD, and DVD player operation.

Wheels and Tires

What to do When a Tire Is Punctured

Repair a tire puncture within the tire's tread area in two stages with the kit.

- In the first stage, inflate the tire with a sealing compound and air. After you inflate the tire, you will need to drive the vehicle a short distance (about 4 miles [6 kilometers]) to distribute the sealant in the tire.
- In the second stage, check the tire pressure and adjust, if necessary, to the vehicle's specified tire inflation pressure.

First Stage: Inflating the Tire with Sealing Compound and Air

WARNINGS



Do not stand directly over the kit while inflating the tire. If you notice any unusual bulges or deformations in the tire's sidewall during inflation, stop and call roadside assistance.



If the tire does not inflate to the recommended tire pressure within 15 minutes, stop and call roadside assistance.

Preparation: Park the vehicle in a safe, level and secure area, away from moving traffic.

Switch the hazard lights on. Apply the parking brake and switch the engine off. Inspect the flat tire for visible damage.

WARNING



Do not run the engine during kit operation unless the vehicle is outdoors or in a well-ventilated area.

Sealant compound contains latex. To avoid any allergic reactions, use the non-latex gloves found in the accessory box on the underside of the kit housing.

Do not remove any foreign object that has pierced the tire. If a puncture is located in the tire sidewall, stop and call roadside assistance.

1. Remove the valve cap from the tire valve.
2. Unwrap the clear tube from the compressor housing.
3. Remove the tube cap and fasten the metal connector of the tube to the tire valve, turning clockwise. Make sure you fasten the connection tightly.



E144619

4. Plug the power cable into the 12-volt power point in the vehicle.
5. Remove the warning sticker found on the canister, and place it on top of the instrument panel or the center of the dash.
6. Start the vehicle and leave the engine running so the compressor does not drain the vehicle's battery.

Wheels and Tires

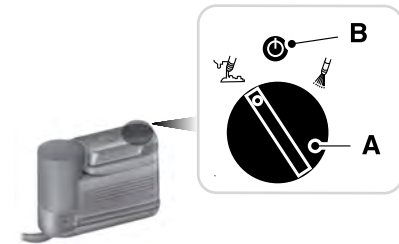

E144924

7. Turn dial (A) counterclockwise to the sealant position. Switch the kit on by pressing the on and off button (B).



E144621

8. Inflate the tire to the pressure listed on the tire label located on the driver door or the door jamb area. The initial air pressure gauge reading may indicate a value higher than the label pressure while you pump the sealing compound into the tire. This is normal and should be no reason for concern. The pressure gauge reading will indicate the tire inflation pressure after about 30 seconds of operation. You should check the final tire pressure with the compressor turned OFF in order to get an accurate pressure reading.

9. When the tire reaches the recommended tire pressure, switch off the kit by pressing the on button; disconnect the kit from the tire valve and the power point. Re-install the valve cap on the tire valve, place the tube cap on the metal connector and return the kit to the storage area.
10. Immediately and cautiously, drive the vehicle 4 miles (6 kilometers) to distribute the sealant evenly inside the tire. Do not exceed 50 mph (80 km/h).
11. After 4 miles (6 kilometers), stop and check the tire pressure. See Second stage: Checking tire pressure.

Note: *If you experience any unusual vibration, ride disturbance or noise while driving, reduce your speed until you can safely pull off to the side of the road to call for roadside assistance.*

Note: *Do not proceed to the second stage of this operation.*

Second Stage: Checking Tire Pressure

WARNINGS

 If you are proceeding from the First stage: Re-inflating the tire with sealing compound and air section and have injected sealant in the tire and the pressure is below 20 psi (1.4 bar), stop and call roadside assistance. If tire pressure is above 20 psi (1.4 bar), continue to the next step.

 The power plug may get hot after use and you should handle it carefully while unplugging.

Check the air pressure of your tires as follows:

1. Remove the valve cap from the tire valve.

Wheels and Tires

- Unhook the black hose from the side of the compressor and fasten firmly on the valve stem by turning clockwise.
- Push and turn the dial clockwise to the air position. To switch the kit on, press the on button.

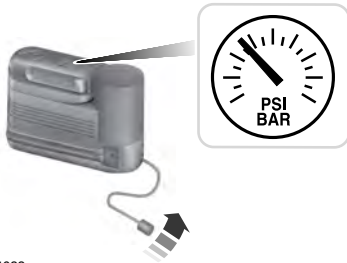

E144622

- If required, switch on the compressor and adjust the tire to the recommended inflation pressure shown on the tire label located on the driver's door or door jamb area. You should check the tire pressure with the compressor turned OFF in order to get an accurate pressure reading.
- Switch the compressor off by pressing the off button.
- Unplug the hoses, re-install the valve cap on the tire and return the kit to the storage area.

What to Do After the Tire has Been Sealed

After using the kit to seal your tire, replace the sealant canister and clear tube (hose). Obtain and replace the sealing compound and spare parts at an authorized Ford Motor Company dealership or tire dealer. You can dispose empty sealant bottles at home. However, return the liquid residue from the sealing compound to an authorized dealer or tire dealer for disposal, or in accordance with local waste disposal regulations.

Note: After you use the sealing compound, the maximum vehicle speed is 50 mph (80 km/h) and the maximum driving distance is 120 mi (200 km). Inspect the sealed tire immediately.

Note: After you use the sealant, an authorized Ford dealer must replace the tire pressure monitoring system sensor and the valve stem on the wheel.

Check the tire pressure any time within the 120 mi (200 km) by performing the steps listed previously in the Second Stage: Checking Tire Pressure procedure.

Removal of the Sealant Canister from the Kit



E144623

- Unwrap the clear tube from the compressor housing.



E144624

- Locate the yellow cap at the end of the clear tube.

Wheels and Tires



E144625

3. Using the yellow cap tool, locate and press the tab on the kit compressor housing while pulling up on the sealant canister.

Installation of the Sealant Canister to the Kit

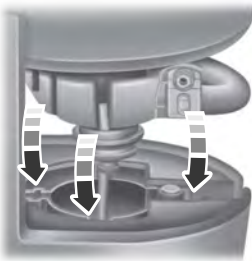

E144626

1. Align the sealant canister with the kit housing.



E161567

2. Once aligned, seat the sealant canister by lightly pushing down until you hear an audible click.



E144628

3. Wrap the clear tube around the compressor housing.

Note: *If you experience any difficulties when you remove or install the sealant canister, contact your authorized Ford dealer for assistance.*

Use By / Utiliser avant:

E144629

Make sure you check the sealant compound's use by date regularly. Locate the compound's use by date on the lower right-hand corner of the label found on the sealant canister (bottle). Replace the sealant canister after four years of non-use.

(Type 2)

Note: *The temporary mobility kit contains enough sealant compound in the canister for one tire repair only. See an authorized Ford dealer for replacement sealant canisters.*

Wheels and Tires

The kit is located in the luggage compartment.

The kit consists of an air compressor to reinflate the tire and a canister of sealing compound that will effectively seal most punctures caused by nails or similar objects. This kit provides a temporary tire repair, allowing you to drive your vehicle up to 120 mi (200 km) at a maximum speed of 50 mph (80 km/h) to reach a tire service location.

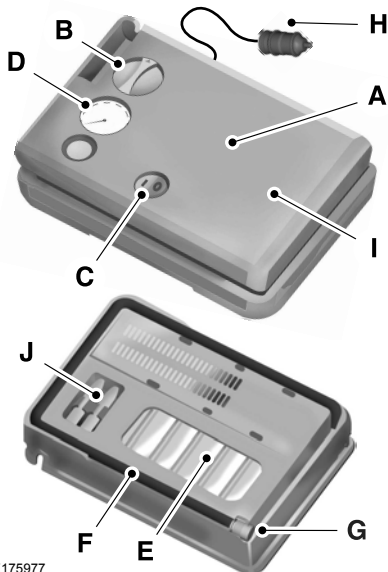

E175977

- A Air compressor (inside).
- B Selector switch.
- C On and off button.
- D Air pressure gauge.
- E Sealant bottle and canister.
- F Dual purpose hose: air and repair.

- G Tire valve connector.
- H Accessory power plug.
- I Casing and housing.
- J Bike/raft/sports ball adapters.

General Information

WARNING



Failure to follow these guidelines could result in an increased risk of loss of vehicle control, injury or death.

Note: Do not use the kit if you have severely damaged a tire. Only seal punctures located within the tire tread with the kit.

Do not attempt to repair punctures larger than ¼ inch (6 millimeters) or damage to the tire's sidewall. The tire may not completely seal.

Loss of air pressure may adversely affect tire performance. For this reason:

Note: Do not drive the vehicle above 50 mph (80 km/h).

Note: Do not drive further than 120 mi (200 km). Drive only to the closest authorized Ford dealer or tire repair shop to have your tire inspected.

- Drive carefully and avoid abrupt steering maneuvers.
- Periodically monitor tire inflation pressure in the affected tire; if the tire is losing pressure, have the vehicle towed.
- Read the information in the Tips for Use of the Kit section to make sure safe operation of the kit and your vehicle occurs.

Tips for Use of the Kit

To ensure safe operation of the kit:

Wheels and Tires

- Read all instructions and cautions fully.
- Before operating the kit, make sure your vehicle is safely off the road and away from moving traffic. Switch on the hazard lights.
- Always set the parking brake to make sure the vehicle does not move unexpectedly.
- Do not remove any foreign objects, such as nails or screws, from the tire.
- When using the kit, leave the engine running (only if the vehicle is outdoors or in a well-ventilated area) so the compressor does not drain the vehicle's battery.
- Do not allow the compressor to operate continuously for more than 15 minutes. This will help prevent the compressor from overheating.
- Never leave the kit unattended during operation.
- Sealant compound contains latex. Those with latex sensitivities should use appropriate precautions to avoid an allergic reaction.
- Keep the kit away from children.
- Only use the kit when the ambient temperature is between -22°F (-30°C) and 158°F (70°C).
- Only use the sealing compound before the use-by date. The use-by date is on a label on the sealant canister, which you can see through the rectangular viewing window on the bottom of the compressor. Check the use-by date regularly and replace the canister after four years of non-use.
- Do not store the kit unsecured inside the passenger compartment of the vehicle as it may cause injury during a sudden stop or crash. Always store the kit in its original location.
- After sealant use, an authorized Ford dealer must replace the tire pressure monitoring system sensor and valve stem on the wheel.
- Operating the kit could cause an electrical disturbance in radio, CD and DVD player operation.



* When inflation only is required for a tire or other objects, the selector must be in the Air position.

What to Do When a Tire Is Punctured

Repair a tire puncture within the tire's tread area in two stages with the kit.

- In the first stage, inflate the tire with a sealing compound and air. After you inflate the tire, you will need to drive the vehicle a short distance (about 4 miles [6 kilometers]) to distribute the sealant in the tire.
- In the second stage, check the tire pressure and adjust, if necessary, to the vehicle's specified tire inflation pressure.

First Stage: Inflating the Tire with Sealing Compound and Air

WARNINGS



Do not stand directly over the kit while inflating the tire. If you notice any unusual bulges or deformations in the tire's sidewall during inflation, stop and call roadside assistance.



If the tire does not inflate to the recommended tire pressure within 15 minutes, stop and call roadside assistance.



Do not run the engine during kit operation unless the vehicle is outdoors or in a well-ventilated area.

Wheels and Tires

Preparation: Park the vehicle in a safe, level and secure area, away from moving traffic.

Switch the hazard lights on. Apply the parking brake and switch the engine off. Inspect the flat tire for visible damage.

Sealant compound contains latex. Use appropriate precautions to avoid any allergic reactions.

Do not remove any foreign object that has pierced the tire. If a puncture is located in the tire sidewall, stop and call roadside assistance.

1. Remove the valve cap from the tire valve.
2. Unwrap the dual purpose hose (black tube) from the back of the compressor housing.
3. Fasten the hose to the tire valve by turning the connector clockwise. Tighten the connection securely.



E175979

4. Plug the power cable into the 12-volt power point in the vehicle.
5. Remove the warning sticker found on the canister and place it on the top of the instrument panel or the center of the dash.
6. Start the vehicle and leave the engine running so the compressor does not drain the vehicle's battery.

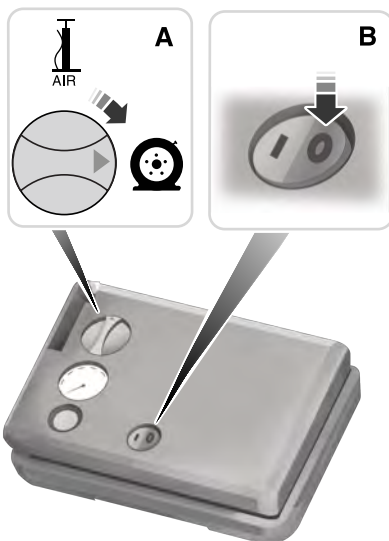

E175981

7. Turn dial (A) clockwise to the sealant position. Switch the kit on by pressing the on/off button (B).
8. Inflate the tire to the pressure listed on the tire label located on the driver door or the door jamb area. The initial air pressure gauge reading may indicate a value higher than the label pressure while you pump the sealing compound into the tire. This is normal and should be no reason for concern. The pressure

Wheels and Tires

gauge reading will indicate the tire inflation pressure after about 30 seconds of operation. You should check the final tire pressure with the compressor turned OFF in order to get an accurate pressure reading.

Note: *If you experience any unusual vibration, ride disturbance or noise while driving, reduce your speed until you can safely pull off to the side of the road to call for roadside assistance.*

Note: *Do not proceed to the second stage of this operation.*

Second Stage: Checking Tire Pressure

WARNINGS

 If you are proceeding from the First stage: Re-inflating the tire with sealing compound and air section and have injected sealant in the tire and the pressure is below 20 psi (1.4 bar), stop and call roadside assistance. If tire pressure is above 20 psi (1.4 bar), continue to the next step.

 The power plug may get hot after use and should be handled carefully while unplugging.

Check the air pressure of your tires as follows:



E175983

1. Remove the valve cap from the tire valve.
2. Firmly screw the air compressor hose onto the valve stem by turning clockwise.
3. Push and turn the dial clockwise to the air position.

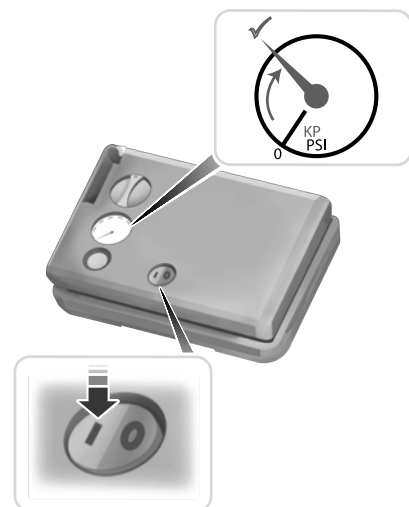

E175982

9. When the tire reaches the recommended tire pressure, switch off the kit, unplug the power cable, and disconnect the hose from the tire valve. Re-install the valve cap on the tire valve and return the kit to the stowage area.
10. Immediately and cautiously, drive the vehicle 4 miles (6 kilometers) to distribute the sealant evenly inside the tire. Do not exceed 50 mph (80 km/h).
11. After 4 miles (6 kilometers), stop and check the tire pressure. See Second Stage: Checking Tire Pressure.

Wheels and Tires

4. If required, switch on the compressor and adjust the tire to the recommended inflation pressure shown on the tire label located on the driver's door or door jamb area. You should check the tire pressure with the compressor turned OFF in order to get an accurate pressure reading.
5. Unplug the hoses, re-install the valve cap on the tire and return the kit to the stowage area.

What to Do After the Tire has Been Sealed

After using the kit to seal your tire, replace the sealant canister and clear tube (hose). Obtain and replace the sealing compound and spare parts at an authorized Ford Motor Company dealership or tire dealer. You can dispose empty sealant bottles at home. However, return the liquid residue from the sealing compound to an authorized dealer or tire dealer for disposal, or in accordance with local waste disposal regulations.

Note: After you use the sealing compound, the maximum vehicle speed is 50 mph (80 km/h) and the maximum driving distance is 120 mi (200 km). Inspect the sealed tire immediately.

Check the tire pressure any time within the 120 mi (200 km) by performing the steps listed previously in the Second Stage: Checking Tire Pressure procedure.

Removal of the Sealant Canister from the Kit

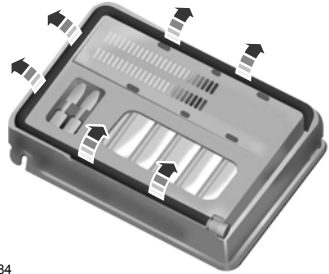

E175984

1. Unwrap the dual purpose hose (black tube) from the compressor housing.



E175985

2. Unwrap the power cord.



E175986

3. Remove the back cover.

Wheels and Tires



E175987

4. Rotate the sealant canister up 90 degrees and pull away from casing/housing to remove.

Installation of the Sealant Canister to the Kit

1. With the canister held perpendicular to the housing, insert the canister nozzle into the connector and push until seated.
2. Rotate the canister 90 degrees down into the housing/casing.



E175988

3. Snap the back cover back into place.

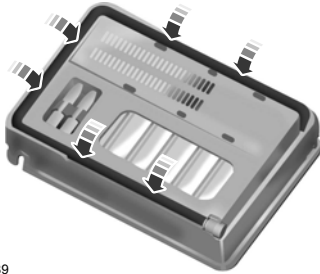

E175989

4. Wrap the dual purpose hose (black tube) around the channel on the bottom of the housing/casing.



E175990

5. Wrap the power cord around the housing and stow the accessory power plug into its storage area.

Note: *If you experience any difficulties when you remove or install the sealant canister, contact your authorized Ford dealer for assistance.*

Make sure you check the sealant compound's use-by date regularly. The use-by date is on a label located on the sealant canister, which you can see through the rectangular viewing window on the bottom of the kit. Replace the sealant canister after four years of non-use.

Wheels and Tires

TIRE CARE

Important Information for 235/40R18 Low-Profile Tires and Wheels

If your vehicle is equipped with 235/40R18 tires, they are low-profile tires. These tires and wheels are designed to give your vehicle a sport appearance. With low-profile tires, you may notice an increase in road noise and faster tire wear, depending on road conditions and driving styles. Due to their design, low-profile tires and wheels are more prone to road damage from potholes, rough or unpaved roads, car wash rails and curb contact than standard tires and wheels.

Note: *Your vehicle's warranty does not cover these types of damage. Tires should always be kept at the correct inflation pressures and extra caution should be taken when operating on rough roads to avoid impacts that could cause wheel and tire damage.*

Information About Uniform Tire Quality Grading



E142542

Tire Quality Grades apply to new pneumatic passenger car tires. The tire Quality Grades can be found where applicable on the tire sidewall between tread shoulder and maximum section width. For example: **Treadwear 200 Traction AA Temperature A.**

These Tire Quality Grades are determined by standards that the United States Department of Transportation has set.

Tire Quality Grades apply to new pneumatic passenger car tires. They do not apply to deep tread, winter-type snow tires, space-saver or temporary use spare tires, light truck or LT type tires, tires with nominal rim diameters of 10 to 12 inches or limited production tires as defined in Title 49 Code of Federal Regulations Part 575.104 ©)(2).

Wheels and Tires

U.S. Department of Transportation-Tire quality grades: The U.S. Department of Transportation requires Ford Motor Company to give you the following information about tire grades exactly as the government has written it.

Treadwear

The treadwear grade is a comparative rating based on the wear rate of the tire when tested under controlled conditions on a specified government test course. For example, a tire graded 150 would wear 1½ times as well on the government course as a tire graded 100. The relative performance of tires depends upon the actual conditions of their use, however, and may depart significantly from the norm due to variations in driving habits, service practices, and differences in road characteristics and climate.

Traction AA A B C

WARNING

 The traction grade assigned to this tire is based on straight-ahead braking traction tests, and does not include acceleration, cornering, hydroplaning or peak traction characteristics.

The traction grades, from highest to lowest are AA, A, B, and C. The grades represent the tire's ability to stop on wet pavement as measured under controlled conditions on specified government test surfaces of asphalt and concrete. A tire marked C may have poor traction performance.

Temperature A B C

WARNING

 The temperature grade for this tire is established for a tire that is properly inflated and not overloaded. Excessive speed, under-inflation, or excessive loading, either separately or in combination, can cause heat buildup and possible tire failure.

The temperature grades are A (the highest), B and C, representing the tire's resistance to the generation of heat and its ability to dissipate heat when tested under controlled conditions on a specified indoor laboratory test wheel. Sustained high temperature can cause the material of the tire to degenerate and reduce tire life, and excessive temperature can lead to sudden tire failure. The grade C corresponds to a level of performance which all passenger car tires must meet under the

Wheels and Tires

Federal Motor Vehicle Safety Standard No. 139. Grades B and A represent higher levels of performance on the laboratory test wheel than the minimum required by law.

Glossary of Tire Terminology

Tire label: A label showing the OE (Original Equipment) tire sizes, recommended inflation pressure and the maximum weight the vehicle can carry.

Tire Identification Number (TIN): A number on the sidewall of each tire providing information about the tire brand and manufacturing plant, tire size and date of manufacture. Also referred to as DOT code.

Inflation pressure: A measure of the amount of air in a tire.

Standard load: A class of P-metric or Metric tires designed to carry a maximum load at 35 psi (2.41 bar)[36 psi (2.5 bar) for Metric tires]. Increasing the inflation pressure beyond this pressure will not increase the tire's load carrying capability.

Extra load: A class of P-metric or Metric tires designed to carry a heavier maximum load at 41 psi (2.8 bar)[42 psi (2.9 bar) for Metric tires]. Increasing the inflation pressure beyond this pressure will not increase the tire's load carrying capability.

kPa: Kilopascal, a metric unit of air pressure.

PSI: Pounds per square inch, a standard unit of air pressure.

Cold tire pressure: The tire pressure when the vehicle has been stationary and out of direct sunlight for an hour or more and prior to the vehicle being driven for 1 mi (1.6 km).

Recommended inflation pressure: The cold inflation pressure found on the Safety Compliance Certification Label (affixed to either the door hinge pillar, door-latch post, or the door edge that meets the door-latch post, next to the driver's seating position) or Tire Label located on the B-Pillar or the edge of the driver's door.

B-pillar: The structural member at the side of the vehicle behind the front door.

Bead area of the tire: Area of the tire next to the rim.

Sidewall of the tire: Area between the bead area and the tread.

Tread area of the tire: Area of the perimeter of the tire that contacts the road when mounted on the vehicle.

Rim: The metal support (wheel) for a tire or a tire and tube assembly upon which the tire beads are seated.

Wheels and Tires

Information Contained on the Tire Sidewall

Both U.S. and Canada Federal regulations require tire manufacturers to place standardized information on the sidewall of all tires. This information identifies and describes the fundamental characteristics of the tire and also provides a U.S. DOT Tire Identification Number for safety standard certification and in case of a recall.

Information on P Type Tires

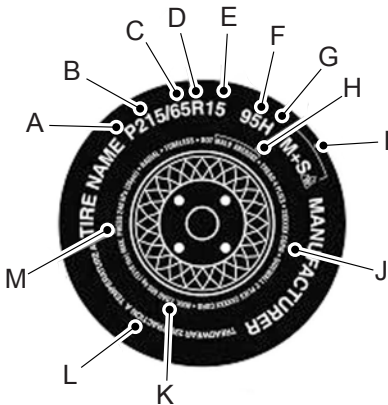

E142543

P215/65R15 95H is an example of a tire size, load index and speed rating. The definitions of these items are listed below. (Note that the tire size, load index and speed rating for your vehicle may be different from this example.)

A. P: Indicates a tire, designated by the Tire and Rim Association, that may be used for service on cars, sport utility vehicles, minivans and light trucks. **Note:** If your tire size does not begin with a letter, this may mean it is designated by either the European Tire and Rim Technical Organization or the Japan Tire Manufacturing Association.

B. 215: Indicates the nominal width of the tire in millimeters from sidewall edge to sidewall edge. In general, the larger the number, the wider the tire.

C. 65: Indicates the aspect ratio which gives the tire's ratio of height to width.

D. R: Indicates a radial type tire.

E. 15: Indicates the wheel or rim diameter in inches. If you change your wheel size, you will have to purchase new tires to match the new wheel diameter.

F. 95: Indicates the tire's load index. It is an index that relates to how much weight a tire can carry. You may find this information in your owner's manual. If not, contact a local tire dealer.

Note: You may not find this information on all tires because it is not required by federal law.

Wheels and Tires

G. H: Indicates the tire's speed rating. The speed rating denotes the speed at which a tire is designed to be driven for extended periods of time under a standard condition of load and inflation pressure. The tires on your vehicle may operate at different conditions for load and inflation pressure. These speed ratings may need to be adjusted for the difference in conditions. The ratings range from 81 mph (130 km/h) to 186 mph (299 km/h). These ratings are listed in the following chart.

Note: *You may not find this information on all tires because it is not required by federal law.*

Letter rating	Speed rating
M	81 mph (130 km/h)
N	87 mph (140 km/h)
Q	99 mph (159 km/h)
R	106 mph (171 km/h)
S	112 mph (180 km/h)
T	118 mph (190 km/h)
U	124 mph (200 km/h)
H	130 mph (210 km/h)
V	149 mph (240 km/h)

Letter rating	Speed rating
W	168 mph (270 km/h)
Y	186 mph (299 km/h)

Note: *For tires with a maximum speed capability over 149 mph (240 km/h), tire manufacturers sometimes use the letters ZR. For those with a maximum speed capability over 186 mph (299 km/h), tire manufacturers always use the letters ZR.*

H. U.S. DOT Tire Identification Number (TIN): This begins with the letters DOT and indicates that the tire meets all federal standards. The next two numbers or letters are the plant code designating where it was manufactured, the next two are the tire size code and the last four numbers represent the week and year the tire was built. For example, the numbers 317 mean the 31st week of 1997. After 2000 the numbers go to four digits. For example, 2501 means the 25th week of 2001. The numbers in between are identification codes used for traceability. This information is used to contact customers if a tire defect requires a recall.

I. M+S or M/S: Mud and Snow, or
AT: All Terrain, or
AS: All Season.

Wheels and Tires

J. Tire Ply Composition and Material Used: Indicates the number of plies or the number of layers of rubber-coated fabric in the tire tread and sidewall. Tire manufacturers also must indicate the ply materials in the tire and the sidewall, which include steel, nylon, polyester, and others.

K. Maximum Load: Indicates the maximum load in kilograms and pounds that can be carried by the tire. Refer to the Safety Compliance Certification Label (affixed to either the door hinge pillar, door-latch post, or the door edge that meets the door-latch post, next to the driver's seating position), for the correct tire pressure for your vehicle.

L. Treadwear, Traction and Temperature Grades:

***Treadwear** The treadwear grade is a comparative rating based on the wear rate of the tire when tested under controlled conditions on a specified government test course. For example, a tire graded 150 would wear one and one-half times as well on the government course as a tire graded 100.

***Traction:** The traction grades, from highest to lowest are AA, A, B, and C. The grades represent the tire's ability to stop on wet pavement as measured under controlled conditions on specified government test surfaces of asphalt and concrete. A tire marked C may have poor traction performance.

***Temperature:** The temperature grades are A (the highest), B and C, representing the tire's resistance to the generation of heat and its ability to dissipate heat when tested under controlled conditions on a specified indoor laboratory test wheel.

M. Maximum Inflation Pressure: Indicates the tire manufacturer's maximum permissible pressure or the pressure at which the maximum load can be carried by the tire. This pressure is normally higher than the manufacturer's recommended cold inflation pressure, which can be found on the Safety Compliance Certification Label (affixed to either the door hinge pillar, door-latch post, or the door edge that meets the door-latch post, next to the driver's seating position), or Tire Label which is located on the B-Pillar or the edge of the driver's door. The cold inflation pressure should never be set lower than the recommended pressure on the vehicle label.

Wheels and Tires

The tire suppliers may have additional markings, notes or warnings such as standard load, radial tubeless, etc.

Additional Information Contained on the Tire Sidewall for LT Type Tires

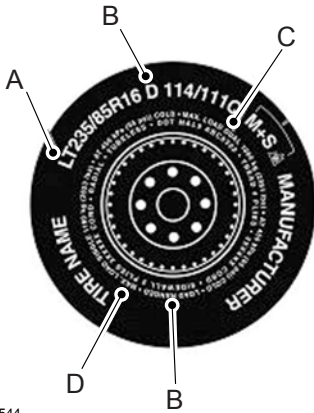

E142544

LT type tires have some additional information beyond those of P type tires; these differences are described below.

Note: *Tire Quality Grades do not apply to this type of tire.*

A. **LT:** Indicates a tire, designated by the Tire and Rim Association, that is intended for service on light trucks.

B. **Load Range and Load Inflation Limits:** Indicates the tire's load-carrying capabilities and its inflation limits.

C. **Maximum Load Dual lb (kg) at psi (kPa) cold:** Indicates the maximum load and tire pressure when the tire is used as a dual, defined as four tires on the rear axle (a total of six or more tires on the vehicle).

D. **Maximum Load Single lb (kg) at psi (kPa) cold:** Indicates the maximum load and tire pressure when the tire is used as a single, defined as two tires (total) on the rear axle.

Information on T Type Tires

T type tires have some additional information beyond those of P type tires; these differences are described below:

T145/80D16 is an example of a tire size.

Note: *The temporary tire size for your vehicle may be different from this example. Tire Quality Grades do not apply to this type of tire.*

Wheels and Tires

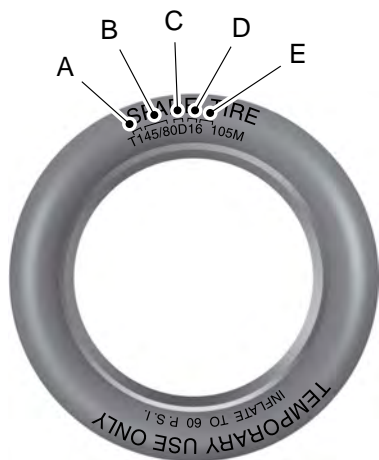

E142545

A. **T:** Indicates a type of tire, designated by the Tire and Rim Association, that is intended for temporary service on cars, sport-utility vehicles, minivans and light trucks.

B. **145:** Indicates the nominal width of the tire in millimeters from sidewall edge to sidewall edge. In general, the larger the number, the wider the tire.

C. **80:** Indicates the aspect ratio which gives the tire's ratio of height to width. Numbers of 70 or lower indicate a short sidewall.

D. **D:** Indicates a diagonal type tire.

R: Indicates a radial type tire.

E. **16:** Indicates the wheel or rim diameter in inches. If you change your wheel size, you will have to purchase new tires to match the new wheel diameter.

Location of the Tire Label

You will find a Tire Label containing tire inflation pressure by tire size and other important information located on the B-Pillar or the edge of the driver door.

Inflating Your Tires

Safe operation of your vehicle requires that your tires are properly inflated. Remember that a tire can lose up to half of its air pressure without appearing flat.

Every day before you drive, check your tires. If one looks lower than the others, use a tire gauge to check pressure of all tires and adjust if required.

At least once a month and before long trips, inspect each tire and check the tire pressure with a tire gauge (including spare, if equipped). Inflate all tires to the inflation pressure recommended by Ford Motor Company.

Wheels and Tires

WARNING



Under-inflation is the most common cause of tire failures and may result in severe tire cracking, tread separation or blowout, with unexpected loss of vehicle control and increased risk of injury. Under-inflation increases sidewall flexing and rolling resistance, resulting in heat buildup and internal damage to the tire. It also may result in unnecessary tire stress, irregular wear, loss of vehicle control and accidents. A tire can lose up to half of its air pressure and not appear to be flat!

You are strongly urged to buy a reliable tire pressure gauge, as automatic service station gauges may be inaccurate. Ford recommends the use of a digital or dial-type tire pressure gauge rather than a stick-type tire pressure gauge.

Use the recommended cold inflation pressure for optimum tire performance and wear. Under-inflation or over-inflation may cause uneven treadwear patterns.

Always inflate your tires to the Ford recommended inflation pressure even if it is less than the maximum inflation pressure information found on the tire. The Ford recommended tire inflation pressure is found on the Safety Compliance Certification Label

(affixed to either the door hinge pillar, door-latch post, or the door edge that meets the door-latch post, next to the driver's seating position), or Tire Label which is located on the B-Pillar or the edge of the driver door. Failure to follow the tire pressure recommendations can cause uneven treadwear patterns and adversely affect the way your vehicle handles.

Maximum Inflation Pressure is the tire manufacturer's maximum permissible pressure or the pressure at which the maximum load can be carried by the tire. This pressure is normally higher than the manufacturer's recommended cold inflation pressure, which can be found on the Safety Compliance Certification Label (affixed to either the door hinge pillar, door-latch post, or the door edge that meets the door-latch post, next to the driver's seating position), or Tire Label which is located on the B-Pillar or the edge of the driver's door. The cold inflation pressure should never be set lower than the recommended pressure on the Safety Compliance Certification Label or Tire Label.

Wheels and Tires

When weather temperature changes occur, tire inflation pressures also change. A 10°F (6°C) temperature drop can cause a corresponding drop of 1 psi (7 kPa) in inflation pressure. Check your tire pressures frequently and adjust them to the proper pressure which can be found on the Safety Compliance Certification Label or Tire Label.

To check the pressure in your tire(s):

1. Make sure the tires are cool, meaning they are not hot from driving even a mile.

Note: *If you are checking tire pressure when the tire is hot, (for example, driven more than 1 mile [1.6 kilometers], never bleed or reduce air pressure. The tires are hot from driving and it is normal for pressures to increase above recommended cold pressures. A hot tire at or below recommended cold inflation pressure could be significantly under-inflated.*

Note: *If you have to drive a distance to get air for your tire(s), check and record the tire pressure first and add the appropriate air pressure when you get to the pump. It is normal for tires to heat up and the air pressure inside to go up as you drive.*

2. Remove the cap from the valve on one tire, then firmly press the tire gauge onto the valve and measure the pressure.

3. Add enough air to reach the recommended air pressure.

Note: *If you overfill the tire, release air by pressing on the metal stem in the center of the valve. Then recheck the pressure with your tire gauge.*

4. Replace the valve cap.

5. Repeat this procedure for each tire, including the spare.

Note: *Some spare tires operate at a higher inflation pressure than the other tires. For T-type mini-spare tires, refer to the Dissimilar spare wheel and tire assembly information for a description. Store and maintain at 60 psi (4.15 bar). For full-size and dissimilar spare tires, refer to the Dissimilar spare wheel and tire assembly information for a description. Store and maintain at the higher of the front and rear inflation pressure as shown on the Tire Label.*

6. Visually inspect the tires to make sure there are no nails or other objects embedded that could poke a hole in the tire and cause an air leak.

7. Check the sidewalls to make sure there are no gouges, cuts or bulges.

Wheels and Tires

Inspecting Your Tires and Wheel Valve Stems

Periodically inspect the tire treads for uneven or excessive wear and remove objects such as stones, nails or glass that may be wedged in the tread grooves. Check the tire and valve stems for holes, cracks, or cuts that may permit air leakage and repair or replace the tire and replace the valve stem. Inspect the tire sidewalls for cracking, cuts, bruises and other signs of damage or excessive wear. If internal damage to the tire is suspected, have the tire demounted and inspected in case it needs to be repaired or replaced. For your safety, tires that are damaged or show signs of excessive wear should not be used because they are more likely to blow out or fail.

Improper or inadequate vehicle maintenance can cause tires to wear abnormally. Inspect all your tires, including the spare, frequently, and replace them if one or more of the following conditions exist:

Tire Wear

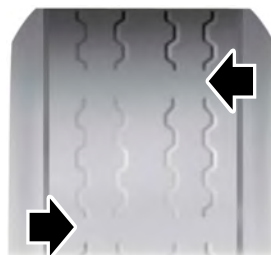

E142546

When the tread is worn down to $\frac{1}{16}$ th of an inch (2 mm), tires must be replaced to help prevent your vehicle from skidding and hydroplaning. Built-in treadwear indicators, or wear bars, which look like narrow strips of smooth rubber across the tread will appear on the tire when the tread is worn down to $\frac{1}{16}$ th of an inch (2 mm).

When the tire tread wears down to the same height as these wear bars, the tire is worn out and must be replaced.

Damage

Periodically inspect the tire treads and sidewalls for damage (such as bulges in the tread or sidewalls, cracks in the tread groove and separation in the tread or sidewall). If damage is observed

Wheels and Tires

or suspected have the tire inspected by a tire professional. Tires can be damaged during off-road use, so inspection after off-road use is also recommended.

Age

WARNING



Tires degrade over time depending on many factors such as weather, storage conditions, and conditions of use (such as load, speed, inflation pressure, etc.) the tires experience throughout their lives.

In general, tires should be replaced after six years regardless of tread wear. However, heat caused by hot climates or frequent high loading conditions can accelerate the aging process and may require tires to be replaced more frequently.

You should replace your spare tire when you replace the road tires or after six years due to aging even if it has not been used.

U.S. DOT Tire Identification Number

Both United States and Canada Federal regulations require tire manufacturers to place standardized information on the sidewall of all tires. This information identifies and

describes the fundamental characteristics of the tire and also provides a United States DOT Tire Identification Number for safety standard certification and in case of a recall.

This begins with the letters DOT and indicates that the tire meets all federal standards. The next two numbers or letters are the plant code designating where it was manufactured, the next two are the tire size code and the last four numbers represent the week and year the tire was built. For example, the numbers 317 mean the 31st week of 1997. After 2000 the numbers go to four digits. For example, 2501 means the 25th week of 2001. The numbers in between are identification codes used for traceability. This information is used to contact customers if a tire defect requires a recall.

Tire Replacement Requirements

Your vehicle is equipped with tires designed to provide a safe ride and handling capability.

WARNINGS



Only use replacement tires and wheels that are the same size, load index, speed rating and type (such as P-metric versus LT-metric or all-season versus all-terrain) as those originally provided by Ford. The recommended tire and wheel size

Wheels and Tires

WARNINGS

may be found on either the Safety Compliance Certification Label (affixed to either the door hinge pillar, door-latch post, or the door edge that meets the door-latch post, next to the driver's seating position), or the Tire Label which is located on the B-Pillar or edge of the driver's door. If this information is not found on these labels, then you should contact your authorized dealer as soon as possible. Use of any tire or wheel not recommended by Ford can affect the safety and performance of your vehicle, which could result in an increased risk of loss of vehicle control, vehicle rollover, personal injury and death. Additionally the use of non-recommended tires and wheels could cause steering, suspension, axle, transfer case or power transfer unit failure. If you have questions regarding tire replacement, contact your authorized dealer as soon as possible.



When mounting replacement tires and wheels, you should not exceed the maximum pressure indicated on the sidewall of the tire to set the beads without additional precautions listed below. If the beads do not seat at the maximum pressure indicated, re-lubricate and try again.

WARNINGS

When inflating the tire for mounting pressures up to 20 psi (1.38 bar) greater than the maximum pressure on the tire sidewall, the following precautions must be taken to protect the person mounting the tire:

1. Make sure that you have the correct tire and wheel size.
2. Lubricate the tire bead and wheel bead seat area again.
3. Stand at a minimum of 12 ft (3.66 m) away from the wheel and tire assembly.
4. Use both eye and ear protection.

For a mounting pressure more than 20 psi (1.38 bar) greater than the maximum pressure, a Ford dealer or other tire service professional should do the mounting.

Always inflate steel carcass tires with a remote air fill with the person inflating standing at a minimum of 12 ft (3.66 m) away from the wheel and tire assembly.

Important: Remember to replace the wheel valve stems when the road tires are replaced on your vehicle.

Wheels and Tires

It is recommended that the two front tires or two rear tires generally be replaced as a pair.

The tire pressure sensors mounted in the wheels (originally installed on your vehicle) are not designed to be used in aftermarket wheels.

The use of wheels or tires not recommended by Ford Motor Company may affect the operation of your tire pressure monitoring system.

If the tire pressure monitoring system indicator is flashing, your tire pressure monitoring system is malfunctioning. Your replacement tire might be incompatible with your TPMS, or some component of the TPMS may be damaged.

Safety Practices

WARNINGS



If your vehicle is stuck in snow, mud, sand, etc., do not rapidly spin the tires. Spinning the tires can tear the tire and cause an explosion. A tire can explode in as little as three to five seconds.



Do not spin the wheels at over 30 mph (56 km/h). The tires may fail and injure a passenger or bystander.

Driving habits have a great deal to do with your tire mileage and safety.

Observe posted speed limits.

Avoid fast starts, stops and turns.

Avoid potholes and objects on the road.

Do not run over curbs or hit the tire against a curb when parking.

Highway Hazards

No matter how carefully you drive there is always the possibility that you may eventually have a flat tire on the highway. Drive slowly to the closest safe area out of traffic.

This may further damage the flat tire, but your safety is more important.

If you feel a sudden vibration or ride disturbance while driving, or you suspect your tire or vehicle has been damaged, immediately reduce your speed. Drive with caution until you can safely pull off the road. Stop and inspect the tires for damage. If a tire is under-inflated or damaged, deflate it, remove wheel and replace it with your spare tire and wheel. If you cannot detect a cause, have the vehicle towed to the nearest repair facility or tire dealer to have the vehicle inspected.

Wheels and Tires

Tire and Wheel Alignment

A bad jolt from hitting a curb or pothole can cause the front end of your vehicle to become misaligned or cause damage to your tires. If your vehicle seems to pull to one side when you are driving, the wheels may be out of alignment. Have an authorized dealer check the wheel alignment periodically.

Wheel misalignment in the front or the rear can cause uneven and rapid treadwear of your tires and should be corrected by an authorized dealer. Front-wheel drive vehicles and those with an independent rear suspension (if equipped) may require alignment of all four wheels.

The tires should also be balanced periodically. An unbalanced tire and wheel assembly may result in irregular tire wear.

Tire Rotation

WARNING



If the tire label shows different tire pressures for the front and rear tires and the vehicle is equipped with a tire pressure monitoring system, then the settings for the system sensors need to be updated. Always perform the system reset procedure after tire rotation. If the system is not reset, it may not provide a low tire pressure warning when necessary. See **Tire Pressure Monitoring System** (page 216).

Note: *If your tires show uneven wear ask an authorized dealer to check for and correct any wheel misalignment, tire imbalance or mechanical problem involved before tire rotation.*

Note: *Your vehicle may be equipped with a dissimilar spare wheel and tire assembly. A dissimilar spare wheel and tire assembly is defined as a spare wheel and tire assembly that is different in brand, size or appearance from the road tires and wheels. If you have a dissimilar spare wheel and tire assembly it is intended for temporary use only and should not be used in a tire rotation.*

Note: *After having your tires rotated, inflation pressure must be checked and adjusted to the vehicle requirements.*

Wheels and Tires

Rotating your tires at the recommended interval (as indicated in the Scheduled Maintenance chapter) will help your tires wear more evenly, providing better tire performance and longer tire life.

Front-wheel drive vehicles (front tires on the left side of the diagram).

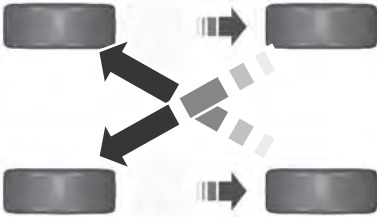

E142547

Sometimes irregular tire wear can be corrected by rotating the tires.

USING SNOW CHAINS

WARNING



Your vehicle is not approved for use with snow chains.

TIRE PRESSURE MONITORING SYSTEM

WARNING



The tire pressure monitoring system is not a substitute for manually checking tire pressure. The tire pressure should be checked periodically (at least monthly) using a tire gauge, see Inflating your tires in this chapter. Failure to properly maintain your tire pressure could increase the risk of tire failure, loss of control, vehicle rollover and personal injury.



Each tire, including the spare (if provided), should be checked monthly when cold and inflated to the inflation pressure recommended by the vehicle manufacturer on the vehicle placard or tire inflation pressure label. (If your vehicle has tires of a different size than the size indicated on the vehicle placard or tire inflation pressure label, you should determine the proper tire inflation pressure for those tires.)

As an added safety feature, your vehicle has been equipped with a Tire Pressure Monitoring System (TPMS) that illuminates a low tire pressure telltale when one or more of your tires is significantly under-inflated. Accordingly, when the low tire pressure telltale illuminates, you should stop and check your tires as soon as possible, and inflate them to the proper pressure. Driving on a significantly under-inflated tire causes the tire to overheat and can lead to tire failure. Under-inflation also reduces fuel efficiency and tire tread life, and may affect the vehicle's handling and stopping ability.

Wheels and Tires

Please note that the TPMS is not a substitute for proper tire maintenance, and it is the driver's responsibility to maintain correct tire pressure, even if under-inflation has not reached the level to trigger illumination of the TPMS low tire pressure telltale.

Your vehicle has also been equipped with a TPMS malfunction indicator to indicate when the system is not operating properly. The TPMS malfunction indicator is combined with the low tire pressure telltale. When the system detects a malfunction, the telltale will flash for approximately one minute and then remain continuously illuminated. This sequence will continue upon subsequent vehicle start-ups as long as the malfunction exists.

When the malfunction indicator is illuminated, the system may not be able to detect or signal low tire pressure as intended. TPMS malfunctions may occur for a variety of reasons, including the installation of replacement or alternate tires or wheels on the vehicle that prevent the TPMS from functioning properly. Always check the TPMS malfunction telltale after replacing one or more tires or wheels on your vehicle to ensure that the replacement or alternate tires and wheels allow the TPMS to continue to function properly.

The tire pressure monitoring system complies with part 15 of the FCC rules and with RSS-210 of Industry Canada. Operation is subject to the following two conditions: (1) This device may not cause harmful interference, and (2) This device must accept any interference received, including interference that may cause undesired operation.

Changing Tires With a Tire Pressure Monitoring System



Note: Each road tire is equipped with a tire pressure sensor located inside the wheel and tire assembly cavity. The pressure sensor is attached to the valve stem. The pressure sensor is covered by the tire and is not visible unless the tire is removed. Take care when changing the tire to avoid damaging the sensor

You should always have your tires serviced by an authorized dealer.

Check the tire pressure periodically (at least monthly) using an accurate tire gauge. See *Inflating Your Tires* in this chapter.

Understanding Your Tire Pressure Monitoring System

The tire pressure monitoring system measures pressure in your four road tires and sends the tire pressure readings to your vehicle. The low tire pressure warning light will turn on if the tire pressure is significantly low. Once the light is illuminated, your tires are under-inflated and need to be inflated to the manufacturer's recommended tire pressure. Even if the light turns on and a short time later turns off, your tire pressure still needs to be checked.

Wheels and Tires

When Your Temporary Spare Tire is Installed

When one of your road tires needs to be replaced with the temporary spare, the system will continue to identify an issue to remind you that the damaged road wheel and tire assembly needs to be repaired and put back on your vehicle.

To restore the full function of the tire pressure monitoring system, have the damaged road wheel and tire assembly repaired and remounted on your vehicle.

When You Believe Your System is Not Operating Properly

The main function of the tire pressure monitoring system is to warn you when your tires need air. It can also warn you in the event the system is no longer capable of functioning as intended. See the following chart for information concerning your tire pressure monitoring system:

Wheels and Tires

Low tire pressure warning light	Possible cause	Customer action required
Solid warning light	Tire(s) under-inflated	Make sure tires are at the proper pressure. See Inflating your tires in this chapter. After inflating your tires to the manufacturer's recommended pressure as shown on the Tire Label (located on the edge of driver's door or the B-Pillar), the vehicle must be driven for at least two minutes over 20 mph (32 km/h) before the light turns off.
	Spare tire in use	Repair the damaged road wheel and tire assembly and reinstall it on the vehicle to restore system function. For a description on how the system functions, see When your temporary spare tire is installed in this section.
	TPMS malfunction	If the tires are properly inflated and the spare tire is not in use but the light remains on, contact your authorized dealer as soon as possible.
Flashing warning light	Spare tire in use	Repair the damaged road wheel and tire assembly and reinstall it on the vehicle to restore system function. For a description on how the system functions, see When your temporary spare tire is installed in this section.
	TPMS malfunction	If the tires are properly inflated and the spare tire is not in use but the light remains on, contact your authorized dealer as soon as possible.

When Inflating Your Tires

When putting air into your tires (such as at a gas station or in your garage), the tire pressure monitoring system may not respond immediately to the air added to your tires.

It may take up to two minutes of driving over 20 mph (32 km/h) for the light to turn off after you have filled your tires to the recommended inflation pressure

Wheels and Tires

How Temperature Affects Your Tire Pressure

The tire pressure monitoring system monitors tire pressure in each pneumatic tire. While driving in a normal manner, a typical passenger tire inflation pressure may increase about 2 to 4 psi (14 to 28 kPa) from a cold start situation. If the vehicle is stationary overnight with the outside temperature significantly lower than the daytime temperature, the tire pressure may decrease about 3 psi (21 kPa) for a drop of 30°F (17°C) in ambient temperature. This lower pressure value may be detected by the tire pressure monitoring system as being significantly lower than the recommended inflation pressure and activate the system warning light for low tire pressure. If the low tire

pressure warning light is on, visually check each tire to verify that no tire is flat. If one or more tires are flat, repair as necessary. Check the air pressure in the road tires. If any tire is under-inflated, carefully drive the vehicle to the nearest location where air can be added to the tires. Inflate all the tires to the recommended inflation pressure.

CHANGING A ROAD WHEEL

Important Information for Lifting or Jacking

WARNING



If you do not follow the guidelines it will result in extensive damage to the high voltage battery.

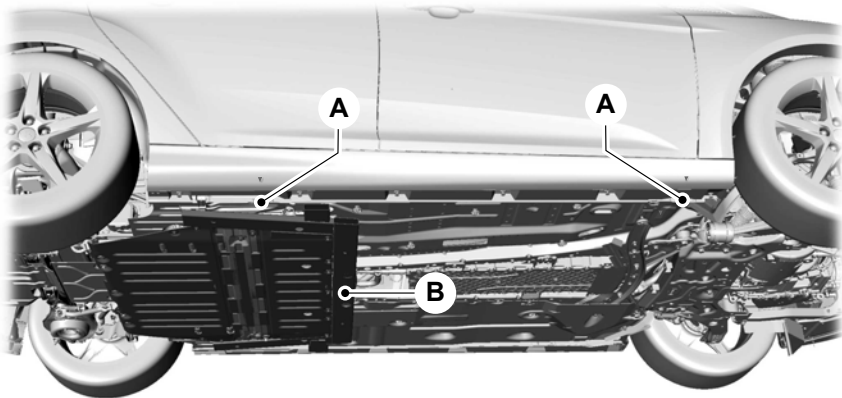

E167345

- A Lifting points
- B High voltage battery and support brace

If you need to use a jack or hoist to service your vehicle, make sure the lift pads do not contact the high voltage battery or support brace.

Wheels and Tires

The high voltage battery and support brace are very close to the rear lifting points. These points are identifiable by a triangle icon. Position the lift pads of the jack or hoist at the specified lifting points. Lifting your vehicle with the lift pads of the jack or hoist on the high voltage battery or the brace will damage the battery.

LUG NUTS

WARNING



When a wheel is installed, always remove any corrosion, dirt or foreign materials present on the mounting surfaces of the wheel or the surface of the wheel hub, brake drum or brake disc that contacts the wheel. Make sure that any fasteners that attach the rotor to the hub are secured so they do not interfere with the mounting surfaces of the wheel. Installing wheels without correct metal-to-metal contact at the wheel mounting surfaces can cause the wheel nuts to loosen and the wheel to come off while the vehicle is in motion, resulting in loss of control.

Retighten the lug nuts to the specified torque within 100 mi (160 km) after any wheel disturbance (such as tire rotation, changing a flat tire, wheel removal).

Bolt size	Wheel lug nut torque*
M12 x 1.5	100 lb.ft (135 Nm)

*Torque specifications are for nut and bolt threads free of dirt and rust. Use only Ford recommended replacement fasteners.



E145950

A Wheel pilot bore

Inspect the wheel pilot bore and mounting surface prior to installation. Remove any visible corrosion or loose particles.

Capacities and Specifications

MOTORCRAFT PARTS

Component	Part number
Battery	BXT-96R-500 BXT-96R-590
Windshield wiper blade	WW-2802 (driver side) WW-2803 (passenger side) WW-1204 (rear)
Cabin air filter	FP-70 (front) FP-75 (auxiliary A/C)

Capacities and Specifications

VEHICLE IDENTIFICATION NUMBER

The vehicle identification number is located on the left-hand side of the instrument panel.

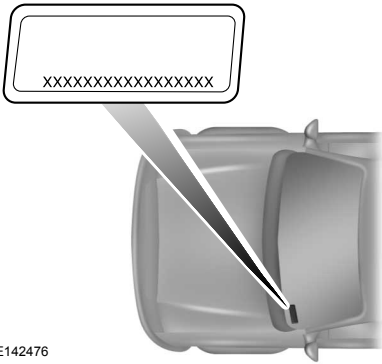

E142476

Please note that in the graphic, XXXX is representative of your vehicle identification number.

The Vehicle Identification Number contains the following information:

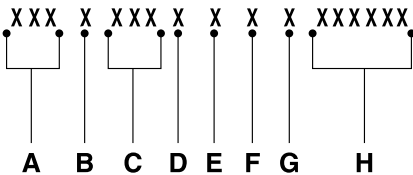

E142477

- A World manufacturer identifier
- B Brake system, Gross Vehicle Weight Rating, Restraint Devices and their locations

- C Make, vehicle line, series, body type
- D Engine type
- E Check digit
- F Model year
- G Assembly plant
- H Production sequence number

VEHICLE CERTIFICATION LABEL

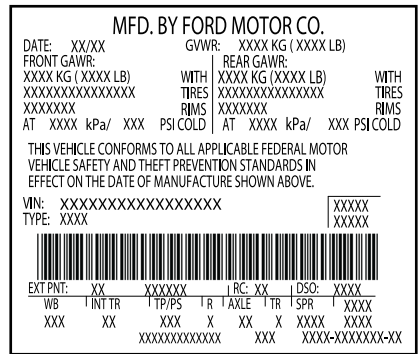

E167469

The National Highway Traffic Safety Administration Regulations require that a Safety Compliance Certification Label be affixed to a vehicle and prescribe where the Safety Compliance Certification Label may be located. The Safety Compliance Certification Label shall be affixed to either the door hinge pillar, the door latch post, or the edge of the door near the door latch, next to the driver's seating position.

Capacities and Specifications

TRANSMISSION CODE DESIGNATION

The transmission code is on the Safety Compliance Certification Label. The following table shows the transmission code along with the transmission description.

MFD. BY FORD MOTOR CO.

DATE: XX/XX GVWR: XXXX KG (XXXX LB)

FRONT GAWR: WITH REAR GAWR:

XXXX KG (XXXX LB) XXXX KG (XXXX LB) WITH

XXXXXXXXXXXXXXXXXX TIRES XXXXXXXXXXXXXXXX TIRES

XXXXXXXXXX RIMS XXXXXXXX RIMS

AT XXXX kPa/ XXX PSI COLD AT XXXX kPa/ XXX PSI COLD

THIS VEHICLE CONFORMS TO ALL APPLICABLE FEDERAL MOTOR
VEHICLE SAFETY AND THEFT PREVENTION STANDARDS IN
EFFECT ON THE DATE OF MANUFACTURE SHOWN ABOVE.

VIN: XXXXXXXXXXXXXXXXXXXX XXXXX
TYPE: XXXX XXXXX



EXT PNT: XX XXXXX RC: XX DSO: XXXX

WB INT TR TP/PS TR AXLE TR SPR XXXX XXXX

XXX XX XXX X XX X XXXX XXXX

XXXXXXXXXXXXX X XXXX-XXXXXX-XX

↑

E167814

Description	Code
One-speed automatic (TR-WA)	44H

Capacities and Specifications

Capacities

WARNING



The air conditioning refrigerant system contains refrigerant R-134a under high pressure. Opening the air conditioning refrigerant system can cause personal injury. Have the air conditioning refrigerant system serviced only by qualified personnel.

Item	Capacity
Electric powertrain assembly coolant	15.9 qt (15 L)
Brake fluid	Between MIN and MAX on brake fluid reservoir
Automatic transmission fluid ¹	1.3 qt (1.25 L)
Windshield washer fluid	Fill as required
A/C refrigerant	20.8 oz (0.59 kg)
A/C refrigerant compressor oil	5.2 fl oz (153 ml)

¹Approximate dry fill capacity. Actual amount may vary during fluid changes.

Specifications

Materials

Name	Specification
Coolant (U.S.): Motorcraft Orange Antifreeze/Coolant Prediluted VC-3DIL-B	WSS-M97B44-D2
Coolant (Canada): Motorcraft Orange Antifreeze/Coolant Prediluted CVC-3DIL-B	WSS-M97B44-D2
Brake fluid: Motorcraft DOT 4 Low Viscosity (LV) High Performance Motor Vehicle Brake Fluid PM-20	WSS-M6C65-A2
Automatic transmission fluid (U.S.): Motorcraft MERCON LV Automatic Transmission Fluid XT-10-QLVC	WSS-M2C938-A MERCON LV
Automatic transmission fluid (Canada):	WSS-M2C938-A

Capacities and Specifications

Name	Specification
Motorcraft MERCON LV Automatic Transmission Fluid CXT-10-LV12	MERCON LV
Windshield washer fluid (U.S.): Motorcraft Premium Windshield Wash Concentrate with Bitterant ZC-32-B2	WSS-M14P19-A
Windshield washer fluid (Canada): Motorcraft Premium Quality Windshield Washer Fluid CXC-37-(A, B, D, F)	WSS-M14P19-A
A/C refrigerant (U.S.): Motorcraft R-134a Refrigerant YN-19	WSH-M17B19-A
A/C refrigerant (Canada): Motorcraft R-134a Refrigerant CYN-16-R	WSH-M17B19-A
A/C refrigerant compressor oil: Motorcraft Electric A/C Compressor Oil YN-32	--
Multi-purpose grease: Motorcraft Multi-Purpose Grease Spray XL-5	ESB-MIC93-B
Lock cylinders (U.S.): Penetrating and Lock Lubricant XL-1	--
Lock cylinders (Canada): Penetrating Fluid CXC-51-A	--

Note: Ford recommends using DOT 4 Low Viscosity (LV) High Performance Brake Fluid or equivalent meeting WSS-M6C65-A2. Use of any fluid other than the recommended fluid may cause degraded brake performance and not meet the Ford performance standards. Keep brake fluid clean and dry. Contamination with dirt, water, petroleum products or other materials may result in brake system damage and possible failure.

Note: Automatic transmissions that require MERCON LV transmission fluid should only use MERCON LV transmission fluid. The use of any other fluid may cause transmission damage.

Audio System

GENERAL INFORMATION

Radio Frequencies and Reception Factors

AM and FM frequencies are established by the Federal Communications Commission (FCC) and the Canadian Radio and Telecommunications Commission (CRTC). Those frequencies are:

- AM: 530, 540-1700, 1710 kHz
- FM: 87.9-107.7, 107.9 MHz

Radio Reception Factors	
Distance and strength	The further you travel from an AM or FM station, the weaker the signal and the weaker the reception.
Terrain	Hills, mountains, tall buildings, bridges, tunnels, freeway overpasses, parking garages, dense tree foliage and thunderstorms can interfere with the reception.
Station overload	When you pass a ground-based broadcast repeating tower, a stronger signal may overtake a weaker one and result in the audio system muting.

CD and CD Player Information

Note: *CD units play commercially pressed 4.75-inch (12 centimeter) audio compact discs only. Due to technical incompatibility, certain recordable and re-recordable compact discs may not function correctly when used in Ford CD players.*

Note: *Do not insert CDs with homemade paper (adhesive) labels into the CD player as the label may peel and cause the CD to become jammed. You should use a permanent felt tip marker rather than adhesive labels on your homemade CDs. Ballpoint pens may damage CDs. Please contact an authorized dealer for further information.*

Note: *Do not use any irregularly shaped discs or discs with a scratch protection film attached.*

Always handle discs by their edges only. Clean the disc with an approved CD cleaner only. Wipe it from the center of the disc toward the edge. Do not clean in a circular motion.

Do not expose discs to direct sunlight or heat sources for extended periods.

MP3 Track and Folder Structure

Audio systems capable of recognizing and playing MP3 individual tracks and folder structures work as follows:

- There are two different modes for MP3 disc playback: MP3 track mode (system default) and MP3 folder mode.
- MP3 track mode ignores any folder structure on the MP3 disc. The player numbers each MP3 track on the disc (noted by the .mp3 file extension) from T001 to a maximum of T255. The maximum number of playable MP3 files may be less depending on the structure of the CD and exact model of radio present.

Audio System

- MP3 folder mode represents a folder structure consisting of one level of folders. The CD player numbers all MP3 tracks on the disc (noted by the .mp3 file extension) and all folders containing MP3 files, from F001 (folder) T001 (track) to F253 T255.
- Creating discs with only one level of folders helps with navigation through the disc files.

If you are burning your own MP3 discs, it is important to understand how the system reads the structures you create. While various files may be present, (files with extensions other than mp3), only files with the .mp3 extension are played; other files are ignored by the system. This enables you to use the same MP3 disc for a variety of tasks on your work computer, home computer and your in-vehicle system.

In track mode, the system displays and plays the structure as if it were only one level deep (all .mp3 files play, regardless of being in a specific folder). In folder mode, the system only plays the .mp3 files in the current folder.

AUDIO UNIT - VEHICLES WITH: SONY AUDIO SYSTEM

WARNING



Driving while distracted can result in loss of vehicle control, crash and injury. We strongly recommend that you use extreme caution when using any device that may take your focus off the road. Your primary responsibility is the safe operation of your vehicle. We recommend against the use of any hand-held device while driving and encourage the use of voice-operated systems when possible. Make sure you are aware of all applicable local laws that may affect the use of electronic devices while driving.

Note: *The MyFord Touch system controls most of the audio features. See **Entertainment** (page 254).*

Audio System

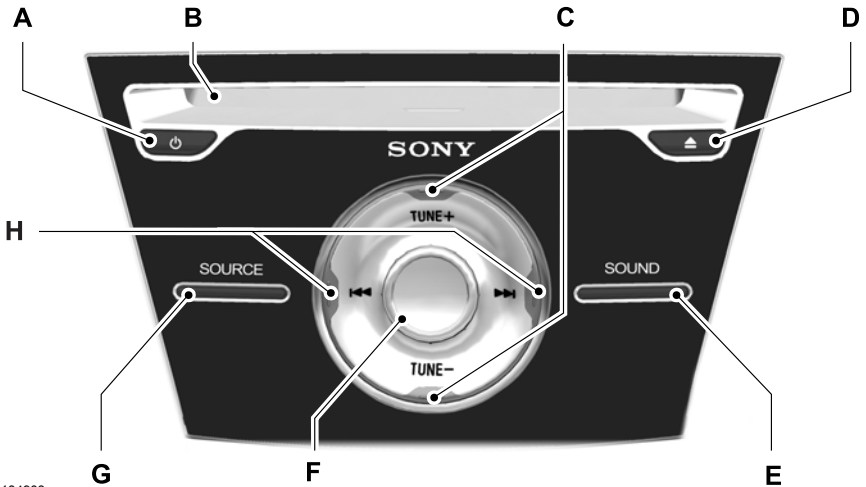

E184903

- A **Power:** Press this button to switch the system off and on.
- B **CD slot:** Insert a CD.
- C **TUNE +/-:** In radio mode, press this button to manually search through the radio frequency band. In SIRIUS mode, press this button to find the previous or next available satellite radio station.
- D **Eject:** Press this button to eject a CD.
- E **SOUND:** Press this button to access settings for Treble, Midrange, Bass, Balance and Fade.
- F **Volume:** Turn this control to adjust the volume.
- G **SOURCE:** Press this button to access different audio modes, such as AM, FM, Satellite Radio, and Line in.
- H **Seek, Fast Forward and Reverse:** In radio mode, select a frequency band and press this button. The system stops at the first station it finds in that direction. In SIRIUS mode, press this button to select the next or previous satellite radio station. If a specific category is selected (such as Jazz, Rock or News), use this button to find the next or previous in the selected category. In CD mode, press this button to select the previous or next track. Press and hold the fast forward button to move quickly forward through the current track.

Audio System

MEDIA HUB (If Equipped)

The media hub is located in the center console and has the following features:

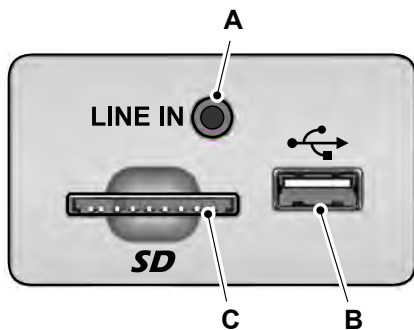

E176343

- A Auxiliary input jack (Line in).
- B USB port.
- C SD card slot.

See **Entertainment** (page 254).

Note: Additional USB ports may be located in other areas of your vehicle.

MyFord Touch™

GENERAL INFORMATION

WARNING



Driving while distracted can result in loss of vehicle control, crash and injury. We strongly recommend that you use extreme caution when using any device that may take your focus off the road. Your primary responsibility is the safe operation of your vehicle. We recommend against the use of any hand-held device while driving and encourage the use of voice-operated systems when possible. Make sure you are aware of all applicable local laws that may affect the use of electronic devices while driving.

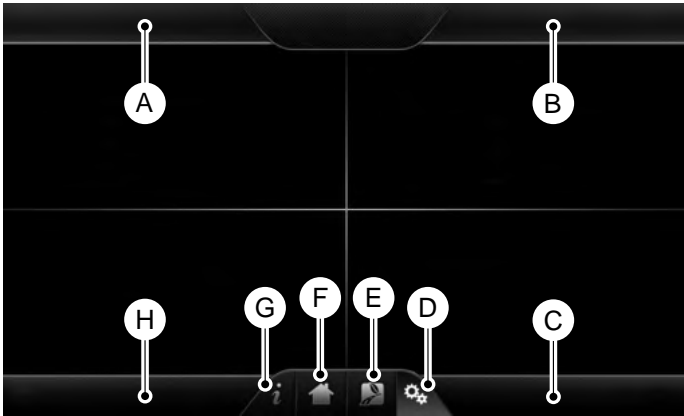

E161890

Item	Message
A	Phone
B	Navigation
C	Climate
D	Settings
E	EV Information

Item	Message
F	Home
G	Information
H	Entertainment

MyFord Touch™

This system uses a four-corner strategy to provide quick access to several vehicle features and settings. The touchscreen provides easy interaction with your cell phone, entertainment, information and system settings. The corners display active modes within the menus, for example; your cell phone's status.

Note: *Some features are not available while your vehicle is moving.*

Note: *You can access the entertainment features for 30 minutes after you switch the ignition off, and no doors are opened.*

Phone

Press to select any of the following:

Message
Phone
Quick Dial
Phonebook
History
Messaging
Settings

Navigation

Press to select any of the following:

Message
My Home
Favorites
Previous Destinations
Point of Interest
Emergency
Street Address
Intersection

Message
City Center
Map
Edit Route
Cancel Route

CLIMATE

Press the corresponding icons to control the following options:

- Driver Settings
- Recirculated Air
- Auto
- Dual
- Passenger Settings
- A/C
- Defrost

Settings



Press to select any of the following:

Message
Clock
Display
Sound
Vehicle
Settings
Help

MyFord Touch™

EV Information



Press to access features specific to your electric vehicle.

Home



Press to access the home screen.

Note: Depending on your vehicle's option package and software, the screens may vary in appearance from the descriptions in this section. The features may also be limited depending on the market. Check with an authorized dealer for availability.

Information



Press to select any of the following:

Message
Services
Travel Link
Alerts
Calendar
Apps

Entertainment

Press to select any of the following:

Message
AM
FM
SIRIUS
CD
USB
BT Stereo
SD Card
Line In

Using the Audio Controls

Depending on your vehicle, it may also have the following controls:

Message	Action and Description
Power	Switch the media features on or off.
Vol:	Adjust the volume of playing media.
Tune	Use as you normally would in media modes.
Eject	Eject a CD from the entertainment system.

MyFord Touch™

Message	Action and Description
Display	Press this button to switch the display screen off. Press again, or touch the screen to switch the display screen on.
Source	Touch the control repeatedly to switch between media modes.
Sound	Adjust the settings for: <ul style="list-style-type: none">• Bass• Treble• Midrange• Balance• Fade• DSP (Digital Signal Processing)• Occupancy Mode• Speed Compensated Volume.

Using the Steering Wheel Controls

Depending on your vehicle, it may also have the following controls:

Control	Action and Description
VOL	Adjust the volume of playing media.
Voice	Press to start a voice session. Press again to interrupt a voice prompt and begin speaking. Press and hold to end an active voice session.
Seek and Call Accept	Use as you normally would in media and phone modes.
Seek and Call Reject	Use as you normally would in media and phone modes.

Using the Touchscreen

- Make sure your hands are clean and dry.
- Press firmly on the center of a control graphic or menu item.
- Keep metal objects or other conductive material away from the surface of the touchscreen.

Cleaning the Touchscreen Display

Use a clean, soft cloth such as one used for cleaning glasses. If dirt or fingerprints are still visible, apply a small amount of alcohol to the cloth. Do not pour or spray alcohol onto the display. Do not use detergent or any type of solvent to clean the display.

MyFord Touch™

Support

The SYNC support team is available:

- Monday-Saturday, 8:30am-8:00pm EST.
- United States: 1-888-270-1055
- Canada: 1-800-565-3673

Note: *Times are subject to change due to holidays.*

Safety Information

WARNING



Driving while distracted can result in loss of vehicle control, crash and injury. We strongly recommend that you use extreme caution when using any device that may take your focus off the road. Your primary responsibility is the safe operation of your vehicle. We recommend against the use of any hand-held device while driving and encourage the use of voice-operated systems when possible. Make sure you are aware of all applicable local laws that may affect the use of electronic devices while driving.

- Do not attempt to service or repair the system. Have your vehicle checked by an authorized dealer.
- Do not operate media devices if the power cables are broken or damaged.

- Make sure the power cables do not interfere with the safe operation of your vehicle's controls or affect your safe driving abilities.
- Some SYNC functions are speed-dependent. Their use is limited to when your vehicle is traveling at speeds below 3 mph (5 km/h).

Make sure that you review your device's manual before using it with SYNC.

Speed-restricted Features

Some features of this system are restricted from use unless your vehicle is stationary.

- Screens crowded with information, for example:
 - Point of Interest reviews and ratings
 - SIRIUS Travel Link sports scores
 - Movie times
 - Ski conditions.
- Any action that requires keyboard use, for example: entering a navigation destination or editing information.
- All lists are limited, for example: phone contacts.

See the following chart for more specific examples.

Speed-restricted Features	
Cell phone	Pairing a cell phone
	Adding or editing phonebook contacts
	Phone contacts and recent phone call entries
System Functionality	Enabling Valet Mode
	Editing settings while the rear view camera or active park assist are active
Wi-Fi and Wireless	Editing wireless settings

MyFord Touch™

Speed-restricted Features	
	Editing the list of wireless networks
Photos and Graphics	Adding or editing wallpaper
Text Messages	Composing text messages
	Viewing received text messages
	Editing preset text messages
Navigation	Using the keyboard to enter a destination
	Demo navigation route
	Adding or editing Address Book or Avoid Area entries

Privacy Information

When you connect a cell phone to SYNC, the system creates a profile within your vehicle that links to that cell phone. This profile helps in offering you more cellular features and operating more efficiently. Among other things, this profile may contain data about your cell phone book, text messages (read and unread), and call history, including history of calls when your cell phone was not connected to the system. In addition, if you connect a media device, the system creates and retains an index of supported media content. The system also records a short development log of approximately 10 minutes of all recent system activity. The log profile and other system data may be used to improve the system and help diagnose any problems that may occur.

The cellular profile, media device index, and development log remain in your vehicle unless you delete them, and are generally accessible only in your vehicle when your cell phone or media player is connected. If you no longer plan to use the system or your vehicle, we recommend you carry out a Master Reset to erase all stored information.

System data cannot be accessed without special equipment and access to your vehicle's SYNC module. Ford Motor Company and Ford of Canada do not access the system data for any purpose other than as described without consent, a court order, or where required by law enforcement, other government authorities, or other third parties acting with lawful authority. Other parties may seek to access the information independently of Ford Motor Company and Ford of Canada. For further privacy information, see the sections on 911 Assist®, Vehicle Health Report, and Traffic, Directions and Information.

MyFord Touch™

Accessing and Adjusting Modes Through Your Right Vehicle Information Display

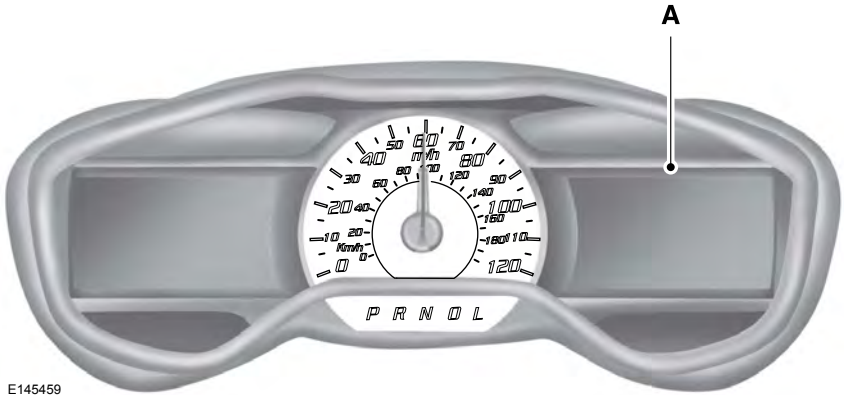

E145459

The display is located on the right side of your instrument cluster (A). You can use your steering wheel controls to view and make minor adjustments to active modes without taking your hands off the wheel. For example:

- In Entertainment mode, you can view what is now playing, change the audio source, select memory presets and make some adjustments.
- In Phone mode, you can accept or reject an incoming call.
- In Navigation mode, you can view the current route or activate a route.
- In Surplus mode, either butterflies or a gauge represent surplus or status. The number of butterflies matches the current surplus or status distance up to a maximum of sixteen butterflies. If you entered your next charge destination in the navigation system and you see butterflies on your screen, then you should be able to make your destination (you have a Surplus). If you

see butterflies but did not enter your next charge destination, then you should be able to achieve the range estimate shown at the start of your drive (you have a positive Status). See **Instrument Cluster** (page 81).

When you enter or switch off the vehicle, you have the opportunity to view charging status, charge start and end times as well as the charging mode. You can also switch your charging mode between Value Charge and Charge Now. See **High Voltage Battery** (page 115).



E144811

Use the **OK** and arrow buttons on the right side of your steering wheel to scroll through the available modes:

The selection menu expands and different options appear.

- Press the up and down arrows to scroll through the modes.
- Press the right arrow to enter the mode.
- Press the left or right arrows to make adjustments within the chosen mode.
- Press **OK** to confirm your selection.

Using Voice Commands

This system helps you control many features using voice commands. This allows you to keep your hands on the wheel and focus on what is in front of you. The system provides feedback through audible tones, prompts, questions and spoken confirmations depending on the situation and the chosen level of interaction (voice settings).

The system also asks short questions (confirmation prompts) when it is not sure of your request or when there are multiple possible responses to your request.

When using voice commands, words and icons may appear in the lower left status bar indicating the status of the voice command session (such as Listening, Success, Failed, Paused or Try Again).

How to Use Voice Commands



The following are some of the voice commands that you can say at any time during a voice command session.

Press the voice button and when prompted say:

Voice command
Main Menu
What Can I Say
Previous Page
Go Back
Help

Helpful Hints

- Make sure the interior of your vehicle is as quiet as possible. Wind noise from open windows and road vibrations may prevent the system from correctly recognizing spoken voice commands.
- After pressing the voice command icon, wait until after the tone sounds and a message appears before saying a voice command. Any voice command spoken prior to this does not register with the system.
- Speak naturally, without long pauses between words.
- At any time, you can interrupt the system while it is speaking by pressing the voice command icon.

Accessing a List of Available Voice Commands

To access a list of available voice commands you can do either of the following.

MyFord Touch™

Using the touchscreen, press:

Menu Item
Settings
Help
Voice Command List

Using the steering wheel control, press the voice button and when prompted say one of the following:

Voice Commands
List of Commands
Radio List of Commands
Phone List of Commands
Voice Instructions List of Commands

Voice Command Settings

These allow you to customize the level of system interaction, help and feedback. The system defaults to standard interaction that uses candidate lists and confirmation prompts as these provide the highest level of guidance and feedback.

Menu Item	Action and Description	
Interaction Mode	Novice	In this mode the system provides detailed interaction and guidance.
	Advanced	This mode has less audible interaction and more tone prompts.
Confirmation Prompts	The system uses these short questions to confirm your voice command. If turned off, the system simply makes a best guess as to what you requested. The system may still occasionally ask you to confirm a voice command.	
Phone Candidate Lists	Candidate lists are lists of possible results from your voice commands. The system creates these lists when it has the same confidence level of several options based on your voice command.	
Media Candidate Lists		

MyFord Touch™

Using the touchscreen, press the settings icon, then press:

Menu Item
Voice Settings
Voice Control
Select from the following:
Interaction Mode
Confirmation Prompts
Media Candidate Lists
Phone Candidate Lists
Voice Control Volume

Using Voice Commands with the Touchscreen Options

The voice command system has a dual mode feature which allows you to switch between using voice commands and making on-screen selections. This is available only when the system displays a list of candidates generated during a voice command session. For example, this can be used when entering a street address or trying to call a contact from a cell phone paired to the system.

SETTINGS



E161968

MyFord Touch™

Item	Menu Item
A	Clock
B	Display
C	Sound
D	Vehicle
E	Settings
F	Help

Clock



Under this menu, you can set the clock, access and adjust the display, sound and vehicle settings as well as access settings for specific modes or the help feature.

To make adjustments using the touchscreen, select:

Menu Item	Action and Description
Settings	Press the settings icon.
Clock	Press the + or - to adjust the time. From this screen, you can also make other adjustments such as 12-hour or 24-hour mode, activate GPS time synchronization and have the system automatically update new time zones. You can also switch the outside air temperature display off and on. It appears at the top center of the touchscreen, next to the time and date.

Note: You cannot manually set the date. Your vehicle's GPS does this for you.

Note: If the battery has been disconnected, your vehicle needs to acquire a GPS signal to update the clock. Once your vehicle acquires the signal, it may take a few minutes for the update to display the correct time.

Display



You can adjust the display using the touchscreen or the voice button on the steering wheel controls.

MyFord Touch™

To make adjustments using the touchscreen, select:

Menu Item	Action and Description	
Settings	Press the settings icon.	
Display		
Then select from the following:		
Mode	Allows you to switch the display off. It also allows you to set the screen to a certain brightness or have the system automatically change based on the outside light level. If you also select:	
	Auto	These features will allow you to adjust the dimming of your screen.
	Night	
Edit Wallpaper	Allows you to display the default photo or upload your own.	
Auto Dim	When set to On , lets you use the Auto Dim Manual Offset feature. When Auto Dim is set to Off you are able to adjust the brightness of the screen.	
	Brightness	Make the screen display brighter or dimmer.
Auto Dim Manual Offset	Allows you to adjust screen dimming as the outside lighting conditions change from day to night.	



To make adjustments using the voice button, press the button and when prompted, say:

Voice command
Display Settings

Uploading Photos for Your Home Screen Wallpaper

Note: You cannot load photos directly from your camera. You must access the photos either from your USB mass storage device or from an SD card.

Note: Photographs with extremely large dimensions (such as 2048 x 1536) may not be compatible and appear as a blank (black) image on the display.

The system allows you to upload and view up to 32 photos.



To access, press:

MyFord Touch™

To upload your photos, select:

Message	Action and Description
Settings	Press the settings icon.
Display	
Edit Wallpaper	Follow the system prompts to upload your photographs.

Only the photograph(s), which meet the following conditions display:

- Compatible file formats are as follows: JPEG, GIF, PNG, BPM.
- Each file must be 1.5 MB or less.
- Recommended dimensions: 800 x 384.

Sound



To make adjustments using the touchscreen, select:

Menu Item
Settings
Sound
Then select from the following:
Bass
Midrange
Treble
Set Balance and Fade
Occupancy Mode
EQ Mode
Speed Compensated Volume

Note: Your vehicle may not have all of these sound settings.

Vehicle



MyFord Touch™

To make adjustments using the touchscreen, select:

Menu Item
Settings
Vehicle
Then select from the following:
Ambient Lighting

Menu Item
Camera Settings
Enable Valet Mode
Charge Port Light Ring

Ambient Lighting (If Equipped)

When you switch this feature on, ambient lighting illuminates footwells and cupholders with a choice of colors. To access and make adjustments:

To make adjustments using the touchscreen, select:

Menu Item	Action and Description
Settings	Press the settings icon.
Vehicle	
Ambient Lighting	

- You can then touch the desired color.
- Use the scroll bar to increase or decrease the intensity.
- To switch the feature on or off, press the power button.

Vehicle Health Report

To make adjustments using the touchscreen, select:

Message	Action and Description
Settings	Press the settings icon.
Vehicle	
Vehicle Health Report	
Automatic Reminders Mileage Interval	Turn on and off and set the mileage interval at which you would like to receive the reports. Press the ? for more information on these selections.
Run Vehicle Health Report Now	To run the vehicle health report immediately.

You can find more information on Vehicle Health Report in this chapter.

MyFord Touch™

Camera Settings



This menu allows you to access settings for your rear view camera.

To make adjustments using the touchscreen, select:

Menu Item	Action and Description
Settings	Press the settings icon.
Vehicle	
Camera Settings	

Then select from the following:

Enhanced Park Aids	
Rear Camera Delay	

You can find more information on the rear view camera system in another chapter. See **Parking Aids** (page 129).

Enable Valet Mode



Valet mode allows you to lock the system. No information is accessible until the system is unlocked with the correct PIN.

Note: If the system locks, and you need to reset the PIN, enter 3681 and the system unlocks.

To make adjustments using the touchscreen, select:

Menu Item	Action and Description
Settings	Press the settings icon.
Vehicle	
Enable Valet Mode	Then enter a four digit PIN twice, as prompted.
Continue	After you press Continue the system locks until you enter the PIN again.

Charge Point Light Ring



MyFord Touch™

To make adjustments using the touchscreen, select:

Menu Item	Action and Description
Settings	
Vehicle	
Charge Port Light Ring	
You can then select:	
On	Illuminates when plugging in, opening doors, pressing the unlock button on your remote and while charging.
Off	Does not illuminate.
Limited	Illuminates only when plugging in, opening doors, or pressing the unlock button on your remote.

Note: Details on the charge port light ring functions are in another chapter. See **High Voltage Battery** (page 115).

System



Settings

Access and adjust system settings, voice features, as well as phone, navigation and wireless settings.

To make adjustments using the touchscreen, select:

Message	Action and Description
Settings	Press the settings icon.
System	
Then select from the following:	
Language	Select to have the touchscreen display in English, Spanish or French.
Distance	Select to display units in kilometers or miles.
Temperature	Select to display units in Celsius or Fahrenheit.
System Prompt Volume	Adjust the volume of voice prompts from the system.
Touch Screen Button Beep	Select to have the system beep to confirm choices made through the touchscreen.

MyFord Touch™

Message	Action and Description
Keyboard Layout	Have the touchscreen keyboard display in QWERTY or ABC format.
Install Applications	Install any downloaded applications or view the current software licenses.
Master Reset	Select to restore factory defaults. This erases all personal settings and personal data.

Voice Control



To make adjustments using the touchscreen, select:

Message	Action and Description
Settings	
Voice Settings	

Then select from the following:

Interaction Mode	Standard interaction mode provides more detailed interaction and guidance. Advanced mode has less audible interaction and more tone prompts.
Confirmation Prompts	Have the system ask you short questions if it has not clearly heard or understood your request. Note: Even with confirmation prompts turned off, the system may occasionally ask you to confirm settings.
Media Candidate Lists	Candidate lists are possible results from your voice commands. The system simply makes a best guess at your request with these turned off.
Phone Candidate Lists	Candidate lists are possible results from your voice commands. The system simply makes a best guess at your request with these turned off.
Voice Control Volume	This allows you to adjust the system's voice volume level.

MyFord Touch™

Media Player



To make adjustments using the touchscreen, select:

Message	Action and Description
Settings	Press the settings icon.
Media Player	
Then select from the following:	
Autoplay	When this feature is on, the system automatically switches to the media source upon initial connection. This allows you to listen to music during the indexing process. When this feature is off, the system does not automatically switch to the inserted media source.
Bluetooth Devices	Select to connect, disconnect, add or delete a device. You can also set a device as your favorite so that the system automatically attempts to connect to that device at every ignition cycle.
Index Bluetooth Audio Devices	When this feature is on, the system automatically indexes media on your connected Bluetooth device.
Gracenote® Database Info	This allows you to view the version level of the Gracenote Database.
Gracenote® Management	With this feature on, the Gracenote Database supplies metadata information for your music files. This overrides information from your device. This feature defaults to off.
Cover Art Priority	With this feature on, the Gracenote Database supplied cover art for your music files. This overrides any art from your device. This feature defaults to Media Player.

Navigation



MyFord Touch™

To make adjustments using the touchscreen, select:

Message	Action and Description		
Settings	Press the settings icon.		
Navigation			
Then select from the following:			
Map Preferences	Turn breadcrumbs on and off.		
	Have the system display your turn list top to bottom or bottom to top.		
	Turn the Parking POI notification on and off.		
	Turn estimated driving range rings on and off.		
Route Preferences	Select which type of route you want the system to display first. You can select from the following options:	Shortest Route	
		Fastest Route	
		Eco Route	
	Always use preferred route	If set to yes, the system will only calculate a single route. This speeds up your destination entry process.	
	Eco Time Penalty	allows you to select the level of cost for the calculated Eco Route. The higher the setting, the longer the time allotment is for the route. This may incur a time penalty.	
	Have the system avoid freeways.		
	Have the system avoid toll roads.		
	Have the system avoid ferries or car trains.		
	Have the system use HOV (high-occupancy vehicle) lanes.		
Navigation Preferences	Have the system use guidance prompts.		
	Have the system automatically fill-in State/Province information.		
Traffic Preferences	Have the system avoid traffic problems automatically.		
	Turn traffic alert notifications on or off.		
	Have the system display accident icons.		

MyFord Touch™

Message	Action and Description
	Have the system display traffic jam icons.
	Have the system display closed roads.
	Have the system display areas where difficult driving conditions may occur.
	Have the system display areas where snow and ice on the road may occur.
	Have the system display any smog alerts.
	Have the system display weather warnings.
	Have the system display where there may be reduced visibility.
	Have the system turn on your radio for traffic announcements.
Avoid Areas	Enter specific areas that would like to avoid on planned navigation routes.

Phone



To make adjustments using the touchscreen, select:

Message	Action and Description
Settings	Press the settings icon.
Phone	
Then select from the following:	
Bluetooth Devices	Connect, disconnect, add or delete a device, as well as save it as a favorite.
Bluetooth	Turn Bluetooth on and off.
Do Not Disturb	Have all calls go directly to your voice mail and not ring inside your vehicle. With this feature turned on, text message notifications are also suppressed and do not ring inside your vehicle.
911 Assist	Turn on or turn off the 911 Assist feature. See Information (page 292).

MyFord Touch™

Message	Action and Description
Phone Ringer	Select the type of notification for phone calls - ring tone, beep, text to speech or silent.
Text Message Notification	Select the type of notification for text messages - alert tone, beep, text to speech, or have it be silent.
Internet Data Connection	If compatible with your phone, you can adjust your internet data connection. Select to make your connection profile with the personal area network or to turn off your connection. You can also choose to adjust your settings or have the system always connect, never connect when roaming, or query on connect. Press ? for more information.
Manage Phonebook	Access features, such as automatic phonebook download, re-download your phonebook, add contacts from your phone as well as delete or upload your phonebook.
Roaming Warning	Have the system alert you when in Roaming mode.

Wireless & Internet



Your system has a Wi-Fi feature that creates a wireless network within your vehicle, thereby allowing other devices (such as personal computers or phones) in your vehicle to speak to each other, share files or play

games. Using this Wi-Fi feature, everyone in your vehicle can also access the internet if you have a USB mobile broadband connection inside your vehicle, your phone supports personal area networking or if you park outside a wireless hotspot.

To make adjustments using the touchscreen, select:

Menu Item	Action and Description
Settings	Press the settings icon.
Wireless & Internet	

Then select from the following:

Wi-Fi Settings	Wi-Fi Network (Client) Mode
	Turns the Wi-Fi feature on and off in your vehicle. Make sure you switch it on for connectivity purposes.
	Choose a Wireless Network

MyFord Touch™

Menu Item	Action and Description
	<p>Allows you to use a previously stored wireless network. You can categorize by alphabetical listing, priority and signal strength. You can also choose to search for a network, connect to a network, disconnect from a network, receive more information, prioritize a network or delete a network.</p> <p>Gateway (Access Point) Mode</p> <p>Makes SYNC an access point for a phone or a computer when turned on. This forms the local area network within your vehicle for things, such as game playing, file transfer and internet browsing. Press ? for more information.</p> <p>Gateway (Access Point) Settings</p> <p>Allows you to view and change settings for using SYNC as the internet gateway.</p> <p>Gateway (Access Point) Devices List</p> <p>Allows you to view recent connections to your Wi-Fi system.</p>
USB Mobile Broadband	<p>Instead of using Wi-Fi, your system can also use a USB mobile broadband connection to access the internet. (You must switch on your mobile broadband device on your personal computer before connecting it to the system.) This screen allows you to set up what is your typical area for your USB mobile broadband connection. (USB mobile broadband settings may not display if the device is already on.) You can select the following:</p> <p>Country</p> <p>Carrier</p> <p>Phone Number</p> <p>User Name</p> <p>Password</p>
Bluetooth Settings	<p>Shows you the currently paired devices as well as giving you your typical Bluetooth options to connect, disconnect, set as favorite, delete and add device. Bluetooth is a registered trademark of the Bluetooth SIG.</p>
Prioritize Connection Methods	<p>Choose your connection methods and change them as needed. You can select to change order and have the system either always attempt to connect using a USB, mobile broadband, or using Wi-Fi.</p>

MyFord Touch™



The Wi-Fi CERTIFIED Logo is a certification mark of the Wi-Fi Alliance.

Help



E142626

To make adjustments using the touchscreen, select:

Menu Item	Action and Description
Settings	Press the settings icon.
Help	
Then select from the following:	
System Information	Touchscreen system serial number
	Vehicle Identification Number (VIN)
	Touchscreen system software version
	Navigation system version
	Map database version
	Sirius satellite radio ESN
	Gracenote® Database Information and Library version
	Modem Electronic Serial Number
View Software Licenses	View the licenses for any software and applications installed on your system.
Driving Restrictions	Certain features are not accessible when your vehicle is moving.
911 Assist	Switch on and off the Emergency Assistance feature. See Information (page 292).
	In Case of Emergency (ICE) Quick Dial

MyFord Touch™

Menu Item	Action and Description	
		The ICE contacts you select appear at the end of the Emergency Assistance call process.
	Edit	Select to access your phone-book and then select the desired contacts. The numbers then appear as options on this screen for the ICE 1 and ICE 2 buttons.
Voice Command List	View categorized lists of voice commands.	

You can also access Help using the voice commands. The system provides allowable voice commands for the current mode.



Press the voice button and when prompted say:

Voice command
Help

ENTERTAINMENT



E161892

MyFord Touch™

Message	Message and Description
A	AM
B	FM
C	SIRIUS
D	CD
E	USB
F	Touch this button to scroll down for more options, for example SD Card and Line In
G	These buttons change with the media mode you are in.
H	Radio memory presets.

Note: Some features may not be available in your area. Contact an authorized dealer for more information.

You can access these options using the touchscreen or voice commands.

AM/FM Radio



The following controls are available for AM/FM radio

Item	Action and Description
AM	Touch either tab to listen to the radio. To change between AM and FM presets, just touch the AM or FM tab.
FM	
Presets	Save a station by pressing and holding one of the memory preset areas. There is a brief mute while the radio saves the station. Sound returns when finished.
HD Radio	Touch this button to turn HD Radio on. The light on the button illuminates when the feature is on. HD Radio allows you to receive radio broadcasts digitally, where available, providing free, crystal-clear sound. See HD Radio information later in this chapter.
Scan	Touch this button to go to the next strong AM or FM radio station. The light on the button illuminates when the feature is on.
Direct Tune	Touch this button to manually enter the desired station number. Touch Enter when you are done.

MyFord Touch™

Options

You can make adjustments to the following options:

Menu Item	Action and Description
Sound Settings	Bass
	Midrange
	Treble
	Set Balance and Fade
	DSP
	Occupancy Mode
	Speed Compensated Volume
Set PTY for Seek / Scan	This allows you to select a category of music you would like to search for. You can then choose to either seek or scan for the stations playing that category.
RDS Text Display	This allows you to view the information broadcast by FM stations.
AST	This allows you to have the system automatically store the six strongest stations in your current location.
TAG Button	This feature is available when HD Radio is on, and allows you to tag a song to download later. When you select On, TAG appears on-screen when HD Radio is active. You can touch TAG to save the information of the song that is playing. When you plug in your portable music player, the information transfers, if supported by your device. When you are connected to iTunes, the tags appear to remind you of the songs you would like to download. See HD Radio information later in this chapter.

Note: *Your vehicle may not have all these sound settings.*

HD Radio™ Information (If Available)

Note: *HD Radio broadcasts are not available in all markets.*

HD Radio technology is the digital evolution of analog AM/FM radio. Your system has a special receiver that allows it to receive digital broadcasts (where available) in addition to the analog broadcasts, it already receives. Digital broadcasts provide a better sound quality

than analog broadcasts with free, crystal-clear audio and no static or distortion. For more information, and a guide to available stations and programming, please visit www.hdradio.com.

When HD Radio is on and you tune to a station broadcasting HD Radio technology, you may notice the following indicators on your screen:

MyFord Touch™



E142616

The HD logo either blinks when acquiring a digital station, and then stays solid when digital audio is playing, or is grey when acquiring a digital station, and then changes to orange when digital audio is playing. When this logo is available, you may also see Title and Artist fields

on-screen.

The multicast indicator appears in FM mode (only) if the current station is broadcasting multiple digital broadcasts. The highlighted numbers signify available digital channels where new or different content is available. HD1 signifies the main programming status and is available in analog and digital broadcasts. Other multicast stations (HD2 through HD7) are only available digitally.

TAG allows you to save a song to download later when you are on an acquired HD Radio station and the feature is on.

To turn the feature on and use it, select AM or FM and the select:

Message	Action and Description
Options	
TAG Button	
On	When you hear a song you, select:
TAG	The system automatically saves the song's information and transfers it to your portable music player (if supported) when you connect it to the system. The system automatically transfers the tag to your player (if already connected) and a pop-up confirms the transfer. When you access iTunes with your portable music player, the tags appear to you as a reminder. The system allows you to tag up to approximately 100 songs. For a list of devices that support tagging, see www.SYNCMYride.com , www.SYNCMYride.ca or www.syncmaroute.ca

MyFord Touch™

When HD Radio broadcasts are active, you can access the following functions:

Message	Action and Description
Scan	Allows you to hear a brief sampling of all available stations. This feature still works when HD Radio reception is on, although it does not scan for HD2-HD7 channels. You may see the HD logo appear if the station has a digital broadcast.
Presets	Allows you to save an active channel as a memory preset. Touch and hold a memory preset slot until the sound returns. There is a brief mute while the radio saves the station. Sound returns when finished. When switching to an HD2 or HD3 memory preset, the sound mutes before the digital audio plays, because the system has to reacquire the digital signal.

Note: As with any saved radio station, you cannot access the saved station if your vehicle is outside the station's reception area.

HD Radio Reception and Station Troubleshooting

Potential reception issues	
Reception area	If you are listening to a multicast station and you are on the fringe of the reception area, the station may mute due to weak signal strength.
	If you are listening to HD1, the system switches back to the analog broadcast until the digital broadcast is available again. However, if you are listening to any of the possible HD2-HD7 multicast channels, the station mutes and stays muted unless it is able to connect to the digital signal again.
Station blending	When the system first receives a station (aside from HD2-HD7 multicast stations), it first plays the station in the analog version. Once the receiver verifies the station is an HD Radio station, it shifts to the digital version. Depending on the station quality, you may hear a slight sound change when the station changes from analog to digital. Blending is the shift from analog to digital sound or digital back to analog sound.

In order to provide the best possible experience, use the contact form to report any station issues found while listening to a station broadcasting with HD Radio technology. Independent entities own and operate each station. These stations are responsible for ensuring all audio streams and data fields are accurate.

MyFord Touch™

Potential station issues		
Issues	Cause	Action
Echo, stutter, skip or repeat in audio. Increase or decrease in audio volume.	This is poor time alignment by the radio broadcaster.	No action required. This is a broadcast issue.
Sound fading or blending in and out.	The radio is shifting between analog and digital audio.	No action required. The reception issue may clear up as you continue to drive.
There is an audio mute delay when selecting HD2 or HD3, multicast preset or Direct Tune.	The digital multicast is not available until the HD Radio broadcast is decoded. Once decoded, the audio is available.	No action required. This is normal behavior. Wait until the audio is available.
Cannot access HD2 or HD3 multicast channel when recalling a preset or from a direct tune.	The previously stored multicast preset or direct tune is not available in your current reception area.	No action required. The station is not available in your current location.
Text information does not match currently playing audio.	Data service issue by the radio broadcaster.	Fill out the station issue form at http://www.ibiquity.com/automotive/report_radio_station_experiences
There is no text information shown for currently selected frequency.	Data service issue by the radio broadcaster.	Fill out the station issue form at http://www.ibiquity.com/automotive/report_radio_station_experiences
HD2-HD7 stations not found when you press Scan.	This selection disables HD2-HD7 channel search.	No action required. This is normal behavior.

MyFord Touch™

HD Radio Technology manufactured under license from iBiquity Digital Corp. U.S. and foreign patents. HD Radio and the HD and HD Radio logos are proprietary trademarks of iBiquity Digital Corp. Ford Motor Company and iBiquity Digital Corp. are not responsible for the content sent using HD Radio technology. Content may be

changed, added or deleted at any time at the station owner's discretion.

Radio Voice Commands



Press the voice button and when prompted say:

Voice command	Action and Description
Radio	
Then you can say a command similar to the following:	
FM	Say a frequency or preset.
Off	
Help	

SIRIUS® Satellite Radio (If Activated)



To turn the feature on press the lower left corner of the touchscreen, and then select:

Menu Item	Action and Description
SIRIUS	
You can then select any of the following:	
Presets	Save a channel by pressing and holding one of the memory preset areas. There is a brief mute while the radio saves the channel. Sound returns when finished.
Alerts	Save the current song, artist, or team as a favorite. If you are listening to music, you can save the song or artist, so the system can alert you when they are playing on a satellite radio channel. If you are listening to a sporting event, you can save your favorite teams so the system can alert you when they are playing on a satellite radio channel. You can also edit alerts or turn alerts on or off.

MyFord Touch™

Menu Item	Action and Description
	When an alert appears on the screen, you can choose to tune to the channel, cancel the alert or turn off alerts.
Replay	Replay audio on the current channel. You can replay approximately 45 minutes of audio as long as you have remained tuned to the current station. Changing stations erases the previous audio. While in replay mode: Press and release the seek buttons to hear the previous or next song. Press and hold the seek buttons to reverse or fast forward in the current track. Press play or pause to play or pause the audio. Press the button again to return to live audio.
Scan	Touch this button to hear a brief sampling of channels.
Browse	Touch this button to view a list of all available stations. Scroll to see more categories. Touch the station you want to listen to.

Note: SIRIUS does not support the Alert feature on all channels. Ford Motor Company shall not be responsible for Alert feature variation.

Browsing Controls

Message	Action and Description
Skip	Touch this button if you want to skip this channel.
Lock	Touch this button if you do not want anyone to listen to this channel.
Title	Touch this button to see song and artists on other stations.
Artist	Touch this button to see song and artists on other stations.

Options

Touch this button to view and adjust various media settings.

Message	Message
Sound Settings	Bass
	Midrange
	Treble
	Set Balance and Fade

MyFord Touch™

Message	Message
	DSP
	Occupancy Mode
	Speed Compensated Volume
Set Category for Seek/Scan	This allows you to select a category of music you would like to search for. You can then choose to either seek or scan for the stations playing that category.
Parental Lockout	This allows you to lock and unlock channels, change or reset your PIN or unlock all channels. To use this feature, you need your initial PIN, which is 1234.
Artist / Title / Team Alerts	This feature allows you turn alerts on and off.
Electronic Serial Number (ESN)	SIRIUS requires this number when communicating with you about your account.
Direct Tune	Touch this button to manually enter the desired satellite channel number. Touch Enter when you are done.

Note: Your vehicle may not have all these sound settings.

SIRIUS Satellite Radio Information

Note: SIRIUS reserves the unrestricted right to change, rearrange, add or delete programming including canceling, moving or adding particular channels, and its prices, at any time, with or without notice to you. Ford Motor Company shall not be responsible for any such programming changes.



E142593

SIRIUS satellite radio is a subscription-based satellite radio service that broadcasts a variety of music, sports, news, weather, traffic and entertainment programming. Your factory-installed SIRIUS satellite radio system includes hardware and a limited subscription term that begins on the date of sale or lease of your vehicle. See an authorized dealer for availability.

MyFord Touch™

For more information on extended subscription terms (a service fee is required), the online media player and a list of SIRIUS satellite radio channels, and other features, please visit www.siriusxm.com in the United States, www.sirius.ca in Canada, or call SIRIUS at 1-888-539-7474.

Note: *This receiver includes the eCos real-time operating system. eCos is published under the eCos License.*

Satellite Radio Electronic Serial Number (ESN)

You need your ESN to activate, modify or track your satellite radio account. The ESN is on the System Information Screen (SR ESN:XXXXXXXXXXXX).

To access your ESN, touch the bottom left corner of the touchscreen, then select:

Message
SIRIUS
Options

SIRIUS Satellite Radio Reception Factors and Troubleshooting

Potential reception issues	
Antenna obstructions	For optimal reception performance, keep the antenna clear of snow and ice build-up and keep luggage and other materials as far away from the antenna as possible.
Terrain	Hills, mountains, tall buildings, bridges, tunnels, freeway overpasses, parking garages, dense tree foliage and thunderstorms can interfere with your reception.
Station overload	When you pass a ground-based broadcast-repeating tower, a stronger signal may overtake a weaker one and the audio system may mute.
Satellite radio signal interference	Your display may show ACQUIRING... to indicate the interference and the audio system may mute.

MyFord Touch™

Troubleshooting tips		
Message	Cause	Action
Acquiring...	Radio requires more than two seconds to produce audio for the selected channel.	No action required. This message should disappear shortly.
Satellite antenna fault SIRIUS system failure	There is an internal module or system failure present.	If this message does not clear shortly, or with an ignition key cycle, your receiver may have a fault. See an authorized dealer for service.
Invalid Channel	The channel is no longer available.	Tune to another channel or choose another preset.
Unsubscribed Channel	Your subscription does not include this channel.	Contact SIRIUS at 1-888-539-7474 to subscribe to the channel, or tune to another channel.
No Signal	The signal is lost from the SIRIUS satellite or SIRIUS tower to your vehicle antenna.	The signal is blocked. When you move into an open area, the signal should return.
Updating...	Update of channel programming in progress.	No action required. The process may take up to three minutes.
Questions? Call 1-888-539-7474	Your satellite service is no longer available.	Contact SIRIUS at 1-888-539-7474 to resolve subscription issues.
None found Check Channel Guide	All the channels in the selected category are either skipped or locked.	Use the channel guide to turn off the Lock or Skip function on that station.
Subscription Updated	SIRIUS has updated the channels available for your vehicle.	No action required.

SIRIUS Satellite Radio Voice Commands



If you are listening to SIRIUS satellite radio, press the voice button on the steering wheel controls. When prompted, say any of the following commands.

MyFord Touch™

If you are not listening to SIRIUS satellite radio, press the voice button and when prompted say:

Voice command
Sirius
You can then say any of the following or a similar command:
SAT 1
Sports Games
Tune
Help

CD



To access, press the lower left corner on the touchscreen, then select:

Menu Item
CD

Insert your CD then select:

Menu Item	Action and Description
Repeat	Touch this button to repeat the currently playing track, all tracks on the disc or switch the feature off if already on.
Shuffle	Touch this button to play the tracks or entire albums in random order, or switch the feature off if already on.
Scan	Touch this button to hear a brief sampling of all available tracks.
More Info	Touch this button to see disc information.
Browse	Touch this button to look through all available CD tracks.

To adjust the Sound Settings, select:

Menu Item
Options
Sound Settings
Then any of the following:
Bass
Midrange
Treble

Menu Item
Set Balance and Fade
Occupancy Mode
EQ Mode
Speed Compensated Volume

Note: *Your vehicle may not have all these sound settings.*

MyFord Touch™

CD Voice Commands



If you are listening to a CD, press the voice button on the steering wheel controls. When prompted, say any of the following commands.

If you are not listening to a CD, press the voice button and, after the tone, say:

Voice command
CD Player

When listening to a CD you can say many commands. Following are a few examples of what you can say.

Voice command
Play
Pause
Next Track
Previous Track
Help

SD Card Slot and USB Port

The SD card slot and USB port are located in the Media Hub. See **Media Hub** (page 230).

SD Card

Note: Your SD card slot is spring-loaded. To remove the SD card, press the card in and the system ejects it. Do not attempt to pull the card to remove it as this could cause damage.

Note: The navigation system also uses this card slot. See **Navigation** (page 304).

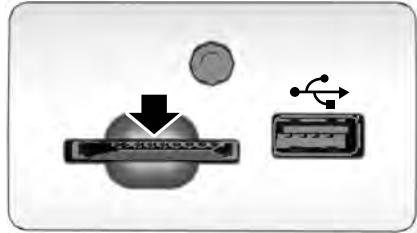

E176638

To access and play music from your device, press the lower left corner of the touchscreen.



E142620

SD logo is a trademark of SD-3C, LLC.

USB Port

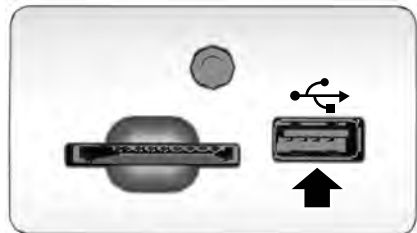

E176639

To access and play music from your device, press the lower left corner of the touchscreen.

MyFord Touch™

This feature allows you to plug in media playing devices, memory sticks, flash drives or thumb drives, and charge devices if they support this feature.

Playing Music from Your Device

Note: *The system is capable of indexing up to 30,000 songs.*



Insert your device and select:

Message	Action and Description
USB SD Card	Once the system recognizes your USB or SD card you can then select from the following options:
Repeat	This feature replays the currently playing song or album.
Shuffle	Touch this button to play music on the selected album or folder in random order.
Similar Music	This feature allows you to choose music similar to what is currently playing.
More Info	Touch this button to see disc information, for example current track, artist name, album and genre.
Options	Touch this button to view and adjust various media settings.

Sound

You can adjust the settings for:

Message	Action and Description
Sound Settings	Bass
	Midrange
	Treble
	Set Balance and Fade
	DSP
	EQ Mode
	Speed Compensated Volume
Media Player Settings	Allows you to select more settings, which is under Media Player. See Settings (page 240).

MyFord Touch™

Message	Action and Description
Device Information	Displays software and firmware information about the currently connected media device.
Update Media Index	Indexes your device when you connect it for the first time and each time the content changes (for example adding or removing tracks) to make sure you have the latest voice commands available for all media on the device.

Note: *Your vehicle may not have all these sound settings.*

Browse

This feature allows you to view the contents of the device. It also allows you to search by categories, for example genre, artist or album.

If you want to view song information, for example Title, Artist, File, Folder, Album, and Genre, touch the on-screen album art.

You can also select:

Message	Action and Description
What's Playing?	To hear how the system pronounces the current band and song. This can be helpful when using voice commands to make sure the system correctly plays your request.

USB and SD Card Voice Commands



Press the voice button and when prompted say:

Voice command
SD Card
USB
Then commands such as the following:
Browse
Next Track
Pause

MyFord Touch™

Voice command	
Play	Say the name of what you would like to listen to such as a band, song, album or playlist.
Similar Music	
Help	

Supported Media Players, Formats and Metadata Information

SYNC is capable of hosting nearly any digital media player, including iPod, Zune™, plays from device players, and most USB drives. Supported audio formats include MP3, WMA, WAV and AAC.

It is also able to organize your indexed media from your playing device by metadata tags. Metadata tags, which are descriptive software identifiers embedded in the media files, provide information about the file.

If your indexed media files contain no information embedded in these metadata tags, SYNC may classify the empty metadata tags as unknown.

Bluetooth Audio

The system allows you to stream audio over your vehicle's speakers from your connected, Bluetooth-enabled cell phone.



To access, press the lower left corner on the touchscreen, then select:

Message
BT Stereo

Bluetooth Audio Voice Commands



The voice system allows you to control your media with a simple voice command. For example to change songs, press the voice button and follow the system prompts.

Line In

WARNINGS



Driving while distracted can result in loss of vehicle control, crash and injury. We strongly recommend that you use extreme caution when using any device that may take your focus off the road. Your primary responsibility is the safe operation of your vehicle. We recommend against the use of any handheld device while driving and encourage the use of voice-operated systems when possible. Make sure you are aware of all applicable local laws that may affect the use of electronic devices while driving.



For safety reasons, do not connect or adjust the settings on your portable music player while your vehicle is moving.

WARNINGS



Store the portable music player in a secure location, such as the center console or the glove box, when your vehicle is moving. Hard objects may become projectiles in a crash or sudden stop, which may increase the risk of serious injury. The audio extension cable must be long enough to allow the portable music player to be safely stored while your vehicle is moving.

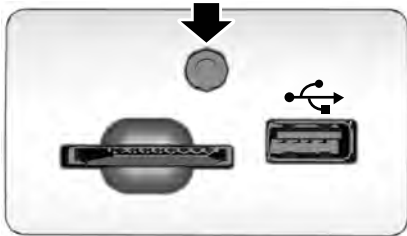

E176636

Your auxiliary input jack allows you to play music from your portable music player over your vehicle's speakers. The jack is located in your center console.

Press the lower left corner of the touchscreen, and then select **Line In**.

To use the auxiliary input jack feature, make sure that your portable music player is designed for use with headphones and that it is fully charged. You also need an audio extension cable with stereo male 1/8-inch (3.5 millimeter) connectors at both ends.

1. Switch off the radio and portable music player. Apply the parking brake and shift the transmission into park (**P**) for automatic transmission or first gear for manual transmission. Switch the ignition off.
2. Attach one end of the audio extension cable to the headphone output of your player and the other end into the adapter in one of the jack inside the center console.
3. Press the lower left corner on the touchscreen. Select either a tuned FM station or a CD (if there is a CD already loaded into the system).
4. Adjust the volume as desired.
5. Turn the portable music player on and adjust the volume to ½ the maximum.
6. Press the lower left corner on the touchscreen. Select the **Line In** tab. (You should hear audio from your portable music player although it may be low.)
7. Adjust the sound on your portable music player until it reaches the level of the FM station or CD by switching back and forth between the controls.

Troubleshooting

- Do not connect the audio input jack to a line level output. The jack only works correctly with devices that have a headphone output with a volume control.
- Do not set the portable music player's volume level higher than is necessary to match the volume of the CD or FM radio as this causes distortion and reduces sound quality.
- If the music sounds distorted at lower listening levels, turn the portable music player volume down. If the problem persists, replace or recharge the batteries in the portable media player.
- Control the portable media player in the same manner when used with headphones, as the auxiliary input jack does not provide control (such as Play or Pause) over the attached portable media player.

PHONE



E161968

Item	Message
A	Phone
B	Quick Dial
C	Phonebook
D	History
E	Messaging
F	Settings

Hands-free calling is one of the main features of SYNC. Once you pair your cell phone, you can access many options using the touchscreen or voice commands. While the system supports a variety of features, many are dependent on your cell phone's functionality.

At a minimum, most cell phones with Bluetooth wireless technology support the following functions:

- Answering an incoming call.
- Ending a call.

- Using privacy mode.
- Dialing a number.
- Redialing.
- Call waiting notification.
- Caller ID.

Other features, such as text messaging using Bluetooth and automatic phonebook download, are cell phone-dependent features. To check your cell phone's compatibility, see your cell phone's user manual and visit www.SYNCMYRide.com, www.SYNCMYRide.ca or www.syncmaroute.ca.

MyFord Touch™

Pairing Your Cell Phone for the First Time

WARNING



Driving while distracted can result in loss of vehicle control, crash and injury. We strongly recommend that you use extreme caution when using any device that may take your focus off the road. Your primary responsibility is the safe operation of your vehicle. We recommend against the use of any hand-held device while driving and encourage the use of voice-operated systems when possible. Make sure you are aware of all applicable local laws that may affect the use of electronic devices while driving.

The first thing you must do to use the phone features of SYNC is to pair your Bluetooth-enabled cell phone with SYNC. This allows you to use your cell phone in a hands-free manner.

Note: *Switch off the radio. Apply the parking brake and shift the transmission into park (P) for automatic transmission or first gear for manual transmission. Switch the ignition off.*

Touch the upper left corner of the touchscreen:

Message	Action and Description
Add phone	
Find SYNC	Follow the on-screen instructions. Make sure that Bluetooth is set to On and that your cell phone is in the correct mode. See your cell phone's manual if necessary. Select SYNC and a six-digit PIN appears on your device. If you are prompted to enter a PIN on your device, it does not support Secure Simple Pairing. To pair, enter the PIN displayed on the touchscreen. Skip the next step. When prompted on your cell phone's display, confirm that the PIN provided by SYNC matches the PIN displayed on your cell phone. The display indicates when the pairing is successful. SYNC may prompt you with more cell phone options. For more information on your cell phone's capability, see your cell phone's manual and visit the website.

Pairing Subsequent Cell Phones

Note: *Switch off the radio. Apply the parking brake and shift the transmission into park (P) for automatic transmission or first gear for manual transmission. Switch the ignition off.*

Make sure that Bluetooth is set to **On** and that your cell phone is in the correct mode. See your device's manual if necessary.

MyFord Touch™

To pair a subsequent cell phone, select:

Menu Item	Action and Description
Phone	
Settings	
Bluetooth Devices	
Add Device	
Find SYNC	<p>Follow the on-screen instructions. Make sure that Bluetooth is set to On and that your cell phone is in the correct mode. See your cell phone's manual if necessary.</p> <p>Select SYNC and a six-digit PIN appears on your device. If you are prompted to enter a PIN on your device, it does not support Secure Simple Pairing. To pair, enter the PIN displayed on the touchscreen. Skip the next step.</p> <p>When prompted on your cell phone's display, confirm that the PIN provided by SYNC matches the PIN displayed on your cell phone.</p> <p>The display indicates when the pairing is successful. SYNC may prompt you with more cell phone options. For more information on your cell phone's capability, see your cell phone's manual and visit the website.</p>

Making Calls



Press the voice button and say a command similar to the following:

Voice command
Call
Dial

You can say the name of a person from your phone book to call or a say a number to dial. For example "Call John" or "Dial 867-5309".



To end the call or exit phone mode, press and hold the phone button.

Receiving Calls

During an incoming call, an audible tone sounds. Call information appears in the display if it is available.



MyFord Touch™

To accept the call, select:

Message
Accept

Note: You can also accept the call by pressing the phone button on the steering wheel.



To reject the call, select:

Message
Reject

Note: You can also reject the call by pressing the phone button on the steering wheel.

Ignore the call by doing nothing. SYNC logs it as a missed call.

Phone Menu Options

Press the top left corner on the touchscreen to select from the following options:

Menu Item	Action and Description
Phone	Touch this button to access the on-screen numerical pad to enter a number and place a call. During an active call, you can also choose any of these options:
	Mute Call
	Hold Call
	Privacy
	Join Calls
	End
Quick Dial	Select to call stored contacts.
Phonebook	Touch this button to access and call any contacts in your previously downloaded phonebook. The system places the entries in alphabetical categories summarized at the top of the screen
	To turn on contact picture settings, if your device supports this feature, select:
	Phone
	Settings
	Manage Phonebook
	Display Photos from Phonebook

MyFord Touch™

Menu Item	Action and Description	
	Certain smartphones may support transferring street addresses when listed with phonebook contact information. If your cell phone supports this feature, you can select and use these addresses as destinations and save them as favorites.	
Call History	Note: This is a cell phone-dependent feature. If your cell phone does not support downloading call history using Bluetooth, SYNC keeps track of calls made with the SYNC system. After you connect your Bluetooth-enabled cell phone to SYNC, you can access any previously dialed, received or missed calls. You can also choose to save these to:	
	<table border="1"> <tr> <td>Favorites</td> <td>Quick Dial</td> </tr> </table>	Favorites
Favorites	Quick Dial	
Messaging	Send text messages using the touchscreen. See Text Messaging later in this section.	
Settings	Touch this button to access various phone settings, for example turning Bluetooth on and off, managing your phonebook and more. See Phone Settings later in this section	

Text Messaging

Note: Downloading and sending text messages using Bluetooth are cell phone-dependent features.

Note: Certain features in text messaging are speed-dependent and not available when your vehicle is traveling at speeds over 3 mph (5 km/h).

Note: SYNC does not download read text messages from your cell phone.

You can send and receive text messages using Bluetooth, read them aloud and translate text messaging acronyms, for example LOL.

Touch the top left corner of the display, then select:

Message
Phone
Messaging
Then any of the following:
Listen (speaker icon)
Dial
Send Text
View
Delete

Composing a Text Message

Note: This is a speed-dependent feature. It is unavailable when your vehicle is traveling at speeds over 3 mph (5 km/h).

MyFord Touch™

Note: Downloading and sending text messages using Bluetooth are cell phone-dependent features.

To compose and send a text message, select:

Message	Action and Description
Phone	
Messaging	
Send Text	Enter a cell phone number or choose from your phonebook.
Edit Text	Allows you to customize the pre-defined message or create a message on your own.
Send	Sends the message as it is.

You can then preview the message, verify the recipient as well as update the message list.

Text Message Options

Message
I'll call you back in a few minutes.
I just left, I'll be there soon.
Can you give me a call?
I'm on my way.
I'm running a few minutes late.
I'm ahead of schedule, so I'll be there early.
I'm outside.
I'll call you when I get there.
OK
Yes
No
Thanks

Message
Stuck in traffic.
Call me later.
LOL

Receiving a Text Message

Note: If you select View and your vehicle is traveling over 3 mph (5 km/h), the system offers to read the message to you instead of allowing you to view it while driving.

When a new message arrives, an audible tone sounds and the screen displays a pop-up with the caller name and ID, if supported by your cell phone. You can select:

Message	Action and Description
View	To view the text message.
Listen	For SYNC to read the message to you.
Dial	To call the contact.
Ignore	To exit the screen.

MyFord Touch™

Phone Settings

To enter the phone settings menu select:

Message	Action and Description
Phone	
Settings	
Then any of the following:	
Bluetooth Devices	Connect, disconnect, add or delete a device, as well as save it as a favorite.
Bluetooth	To turn Bluetooth off or on.
Do Not Disturb	If you want all calls to go directly to your voicemail and not ring in the vehicle. When this feature is on, text message notifications do not ring inside the cabin either.
911 Assist	Turn the 911 Assist feature on and off. See Information (page 292).
Phone Ringer	Select the ring tone you want to hear when you receive a call. Choose from possible system ring tones, your currently paired cell phone's ring tone, a beep, text-to-speech or a silent notification.
Text Message Notification	Select a text message notification, if supported by your cell phone. Choose from possible system alert tones, text-to-speech or silent.
Internet Data Connection	If your cell phone is compatible, use this screen to adjust your internet data connection. Select to make your connection profile with the personal area network or to turn off your connection. You can also choose to adjust your settings or have the system always connect, never connect when roaming or query on connect. Press ? for more information.
Manage Phonebook	To access features such as automatic phonebook download, re-download your phonebook, add contacts from your cell phone as well as delete or upload your phonebook.
Roaming Warning	To have the system alert you when your cell phone is in roaming mode.

MyFord Touch™

Phone Voice Commands



Press the voice button and when prompted say any of the following or a similar command:

Voice command
Call Voicemail
Listen to Message
Reply to Message
Pair Phone
Help

ELECTRIC VEHICLE INFORMATION



Your system has special electric vehicle screens, which display power flow and charge settings. To access these screens, press the EV Info button.

A 
B 



E188886

MyFord Touch™

Item	Menu Item
A	Settings
B	Power

Settings

This screen allows you to set up the charging convenience features.

Note: You can also set up the charging convenience features using MyFord Mobile over the internet or smartphone application. For more information on MyFord Mobile, and to set up your MyFord Mobile account, visit www.myfordmobile.com

To improve the charging experience, your vehicle has the following convenience features:

Feature	Description
Value Charge	Your vehicle schedules its charging time for when the utility rates are lowest. Contact your utility company to see what rates are available.
Charge Now	Your vehicle starts charging immediately after you connect the charging plug.
Cabin Conditioning	Get the most miles out of every charge by conditioning your vehicle when it is plugged in. Set the cabin temperature when you set your GO Time in order to use energy from your home (or charging station) instead of from your vehicle's battery.
GO Time	Setting GO Times allows you to control charging schedules and cabin conditioning settings so your vehicle is ready to drive when you are. By setting a GO Time, your vehicle can use your value charge settings to minimize your electricity costs but still prioritize getting a full charge before your GO Time. A calendar view allows you to program two GO Times per day for each day of the week.

Note: Remember, you must plug in your vehicle for My GO Time to work.

MyFord Touch™

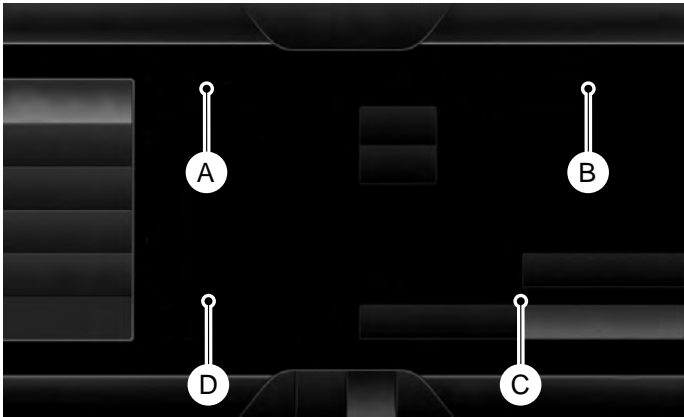

E161966

- A **My GO Time summary** displays the next GO Time and cabin temperature setting.
- B **Estimated charge time limits** displays the estimated minimum and maximum times to fully charge the high-voltage battery and the battery's present state of charge as a percentage of total capacity.
- C **Charge profile and mode** displays the charging profile and charging mode for your vehicle's present location.
- D **Charging status and actual times** displays charging status with the charging start time, end time and duration.

MyFord Touch™

My GO Time Summary

Menu Item	Action and Description
GO Time	This is the time and date of your next set drive time. Your vehicle automatically schedules charging and cabin conditioning to finish by this time.
Temperature	This is the chosen cabin conditioning setting for this GO Time.
Skip	This cancels the cabin conditioning for the present GO Time. Once you touch Skip, the GO Time and Temperature grey out, and the LED illuminates on the Skip button. Touch the button again to switch on the cabin conditioning. This feature allows you to ignore the present GO Time without having to delete it or having to switch off the entire schedule (see GO Time Schedule later in this section). After the present GO Time passes, the Skip feature resets.
Edit	This accesses your GO Time Schedule (see GO Time Schedule later in this section). The system also alerts you to any conflicts by highlighting areas of the screen in yellow. If your battery cannot have a full charge by the scheduled drive time, the system highlights your next GO Time and Charge Complete time and a message Charge at GO Time: under 100% appears. This is normal; the vehicle is informing you of the conflicting situation. This notification only displays when the gearshift selector lever is in position P .

Note: Charging occurs as soon as you plug the vehicle in. The system limits cabin conditioning to 15 minutes before your GO Time.

To eliminate the conflict notification immediately or to prevent a conflict in the future, try the following:

- Switch the present GO Time to occur later.
- Plug the vehicle into a 240V charging station instead of the 120V convenience cord. Higher power charging yields shorter charge times.
- Plug the vehicle in sooner.

MyFord Touch™

Menu Item	Action and Description
Battery	This shows you the battery's current charge displayed as a percentage. A reading of 100% means the battery has a full charge. A reading of 0% indicates the battery has no charge.
To fully charge	<p>240V This shows the estimated minimum charging time from the present high-voltage battery level to full charge (100%). This represents the shortest amount of time you should expect the high-voltage battery to recharge under ideal conditions. Ideal conditions include a 240V charging station and a minimum 30A service and high-voltage battery at a moderate temperature.</p> <p>120V This shows the estimated maximum charging time from the present high-voltage battery level to full charge (100%). This represents the longest amount of time you should expect the high-voltage battery to recharge under normal conditions. Normal conditions include a 120V convenience cord and 12A service.</p>

Note: *This charging time is only an estimate. It is normal for your actual charge duration to be longer.*

Note: *Some charging stations use lower voltage (208V), which result in longer charge times.*

Note: *This charging time is only an estimate. It is possible for your actual charge duration to be longer. This occurs when the AC line voltage is low and may indicate your electrical source is not meeting certain requirements. See **Charging the High Voltage Battery** (page 115).*

MyFord Touch™

Value Charge Profile and Mode

Menu Item	Action and Description
Value Charge Profile Name	This is the name of the presently detected Value Charge Profile. The system detects a customer defined value charge profile when the vehicle is within approximately 328 ft (100 m) of the GPS location registered for the profile. If the vehicle is close to more than one charge profile, it chooses the closest. When the vehicle is not at a defined profile, it uses the Default Value charge profile. The system normally displays Default Profile when you are driving because the vehicle is typically between defined value charge profiles.
Edit	Touch this button to access your Value Charge profiles settings screen (see Value Charge Profiles later in this section).
Charge Now	Touch this button if you want your vehicle to immediately charge when plugged in at this profile location. This button illuminates when Charge Now is the charge mode selected for the presently detected charge profile.
Value Charge	Touch this button if you want to take advantage of off-peak electricity rates. The vehicle optimizes the charge schedule to be complete by the next GO Time. This button illuminates when Value Charge is the charge mode selected for the presently detected charge profile.

Charging Status and Actual Times

This is the status of the charging system, which includes the charging plug, high-voltage battery and charger.

MyFord Touch™

Menu Item	Action and Description	
Next Charge	This means the vehicle is unplugged. Charge Start and Complete information is for the present vehicle location.	
Waiting to charge	This means you plugged the vehicle in and it is ready to charge. Typical of Value Charge mode, the vehicle may not start charging right away because it is set to charge at times with lower utility costs.	
Charging	This means the high-voltage battery is charging.	
Charged	This informs you that the high-voltage battery is fully charged and not currently scheduled for further charging.	
Fault	This alerts you that a fault is present and is preventing the high-voltage battery from charging. Check the charge plug connection, charge cord and charging station.	
Start	This is the scheduled start time of charging.	
	At Plug In	When the vehicle is in Charge Now mode, and unplugged, the message At Plug In appears, indicating the vehicle immediately starts charging once you plug it in. Once you plug it in, the system shows the actual charge start time.
	Scheduled Charge Start Time	When the vehicle is in Value Charge mode, the system displays the scheduled charge start time (for example, 8:00 PM). Once charging starts, the system continues to display the actual charge start time.

MyFord Touch™

Menu Item	Action and Description	
Complete	This is the estimated time of charge completion.	
	Charge Now Duration	When the vehicle is in Charge Now mode, and unplugged, the system displays the charging duration in hours. Once you plug in the vehicle, the value shows the estimated time to finish charging.
	Scheduled Charge Complete Time	When the vehicle is in Value Charge mode, the system displays the estimated charge complete time. It is normal for the estimated complete time to switch when charging. The vehicle keeps charging until the high-voltage battery is fully charged.

GO Time Schedule

Menu Item	Action and Description	
Edit	Touch this button to see the GO Time Schedule.	
On	This turns on the GO Time schedule.	
Off	This turns off the GO Time schedule. This also turns off the cabin conditioning function. Use this mode to prevent using energy for cabin preconditioning when you leave your vehicle plugged in and do not plan to use it for a while, such as when on vacation.	
GO Time 1	This displays the GO Time day-of-week and time. The blue highlighted GO Time is the present GO Time, which the vehicle is using for charge scheduling and cabin conditioning. You can schedule two GO Time events per day for each day of the week.	
GO Time 2	GO Time	allows you to edit the GO Time and cabin conditioning temperature.
	--:--	indicates that you can add a GO Time to this slot.

Note: If you choose to perform Value Charging with the schedule off, the vehicle schedules charging to finish at the lowest cost within 24 hours of plugging the vehicle in.

Note: If you set GO Time 2 to occur before GO Time 1, a message pops up alerting you. You need to go back to the previous screen and switch the times so GO Time 1 occurs before GO Time 2.

MyFord Touch™

GO Time and Cabin Conditioning

the GO Time and cabin conditioning temperature.

This screen allows you to enter or change

Menu Item	Action and Description			
Time (+ and -)	These switch the hours and minutes of your GO Time. The minutes switch in increments of five. You can also switch the settings for AM and PM by touching those buttons.			
Cabin Conditioning (+ and -)	These switch the setting for your selected cabin conditioning temperature for this GO Time event. You can select from four settings:			
	65°F (18.5°C)	72°F (22°C)	85°F (29.5°C)	Off
Clear	Touching this button erases the GO Time and cabin conditioning temperature.			
Save	Touching this button stores the GO Time and temperature settings.			

Note: Cabin conditioning can perform differently depending on if you plug into a 120V convenience cord or 240V charging station. The power available for conditioning is limited to the charging station power available.

Note: Your vehicle may not always reach the set cabin temperature due to charging and ambient temperature conditions. This is normal operation.

Note: If you select a GO Time, but choose **Off** for the temperature setting, the vehicle schedules charging to be complete by your GO Time and does not condition the cabin.

Note: Make sure you save your settings before returning to the previous screen. If you do not touch **Save**, your settings are not stored in the system.

Value Charge Profiles

Menu Item	Action and Description	
Edit	Touch this button next to the profile name on the Settings screen to see the value charge profiles.	
Default	This displays the charging mode and off-peak times for your Default Value Charge profile. The system displays off-peak times for weekdays; the remaining hours of the day are considered peak time. The system displays similar off-peak times for weekend days.	
	Charge Now	if you want your vehicle to immediately charge when you plug it in at this profile location.

MyFord Touch™

Menu Item	Action and Description	
	Value Charge	if you want to take advantage of off-peak electricity rates. The vehicle optimizes the charge schedule to be complete by the next GO Time.
	Edit	to access your Default Value Charge Profile settings screen (see Default Value Charge Profile later in this section).
Customer Defined Value Charge Profiles	Once you create profile names, this section displays the Value Charge Profile names and current Charge Mode for specific locations. You can set up and edit these profiles using the MyFord Mobile internet or smartphone application. You can program up to nine unique charge profiles.	

Default Value Charge Profile

Menu Item	Action and Description	
Weekday	Edit	Touch this button to set the off-peak charge times. Set the Weekday times and Weekend times by press these buttons.
Weekend	Save	Touch this button for the system to remember your settings. The system does not store your settings until you make selections for both Weekday and Weekend. If you touch the back arrow button to return to the previous screen

MyFord Touch™

Menu Item	Action and Description	
		without saving your settings, the system does not store them and you need to enter them again.
Start	These buttons display the times, which you can modify, using the following:	
	+ and -	Allows you to switch the hours of your start and finish times.
Complete	AM	Allows you to switch the time of your start and finish time. This setting is viewable in 12-hour mode.
	PM	
240V and 120V	These represent the voltage service the default profile is using. The system uses this selection to calculate estimated charge times.	
Clear	Touching this button erases the Default Value Charge preferences.	
Save	Touching this button stores your Default Value Charge preferences.	

Note: Make sure you save your settings before returning to the previous screen. If you do not touch **Save**, the system does not store your settings.

MyFord Touch™

Power

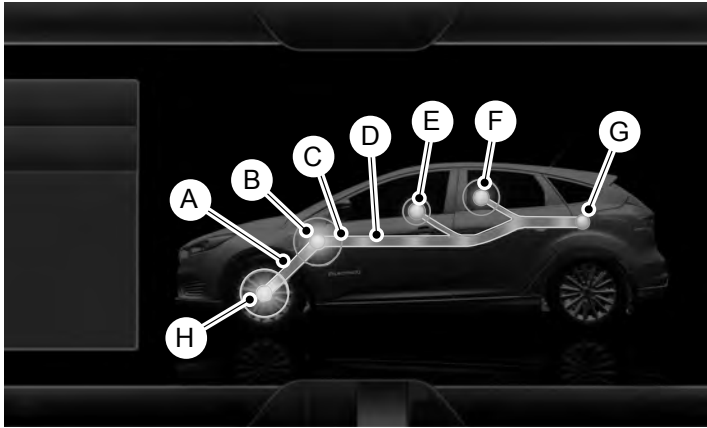

E187299

Callout	Item	Description
A	Motor-to-Wheel Flow	Shows the direction of power flow between the wheels and the electric motor.
B	Electric Motor	Represents the hybrid electric motor. The higher the motor power is, the larger the circle around this node. Any time the vehicle is ready to be driven, the motor node illuminates.
C	Battery-to-Motor Flow	Shows the direction of power flow between the high-voltage battery and the electric motor. Flow toward the motor indicates the battery is providing power to accelerate the vehicle (discharging the battery). Flow toward the battery indicates the electric motor is providing power to the battery (charging the battery).
D	Plug	Appears when you plug your vehicle into the wall. When charging the high voltage battery from the wall, you can see flow from the plug to the battery on the screen.

MyFord Touch™

Callout	Item	Description
E	Other ²	Includes all power usage from the low voltage accessories such as the climate control fan, headlights and heated seats. The higher the power usage is from these accessories, the larger the circle around the node. This node illuminates anytime the vehicle is on since there is always some low level power in use.
F	Climate ^{2,3}	Includes the power usage from the high-voltage climate control components such as the electric A/C compressor and the electric heater. The higher the power usage is from these components, the larger the circle around this node.
G	High Voltage Battery Power	Represents your high-voltage battery. A circle illuminates around the node when the high-voltage battery is receiving power from regenerative braking, engine charging or external charging (when you plug it in). The higher the power going into the high-voltage battery, the larger the circle around this node.
H	Drive Power	Represents the power going to the wheels. The higher the wheel power is, the larger the circle around this node.

¹The battery-to-motor flow includes battery power the vehicle is using for acceleration. It does not include energy the vehicle is using for accessories (such as air conditioning, headlights and radio). This screen displays accessories and climate usage separately.

² **Accessories** indicates electrical power demands from your vehicle's accessory systems. Accessories use power but do not contribute to making the vehicle move. The power flow displays power usage from the climate control system and other accessories separately.

³The climate control system may determine A/C is necessary even when you switch it off. In this case, you may see some climate power when the A/C is off.

Status

This indicates which mode is active within the vehicle system.

MyFord Touch™

Menu Item	Action and Description
Charging HV Battery	The hybrid system is storing power in the high-voltage battery.
Idle	The vehicle is either at rest, or sharing very little power between the electric system parts.
Electric Drive	You are driving in electric mode.
Charge Complete	The high-voltage battery charging from the wall is complete.

Privacy Notice for GPS Mapping with MyFord® Mobile

MyFord Mobile allows for GPS mapping when you register a vehicle to a MyFord Mobile account. To remove the vehicle from the account, thereby removing GPS mapping ability, perform a Master Reset in the vehicle. See **Settings** (page 240).

Prior to transferring ownership of a vehicle, owners may choose to execute a Master Reset or Factory Reset (completed via the MyFord Mobile website). Either method will remove the vehicle from all MyFord Mobile accounts.

We recommend that new owners conduct a Master Reset upon taking possession of the vehicle to remove it from any existing MyFord Mobile accounts. The new owner can activate a MyFord Mobile account by going to www.myfordmobile.com and following the registration process.

INFORMATION

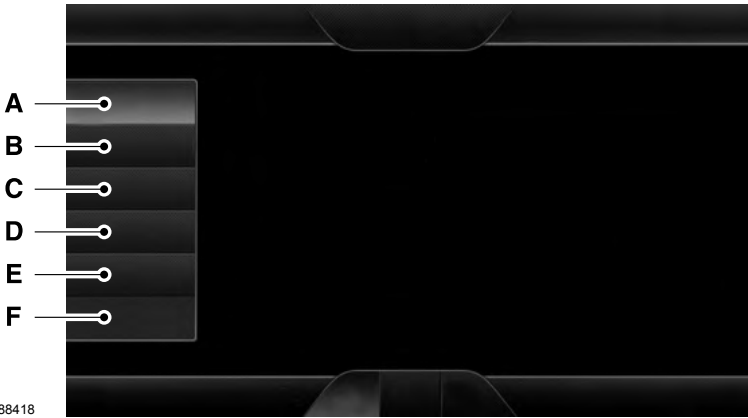

E188418

Item	Message
A	SYNC Services
B	Travel Link
C	Alerts
D	Calendar
E	Apps
F	Where Am I?

 If your vehicle is equipped with Navigation, press the **Information** button to access these features. If your vehicle is not equipped with Navigation, press the corner of the touchscreen with the green tab.

SYNC Services (If Equipped, United States Only)

Note: SYNC Services varies by trim level and model year and may require a subscription. Traffic alerts and turn-by-turn directions available in select markets. Message and data rates may apply. Ford Motor Company reserves the right to change or discontinue this product service at any time without prior notification or incurring any future obligation.

Note: SYNC Services requires activation before use. Visit www.SYNCMYride.com to register and check your eligibility for complimentary services. Standard phone and message rates may apply. Subscription may be required. You must also have the active SYNC Services Bluetooth-enabled cellular phone paired and connected to the system in order to connect to, and use, SYNC Services. See **Phone** (page 271).

MyFord Touch™

Note: This feature does not function properly if you have enabled caller ID blocking on your cellular phone. Make sure your cellular phone is not blocking caller ID before using SYNC Services.

Note: The driver is ultimately responsible for the safe operation of the vehicle, and therefore, must evaluate whether it is safe to follow the suggested directions. Any navigation features provided are only an aid. Make your driving decisions based on your observations of local conditions and existing traffic regulations. Do not follow the route suggestions if doing so would result in an unsafe or illegal maneuver, if you would be placed in an unsafe situation, or if you would be directed into an area that you consider unsafe. Maps used by this system may be inaccurate because of errors, changes in roads, traffic conditions or driving conditions.

Note: When you connect, the service uses GPS technology and advanced vehicle sensors to collect your vehicle's current location, travel direction and speed to help provide you with the directions, traffic reports, or business searches you request. Further, to provide the services you request, for continuous improvement, the service may collect and record call details and voice communications. For more information, see SYNC Services Terms and Conditions at www.SYNCMYride.com. If you do not want Ford or its service providers to collect your vehicle travel information or other information identified in the Terms and Conditions, do not subscribe or use the service.

SYNC Services uses advanced vehicle sensors, integrated GPS technology and comprehensive map and traffic data, to give you personalized traffic reports, precise turn-by-turn directions, business search, news, sports, weather and more. For a complete list of services, or to learn more, please visit www.SYNCMYride.com.

Connecting to SYNC Services

You can connect to SYNC Services using voice commands or by selecting a menu item on the touchscreen.

To use voice commands, press the voice button and say:

Voice Command	Action and Description
Services	This initiates an outgoing call to SYNC Services using your paired and connected Bluetooth-enabled cellular phone. Once you connect to the service, follow the voice prompts to request the desired service, for example traffic or directions.
Once connected to SYNC Services, you can also say the following:	
What Can I Say	Receive a list of available services from which to choose.
Services	To return to the Services main menu.
Help	Receive system help.

MyFord Touch™

If your vehicle is equipped with Navigation, press the **I (Information)** button. If your vehicle is not equipped with Navigation, press the green tab on your touchscreen.

To use the touchscreen select:

Menu Item
Connect to Services

This command initiates an outgoing call to SYNC Services using your paired and connected Bluetooth-enabled cellular phone. Once you connect to the service, follow the voice prompts to request the desired service.

Receiving Turn-by-Turn Directions

Press the voice button and say:

Voice Command	Action and Description
Directions	To receive directions to a location. Once you select your destination, the system uploads your current vehicle location, calculates a route based on current traffic conditions and sends it back to your vehicle. After the route download is complete, the phone call automatically ends. You then receive audible and visual driving instructions as you travel toward your destination.
Business Search	To find a business or type of business. Once you select your destination, the system uploads your current vehicle location, calculates a route based on current traffic conditions and sends it back to your vehicle. After the route download is complete, the phone call automatically ends. You then receive audible and visual driving instructions as you travel toward your destination.
Search near me	To find the closest business or type of business to your location, within business search.
Operator	Provides you with further assistance within Directions and Business Search. The system may prompt you to speak with an operator when it has difficulty matching your voice request. The live operator can assist you by searching for businesses by name or by

MyFord Touch™

Voice Command	Action and Description
	category, residential addresses by street address or by name or specific street intersections. Operator Assist is a feature of your SYNC Services subscription. For more information on Operator Assist, visit www.SYNCMyRide.com/support .
Yes [During an active route]	If you miss a turn, SYNC automatically asks if you want the route updated. Say yes when prompted and the system sends a new route to your vehicle.

Disconnecting from SYNC Services

To use the steering wheel controls, press and hold the hang-up phone button on the steering wheel.

To use voice commands, press the voice button and say:

Voice Command
Good-bye

SYNC Services Quick Tips

Tips	
Personalizing	You can personalize your Services feature to provide quicker access to your most used or favorite information. You can save address points, such as work or home. You can also save favorite information like sports teams, for example Detroit Lions, or a news category. You can learn more about personalization by logging onto www.SYNCMyRide.com .
Push to interrupt	Press the voice button at any time (while connected to SYNC Services) to interrupt a voice prompt or an audio clip (such as a sports report) and say your voice command.
Portable	Your subscription is associated with your Bluetooth-enabled cellular phone number, not your VIN (Vehicle Identification Number). You can pair and connect your phone to any vehicle equipped with SYNC Services and continue enjoying your personalized services.

SYNC Services Voice Commands



If your vehicle is equipped with Navigation, SYNC Services downloads your requested destination to the navigation system. The navigation system then calculates the route and provides driving instructions. See **Navigation** (page 304).

If your vehicle is not equipped with Navigation, when a route has been downloaded (non-navigation systems), you can press the voice button on the steering wheel controls and say any of the following commands to receive directions:

Services

Voice command
Cancel Route
Route Status
Route summary
Update Route
Help

Sirius Travel Link (If Equipped)

WARNING



Driving while distracted can result in loss of vehicle control, crash and injury. We strongly recommend that you use extreme caution when using any device that may take your focus off the road. Your primary responsibility is the safe operation of your vehicle. We recommend against the use of any handheld device while driving and encourage the use of voice-operated systems when possible. Make sure you are aware of all applicable local laws that may affect the use of electronic devices while driving.

Note: In order to use Sirius Travel Link, your vehicle must be equipped with navigation and your navigation SD card must be in the SD card slot.

Note: A paid subscription is required to access and use these features. Go to www.siriusxm.com/travellink for more information.

Note: Visit www.siriusxm.com/traffic and click on Coverage map and details for a complete listing of all traffic areas covered by Sirius Travel Link.

Note: Neither Sirius nor Ford is responsible for any errors or inaccuracies in the Sirius Travel Link services or its use in vehicles.

When you subscribe to Sirius Travel Link, it can help you locate the best gas prices, find movie listings, get current traffic alerts, view the current weather map, get accurate ski conditions and see scores to current sports games.

MyFord Touch™

Menu Item	Action and Description	
Traffic on Route	Touch these buttons to identify traffic incidents on your route, nearby your vehicle's current location or near any of your favorite places, if programmed.	
Traffic Nearby		
Fuel Prices	Touch this button to view fuel prices at stations close to your vehicle's location or on an active navigation route.	
Movie Listings	Touch this button to view nearby movie theaters and their show times, if available.	
Weather	Touch this button to view the nearby weather, current weather, or the five day forecast for the chosen area.	
	Map	Select to see the weather map, which can show storms, radar information, charts and winds.
	Area	Select to choose from a listing of weather locations.
Sports Info	Touch this button to view scores and schedules from a variety of sports. You can also save up to 10 favorite teams for easier access. The score automatically refreshes when a game is in progress.	
Ski Conditions	Touch this button to view ski conditions for a specific area.	

Sirius Travel Link Voice Commands



Press the voice button on the steering wheel controls. When prompted, say any of the following or a similar command:

Voice command
Show Traffic
Show Weather
Help

Alerts



If your vehicle is equipped with Navigation, touch the **i** (Information) button to access these features. If your vehicle is not equipped with Navigation, touch the corner of the touchscreen with the green tab.

Press Alerts, then choose from any of the following services:

Message	Action and Description
View	The complete message
Delete	The message
Delete All	Messages

This screen displays any system messages (such as an SD card fault).

Note: The system alerts you to any messages by turning the information icon yellow. After you read or delete the messages, the icon returns to white.

Calendar



If your vehicle is equipped with Navigation, touch the I (Information) button to access these features. If your vehicle is not equipped with Navigation, touch the corner of the touchscreen with the green tab.

Press **Calendar**. You can view the current calendar by day, week or month.

911 Assist

WARNINGS



Unless the 911 Assist setting is set on before a crash, the system will not dial for help, which could delay response time, potentially increasing the risk of serious injury or death after a crash.



Do not wait for 911 Assist to make an emergency call if you can do it yourself. Dial emergency services immediately to avoid delayed response time, which could increase the risk of serious injury or death after a crash. If you do not hear 911 Assist within five seconds of the crash, the system or phone may be damaged or non-functional.



Always place your phone in a secure location in your vehicle so it does not become a projectile or damaged in a crash. Failure to do so may cause serious injury to someone or damage the phone, which could prevent 911 Assist from working properly.

Note: The SYNC 911 Assist feature must be set on prior to the incident.

Note: Before setting this feature on, make sure that you read the 911 Assist Privacy Notice later in this section for important information.

Note: If any user turns 911 Assist on or off, that setting applies for all paired phones. If 911 Assist is turned off, either a voice message plays or a display message (or icon) comes on (or both) when your vehicle is started after a previously paired phone connects.

Note: Every phone operates differently. While SYNC 911 Assist works with most cellular phones, some may have trouble using this feature.

If a crash deploys an airbag, excluding knee airbags and rear inflatable safety belts where fitted or activates the fuel pump shut-off, your SYNC-equipped vehicle may be able to contact emergency services by dialing 911 through a paired and connected Bluetooth-enabled phone. You can learn more about the 911 Assist feature, visit www.SYNCMYride.com, www.SYNCMYride.ca or www.syncmaroute.ca.

See **Supplementary Restraints System** (page 37). Important information regarding airbag deployment is in this chapter.

See **Roadside Emergencies** (page 147). Important information regarding the fuel pump shut-off is in this chapter.

Setting 911 Assist On



If your vehicle is equipped with Navigation, touch the I (Information) button to access these features. If your vehicle is not equipped with Navigation, touch the corner of the touchscreen with the green tab. Then select:

Message
Apps
911 Assist
On



You can also access 911 Assist by pressing:

Message
Settings
Phone
911 Assist
Or you can also select:
Help
911 Assist

To make sure that 911 Assist works properly:

- SYNC must be powered and working properly at the time of the incident and throughout feature activation and use.
- The 911 Assist feature must be set on prior to the incident.
- You must pair and connect a Bluetooth-enabled and compatible phone to SYNC.

- A connected Bluetooth-enabled phone must have the ability to make and maintain an outgoing call at the time of the incident.
- A connected Bluetooth-enabled phone must have adequate network coverage, battery power and signal strength.
- The vehicle must have battery power and be located in the United States, Canada or in a territory in which 911 is the emergency number.

In the Event of a Crash

Not all crashes deploy an airbag or activate the fuel pump shut-off (which would trigger 911 Assist); however, SYNC tries to contact emergency services if 911 Assist triggers. If a connected phone sustains damage or loses connection to SYNC, SYNC searches for, and tries to connect to, any available previously paired phone and tries to make the call to 911.

Before making the call:

- SYNC provides a short window of time (approximately 10 seconds) to cancel the call. If you fail to cancel the call, SYNC attempts to dial 911.
- SYNC says the following, or a similar message: "SYNC will attempt to call 911, to cancel the call, press Cancel on your screen or press and hold the phone button on your steering wheel."

If you do not cancel the call, and SYNC makes a successful call, a pre-recorded message plays for the 911 operator, and then the occupant(s) in your vehicle is able to talk with the operator. Be prepared to provide your name, phone number and location immediately, because not all 911 systems are capable of receiving this information electronically.

MyFord Touch™

911 Assist May Not Work If:

- Your cellular phone or 911 Assist hardware sustains damage in a crash.
- The vehicle's battery or the SYNC system has no power.
- The phone(s) previously paired or connected to the system are thrown from the vehicle.

911 Assist Privacy Notice

When you turn on 911 Assist, it may disclose to emergency services that your vehicle has been in a crash involving the deployment of an airbag or activation of the fuel pump shut-off. Certain versions or updates to 911 Assist may also be capable of electronically or verbally disclosing to 911 operators your vehicle location or other details about your vehicle or crash to assist 911 operators to provide the most appropriate emergency services. If you do not want to disclose this information, do not turn the feature on.

Vehicle Health Report

WARNING



Always follow scheduled maintenance instructions, regularly inspect your vehicle, and seek repair for any damage or problem you suspect. Vehicle Health Report supplements, but cannot replace, normal maintenance and vehicle inspection. Vehicle Health Report only monitors certain systems electronically monitored by your vehicle and will not monitor or report the status of any other system, (such as brake lining wear). Failure to perform scheduled maintenance and regularly inspect your vehicle may result in vehicle damage and serious injury.

Note: This feature is only available in the United States.

Note: Your Vehicle Health Report feature requires activation prior to use. Visit www.SYNCMYRIDE.com to register. There is no fee or subscription associated with Vehicle Health Report, but you must register to use this feature.

Note: This feature may not function properly if you have enabled caller ID blocking on your cellular phone. Before running a report, review the Vehicle Health Report Privacy Notice.

Note: In order to allow a break-in period for your vehicle, you may not be able to create a Vehicle Health Report until your vehicle odometer has reached 200 miles.

Note: Cellular phone and SMS charges may apply when making a report.

Register for Vehicle Health Report and set your report preferences at www.SYNCMYRIDE.com. After registering, you can request a Vehicle Health Report (inside your vehicle). Return to your account at www.SYNCMYRIDE.com to view your report. You can also choose for SYNC to remind you automatically to run reports at specific mileage intervals. Cellular phone airtime usage may apply when reporting.

The system allows you to check your vehicle's overall health in the form of a diagnostic report card. The Vehicle Health Report contains valuable information, for example:

- Vehicle diagnostic information.
- Scheduled maintenance.
- Open recalls and Field Service Actions.
- Items noted during vehicle inspections by your authorized dealer that still need servicing.

Making a Report



MyFord Touch™

If you want to run a report by using the touchscreen, select:

Message
Apps
Vehicle Health Report



You can also run a vehicle health report by voice command.

Press the voice button and when prompted say:

Voice command
Vehicle Health Report

Vehicle Health Report Privacy Notice

When you create a Vehicle Health Report, Ford Motor Company may collect your cellular phone number (to process your report request) and diagnostic information about your vehicle. Certain versions or updates to Vehicle Health Report may also collect more vehicle information. Ford may use your vehicle information it collects for any purpose. If you do not want to disclose your cellular phone number or vehicle

information, do not run the feature or set up your Vehicle Health Report profile at www.SYNCMYride.com. See www.SYNCMYride.com (Vehicle Health Report Terms and Conditions, and Privacy Statement) for more information.

Where Am I?

For information about your current location, select:

Message	Action and Description
Where Am I?	View your vehicle's current location, if your vehicle is equipped with navigation. If your vehicle is not equipped with navigation, nothing displays.

CLIMATE

Press the lower right corner on the touchscreen to access your climate control features. Depending on your vehicle line and option package, your climate screen may look different from the screen shown here.

Note: You can switch temperature units between Fahrenheit and Celsius. See **Settings** (page 240).

MyFord Touch™

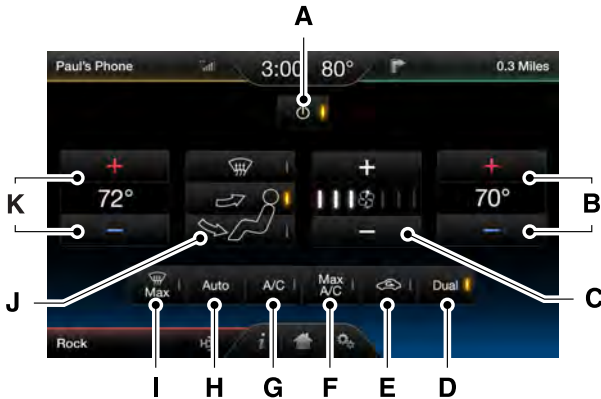

E185678

- A **Power:** Touch to switch the system off and on. Outside air cannot enter your vehicle when you switch off the system.
- B **Passenger settings:** Touch + or – to adjust the temperature.
- C **Fan speed:** Touch + or - to adjust fan speed.
- D **DUAL:** Touch to switch on the passenger temperature control.
- E **Recirculated air:** Touch to turn the recirculated air on or off which may reduce the amount of time needed to cool down the interior and help reduce odors from reaching the interior. Recirculated air also engages automatically when MAX A/C or MAX defrost is selected and may be engaged manually in any airflow mode except defrost. It may also turn off in all airflow modes except MAX A/C and MAX defrost to reduce fog potential.
- F **MAX A/C:** Touch to cool your vehicle with recirculated air. Touch again for normal A/C operation. MAX A/C distributes air through instrument panel vents and may help reduce odors from entering your vehicle. MAX A/C is more economical and efficient than normal A/C mode.
- G **A/C:** Touch to turn the air conditioning on or off. Use A/C with recirculated air to improve cooling performance and efficiency. A/C engages automatically in MAX A/C, defrost and footwell/defrost.
- H **AUTO:** Touch to engage automatic operation, then set the temperature using the temperature control. The system automatically controls fan speed, airflow distribution, A/C on or off and the use of fresh or recirculated air.

MyFord Touch™

- I **MAX Defrost:** Distributes outside air through the windshield air vents and automatically switches the air conditioning on. The fan is set to the highest speed and the temperature to HI. When the air distribution is set in this position, you are unable to select recirculated air or manually adjust the fan speed and temperature control.
- J **Manual airflow distribution controls:** Airflow can be directed into the following locations:
 - Footwell and Defrost:** Distributes air through the windshield defroster vents, demister vents, floor vents and rear seat floor vents, and provides outside air to reduce window fogging.
 - Panel:** Distributes air through the instrument panel vents.
 - Panel and Floor:** Distributes air through the instrument panel vents, demister vents, floor vents and rear seat floor vents.
 - Floor:** Distributes air through the demister vents, floor vents and rear seat floor vents.
 - Defrost:** Touch to clear the windshield of fog and thin ice. Touch again to return to the previous airflow selection. When on, defrost provides outside air to reduce window fogging and distributes air through the windshield defroster vents and demister vents.
- K **Driver settings:** Touch + or – adjust the temperature.

Climate Control Voice Commands



Press the voice button on the steering wheel controls. When prompted, say any of the following or a similar command:

Voice commands	
Climate On	
Climate Off	
Set temperature	Adjust the temperature to between 59 - 86°F (15.0 - 30.0°C).

MyFord Touch™

NAVIGATION

Note: The navigation SD card must be in the SD card slot to operate the navigation system. If you need a replacement SD card, see an authorized dealer.

Note: The SD card slot is spring-loaded. To remove the SD card, just push the card in and release it. Do not attempt to pull the card out to remove it; this could cause damage.

Your navigation system is comprised of two main features, destination mode and map mode.

Destination Mode

To set a destination press the green corner of your touchscreen, then the press:

Menu Item
Dest.
Choose any of the following:
My Home
Favorites
Previous Destinations
Point of Interest
Emergency

Menu Item
Street Address
Intersection
City Center
Map
Edit Route
Cancel Route

To set your destination, enter the necessary information into the highlighted text fields (in any order).

For an address destination entry, press:

Menu Item	Action and Description
Go	Pressing this button makes the address location appear on the map.

To choose a previous destination, press:

Menu Item	Action and Description
Previous Destinations	The last 20 destinations you have selected appear.

MyFord Touch™

Once you have chosen your destination press:

Menu Item	Action and Description	
Set as Dest	To make this your destination. You can also choose to set this as a waypoint (have the system route to this point on the way to your current destination) or save it as a favorite. You can then choose your route from three different options.	
	Fastest Route	Uses the fastest moving roads possible.
	Shortest Route	Uses the shortest distance possible.
	Eco Route	Uses the most fuel-efficient route.

To begin navigation press:

Menu Item	Action and Description
Start Route	You can cancel the route or have the system demo the route for you. During route guidance, you can press the talking bubble icon that appears in the upper right navigation corner (green bar) if you want the system to repeat route guidance information. When the system repeats the last guidance instruc-

Menu Item	Action and Description
	tion, it updates the distance to the next guidance instruction, since it detects when the vehicle is moving.

Note: If your vehicle is on a recognized road and you do not press the **Start Route** button, the system defaults to the **Fastest Route** option and begins guidance.

Point of Interest (POI) Categories

Main Categories
Food/Drink & Dining
Travel & Transportation
Financial
Emergency
Community
Health & Medicine
Automotive
Shopping

MyFord Touch™

Main Categories
Entertainment & Arts
Recreation & Sports
Government
Domestic Services

Subcategories
Restaurant
Golf
Parking
Home & Garden

Subcategories
Personal Care Services
Auto Dealership
Govt Office
Public Transit
Education

To expand these listings, press the + in front of the listing.

The system also allows you to sort alphabetically, by distance or by cityseekr listings (if available).

Range Rings and Charge Points



E161378

Shaded rings appear on the map when you are driving.

Note: You may only see them when you zoom out.

The inner ring with no shading indicates a safe range you can travel with the current battery charge.

The lightly shaded outer band reflects areas you may or may not be able to reach. If your destination is within this band, enter it into the navigation system and use the budget features in the instrument cluster to help you manage your vehicle energy usage.

MyFord Touch™

The darker shaded area, beyond the rings, is unlikely to be within range on the current battery charge.

The rings represent approximate ranges. Actual route distances, road grades, vehicle speed, accessory usage and other conditions affect how far your vehicle can travel before recharging.

You can switch off the rings in the Settings menu by pressing:

Menu Item
Settings
Navigation
Map Preferences

You can switch the charge point POIs on and off. Touch the map, use the buttons at the bottom of the screen and then select the POI icon. The icons only appear at a map scale of 5 mi (8 km) and lower.

cityseekr

Note: *cityseekr* point of interest (POI) information is limited to approximately 912 cities (881 in the United States, 20 in Canada and 11 in Mexico).



E142634

cityseekr, when available, is a service that provides more information about certain points of interest such as restaurants, hotels and attractions.

When you have selected a point of interest, the location and information appear, such as address and phone number. If cityseekr lists the point of interest, more information is available, such as a brief description, check-in and checkout times or restaurant hours.

For a longer review, a list of services and facilities, the average room, meal price or the website press:

Menu Item
More Information

This screen displays the point of interest icon such as:



Hotel



Coffeehouse



Food & Drink



Nightlife



Attraction



This icon appears when your selection exists in multiple categories within the system.

MyFord Touch™

When you are viewing more information for hotels, cityseekr also tells you if the hotel has certain services and facilities using icons, such as:

- Restaurant
- Business center
- Handicap facilities
- Laundry
- Refrigerator
- 24 hour room service
- Fitness center
- Internet access
- Pool
- Wi-Fi

For restaurants, cityseekr can provide information such as star rating, average cost, review, handicap access, hours of operation, and website address.

Map Preferences

Menu Item	Second Level Messages, Actions and Descriptions	
Map Preferences		
Then select any of the following:		
Breadcrumbs	Display your vehicle's previously traveled route with white dots. You can switch this feature:	
	On	Off
Turn List Format	Have the system display your turn list	
	Top to Bottom	Bottom to Top
Parking POI Notification	When parking point of interest notification is on, the icons display on the map when you get close to your destination. This may not be very useful in dense areas, and may clutter the map when other points of interest display. Set the automatic parking point of interest notification. You can switch this feature:	
	On	Off

For hotels, cityseekr can provide information such as star rating, price category, review, check-in and checkout times, hotel service icons and website address.

Setting Your Navigation Preferences



Select settings for the system to take into account when planning your route.

To access the settings options, press

Menu Item
Settings
Navigation
Then select any of the following:

MyFord Touch™

Route Preferences

Menu Item	Second Level Messages, Actions and Descriptions		
Route Preferences			
Then select any of the following:			
Preferred Route	Choose to have the system display your chosen route type.		
	Shortest Route	Fastest Route	Eco Route
Always use Preferred Route	Bypass route selection in destination programming. The system only calculates one route based on preferred route setting. When activated, the system uses your selected route type to calculate only one route to the desired destination.		
Eco Time Penalty	Select a level of cost for the calculated Eco Route. The higher the setting, the longer the time allotment is for the route.		
Avoid	When activated, you can to choose to have the system avoid motorways, toll roads, ferries and car trains when planning your route.		
Use HOV Lanes	Have the system use high-occupancy vehicle lanes, if available, when planning your route.		

Navigation Preferences

Menu Item	Second Level Messages, Actions and Descriptions	
Navigation Preferences		
Then select any of the following:		
Guidance Prompts	Select the type of prompts the system uses.	
	Tones Only	Voice and Tones
Auto - Fill State/Province	Have the system automatically fill in the state and province based on the information already entered into the system. You can switch this feature:	
	On	Off

MyFord Touch™

Traffic Preferences

Menu Item	Second Level Messages, Actions and Descriptions	
Traffic Preferences		
Then select any of the following:		
Avoid Traffic Problems	You can choose how you want the system to handle traffic problems along your route.	
	Automatic	Have the system reroute you to avoid traffic incidents that develop and impact the current route. The system does not provide a traffic alert notification
	Manual	Have the system always provide a traffic alert notification for traffic incidents along the planned route. You have a choice to accept or ignore the notification before making the route deviation.
Traffic alert notification	Activate traffic alert notifications on or off.	
You are also able to switch on and off the 11 traffic map icons.	These icons will alert you to traffic and driving conditions including accidents, closures and weather conditions.	

Avoid Area

Menu Item	Second Level Messages, Actions and Descriptions	
Avoid Areas	Choose areas which you want the system to avoid when calculating a route for you	
Then select any of the following:		
Add	Once you make a selection, the system tries to avoid the area(s) if possible for all routes. Select this button to program an entry, then choose a destination entry method. You can edit the name or location of a destination or remove it from your selections.	
Delete	To remove an area from your selection, choose the listing on the screen. The screen will change, then press delete and confirm the deletion.	

Map Mode

Press the green bar in the upper right area of the touchscreen to view map mode. Map mode shows advanced viewing comprised of both 2D city maps as well as 3D landmarks (when available).

2D city maps show detailed outlines of buildings, visible land use and land elements and detailed railway infrastructure for the most essential cities around the globe. These maps also contain features, such as town blocks, building footprints and railways.

3D landmarks appear as clear, visible objects that are typically recognizable and have a certain tourist value. The 3D landmarks appear in 3D map mode only. Coverage varies, and improves with updated map releases.



E174016

Change the appearance of the map display by repeatedly pressing the arrow button in the upper left corner of the screen. It toggles between three different map modes: Heading up, North up, and 3D.



Heading up (2D map) always shows the direction of forward travel to be upward on the screen.

This view is available for map scales up to 2.5 miles (4 kilometers). The system remembers this setting for larger map scales, but shows the map in North up only. If the scale returns below this level, the system restores Heading up.



North up (2D map) always shows the northern direction to be upward on the screen.



3D map mode provides an elevated perspective of the map. You can adjust the viewing angle and rotate the map 180 degrees by touching the map twice, and then dragging your finger along the shaded bar with arrows at the bottom of the map.

You can also select the following options:

Menu Items	Description
View	Switches between full map, street list and exit view in route guidance.
Menu	Displays a pop-up box that allows direct access to navigation settings.



Press the speaker button on the map to mute route guidance. When the light on the button illuminates, the feature is on. The speaker button appears on the map only when route guidance is active.



Re-center the map by pressing this icon whenever you scroll the map away from your vehicle's current location.

Auto Zoom

Press the green bar to access map mode, then select the **+** or **-** zoom button to bring up the zoom level and Auto buttons on the touchscreen. When you press **Auto**, Auto Zoom turns on and **Auto** displays in the bottom left corner of the screen in the map scale. The map zoom level then

synchronizes with vehicle speed. The slower your vehicle is traveling, the farther in the map zooms in; the faster your vehicle is traveling, the farther the map zooms out. To switch the feature off, just press the **+** or **-** button again.

In 3D mode, rotate the map view by swiping your finger across the shaded bar with the arrows.

The ETA box under the zoom buttons appears when a route is active and displays the distance and time to your destination. If you press the button, a pop up appears with the destination listed (and waypoint, if applicable) along with mileage and time to destination. You may also select to have either the estimated time to reach your destination or your estimated arrival time.

Map Icons



Vehicle mark shows the current location of your vehicle. It stays in the center of the map display, except when in scroll mode.



Scroll cursor allows you to scroll the map; the fixed icon is in the center of the screen. The map position closest to the cursor is in a window on the top center part of the screen.



Address book entry default icon (s) indicates the location on the map of an address book entry. This is the default symbol shown after you store the entry to the Address Book by any method other than the map. You can select from any of the 22 icons available. You can use each icon more than once.



Home indicates the location on the map currently stored as the home position. You can only save one address from the Address Book as your Home entry. You cannot change this icon.



POI (Point of Interest) icons indicate locations of any point of interest categories you choose to display on the map. You can choose to display three point of interest categories on the map at one time.



Starting point indicates the starting point of a planned route.



Waypoint indicates the location of a waypoint on the map. The number inside the circle is different for each waypoint and represents the position of the waypoint in the route list.



Destination symbol indicates the ending point of a planned route.



Next maneuver point indicates the location of the next turn on the planned route.



No GPS symbol indicates that insufficient GPS satellite signals are available for accurate map positioning. This icon may display under normal operation in an area with poor GPS access.

Quick-touch Buttons

When in map mode, touch anywhere on the map display to access the following options:

MyFord Touch™

Menu Item	Action and Description	
Set as Dest	Touch this button to select a scrolled location on the map as your destination. You may scroll the map by pressing your index finger on the map display. When you reach the desired location, simply let go and then touch this button.	
Set as Waypoint	Touch this button to set the current location as a waypoint.	
Save to Favorites	Touch this button to save the current location to your favorites.	
POI Icons	Touch this button to select icons to display on the map. You can select up to three icons to display on the map at the same time. You can switch these features:	
	<table border="1"> <tr> <td>On</td> <td>Off</td> </tr> </table>	On
On	Off	
View / Edit Route	When on an active route, select any of the following options:	
	View Route	
	Edit Destination/Waypoints	
	Edit Turn List	
	Detour	
	Edit Route Preferences	
	Edit Traffic Preferences	
Cancel Route		

HERE is the digital map provider for the navigation application. If you find map data errors, you may report them directly to Here by going to www.here.com/mapcreator. HERE evaluates all reported map errors and responds with the result of their investigation by e-mail.

Navigation Map Updates

Annual navigation map updates are available for purchase through your dealership, by calling 1-866-462-8837 (in Mexico, call 01-800-557-5539) or going to www.navigation.com/sync. You need to specify the make and model of your vehicle to determine if there is an update available.

Navigation Voice Commands



When in navigation mode, press the voice button on the steering wheel controls.

MyFord Touch™

After the tone, say any of the following or a similar command:

Voice command
Destination
Zoom Out
Zoom In
Where Am I
Help

The following commands can only be used when a navigation route is active:

Voice command
Detour
Cancel Route
Show Route
Repeat Instruction
Turn List

One-shot Destination Street Address

To set a destination with voice commands, you can say:

Voice Command	Action and Description
Find an Address	The system asks you to say the full address. The system displays an example on-screen.

You can then speak the address naturally, such as "One two three four Main Street, Anytown".

MYFORD TOUCH™ TROUBLESHOOTING

Your SYNC system is easy to use. However, should questions arise, see the tables below.

Use the website at any time to check your phone's compatibility, register your account and set preferences as well as access a customer representative via an online chat (during certain hours). For more information visit:

Websites
www.SYNCMYRide.com
www.SYNCMYRide.ca
www.syncmaroute.ca

MyFord Touch™

Phone issues		
Issue	Possible cause(s)	Possible solution(s)
There is excessive background noise during a phone call.	The audio control settings on your phone may be affecting SYNC performance.	Review your phone's manual about audio adjustments.
During a call, I can hear the other person but they cannot hear me.	This may be a possible phone malfunction.	Try turning off the device, resetting the device, removing the device's battery, then trying again.
SYNC is not able to download my phonebook.	This is a phone-dependent feature. This may be a possible phone malfunction.	Go to the website to review your phone's compatibility. Try turning off the device, resetting the device or removing the device's battery, then trying again. Try pushing your phonebook contacts to SYNC by using the Add Contacts feature. Use the SYNCmyphone feature available on the website.
The system says Phonebook Downloaded but the phonebook in SYNC is empty or missing contacts.	This may be a limitation on your phone's capability.	Try pushing your phonebook contacts to SYNC by using the Add Contacts feature. If the missing contacts are stored on your SIM card, try moving them to the device memory. Remove any pictures or special ring tones associated with the missing contact.

MyFord Touch™

Phone issues		
Issue	Possible cause(s)	Possible solution(s)
		Depending upon your phone, you may have to grant SYNC permission to access your phonebook contacts. Make sure to confirm when prompted by your phone during the phonebook download.
I am having trouble connecting my phone to SYNC.	This is a phone-dependent feature. This may be a possible phone malfunction.	Go to the website to review your phone's compatibility. Try turning off the device, resetting the device or removing the device's battery, then trying again. Try deleting your device from SYNC, deleting SYNC from your device and trying again. Check the security and auto accept and prompt always settings relative to the SYNC Bluetooth connection on your phone. Update your device's firmware. Turn off the Auto phonebook download setting. You can also preform the MyFord Touch reset procedure.
Text messaging is not working on SYNC.	This is a phone-dependent feature. This may be a possible phone malfunction.	Go to the website to review your phone's compatibility. Try turning off the device, resetting the device or removing the device's battery, then trying again.

MyFord Touch™

USB and media issues		
Issue	Possible cause(s)	Possible solution(s)
I am having trouble connecting my device.	This may be a possible device malfunction.	Try turning off the device, resetting the device, removing the device's battery, then trying again. Make sure you are using the manufacturer's cable. Make sure you insert the USB cable correctly into the device and the USB port. Make sure that the device does not have an auto-install program or active security settings.
SYNC does not recognize my device when I turn on the car.	This is a device limitation.	Make sure you are not leaving the device in your vehicle during very hot or cold temperatures.
Bluetooth audio does not stream.	This is a phone-dependent feature. The device is not connected.	Review the device compatibility chart on the SYNC website to confirm your phone supports the Bluetooth audio streaming function. Make sure you correctly connect the device to SYNC, and that you have pressed play on your device. You can also preform the MyFord Touch reset procedure.
SYNC does not recognize music that is on my device.	Your music files may not contain the correct artist, song title, album or genre information. The file may be corrupted. The song may have copyright protection, which does not allow it to play.	Make sure that all song details are populated. Some devices require you to change the USB settings from mass storage to MTP class.

MyFord Touch™

Vehicle Health Report and Services (Traffic, Directions and Information) issues		
Issue	Possible cause(s)	Possible solution(s)
I received a text that I did not activate Vehicle Health Report.	You did not activate your account on the website. You may have the wrong VIN (vehicle identification number) listed.	This is a free feature, but you must first register online to use it. Make sure that your VIN is correctly listed in your account.
I am unable to retrieve the report on the website, or I receive a system error.	The preferred dealer information did not load correctly.	When you register your account, you must choose a preferred dealer. If it already lists a dealer, try selecting another dealer and logging out. Log back in, change it back to your preferred dealer, and retrieve the report.
I am unable to submit a report.	This could be due to your phone's compatibility. Bad signal strength. You did not register your phone correctly on the website.	Update your cellular number in your account on the website. Make sure you have full signal strength and that your Bluetooth volume level has been turned up. Make sure the currently connected phone is registered on your SYNCMyRide account. Try deleting your phone and performing a clean pairing.
I heard a commercial when I tried to use Traffic, Directions and Information.	You did not activate this phone for this service. Your phone has ID blocker active.	This is a free feature, but you must first register online to use it. Turn off ID blocker on your phone as the system recognizes you by your phone number. Make sure the currently connected phone is the same one that is registered on your SYNCMyRide account.

MyFord Touch™

Voice command issues		
Issue	Possible cause(s)	Possible solution(s)
SYNC does not understand what I am saying.	You may be using the wrong voice commands. You may be speaking too soon or at the wrong time.	Review the phone voice commands and the media voice commands at the beginning of their respective sections. After pressing the voice icon, wait until after the tone sounds and Listening appears before saying a command. Any command spoken before this does not register with the system.
SYNC does not understand the name of a song or artist.	You may be using the wrong voice commands. You may be saying the name differently than the way you saved it. The system may not be reading the name the same way you are saying it.	Review the media voice commands at the beginning of the media section. Say the song or artist exactly as listed. If you say "Play Artist Prince", the system does not play music by Prince and the Revolution or Prince and the New Power Generation. Make sure you are saying the complete title, such as "California remix featuring Jennifer Nettles". If the song titles are in all CAPS, you have to spell them. LOLA requires you to say "L-O-L-A". Do not use special characters in the title. The system does not recognize them.
SYNC does not understand or is calling the wrong contact when I want to make a call.	You may be using the wrong voice commands. You may be saying the name differently than the way you saved it.	Review the Phone voice commands at the beginning of the phone section.

MyFord Touch™

Voice command issues		
Issue	Possible cause(s)	Possible solution(s)
	<p>The system may not be reading the name the same way you are saying it. Contacts in your phonebook may be very short and similar, or they may contain special characters. Your phonebook contacts may be in CAPS.</p>	<p>Make sure you are saying the contacts exactly as they are listed. For example, if you save a contact as Joe Wilson, say "Call Joe Wilson".</p> <p>Using the SYNC phone menu, open the phonebook and scroll to the name SYNC is having trouble understanding. SYNC will read the name to you, giving you some idea of the pronunciation SYNC is expecting.</p> <p>The system works better if you list full names, such as "Joe Wilson" rather than "Joe".</p> <p>Do not use special characters, such as 123 or ICE, as the system does not recognize them.</p> <p>If a contact is in CAPS, you have to spell it. JAKE requires you to say "Call J-A-K-E".</p>

Touchscreen System Reset

The touchscreen system has System Reset feature that can be performed if the function of a SYNC feature is lost. This reset is intended to restore functionality and will not erase any information previously stored in the system (such as paired devices, phonebook, call history, text messages, or user settings). To perform a System Reset, press and hold the Seek Up (>>) button while pressing and holding the Radio Power button. After approximately 5 seconds the screen will go black. Allow a 1-2 minutes for the system reset to complete. You may then resume using the SYNC system.

Accessories

For a complete listing of the accessories that are available for your vehicle, contact an authorized dealer or visit our online store at www.Accessories.Ford.com (United States only).

Ford Accessories are available for your vehicle through an authorized Ford dealer. Ford Motor Company repairs or replaces any properly authorized dealer-installed Ford Original Accessory found to be defective in factory-supplied materials or workmanship during the warranty period, as well as any component damaged by the defective accessories. Ford Motor Company warrants your Ford Original Accessory through the warranty that provides the greatest benefit:

- 24 months, unlimited mileage.
- The remainder of your new vehicle limited warranty.

Contact an authorized dealer for details and a copy of the warranty.

Exterior style

- Accent lights.
- Graphics.
- Keyless entry.
- Side window deflectors.
- Splash guards.
- Spoilers.

Interior style

- All-weather floor mats.
- Cargo area protectors.
- Cargo organizers.
- Illuminated door sills.
- Premium carpeted floor mats.
- Rear seat entertainment*.
- Shift knobs.

Lifestyle

- Ash cup and smokers packages.
- Roof racks and carriers*.

Peace of mind

- Bumper-mounted parking sensor*.
- Full vehicle covers*.
- Locking fuel plug.
- Vehicle security systems.
- Wheel locks.

*Ford Licensed Accessory. The accessory manufacturer designs, develops and therefore warrants Ford Licensed Accessories, and does not design or test these accessories to Ford Motor Company engineering requirements. Contact an authorized Ford dealer for the manufacturer's limited warranty details and request a copy of the Ford Licensed Accessories product limited warranty from the accessory manufacturer.

Accessories

For maximum vehicle performance, keep the following information in mind when adding accessories, equipment, passengers and luggage to your vehicle:

- Do not exceed the total weight capacity of the vehicle or of the front or rear axle (GVWR or GAWR as indicated on the Safety Compliance Certification label). Consult an authorized dealer for specific weight information.
- The Federal Communications Commission (FCC) and Canadian Radio Telecommunications Commission (CRTC) regulate the use of radio transmitter-equipped mobile communications systems, for example, two-way radios, telephones and theft alarms. Any such equipment should comply with the Federal Communications Commission (FCC) and Canadian Radio Telecommunications Commission (CRTC) regulations, and an authorized dealer should install this equipment.
- An authorized dealer should install mobile communications systems. Improper installation may harm the operation of your vehicle, particularly if the manufacturer did not design the mobile communication system specifically for automotive use.
- If you or an authorized dealer add any non-Ford electrical or electronic accessories or components to your vehicle, you may adversely affect battery performance and durability. In addition, you may also adversely affect the performance of other electrical systems in the vehicle.

Appendices

END USER LICENSE AGREEMENT

SYNC End User License Agreement (EULA)

- You have acquired a device ("DEVICE") that includes software licensed by Ford Motor Company and its affiliates ("FORD MOTOR COMPANY") from an affiliate of Microsoft Corporation ("MS"). Those installed software products of MS origin, as well as associated media, printed materials, and "online" or electronic documentation ("MS SOFTWARE") are protected by international intellectual property laws and treaties. The MS SOFTWARE is licensed, not sold. All rights reserved.
- The MS SOFTWARE may interface with and/or communicate with, or may be later upgraded to interface with and/or communicate with additional software and/or systems provided by FORD MOTOR COMPANY. The additional software and systems of FORD MOTOR COMPANY origin, as well as associated media, printed materials, and "online" or electronic documentation ("FORD SOFTWARE") are protected by international intellectual property laws and treaties. The FORD SOFTWARE is licensed, not sold. All rights reserved.

- The MS SOFTWARE and/or FORD SOFTWARE may interface with and/or communicate with, or may be later upgraded to interface with and/or communicate with additional software and/or systems provided by third party software and service suppliers. The additional software and services of third party origin, as well as associated media, printed materials, and "online" or electronic documentation ("THIRD PARTY SOFTWARE") are protected by international intellectual property laws and treaties. The THIRD PARTY SOFTWARE is licensed, not sold. All rights reserved.
- The MS SOFTWARE, FORD SOFTWARE and THIRD PARTY SOFTWARE hereinafter collectively and individually will be referred to as "SOFTWARE".

IF YOU DO NOT AGREE TO THIS END USER LICENSE AGREEMENT ("EULA") DO NOT USE THE DEVICE OR COPY THE SOFTWARE. ANY USE OF THE SOFTWARE, INCLUDING BUT NOT LIMITED TO USE ON THE DEVICE, WILL CONSTITUTE YOUR AGREEMENT TO THIS EULA (OR RATIFICATION OF ANY PREVIOUS CONSENT).

GRANT OF SOFTWARE LICENSE: This EULA grants you the following license:

- You may use the SOFTWARE as installed on the DEVICE and as otherwise interfacing with systems and/or services provide by or through FORD MOTOR COMPANY or its third party software and service providers.

Appendices

Description of Other Rights and Limitations

- **Speech Recognition:** If the SOFTWARE includes speech recognition component(s), you should understand that speech recognition is an inherently statistical process and that recognition errors are inherent in the process. Neither FORD MOTOR COMPANY nor its suppliers shall be liable for any damages arising out of errors in the speech recognition process.
- **Limitations on Reverse Engineering, Decompilation and Disassembly:** You may not reverse engineer, decompile, or disassemble nor permit others to reverse engineer, decompile or disassemble the SOFTWARE, except and only to the extent that such activity is expressly permitted by applicable law notwithstanding this limitation.
- **Limitations on Distributing, Copying, Modifying and Creating Derivative Works:** You may not distribute, copy, make modifications to or create derivative works based on the SOFTWARE, except and only to the extent that such activity is expressly permitted by applicable law notwithstanding this limitation.
- **Single EULA:** The end user documentation for the DEVICE and related systems and services may contain multiple EULAs, such as multiple translations and/or multiple media versions (e.g., in the user documentation and in the software). Even if you receive multiple EULAs, you are licensed to use only one (1) copy of the SOFTWARE.
- **SOFTWARE Transfer:** You may permanently transfer your rights under this EULA only as part of a sale or transfer of the DEVICE, provided you retain no copies, you transfer all of the SOFTWARE (including all component parts, the media and printed materials, any upgrades, and, if applicable, the Certificate(s) of Authenticity), and the recipient agrees to the terms of this EULA. If the SOFTWARE is an upgrade, any transfer must include all prior versions of the SOFTWARE.
- **Termination:** Without prejudice to any other rights, FORD MOTOR COMPANY or MS may terminate this EULA if you fail to comply with the terms and conditions of this EULA.
- **Security Updates/Digital Rights Management:** Content owners use the WMDRM technology included in your DEVICE to protect their intellectual property, included copyrighted content. Portions of the SOFTWARE on your DEVICE use WMDRM software to access WMDRM-protected content. If the WMDRM software fails to protect the content, content owners may ask Microsoft to revoke the SOFTWARE's ability to use WMDRM to play or copy protected content. This action does not affect unprotected content. When your DEVICE downloads licenses for protected content, you agree that Microsoft may include a revocation list with the licenses. Content owners may require you to upgrade the SOFTWARE on your DEVICE to access their content. If you decline an upgrade, you will not be able to access content that requires the upgrade.

Appendices

- **Consent to Use of Data:** You agree that MS, Microsoft Corporation, FORD MOTOR COMPANY, third party software and systems suppliers, their affiliates and/or their designated agent may collect and use technical information gathered in any manner as part of product support services related to the SOFTWARE or related services. MS, Microsoft Corporation, FORD MOTOR COMPANY, third party software and services suppliers, their affiliates and/or their designated agent may use this information solely to improve their products or to provide customized services or technologies to you. MS, Microsoft Corporation, FORD MOTOR COMPANY, third party software and systems suppliers, their affiliates and/or their designated agent may disclose this information to others, but not in a form that personally identifies you.
- **Internet-Based Services Components:** The SOFTWARE may contain components that enable and facilitate the use of certain Internet-based services. You acknowledge and agree that MS, Microsoft Corporation, FORD MOTOR COMPANY, third party software and service suppliers, their affiliates and/or their designated agent may automatically check the version of the SOFTWARE and/or its components that you are utilizing and may provide upgrades or supplements to the SOFTWARE that may be automatically downloaded to your DEVICE.
- **Additional Software/Services:** The SOFTWARE may permit FORD MOTOR COMPANY, third party software and service suppliers, MS, Microsoft Corporation, their affiliates and/or their designated agent to provide or make available to you SOFTWARE updates,

supplements, add-on components, or Internet-based services components of the SOFTWARE after the date you obtain your initial copy of the SOFTWARE ("Supplemental Components").

If FORD MOTOR COMPANY or third party software and services suppliers provide or make available to you Supplemental Components and no other EULA terms are provided along with the Supplemental Components, then the terms of this EULA shall apply.

If MS, Microsoft Corporation, their affiliates and/or their designated agent make available Supplemental Components, and no other EULA terms are provided, then the terms of this EULA shall apply, except that the MS, Microsoft Corporation or affiliate entity providing the Supplemental Component(s) shall be the licensor of the Supplemental Component(s).

FORD MOTOR COMPANY, MS, Microsoft Corporation, their affiliates and/or their designated agent reserve the right to discontinue without liability any Internet-based services provided to you or made available to you through the use of the SOFTWARE.

Appendices

- **Links to Third Party Sites:** The MS SOFTWARE may provide you with the ability to link to third party sites through the use of the SOFTWARE. The third party sites are not under the control of MS, Microsoft Corporation, their affiliates and/or their designated agent. Neither MS nor Microsoft Corporation nor their affiliates nor their designated agent are responsible for (i) the contents of any third party sites, any links contained in third party sites, or any changes or updates to third party sites, or (ii) webcasting or any other form of transmission received from any third party sites. If the SOFTWARE provides links to third party sites, those links are provided to you only as a convenience, and the inclusion of any link does not imply an endorsement of the third party site by MS, Microsoft Corporation, their affiliates and/or their designated agent.
- **Obligation to Drive Responsibly:** You recognize your obligation to drive responsibly and keep attention on the road. You will read and abide with the DEVICE operating instructions particularly as they pertain to safety and assumes any risk associated with the use of the DEVICE.

UPGRADES AND RECOVERY MEDIA:

If the SOFTWARE is provided by FORD MOTOR COMPANY separate from the DEVICE on media such as a ROM chip, CD ROM disk(s) or via web download or other means, and is labeled "For Upgrade Purposes Only" or "For Recovery Purposes Only" you may install one (1) copy of such SOFTWARE onto the DEVICE as a replacement copy for the existing SOFTWARE, and use it in accordance with this EULA, including any additional EULA terms accompanying the upgrade SOFTWARE.

INTELLECTUAL PROPERTY RIGHTS:

All title and intellectual property rights in and to the SOFTWARE (including but not limited to any images, photographs, animations, video, audio, music, text and "applets" incorporated into the SOFTWARE), the accompanying printed materials, and any copies of the SOFTWARE, are owned by MS, Microsoft Corporation, FORD MOTOR COMPANY, or their affiliates or suppliers. The SOFTWARE is licensed, not sold. You may not copy the printed materials accompanying the SOFTWARE. All title and intellectual property rights in and to the content which may be accessed through use of the SOFTWARE is the property of the respective content owner and may be protected by applicable copyright or other intellectual property laws and treaties. This EULA grants you no rights to use such content. All rights not specifically granted under this EULA are reserved by MS, Microsoft Corporation, FORD MOTOR COMPANY, third party software and service providers, their affiliates and suppliers. Use of any on-line services which may be accessed through the SOFTWARE may be governed by the respective terms of use relating to such services. If this SOFTWARE contains documentation that is provided only in electronic form, you may print one copy of such electronic documentation.

EXPORT RESTRICTIONS: You acknowledge that the SOFTWARE is subject to U.S. and European Union export jurisdiction. You agree to comply with all applicable international and national laws that apply to the SOFTWARE, including the U.S. Export Administration Regulations, as well as end-user, end-use and destination restrictions issued by U.S. and other governments. For additional information, see <http://www.microsoft.com/exporting/>.

Appendices

TRADEMARKS: This EULA does not grant you any rights in connection with any trademarks or service marks of FORD MOTOR COMPANY, MS, Microsoft Corporation, third party software or service providers, their affiliates or suppliers.

PRODUCT SUPPORT: Product support for the SOFTWARE is not provided by MS, its parent corporation Microsoft Corporation, or their affiliates or subsidiaries. For product support, please refer to FORD MOTOR COMPANY instructions provided in the documentation for the DEVICE. Should you have any questions concerning this EULA, or if you desire to contact FORD MOTOR COMPANY for any other reason, please refer to the address provided in the documentation for the DEVICE.

No Liability for Certain Damages: EXCEPT AS PROHIBITED BY LAW, FORD MOTOR COMPANY, ANY THIRD PARTY SOFTWARE OR SERVICES SUPPLIERS, MS, MICROSOFT CORPORATION AND THEIR AFFILIATES SHALL HAVE NO LIABILITY FOR ANY INDIRECT, SPECIAL, CONSEQUENTIAL OR INCIDENTAL DAMAGES ARISING FROM OR IN CONNECTION WITH THE USE OR PERFORMANCE OF THE SOFTWARE. THIS LIMITATION SHALL APPLY EVEN IF ANY REMEDY FAILS OF ITS ESSENTIAL PURPOSE. IN NO EVENT SHALL MS, MICROSOFT CORPORATION AND/OR THEIR AFFILIATES BE LIABLE FOR ANY AMOUNT IN EXCESS OF U.S. TWO HUNDRED FIFTY DOLLARS (U.S. \$250.00).

- THERE ARE NO WARRANTIES OTHER THAN THOSE THAT MAY EXPRESSLY BE PROVIDED FOR YOUR NEW VEHICLE.

Adobe

Contains Adobe® [Flash® Player] or [AIR®] technology by Adobe Systems Incorporated. This [Licensee Product] contains [Adobe® Flash® Player] [Adobe® AIR®] software under license from Adobe Systems Incorporated, Copyright ©1995-2009 Adobe Macromedia Software LLC. All rights reserved. Adobe, Flash and AIR are trademarks of Adobe Systems Incorporated.

End User Notice

Microsoft® Windows® Mobile for Automotive Important Safety Information

This system Ford SYNC contains software that is licensed to Manufacturer FORD MOTOR COMPANY by an affiliate of Microsoft Corporation pursuant to a license agreement. Any removal, reproduction, reverse engineering or other unauthorized use of the software from this system in violation of the license agreement is strictly prohibited and may subject you to legal action.

Read and follow instructions: Before using your Windows Automotive- based system, read and follow all instructions and safety information provided in this end user manual ("User's Guide"). Not following precautions found in this User's Guide can lead to an accident or other serious consequences.

Keep User's Guide in vehicle: When kept in the vehicle, the User's Guide will be a ready reference for you and other users unfamiliar with the Windows Automotive-based system. Please make certain that before using the system for the first time, all persons have access to the User's Guide and read its instructions and safety information carefully.

Appendices

WARNING



Operating certain parts of this system while driving can distract your attention away from the road, and possibly cause an accident or other serious consequences. Do not change system settings or enter data non-verbally (using your hands) while driving. Stop the vehicle in a safe and legal manner before attempting these operations. This is important since while setting up or changing some functions you might be required to distract your attention away from the road and remove your hands from the wheel.

General Operation

Voice Command Control: Functions within the Windows Automotive-based system may be accomplished using only voice commands. Using voice commands while driving allows you to operate the system without removing your hands from the wheel.

Prolonged Views of Screen: Do not access any function requiring a prolonged view of the screen while you are driving. Pull over in a safe and legal manner before attempting to access a function of the system requiring prolonged attention. Even occasional short scans to the screen may be hazardous if your attention has been diverted away from your driving task at a critical time.

Volume Setting: Do not raise the volume excessively. Keep the volume at a level where you can still hear outside traffic and emergency signals while driving. Driving while unable to hear these sounds could cause an accident.

Use of Speech Recognition Functions:

Speech recognition software is inherently a statistical process which is subject to errors. It is your responsibility to monitor any speech recognition functions included in the system and address any errors.

Navigation Features: Any navigation features included in the system are intended to provide turn by turn instructions to get you to a desired destination. Please make certain all persons using this system carefully read and follow instructions and safety information fully.

Distraction Hazard: Any navigation features may require manual (non-verbal) setup. Attempting to perform such set-up or insert data while driving can seriously distract your attention and could cause an accident or other serious consequences. Stop the vehicle in a safe and legal manner before attempting these operations.

Let Your Judgment Prevail: Any navigation features are provided only as an aid. Make your driving decisions based on your observations of local conditions and existing traffic regulations. Any such feature is not a substitute for your personal judgment. Any route suggestions made by this system should never replace any local traffic regulations or your personal judgment or knowledge of safe driving practices.

Route Safety: Do not follow the route suggestions if doing so would result in an unsafe or illegal maneuver, if you would be placed in an unsafe situation, or if you would be directed into an area that you consider unsafe. The driver is ultimately responsible for the safe operation of the vehicle and therefore, must evaluate whether it is safe to follow the suggested directions.

Appendices

Potential Map Inaccuracy: Maps used by this system may be inaccurate because of changes in roads, traffic controls or driving conditions. Always use good judgment and common sense when following the suggested routes.

Emergency Services: Do not rely on any navigation features included in the system to route you to emergency services. Ask local authorities or an emergency services operator for these locations. Not all emergency services such as police, fire stations, hospitals and clinics are likely to be contained in the map database for such navigation features.

Telenav Software End User License Agreement

Please read these terms and conditions carefully before you use the Telenav Software. Your use of the Telenav Software indicates that you accept these terms and conditions. If you do not accept these terms and conditions, do not break the seal of the package, launch, or otherwise use the Telenav Software.

These terms and conditions represent the agreement ("Agreement") between you and Telenav, Inc. ("Telenav") with respect to the Telenav Software (including upgrades, modifications, or additions thereto) (collectively "Telenav Software"). All references herein to "you" and "your" means you, your employees, agents, and contractors, and any other entity on whose behalf you accept these terms and conditions, all of whom shall also be bound by this Agreement. Additionally, all of your account information, as well as other payment and personal information provided by you to Telenav (directly or through the use of the Telenav Software, is subject to Telenav's privacy policy located at <http://www.telenav.com>.

Telenav may revise this Agreement and the privacy policy at any time, with or without notice to you. You agree to visit <http://www.telenav.com> from time to time to review the then current version of this Agreement and of the privacy policy.

1. Safe and Lawful Use

You acknowledge that devoting attention to the Telenav Software may pose a risk of injury or death to you and others in situations that otherwise require your undivided attention, and you therefore agree to comply with the following when using the Telenav Software: (a) observe all traffic laws and otherwise drive safely; (b) use your own personal judgment while driving. If you feel that a route suggested by the Telenav Software instructs you to perform an unsafe or illegal maneuver, places you in an unsafe situation, or directs you into an area that you consider to be unsafe, do not follow such instructions; (c) do not input destinations, or otherwise manipulate the Telenav Software, unless your vehicle is stationary and parked; (d) do not use the Telenav Software for any illegal, unauthorized, unintended, unsafe, hazardous, or unlawful purposes, or in any manner inconsistent with this Agreement; (e) arrange all GPS and wireless devices and cables necessary for use of the Telenav Software in a secure manner in your vehicle so that they will not interfere with your driving and will not prevent the operation of any safety device (such as an airbag).

You agree to indemnify and hold Telenav harmless against all claims resulting from any dangerous or otherwise inappropriate use of the Telenav Software in any moving vehicle, including as a result of your failure to comply with the directions above.

Appendices

2. Account Information

You agree: (a) when registering the Telenav Software, to provide Telenav with true, accurate, current, and complete information about yourself, and (b) to inform Telenav promptly of any changes to such information, and to keep it true, accurate, current and complete.

3. Software License

Subject to your compliance with the terms of this Agreement, Telenav hereby grants to you a personal, non-exclusive, non-transferable license (except as expressly permitted below in connection with your permanent transfer of the Telenav Software license), without the right to sublicense, to use the Telenav Software (in object code form only) in order to access and use the Telenav Software. This license shall terminate upon any termination or expiration of this Agreement. You agree that you will use the Telenav Software only for your personal business or leisure purposes, and not to provide commercial navigation services to other parties.

3.1 License Limitations

You agree not to do any of the following: (a) reverse engineer, decompile, disassemble, translate, modify, alter or otherwise change the Telenav Software or any part thereof; (b) attempt to derive the source code, audio library or structure of the Telenav Software without the prior express written consent of Telenav; (c) remove from the Telenav Software, or alter, any of Telenav's or its suppliers' trademarks, trade names, logos, patent or copyright notices, or other notices or markings; (d) distribute, sublicense or otherwise transfer the Telenav Software to others, except as part of your permanent transfer of the Telenav Software; or (e) use the Telenav Software in any manner that (i) infringes the intellectual property

or proprietary rights, rights of publicity or privacy or other rights of any party, (ii) violates any law, statute, ordinance or regulation, including but not limited to laws and regulations related to spamming, privacy, consumer and child protection, obscenity or defamation, or (iii) is harmful, threatening, abusive, harassing, tortuous, defamatory, vulgar, obscene, libelous, or otherwise objectionable; and (f) lease, rent out, or otherwise permit unauthorized access by third parties to the Telenav Software without advanced written permission of Telenav.

4. Disclaimers

To the fullest extent permissible pursuant to applicable law, in no event will Telenav, its licensors and suppliers, or agents or employees of any of the foregoing, be liable for any decision made or action taken by you or anyone else in reliance on the information provided by the Telenav Software. Telenav also does not warrant the accuracy of the map or other data used for the Telenav Software. Such data may not always reflect reality due to, among other things, road closures, construction, weather, new roads and other changing conditions. You are responsible for the entire risk arising out of your use of the Telenav Software. For example but without limitation, you agree not to rely on the Telenav Software for critical navigation in areas where the well-being or survival of you or others is dependent on the accuracy of navigation, as the maps or functionality of the Telenav Software are not intended to support such high risk applications, especially in more remote geographical areas.

TELENAV EXPRESSLY DISCLAIMS AND EXCLUDES ALL WARRANTIES IN CONNECTION WITH THE TELENNAV SOFTWARE, WHETHER STATUTORY, EXPRESS OR IMPLIED, INCLUDING ALL WARRANTIES WHICH MAY ARISE FROM

Appendices

COURSE OF DEALING, CUSTOM OR TRADE AND INCLUDING, BUT NOT LIMITED TO, THE IMPLIED WARRANTIES OF MERCHANTABILITY, FITNESS FOR A PARTICULAR PURPOSE AND NON-INFRINGEMENT OF THIRD PARTY RIGHTS WITH RESPECT TO THE TELENAV SOFTWARE. Certain jurisdictions do not permit the disclaimer of certain warranties, so this limitation may not apply to you.

5. Limitation of Liability

TO THE EXTENT PERMITTED UNDER APPLICABLE LAW, UNDER NO CIRCUMSTANCES SHALL TELENAV OR ITS LICENSORS AND SUPPLIERS BE LIABLE TO YOU OR TO ANY THIRD PARTY FOR ANY INDIRECT, INCIDENTAL, CONSEQUENTIAL, SPECIAL OR EXEMPLARY DAMAGES (INCLUDING IN EACH CASE, BUT NOT LIMITED TO, DAMAGES FOR THE INABILITY TO USE THE EQUIPMENT OR ACCESS DATA, LOSS OF DATA, LOSS OF BUSINESS, LOSS OF PROFITS, BUSINESS INTERRUPTION OR THE LIKE) ARISING OUT OF THE USE OF OR INABILITY TO USE THE TELENAV SOFTWARE, EVEN IF TELENAV HAS BEEN ADVISED OF THE POSSIBILITY OF SUCH DAMAGES.

NOTWITHSTANDING ANY DAMAGES THAT YOU MIGHT INCUR FOR ANY REASON WHATSOEVER (INCLUDING, WITHOUT LIMITATION, ALL DAMAGES REFERENCED HEREIN AND ALL DIRECT OR GENERAL DAMAGES IN CONTRACT, TORT (INCLUDING NEGLIGENCE) OR OTHERWISE), THE ENTIRE LIABILITY OF TELENAV AND OF ALL OF TELENAV'S SUPPLIERS SHALL BE LIMITED TO THE AMOUNT ACTUALLY PAID BY YOU FOR THE TELENAV SOFTWARE. SOME

STATES AND/OR JURISDICTIONS DO NOT ALLOW THE EXCLUSION OR LIMITATION OF INCIDENTAL OR CONSEQUENTIAL DAMAGES, SO THE ABOVE LIMITATIONS OR EXCLUSIONS MAY NOT APPLY TO YOU.

6. Arbitration and Governing Law

You agree that any dispute, claim or controversy arising out of or relating to this Agreement or the Telenav Software shall be settled by independent arbitration involving a neutral arbitrator and administered by the American Arbitration Association in the County of Santa Clara, California. The arbitrator shall apply the Commercial Arbitration Rules of the American Arbitration Association, and the judgment upon the award rendered by the arbitrator may be entered by any court having jurisdiction. Note that there is no judge or jury in an arbitration proceeding and the decision of the arbitrator shall be binding upon both parties. You expressly agree to waive your right to a jury trial.

This Agreement and performance hereunder will be governed by and construed in accordance with the laws of the State of California, without giving effect to its conflict of laws provisions. To the extent judicial action is necessary in connection with the binding arbitration, both Telenav and you agree to submit to the exclusive jurisdiction of the courts of the County of Santa Clara, California. The United Nations Convention on Contracts for the International Sale of Goods shall not apply.

7. Assignment

You may not resell, assign, or transfer this Agreement or any of your rights or obligations, except in totality, in connection with your permanent transfer of the Telenav Software, and expressly conditioned upon the new user of the Telenav Software agreeing to be bound by

Appendices

the terms and conditions of this Agreement. Any such sale, assignment or transfer that is not expressly permitted under this paragraph will result in immediate termination of this Agreement, without liability to Telenav, in which case you and all other parties shall immediately cease all use of the Telenav Software. Notwithstanding the foregoing, Telenav may assign this Agreement to any other party at any time without notice, provided the assignee remains bound by this Agreement.

8. Miscellaneous

8.1

This Agreement constitutes the entire agreement between Telenav and you with respect to the subject matter hereof.

8.2

Except for the limited licenses expressly granted in this Agreement, Telenav retains all right, title and interest in and to the Telenav Software, including without limitation all related intellectual property rights. No licenses or other rights which are not expressly granted in this Agreement are intended to, or shall be, granted or conferred by implication, statute, inducement, estoppel or otherwise, and Telenav and its suppliers and licensors hereby reserve all of their respective rights other than the licenses explicitly granted in this Agreement.

8.3

By using the Telenav Software, you consent to receive from Telenav all communications, including notices, agreements, legally required disclosures or other information in connection with the Telenav Software (collectively, "Notices") electronically. Telenav may provide such

Notices by posting them on Telenav's Website or by downloading such Notices to your wireless device. If you desire to withdraw your consent to receive Notices electronically, you must discontinue your use of the Telenav Software.

8.4

Telenav's or your failure to require performance of any provision shall not affect that party's right to require performance at any time thereafter, nor shall a waiver of any breach or default of this Agreement constitute a waiver of any subsequent breach or default or a waiver of the provision itself.

8.5

If any provision herein is held unenforceable, then such provision will be modified to reflect the intention of the parties, and the remaining provisions of this Agreement will remain in full force and effect.

8.6

The headings in this Agreement are for convenience of reference only, will not be deemed to be a part of this Agreement, and will not be referred to in connection with the construction or interpretation of this Agreement. As used in this Agreement, the words "include" and "including," and variations thereof, will not be deemed to be terms of limitation, but rather will be deemed to be followed by the words "without limitation."

9. Other Vendors Terms and Conditions

The Telenav Software utilizes map and other data licensed to Telenav by third party vendors for the benefit of you and other end users. This Agreement includes end-user terms applicable to these companies (included at the end of this

Appendices

Agreement), and thus your use of the Telenav Software is also subject to such terms. You agree to comply with the following additional terms and conditions, which are applicable to Telenav's third party vendor licensors:

9.1 End User Terms Required by HERE North America, LLC

The data ("Data") is provided for your personal, internal use only and not for resale. It is protected by copyright, and is subject to the following terms and conditions which are agreed to by you, on the one hand, and Telenav ("Telenav") and its licensors (including their licensors and suppliers) on the other hand.

© 2013 HERE. All rights reserved.

The Data for areas of Canada includes information taken with permission from Canadian authorities, including: © Her Majesty the Queen in Right of Canada, © Queen's Printer for Ontario, © Canada Post Corporation, GeoBase®, © Department of Natural Resources Canada.

HERE holds a non-exclusive license from the United States Postal Service® to publish and sell ZIP+4® information.

©United States Postal Service® 2014. Prices are not established, controlled or approved by the United States Postal Service®. The following trademarks and registrations are owned by the USPS: United States Postal Service, USPS, and ZIP+4.

The Data for Mexico includes certain data from Instituto Nacional de Estadística y Geografía.

TERMS AND CONDITIONS

9.2 End User Terms Required by NAV2 (Shanghai) Co., Ltd

The data ("Data") is provided for your personal, internal use only and not for resale. It is protected by copyright, and is subject to the following terms and conditions which are agreed to by you, on the one hand, and NAV2 (Shanghai) Co., Ltd ("NAV2") and its licensors (including their licensors and suppliers) on the other hand.

© 20xx. All rights reserved.

Permitted Use.

You agree to use this Data together with the Telenav Software solely for the internal business and personal purposes for which you were licensed, and not for service bureau, time-sharing or other similar purposes. Accordingly, but subject to the restrictions set forth in the following paragraphs, you agree not to otherwise reproduce, copy, modify, decompile, disassemble, create any derivative works of, or reverse engineer any portion of this Data, and may not transfer or distribute it in any form, for any purpose, except to the extent permitted by mandatory laws.

Restrictions.

Except where you have been specifically licensed to do so by Telenav, and without limiting the preceding paragraph, you may not use this Data (a) with any products, systems, or applications installed or otherwise connected to or in communication with vehicles, capable of vehicle navigation, positioning, dispatch, real time route guidance, fleet management or similar applications; or (b) with or in communication with any

Appendices

positioning devices or any mobile or wireless-connected electronic or computer devices, including without limitation cellular phones, palmtop and handheld computers, pagers, and personal digital assistants or PDAs.

Warning.

The Data may contain inaccurate or incomplete information due to the passage of time, changing circumstances, sources used and the nature of collecting comprehensive geographic data, any of which may lead to incorrect results.

No Warranty.

This Data is provided to you “as is,” and you agree to use it at your own risk. Telenav and its licensors (and their licensors and suppliers) make no guarantees, representations or warranties of any kind, express or implied, arising by law or otherwise, including but not limited to, content, quality, accuracy, completeness, effectiveness, reliability, fitness for a particular purpose, usefulness, use or results to be obtained from this Data, or that the Data or server will be uninterrupted or error-free.

Disclaimer of Warranty:

TELENAV AND ITS LICENSORS (INCLUDING THEIR LICENSORS AND SUPPLIERS) DISCLAIM ANY WARRANTIES, EXPRESS OR IMPLIED, OF QUALITY, PERFORMANCE, MERCHANTABILITY, FITNESS FOR A PARTICULAR PURPOSE OR NON-INFRINGEMENT. Some States, Territories and Countries do not allow certain warranty exclusions, so to that extent the above exclusion may not apply to you.

Disclaimer of Liability:

TELENAV AND ITS LICENSORS (INCLUDING THEIR LICENSORS AND SUPPLIERS) SHALL NOT BE LIABLE TO YOU: IN RESPECT OF ANY CLAIM, DEMAND OR ACTION, IRRESPECTIVE OF THE NATURE OF THE CAUSE OF THE CLAIM, DEMAND OR ACTION ALLEGING ANY LOSS, INJURY OR DAMAGES, DIRECT OR INDIRECT, WHICH MAY RESULT FROM THE USE OR POSSESSION OF THE INFORMATION; OR FOR ANY LOSS OF PROFIT, REVENUE, CONTRACTS OR SAVINGS, OR ANY OTHER DIRECT, INDIRECT, INCIDENTAL, SPECIAL OR CONSEQUENTIAL DAMAGES ARISING OUT OF YOUR USE OF OR INABILITY TO USE THIS INFORMATION, ANY DEFECT IN THE INFORMATION, OR THE BREACH OF THESE TERMS OR CONDITIONS, WHETHER IN AN ACTION IN CONTRACT OR TORT OR BASED ON A WARRANTY, EVEN IF TELENAV OR ITS LICENSORS HAVE BEEN ADVISED OF THE POSSIBILITY OF SUCH DAMAGES. Some States, Territories and Countries do not allow certain liability exclusions or damages limitations, so to that extent the above may not apply to you.

Export Control.

You shall not export from anywhere any part of the Data or any direct product thereof except in compliance with, and with all licenses and approvals required under, applicable export laws, rules and regulations, including but not limited to the laws, rules and regulations administered by the Office of Foreign Assets Control of the U.S. Department of Commerce and the Bureau of Industry and Security of the U.S. Department of Commerce. To the extent

Appendices

that any such export laws, rules or regulations prohibit HERE from complying with any of its obligations hereunder to deliver or distribute Data, such failure shall be excused and shall not constitute a breach of this Agreement.

Entire Agreement.

These terms and conditions constitute the entire agreement between Telenav (and its licensors, including their licensors and suppliers) and you pertaining to the subject matter hereof, and supersedes in their entirety any and all written or oral agreements previously existing between us with respect to such subject matter.

Governing Law.

The above terms and conditions shall be governed by the laws of the State of Illinois [insert "Netherlands" where European HERE Data is used], without giving effect to (i) its conflict of laws provisions, or (ii) the United Nations Convention for Contracts for the International Sale of Goods, which is explicitly excluded. You agree to submit to the jurisdiction of the State of Illinois [insert "The Netherlands" where European HERE Data is used] for any and all disputes, claims and actions arising from or in connection with the Data provided to you hereunder.

Government End Users.

If the Data is being acquired by or on behalf of the United States government or any other entity seeking or applying rights similar to those customarily claimed by the United States government, this Data is a "commercial item" as that term is defined at 48 C.F.R. ("FAR") 2.101, is licensed in accordance with these End-User Terms, and each copy of Data delivered or otherwise furnished shall be marked and embedded as appropriate with the following "Notice of Use," and shall be treated in accordance with such Notice:

NOTICE OF USE

CONTRACTOR (MANUFACTURER/
SUPPLIER) NAME: HERE

CONTRACTOR (MANUFACTURER/
SUPPLIER) ADDRESS: c/o Nokia, 425
West Randolph Street, Chicago, Illinois
60606

This Data is a commercial item as defined in FAR 2.101 and is subject to these End-User Terms under which this Data was provided.

© 1987 – 2014 HERE – All rights reserved.

If the Contracting Officer, federal government agency, or any federal official refuses to use the legend provided herein, the Contracting Officer, federal government agency, or any federal official must notify HERE prior to seeking additional or alternative rights in the Data.

I. US/Canada Territory

A. United States Data. The End-User Terms for any Application containing Data for the United States shall contain the following notices:

"HERE holds a non-exclusive license from the United States Postal Service® to publish and sell ZIP+4® information."

"©United States Postal Service® 20XX. Prices are not established, controlled or approved by the United States Postal Service®. The following trademarks and registrations are owned by the USPS: United States Postal Service, USPS, and ZIP+4."

Appendices

B. Canada Data. The following provisions apply to the Data for Canada, which may include or reflect data from third party licensors (“Third Party Data”), including Her Majesty the Queen in Right of Canada (“Her Majesty”), Canada Post Corporation (“Canada Post”) and the Department of Natural Resources of Canada (“NRCan”):

1. Disclaimer and Limitation: Client agrees that its use of the Third Party Data is subject to the following provisions:

a. Disclaimer: The Third Party Data is licensed on an “as is” basis. The licensors of such data, including Her Majesty, Canada Post and NRCan, make no guarantees, representations or warranties respecting such data, either express or implied, arising by law or otherwise, including but not limited to, effectiveness, completeness, accuracy or fitness for a particular purpose.

b. Limitation on Liability: The Third Party Data licensors, including Her Majesty, Canada Post and NRCan, shall not be liable: (i) in respect of any claim, demand or action, irrespective of the nature of the cause of the claim, demand or action alleging any loss, injury or damages, direct or indirect, which may result from the use or possession of such Data; or (ii) in any way for loss of revenues or contracts, or any other consequential loss of any kind resulting from any defect in the Data.

2. Copyright Notice: In connection with each copy of all or any portion of the Data for the Territory of Canada, Client shall affix in a conspicuous manner the following copyright notice on at least one of: (i) the label for the storage media of the copy; (ii) the packaging for the copy; or (iii) other materials packaged with the copy, such as user manuals or end user license agreements: “This data includes information taken with permission from Canadian authorities, including © Her Majesty the Queen in Right of Canada, © Queen’s Printer for Ontario, © Canada Post Corporation, GeoBase®, © The Department of Natural Resources Canada. All rights reserved.”

3. End-User Terms: Except as otherwise agreed by the parties, in connection with the provision of any portion of the Data for the Territory of Canada to End-Users as may be authorized under the Agreement, Client shall provide such End-Users, in a reasonably conspicuous manner, with terms (set forth with other end user terms required to be provided under the Agreement, or as otherwise may be provided, by Client) which shall include the following provisions on behalf of the Third Party Data licensors, including Her Majesty, Canada Post and NRCan:

The Data may include or reflect data of licensors, including Her Majesty the Queen in the Right of Canada (“Her Majesty”), Canada Post Corporation (“Canada Post”) and the Department of Natural Resources Canada (“NRCan”). Such data is licensed on an “as is” basis. The licensors, including Her Majesty, Canada Post and NRCan, make no guarantees, representations or warranties respecting such data,

Appendices

either express or implied, arising by law or otherwise, including but not limited to, effectiveness, completeness, accuracy or fitness for a particular purpose. The licensors, including Her Majesty, Canada Post and NRCan, shall not be liable in respect of any claim, demand or action, irrespective of the nature of the cause of the claim, demand or action alleging any loss, injury or damages, direct or indirect, which may result from the use or possession of the data or the Data. The licensors, including Her Majesty, Canada Post and NRCan, shall not be liable in any way for loss of revenues or contracts, or any other consequential loss of any kind resulting from any defect in the data or the Data.

End User shall indemnify and save harmless the licensors, including Her Majesty, Canada Post and NRCan, and their officers, employees and agents from and against any claim, demand or action, irrespective of the nature of the cause of the claim, demand or action, alleging loss, costs, expenses, damages or injuries (including injuries resulting in death) arising out of the use or possession of the data or the Data.

4. Additional Provisions: The terms contained in this Section are in addition to all of the rights and obligations of the parties under the Agreement. To the extent that any of the provisions of this Section are inconsistent with, or conflict with, any other provisions of the Agreement, the provisions of this Section shall prevail.

II. Mexico. The following provision applies to the Data for Mexico, which includes certain data from the Instituto Nacional de Estadística y Geografía (“INEGI”):

A. Any and all copies of the Data and/or packaging containing Data for Mexico shall contain the following notice: “Fuente: INEGI (Instituto Nacional de Estadística y Geografía)”

III. Latin America Territory

A. Third Party Notices. Any and all copies of the Data and/or packaging relating thereto shall include the respective Third Party Notices set forth below and used as described below corresponding to the Territory (or portion thereof) included in such copy:

Territory Notice

Ecuador “INSTITUTO GEOGRAFICO MILITAR DEL ECUADOR AUTORIZACION N° IGM-2011-01- PCO-01 DEL 25 DE ENERO DE 2011”
“source: © IGN 2009 - BD TOPO ®”

Guadeloupe,
French
Guiana
and

Martinique “Fuente: INEGI (Instituto Nacional de Estadística y Geografía)”
Mexico

IV. Middle East Territory

Appendices

A. Third Party Notices. Any and all copies of the Data and/or packaging relating thereto shall include the respective Third Party Notices set forth below and used as described below corresponding to the Territory (or portion thereof) included in such copy:

Country Notice

Jordan “© Royal Jordanian Geographic Centre”. The foregoing notice requirement for Jordan Data is a material term of the Agreement. If Client or any of its permitted sublicensees (if any) fail to meet such requirement, HERE shall have the right to terminate Client’s license with respect to the Jordan Data.

B. Jordan Data. Client and its permitted sublicensees (if any) are restricted from licensing and/or otherwise distributing HERE’s database for the country of Jordan (“Jordan Data”) for use in Enterprise Applications to (i) non-Jordanian entities for use of the Jordan Data solely in Jordan or (ii) Jordan-based customers. In addition, Client, its permitted sublicensees (if any) and End-Users are restricted from using the Jordan Data in Enterprise Applications if such party is (i) a non-Jordanian entity using the Jordan Data solely in Jordan or (ii) a Jordan-based customer. For purposes of the foregoing, “Enterprise Applications” shall mean Geomarketing applications, GIS applications, mobile business asset management applications, call center applications, telematics applications, public organization Internet applications or for providing geocoding services.

V. Europe Territory

A. Use of Certain Traffic Codes in Europe

1. General Restrictions Applicable to Traffic Codes. Client acknowledges and agrees that in certain countries of the Europe Territory, Client will need to obtain rights directly from third party RDS-TMC code providers to receive and use the Traffic Codes in the Data and to deliver to End-Users Transactions in any way derived from or based on such Traffic Codes. For such countries, HERE shall deliver the Data incorporating Traffic Codes to Client only after receiving certification from Client of its having obtained such rights.

2. Display of Third Party Rights Legends for Belgium. Client shall, for each Transaction that uses Traffic Codes for Belgium, provide the following notice to the End-User: “Traffic Codes for Belgium are provided by the Ministerie van de Vlaamse Gemeenschap and the Ministère de l’Équipement et des Transports.”

B. Paper Maps. With respect to any license granted to Client relating to making, selling or distributing paper maps (i.e., a map fixed on a paper or paper-like medium): (a) such license with respect to Data for the Territory of Great Britain is conditioned on Client’s entering into and complying with a separate written agreement with the Ordnance Survey (“OS”) to create and sell paper maps, Client’s paying to the OS any and all applicable paper map royalties, and Client’s complying with the OS copyright notice requirements; (b) such license for selling or otherwise distributing for charge with respect to Data for the Territory of Czech Republic

Appendices

is conditioned on Client's obtaining prior written consent from Kartografie a.s.; (c) such license for selling or distributing with respect to Data for the Territory of Switzerland is conditioned on Client's obtaining a permit from Bundesamt für Landestopografie of Switzerland; (d) Client is restricted from using Data for the Territory of France to create paper maps with a scale between 1:5,000 and 1:250,000; and (e) Client is restricted from using any Data to create, sell or distribute paper maps that are the same or substantially similar, in terms of data content and specific use of color, symbols and scale, to paper maps published by the European national mapping agencies, including without limitation, Landervermessungämter of Germany, Topografische Dienst of the Netherlands, Nationaal Geografisch Instituut of Belgium, Bundesamt für Landestopografie of Switzerland, Bundesamt für Eich-und Vermessungswesen of Austria, and the National Land Survey of Sweden.

C. OS Enforcement. Without limiting Section IV(B) above, with respect to Data for the Territory of Great Britain, Client acknowledges and agrees that the Ordnance Survey ("OS") may bring a direct action against Client to enforce compliance with the OS copyright notice (see Section IV(D) below) and paper map requirements (see Section IV(B) above) contained in this Agreement.

D. Third Party Notices. Any and all copies of the Data and/or packaging relating thereto shall include the respective Third Party Notices set forth below and used as described below corresponding to the Territory (or portion thereof) included in such copy:

Country(ies) Notice

Austria	"© Bundesamt für Eich- und Vermessungswesen"
Croatia Cyprus, Estonia, Latvia, Lithuania, Moldova, Poland, Slovenia and/or Ukraine	"© EuroGeographics"
France	"source: © IGN 2009 – BD TOPO ®"
Germany	"Die Grundlegendaten wurden mit Genehmigung der zuständigen Behörden entnommen"
Great Britain	"Contains Ordnance Survey data © Crown copyright and database right 2010 Contains Royal Mail data © Royal Mail copyright and database right 2010"
Greece	"Copyright Geomatics Ltd."
Hungary	"Copyright © 2003; Top-Map Ltd."
Italy	"La Banca Dati Italiana è stata prodotta usando quale riferimento anche cartografia numerica ed al tratto prodotta e fornita dalla Regione Toscana."
Norway	"Copyright © 2000; Norwegian Mapping Authority"
Portugal	"Source: IgeoE – Portugal"
Spain	"Información geográfica propiedad del CNIG"

Appendices

Sweden “Based upon electronic data
© National Land Survey
Sweden.”

Switzer- “Topografische Grundlage: ©
land Bundesamt für Landestopo-
graphie.

E. Respective Country Distribution. Client acknowledges that HERE has not received approvals to distribute map data for the following countries in such respective countries: Albania, Belarus, Kyrgyzstan, Moldova and Uzbekistan. HERE may update such list from time to time. The license rights granted to Client under this TL with respect to the Data for such countries are contingent upon Client’s compliance with all applicable laws and regulations, including, without limitation, any required licenses or approvals to distribute the Application incorporating such Data in such respective countries.

VI. Australia Territory

A. Third Party Notices. Any and all copies of the Data and/or packaging relating thereto shall include the respective Third Party Notices set forth below and used as described below corresponding to the Territory (or portion thereof) included in such copy:

Copyright. Based on data provided under license from PSMA Australia Limited (www.pasma.com.au).

Product incorporates data which is © 20XX Telstra Corporation Limited, GM Holden Limited, Intelomatics Australia Pty Ltd and Continental Pty Ltd.

B. Third Party Notices for Australia. In addition to the foregoing, the End-User Terms for any Application containing RDS-TMC Traffic Codes for Australia shall contain the following notice: “Product incorporates traffic location codes which is © 20XX Telstra Corporation Limited and its licensors.”

VII. China Territory

Personal Use Only

You agree to use this Data together with [insert name of Client Application] for the solely personal, non-commercial purposes for which you were licensed, and not for service bureau, time-sharing or other similar purposes. Accordingly, but subject to the restrictions set forth in the following paragraphs, you may copy this Data only as necessary for your personal use to (i) view it, and (ii) save it, provided that you do not remove any copyright notices that appear and do not modify the Data in any way. You agree not to otherwise reproduce, copy, modify, decompile, disassemble or reverse engineer any portion of this Data, and may not transfer or distribute it in any form, for any purpose, except to the extent permitted by mandatory laws.

Restrictions

Except where you have been specifically licensed to do so by NAV2 , and without limiting the preceding paragraph, you may not (a) use this Data with any products, systems, or applications installed or otherwise connected to or in communication with vehicles, capable of vehicle navigation, positioning, dispatch, real time route guidance, fleet management or similar applications; or (b)

Appendices

with or in communication with any positioning devices or any mobile or wireless-connected electronic or computer devices, including without limitation cellular phones, palmtop and handheld computers, pagers, and personal digital assistants or PDAs. You agree to cease using this Data if you fail to comply with these terms and conditions.

Limited Warranty

NAV2 warrants that (a) the Data will perform substantially in accordance with the accompanying written materials for a period of ninety (90) days from the date of receipt, and (b) any support services provided by NAV2 shall be substantially as described in applicable written materials provided to you by NAV2, and NAV2's support engineers will make commercially reasonable efforts to solve any problem issues.

rigCustomer Remedies

NAV2 and its suppliers' entire liability and your exclusive remedy shall be, at NAV2's sole discretion, either (a) return of the price paid, if any, or (b) repair or replacement of the Data that do not meet NAV2's Limited Warranty and that are returned to NAV2 with a copy of your receipt. This Limited Warranty is void if failure of the Data has resulted from accident, abuse, or misapplication. Any replacement Data will be warranted for the remainder of the original warranty period or thirty (30) days, whichever is longer. Neither these remedies nor any product support services offered by NAV2 are available without proof of purchase from an authorized international source.

No Other Warranty:

EXCEPT FOR THE LIMITED WARRANTY SET FORTH ABOVE AND TO THE EXTENT PERMITTED BY APPLICABLE LAW, NAV2 AND ITS LICENSORS (INCLUDING THEIR LICENSORS AND SUPPLIERS) DISCLAIM ANY WARRANTIES, EXPRESS OR IMPLIED, OF QUALITY, PERFORMANCE, MERCHANTABILITY, FITNESS FOR A PARTICULAR PURPOSE, OWNERSHIP OR NON-INFRINGEMENT. Certain warranty exclusions may not be permitted under applicable law, so to that extent the above exclusion may not apply to you.

Limited Liability:

TO THE EXTENT PERMITTED BY APPLICABLE LAW, NAV2 AND ITS LICENSORS (INCLUDING THEIR LICENSORS AND SUPPLIERS) SHALL NOT BE LIABLE TO YOU: IN RESPECT OF ANY CLAIM, DEMAND OR ACTION, IRRESPECTIVE OF THE NATURE OF THE CAUSE OF THE CLAIM, DEMAND OR ACTION ALLEGING ANY LOSS, INJURY OR DAMAGES, DIRECT OR INDIRECT, WHICH MAY RESULT FROM THE USE OR POSSESSION OF THE INFORMATION; OR FOR ANY LOSS OF PROFIT, REVENUE, CONTRACTS OR SAVINGS, OR ANY OTHER DIRECT, INDIRECT, INCIDENTAL, SPECIAL OR CONSEQUENTIAL DAMAGES ARISING OUT OF YOUR USE OF OR INABILITY TO USE THIS INFORMATION, ANY DEFECT IN THE INFORMATION, OR THE BREACH OF THESE TERMS OR CONDITIONS, WHETHER IN AN ACTION IN CONTRACT OR TORT OR BASED ON A WARRANTY, EVEN IF NAV2 OR ITS LICENSORS HAVE BEEN ADVISED OF THE POSSIBILITY OF SUCH DAMAGES. UNDER NO CIRCUMSTANCES SHALL NAV2'S OR ITS SUPPLIERS' LIABILITY HEREUNDER EXCEED THE PRICE PAID. Certain liability exclusions may not be permitted under applicable law, so to that extent the above exclusion may not apply to you.

Appendices

Export Control

You agree not to export to anywhere any part of the Data provided to you or any direct product thereof except in compliance with, and with all licenses and approvals required under, applicable export laws, rules and regulations.

IP Protection

The Data are owned by NAV2 or its suppliers and are protected by applicable copyright and other intellectual property law and treaties. The Data are provided solely on the basis of a license to use, not sale.

Entire Agreement

These terms and conditions constitute the entire agreement between NAV2 (and its licensors, including their licensors and suppliers) and you pertaining to the subject matter hereof, and supersedes in their entirety any and all written or oral agreements previously existing between us with respect to such subject matter.

Governing Law.

The above terms and conditions shall be governed by the laws of the People's Republic of China, without giving effect to (i) its conflict of laws provisions, or (ii) the United Nations Convention for Contracts for the International Sale of Goods, which is explicitly excluded. Any dispute arising from or in connection with the Data provided to you hereunder shall be submitted to the Shanghai International Economic and Trade Arbitration Commission for arbitration.

Gracenote® Copyright

CD and music-related data from Gracenote, Inc., copyright© 2000-2007 Gracenote. Gracenote Software, copyright © 2000-2007 Gracenote. This product and service may practice one or more of the following U.S. Patents #5,987,525, #6,061,680, #6,154,773, #6,161,132, #6,230,192, #6,230,207, #6,240,459, #6,330,593 and other patents issued or pending. Some services supplied under license from Open Globe, Inc. for U.S. Patent: #6,304,523.

Gracenote and CDDB are registered trademarks of Gracenote. The Gracenote logo and logotype, and the "Powered by Gracenote™" logo are trademarks of Gracenote.

Gracenote® End User License Agreement (EULA)

This device contains software from Gracenote, Inc. of 2000 Powell Street Emeryville, California 94608 ("Gracenote").

The software from Gracenote (the "Gracenote Software") enables this device to do disc and music file identification and obtain music-related information, including name, artist, track, and title information ("Gracenote Data") from online servers ("Gracenote Servers"), and to perform other functions. You may use Gracenote Data only by means of the intended End User functions of this device.

This device may contain content belonging to Gracenote's providers. If so, all of the restrictions set forth herein with respect to Gracenote Data shall also apply to such content and such content providers shall be entitled to all of the benefits and protections set forth herein that are available to Gracenote.

Appendices

You agree that you will use the content from Gracenote ("Gracenote Content"), Gracenote Data, the Gracenote Software, and Gracenote Servers for your own personal, non-commercial use only. You agree not to assign, copy, transfer or transmit the Gracenote Content, Gracenote Software or any Gracenote Data (except in a Tag associated with a music file) to any third party. YOU AGREE NOT TO USE OR EXPLOIT GRACENOTE CONTENT, GRACENOTE DATA, THE GRACENOTE SOFTWARE, OR GRACENOTE SERVERS, EXCEPT AS EXPRESSLY PERMITTED HEREIN.

You agree that your non-exclusive licenses to use the Gracenote Content, Gracenote Data, the Gracenote Software, and Gracenote Servers will terminate if you violate these restrictions. If your licenses terminate, you agree to cease any and all use of the Gracenote Content, Gracenote Data, the Gracenote Software, and Gracenote Servers. Gracenote, respectively, reserve all rights in Gracenote Data, the Gracenote Software, and the Gracenote Servers and Gracenote Content, including all ownership rights. Under no circumstances will either Gracenote become liable for any payment to you for any information that you provide, including any copyrighted material or music file information. You agree that Gracenote may enforce its respective rights, collectively or separately, under this agreement against you, directly in each company's own name.

Gracenote uses a unique identifier to track queries for statistical purposes. The purpose of a randomly assigned numeric identifier is to allow Gracenote to count queries without knowing anything about who you are. For more information, see the web page at www.gracenote.com for the Gracenote Privacy Policy.

THE GRACENOTE SOFTWARE, EACH ITEM OF GRACENOTE DATA AND THE GRACENOTE CONTENT ARE LICENSED TO YOU "AS IS". NEITHER GRACENOTE MAKES ANY REPRESENTATIONS OR WARRANTIES, EXPRESS OR IMPLIED, REGARDING THE ACCURACY OF ANY GRACENOTE DATA FROM THE GRACENOTE SERVERS OR GRACENOTE CONTENT. GRACENOTE COLLECTIVELY AND SEPARATELY RESERVE THE RIGHT TO DELETE DATA AND/OR CONTENT FROM THE COMPANIES' RESPECTIVE SERVERS OR, IN THE CASE OF GRACENOTE, CHANGE DATA CATEGORIES FOR ANY CAUSE THAT GRACENOTE DEEMS SUFFICIENT. NO WARRANTY IS MADE THAT EITHER GRACENOTE CONTENT OR THE GRACENOTE SOFTWARE OR GRACENOTE SERVERS ARE ERROR-FREE OR THAT THE FUNCTIONING OF THE GRACENOTE SOFTWARE OR GRACENOTE SERVERS WILL BE UNINTERRUPTED. GRACENOTE IS NOT OBLIGATED TO PROVIDE YOU WITH ANY ENHANCED OR ADDITIONAL DATA TYPES THAT GRACENOTE MAY CHOOSE TO PROVIDE IN THE FUTURE AND IS FREE TO DISCONTINUE ITS ONLINE SERVICES AT ANY TIME. GRACENOTE DISCLAIMS ALL WARRANTIES EXPRESS OR IMPLIED, INCLUDING, BUT NOT LIMITED TO, IMPLIED WARRANTIES OF MERCHANTABILITY, FITNESS FOR A PARTICULAR PURPOSE, TITLE, AND NON-INFRINGEMENT. NEITHER GRACENOTE WARRANTS THE RESULTS THAT WILL BE OBTAINED BY YOUR USE OF THE GRACENOTE SOFTWARE OR ANY GRACENOTE SERVER. IN NO CASE WILL GRACENOTE BE LIABLE FOR ANY CONSEQUENTIAL OR INCIDENTAL DAMAGES OR FOR ANY LOST PROFITS OR LOST REVENUES FOR ANY REASON WHATSOEVER.

© Gracenote 2007.

Appendices

Vehicle with SYNC only

United States and Mexico

FCC ID: KMHSG1G1

IC: 1422A-SG1G1

Mexico

Model: KMHSG1P1

NOM-121-SCT1-2009

The operation of this equipment is subject to the following two conditions: (1) This equipment or device may not cause harmful interference, and (2) this equipment or device must accept any interference, including interference that may cause undesired operation.

Vehicle with SYNC with Touchscreen/My Touch

FCC ID: KMHSYNCG2

IC: 1422A-SYNCG2

This device complies with Part 15 of the FCC Rules and with RSS-210 of Industry Canada. Operation is subject to the following two conditions: (1) This device may not cause harmful interference, and (2) this device must accept any interference received, including interference that may cause undesired operation.

WARNING



Changes or modifications not expressly approved by the party responsible for compliance could void the user's authority to operate the equipment. The term "IC" before the radio certification number only signifies that Industry Canada technical specifications were met.

The antenna used for this transmitter must not be co-located or operating in conjunction with any other antenna or transmitter.

Extended Service Plan (ESP)

PROTECT YOURSELF FROM THE RISING COST OF VEHICLE REPAIRS WITH A FORD EXTENDED SERVICE PLAN.

SERVICE PLANS (U.S. Only)

More than 32 million Ford owners have discovered the powerful protection of Ford Extended Service Plan. It is the extended service plan backed by Ford Motor Company, and provides peace of mind protection beyond the New Vehicle Limited Warranty coverage.

Ford ESP Can Quickly Pay for Itself

One service bill – the cost of parts and labor – can easily exceed the price of your Ford Extended Service Plan. With Ford ESP you minimize your risk for unexpected repair bills and rising repair costs.

Up to 1,000+ Covered Vehicle Components

There are four core Extended Service Plans with different levels of coverage. Ask your authorized dealer for details.

1. PremiumCARE - Our most comprehensive coverage. With over 1,000 covered components, this plan is so complete that we generally only discuss what's not covered.
2. ExtraCARE - Covers 113 components, and includes many high-tech items.
3. BaseCARE - Covers 84 components.
4. PowertrainCARE - Covers 29 critical components.

Ford Extended Service Plan is honored by all authorized Ford dealers in the U.S., Canada and Mexico. It is the extended service plan authorized and backed by Ford Motor Company.

That means you get:

- Reliable, quality service at any Ford or Lincoln dealership
- Repairs performed by factory trained technicians, using genuine parts

Rental Car Reimbursement

1st day Rental Benefit

You take advantage of replacement transportation if your vehicle is at your authorized dealer for same day covered repairs.

Extended Rental Benefits

If your vehicle is kept overnight for covered repairs, you are eligible for rental car coverage, including bumper to bumper warranty repairs, and Field Service Actions.

Roadside Assistance

Exclusive 24/7 roadside assistance, including:

- Towing, flat-tire change and battery jump starts
- Out of fuel and lock-out assistance.
- Travel expense reimbursement for lodging, meals and rental car.
- Destination assistance for taxi, shuttle, rental car coverage and emergency transportation.

Transferable Coverage

If you sell your vehicle before your Ford Extended Service Plan coverage expires, you can transfer any remaining coverage to the new owner. Whenever you sell your vehicle, prospective buyers may have a higher degree of confidence that vehicle was properly maintained with Ford ESP, thereby improving resale value.

Extended Service Plan (ESP)

Avoid the Rising Cost of Properly Maintaining Your Vehicle!

Ford Extended Service Plan also offers a Premium Maintenance Plan that covers all scheduled maintenance, and selected wear items. The coverage is prepaid, so you never have to worry about affording your vehicle's maintenance. It covers regular checkups, routine inspections, preventive care and replacement of select items that require periodic attention for normal wear:

- Windshield wiper blades.
- Spark plugs.
- The clutch disc.
- Brake pads and linings.
- Shock absorbers.
- Struts.
- Engine Belts.
- Engine coolant hoses, clamps and o-rings.
- Diesel exhaust fluid replenishment.

Interest Free Finance Options Available

Take advantage of our interest free installment payment plan. Just a 10% down payment will provide you with an affordable, no interest, no fee payment program allowing you all the security and benefits Ford ESP has to offer while paying over time. You are pre-approved with no credit checks, no hassles! To learn more, call our Ford ESP specialists at 800-367-3377.

Ford ESP
P.O. Box 321067
Detroit, MI 48232

SERVICE PLANS (CANADA ONLY)

You can get more protection for your vehicle by purchasing a Ford Extended Service Plan. Ford Extended Service Plan is the only service contract backed by Ford Motor Company of Canada, Limited. Depending on the plan you purchase, Ford Extended Service Plan provides benefits such as:

- Rental reimbursement.
- Coverage for certain maintenance and wear items.
- Protection against repair costs after your New Vehicle Limited Warranty Coverage expires.
- Roadside Assistance benefits.

There are several Ford Extended Service Plans available in various time, distance and deductible combinations. Each plan is tailored to fit your own driving needs, including reimbursement for towing and rental. When you purchase Ford Extended Service Plan, you receive added peace-of-mind protection throughout Canada and the United States, provided by a network of participating authorized Ford Motor Company dealers.

Note: *Repairs performed outside of Canada and the United States are not eligible for Ford Extended Service Plan coverage.*

This information is subject to change. For more information, visit your local Ford of Canada dealer or www.ford.ca to find the Ford Extended Service Plan that is right for you.

Scheduled Maintenance

GENERAL MAINTENANCE INFORMATION

Why Maintain Your Vehicle?

Carefully following the maintenance schedule helps protect against major repair expenses resulting from neglect or inadequate maintenance and may help to increase the value of your vehicle when you sell or trade it. Keep all receipts for completed maintenance with your vehicle.

We have established regular maintenance intervals for your vehicle based upon rigorous testing. It is important that you have your vehicle serviced at the proper times. These intervals serve two purposes; one is to maintain the reliability of your vehicle and the second is to keep the cost of owning your vehicle down.

It is your responsibility to have all scheduled maintenance performed and to make sure that the materials used meet the specifications identified in this owner's manual. See **Capacities and Specifications** (page 222).

Failure to perform scheduled maintenance invalidates warranty coverage on parts affected by the lack of maintenance.

Why Maintain Your Vehicle at Your Dealership?

Factory-trained Technicians

Service technicians participate in extensive factory-sponsored certification training to help them become experts on the operation of your vehicle. Ask your dealership about the training and certification their technicians have received.

Genuine Ford and Motorcraft Replacement Parts

Dealerships stock Ford, Motorcraft and Ford-authorized branded re-manufactured replacement parts. These parts meet or exceed our specifications. Parts installed at your dealership carry a nationwide 24-month or unlimited mile (kilometer) parts and labor limited warranty.

If you do not use Ford authorized parts they may not meet our specifications and depending on the part, it could affect emissions compliance.

Convenience

Many dealerships have extended evening and Saturday hours to make your service visit more convenient and they offer one stop shopping. They can perform any services that are required on your vehicle, from general maintenance to collision repairs.

Note: *Not all dealers have extended hours or body shops. Please contact your dealer for details.*

Protecting Your Investment

Maintenance is an investment that pays dividends in the form of improved reliability, durability and resale value. To maintain the proper performance of your vehicle and its emission control systems, make sure you have scheduled maintenance performed at the designated intervals.

Your vehicle is very sophisticated and built with multiple, complex, performance systems. Every manufacturer develops these systems using different specifications and performance features. That is why it is important to rely upon your dealership to properly diagnose and repair your vehicle.

Scheduled Maintenance

Ford Motor Company has recommended maintenance intervals for various parts and component systems based upon engineering testing. Ford Motor Company relies upon this testing to determine the most appropriate mileage for replacement of oils and fluids to protect your vehicle at the lowest overall cost to you and recommends against maintenance schedules that deviate from the scheduled maintenance information.

We strongly recommend the use of only genuine Ford, Motorcraft or Ford-authorized re-manufactured replacement parts engineered for your vehicle.

Additives and Chemicals

This owner's manual and the Ford Workshop Manual list the recommended additives and chemicals for your vehicle. We do not recommend using chemicals or additives not approved by us as part of your vehicle's normal maintenance. Please consult your warranty information.

Oils, Fluids and Flushing

In many cases, fluid discoloration is a normal operating characteristic and, by itself, does not necessarily indicate a concern or that the fluid needs to be changed. However, a qualified expert, such as the factory-trained technicians at your dealership, should inspect discolored fluids that also show signs of overheating or foreign material contamination immediately.

Make sure to change your vehicle's oils and fluids at the specified intervals or in conjunction with a repair. Flushing is a viable way to change fluid for many vehicle sub-systems during scheduled maintenance. It is critical that systems are flushed only with new fluid that is the same as that required to fill and operate the system or using a Ford-approved flushing chemical.

Owner Checks and Services

Make sure you perform the following basic maintenance checks and inspections every month or at six-month intervals.

Check every month
Function of all interior and exterior lights.
Tires (including spare) for wear and proper pressure.
Windshield washer fluid level.

Check every six months
Battery connections. Clean if necessary.
Body and door drain holes for obstructions. Clean if necessary.
Cooling system fluid level and coolant strength.
Door weatherstrips for wear. Lubricate if necessary.
Hinges, latches and outside locks for proper operation. Lubricate if necessary.

Scheduled Maintenance

Check every six months
Parking brake for proper operation.
Safety belts and seat latches for wear and function.
Safety warning lamps (brake, ABS, airbag and safety belt) for operation.
Washer spray and wiper operation. Clean or replace blades as necessary.

Multi-point Inspection

In order to keep your vehicle running right, it is important to have the systems on your vehicle checked regularly. This can help identify potential issues and prevent major problems. We recommend having the following multi-point inspection performed at every scheduled maintenance interval to help make sure your vehicle keeps running great.

Multi-point inspection	
Battery performance	Radiator, cooler, heater and air conditioning hoses
Exterior lamps and hazard warning system operation	Suspension components for leaks or damage
Fluid levels*; fill if necessary	Steering and linkage
For oil and fluid leaks	Tires for wear and proper pressure**
Half-shaft dust boots	Windshield for cracks, chips or pits
Horn operation	Washer spray and wiper operation

* Brake, coolant recovery reservoir and window washer.

**Your vehicle is equipped with a temporary mobility kit; check the tire sealant expiration Use By date on the canister. Replace as needed.

Scheduled Maintenance

Be sure to ask your dealership service advisor or technician about the multi-point vehicle inspection. It is a comprehensive way to perform a thorough inspection of

your vehicle. Your checklist gives you immediate feedback on the overall condition of your vehicle.

NORMAL SCHEDULED MAINTENANCE

Normal scheduled maintenance*	
Every 12 months or 10000 mi (16,000 km).	Rotate tires, inspect tire wear and measure tread depth.
	Perform multi-point inspection (recommended).
	Inspect brake pads, shoes, rotors, drums, brake linings, hoses and parking brake.
	Inspect cooling system level, strength and hoses.
	Inspect half-shaft boots.
	Inspect steering linkage, ball joints, suspension and tie-rod ends.
	Inspect wheels and related components for abnormal noise, wear, looseness or drag.

*Do not exceed one year or 10000 mi (16,000 km) between service intervals.

Other maintenance items	
Every 20000 mi (32,000 km) *	Replace cabin air filter.
At 10 years or 150000 mi (240,000 km) **	Change coolant and coolant filter.

* Cabin air filter life is dependent on exposure to dusty and dirty conditions. Vehicles operated in these conditions require frequent inspection and replacement of the cabin air filter.

Scheduled Maintenance

** Initial replacement at 10 years or 150000 mi (240,000 km), then every five years or 50000 mi (80,000 km). The coolant must be exchanged as indicated in the Ford Motor Company Workshop

Manual. If not performed properly, damage could occur to the cooling system components. Only use pre-mixed coolant that meets Ford Motor Company specifications. See **Capacities and Specifications** (page 222).

SCHEDULED MAINTENANCE RECORD

<input type="radio"/> Repair Order #:	<p>Dealer stamp</p>
<input type="radio"/> Distance:	
<input type="radio"/> Engine hours (optional):	
<input type="radio"/> Multi-point inspection (recommended): <input type="checkbox"/>	
<input type="radio"/> Signature:	

<input type="radio"/> Repair Order #:	<p>Dealer stamp</p>
<input type="radio"/> Distance:	
<input type="radio"/> Engine hours (optional):	
<input type="radio"/> Multi-point inspection (recommended): <input type="checkbox"/>	
<input type="radio"/> Signature:	

Scheduled Maintenance

<input type="radio"/> Repair Order #:	<p>Dealer stamp</p>
<input type="radio"/> Distance:	
<input type="radio"/> Engine hours (optional):	
<input type="radio"/> Multi-point inspection (recommended): <input type="checkbox"/>	
<input type="radio"/> Signature:	

<input type="radio"/> Repair Order #:	<p>Dealer stamp</p>
<input type="radio"/> Distance:	
<input type="radio"/> Engine hours (optional):	
<input type="radio"/> Multi-point inspection (recommended): <input type="checkbox"/>	
<input type="radio"/> Signature:	

<input type="radio"/> Repair Order #:	<p>Dealer stamp</p>
<input type="radio"/> Distance:	
<input type="radio"/> Engine hours (optional):	
<input type="radio"/> Multi-point inspection (recommended): <input type="checkbox"/>	
<input type="radio"/> Signature:	

Scheduled Maintenance

<input type="radio"/> Repair Order #:	<p>Dealer stamp</p>
<input type="radio"/> Distance:	
<input type="radio"/> Engine hours (optional):	
<input type="radio"/> Multi-point inspection (recommended): <input type="checkbox"/>	
<input type="radio"/> Signature:	

<input type="radio"/> Repair Order #:	<p>Dealer stamp</p>
<input type="radio"/> Distance:	
<input type="radio"/> Engine hours (optional):	
<input type="radio"/> Multi-point inspection (recommended): <input type="checkbox"/>	
<input type="radio"/> Signature:	

<input type="radio"/> Repair Order #:	<p>Dealer stamp</p>
<input type="radio"/> Distance:	
<input type="radio"/> Engine hours (optional):	
<input type="radio"/> Multi-point inspection (recommended): <input type="checkbox"/>	
<input type="radio"/> Signature:	

Scheduled Maintenance

<input type="radio"/> Repair Order #:	<p>Dealer stamp</p>
<input type="radio"/> Distance:	
<input type="radio"/> Engine hours (optional):	
<input type="radio"/> Multi-point inspection (recommended): <input type="checkbox"/>	
<input type="radio"/> Signature:	

<input type="radio"/> Repair Order #:	<p>Dealer stamp</p>
<input type="radio"/> Distance:	
<input type="radio"/> Engine hours (optional):	
<input type="radio"/> Multi-point inspection (recommended): <input type="checkbox"/>	
<input type="radio"/> Signature:	

<input type="radio"/> Repair Order #:	<p>Dealer stamp</p>
<input type="radio"/> Distance:	
<input type="radio"/> Engine hours (optional):	
<input type="radio"/> Multi-point inspection (recommended): <input type="checkbox"/>	
<input type="radio"/> Signature:	

Scheduled Maintenance

<input type="radio"/> Repair Order #:	<p>Dealer stamp</p>
<input type="radio"/> Distance:	
<input type="radio"/> Engine hours (optional):	
<input type="radio"/> Multi-point inspection (recommended): <input type="checkbox"/>	
<input type="radio"/> Signature:	

<input type="radio"/> Repair Order #:	<p>Dealer stamp</p>
<input type="radio"/> Distance:	
<input type="radio"/> Engine hours (optional):	
<input type="radio"/> Multi-point inspection (recommended): <input type="checkbox"/>	
<input type="radio"/> Signature:	

<input type="radio"/> Repair Order #:	<p>Dealer stamp</p>
<input type="radio"/> Distance:	
<input type="radio"/> Engine hours (optional):	
<input type="radio"/> Multi-point inspection (recommended): <input type="checkbox"/>	
<input type="radio"/> Signature:	

Scheduled Maintenance

<input type="radio"/> Repair Order #:	<p>Dealer stamp</p>
<input type="radio"/> Distance:	
<input type="radio"/> Engine hours (optional):	
<input type="radio"/> Multi-point inspection (recommended): <input type="checkbox"/>	
<input type="radio"/> Signature:	

<input type="radio"/> Repair Order #:	<p>Dealer stamp</p>
<input type="radio"/> Distance:	
<input type="radio"/> Engine hours (optional):	
<input type="radio"/> Multi-point inspection (recommended): <input type="checkbox"/>	
<input type="radio"/> Signature:	

<input type="radio"/> Repair Order #:	<p>Dealer stamp</p>
<input type="radio"/> Distance:	
<input type="radio"/> Engine hours (optional):	
<input type="radio"/> Multi-point inspection (recommended): <input type="checkbox"/>	
<input type="radio"/> Signature:	

Scheduled Maintenance

<input type="radio"/> Repair Order #:	<p>Dealer stamp</p>
<input type="radio"/> Distance:	
<input type="radio"/> Engine hours (optional):	
<input type="radio"/> Multi-point inspection (recommended): <input type="checkbox"/>	
<input type="radio"/> Signature:	

<input type="radio"/> Repair Order #:	<p>Dealer stamp</p>
<input type="radio"/> Distance:	
<input type="radio"/> Engine hours (optional):	
<input type="radio"/> Multi-point inspection (recommended): <input type="checkbox"/>	
<input type="radio"/> Signature:	

<input type="radio"/> Repair Order #:	<p>Dealer stamp</p>
<input type="radio"/> Distance:	
<input type="radio"/> Engine hours (optional):	
<input type="radio"/> Multi-point inspection (recommended): <input type="checkbox"/>	
<input type="radio"/> Signature:	

Index

A

A/C	
See: Climate Control.....	100
About This Manual.....	5
ABS	
See: Brakes.....	124
ABS driving hints	
See: Hints on Driving With Anti-Lock Brakes.....	125
Accessories.....	321
Exterior style.....	321
Interior style.....	321
Lifestyle.....	321
Peace of mind.....	321
Accessories	
See: Replacement Parts Recommendation.....	9
Adjusting the Headlamps.....	176
Horizontal Aim Adjustment.....	177
Vertical Aim Adjustment.....	176
Adjusting the Steering Wheel.....	67
Airbag Disposal.....	45
Air Conditioning	
See: Climate Control.....	100
Alarm	
See: Anti-Theft Alarm.....	65
Ambient Lighting.....	76
Anti-Theft Alarm.....	65
Arming the Alarm.....	65
Disarming the Alarm.....	66
Appendices.....	323
At a Glance.....	12
Audible Warnings and Indicators.....	85
Headlamps On Warning Chime.....	85
Keyless Warning Alert.....	85
Parking Brake On Warning Chime.....	85
Audio Control.....	67
Seek, Next or Previous.....	68
Audio System.....	227
General Information.....	227
Audio Unit - Vehicles With: Sony Audio System.....	228
Autolamps.....	73
Windshield Wiper Activated Headlamps.....	73

Automatic Climate Control.....	100
Dual Zone Temperature Control.....	101
Single Zone Temperature Control.....	101
Temperature Control.....	101
Automatic Transmission.....	122
Brake-Shift Interlock.....	122
If Your Vehicle Gets Stuck In Mud or Snow.....	123
Single Speed Automatic Transmission.....	122
Auxiliary Power Points.....	110
12 Volt DC Power Point.....	110
Location.....	110

B

Bonnet Lock	
See: Opening and Closing the Hood.....	169
Booster Seats.....	24
Types of Booster Seats.....	25
Brake Fluid Check.....	173
Brakes.....	124
General Information.....	124
Breaking-In.....	145
Bulb Specification Chart.....	181

C

Cabin Air Filter.....	103
California Proposition 65.....	9
Capacities and Specifications.....	225
Specifications.....	225
Car Wash	
See: Cleaning the Exterior.....	182
Center Console.....	111
Changing a Bulb.....	178
Replacing Headlamp Bulbs.....	178
Replacing HID Headlamp Bulbs.....	178
Replacing LED Rear Lamp Bulbs.....	180
Replacing Licence Plate and High Mounted Brake Lamp Bulbs.....	181
Replacing Rear Lamp Bulbs.....	179
Changing a Fuse.....	168
Fuses.....	168
Changing a Road Wheel.....	220
Important Information for Lifting or Jacking.....	220
Jacking.....	220
Changing the 12V Battery.....	173

Index

Changing the Wiper Blades.....	175
Charging the High Voltage Battery.....	115
Charge Port.....	118
Charging.....	118
Charging Equipment.....	115
Convenience Charging and MyFord Mobile.....	120
Disconnecting the Charging Coupler.....	120
Locking the Charging Coupler.....	119
Waiting to Charge.....	119
Checking MyKey System Status.....	53
Checking the Wiper Blades.....	175
Child Restraint and Safety Belt Maintenance.....	35
Child Safety.....	17
General Information.....	17
Child Safety Locks.....	27
Left-Hand Side.....	28
Right-Hand Side.....	28
Child Seat Positioning.....	26
Cleaning Leather Seats.....	185
Cleaning Products.....	182
Cleaning the Alloy Wheels.....	186
Cleaning the Engine.....	183
Cleaning the Exterior.....	182
Exterior Chrome Parts.....	182
Exterior Plastic Parts.....	183
Stripes or Graphics.....	183
Underbody.....	183
Cleaning the Instrument Panel and Instrument Cluster Lens.....	184
Cleaning the Interior.....	184
Cleaning the Windows and Wiper Blades.....	184
Clearing All MyKeys.....	52
Climate.....	301
Climate Control Voice Commands.....	303
Climate Control.....	100
Cold Weather Precautions.....	145
Collision, Damage or Fire Event.....	150
Guidance for Ford Motor Company Electric and Hybrid-Electric Vehicles Equipped With High Voltage Batteries.....	150
Coolant Check.....	171
Adding Coolant.....	171
Recycled Coolant.....	172
Severe Climates.....	172
Crash Sensors and Airbag Indicator.....	44
Creating a MyKey.....	51
Programming/Changing Configurable Settings.....	51
Cruise Control.....	68
Principle of Operation.....	133
Cruise control See: Using Cruise Control.....	133
Customer Assistance.....	152
D	
Data Recording.....	7
Event Data Recording.....	7
Service Data Recording.....	7
Daytime Running Lamps.....	74
Type 1 - Conventional (Non-Configurable).....	74
Type 2 - Configurable.....	74
Direction Indicators.....	75
Driver and Passenger Airbags.....	38
Children and Airbags.....	38
Proper Driver and Front Passenger Seating Adjustment.....	38
Driver Knee Airbag.....	42
Driving Aids.....	134
Driving Hints.....	145
Driving Through Water.....	145
DRL See: Daytime Running Lamps.....	74
E	
Electric Vehicle Information.....	278
Power.....	289
Settings.....	279
End User License Agreement.....	323
SYNC End User License Agreement (EULA).....	323
Engine Immobilizer See: Passive Anti-Theft System.....	64

Index

Entertainment.....	254	General Information on Radio	
AM/FM Radio.....	255	Frequencies.....	46
Bluetooth Audio.....	269	General Maintenance Information.....	347
CD.....	265	Multi-point Inspection.....	349
Line In.....	269	Owner Checks and Services.....	348
SD Card Slot and USB Port.....	266	Protecting Your Investment.....	347
SIRIUS® Satellite Radio (If		Why Maintain Your Vehicle?.....	347
Activated).....	260	Why Maintain Your Vehicle at Your	
Supported Media Players, Formats and		Dealership?.....	347
Metadata Information.....	269	Getting Assistance Outside the U.S. and	
Environment.....	11	Canada.....	155
Event Data Recording		Getting the Services You Need.....	152
See: Data Recording.....	7	Away From Home.....	152
Extended Service Plan (ESP).....	345		
SERVICE PLANS (CANADA ONLY).....	346	H	
SERVICE PLANS (U.S. Only).....	345	Handbrake	
Exterior Mirrors.....	78	See: Parking Brake.....	125
Fold-Away Exterior Mirrors.....	78	Hazard Warning Flashers.....	148
Heated Exterior Mirrors.....	79	Headlamp Exit Delay.....	74
Integrated Blind Spot Mirrors.....	79	Head Restraints.....	104
Power Exterior Mirrors.....	78	Adjusting the Head Restraint.....	105
		Tilting Head Restraints	105
F		Heated Seats.....	109
Fastening the Safety Belts.....	30	Heated Windows and Mirrors.....	102
Safety Belt Extension Assembly.....	32	Heated Exterior Mirrors.....	103
Safety Belt Locking Modes.....	31	Heated Rear Window.....	102
Using Safety Belts During Pregnancy.....	30	Heating	
Flat Tire Inflation		See: Climate Control.....	100
See: Temporary Mobility Kit.....	189	High Voltage Battery Cut-Off	
Floor Mats.....	145	Switch.....	120
Ford Credit.....	9	High Voltage Battery.....	115
(U.S. Only).....	9	General Information.....	115
Front Exterior Overview.....	12	Hill Start Assist.....	125
Front Passenger Sensing System.....	39	Using Hill Start Assist.....	126
Fuses.....	158	Hints on Controlling the Interior	
Fuse Specification Chart.....	158	Climate.....	101
Electric Motor Compartment Fuse		General Hints.....	101
Box.....	158	Improving Vehicle Drive Range.....	102
Luggage Compartment Fuse Box.....	165	Recommended Settings for Cooling.....	102
Passenger Compartment Fuse Box.....	163	Side Window Defogging in Cold	
Pre-Fuse Box.....	158	Weather.....	102
		Hints on Driving With Anti-Lock	
G		Brakes.....	125
Gauges.....	81	Hood Lock	
Common Displays.....	81	See: Opening and Closing the Hood.....	169

Index

I

In California (U.S. Only).....	153
Information Display Control.....	68
Multimedia Controls.....	69
Information Displays.....	86
General Information.....	86
Information.....	292
911 Assist.....	298
Alerts.....	297
Calendar.....	298
Sirius Travel Link.....	296
SYNC Services (If Equipped, United States Only).....	292
Vehicle Health Report.....	300
Information Messages.....	92
AdvanceTrac®.....	93
Alarm.....	93
Battery and Charging System (High Voltage).....	93
Doors.....	95
Hill Start Assist.....	95
Keys and Intelligent Access.....	95
Lighting.....	96
Maintenance.....	96
MyKey.....	96
Park Aid.....	97
Park Brake.....	97
Power Steering.....	98
Remote Start.....	98
Tire Pressure Monitoring System.....	98
Transmission.....	99
Installing Child Seats.....	18
Child Seats.....	18
Using Lap and Shoulder Belts.....	19
Using Lower Anchors and Tethers for Children (LATCH).....	21
Using Tether Straps.....	23
Instrument Cluster.....	81
Instrument Lighting Dimmer.....	74
Instrument Panel Overview.....	15
Interior Lamps.....	75
Front Interior Lamps (If Equipped).....	75
Interior Mirror.....	79
Introduction.....	5

J

Jump Starting the Vehicle.....	148
To Connect the Booster Cables.....	149
To Start Your Vehicle.....	149

K

Keyless Entry.....	62
SECURICODE™ KEYLESS ENTRY KEYPAD.....	62
Keys and Remote Controls.....	46

L

Lighting Control.....	72
Headlamp Flasher.....	73
High Beams.....	72
Lighting.....	72
General Information.....	72
Load Carrying.....	135
Load Limit.....	135
Vehicle Loading - with and without a Trailer.....	135
Locking and Unlocking.....	57
Activating Intelligent Access.....	58
Autolock Feature.....	59
Autounlock Feature.....	60
Battery Saver.....	61
Disabled Intelligent Access Keys.....	59
Enabling or Disabling Autolock and Autounlock.....	60
Illuminated Entry.....	60
Illuminated Exit.....	60
Opening the Liftgate.....	61
Power Door Locks.....	57
Remote Control.....	57
Smart Unlocks for Intelligent Access Keys.....	59
Locks.....	57
Lug Nuts	
See: Changing a Road Wheel.....	220
Lug Nuts.....	221

M

Maintenance.....	169
General Information.....	169

Index

Manual Liftgate.....	61	PATS	
Closing the Liftgate.....	62	See: Passive Anti-Theft System.....	64
Opening the Liftgate.....	61	Perchlorate.....	9
Manual Seats.....	106	Personal Safety System™.....	36
Media Hub.....	230	How Does the Personal Safety System	
Message Center		Work?.....	36
See: Information Displays.....	86	Phone.....	271
Mirrors		Making Calls.....	273
See: Heated Windows and Mirrors.....	102	Pairing Subsequent Cell Phones.....	272
See: Windows and Mirrors.....	77	Pairing Your Cell Phone for the First	
Mobile Communications		Time.....	272
Equipment.....	10	Phone Menu Options.....	274
Motorcraft Parts.....	222	Phone Settings.....	277
MyFord Touch™.....	231	Phone Voice Commands.....	278
General Information.....	231	Receiving Calls.....	273
MyFord Touch™ Troubleshooting.....	314	Text Messaging.....	275
MyKey Troubleshooting.....	55	Post-Crash Alert System.....	151
MyKey™.....	50	Power Door Locks	
Principle of Operation.....	50	See: Locking and Unlocking.....	57
N		Power Seats.....	106
Navigation.....	304	Power Lumbar.....	107
cityseekr.....	307	Power Windows.....	77
Destination Mode.....	304	Accessory Delay.....	78
Map Mode.....	311	Bounce-Back.....	77
Navigation Map Updates.....	313	One-Touch Down.....	77
Navigation Voice Commands.....	313	One-Touch Up.....	77
Point of Interest (POI) Categories.....	305	Window Lock.....	77
Quick-touch Buttons.....	312	Protecting the Environment.....	11
Setting Your Navigation Preferences.....	308	R	
Normal Scheduled Maintenance.....	350	Rear Exterior Overview.....	13
O		Rear Parking Aid.....	129
Opening and Closing the Hood.....	169	Rear Sensing System.....	129
Ordering Additional Owner's		Rear Seats.....	107
Literature.....	156	Folding the Seatback.....	107
Obtaining a French Owner's Manual.....	156	Rear Under Floor Storage.....	135
Overhead Console.....	111	Cargo Management System.....	135
P		Rear View Camera.....	130
Parking Aids.....	129	Using the Rear View Camera System.....	130
Parking Brake.....	125	Rear View Camera	
Passive Anti-Theft System.....	64	See: Rear View Camera.....	130
SecuriLock.....	64	Rear Window Wiper and Washers.....	71
		Rear Window Washer.....	71
		Rear Window Wiper.....	71

Index

Remote Control.....	46	Security.....	64
Changing the Remote Control Battery.....	47	Settings.....	240
Intelligent Access Key.....	46	Clock.....	241
Locating Your Vehicle.....	47	Display.....	241
Programming a New Remote Control.....	47	Settings.....	246
Remote Start.....	48	Sound.....	243
Sounding the Panic Alarm.....	48	Vehicle.....	243
Remote Start.....	103	Side Airbags.....	41
Removing a Headlamp.....	177	Side Curtain Airbags.....	43
Repairing Minor Paint Damage.....	186	Sitting in the Correct Position.....	104
Replacement Parts		Snow Chains	
Recommendation.....	9	See: Using Snow Chains.....	216
Collision Repairs.....	9	Special Notices.....	10
Scheduled Maintenance and Mechanical		New Vehicle Limited Warranty.....	10
Repairs.....	9	On-board Diagnostics (OBD-II).....	10
Warranty on Replacement Parts.....	10	Special Instructions.....	10
Replacing a Lost Key or Remote		Speed Control	
Control.....	49	See: Cruise Control.....	133
Reporting Safety Defects (Canada		Stability Control.....	128
Only).....	157	Principle of Operation.....	128
Reporting Safety Defects (U.S.		Starting and Stopping the Electric	
Only).....	156	Motor.....	112
Roadside Assistance.....	147	Starting the Electric Motor.....	112
Vehicles Sold in Canada: Getting Roadside		Keyless Starting.....	112
Assistance.....	147	Starting Your Vehicle.....	112
Vehicles Sold in Canada: Using Roadside		Steering.....	134
Assistance.....	147	Electric Power Steering.....	134
Vehicles Sold in the United States: Getting		Steering Wheel.....	67
Roadside Assistance.....	147	Storage Compartments.....	111
Vehicles Sold in the United States: Using		Sun Visors.....	80
Roadside Assistance.....	147	Illuminated Vanity Mirror.....	80
Roadside Emergencies.....	147	Supplementary Restraints System.....	37
Running-In		Principle of Operation.....	37
See: Breaking-In.....	145	Switching Off the Electric Motor.....	113
S		Symbols Glossary.....	5
Safety Belt Height Adjustment.....	32	T	
Safety Belt Minder.....	33	Tailgate	
Belt-Minder™.....	33	See: Manual Liftgate.....	61
Safety Belts.....	29	Technical Specifications	
Principle of Operation.....	29	See: Capacities and Specifications.....	222
Safety Belt Warning Lamp and Indicator			
Chime.....	33		
Conditions of operation.....	33		
Scheduled Maintenance Record.....	351		
Scheduled Maintenance.....	347		
Seats.....	104		

Index

Temporary Mobility Kit.....189	Transmission
(Type 2).....194	See: Transmission.....122
First Stage: Inflating the Tire with Sealing Compound and Air.....191	Transporting the Vehicle.....143
General Information.....190	U
Second Stage: Checking Tire Pressure.....192	Under Hood Overview.....170
Tips for Use of the Kit.....190	Using Cruise Control.....133
What to Do After the Tire has Been Sealed.....193	Switching Cruise Control Off.....133
What to Do When a Tire Is Punctured.....191	Switching Cruise Control On.....133
What to Do When a Tire Is Punctured.....196	Using MyKey With Remote Start Systems.....54
The Better Business Bureau (BBB) Auto Line Program (U.S. Only).....154	Vehicles With Ford-Approved Aftermarket Remote Start Systems.....54
Tire Care.....201	Vehicles With Non-Ford-Approved Aftermarket Remote Start Systems.....54
Glossary of Tire Terminology.....203	Using Snow Chains.....216
Important Information for 235/40R18 Low-Profile Tires and Wheels.....201	Using Traction Control.....127
Information About Uniform Tire Quality Grading.....201	Switching the System Off Using a Switch.....127
Information Contained on the Tire Sidewall.....204	Switching the System Off Using the Information Display Controls.....127
Temperature A B C.....202	System Warning Lamps and Messages.....127
Traction AA A B C.....202	Utilizing the Mediation/Arbitration Program (Canada Only).....154
Treadwear.....202	V
Tire Inflation When Punctured See: Temporary Mobility Kit.....189	Vehicle Care.....182
Tire Pressure Monitoring System.....216	General Information.....182
Changing Tires With a Tire Pressure Monitoring System.....217	Vehicle Certification Label.....223
Understanding Your Tire Pressure Monitoring System.....217	Vehicle Identification Number.....223
Tire Repair Kit See: Temporary Mobility Kit.....189	Vehicle Interior Overview.....14
Tires See: Wheels and Tires.....189	Vehicle Storage.....186
Towing a Trailer.....143	12V Battery.....187
Towing the Vehicle on Four Wheels.....143	Body.....187
Emergency Towing.....143	Brakes.....188
Recreational Towing.....144	Cooling System.....187
Towing.....143	Electric Motor.....187
Traction Control.....127	Fuel System.....187
Principle of Operation.....127	General.....187
Transmission Code Designation.....224	Miscellaneous.....188
Transmission.....122	Removing Vehicle From Storage.....188
	Tires.....188
	Ventilation See: Climate Control.....100

Index

VIN
See: Vehicle Identification Number.....223
Voice Control.....68

W

Warning Lamps and Indicators.....83
Anti-Lock Braking System Warning
Lamp.....83
Battery Warning Lamp.....83
Brake System Warning Lamp.....83
Cruise Control Indicator83
Direction Indicator.....83
Door Ajar.....83
Fasten Safety Belt Warning Lamp.....84
Front Airbag Warning Lamp.....84
Headlamp and Parking Lamp Indicator
.....84
High Beam Indicator.....84
Liftgate Ajar.....84
Limited Performance.....84
Low Battery.....84
Low Tire Pressure Warning.....84
Low Washer Fluid.....84
Motor Coolant Temperature.....83
Powertrain Fault.....84
Ready to Drive.....84
Stability Control Off Indicator.....85
Stability Control Warning Lamp85
Stop Safely.....85
Vehicle Plugged in.....85
Washer Fluid Check.....173
Washers
See: Cleaning the Exterior.....182
See: Wipers and Washers.....70
Waxing.....183
Wheel Nuts
See: Changing a Road Wheel.....220
Wheels and Tires.....189
Windows and Mirrors.....77
Windshield Washers.....70
Windshield Wipers.....70
Intermittent Wipe.....70
Speed Dependent Wipers.....70
Wipers and Washers.....70