

FORTINET



FortiAP 224E

QuickStart Guide



11/10/2017

Copyright© 2017 Fortinet, Inc. All rights reserved. Fortinet®, FortiGate®, FortiCare® and FortiGuard®, and certain other marks are registered trademarks of Fortinet, Inc., in the U.S. and other jurisdictions, and other Fortinet names herein may also be registered and/or common law trademarks of Fortinet. All other product or company names may be trademarks of their respective owners. Performance and other metrics contained herein were attained in internal lab tests under ideal conditions, and actual performance and other results may vary. Network variables, different network environments and other conditions may affect performance results. Nothing herein represents any binding commitment by Fortinet, and Fortinet disclaims all warranties, whether express or implied, except to the extent Fortinet enters a binding written contract, signed by Fortinet's General Counsel, with a purchaser that expressly warrants that the identified product will perform according to certain expressly-identified performance metrics and, in such event, only the specific performance metrics expressly identified in such binding written contract shall be binding on Fortinet. For absolute clarity, any such warranty will be limited to performance in the same ideal conditions as in Fortinet's internal lab tests. In no event does Fortinet make any commitment related to future deliverables, features, or development, and circumstances may change such that any forward-looking statements herein are not accurate. Fortinet disclaims in full any covenants, representations, and guarantees pursuant hereto, whether express or implied. Fortinet reserves the right to change, modify, transfer, or otherwise revise this publication without notice, and the most current version of the publication shall be applicable.

Cautions and Warnings

Environmental specifications

Ambient operating temperature: 0C to 40C

Refer to specific Product Model Data Sheet for Environmental Specifications (Operating Temperature, Storage Temperature, Humidity, and Altitude).

Référez à la Fiche Technique de ce produit pour les caractéristiques environnementales (Température de fonctionnement, température de stockage, humidité et l'altitude).

Safety

Caution: This equipment is to be used in a Network Environment 0 per IECTR 62101. This product is connected only to PoE networks without routing to the outside plant.

Attention: Ce matériel doit être utilisé dans un Environnement Réseau 0 par IECTR 62101. Ce produit est uniquement connecté aux réseaux PoE sans installation externe de routage.

Box Includes



FortiAP device



QuickStart Guide

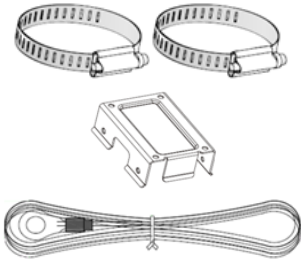

Pole Mount Straps (X2),
Wall Mount Bracket, and
Grounding Cable 6M

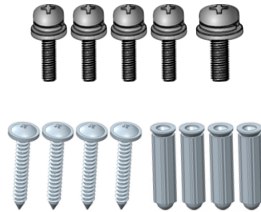

Pole and Wall Mounting Kits:

Machine Pan M4x10L screws (X4), Machine pan
M5x10L screw, Self-Tapping Steel Pan P3x20L (X4),
and Plastic Conical wall anchors (X4)

Before You Begin

Write down details typically provided by your network administrator or ISP.

Static IP address

IP address _____

Subnet Mask _____

Default Gateway _____

Primary/Secondary DNS _____

DHCP

It is normal to not require a hostname, but your ISP might require it.

Hostname _____



QuickStart Guide Video

[https://video.fortinet.com/video/177/
fortigate-and-fortiap](https://video.fortinet.com/video/177/fortigate-and-fortiap)

FortiAP 224E - Device Front

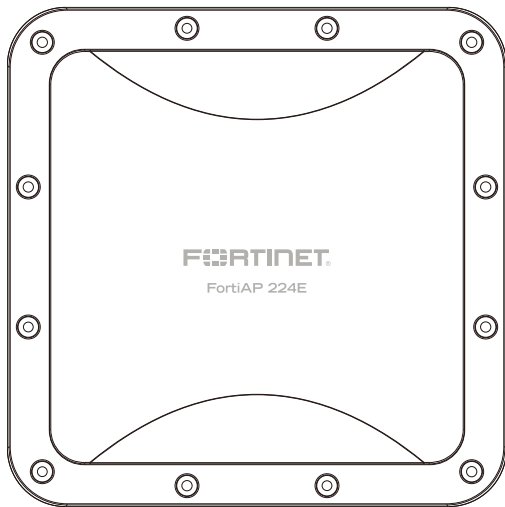

FortiAP 224E - Device Rear

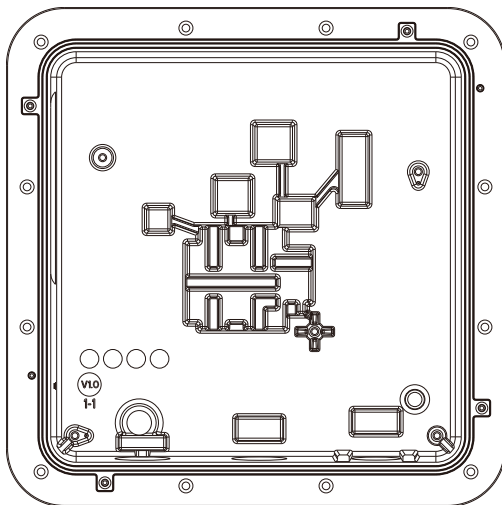

FortiAP 224E - Device Side (LEDs)

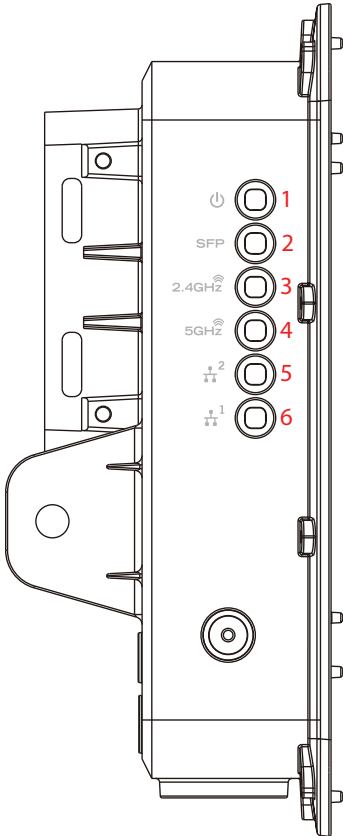

1: Power

Green: System is ready
Off: Power off
Amber: System is booting up
Off: System booted

2: Small form-factor pluggable (SFP)

Green: Connect to optical port
Blinking: Optical activity present
Off: No activity or power off
Amber: Reserved

3: 2.4GHz WLAN

Green: Connect to WLAN port
Blinking: WLAN activity present
Off: No activity or power off
Amber: Reserved

4: 5GHz WLAN

Green: Connect to WLAN port
Blinking: WLAN activity present
Off: No activity or power off
Amber: Reserved

5: LAN2

Amber: Device connected to LAN port at 10/100/1000Mbps
Blinking: LAN activity present
Off: Not connected

6: LAN1 (PoE)

Amber: Device connected to LAN port at 10/100/1000Mbps
Blinking: LAN activity present
Off: Not connected

1 Installation

Mount on Wall

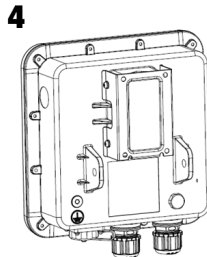
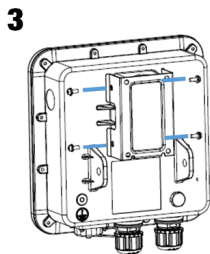
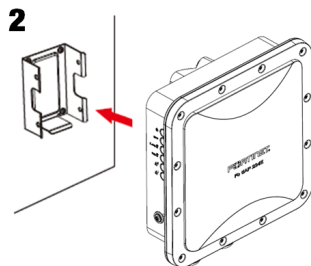
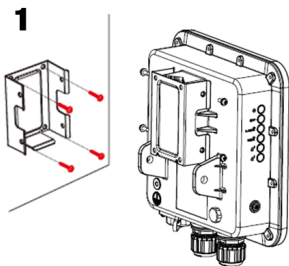

Mount on Pole

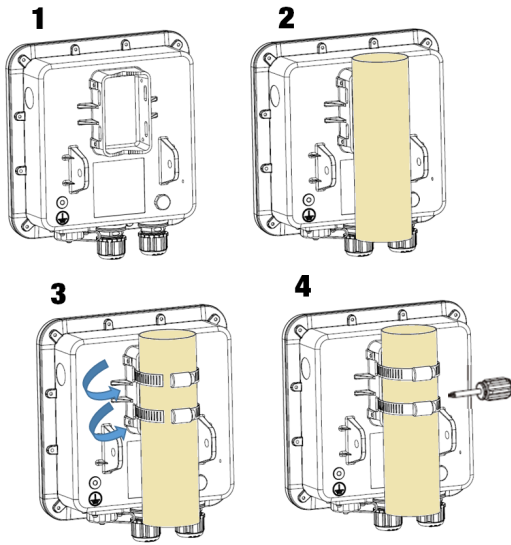

Rotating Mount

Fasten the Hold Bracket (1) and the Bracket Sheets (2) to the base using the M8x32L Hexagon screw bolts and washers:

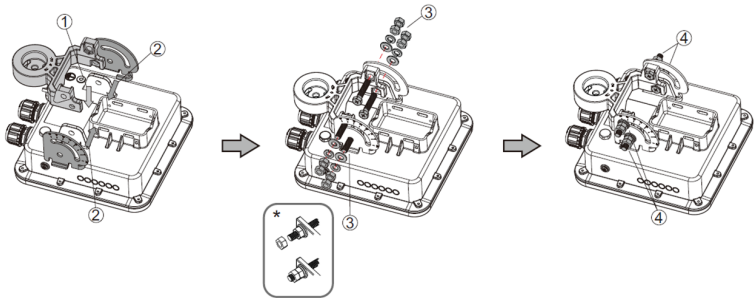

Fasten the Pole Bracket & Wall Bracket to the pole using supplied M8x160L Hexagon screw bolts (5 and 6):

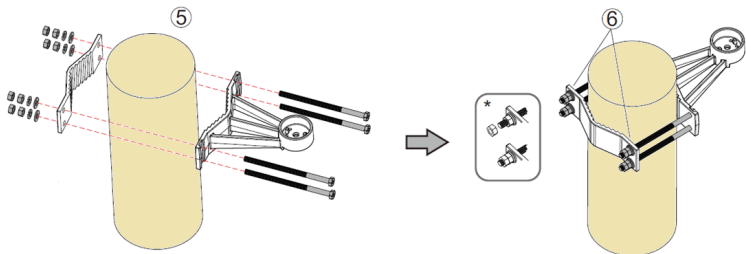

Fasten the Pole Bracket to the Wall Bracket by securing the supplied M8x32L Hexagon screw bolts (7, 8, and 9):

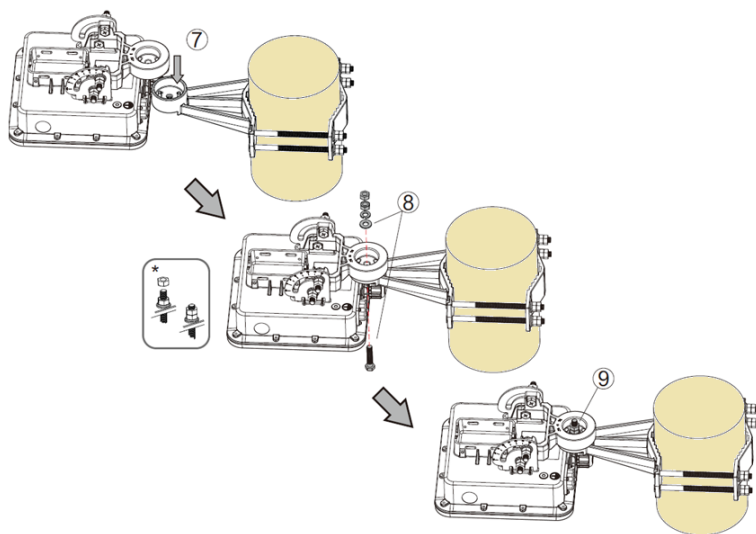

To adjust the unit to tilt up and down:

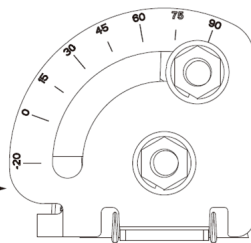
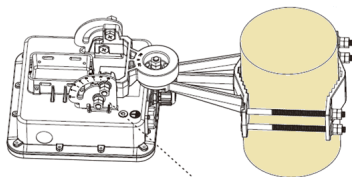

Up / down tilting



Up / down tilting: -20°-90°

Tilt up -20°

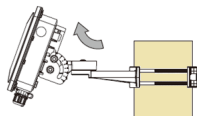

Tilt down 90°

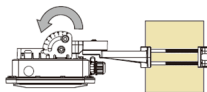

To adjust the unit to tilt left and right:

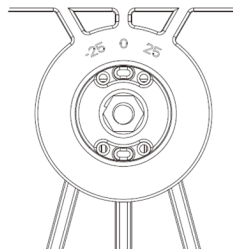
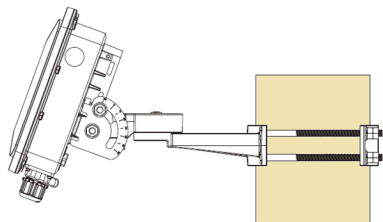

Left / right rotating

Left rotating 25°

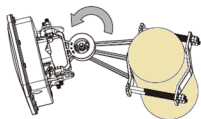

Right rotating 25°

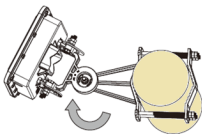

Left / right rotating: -25°-25°

The unit requires 48V DC power, which is delivered by the [PoE injector](#) over a straight-through [Ethernet cable](#).

To install the weatherproof connector

1. Unscrew the coupling ring from the waterproof connector, remove the sealing gland, and thread the RJ-45 plug through the connector components.

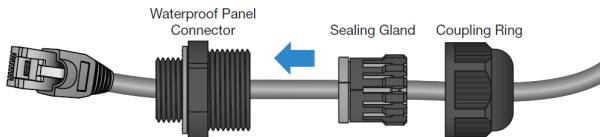

2. Insert the RJ-45 plug into the PoE port on the unit and install the weatherproof panel connector onto the threaded coupling at the port.
3. Slide the sealing gland along the cable into the panel connector.

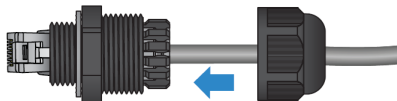

4. Thread the coupling ring into the panel connector and tighten it until the sealing gland is compressed, making a watertight seal on the cable.

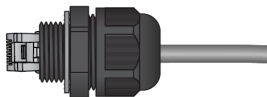

2 Basic Connection

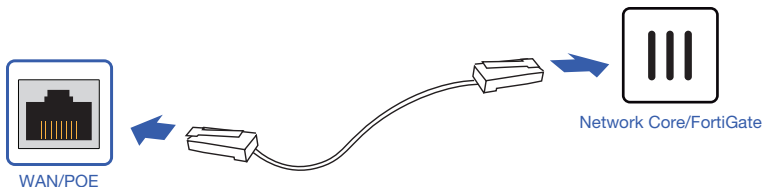

Connect the FortiAP device to a FortiGate controller or an Internet connection.

Ensure that the Power over Ethernet (PoE) cable is connected to an applicable port on your FortiGate device or PoE injector.

Caution: Adequate grounding must be provided to the FortiAP unit and the PoE injector, in compliance with your local electrical code or regulations.

Warning: This device complies with IEEE 802.3af PoE specification. Do not use any PoE injectors that are not IEEE 802.3af compliant as they may damage your device.

③ FortiAP Setup

Deployment through a FortiGate

Ensure that you are running the Fortinet recommended version of software. Please check support.fortinet.com for more information.

If FortiGate is on the same network as the FortiAP:

1. Use FortiGate to preauthorize the FortiAP device.
2. Refer to the “Access Point Deployment” section of the FortiWiFi and FortiAP Configuration Guide found at <http://forti.net/ap-docs>.
3. Plug the FortiAP into your local Ethernet connection. The FortiAP will self-configure.

Or

1. Instead of preauthorizing, you can use the FortiGate to authorize the FortiAP device after you have connected the FortiAP to the network.
2. Within two minutes of connecting the FortiAP to the FortiGate, the device appears on the Managed FortiAP page in the Web-based Manager: authorize and assign a profile to the device.

Access Point	State	Connected Via	SSIDs	Channel	Clients
FC221E-4N16000001	○	-	Radio 1: None Radio 2: None	Radio1:0 Radio2:0	Radio 1:0 Radio 2:0
FC225C-4N15000007	○	-	Radio 1: None Radio 2: None	Radio1:0 Radio2:0	Radio 1:0 Radio 2:0
FC224E-4N16000001	○	-	Radio 1: None Radio 2: None	Radio1:0 Radio2:0	Radio 1:0 Radio 2:0
FC23JD-4N16000001	○	192.168.1.104	Radio 1: None Radio 2: None	Radio1:0 Radio2:0	Radio 1:0 Radio 2:0

If FortiGate is not on the same network as the FortiAP:

1. Log into FortiAP directly (IP address: 192.168.1.2) with username `admin` and no password, and specify the IP address of the controlling FortiGate.
2. Connect to FortiAP via the CLI using the instructions in the “Connecting to FortiAP CLI” section of the FortiWiFi and FortiAP Configuration guide.
3. Specify the IP address of the controlling FortiGate:

```
config capwap wtp acIpAddr 0.0.0.0
```

where 0.0.0.0 is the address of the FortiGate.

4. The FortiAP device connects to FortiGate, and then you can authorize the FortiAP.

Cautions and Warnings

Environmental specifications

Ambient operating temperature: -30C to 60C

Refer to specific Product Model Data Sheet for Environmental Specifications (Operating Temperature, Storage Temperature, Humidity, and Altitude)

Référez à la Fiche Technique de ce produit pour les caractéristiques environnementales (Température de fonctionnement, température de stockage, humidité et l'altitude).

Safety

Warning: Equipment intended for installation in Restricted Access Location.

Avertissement: Le matériel est conçu pour être installé dans un endroit où l'accès est restreint.

Caution: This equipment is to be used in a Network Environment 0 per IECTR 62101. This product is connected only to PoE networks without routing to the outside plant.

Attention: Ce matériel doit être utilisé dans un Environnement Réseau 0 par IECTR 62101. Ce produit est uniquement connecté aux réseaux PoE sans installation externe de routage.

This product is intended to be supplied 48-57 Vdc from PoE source.

Le produit doit être alimenté par à de 48-57 Vdc (PoE).

Grounding — To prevent damage to your equipment, connections that enter from outside the building should pass through a lightning / surge protector, and be properly grounded. Use an electrostatic discharge workstation (ESD) and/or wear an anti-static wrist strap while you work. In addition to the grounding terminal of the plug, on the back panel, there is another, separate terminal for earthing.

Mise à la terre — Pour éviter d'endommager votre matériel, assurez-vous que les branchements qui entrent à partir de l'extérieur du bâtiment passent par un parafoudre / parasurtenseur et sont correctement mis à la terre. Utilisez un poste de travail de décharge électrostatique (ESD) et / ou portez

un bracelet anti-statique lorsque vous travaillez. Ce produit possède une borne de mise à la terre qui est prévu à l'arrière du produit, à ceci s'ajoute la mise à la terre de la prise.

This product has a separate protective earthing terminal provided on the back of the product in addition to the grounding terminal of the attachment plug. This separate protective earthing terminal must be permanently connected to earth with a green with yellow stripe conductor minimum size # 14 AWG and the connection is to be installed by a qualified service personnel.

Ce produit a une borne de mise à la terre séparé sur le dos de l'appareil, en plus de la borne de mise à la terre de la fiche de raccordement. Cette borne de mise à la terre séparée doit être connecté en permanence à la terre avec un conducteur vert avec la taille bande jaune de minimum # 14 AWG et la connexion doit être installé par un personnel qualifié.

The connecting cable between the outdoor equipment and the indoor ITE devices should comply with Class 3 wiring methods as listed in NEC, Table 725.154(G) for Class 3 Cable Substitutions.

Le câble connectant l'équipement extérieur et ceux d'intérieur de type ITE doit être conforme avec les méthodes de câblage de classe 3 tel que listé dans le standard NEC, Table 725.154(G) pour les câbles de substitutions de classe 3.

PoE input cable type should be CL3, CL3P, CL3R, CL3X, marked "SUNLIGHT RESISTANT", "SUN. RES.", or "SR." and "water resistant" or "W".

Le type de câble PoE d'entrée doit être CL3, CL3P, CL3R, CL3X marqué "SUNLIGHT RESISTANT". "SUN RES.» Ou «SR», et "waterproof" ou "W".

If further assistance is needed with purchasing a power source and POE input cable, please contact Fortinet, Inc.

Si vous avez besoin de plus d'aide à l'achat de l'alimentation et le fil d'entrée PoE, s'il vous plaît communiquer avec Fortinet, Inc.

The Console port is not intended to be connected to the computer after the outdoor installation is completed.

La porte Console n'est pas destinée à être raccordée à l'ordinateur après l'installation extérieure faite.

This equipment is to be connected only to PoE networks (LPS) and maybe installed outdoors except the Surge Protector, the PoE Injector and its external LPS Power Supply which are intended for indoor installation only.

Ce produit doit être connecté uniquement aux réseaux POE et peut être installé à l'extérieur sauf le protecteur de surtension, l'injecteur PoE et son alimentation LPS externe qui sont destinés à une installation intérieure seulement

Regulatory Notices

Federal Communication Commission (FCC) - USA

This device complies with Part 15 of FCC Rules. Operation is subject to the following two conditions:

- (1) this device may not cause harmful interference, and
- (2) this device must accept any interference received; including interference that may cause undesired operation.

This equipment has been tested and found to comply with the limits for a Class B digital device, pursuant to Part 15 of the FCC Rules. These limits are designed to provide reasonable protection against harmful interference in residential installation. This equipment generates, uses, and can radiate radio frequency energy, and if it is not installed and used in accordance with the instruction manual, it may cause harmful interference to radio communications. However, there is no guarantee that interference will not occur in a particular installation.

If this equipment does cause harmful interference to radio or television reception, which can be determined by turning the equipment off and on, the user is encouraged to try to correct the interference by one or more of the following measures:

- Reorient or relocate the receiving antenna.

- Increase the separation between the equipment and receiver.

- Connect the equipment into an outlet on a circuit different from that to which the receiver is connected.

- Consult the dealer or an experienced radio/TV technician for help.

WARNING: Any changes or modifications to this unit not expressly approved by the party responsible for compliance could void the user's authority to operate the equipment

This equipment complies with FCC radiation exposure limits set forth for an uncontrolled environment. This equipment should be installed and operated with minimum distance 32 cm between the radiator and your body. This transmitter must not be co-located or operating in conjunction with any other antenna or transmitter.

This device meets all the other requirements specified in Part 15E, Section 15.407 of the FCC Rules.

Industry Canada Equipment Standard for Digital Equipment (ICES) - Canada

This Class B digital apparatus complies with Canadian ICES-003.

Cet appareil numérique de la classe B est conforme à la norme NMB-003 du Canada.

Innovation, Science and Economic Development (ISED) - Canada

This device complies with Industry Canada's licence-exempt RSSs. Operation is subject to the following two conditions:

- (1) This device may not cause interference; and
- (2) This device must accept any interference, including interference that may cause undesired operation of the device.

Le présent appareil est conforme aux CNR d'Industrie Canada applicables aux appareils radio exempts de licence. L'exploitation est autorisée aux deux conditions suivantes:

- (1) l'appareil ne doit pas produire de brouillage, et
- (2) l'utilisateur de l'appareil doit accepter tout brouillage radioélectrique subi, même si le brouillage est susceptible d'en compromettre le fonctionnement.

For product available in the USA/Canada market, only channel 1~11 can be operated. Selection of other channels is not possible.

Pour les produits disponibles aux États-Unis / Canada du marché, seul le canal 1 à 11 peuvent être exploités. Sélection d'autres canaux n'est pas possible.

This equipment complies with ISED radiation exposure limits set forth for an uncontrolled environment. This equipment should be installed and operated with minimum distance 32 cm between the radiator & your body.

Cet équipement est conforme aux limites d'exposition aux rayonnements ISED établies pour un environnement non contrôlé. Cet équipement doit être installé et utilisé avec un minimum de 32 cm de distance entre la source de rayonnement et votre corps.

Caution: The device for the band 5150-5250 MHz is only for indoor usage to reduce potential for harmful interference to co-channel mobile satellite systems. High-power radars are allocated as primary users (i.e. priority users) of the bands 5250-5350 MHz and 5650-5850 MHz and that these radars could cause interference and/or damage to LE-LAN devices.

Attention: Le dispositif de la bande 5150-5250 MHz est réservé à un usage intérieur afin de réduire l'interférence nuisible potentielle aux systèmes mobiles par satellite co-canal. Les radars à haute puissance sont désignés comme utilisateurs principaux (à savoir les utilisateurs prioritaires) des bandes 5250-5350 MHz et 5650-5850 MHz et que ces radars pourraient causer des interférences et / ou endommager les périphériques LE-LAN

This device has been designed to operate with an antenna having a maximum gain of 5.9 dBi for 2.4GHz and 6.5 dBi for 5GHz. Antenna having a higher gain is strictly prohibited per regulations of ISED. The required antenna impedance is 50 ohms.

Under ISED regulations, this radio transmitter may only operate using an antenna of a type and maximum (or lesser) gain approved for the transmitter by ISED. To reduce potential radio interference to other users, the antenna type and its gain should be so chosen that the equivalent isotopically radiated power (e.i.r.p.) is not more than that necessary for successful communication.

Ce dispositif a été conçu pour fonctionner avec une antenne ayant un gain maximal de 5.9 dBi pour 2,4 GHz et 6.5 dBi pour 5GHz. Une antenne ayant un gain supérieur sont strictement interdites par la réglementation d'ISED. L'impédance d'antenne requise est de 50 ohms.

Conformément à la réglementation d'ISED, cet émetteur radio peut fonctionner seulement avec une antenne d'un type et d'un gain maximal (ou inférieur) approuvé pour l'émetteur par ISED. Dans le but de réduire les risques de brouillage radioélectrique aux autres utilisateurs, il faut choisir le type d'antenne et son gain de sorte que la puissance isotrope rayonnée équivalente (p.i.r.e.) ne dépasse pas l'intensité nécessaire à l'établissement d'une communication réussie.

This radio transmitter (IC: 7280B-2517Q021) has been approved by ISED to operate with the antenna types listed below with the maximum permissible gain and required antenna impedance for each antenna type indicated. Antenna types not included in this list, having a gain greater than the maximum gain indicated for that type, are strictly prohibited for use with this device.

Le présent émetteur radio (IC: 7280B-2517Q021) a été approuvé par ISED pour fonctionner avec les types d'antenne énumérés ci-dessous et ayant un gain admissible maximal et l'impédance requise pour chaque type d'antenne. Les types d'antenne non inclus dans cette liste, ou dont le gain est supérieur au gain maximal indiqué, sont strictement interdits pour l'exploitation de l'émetteur.

This device and its antennas(s) must not be co-located or operating in conjunction with any other antenna or transmitter except in accordance with IC multi-transmitter product procedures.

Cet appareil et son antenne (s) ne doit pas être co-localisés ou fonctionnement en association avec une autre antenne ou transmetteur.

Qty	MPN	Antenna Type	Antenna Connector	Gain (dBi)				
				2.4GHz	5GHz			
					Band 1	Band 2	Band 3	Band 4
1	RFMTA400809MMLB901	Metal Antenna	MMCX	5.9	-	-	-	-
1	RFMTA400811MMLB901	Metal Antenna	MMCX	5.9	-	-	-	-
1	RFMTA400814MM5B901	Metal Antenna	MMCX	-	6.2	6.5	6.5	6.4
1	RFMTA400816MM5B901	Metal Antenna	MMCX	-	6.2	6.5	6.5	6.4
1	RFPCA381017MMAB702	PCB Antenna	MMCX	8.6	-	-	-	-

Professional Installation Instruction

1. Installation personnel

This product is designed for specific application and needs to be installed by qualified personnel who has RF and related rule knowledge. The general user shall not attempt to install or change the settings.

2. Installation location

The product shall be installed at a location where the radiating antenna can be kept 32 cm from nearby person in normal operation condition to meet Regulatory RF exposure requirement. The installation applies to both indoor and outdoor location.

3. Antenna(s)

Use only the antenna(s) that have been approved by the manufacturer. The non-approved antenna(s) may produce unwanted spurious or excessive RF transmitting power that may lead to the violation of FCC/ISED limit and is prohibited.

4. Warning

Please carefully select the installation position and ensure that the final output power does not exceed the limit set forth in relevant rules. The violation of the rule could lead to serious federal penalty.

Instructions d'installation professionnelle

1. Installation

Ce produit est conçu pour un usage spécifique et doit être installé par un personnel qualifié maîtrisant les radiofréquences et règle similaires. L'utilisateur ne doit pas tenter d'installer ou de modifier les paramètres.

2. Emplacement d'installation

En usage normal, afin de respecter les exigences réglementaires concernant l'exposition aux radiofréquences, ce produit doit être installé de façon à respecter une distance de 32 cm entre l'antenne émettrice et. L'installation s'applique aux emplacements intérieur et extérieur.

3. Antenne(s)

Utiliser uniquement l'antenne (s) approuvées par le fabricant. L'utilisation d'autres antennes peut conduire à un niveau de rayonnement essentiel ou non essentiel dépassant les niveaux limites définis par FCC/ISED, ce qui est interdit.

4. Avertissement

Choisir avec soin la position d'installation et s'assurer que la puissance de sortie ne dépasse pas les limites en vigueur. La violation de cette règle peut conduire à de sérieuses pénalités fédérales.

European Conformity (CE) - EU

This is a Class B product. In a domestic environment, this product may cause radio interference, in which case the user may be required to take adequate measures.



The product transmits within the frequency ranges and less than or equal to the power listed below:

2412-2472MHz less than 20dBm

5180-5240MHz less than 23dBm

5260-5320MHz less than 23dBm *

5500-5700MHz less than 30dBm *

Note: * Only with DFS bands certification.

This equipment should be installed and operated with minimum distance 32cm between the radiator & your body.

Simplified EU Declaration of Conformity

This declaration is only valid for Fortinet products (including, combinations of software, firmware and hardware) provided by Fortinet or Fortinet's authorized partners to the end customer directly for use within the EU or countries that have implemented the EU Directives and/or spectrum regulation. Any Fortinet products not obtained directly from Fortinet or Fortinet's authorized partners may not comply with EU Directives and Fortinet makes no assurances for such products.

Български

Този продукт е в съответствие с Директива 2014/53/ЕС.

Česky

Tento produkt je v souladu se směrnici 2014/53/EU.

Dansk

Denne produkt er i overensstemmelse med direktiv 2014/53/EU.

Deutsch

Dieses Produkt entspricht der Richtlinie 2014/53/EU.

Eesti

See toode vastab direktiivile 2014/53/EL.

English

This product is in compliance with Directive 2014/53/EU.

Español

Este producto cumple con la Directiva 2014/53/UE.

Ελληνική

Το προϊόν αυτό συμμορφώνεται με την Οδηγία 2014/53/ΕΕ.

Français

Ce produit est conforme à la Directive 2014/53/UE.

Hrvatski

Ovaj proizvod je u skladu s Direktivom 2014/53/EU.

Italiano

Questo prodotto è conforme alla Direttiva 2014/53/EU.

Latviski

Questo prodotto è conforme alla Direttiva 2014/53/EU.

Lietuvių

Šis gaminys atitinka direktyvą 2014/53/ES.

Malti

Dan il-prodott huwa konformi mad-Direttiva 2014/53/UE.

Magyar

Ez a termék megfelel a 2014/53/EU irányelvnek.

Nederlands

Dit product is in overeenstemming met Richtlijn 2014/53/EU.

Norsk

Dette produktet er i samsvar med direktiv 2014/53/EU.

Polski

Ten produkt jest zgodny z dyrektywą 2014/53/UE.

Português

Este produto está em conformidade com a Diretiva 2014/53/UE.

Rumunski

Acest produs este în conformitate cu Directiva 2014/53/UE.

Slovensky

Tento produkt je v súlade so smernicou 2014/53/EÚ.

Slovensko

Ta izdelek je v skladu z Direktivo 2014/53/EU.

Suomi

Tämä tuote on direktiivin 2014/53/EU mukainen.

Svenska

Denna produkt överensstämmer med direktiv 2014/53/EU.

Note: The full declaration of conformity for this product is available at the link below:

<https://site.fortinet.com/ProductRegulatory/EU>

The device is restricted to indoor use only when operating in the 5150 to 5350 MHz frequency range in the following countries:



AT	BE	BG	HR	CY	CZ	DK
EE	FI	FR	DE	EL	HU	IE
IT	LV	LT	LU	MT	NL	PL
PT	RO	SK	SI	ES	SE	UK

Fortinet Customer Service & Support

Create a support account, register and manage your products, download updates, firmware images and release notes, and create technical support tickets.

<https://support.fortinet.com>

Fortinet Document Library

Up-to-date versions of Fortinet publications for the entire family of Fortinet products.

<http://docs.fortinet.com>

Training Services

Course descriptions, availability, schedules, and location of training programs in your area.

<http://www.fortinet.com/training>

Technical Discussion Forums

Communicate with other customers and Fortinet partners about Fortinet products, services, and configuration issues.

<https://support.fortinet.com/forum>

FortiGuard Threat Research and Response

Up-to-date information on vulnerabilities and threats, includes a virus scanner, IP signature look-up, and web filtering tools.

<http://www.fortiguard.com>

Fortinet.com