

8588 088 000
(452186)

Owner's Manual

MR16

DIGITAL MULTITRACKER





Caution: Please visit Fostex website (<http://www.fostex.com>) for the latest version software.

Note: The MR16 has two models: one has a built in CD-R/RW drive , while the other has no CD-R/RW drive.

This manual can be used for both manual. Each MR16 model also contains the independent supplementary manual which explains how to create an audio CD using the internal or an external CD-R/RW drive. Therefore, if you attempt to create an audio CD (CD-DA), read the supplementary manual.

Fostex[®]

	CAUTION RISK OF ELECTRIC SHOCK DO NOT OPEN	
<p>CAUTION: TO REDUCE THE RISK OF ELECTRIC SHOCK, DO NOT REMOVE COVER (OR BACK). NO USER - SERVICEABLE PARTS INSIDE. REFER SERVICING TO QUALIFIED SERVICE PERSONNEL.</p>		

"WARNING"

"TO REDUCE THE RISK OF FIRE OR ELECTRIC SHOCK, DO NOT EXPOSE THIS APPLIANCE TO RAIN OR MOISTURE."

SAFETY INSTRUCTIONS

1. Read Instructions - All the safety and operating instructions should be read before the appliance is operated.
2. Retain Instructions - The safety and operating instructions should be retained for future reference.
3. Heed Warnings - All warnings on the appliance and in the operating instructions should be adhered to.
4. Follow Instructions - All operating and use instructions should be followed.
5. Water and Moisture - The appliance should not be used near water - for example, near a bathtub, washbowl, kitchen sink, laundry tub, in a wet basement, or near a swimming pool, and the like.
6. Carts and Stands - The appliance should be used only with a cart or stand that is recommended by the manufacturer.



An appliance and cart combination should be moved with care. Quick stops, excessive force, and uneven surfaces may cause the appliance and cart combination to overturn.

7. Wall or Ceiling Mounting - The appliance should be mounted to a wall or ceiling only as recommended by the manufacturer.
8. Ventilation - The appliance should be situated so that its location or position does not interfere with its proper ventilation. For example, the appliance should not be situated on a bed, sofa, rug, or similar surface that may block the ventilation openings; or, placed in a built-in installation, such as a bookcase or cabinet that may impede the flow of air through the ventilation openings.
9. Heat - The appliance should be situated away from heat sources such as radiators, heat registers, stoves, or other appliances (including amplifiers) that produce heat.
10. Power Sources - The appliance should be connected to a power supply only of the type described in the operating instructions or as marked on the appliance.
11. Grounding or Polarization - The precautions that should be taken so that the grounding or polarization means of an appliance is not defeated.

<p>CAUTION: TO PREVENT ELECTRIC SHOCK, MATCH WIDE BLADE OF PLUG TO WIDE SLOT, FULLY INSERT.</p> <p>ATTENTION: POUR ÉVITER LES CHOC ÉLECTRIQUES, INTRODUIRE LA LAME LA PLUS LARGE DE LA FICHE DANS LA BORNE CORRESPONDANTE DE LA PRISE ET POUSSER JUSQU' AU FOND.</p>
--



The lightning flash with arrowhead symbol, within an equilateral triangle, is intended to alert the user to the presence of uninsulated "dangerous voltage" within the product's enclosure that may be of sufficient magnitude to constitute a risk of electric shock to persons.



The exclamation point within an equilateral triangle is intended to alert the user to the presence of important operating and maintenance (servicing) instructions in the literature accompanying the appliance.

12. Power Cord Protection - Power supply cords should be routed so that they are not likely to be walked on or pinched by items placed upon or against them, paying particular attention to cords at plugs, convenience receptacles, and the point where they exit from the appliance.
13. Cleaning - The appliance should be cleaned only as recommended by the manufacturer.
14. Nonuse Periods - The power cord of the appliance should be unplugged from the outlet when left unused for a long period of time.
15. Object and Liquid Entry - Care should be taken so that objects do not fall and liquids are not spilled into the enclosure through openings.
16. Damage Requiring Service - The appliance should be serviced by qualified service personnel when:
 - A. The power supply cord or the plug has been damaged; or
 - B. Objects have fallen, or liquid has been spilled into the appliance; or
 - C. The appliance has been exposed to rain; or
 - D. The appliance does not appear to operate normally or exhibits a marked change in performance; or
 - E. The appliance has been dropped, or the enclosure damaged.
17. Servicing - The user should not attempt to service the appliance beyond that described in the operating instructions. All other servicing should be referred to qualified service personnel.
18. The appliance should be situated away from drops of water or spray of water.
19. Objects containing liquid such as vase must not be put on the appliance.
20. The appliance is not completely isolated from the power supply even if the power switch is at off position.
21. Apparatus shall not be exposed to dripping or splashing and no objects filled with liquids, such as vases, shall be placed on the apparatus.
22. Only use attachments/accessories specified by the manufacturer.
23. An appliance with a protective earth terminal should be connected to a mains outlet with a protective earth connection.
24. An appliance should be placed in a position where an AC plug / inlet can be easily pulled out by hand.
25. Main plug is used as the disconnection device. It shall remain readily operable and should not be obstructed during intended use. To be completely disconnected the apparatus from supply mains, the mains plug of the apparatus shall be disconnected from the mains socket outlet completely.

Important Safety Instructions

- 1) Read these instructions.
- 2) Keep these instructions.
- 3) Heed all warnings.
- 4) Follow all instructions.
- 5) Do not use this apparatus near water.
- 6) Clean only with dry cloth.
- 7) Do not block any ventilation openings. Install in accordance with the manufacturer's instructions.
- 8) Do not install near any heat sources such as radiators, heat registers, stoves, or other apparatus (including amplifiers) that produce heat.
- 9) Do not defeat the safety purpose of the polarized or grounding-type plug. A polarized plug has two blades with one wider than the other. A grounding type plug has two blades and a third grounding prong. The wide blade or the third prong are provided for your safety. If the provided plug does not fit into your outlet, consult an electrician for replacement of the obsolete outlet.
- 10) Protect the power cord from being walked on or pinched particularly at plugs, convenience receptacles, and the point where they exit from the apparatus.
- 11) Only use attachments/accessories specified by the manufacturer.
- 12) Use only with the cart, stand, tripod, bracket, or table specified by the manufacturer, or sold with the apparatus. When a cart is used, use caution when moving the cart/apparatus combination to avoid injury from tip-over.



- 13) Unplug this apparatus during lightning storms or when unused for long periods of time.
- 14) Refer all servicing to qualified service personnel. Servicing is required when the apparatus has been damaged in any way, such as power-supply cord or plug is damaged, liquid has been spilled or objects have fallen into the apparatus, the apparatus has been exposed to rain or moisture, does not operate normally, or has been dropped.

Table of contents

Safety Instructions	2
---------------------------	---

Read this chapter first!	9
--------------------------------	---

Precautions before using	10
About power supply	10
Precautions upon installing the MR16	10
Notes on repair	10
About copyrights	10
About damages	10
Note on audio interruption	10
Notes on USB connection with Mac OS	10

MR16 main features	11
---------------------------------	-----------

The basics of the MR16	13
Recording method	13
About song	14
Remain (recordable space left on the disk)	14
Time base	15
Input and repro monitor	15
TRIM control	16

How to burn an audio CD	17
--------------------------------------	-----------

Names and functions	19
----------------------------------	-----------

Top panel 1	20
-------------------	----

Top panel 2	22
-------------------	----

Rear panel	24
------------------	----

Front panel (CD-R/RW drive built-in model only)	25
---	----

LCD display	26
--------------------------	-----------

Home screen	26
-------------------	----

Selecting a time base mode	27
----------------------------------	----

Adjusting the display contrast	27
--------------------------------------	----

MENU mode screen	28
------------------------	----

Warning message	28
-----------------------	----

Basic operations	29
-------------------------------	-----------

About power	30
--------------------------	-----------

Power connection	30
------------------------	----

Turning on the unit	30
---------------------------	----

Listening the demo song	31
--------------------------------------	-----------

Connecting headphones (or a monitor speaker system)	31
---	----

Playing back the demo song	32
----------------------------------	----

Creating a song for recording	33
--	-----------

Input connection	35
Input channel	35
[INPUT A SELECT] switch	35
Recording track combinations and available input channel(s)	36
Recording onto a single track	37
Preparation for recording	37
Starting recording	38
Playing back the recorded track	38
Undoing recording (undo/redo)	38
Overdubbing basics	39
Preparation for recording	39
Adjusting the recording levels while listening to track 1	40
Starting recording	40
Playing back recorded track	40
Undoing recording (undo/redo)	40
Recording onto four tracks simultaneously	41
Preparation for recording	41
Starting recording	42
Playing back recorded tracks	42
Undoing recording (undo/redo)	42
Basic mixdown	43
Mixdown to an analog recorder	44
Mixdown to a digital recorder	45
Advanced playback and locates functions	47
3 x cueing	48
Playback between LOCATE A and B points	48
Play mode	49
Selecting a play mode	49
Auto play mode	50
Auto return mode	50
Loop mode	50
Loop function in auto punch in/out mode	51
Locate function	52
Time locate	52
Locating to the beginning (ABS ZERO) of a song	52
Locating to the recording end point (REC END) of a song	52
Locating to the LOCATE A or LOCATE B point	53
Setting the LOCATE A or LOCATE B point	53
Locating	54
Direct locate mode	55
Direct locate mode basics	55
Setting the locate accuracy	56
Example of using the direct locate function	56
Previewing the locate point	58
Punch in/out	59
Punch in/out using the keys on the top panel	60
Punch in/out using the footswitch	61

Auto punch in/out	62
Setting the punch-in and punch-out points	62
Rehearsal for auto punch in/out	63
Actual auto punch in/out	64

Using effects65

Using the input EQ for recording	66
Turning of the input EQ	66
Selecting a desired EQ preset entry	66
Using the insert effects for recording	68
Mic simulation effects	68
Amp simulation effects	68
Using external effects for recording	69
Using the reverb or delay	70
Selecting an effect type	70
Selecting a delay type	71
Adjusting the delay/reverb time	71
Adjusting the effect send levels	72
Using the mastering effects	73
Selecting the desired effect type	74

Track bouncing75

Preliminary knowledge	76
Track bouncing example	76
Track bouncing modes	77
Selecting the track bouncing mode	78
Bouncing tracks 1 through 14 to tracks 15/16	79
Rehearsal of track bouncing	79
Actual track bouncing	81
Checking the bounced signals on tracks 15/16	81
Bouncing tracks 1 through 16 to a new song	82
Rehearsal of track bouncing	82
Actual track bouncing	83
Mixing signals of inputs A through D	85
Connecting sound sources to INPUT A through INPUT D	85
[TO STEREO BUSS] key setting	85
Panning setting for INPUT A through INPUT D	86
Bouncing the desired part of a song	87

Rhythm guide function89

Using the rhythm guide function	90
Setting the time signature and tempo	90
Creating the conductor map	92
Setting the signature map	92
Editing a time signature event	94
Deleting an unnecessary time signature event	94

Editing the bar offset	95
Setting the tempo map	96
Editing a tempo event	98
Deleting an unnecessary tempo event	98
MIDI synchronization	99
Synchronization using MTC	100
Connection	100
Settings of the MR16 and MIDI sequencer	100
MIDI sync/MTC frame rate settings	101
Synchronization using MIDI clock	102
Connection	102
Settings of the MR16 and MIDI sequencer	102
Data export to a personal computer	103
WAV file conversion	104
Enabling the file conversion	104
Procedure of file conversion	105
Exporting data to a personal computer	107
Connection to a personal computer	107
Exporting a WAV file to a personal computer	108
Protecting the hard disk	110
Archiving a song	111
Song management	113
Selecting the desired song	114
Editing a song name	115
Deleting an unnecessary song	116
Protecting a song	117
Track editing	119
Erasing track data	120
Copying/pasting track data	121
Moving track data	123
Exchanging whole track data	125
Part editing	127
Erasing the part(s)	128
Copying/pasting the part(s)-1	129
Copying/pasting the part(s)-2	131
Copying to the clipboard	131
Pasting clipboard data	133

Moving the part(s)	134
Exchange the parts	136
Other functions	139
Hard disk formatting	140
Peak hold time setting	141
Pre-roll/post-roll time setting	142
Beat resolution mode on/off	143
Phantom power on/off	144
Setting output mode of AUX OUT 1, 2	146
Initializing the MR16	147
Application examples	149
Application example 1 (Mixing)	150
Application example 2 (Live)	151
Troubleshooting	153
Trouble for recording	154
Trouble for playback	156
Trouble for effect	156
Trouble for USB connection	157
Other troubles	158
MR16 Specifications	159
Specifications	160
Physical dimensions	161
Block diagram	162
MIDI implementation chart	163
Index	164
Declaration of EC Directive	166

Read this chapter first!

Thank you very much for purchasing the Fostex MR16 digital multitracker. The MR16 is a digital multitracker which can record 16-track audio at 44.1 kHz/16 bits on the internal 3.5-inch hard disk. Up to four tracks can be recorded simultaneously.

The MR16 is also equipped with a 16-channel digital mixer, digital effects including the delay/reverb, insert effects (including simulation effects) and mastering effects. It allows you to carry out all the process for digital multitrack recording including overdubbing, track bouncing and mixdown within the digital domain, ensuring no loss of sound quality. The MR16 with the CD-R/RW drive built-in allows you to make an audio CD internally. If your MR16 does not have a built-in CD-R/RW drive, you can make an audio CD using an external CD-R/RW drive connected to the [USB HOST] port.

This chapter describes precautions before using, as well as features and basic knowledge of the MR16.

To understand the MR16 features and basic functions, read this chapter before using.

Precautions before using

About power supply

- Be sure to connect the MR16 to the power supply specified in the specifications section of this owner's manual. Do not use an AC outlet of any other voltage.
- Do not connect the MR16 to the same AC outlet to which devices that could generate noise (such as a large motor or dimmer), or the devices that consume a large amount of power (such as an air conditioning system or large electric heater) are connected.
- If you use the MR16 in an area with a different power voltage, first consult your dealer or the nearest Fostex service station.
- The [POWER] switch cannot turn off the power completely. When this switch is "up", the MR16 enters standby mode (i.e. the power does not completely turned off). Therefore, if you do not use the MR16 for a long time, we recommend unplugging the power cord from the AC outlet.
- It is very dangerous to use a power cord that is frayed or damage. In such a case, stop using the MR16 immediately and ask your dealer to repair the cord.

<Important! >

Model name, power requirement, serial number and other information for the MR16 are shown at the bottom of the unit.

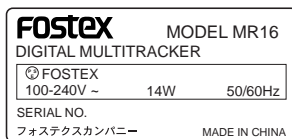

Precautions upon installing the MR16

- Do not install the MR16 in locations subject to the following:
 - * Extremely high or low temperature, or significant changes in temperature.
 - * Excessive humidity or dust.
 - * Excessive changes in power supply voltage.
 - * Unstable or significantly vibrating or shaking surfaces.
 - * Near a strong magnetic field (such as a TV or speaker).

Notes on repair

- The MR16 does not use any parts that user can repair easily. Contact your dealer or the nearest Fostex service station to ask about repairs.
- Use the original packing carton of the MR16 when you transport or send the MR16 to the dealer or Fostex service station for repair. If you have discarded the packing carton, pack the MR16 using shock absorbing materials. Fostex is not responsible for malfunction or damage due to incomplete packaging or caused during transportation.
- Because the MR16 is a consumer product, Fostex does not offer on-site service or provide a loaner unit while your MR16 is under repair.

About copyrights

- It is prohibited by law to use any part of a CD recording or video images or audio data for which copyright is possessed by a third party for commercial purposes such as contents, broadcasts, sales, or distribution-any purpose other than for your personal pleasure.

About damages

- Fostex is not responsible for any "direct damage" or "indirect damage" caused by using the MR16.

Notes on audio interruption

- If you make recording or editing to a song many times, audio may be occasionally interrupted when the song is played back, due to data fragmentation. Note that this is not a malfunction.

Note on USB connection with Mac OS

- Before you connect the MR16 to a Macintosh computer, make sure that the OS is Mac OS X or higher. The MR16 supports only Mac OS X or higher. If you connect the MR16 to a Macintosh computer with Mac OS lower than "OS X", song data on the MR16 may be damaged.

MR16 main features

- **Internal hard disk drive for reliable recording/playback**
 You can record high quality audio to the internal high performance 3.5-inch hard disk drive. You can also edit recorded audio later without sound deterioration. Up to 99 songs can be recorded.
- **Four analog input channels**
 The MR16 provides four analog input channels and up to four tracks can be recorded simultaneously. Input A features the guitar input to which you can apply distortion or an external effect unit via insert connection. Each input provides the [TRIM] control, allowing the perfect input level adjustment.
- **Input EQ**
 You can apply the input EQ to each of input signals (A through D) when recording. The input EQ library has 33 presets (L01 through L33) from which you can select an appropriate EQ setting (see page 66 for details).
- **Fostex original effects**
 An ASP digital effect processor (delay/reverb) with the algorithm newly developed by Fostex is built in. You can apply the effects to tracks 1 through 8 during mixdown and track bounce (see page 70 for details). In addition, the MR16 also provides insert effects for microphone and amplifier simulation for coloring sounds.
- **Mastering effects**
 The MR16 provides the mastering effects for stereo buss. You can apply the mastering effect during mastering. Three effect types are available. See page 73 for details.
- **Versatile editing functions**
 The MR16 provides versatile editing functions including copy, paste, move, import and erase (see pages 119 through 140 for details).
- **Versatile track bounce functions**
 To use the recording tracks effectively, the MR16 provides the following five track bounce modes (see page 75 for details).

 - (1) Bouncing tracks 1 through 8 to tracks 9/10
 - (2) Bouncing tracks 1 through 10 to tracks 11/12
 - (3) Bouncing tracks 1 through 12 to tracks 13/14
 - (4) Bouncing tracks 1 through 14 to tracks 15/16
 - (5) Bouncing tracks 1 through 16 to tracks 15/16 of the New song
- **Capability of exporting song data to a PC**
 The MR16 provides the [USB] port for PC connection. Mastered song data can be converted to a stereo WAV file and exported to a PC for creating an audio CD or audio DVD (see page 103 for details).

- **Audio CD burning capability**

If your MR16 does not have an internal CD-R/RW drive, you can burn an audio CD (CD-DA) from song data (stored in the 2 MIX folder) by connecting an external CD-R/RW drive to the [USB HOST] port of the unit.

If your MR16 has the internal CD-R/RW drive, you can burn an audio CD (CD-DA) from song data using the internal CD-R/RW drive. See the "Using the CD-R/RW drive" supplement for details.

- **Capability of exporting/importing a WAV file (CD-R/RW drive built-in model only)**

If your MR16 has the internal CD-R/RW drive, you can convert song data on the internal hard disk to a mono WAV file and export (copy) to a CD-R/RW disc set on the CD-R/RW drive, or import (copy) a WAV file from a CD-R/RW disc set on the CD-R/RW drive to the internal hard disk. In addition, you can import track data on a CD-DA disc (including a commercially available audio CD). See the "Using the CD-R/RW drive" supplement for details.

- **Capability of digital copy to an external digital device**

The MR16 provides the [DIGITAL OUT] port (Toslink optical) which outputs S/P DIF digital signals. By connecting an external DAT or MD to this port, you can copy song data digitally (see page 43 for details).

- **Synchronization to MIDI**

The MR16 provides the [MIDI OUT] port (DIN 5-pin). You can synchronize the MR16 with external MIDI devices (MIDI sequencer, etc.) using MTC or MIDI clock fed from the MR16 (see page 99 for details).

- **Rhythm guide function for recording**

The MR16 provides the rhythm guide function which is useful for recording. You can hear the rhythm guide sound according to the signature/tempo or the conductor map you set (see page 89 for details).

- **Phantom power supply**

You can supply the phantom power to the balanced XLR connector on Input A through Input D, allowing direct connection of a condenser microphone. You can select on or off of the phantom power (see page 144 for details).

- **"2 MIX" file playback mode**

The MR16 can play back a stereo WAV file which is necessary for creating an audio CD, as well as can set CUE points for dividing into tracks. See the "Using the CD-R/RW drive" supplement for details.

- **TO STEREO BUSS function**

During mixdown or track bouncing, you can add signals from Inputs A through D to the mixed track signals.

- **Two pairs of AUX OUT jacks**

The MR16 provides two pairs of AUX OUT jacks for applying an external effect to the selected track(s) or sending out the rhythm guide signal, allowing the MR16 to be used in various situations. See page 149 for details.

The basics of the MR16

This section describes the basics of the MR16 you should know before using the MR16.

Recording method

The MR16 is fitted with a 3.5-inch hard disk drive. Songs are recorded on a hard disk along with the ABS time (from 00m 00s 000ms to 399m 59s 999ms).

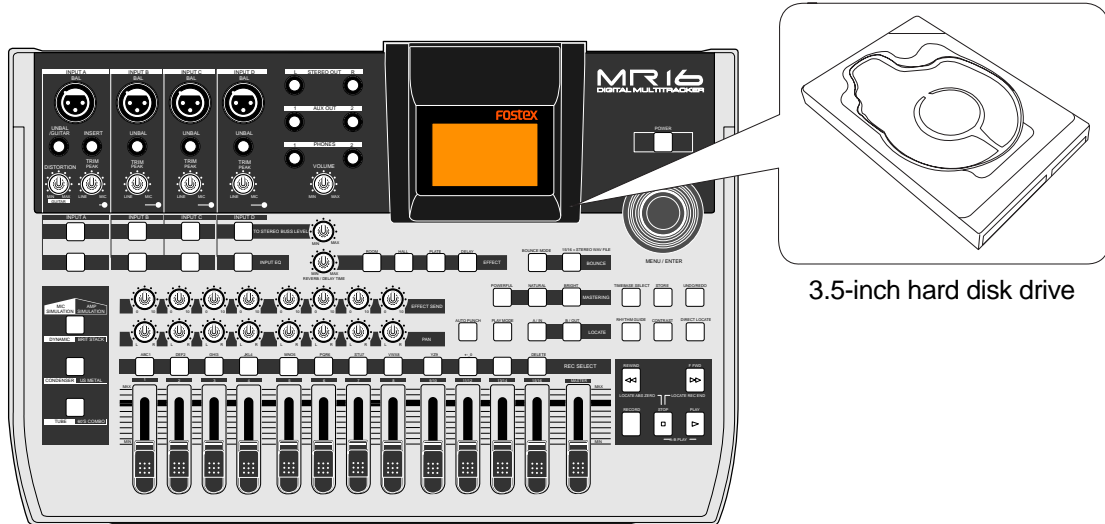

The ABS time shows the absolute time on a hard disk and you can start recording from any desired time within the range between 00m 00s 000ms and 399m 59s 999ms ABS time.

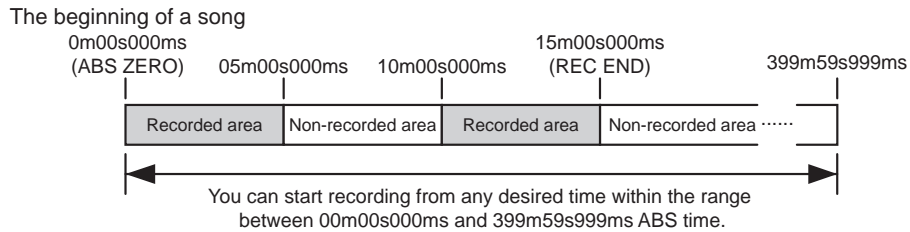

As the MR16 does not consume the disk space when no audio is recorded, you can record audio effectively, while the recordable time for a tape recorder depends on the tape length.

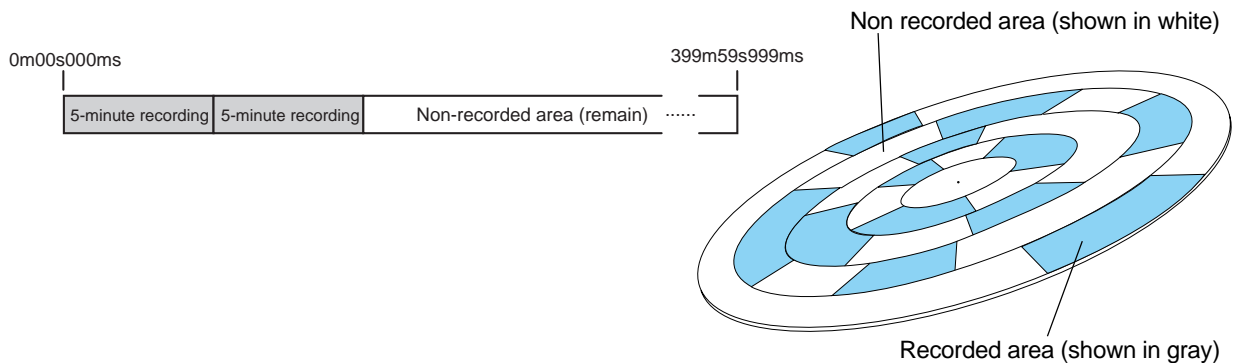

About song

To understand songs, imagine separated rooms as shown below. Each room can be regarded as a song. With the MR16, you can create up to 99 rooms (songs) on the hard disk (although the available space may limit the number of songs).

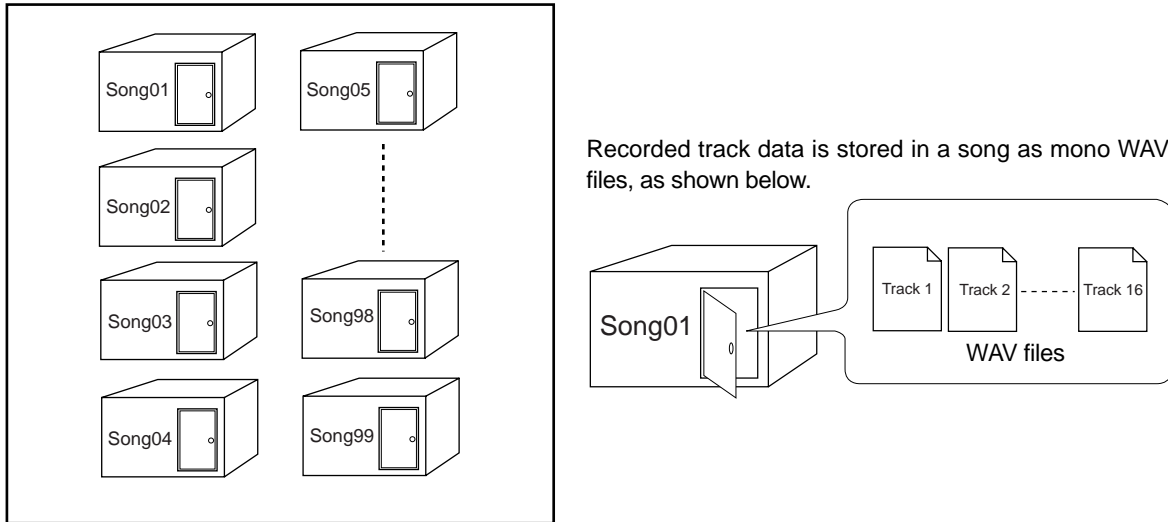

Each song is independent on a disk and you can record, play back or edit a song without affecting other songs. You can give a desired song name for managing recorded songs (see page **).

Recorded track data is stored in a song as mono WAV files.

The MR16 can convert the two WAV files recorded on tracks 15 and 16 (L and R) to a stereo WAV file (see page 90).

You can burn the converted stereo WAV file to an audio CD. To do this, export the file to your PC and burn it using a music software application (see page 104), or burn the file to the internal CD-R/RW drive (if it is provided to your MR16) or to an external CD-R/RW drive connected to the MR16.

Remain (recordable space left on the disk)

"Remain" shows how much time you can further record audio data to the available space left on the internal hard disk.

As described earlier, the MR16 stripes ABS time from 0m 00s 000ms to 399m 59s 999ms at maximum for each song. However, the remaining time (= available recording time left) depends on the available space on the hard disk in actual use. The remaining time is shown as in the screen example below during recording or record standby. Note that it shows the remaining time for recording onto a mono track.

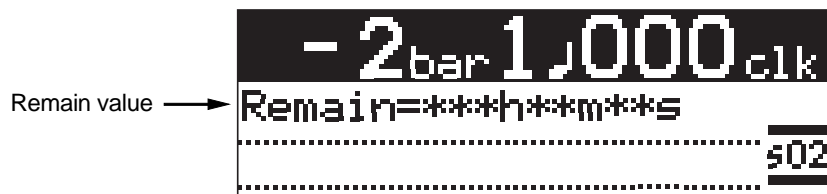

A "mono" track means a single track. Therefore, you can calculate the remaining time for recording to more than one track by dividing the displayed time by the number of tracks. Note that the remaining time shown on the screen is an approximate time.

Time base

The term, "**time base**", is used as the reference of recorder position information. Using the [TIME BASE SELECT] key, you can select from among two time base modes: ABS time and bar/beat mode. Each screen example below shows the recorder is located at the beginning of a song in each time base mode.



<ABS time mode>



<Bar/beat mode>

ABS time mode:

ABS time stands for Absolute time, which is "**striped**" on the disk when creating a song. It starts from 0m 00s 000ms (=ABS zero, the beginning of a song) and ends by 399m 59s 999ms at maximum.

Bar/beat mode:

The bar/beat/clock information is created according to the internal tempo map. The ABS zero position is set to "**bar -2/beat 1/clock 000**" by default (this is called "bar offset"). The MR16 determines the bar/beat/clock value in a song in referenced to the bar offset, as well as the time signature map and tempo map. You can set the bar offset between bar 1 to bar -8 via the menu mode (see page 95). The figure below shows the relation between two time base modes.

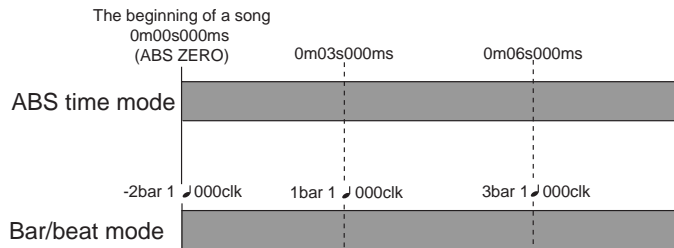

Input monitor and repro monitor

Each of the MR16 tracks has two output modes: repro monitor and input monitor. In the repro monitor mode, the track playback signal is output. So if you want to listen to the track playback sound, select the repro monitor mode. In the input monitor mode, the input signal fed to the track is output. So you can check the level of the input signal to be recorded.

To enter a MR16 track to input monitor mode, press the appropriate [REC SELECT] key to arm the track (i.e. make the track record-ready), then press only the [RECORD] key to enter the "RECORD READY" mode or press both the [RECORD] and [PLAY] keys simultaneously to start recording.

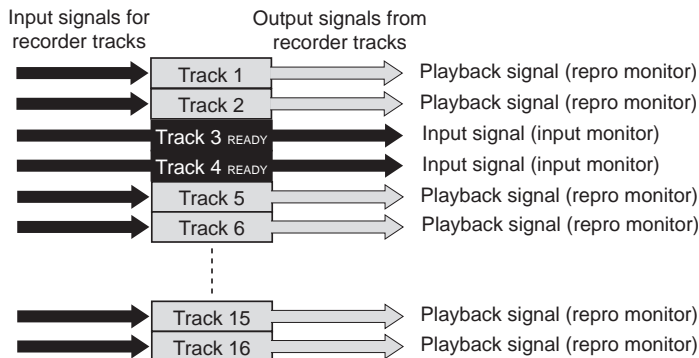

[TRIM] control

You must pay great attention to the [TRIM] control adjustment when recording to the MR16.

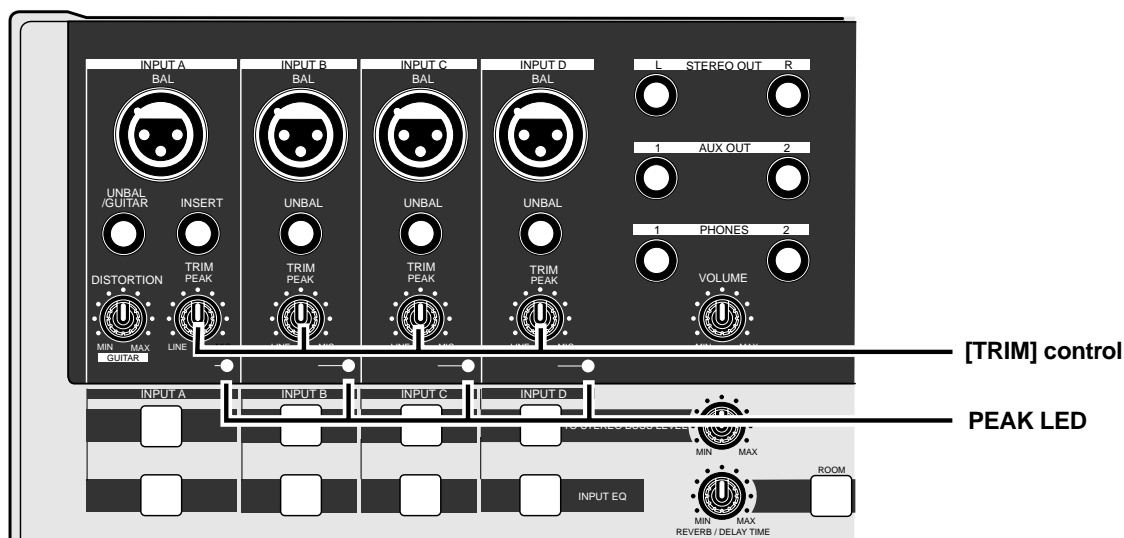

The analog signal received at each input ([INPUT A] through [INPUT D]) is sent to the [TRIM] control, by which the signal level fed to the A/D converter of the MR16 is controlled.

You can check this level by the PEAK indicator. If the level is too high, the PEAK indicator lights, while you may hear the sound distorted or noisy. This distortion (noise) generated at this stage cannot be eliminated, therefore, adjust the TRIM control properly so that the PEAK indicator does not light at the loudest part of the input signal.

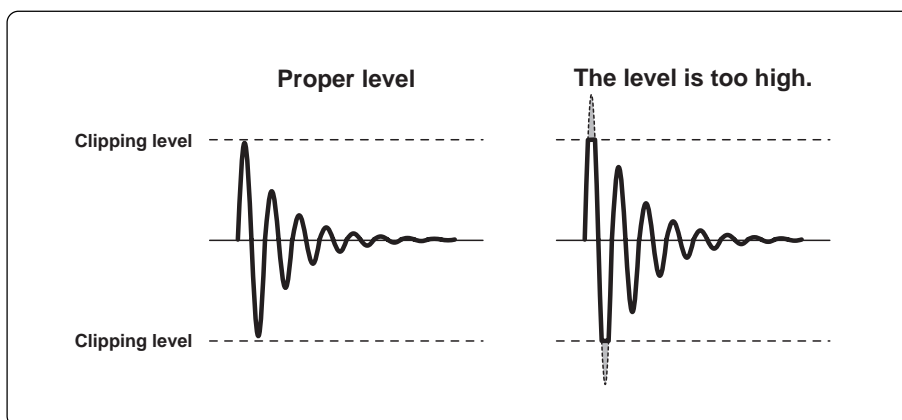

How to burn an audio CD

You can burn an audio CD from songs created by the MR16 multitrack recording function using either of the following methods.

- (1) Burns a CD using the internal CD-R/RW drive (the CD-R/RW drive built-in model only)
- (2) Burns a CD using an external CD-R/RW drive
- (3) Burns a CD using the CD-R function of a PC

Regardless of the burning methods above, you must carry out the following preparation for burning an audio CD.

- | | |
|----------|--|
| 1 | <p>Mix down recorded track signals and bounce to tracks 15/16.</p> <p>There are two methods for bouncing tracks to tracks 15/16. One is to bounce to tracks 15/16 of the same song, while the other is to bounce to tracks 15/16 of the New song. See pages 75 through 88 for details about track bouncing.</p> |
| 2 | <p>Convert the song data bounced to tracks 15/16 to a stereo WAV file.</p> <p>A converted stereo WAV file is stored to the "2MIX" folder in the song. When you create an audio CD, this WAV file is recorded to a CD-R/RW disc. See page 104 for details about WAV file conversion.</p> |

In short, after preparing the stereo WAV file(s) to be burned, you can burn the file(s) to a CD-R/RW using either of three burning methods.

- **Burning a CD using the internal CD-R/RW drive (the CD-R/RW drive built-in model only)**

 - (1) Use the "CD-RW" menu of the menu mode to burn an audio CD. See the "Using the CD-R/RW drive" supplement for details.
- **Burning a CD using an external CD-R/RW drive**

 - (1) Connect an external CD-R/RW drive to the [USB HOST] port on the rear panel.
 - (2) Use the "USB HOST" menu of the menu mode to burn an audio CD. See the "Using the CD-R/RW drive" supplement for details.
- **Burning a CD using the CD-R function of a PC**

 - (1) Connect a PC to the [USB] port on the rear panel.
 - (2) Use the [USB] menu of the menu mode to make USB connection enabled.
 - (3) **Start up WAV Manager supplied by Fostex on your PC.**
You can download WAV Manager from the Fostex web site. Access our web site or ask your local Fostex dealer.
 - (4) **Use the "CD Writer" function of WAV Manager to burn an audio CD using the CD-R/RW drive connected to your PC.**
See page 107 for details about how to connect a PC. See the PDF manual included in the downloaded file of WAV Manager.

Names and functions

This chapter describes the names and functions of the controls, keys, connectors, etc. on the MR16 top panel, side panel and rear panel, as well as details of the display. See this chapter whenever you want to know the function of a control, key, etc.

Top panel 1

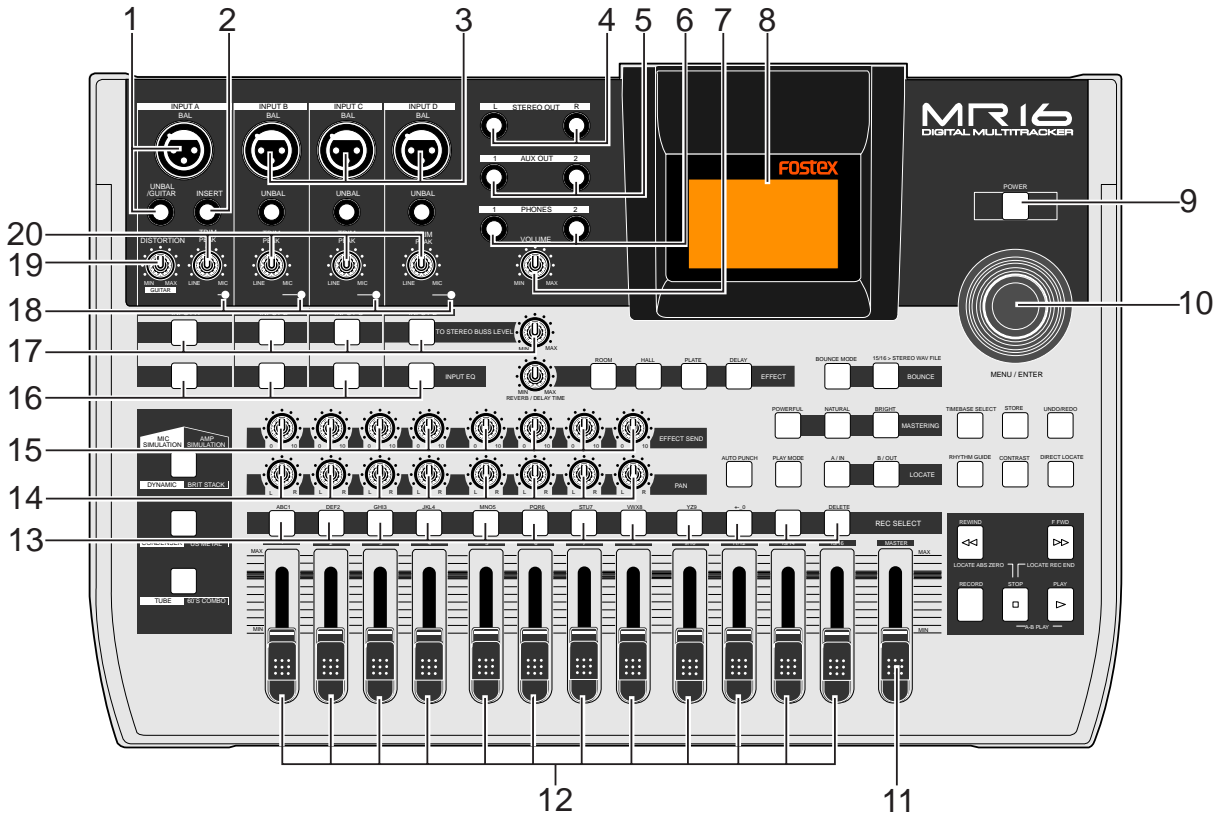

1. [INPUT A] input connectors (XLR connector and phone jack)

Both the [BAL] XLR connector and [UNBAL/GUITAR] phone jack are provided. You can connect a guitar, microphone, keyboard, etc. If you connect sources to both the XLR connector and phone jack, the phone input takes priority. When using the [INPUT A] section, select the [INPUT A SELECT] switch on the rear panel appropriately according to your usage (see page 35).

2. [INSERT] connector (TRS phone jack)

Connects an external effect processor (typically, a compressor/limiter, etc.). For connection between the MR16 and the effect processor, use a Y-cable as shown below (see page 69).

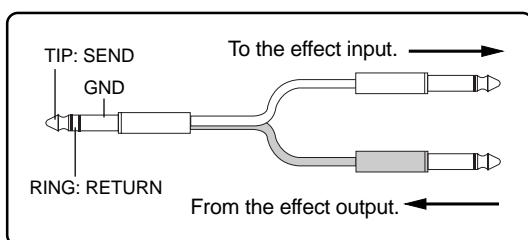

3. [INPUT B, C, D] input connectors (XLR connector and phone jack)

You can connect a microphone, keyboard, etc. to each of the [INPUT B], [INPUT C] and [INPUT D] inputs.

Both the [BAL] XLR connector and [UNBAL] phone jack are provided for each input so you can use the appropriate connector according to the sound source.

If you connect sources to both the XLR connector and phone jack on the same input, the phone input takes priority (see page 35).

4. [STEREO OUT] jacks (L, R)

These jacks output the stereo (L and R) buss signals. Connect these jacks to the monitoring equipment or master recorder (see pages 31 and 44).

5. [AUX OUT] jacks (1, 2)

These jacks can output the playback signal of any of tracks 1 through 16, the effect send buss signal or the internal click (see page 150). You can select the output signal of each AUX OUT independently using the "System" menu of the menu mode (see page 146 for details).

- 6. [PHONES] jacks (1, 2)**
Two jacks (1 and 2) are provided. You can use two pairs of stereo headphones with the MR16 (see page 31).
- 7. [PHONES VOL] control**
Adjusts the headphone output level.
- 8. LCD display**
This 132 x 64 dot LCD display shows various information (see page 26).
- 9. [POWER] switch**
Turn on or off the power of the unit (see page 30). To turn off the power when the power is on, press and hold down the [POWER] switch for a few seconds.
- <Note>: If you do not use the MR16 for a long time, we recommend unplugging the power cord from the AC outlet.*
- 10. [MENU/ENTER] rotary / push knob**
Pressing this knob enters the menu mode (see page 28).
In the menu mode, rotating this knob selects the item or numeric value, while pressing this knob confirm the setting/selection.
- 11. [MASTER] fader**
Adjusts the stereo (L and R) buss output level (see pages 37 through 45).
- 12. Track faders**
Each fader adjusts the track playback level. Each of track faders 9/10, 11/12, 13/14 and 15/16 controls the stereo signal (see pages 37 through 45).
- 13. [REC SELECT] keys**
Used to select the recording track(s). You can record onto up to four tracks simultaneously. Pressing a key arms or unarms the corresponding track(s).

Tracks 9/10, 11/12, 13/14 or 15/16 are armed or unarmed simultaneously (see pages 36).
In the menu mode, these keys are used for entering or deleting characters .
- 14. [PAN] controls**
Control panning for tracks 1 through 8.
- 15. [EFFECT SEND] controls**
Control the amount of signals from tracks 1 through 8 sent to the internal effect (reverb or delay) (see page 72).
- 16. [INPUT EQ] keys**
Each key selects whether or not applying the internal input EQ to the corresponding input signal.
Each press of the key alternates ON and OFF of the EQ (see page 66).
You can select a desired EQ setting from among 33 EQ presets available in the EQ library (see page 67).

A long press of the key enters the menu mode for selecting the desired EQ library entry (see page 66).
- 17. [TO STEREO BUSS] keys
[TO STEREO BUSS LEVEL] control**
Each of the [TO STEREO BUSS] key selects whether or not sending the corresponding input signal to the stereo L/R busses (see page 85). Each press of the key alternates ON and OFF. When ON, the key illuminates in green. When OFF, it is unlit. When the corresponding input is assigned to a recording track, the key flashes in green.
A long press of the key enters the input menu of the MENU mode, in which you can set phantom power on/off, panning, etc. (see pages 86 and 144).
The [TO STEREO BUSS LEVEL] control adjusts the level of the signal sent to the stereo L/R buss.
- 18. [PEAK] indicators**
Each indicator lights when the input signal is overloaded (see page 16). You should adjust the input gain using the [TRIM] control so that the [PEAK] indicator does not light.
- 19. [DISTORTION] control**
Controls the amount of the distortion effect for a guitar connected to the [XLR] connector or [UNBAL/GUITAR] jack (phone type) on the [INPUT A] channel.
This control is effective only when the [INPUT A SELECT] switch is set to "GTR/DIST" (see pages 35 and 68).
- 20. [TRIM] controls**
Each control adjusts the input gain of the corresponding input channel (see page 16, and 37 through 42).

Top panel 2

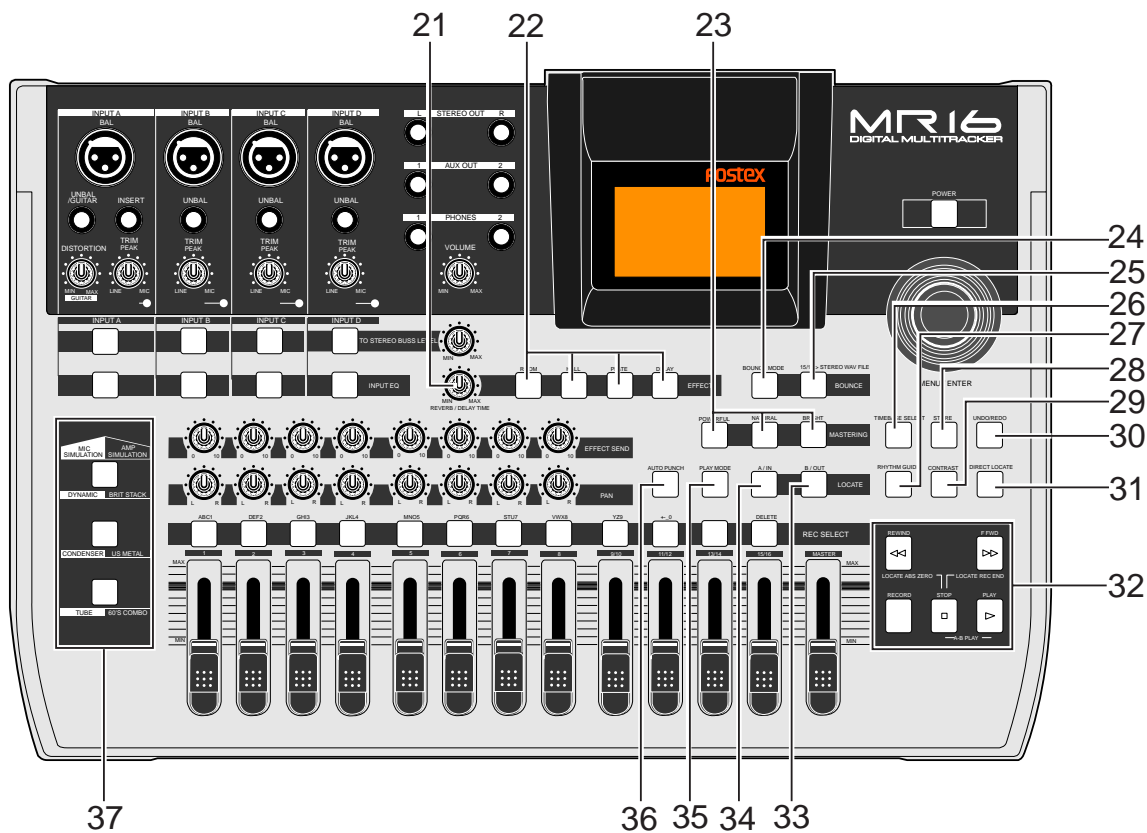

- 21. [REVERB/DELAY TIME] control**
 This control adjusts the reverb time or delay time. When you select "ROOM", "HALL" or "PLATE" for the effect type, it adjusts the reverb time. When you select "DELAY", it adjusts the delay time (See page 71).
- 22. [EFFECT] keys
 (ROOM / HALL / PLATE / DELAY)**
 These keys are used to select the effect type. You can select from three reverb types (ROOM, HALL and PLATE) and a delay (DELAY). The selected key is lit (see page 70).
- 23. [MASTERING] keys
 (POWERFUL / NATURAL / BRIGHT)**
 Used to select the desired mastering effect during track bounce or mixdown. You can select from three effect types by pressing an appropriate key (see page 74).
- 24. [BOUNCE MODE] key**
 Used to select the bounce mode. Each press of the key switches the bounce mode (see page 78).
- 25. [15/16 > STEREO WAV FILE] key**
 This key is used when converting a mono WAV file recorded on tracks 15/16 to a stereo WAV file (see page 104). A converted stereo WAV file can be exported to a USB-connected personal computer (see page 107), or can be burned to an audio CD using the internal CD-R/RW drive or an external CD-R/RW drive (see the supplementary manual "How to use the CD-R/RW drive").
- 26. [TIME BASE SEL] key**
 Selects the time base shown on the display (see page 15). Each press of the key switch between "time" and "bar/beat".
- 27. [RHYTHM GUIDE] key**
 Switches on/off of the rhythm guide function (see page 90). Each press of the switch alternates on and off. A long press of the key enters the rhythm guide menu, in which you can set the rhythm guide parameters (see page 91).

28. [STORE] key

Stores the current recorder position (time data) as the LOCATE A/IN or LOCATE B/OUT point (see page 53).

In the "2-mix file playback" mode, pressing this key sets a CUE point to the current stereo WAV file (see the supplementary manual "How to use the CD-R/RW drive").

29. [CONTRAST] key

By rotating the [MENU/ENTER] knob while holding down this key, you can adjust the display contrast (see page 27).

30. [UNDO/REDO] key

Used to undo or redo recording or editing (see pages 38, 40, 42, 119 and 127).

Each press of the key alternates "undo" and "redo".

31. [DIRECT LOCATE] key

Each press of this key alternates ON and OFF of the direct locate mode (see page 55).

32. Transport keys**[PLAY] key**

Starts playback of the recorder.

Pressing this key while holding down the [RECORD] key starts recording of the armed (record-ready) track(s).

Pressing this key during recording exits recording.

Pressing this key in the direct locate mode executes the preview playback for a few seconds after the locate point (see page 58).

[STOP] key

Stops the recorder.

By pressing the [PLAY], [REWIND] or [F FWD] key while holding down the [STOP] key, you can locate to a specific point or repeat playback as below.

- **[STOP] + [PLAY] (A-B PLAY)**

Repeats playback between the LOCATE A and LOCATE B points (see page 48).

- **[STOP] + [REWIND] (LOCATE ABS ZERO)**

Locates to the beginning (ABS ZERO) of the current song (see page 52).

- **[STOP] + [F FWD] (LOCATE REC END)**

Locates to the recording end of the current song (REC END) (see page 52).

[RECORD] key

Pressing the [PLAY] key while holding down the [RECORD] key starts recording of the armed (record-ready) track(s).

By pressing only the [RECORD] key when any track(s) is armed (in record-ready), the input signal(s) of the armed track(s) can be monitored (i.e. input monitor mode). (see pages 37 through 42).

Pressing this key in the direct locate mode executes the preview playback for a few seconds before the locate point (see page 58).

[F FWD] key

Pressing this key fast forwards the recorder. During playback, pressing this key starts 3 x cueing (see page 48).

While holding down the [STOP] key, pressing this key locates to the recording end of the current song (REC END) (see page 52).

[REWIND] key

Pressing this key rewinds the recorder.

During playback, pressing this key starts 3 x reverse cueing (see page 48).

While holding down the [STOP] key, pressing this key locates to the beginning (ABS ZERO) of the current song (see page 52).

This key is also used to go up the menu screen layer while a menu screen is displayed.

33. [LOCATE B/OUT] key

Pressing this key while holding down the [STORE] key sets the LOCATE B point (or punch out point) (see pages 53 and 62).

34. [LOCATE A/IN] key

Pressing this key while holding down the [STORE] key sets the LOCATE A point (or punch in point) (see pages 53 and 62).

35. [PLAY MODE] key

Selects a play mode. You can select from among normal, auto play, auto return and loop (see page 49).

36. [AUTO PUNCH] key

Turns on or off the auto punch mode (see page 63).

37. Insert effect selection keys

Used to select the insert effect (mic simulation or amp simulation) for the signal from the [INPUT A] jack.

When setting the [INPUT A SELECT] switch on the rear panel to "MIC/LINE", you can use the mic simulation effect. When setting the switch to "GTR/DIST", you can use the guitar amp simulation effect (see page 68).

Rear panel

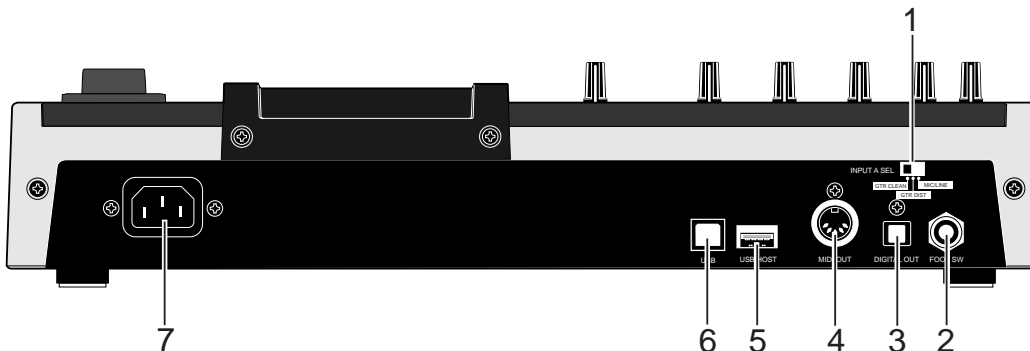

1. [INPUT A SELECT] switch

This switch must be set appropriately according to the input source of the [INPUT A] channel (see page 35).

MIC/LINE	Either of the [BAL] XLR and [UNBAL/GUITAR] phone connectors can be used. Set the switch to this position when the source is an external microphone or line level source.
GTR DIST	Either of the [BAL] XLR and [UNBAL/GUITAR] phone connectors can be used. You can adjust the input level and distortion using the [TRIM] and [DISTORTION] controls respectively. You can also use the amp simulation insert effect.
GTR CLEAN	Either of the [BAL] XLR and [UNBAL/GUITAR] phone connectors can be used. You can adjust the input level using the [TRIM] control. You can also use the amp simulation insert effect.

2. [FOOT SW] jack (TRS phone jack)

Used to connect with an unlatched-type footswitch (see page 61).

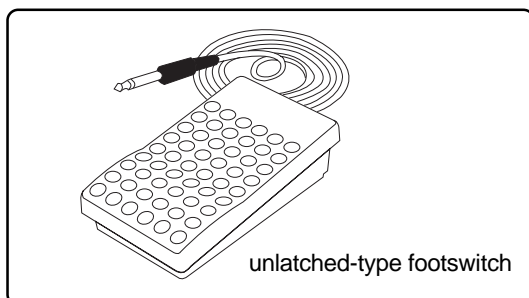

3. [DIGITAL OUT] connector (Toslink optical connector)

Used to connect with an external digital device using an optical cable (see page 45).

<Note>: The dust protection cap is inserted to the [DIGITAL OUT] connector when the unit is shipped. Remove the cap when you use this connector. If you do not use this connector, attach the dust protection cap.

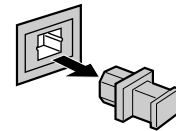

If you need to connect the unit to a digital device which only provides a coaxial type digital connector (typically, an RCA pin jack), use the Fostex COP-1/96k coaxial-optical converter (shown right).



Model COP-1/96k

Use an optical digital cable with Toslink plugs on both ends.



4. [MIDI OUT] jack (DIN 5-pin connector)

Used to connect to a MIDI IN jack of an external MIDI device (such as a MIDI sequencer) (see pages 100 and 102).

5. [USB HOST] connector (USB A type)

Used to connect to an external CD-R/RW drive for creating an audio CD (CD-DA). See the supplementary manual "How to use the CD-R/RW drive" for details.

<Caution>: Do not connect your personal computer to the [USB HOST] port.

6. [USB] port (USB B type)

Used to connect with a personal computer using a standard USB cable for song file data transfer between the MR16 and the personal computer (see page 107).

7. [AC IN] connector

Connect the supplied power cord to this connector (see page 30).

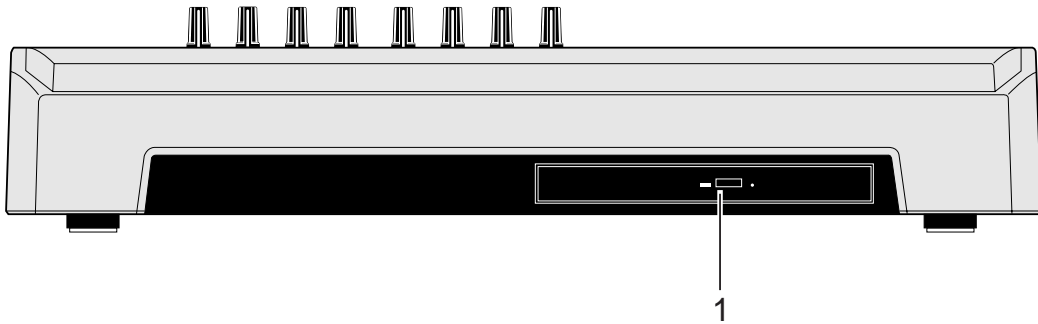
Front panel (CD-R/RW drive built-in model only)**1. Internal CD-R/RW drive**

Used to create an original audio CD by burning converted stereo WAV files to a CD-R/RW disc, or used to record a single mono WAV file converted from track data on the HDD to a CD-R/RW disc (see the supplementary manual "How to use the CD-R/RW drive" for details).

<Caution>: Although you can see the DVD-ROM logo on the front of the CD-R/RW drive tray, it does not support DVD ROM discs. Only CD-R/RW discs can be used.

LCD display

The following describes details about the LCD display, including screen contents and operation.

Home screen

When turning on the MR16, the display shows the startup screen (showing the startup status of the MR16), followed by the "Home" screen, which is similar to the one below. In this condition, the previously loaded song is loaded and the recorder is located at the beginning of the song. The home screen provides the following information.

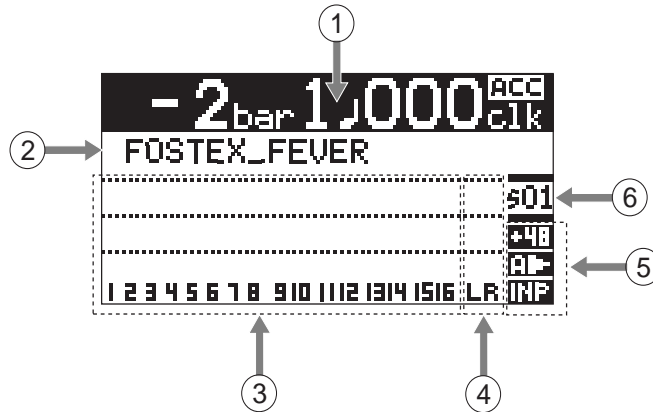

1. Time counter display

Time information of the current recorder position is shown in ABS or bar/beat mode (by default, bar/beat). Using the [TIME BASE SELECT] key, you can select a desired time base mode. When the recorder is moving (playing back, fast forwarding, etc.), the appropriate icon is also shown. While the hard disk drive is in access, "ACC" lights up.

2. Character display

Normally, the name of the song currently loaded is shown (up 22 characters can be shown at a time).

It also shows following information.

- A name of the operation mode currently being executed (such as BOUNCE 1-8->9/10).
- A (not-so-serious) warning message
- The "Remain" time when at least one track is record-armed (i.e. At least one of the [REC SELECT] keys is active).



The remain time shows how much time you can further record audio data onto a mono track using the available space left on the hard disk.

3. Track level display

The recording or playback levels of tracks 1 through 16 are shown. When a track is record armed, the track number indication changes to the source input channel (any of A, B, C and D).

4. Stereo buss (L and R) level display

During recording or playback, the output levels of the L/R stereo buss are shown.

5. Song status display

Lights up the following status icons when the appropriate modes (functions) are active.

	At least one of the tracks is in the input monitor mode (see pages 38, 40 and 42).
	The auto return mode is active (see page 49).
	The loop mode is active (see page 49).
	The auto play mode is active (see page 49).
	The +48V phantom power is being supplied (see page 144).

6. Song number display

Shows the song number of the song currently loaded.

Selecting a time base mode

When the display shows the home screen, pressing the [TIME BASE SELECT] key switches the time base mode between ABS and bar/beat.

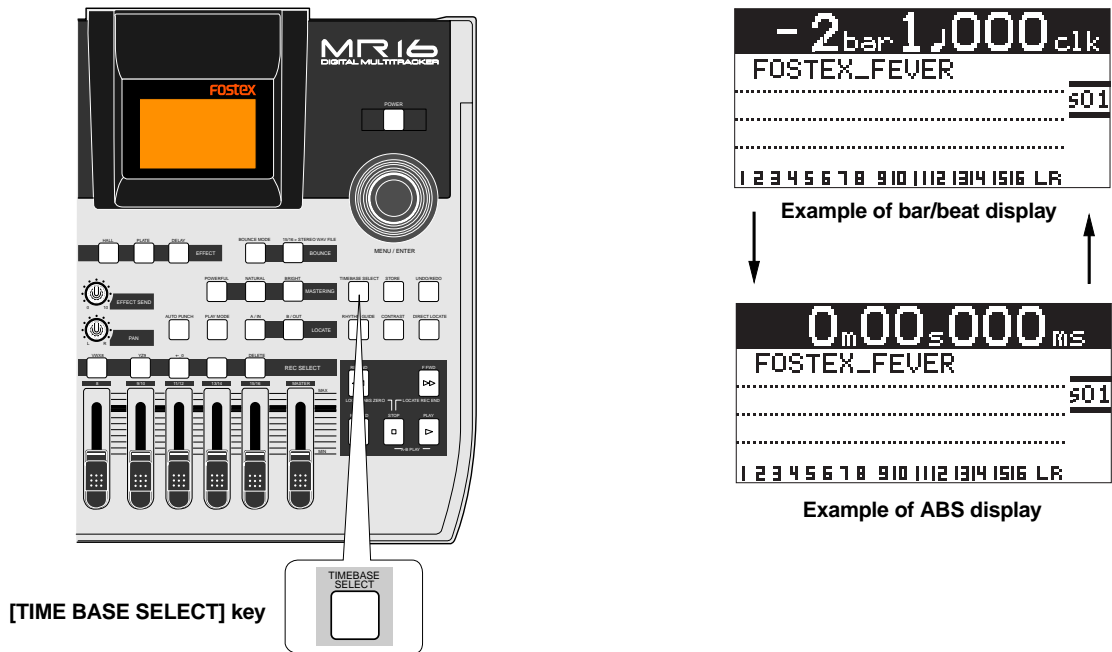

Adjusting the display contrast

You can adjust the display contrast by rotating the [MENU/ENTER] knob while holding down the [CONTRAST] key. Rotating the dial clockwise heightens the contrast, while rotating it counterclockwise lowers the contrast.

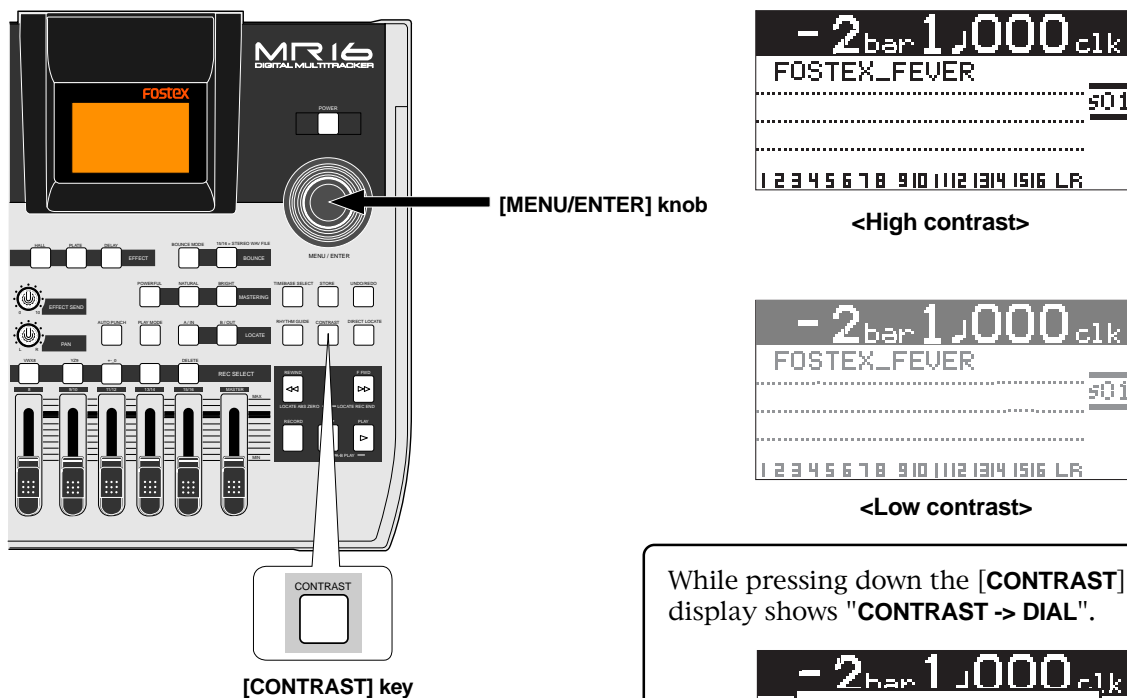

While pressing down the [CONTRAST] key, the display shows "CONTRAST -> DIAL".

The diagram shows the display with a box around the text 'CONTRAST -> DIAL'. The rest of the display shows '- 2 bar 1,000 clk' at the top, 'FOSTEX_FEVER' in the middle, and 's01' at the bottom right. The numeric keypad is at the bottom.

MENU mode screen

Pressing the [MENU/ENTER] knob while the recorder is stopped enters the menu mode and brings up the menu screen. In the menu mode, you can make setting or editing via the appropriate screen. The top menu screen has two pages, in which you can select the desired menu by rotating the [MENU/ENTER] knob.

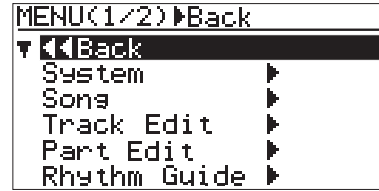
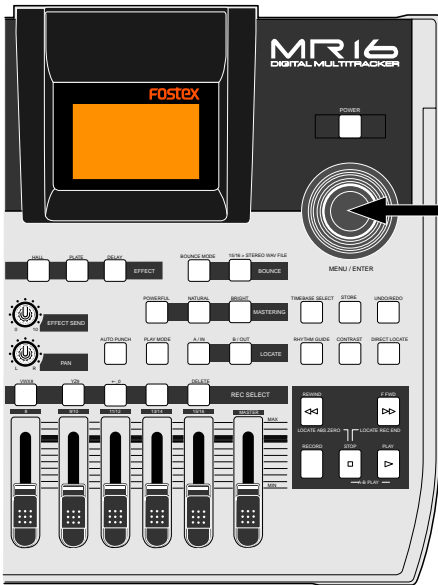

<First page>

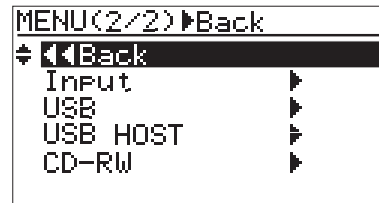

<Second page>

Warning message

If a serious problem happens to the MR16 during operation, an appropriate warning message is shown on the display. Most warning messages are being shown until the [MENU/ENTER] knob is pressed. Note that there are also not-so-serious warning messages besides the following.

This message is shown when you are going to delete a song which is protected.

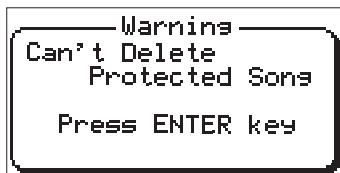

During recording, this message is shown if there is no more space left on the hard disk for recording.

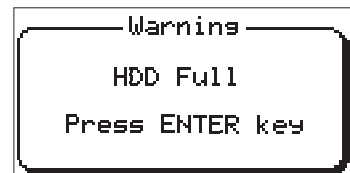

This message is shown when the hard disk drive has a problem.

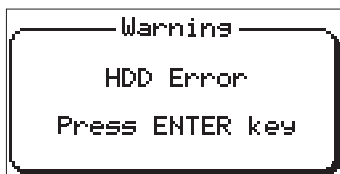

This message is shown when you are going to make recording or editing to a song which is protected.

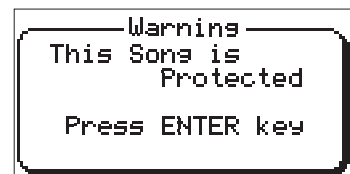

This message is shown when you are going to edit a track or part but there is not enough space on the hard disk for executing the undo function.

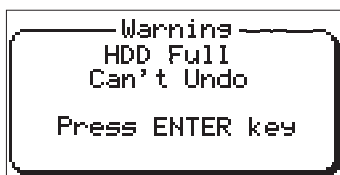

This message is shown when you are going to create a new song while 99 songs exist on the hard disk.

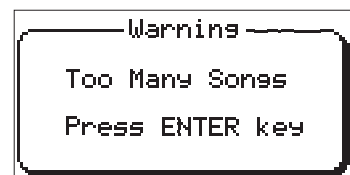

Basic operations

This chapter describes power connection, power on/off, demo song playback, etc., as well as basic multitrack recording.

If it is the first time for you to use a Multitracker, read this chapter carefully first so that you are familiar with the MR16 basic operations, then read other sections which describe advanced operations.

About power

The MR16 operates by AC power. Before you start using the MR16, you must connect the supplied power cord.

Power connection

Connect between the [AC IN] connector on the MR16 rear panel and an AC outlet using the supplied power cord.

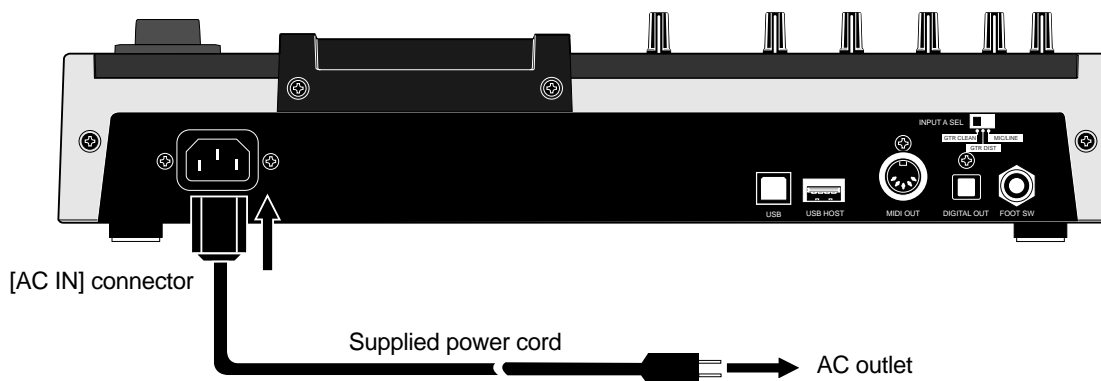

<Note>: When you do not operate the MR16 for a long period of time, we recommend disconnecting the power cord.

Turning on the unit

You can turn on or off the MR16 power using the [POWER] switch (pointed by an arrow below). To turn off the power, press and hold down the [POWER] switch for a few seconds.

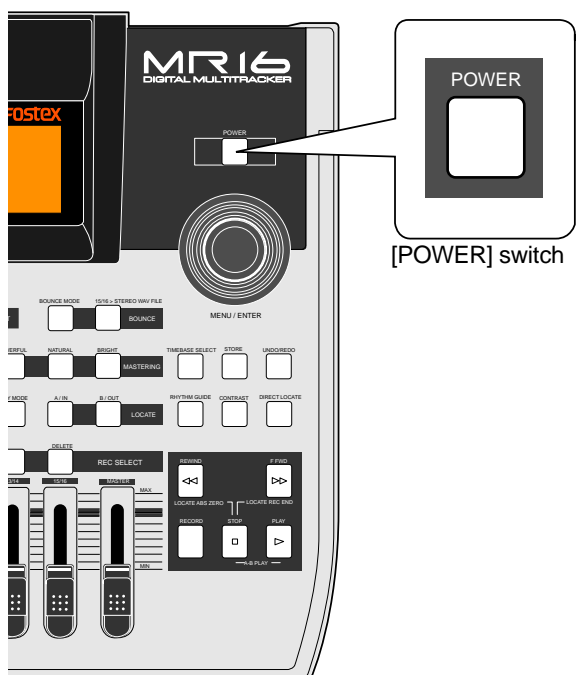

When you press the [POWER] switch to turn on the power for the first time, the MR16 starts up and the display shows the screen as below (note that it takes some time until the screen as below is shown). This screen shows that the demo song is loaded and stopped at the beginning (ABS 0) of the song named "FOSTEX_FEVER".



Follow the procedure described on the next page to play back the demo song.

Listening the demo song

A demo song is pre-recorded on the hard disk of the MR16 when shipped. Before you make recording, let's listen to the demo song via headphones (or a monitor speaker).

Connecting headphones (or a monitor speaker system)

Connect headphones to either of the two [PHONES] jacks of the MR16. Both jacks feed the same signal so you may connect headphones whichever you like.

If you have a powered monitor speaker, you may connect it to the [STEREO OUT] L or R jacks of the MR16.



<Note>: You can plug a 1/4" phone plug to the [STEREO OUT] L or R jack.



<Note>: When you connect a powered monitor speaker to the unit, turn down the volume of the powered monitor speaker to minimum before you turn on the MR16 and the powered monitor speaker.

Playing back the demo song

In the demo song, approximately 1-minute audio is recorded on all eight tracks. Follow the procedure below for listening to the demo song. In the following procedure, it is assumed that the MR16 is turned on and a pair of headphones (or a monitor speaker system) is connected.

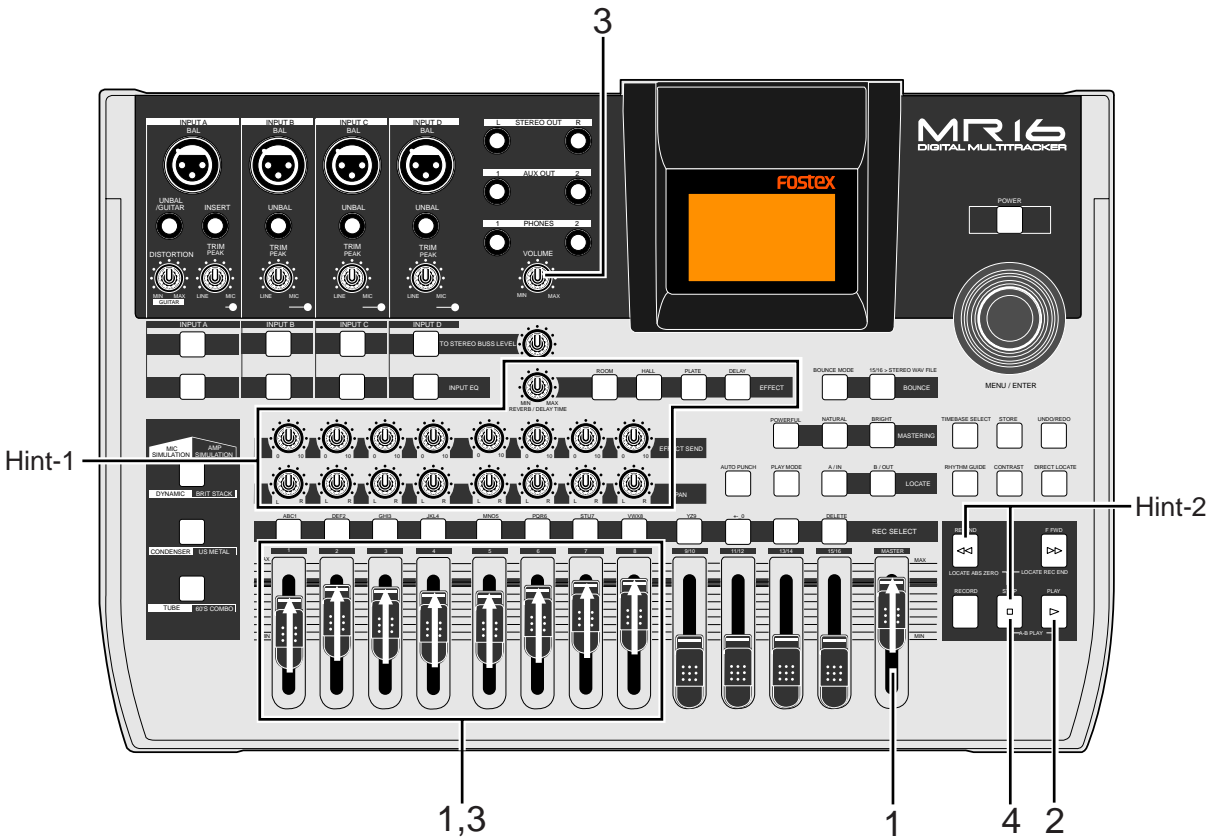

- 1) **Raise the [MASTER] fader to the "≡" position. Set the track faders at the lowest position.**
- 2) **Press the [PLAY] key to start playback.**
- 3) **Raise the track faders (1 through 8) gradually to adjust the playback level and balance.**
Also raise the [PHONES VOL] control gradually to adjust the headphones level. (If you are using a powered monitor speaker for monitoring, adjust the level control of the powered speaker.)

<Hint-1>: While listening to the playback sound, adjust panning setting of tracks 1 through 8, as well as try to adjust the internal effects (reverb/delay) (see page 70).

- 4) **When the demo song ends, press the [STOP] key to stop the recorder.**

<Hint-2>: **To listen to the demo song again:**
When the recorder is stopped after listening to the demo song, press the [REWIND] key while holding down the [STOP] key. The recorder instantly moves back to the beginning of the demo song (see page 52). Then pressing the [PLAY] key starts playback from the beginning of the demo song.

<Note>: The demo song is protected and you cannot overwrite or erase it. Therefore, you cannot make recording in this condition. If you want to make new recording while keeping the demo tape on the hard disk, see "Creating a song for recording" on the next page. If you do not keep the demo song, carry out either of the following operations.

- (1) **Release the song protection (see page 117).**
Then, start recording (overwrite recording) from the beginning of the demo song, or delete the demo song from the hard disk (see page 116). If you delete the demo song, create a new song (see the next page) and make recording to the new song.
- (2) **Format the hard disk (see page 140) and make recording.**
Because a new song is automatically created after formatting the disk, you can start recording without the need of creating a new song manually.

Creating a song for recording

This section describes how to create a new song for recording on the hard disk, while keeping the demo song. In the following procedure, it is assumed that the MR16 is stopped at the beginning (ABS ZERO) of the demo song.

- 1) While the recorder is stopped, press the [MENU/ENTER] knob to enter the menu mode.

The display now shows the first page of the menu selection screen, where "◀◀ Back" is highlighted initially.

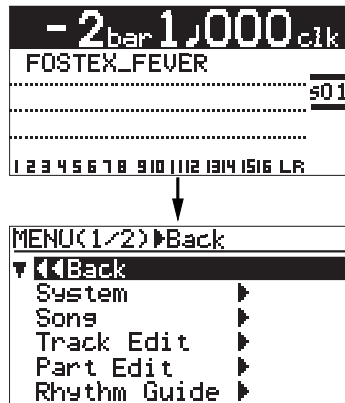

<Note>: By selecting "◀◀ Back" and pressing the [MENU/ENTER] knob, the display returns to the previous screen. You can also return the display to the previous screen by pressing the [REWIND] key.

- 2) Rotate the [MENU/ENTER] knob to select "Song ▶", and press the [MENU/ENTER] knob.

The display now shows the first page of the song menu screen, where "◀◀ Back" is highlighted initially.

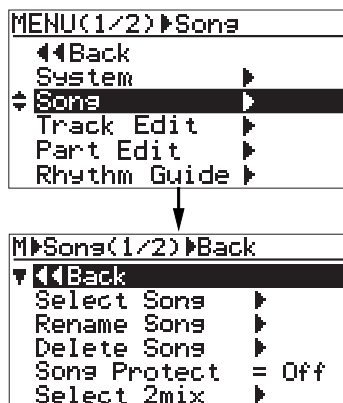

- 3) Rotate the [MENU/ENTER] knob to select "Select Song ▶", and press the [MENU/ENTER] knob.

The display now shows the first page of the song selection screen. You can see the list of the song numbers/names on the hard disk. Currently, only the demo song is created, and "S01: FOSTEX_FEVER" and "---:(New Song)" are shown.

"---:(New Song)" is used to create a new song.

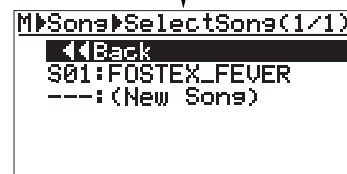
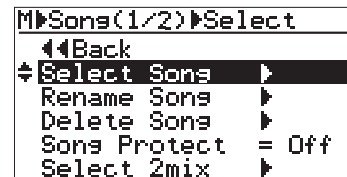

- 4) Rotate the [MENU/ENTER] knob to select "---:(New Song)", and press the [MENU/ENTER] knob.

The display now shows the screen for entering a new song name. The rightmost character on the default song name is flashing (in the example below, "2" of "Song02" starts flashing).

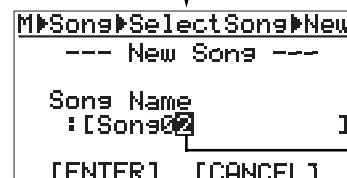
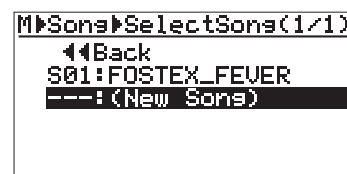

- 5) Enter the desired song name.

Use the character entry keys to enter the desired character at the flashing point. Rotate the [MENU/ENTER] knob to move the flashing point. Use the [DELETE] key to delete the character at the flashing point. Therefore, when the rightmost character is flashing as in the screen example above, you can delete all characters by pressing the [DELETE] key repeatedly. You can enter up to 16 characters for a song name.

See <How to enter characters> on the next page for entering the song name as "My_Song".

<Note>: You may leave the default song name as it is. Also, you can edit the song name after creating a song using the "Rename Song" menu item in the song menu of the menu mode (see page 115).

<How to enter characters>

<Character entry keys>

[REC SELECT] keys on the MR16 top panel act as character entry keys in the menu mode.

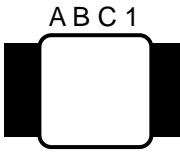

For example, the [REC SELECT] key for track 1 (shown on the left) can be used for entering A, B, C, a, b, c and 1.

<Character entry example>

The following procedure example shows how to enter "My_Song" as a song name.

1. Use the [M N O 5] key to enter "M".
2. Use the [Y Z 9] key to enter "y".
3. Use the [+ _ 0] key to enter "_".
4. Use the [S T U 7] key to enter "S".
5. Use the [M N O 5] key to enter "o".
6. Rotate the [MENU/ENTER] knob to move the cursor right.
7. Use the [M N O 5] key to enter "n".
8. Use the [G H I 3] key to enter "g".

<Notes on cursor movement>

Pressing a different character entry key automatically moves the cursor right.

If two successive characters are assigned to the same character entry key, rotate the [MENU/ENTER] knob after selecting the first character to move the cursor right.

- 6) **After completing song name entry, press the [MENU/ENTER] knob.**

The cursor moves to "[ENTER]" at the bottom of the screen.

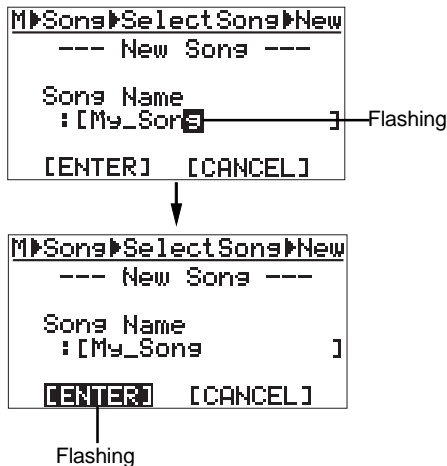

<Note>: If you want to cancel creating a song, rotate the [MENU/ENTER] knob to move the cursor to "[CANCEL]" and press the [MENU/ENTER] knob.

- 7) **While "[ENTER]" is flashing, press the [MENU/ENTER] knob.**

The display now shows the home screen of the newly created song (My_Song).

As shown in the lower screen example, the song name (My_Song) and the song number (Song02) are shown.

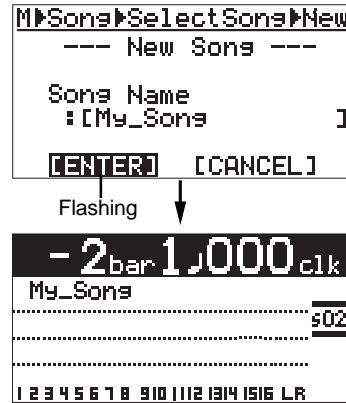

Now, in addition to the demo song, a new song on which no audio is recorded is created by the procedure above.

It is a good idea to create more than one song before you start recording.

After creating a song or songs for recording, connect the sound source to the MR16 (see the next page) and start recording.

<Note>: After creating a new song, by executing procedure steps 1 through 3, the following song selection screen appears.

This screen is used for loading the desired song from the list, as well as creating a new song.

For example, by rotating the [MENU/ENTER] knob to highlight "S01: FOSTEX_FEVER" and pressing the [MENU/ENTER] knob, you can load the demo song.

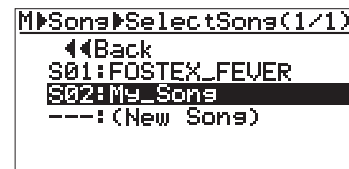



For details about how to select the desired song, see "Song management" on page 113.

Input connection

Input channel

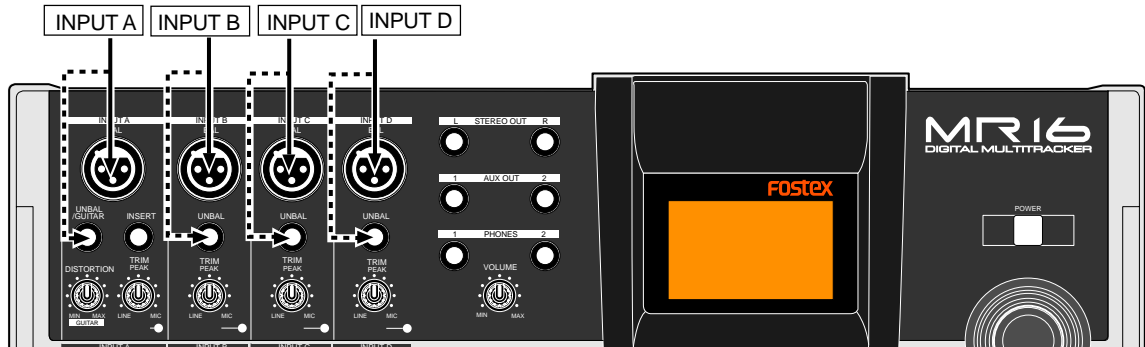
The MR16 provides four input channels: [INPUT A], [INPUT B], [INPUT C] and [INPUT D]. Each channel provides both the XLR and 1/4" phone connectors.



Input channel	Available input connectors	Shapes of connectable connector
INPUT A INPUT B INPUT C INPUT D	Either of the XLR (balanced) connector or phone (unbalanced) jack can be used (if both connectors are plugged, the phone jack is effective).	 <div style="display: flex; justify-content: space-around; margin-top: 5px;"> XLR-3-12C type PHONE plug </div>
<ul style="list-style-type: none"> When you use the [INPUT A] channel, set the [INPUT A SELECT] switch on the rear panel appropriately. If you use a condenser microphone, use the XLR (balanced) connector. The MR16 can supply the phantom power (see page 144). 		

[INPUT A SELECT] switch

When you use the [INPUT A] channel, you must set the [INPUT A SELECT] switch on the rear panel appropriately.

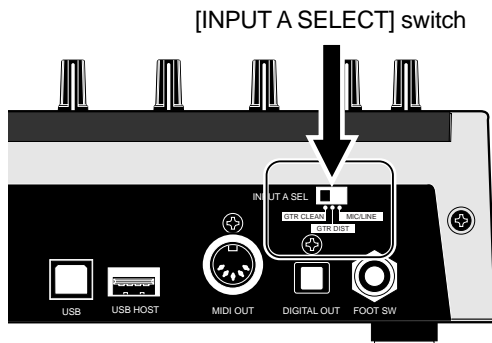

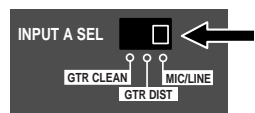
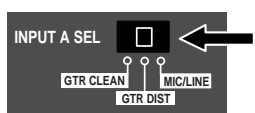
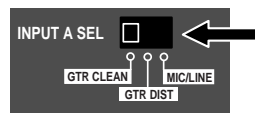
<p style="text-align: center;">"MIC/LINE" position</p> 	<p>Both the [BAL] XLR and [UNBAL/GUITAR] phone connectors can be used. Set the switch to this position when the source is an external microphone or line level source.</p>
<p style="text-align: center;">"GTR DIST" position</p> 	<p>Both the [BAL] XLR and [UNBAL/GUITAR] phone connectors can be used. You can adjust the input level and distortion using the [TRIM] and [DISTORTION] controls respectively. You can also use the amp simulation insert effect.</p>
<p style="text-align: center;">"GTR CLEAN" position</p> 	<p>Both the [BAL] XLR and [UNBAL/GUITAR] phone connectors can be used. You can adjust the input level using the [TRIM] control. You can also use the amp simulation insert effect.</p>

Recording track combinations and available input channel(s)

The MR16 is a 16-track recorder. Tracks 1 through 8 are mono tracks, while tracks 9 through 16 are stereo tracks. The [REC SELECT] keys control track arming.

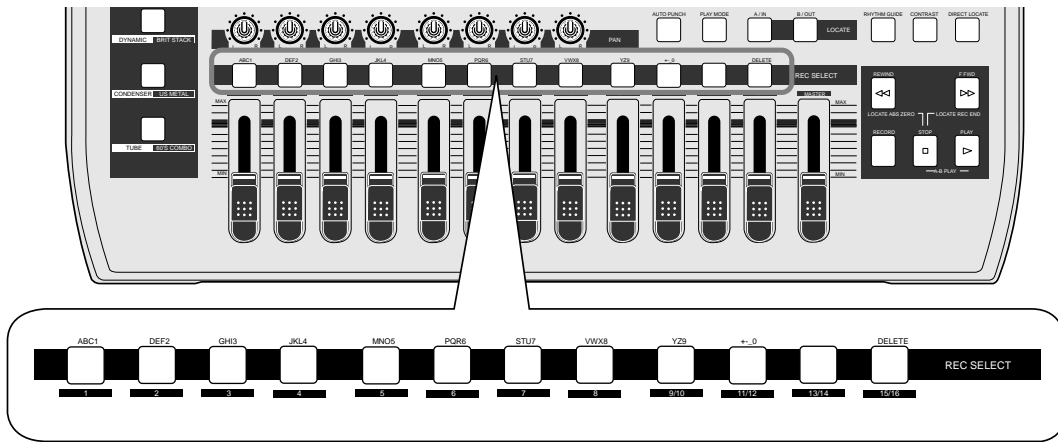

With the MR16, you can simultaneously record up to four tracks. Depending on the armed track(s), the available input channel(s) is (are) automatically assigned. The following shows the recording track combinations, as well as available input channel(s) by the number of tracks simultaneously recorded.

Recording track combinations

When recording to a single track	<ul style="list-style-type: none"> Any one of tracks 1 through 8.
When recording to two tracks simultaneously	<ul style="list-style-type: none"> Any two of tracks 1 through 8. Any pair of tracks 9/10, 11/12, 13/14 and 15/16.
When recording to three tracks simultaneously	<ul style="list-style-type: none"> Any three of tracks 1 through 8 Any one of tracks 1 through 8 and any pair of tracks 9/10, 11/12, 13/14 and 15/16.
When recording to four tracks simultaneously	<ul style="list-style-type: none"> Any four of tracks 1 through 8 Any two of tracks 1 through 8 and any pair of tracks 9/10, 11/12, 13/14 and 15/16. Any two pairs of tracks 9/10, 11/12, 13/14 and 15/16.

Available input channels

When recording to a single track	<ul style="list-style-type: none"> only [INPUT A] is available.
When recording to two tracks simultaneously	<ul style="list-style-type: none"> [INPUT A] and [INPUT B] are available. The [INPUT A] is assigned to the lower numbered track, while the [INPUT B] is assigned to the higher numbered track. (Example: Track 1 -> [INPUT A], Track 2 -> [INPUT B])
When recording to three tracks simultaneously	<ul style="list-style-type: none"> [INPUT A], [INPUT B] and [INPUT C] are available. The [INPUT A] channel is assigned to the lowest numbered track, the [INPUT B] channel assigned to the next lower numbered track, and the [INPUT C] channel is assigned to the highest numbered track . (Example: INPUT A -> Track 8, INPUT B -> Track 9, INPUT C -> Track 10)
When recording to four tracks simultaneously	<ul style="list-style-type: none"> All input channels ([INPUT A], [INPUT B], [INPUT C] and [INPUT D]) are available. The [INPUT A] channel is assigned to the lowest numbered track, the [INPUT B] channel assigned to the next lower numbered track, the [INPUT C] channel is assigned to the next higher numbered track, and the [INPUT D] channel is assigned to the highest numbered track . (Example: INPUT A -> Track 1, INPUT B -> Track 2, INPUT C -> Track 7, INPUT D -> Track 8)

Recording onto a single track

You can record onto any one of tracks 1 through 8. When making recording to a single track, you can record a signal fed to the [INPUT A] channel.

The following describes the procedure for recording an acoustic guitar onto track 1 via a microphone. We assume that Song02 is loaded and no sound is recorded to Song02. See "Creating a song for recording" on page 33 for details about how to create a song.

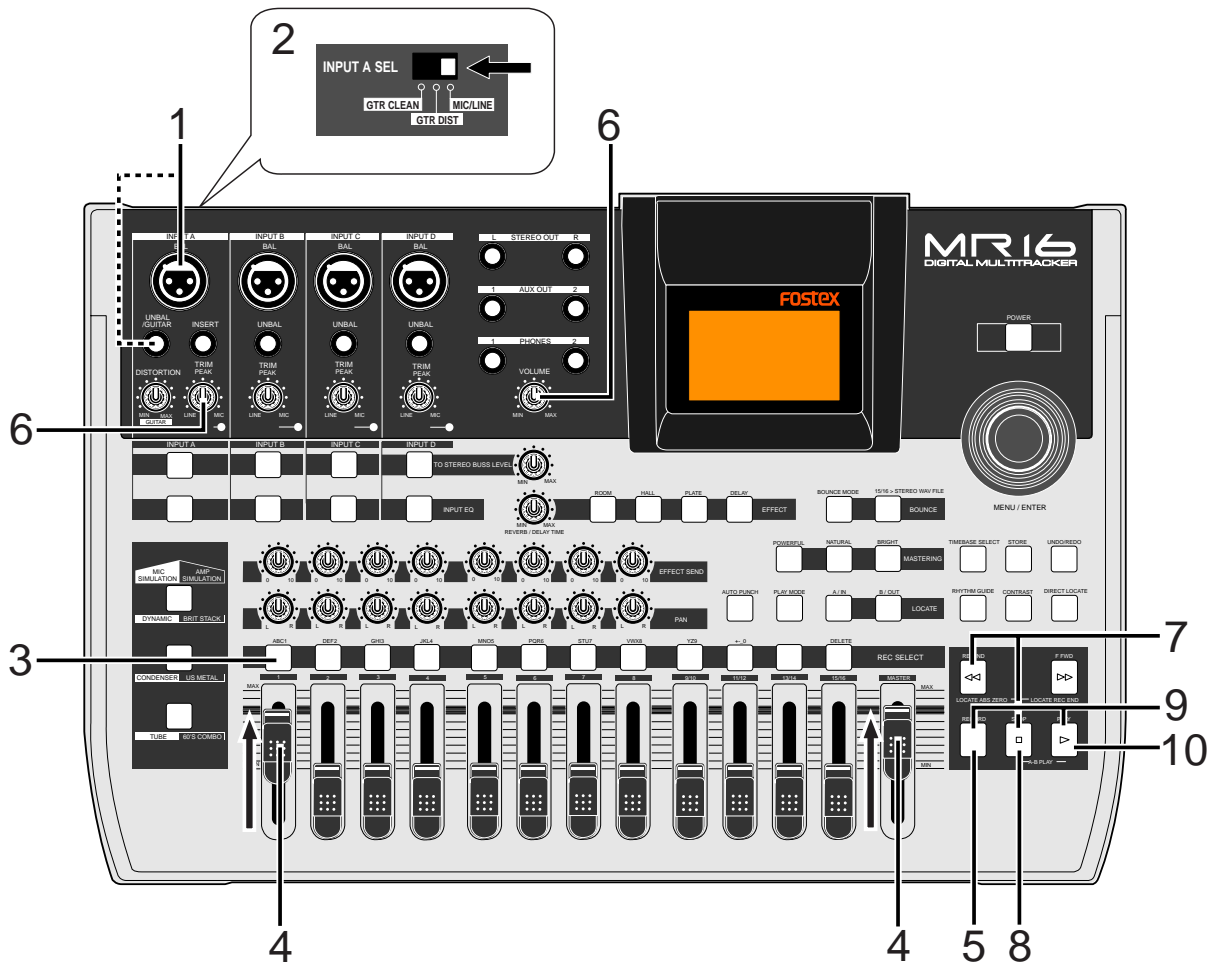

Preparation for recording

- 1) Connect a microphone to the [BAL] or [UNBAL/GUITAR] input connector of the [INPUT A] channel.

<Note>: You can supply the phantom power to a condenser microphone connected to the [BAL] XLR connector (see page 144). Note that you cannot supply the phantom power via the [GUITAR/UNBAL] phone connector.

- 2) Set the [INPUT A SELECT] switch to "MIC/LINE".

<Note>: You can apply the mic simulation as insert effects when the [INPUT A SELECT] switch to "MIC/LINE" (see page 68).

<Note>: You can apply EQ to the input signal during recording (see page 66).

- 3) Press the [REC SELECT] key for track 1. Track 1 is record armed and the [REC SELECT] key for track 1 starts flashing. On the home screen, the remaining time is shown, while "1" for the track number changes to "A". This indicates you can now record the [INPUT A] channel signals to tracks 1 respectively.



- 4) **Set track fader 1 and [MASTER] fader to the nominal position (marked by ≡).**
 Raising these faders allows you to monitor the input sound. If these faders are not raised, you cannot monitor the sound via headphones.

<Note>: The fader for track 1 is used to adjust the monitor level. To adjust the recording level, use the [TRIM] control of the [INPUT A] channel.

- 5) **Press the [RECORD] key once (the key indicator starts flashing).**
 Track 1 (which is record armed) now enters the input monitor mode and "INF" is shown on the home screen.



- 6) **While playing the guitar, adjust the recording level using the [TRIM] control of the [INPUT A] channel.**

Adjust the level appropriately so that the PEAK indicator does not light.
 Turning the [PHONES VOL] control clockwise raises the headphone monitor level.

The screen shows the input level of track 1, as well as the stereo L and R output levels.



<Note>: Adjust the [TRIM] control properly so that the PEAK indicator does not light at the loudest part of the guitar sound. If the input level is too high, the PEAK indicator lights and the sound may be distorted or noisy.

<Tip>: When receiving a line level signal, set the [TRIM] control to left ("LINE") to get the appropriate level. When receiving a microphone signal, set the [TRIM] control to right ("MIC") to get the appropriate level.

Starting recording

- 7) **While holding down the [RECORD] key, press the [PLAY] key to start recording.**
 The guitar is recorded.
- 8) **When recording completes, press the [STOP] key to stop the recorder.**

<Note>: We recommend to press the [REC SELECT] key for track 1 to unarm track 1.

Playing back the recorded track

- 9) **Press the [REWIND] key while holding down the [STOP] key to locate the recorder to the beginning of the song.**
- 10) **Press the [PLAY] key to start playback.**
 You can adjust the monitor level using the track 1 fader, as well as the [MASTER] fader and [PHONES VOL] control.

If you are not satisfied with the result, use the undo/redo function to cancel the recording and try again.

Undoing recording (undo/redo)

If you press the [UNDO/REDO] key after finishing recording, you can return to the condition before the recording started (UNDO operation). Therefore, you can try recording again.
 If you press the [UNDO/REDO] key again (after UNDO), the undo operation is canceled and you can return to the condition when the recording finished (REDO operation).



<Notes>: The undo/redo function is available for all kind of recordings, however, if you carry out any of the following operations after making recording, you cannot undo the recording.

- Carrying out new recording.
- Carrying out track or part editing.
- Turning off the power.
- Selecting another song or editing the song name.

Overdubbing basics

Overdubbing is recording something new while listening to the previously recorded track(s). It is a very important method in multitrack recording. The following describes an example of overdubbing for recording a stereo keyboard to tracks 9/10 while listening to the guitar on track 1. See the procedure previously described in "Recording onto a single track" for details about how to record a guitar on track 1. In the procedure below, we assume that the song of which the guitar has been recorded on track 1 is loaded.

Note that you can make overdubbing to another track or other tracks in the same manner as described below.

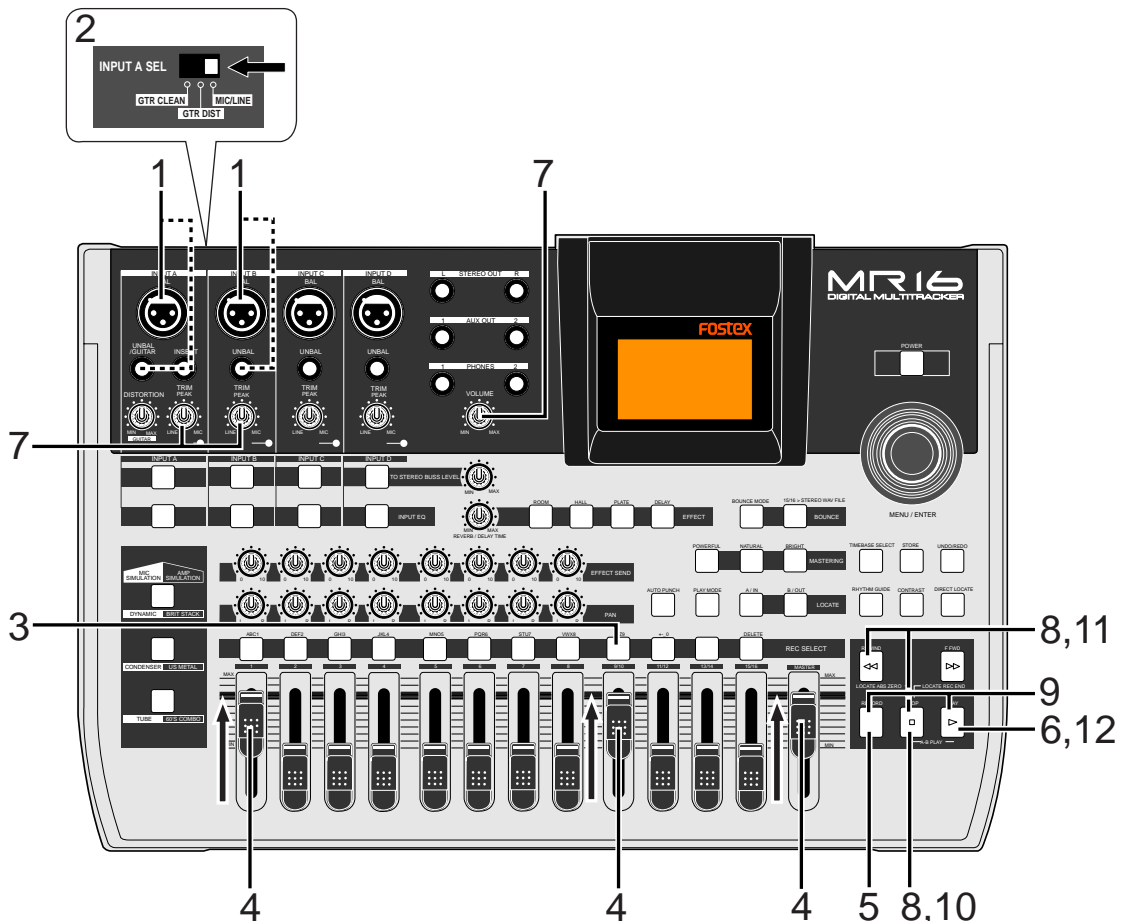

Preparation for recording

- 1) **Connect the L and R outputs of the keyboard to input connectors of the [INPUT A] and [INPUT B] channels.**
Connect the L and R outputs to the [INPUT A] and [INPUT B] channels respectively.
- 2) **Set the [INPUT A SELECT] switch to "MIC/LINE".**
- 3) **Press the [REC SELECT] key for tracks 9/10.**
Tracks 9/10 are record armed and the [REC SELECT] key for tracks 9/10 starts flashing.

On the home screen, the remaining time is shown, while "9" and "10" for the track numbers change to "A" and "B" respectively.

This indicates you can now record the [INPUT A] and [INPUT B] channel signals to tracks 9 and 10 respectively.



- 4) **Set track faders 1 and 7/8 and the [MASTER] fader to the nominal position (marked by ≡).**
Raising these faders allows you to monitor the input sound. If these faders are not raised, you cannot monitor the sound via headphones.

<Note>: Track 1 and 9/10 faders are used to adjust the monitor level. To adjust the recording levels, use the [TRIM] controls of the [INPUT A] and [INPUT B] channels.

- 5) Press the [RECORD] key once (the key indicator starts flashing).

The armed tracks 9/10 now enter the input monitor mode, while "IMP" is shown on the home screen.



Adjusting the recording levels while listening to track 1

- 6) Press the [PLAY] key to play back the song from the beginning.

Though tracks 9/10 are in the input monitor mode, you can hear the track 1 signal by rotating the [PHONES VOL] control clockwise (while the meter for track 1 shows the playback level).

- 7) While playing the keyboard, adjust the recording levels using the [TRIM] controls of the [INPUT A] and [INPUT B] channels.

Adjust the levels appropriately so that the PEAK indicators for these input channels do not light.

The home screen shows the playback level of track 1 and the input levels of tracks 9 and 10, as well as the stereo L and R output levels.



<Note>: Adjust each [TRIM] control properly so that the corresponding PEAK indicator does not light at the loudest part of the keyboard sound.

<Tip>: When receiving a line level signal, set the [TRIM] control to left ("LINE") to get the appropriate level. When receiving a microphone signal, set the [TRIM] control to right ("MIC") to get the appropriate level.

- 8) After adjusting the recording levels properly, press the [REWIND] key while holding down the [STOP] key to locate the recorder to the beginning of the song.

Starting recording

- 9) While holding down the [RECORD] key, press the [PLAY] key to start recording.

The recorder records the keyboard while playing back track 1 (guitar).

- 10) When recording completes, press the [STOP] key to stop the recorder.

<Note>: We recommend to press the [REC SELECT] key for tracks 9/10 to unarm tracks 9/10.

Playing back the recorded track

- 11) Press the [REWIND] key while holding down the [STOP] key to locate the recorder to the beginning of the song.

- 12) Press the [PLAY] key to start playback.

You can adjust the monitor level using the track faders, as well as the [MASTER] fader and [PHONES VOL] control.

<Note>: If you are not satisfied with the result, use the undo/redo function to cancel the recording and try again.

Undoing recording (undo/redo)

If you press the [UNDO/REDO] key after finishing recording, you can return to the condition before the recording started (UNDO operation). Therefore, you can try recording again.

If you press the [UNDO/REDO] key again (after UNDO), the undo operation is canceled and you can return to the condition when the recording finished (REDO operation).

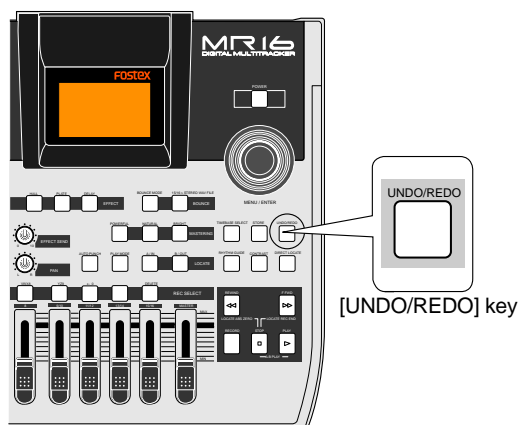

<Notes>: The undo/redo function is available for all kind of recordings, however, if you carry out any of the following operations after making recording, you cannot undo the recording.

- Carrying out new recording.
- Carrying out track or part editing.
- Turning off the power.
- Selecting another song or editing the song name.

Recording onto four tracks simultaneously

You can simultaneously record up to four tracks. See page 36 for the available combinations of four recording tracks. The following describes the procedure for recording different sound sources simultaneously to tracks 1 through 4. You can make four-track simultaneous recording with any available track combination in the same manner.



Preparation for recording

- 1) Connect the following sound sources to the [INPUT A] through [INPUT D] channels.

[INPUT A]	->	Electric guitar
[INPUT B]	->	Electric bass
[INPUT C]	->	Microphone (vocal)
[INPUT D]	->	Drum machine

<Note>: If you connect a condenser microphone to the [BAL] XLR connector of the [INPUT C] channel, you can supply the phantom power to the microphone (see page 144).

- 2) Set the [INPUT A SELECT] switch to "GTR DIST". You can add distortion of the internal effects to your guitar sound.

<Note>: You can apply the amp simulation as insert effects when the [INPUT A SELECT] switch is set to "GTR DIST" (see page 68).

- 3) Press the [REC SELECT] key for tracks 1 through 4. Tracks 1 through 4 are record armed and the [REC SELECT] keys for tracks 1 through 4 start flashing.

On the home screen, track numbers "1" through "4" changes to "A" through "D" respectively, showing that each input is assigned to the appropriate track. The remaining time of the hard disk is shown.



- 4) Set the track faders 1 through 4 and [MASTER] fader to the nominal position (marked by ). Raising these faders allows you to monitor the input sound. If these faders are not raised, you cannot monitor the sound via headphones.

<Note>: Track faders 1 through 4 are used to adjust the monitor levels. To adjust the recording level, use the [TRIM] controls for [INPUT A] through [INPUT D].

- 5) Press the [RECORD] key once (the key indicator starts flashing). Tracks 1 through 4 (which are armed) now enter the input monitor mode and "IMP" is shown on the home screen.

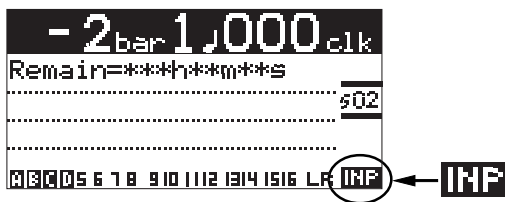

- 6) While playing the music, adjust the recording level of each track using the [TRIM] control of each input channel. Adjust the level appropriately so that the PEAK indicator does not light. Turning the [PHONES VOL] control clockwise raises the headphone monitor level. The screen shows the input level of tracks 1 through 4, as well as the stereo L and R output levels.



<Note>: Adjust the [TRIM] control of each input channel properly so that the PEAK indicator does not light at the loudest part of the sound.

<Tip>: You can add distortion to an electric guitar connected to [INPUT A]. Use the [DISTORTION] control to adjust the distortion level. When you add distortion, readjust the [TRIM] control.

<Tip>: When receiving a line level signal, set the [TRIM] control to left ("LINE") to get the appropriate level. When receiving a microphone signal, set the [TRIM] control to right ("MIC") to get the appropriate level.

Starting recording

- 7) While holding down the [RECORD] key, press the [PLAY] key to start recording. The recorder starts recording.
- 8) When recording completes, press the [STOP] key to stop the recorder.

<Note>: We recommend to press the [REC SELECT] key for tracks 1 through 4 to un-arm these tracks.

Playing back the recorded track

- 9) Press the [REWIND] key while holding down the [STOP] key to locate the recorder to the beginning of the song.
- 10) Press the [PLAY] key to start playback. You can adjust the monitor level using track faders 1 through 4, as well as the [MASTER] fader and [PHONES VOL] control.

<Note>: If you are not satisfied with the result, use the undo/redo function to cancel the recording and try again.

Undoing recording (undo/redo)

If you press the [UNDO/REDO] key after finishing recording, you can return to the condition before the recording started (UNDO operation). Therefore, you can try recording again. If you press the [UNDO/REDO] key again (after UNDO), the undo operation is canceled and you can return to the condition when the recording finished (REDO operation).

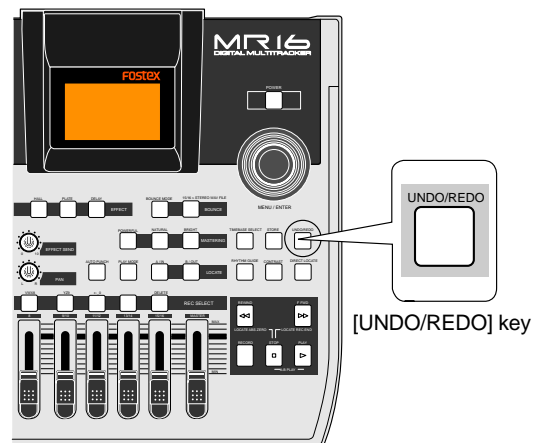

<Notes>: The undo/redo function is available for all kind of recordings, however, if you carry out any of the following operations after making recording, you cannot undo the recording.

- Carrying out new recording.
- Carrying out track or part editing.
- Turning off the power.
- Selecting another song or editing the song name.

Basic mixdown

This section describes basic mixdown which is the final process of multitrack recording. Mixdown mixes recorded materials on tracks 1 through 16 down to stereo. The mixdowned material can be recorded to an external master recorder.

The MR16 is equipped with the [DIGITAL OUT] connector, so you can record a mixdowned signal to a digital master recorder (DAT, MD, etc.) which can accept an S/P DIF digital signal in digital domain. With the MR16, you can also record a mixdowned signal internally to a new song of the MR16 using the track bouncing function, without the need of an external master recorder (see "Track bouncing" described later).

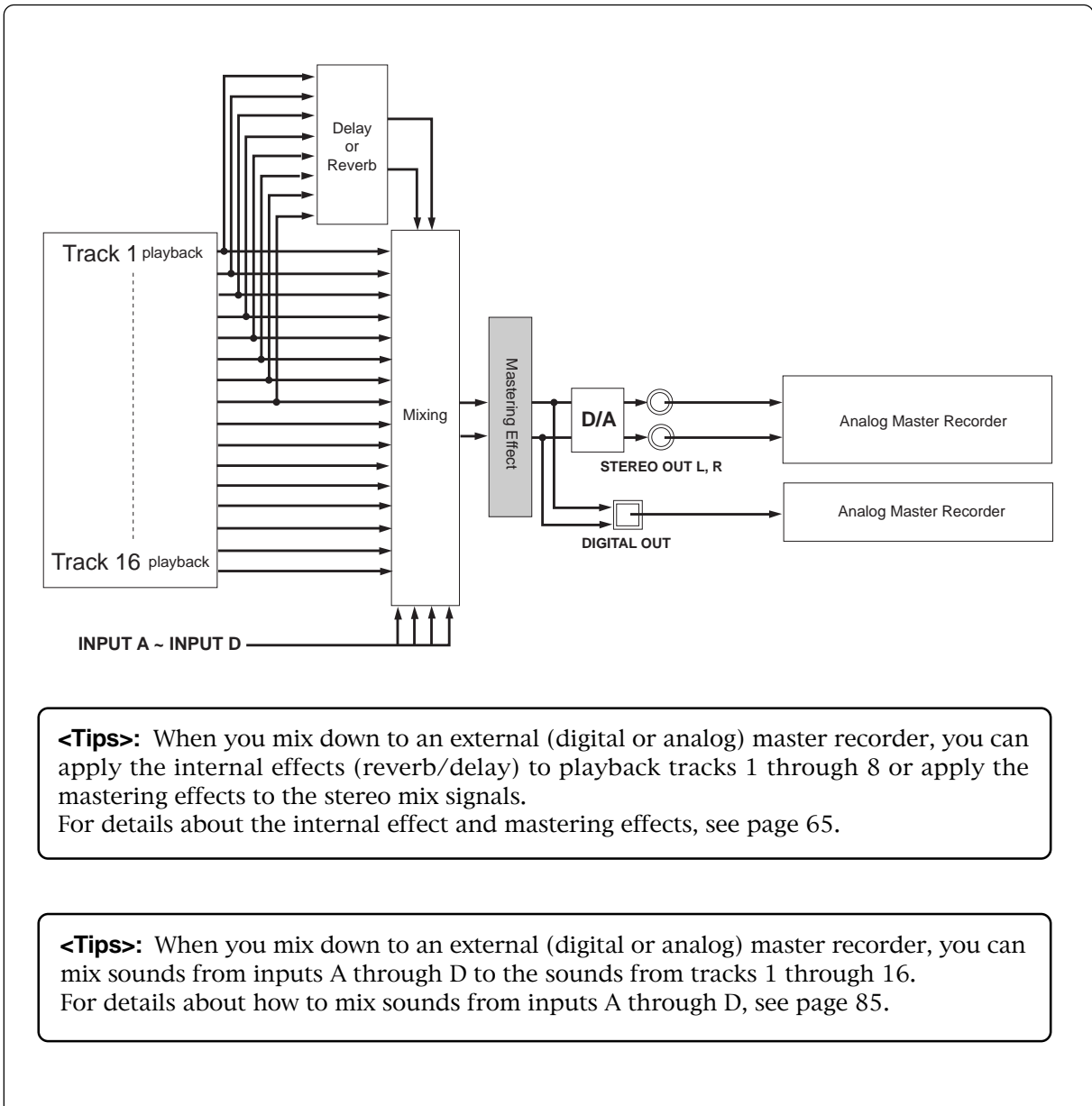

Mixdown to an analog recorder

The following describes how to make mixdown recording to an external analog recorder.

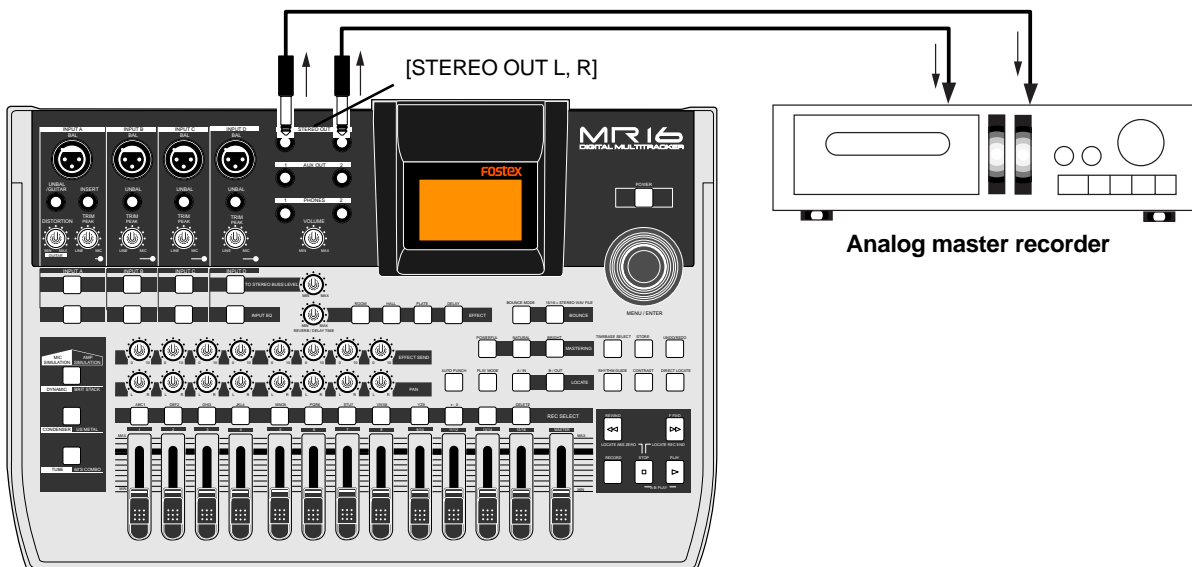

- 1) **Connect the [STEREO OUT (L, R)] connectors of the MR16 to the input connectors of an analog master recorder.**
- 2) **While playing back the MR16, rehearse mixing down the recorded sounds by adjusting the level and panning of each track, applying effects to tracks 1 through 8 and applying the mastering effects to the L/R stereo mix, etc.**
The output levels from the [STEREO OUT (L, R)] connectors can be controlled by the [MASTER] fader.
- 3) **Adjust the recording level of the master recorder while rehearsing mixdown.**
See the manual of the master recorder for details about how to adjust the recording level.
- 4) **After rehearsing mixdown and adjusting the recording level, locate the MR16 to the beginning of the song.**
- 5) **Start the master recorder recording and then start the MR16 playing back.**
- 6) **After finishing recording, stop both recorders.**

Adjust the levels appropriately so that the highest segments of L and R meters do not light.

See "Using effects" on page 65 for details about the delay/reverb and mastering effects.

You can also mix sound sources connected to [INPUT A] through [INPUT D] during mixdown. See page 85 for details.

<Tip>: By sliding up or down the MR16 [MASTER] fader gradually, you can fade in or fade out recording.

Mixdown to a digital recorder

The following describes how to make mixdown recording to an external digital recorder.

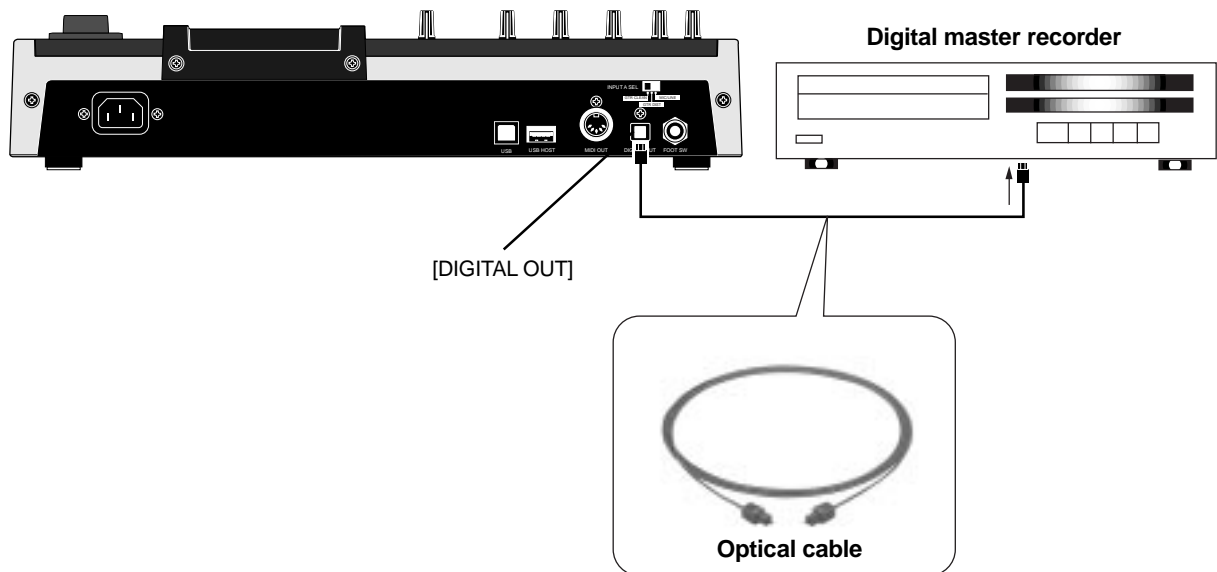

- 1) Connect the [DIGITAL OUT] connector of the MR16 to the digital input connector of a digital master recorder using an optical cable.

<Note>: The [DIGITAL OUT] connector of the MR16 is the Toslink optical type. If your digital recorder provides only the coaxial type connector, use the Fostex COP-1/96kHz coaxial-optical converter. Contact Fostex or our dealer for details about the Model COP-1/96kHz.



Model COP-1/96kHz

- 2) **Set the master recorder to accept the digital input.**
Make sure that the recorder accepts the digital signal output from the MR16, which is 44.1-kHz, 16-bit, S/P DIF signal.

Generally, a digital recorder cannot adjust the digital input level.

- 3) While playing back the MR16, rehearse mixing down the recorded sounds by adjusting the level and panning of each track, applying effects to tracks 1 through 8 and applying the mastering effects to the L/R stereo mix, etc.

See "Using effects" on page 65 for details about the delay/reverb and mastering effects.

You can also mix sound sources connected to [INPUT A] through [INPUT D] during mixdown. See page 85 for details.

- 4) **Use the [MASTER] fader of the MR16 to adjust the output level.**
Adjust the level appropriately so that the level meter of the master recorder shows "0" when the MR16 outputs the biggest signal.

If the level meter exceeds "0", the sound may be distorted.

- 5) **Start the master recorder recording and then start the MR16 playing back.**

<Tip>: By sliding up or down the MR16 [MASTER] fader gradually, you can fade in or fade out recording.

- 6) **After finishing recording, stop both recorders.**

Advanced playback and locate functions

This chapter describes advanced playback functions including cueing, partial playback (between points A and B), special play modes, as well as the locate function.

3 x cueing

By holding down the [F FWD] or [REWIND] key during playback, the recorder enters cueing mode and you can monitor playback at 3 x speed. It may be useful for searching a specific position.

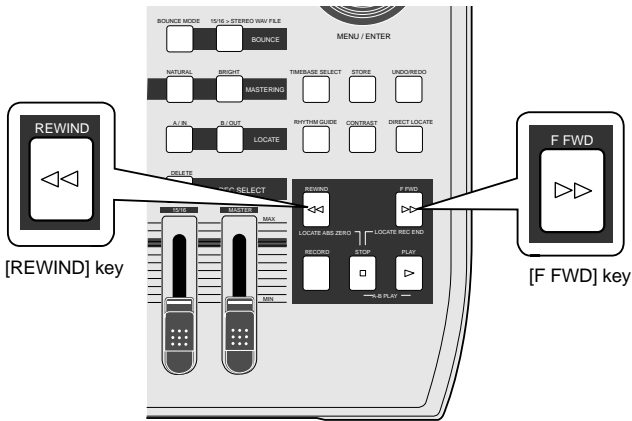

- **By holding down the [F FWD] key during playback, the recorder starts cueing forwards at 3 x speed.** During forward cueing, "▶▶" is shown on the display.



- **By holding down the [REWIND] key during playback, the recorder starts cueing backwards at 3 x speed.** During backward cueing, "◀◀" is shown on the display.



Playback between LOCATE A and B points

When the LOCATE A and LOCATE B points are set, you can playback between these points once. This function is always available regardless of the play mode setting (see "Play mode" on next page). This function allows you to check the editing part (between LOCATE A and B points) for copy/paste, erase, etc. See "Part editing" described later.

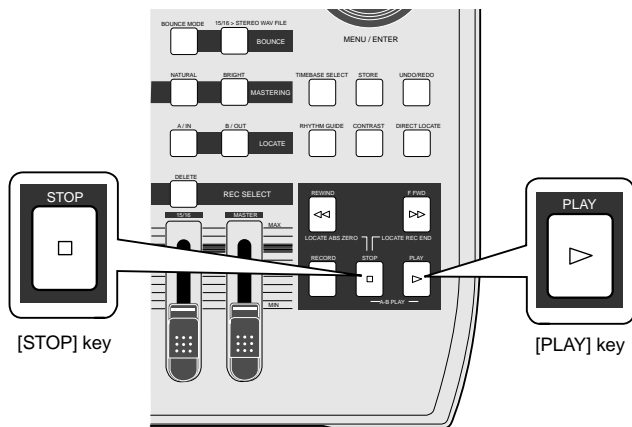

- **While the recorder is stopped, press the [PLAY] key while holding down the [STOP] key.** The MR16 plays back audio data between the LOCATE A and LOCATE B points once, then stops.

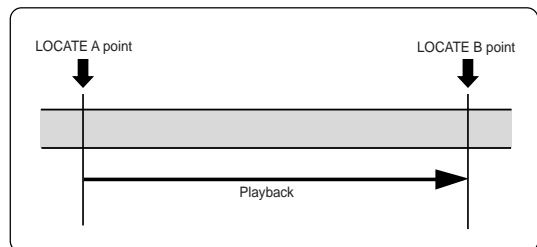

<Note>: Note that this function is available only when the LOCATE A and B points are set. See page 53 for details about how to set the LOCATE A and B points.

<Note>: If you carry out the operation above when the LOCATE A point is set ahead of the LOCATE B point (i.e. LOCATE A > LOCATE B), the MR16 plays back audio data from the LOCATE A point to the REC END points once, then stops.

While the recorder is playing back between the LOCATE A and B points, the display shows the icon as below.



During playback, you can monitor playback audio of the desired track(s) by raising the appropriate track fader(s), the [MASTER] fader and the [PHONES] control.

Play mode

The MR16 offers special play modes including the auto play, auto return and loop playback modes in addition to the normal playback mode.

Selecting a play mode

While the recorder is stopped, each time you press the [PLAY MODE] key, the play mode switches among "Off", "Auto Play", "Auto return" and "Loop".

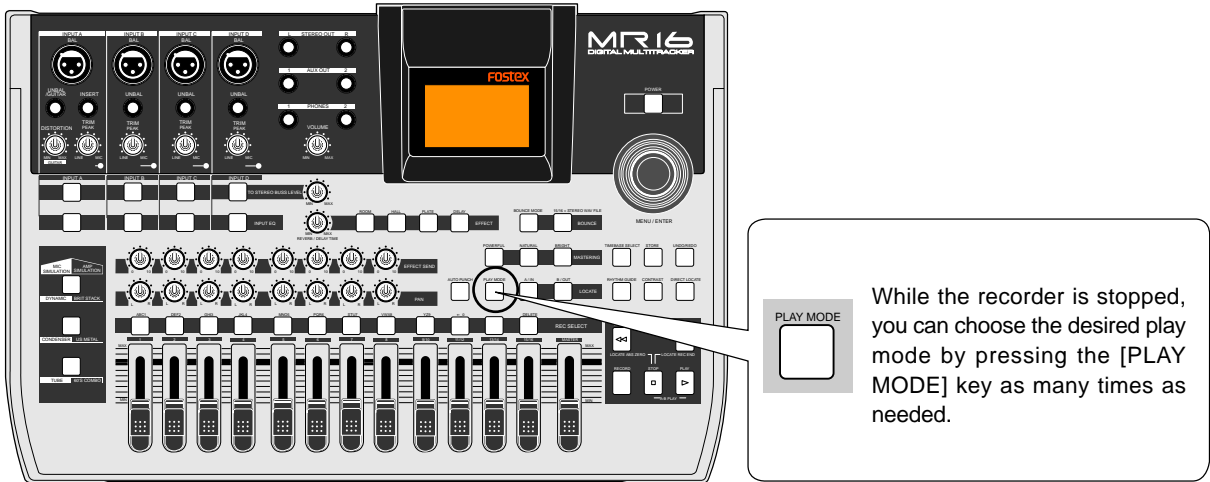

The current mode is shown on the screen as follows (when "Off" is selected, there is no indication).

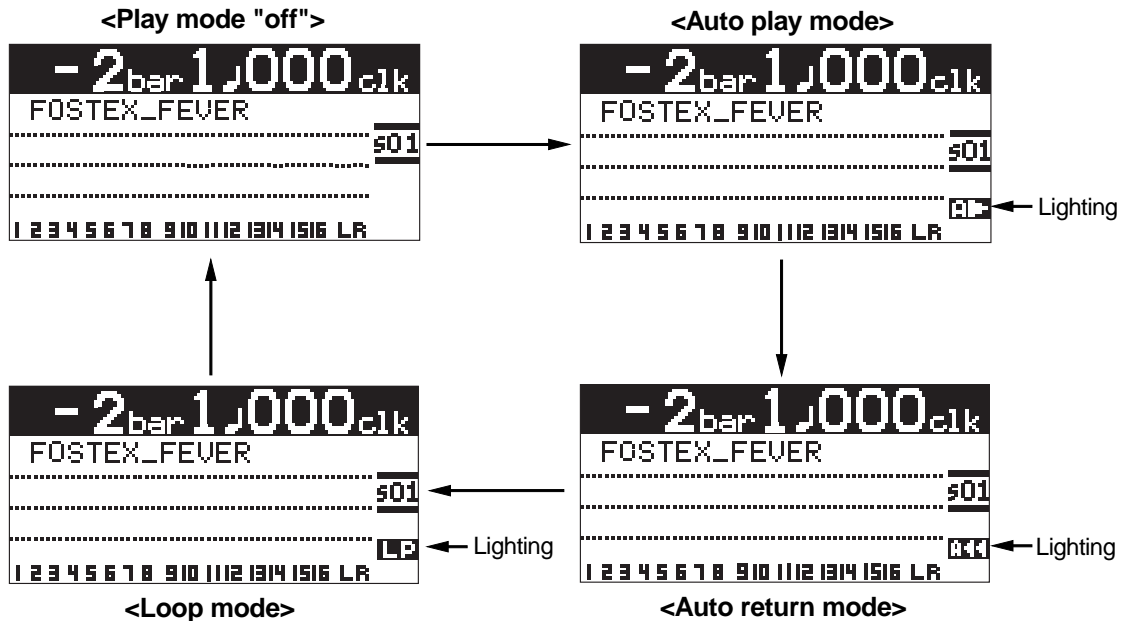

Auto play mode

In the Auto play mode, when locating to the ABS ZERO, REC END, LOCATE A or LOCATE B point, the recorder automatically starts playback from the point. The following shows the auto play function after locating to the LOCATE A point (see page 52 for the locate function).

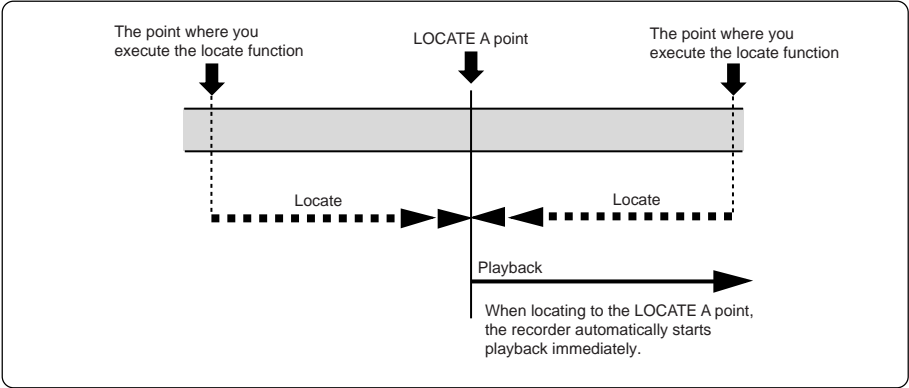

Auto return mode

The auto return mode is active when the LOCATE A and LOCATE B points are set. In the auto return mode, when reaching at the LOCATE B point during playback, the recorder automatically locates to the LOCATE A point and stops.

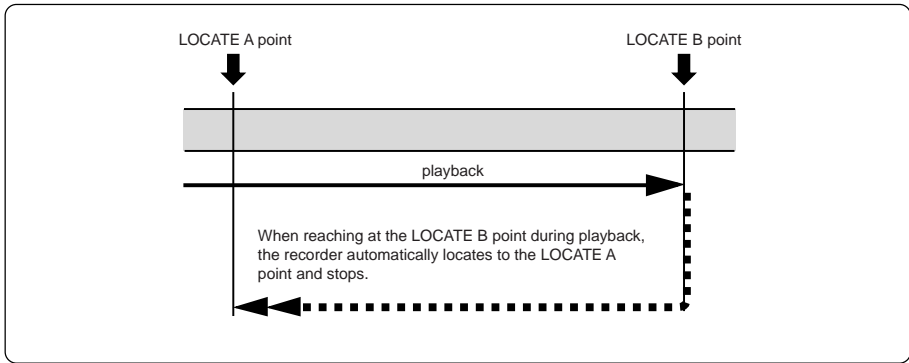

Loop mode

As with the auto return mode, the loop mode is active when the LOCATE A and LOCATE B points are set. In the loop mode, when reaching at the LOCATE B point during playback, the recorder automatically locates to the LOCATE A point and starts playback. The recorder repeats this behavior until you stop the recorder.

You may find it very convenience to use the loop function together with the auto punch in/out function (see the next page).

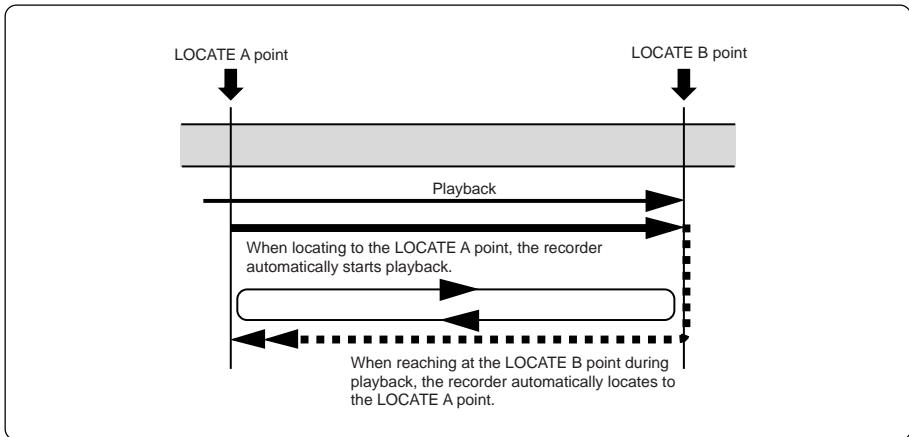

Loop function in auto punch in/out mode

When the loop mode is active (while the auto punch in/out mode is inactive), the LOCATE A and LOCATE B points are used as the loop start and end points. When the auto punch in/out mode is active (while the loop mode is inactive), the LOCATE A and LOCATE B points are used as the punch-in and punch-out points.

When both the auto punch in/out and loop modes are active, the LOCATE A and LOCATE B points are used as the punch-in and punch-out points, while the loop function starts at "the LOCATE A point minus the pre-roll time" and ends at "the LOCATE B point plus the post-roll time", as shown below. The pre-roll time is initially set to four seconds, while the post-roll time is set to one second.

<Note>: If you set the LOCATE A point to the beginning of a song (ABS ZERO) or set the LOCATE B point to the recording end point (REC END) of a song, the pre-roll or post-roll time is ignored.

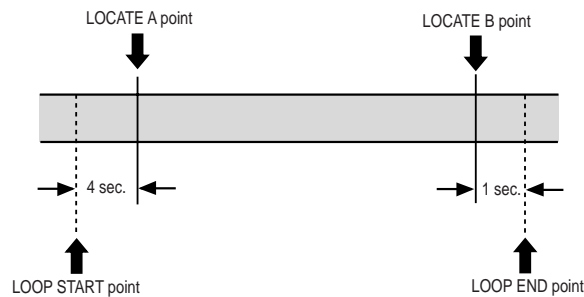

Using the loop function in the auto punch in/out mode reduces the number of key presses, allowing you to concentrate on playing.

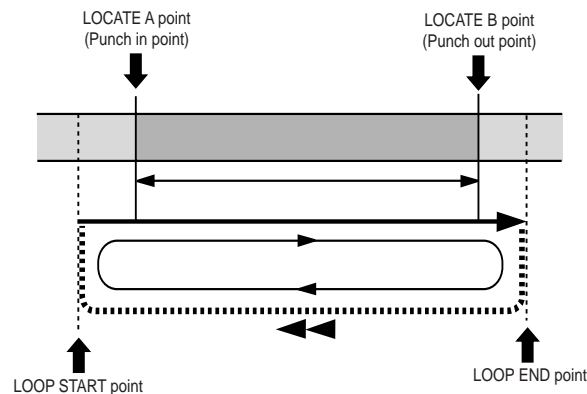

You can change the pre-roll and post-roll time within the range between 0.1 and 10.0 seconds (in 0.1 second steps) in the menu mode (see page 142).

Locate function

The following describes the locate functions, which allow you to immediately skip to a specified point in a song.

Time locate

Regardless of the current recorder position, you can locate to the beginning (ABS ZERO) of the song or the recording end (REC END) of the song.

Locating to the beginning (ABS ZERO) of a song

- While the recorder is stopped, press the [REWIND] key while holding down the [STOP] key.

The MR16 immediately locates to the beginning of the song (ABS ZERO) and stops.

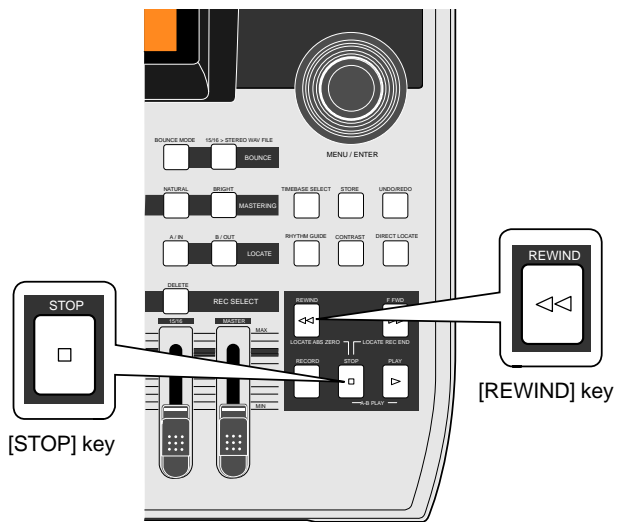
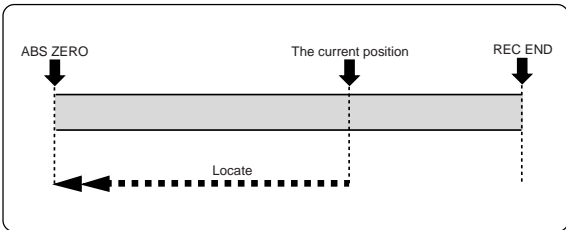

Locating to the recording end point (REC END) of a song

- While the recorder is stopped, press the [F FWD] key while holding down the [STOP] key.

The MR16 immediately locates to the recording end of the song (REC END) and stops.

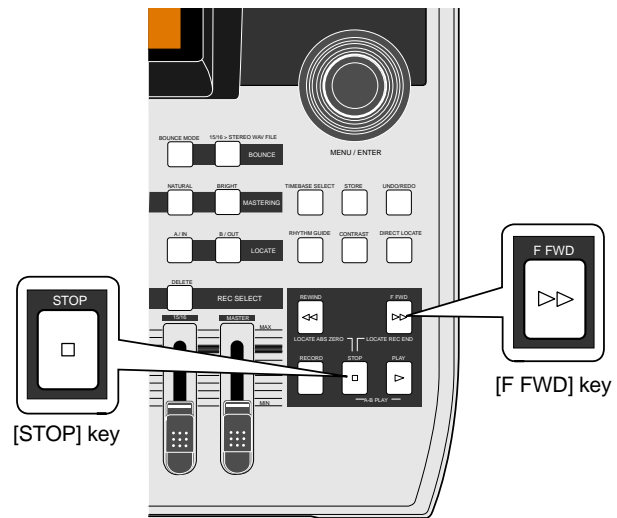
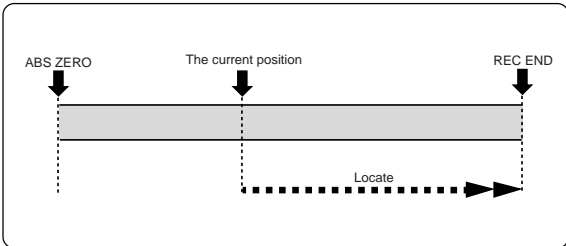

Locating to the LOCATE A or LOCATE B point

You can set the desired point of a song as the LOCATE A or LOCATE B point. The LOCATE A and B points can be used not only for locating, but also for auto punch in/out, play modes and part editing, etc.

Setting the LOCATE A or LOCATE B point

You can set the LOCATE A or LOCATE B point while the recorder is running or stops at the desired point, regardless of time base setting.

<Note>: You cannot set the LOCATE A or B point for a protected song. If you are going to do so, the warning message ("**This song is protected!**") is shown. To set the LOCATE A or B point for a protected song, release the protection first (see page 117).

<Note>: The LOCATE A point must be earlier than the LOCATE B point. If not, you cannot carry out the auto punch in/out or loop function correctly.

<Tip>: While the time base is set to the bar/beat mode, if you set the "**Beat resolution**" menu item in the menu mode to "**On**", you can store the LOCATE A or B point in beat resolution. In other words, the clock digit of the Bar/Beat/Clk value is automatically rounded down or up, so that the clock digit is always "**000**". See page 143 for details about how to make the beat resolution active or inactive.

- **To set the LOCATE A point:**

When the recorder is playing back (or stopped), press the [LOCATE A/IN] key at the desired point while holding down the [STORE] key.

The display briefly shows "Store LOCATE A", and the point when pressing the [LOCATE A/IN] key is stored as the LOCATE A point.

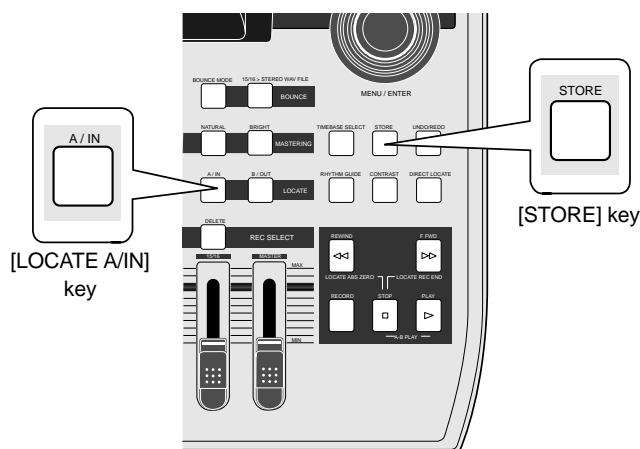

- **To set the LOCATE B point:**

When the recorder is playing back (or stopped), press the [LOCATE B/OUT] key at the desired point while holding down the [STORE] key.

The display briefly shows "Store LOCATE B", and the point when pressing the [LOCATE B/OUT] key is stored as the LOCATE B point.

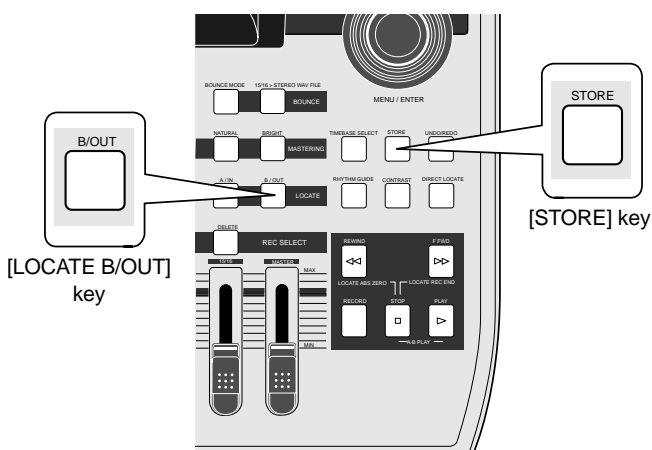

Locating

While the recorder is stopped, press the [LOCATE A/IN] (or [LOCATE B/OUT]) key.
The recorder instantly locates to the appropriate point.

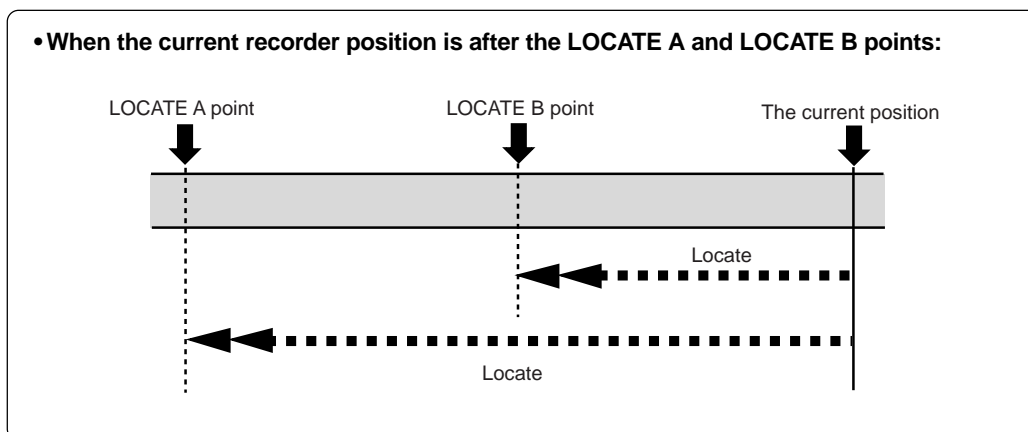
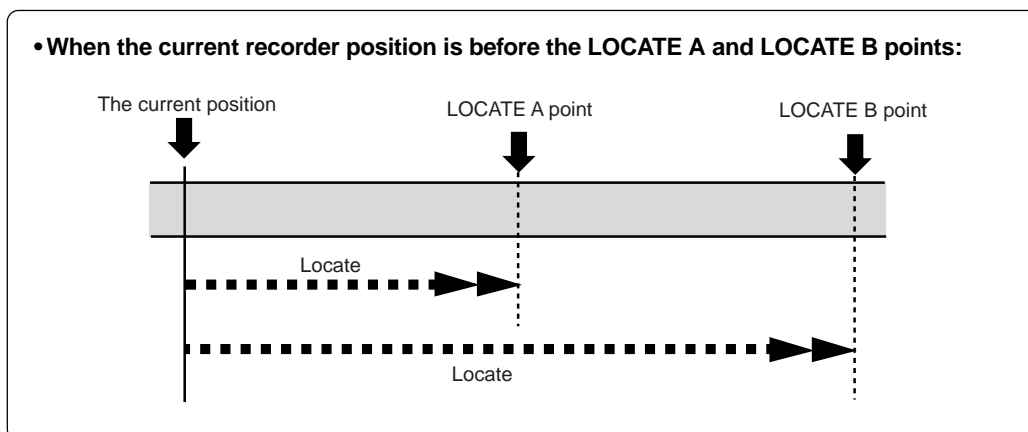
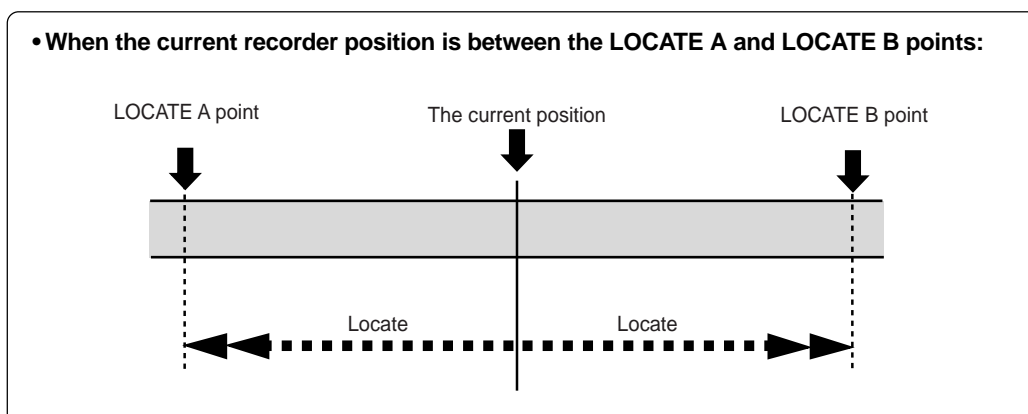

<Tip>: By selecting the play mode to "Auto play", the recorder automatically starts playback after locating the LOCATE A or LOCATE B point.

Direct locate mode

The direct locate mode allows you to locate the desired point specified by measure/beat or time in a song. To do this, you rotate the **[MENU/ENTER]** knob instead of using the **[REWIND]** or **[F FWD]** key.

Direct locate mode basics

Use the **[DIRECT LOCATE]** key to switch on/off of the direct locate mode. Each press of the **[DIRECT LOCATE]** key alternates between ON and OFF. When ON, the key indicator lights up. You can also turn off the direct locate mode by pressing the **[STOP]** key. In the direct locate mode, you rotate the **[MENU/ENTER]** knob for locating the desired point.

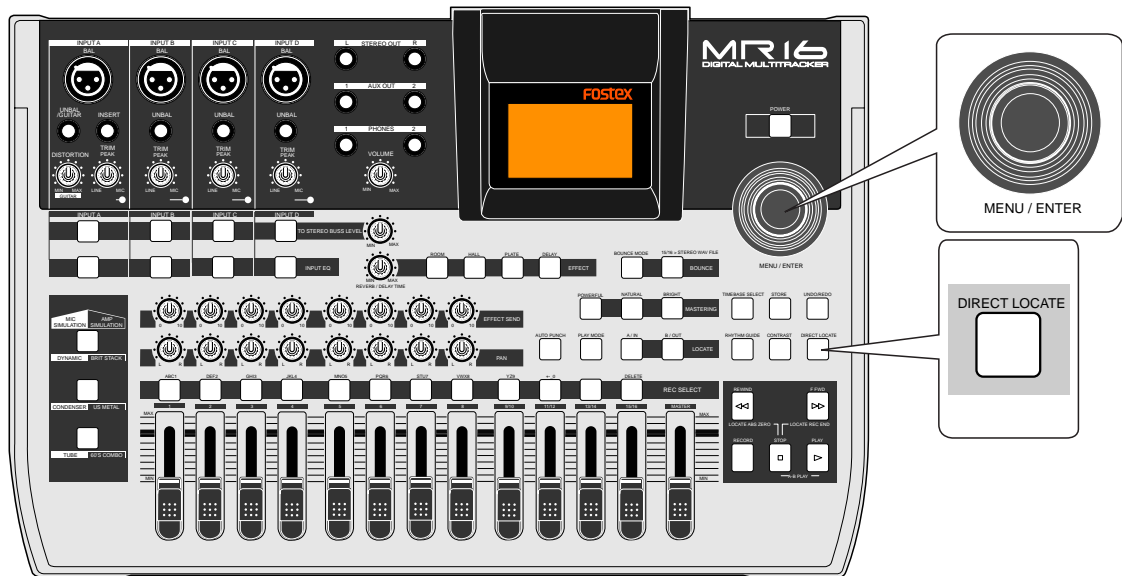

While the recorder is stopped, pressing the **[DIRECT LOCATE]** key turns on the direct locate mode and the following "Direct locate" screen appears. Note that the "Direct locate" screen looks different depending on the time base mode before the unit enters the direct locate mode (see screen examples below). In this condition, you can use the **[MENU/ENTER]** rotary knob to locate the desired position. The time base mode can be changed using the **[TIME BASE SELECT]** key after the unit enters the direct locate mode. The following shows the "Direct locate" screen examples when you enter the direct locate mode while the recorder is at the beginning of the current song.

Time base mode: ABS



In the screen example on the left, the time base mode is "ABS" and the locate function by rotating the **[MENU/ENTER]** knob is executed with minute accuracy. For details about how to change the locate accuracy, see the next page.

Time Base mode: Bar/Beat



In the screen example on the left, the time base mode is "BAR/BEAT" and the locate function by rotating the **[MENU/ENTER]** knob is executed with bar accuracy. For details about how to change the locate accuracy, see the next page.

Setting the locate accuracy

By default, the direct locate function is executed in minute accuracy when the time base is set to "ABS", while it is executed in measure accuracy when the time base is set to "Bar/Beat". By pressing the [MENU/ENTER] knob while the direct locate

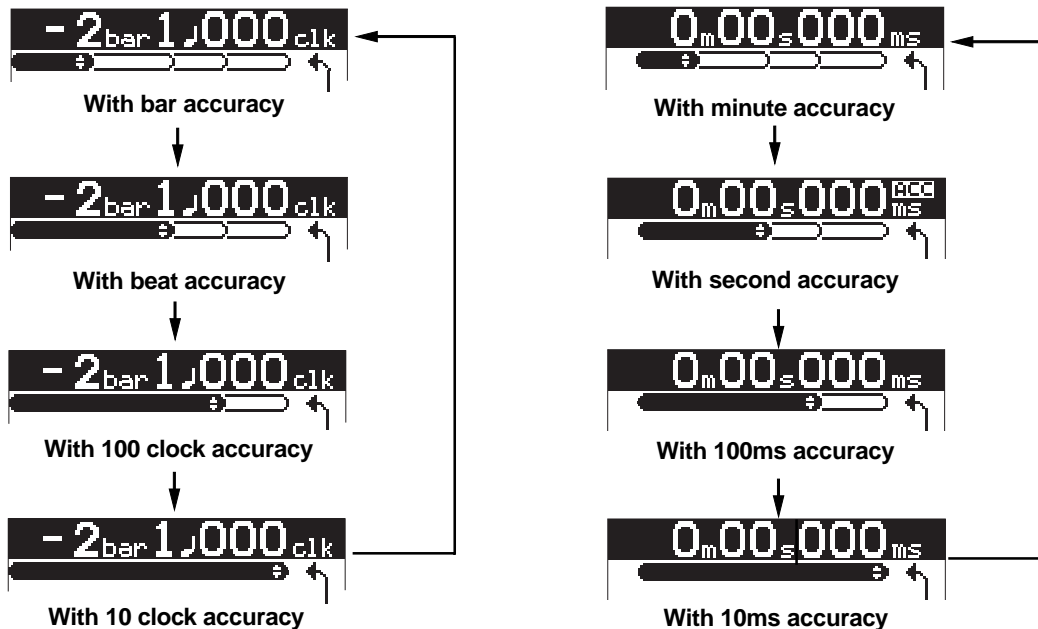

Example of using the direct locate function

Locating the desired bar

During recording process, it often happens that you want to locate the desired bar accurately. For example, let's assume that a vocalist and an operator are working together and they want to make punch-in recording from the beginning of the first bridge. In the typical process, the operator locates the position a few seconds before the first bridge using the [REWIND] or [F FWD] key, and then starts playback from the position and punches in at the beginning of the first bridge. In this manner, the vocalist does not know from where playback starts until it starts. Or he (she) may get lost and miss the punch-in point. If you use the direct locate function, this problem is solved.

In the following procedure, it is assumed that the time base mode is set to "Bar/Beat".

- 1) Press the [DIRECT LOCATE] key to enter the direct locate mode.
- 2) Rotate the [MENU/ENTER] knob to set the locate point to the four bars before the first bridge.
You need to make a note of the bar number of each part.
- 3) Tell the vocalist that the playback starts from four bars before the bridge.
If necessary, you can make rehearsal (see page 58 for rehearsal).
- 4) Press the [STOP] key to exit the direct locate mode and start recording.

<Note>: By setting the locate accuracy to a smaller unit ("bar" or "clock"), you can locate the point more accurately.

Locating the desired time

If you know the time at the point you want to locate, the direct locate function allows you to locate the point accurately by specifying the time.

For example, if you want to locate "12m 34s 540ms" accurately, follow the procedure below. In the following procedure, it is assumed that the time base mode is set to "ABS".

- 1) Press the [DIRECT LOCATE] key to enter the direct locate mode.
- 2) Rotate the [MENU/ENTER] knob to set the "m" field to "12".
- 3) Press the [MENU/ENTER] knob to change the locate accuracy unit to "s".
- 4) Rotate the [MENU/ENTER] knob to set the "s" field to "34".
- 5) Press the [MENU/ENTER] knob to change the locate accuracy unit to "100ms".
- 6) Rotate the [MENU/ENTER] knob to set the "100ms" field to "5".
- 7) Press the [MENU/ENTER] knob to change the locate accuracy unit to "10ms".
- 8) Rotate the [MENU/ENTER] knob to set the "10ms" field to "40".
- 9) Press the [STOP] key to exit the direct locate mode.

Adjusting the counter and setting Locate A and Locate B

There is a case that you need to adjust the counter. That is, when you convert the stereo-mixed audio signals recorded on tracks 15/16 to a stereo WAV file for creating an audio CD, you need to cut the unnecessary parts at the beginning and end. In such a case, you need to adjust the counter after editing.

In the following procedure, it is assumed that the time base mode is set to "Bar/Beat".

- 1) Press the [DIRECT LOCATE] key to enter the direct locate mode.
- 2) Use the [REWIND] key (or the [F FWD] key) to roughly search the beginning (or end) of the song.
- 3) Press the [MENU/ENTER] knob to select the locate accuracy.
- 4) Rotate the [MENU/ENTER] knob to adjust the counter.
You can check the adjustment by preview playback.
- 5) After adjusting the counter, press the [LOCATE A/IN] key (or [LOCATE B/OUT] key) while holding down the [STORE] key to set the Locate A (or Locate B) point.

<Note>: In the direct locate mode, pressing the [REWIND] key (or the [F FWD] key) allows audible cueing.

Previewing the locate point

After executing direct locate function, pressing the **[PLAY]** key (or **[RECORD]** key) plays back two seconds after (or before) the locate point (preview function). The preview time is set to two seconds by default, however, you can set it to a desired time between one and four seconds.

Setting the preview time

While the direct locate screen is shown, each press of the **[PLAY MODE]** key switches the preview time (indicated by an arrow in the screen example below) between "1s", "2s", "3s" and "4s".

Note that the preview time is reset to "2s" when you turn off the unit.

<Note>: You can also change the preview time during preview playback. In this case, the new setting is effective from the next preview playback.



Previewing after the locate point

While the direct locate screen is shown, pressing the **[PLAY]** key executes preview playback from the locate point for a few seconds (set by the preview time).

The display shows "**PREVIEW ->**" during preview playback. To stop preview playback during preview playback, press the **[STOP]** key.



Previewing before the locate point

While the direct locate screen is shown, pressing the **[RECORD]** key executes preview playback from a few seconds (set by the preview time) before the locate point to the locate point. The display shows "**PREVIEW ->**" during preview playback.

To stop preview playback during preview playback, press the **[STOP]** key.



Punch in/out

Using the punch in/out function of the MR16, you can overwrite the desired part of the recorded track. "**Punch in**" means switching from playback to recording, while "**punch out**" means switching from recording to playback. The MR16 offers three methods for making punch in/out recording.

- 1) **Manual punch in/out using the top panel keys**
- 2) **Punch in/out using a footswitch**
- 3) **Auto punch in/out at the specified in/out points**

The following description assumes that the song you are going to make punch in/out recording to is loaded and the preparations for recording is completed.

Punch in/out using the keys on the top panel

You can make punch in/out manually by using the [RECORD] and [PLAY] keys on the MR16 top panel.

<Note>: The punch in/out operation by yourself using the keys on the top panel sometimes prevents you from concentrating on playing. In such a case, ask someone to operate the MR16, or use either of the other two punch in/out methods described later.

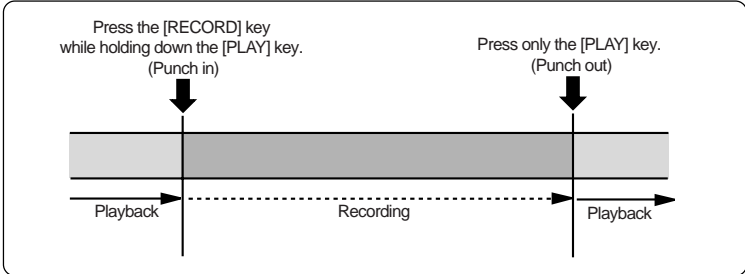
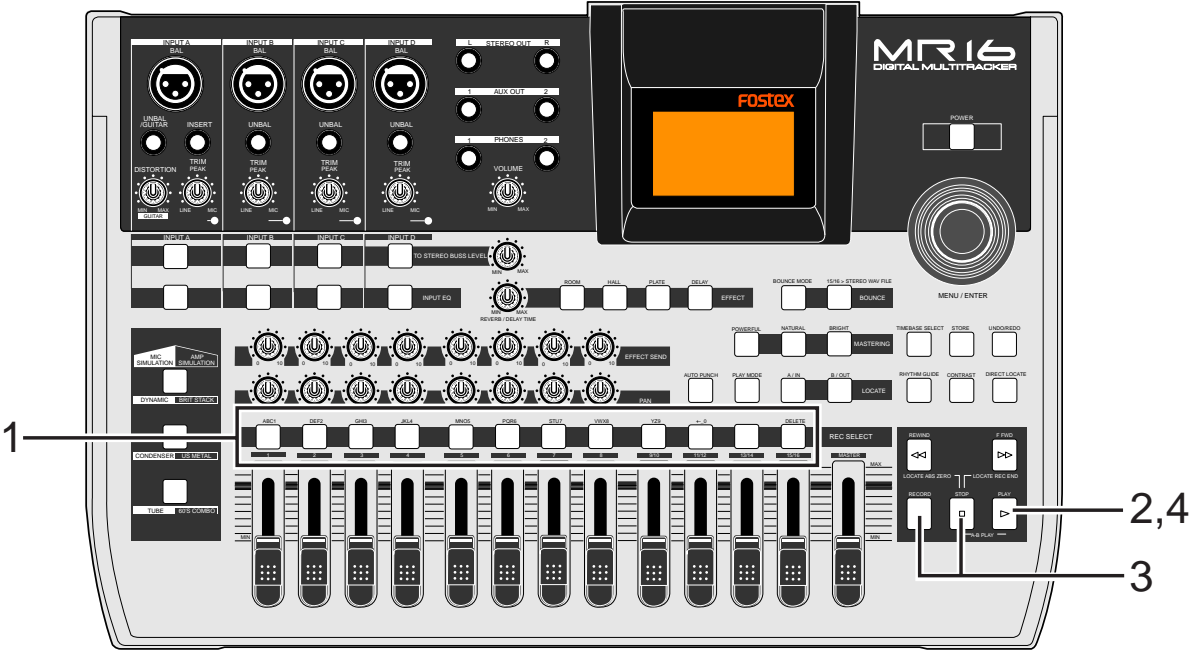

- 1) **Press the [REC SELECT] key for the track you are going to make punch in/out recording.** The track is record-armed.
- 2) **Locate the recorder to the point before the punch-in point and press the [PLAY] key to start playback.**
It may be a good idea to play the instrument along with the playback sound, so that you can get the tempo and feel.
- 3) **When the recorder reaches at the point you want to punch in, press the [RECORD] key while holding down the [PLAY] key (see <Important note>).** The armed track is punched in (i.e. starts recording).

<Important note>
You cannot punch in by only pressing the [RECORD] key. You need to hold down the [PLAY] key when pressing the [RECORD] key.

- 4) **When the recorder reaches at the point you want to punch out, press only the [PLAY] key.** The recorder status switches from recording to playback.
- 5) **Press the [STOP] key to stop the recorder.**
- 6) **Rewind the recorder and play back the part you performed the punch in/out recording to check the result.**
If you are not satisfied with the result, use the undo function to cancel the punch in/out recording and try again.

Punch in/out using the footswitch

You can make hands-free punch in/out recording using an unlatched-type footswitch.

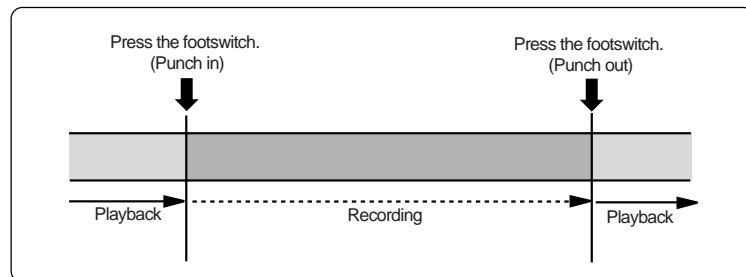
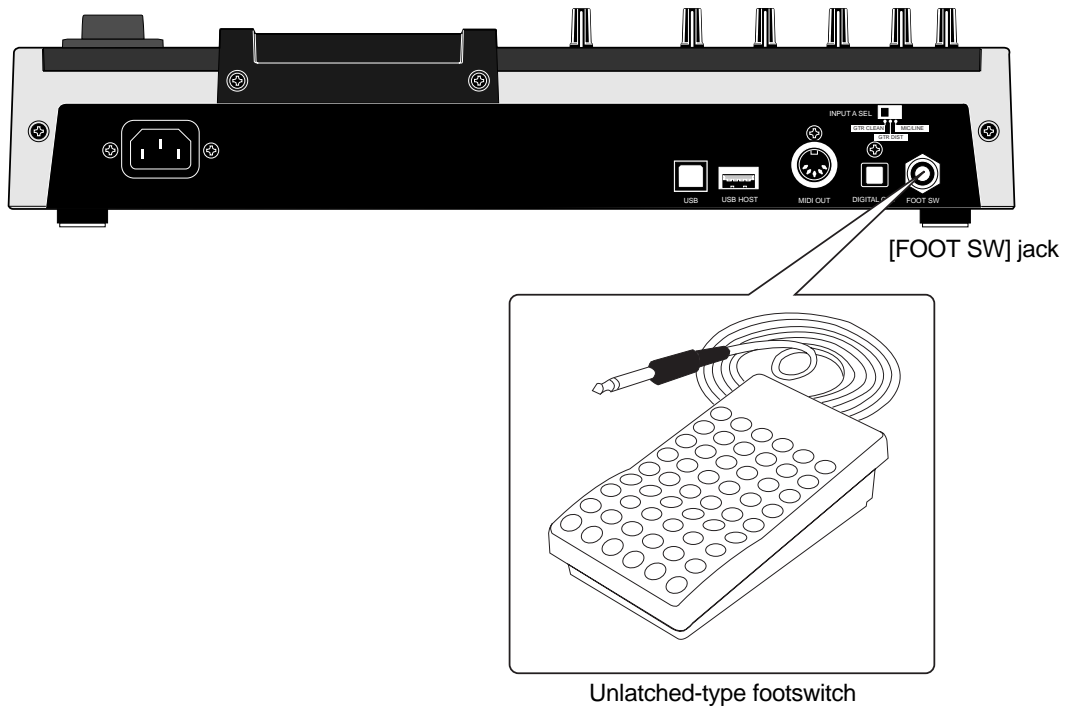

- 1) **Connect the footswitch to the [FOOT SW] jack on the MR16 rear panel.**
- 2) **Press the [REC SELECT] key for the track you are going to make punch in/out recording.**
The track is record-armed.
- 3) **Locate the recorder to the point before the punch-in point, and press the [PLAY] key to start playback.**
It may be a good idea to play the instrument along with the playback sound, so that you can get the tempo and feel.
- 4) **When the recorder reaches at the point you want to punch in, press the footswitch.**
The armed track is punched in (i.e. starts recording).
- 5) **When the recorder reaches at the point you want to punch out, press the footswitch again.**
The recorder status switches from recording to playback.

<Note>: You cannot perform another punch in/out recording successively.
To perform punch in/out recording in another part, stop the recorder and perform the steps above again.

- 6) **Press the [STOP] key to stop the recorder.**
- 7) **Rewind the recorder and play back the part you performed the punch in/out recording to check the result.**
If you are not satisfied with the result, use the undo function to cancel the punch in/out recording and try again.

Auto punch in/out

By setting the punch-in and punch-out points in advance, the recorder automatically makes punch in/out recording for you. You can rehearse punch in/out recording as many times you like.

Setting the punch-in and punch-out points

You can set the punch-in and punch-out points on-the-fly while playing back the recorder (as well as you can set them while the recorder is stopped at the desired position).

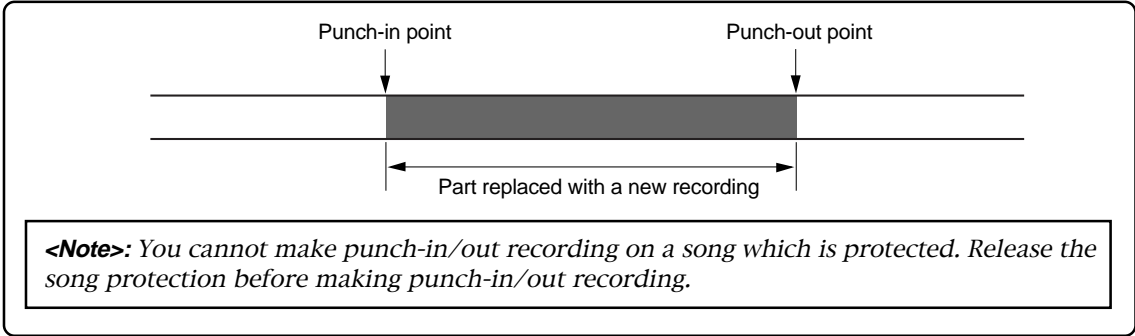

- 1) **Start playback from the beginning of the song (or from a point before the point where you want to make punching in) by pressing the [PLAY] key.**
- 2) **When the recorder reaches at the point where you want to make punching in, press the [LOCATE A/IN] key while holding down the [STORE] key.**
The display briefly shows "Store LOCATE A" and the time data when you press the [LOCATE A/IN] key is set as the punch-in point.

<Note>: If you are not satisfied with the punch-in or punch-out point you set, simply redo the operation above. The new time data overwrites the previous one.

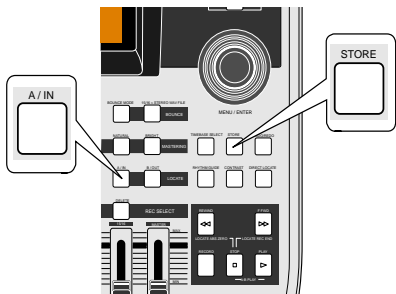

- 4) **Stop the recorder after setting the punch-in and punch-out points, and rewind the recorder to the beginning of the song (or to a point before the point where you want to make punching in).**

<Hint>: To rewind the recorder to the beginning of the song after setting the punch-out point, press the [REWIND] key while holding down the [STOP] key.

To locate before the punch-in point, carry out the following.

- 3) **When the recorder reaches at the point where you want to make punching out, press the [LOCATE B/OUT] key while holding down the [STORE] key.**
The display briefly shows "Store LOCATE B" and the time data when you press the [LOCATE B/OUT] key is set as the punch-out point.

- (1) **While the recorder is stopped, press the [LOCATE A/IN] key.**
The recorder immediately locates to the punch-in point and stops.
 - (2) **Press the [REWIND] key to move back the recorder and press the [STOP] key at the desired point.**

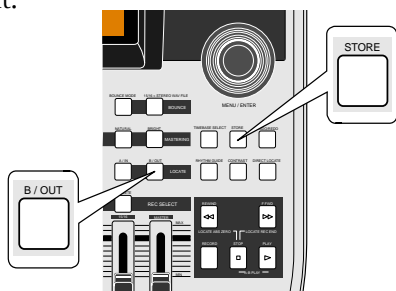

<Hint>: The punch-in and punch-out points you set also can be used for the locate function, playback by the play mode and part editing (see pages 47 and 127).

Rehearsal for auto punch in/out

After setting the punch-in and punch-out points appropriately, you can rehearse the auto punch in/out for checking the punch-in and -out points or practicing punch-in and -out timing.

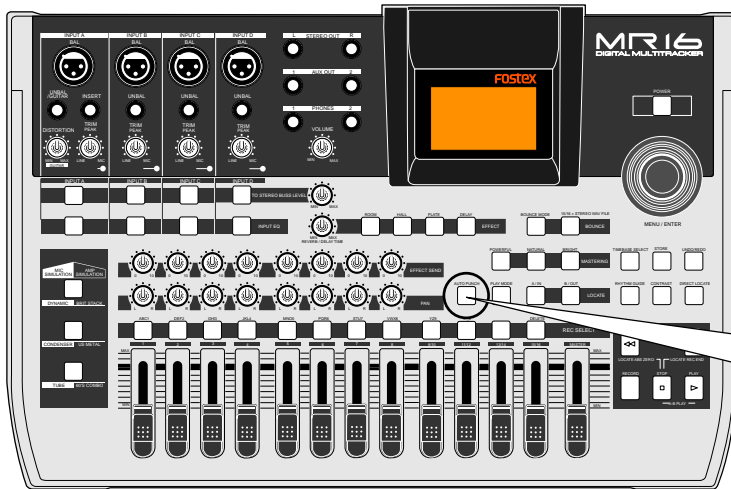

<How to make auto punch in/out mode active>

AUTO PUNCH



Pressing the [AUTO PUNCH] key switches the auto punch in/out mode on or off.

Each press of the [AUTO PUNCH] key turns on or off the indicator.

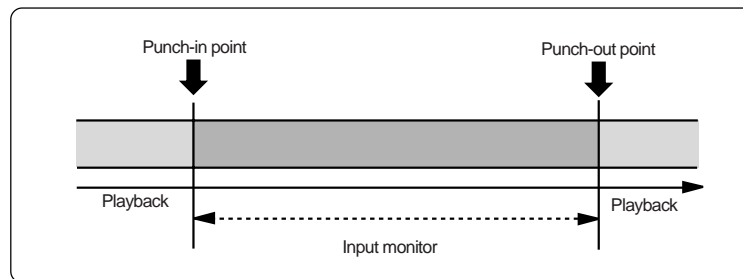

- 1) **Locate the recorder to the point before the punch-in point (or the beginning of the song).**

<Tip>: You can immediately locate to the punch-in point by pressing the [LOCATE A/IN] key. Therefore, by pressing the [LOCATE A/IN] key, followed by the [REWIND] key then the [STOP] key, you can easily locate to the point before the punch-in point.

- 2) **Press the [REC SELECT] key of the track you are going to make punch in/out operation to arm the track.**

- 3) **Press the [AUTO PUNCH] key to make the auto punch mode active.**

The [AUTO PUNCH] key is lit.

- 4) **Press the [PLAY] key.**

In the rehearsal mode, the recorder automatically switches the monitor of the armed track from "repro" to "input" at the punch-in point, but actual recording is not made (the [RECORD] key flashes while "TRF" is shown on the display).

By repeating the operation above, you can practice auto in/out operation as many times as you like.

<Hint>: During rehearsal, "REHE" is lit in the time display section on the screen, so that you can know that the recorder is now in the rehearsal mode.

Now playing back in the rehearsal mode.



Now rehearsing recording.



- 5) **After the punch-out point is passed, locate the recorder back to the beginning position.**

<Note>: By using the loop function when rehearsing the auto punch in/out operation, you can concentrate on playing without the need of troublesome operation of the MR16. See page 49 for details about the loop function.

Actual auto punch in/out

After rehearsing the auto punch-in/out operation, it's time for executing actual auto punch in/out operation.

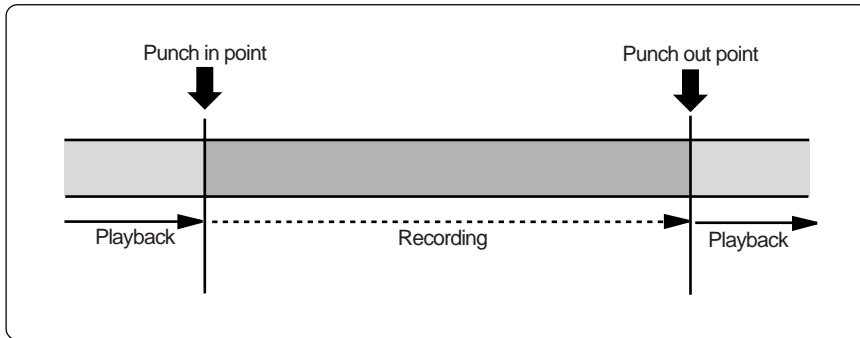

- 1) **Locate the recorder to the point before the punch-in point.**
- 2) **Confirm that the auto punch mode is active.**
If it is not active, press the [AUTO PUNCH] key to make it active.
- 3) **Press the [RECORD] key while holding down the [PLAY] key.**

<Note>: In the rehearsal mode, you press only the [PLAY] key. In the actual auto punch-in operation, make sure to press the [RECORD] key while holding down the [PLAY] key.

Unlike the rehearsal, the recorder automatically starts recording when it reaches the punch-in point, then automatically stops recording and exits the auto punch mode at the punch-out point.

<Hint>: During actual auto punch in/out mode, "TAKE" is lit in the time display section on the screen, so that you can know that the recorder is now in the actual auto punch in/out mode.

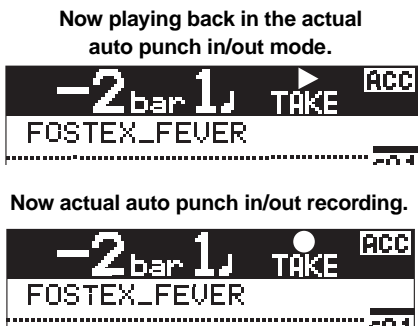

<Note>: You can cancel the auto punch in/out recording you made by pressing the [UNDO/REDO] key.

<Note>: In addition to the punch in/out function, the MR16 allows you to edit the recorded material using the following editing functions.

- Deleting the whole data on the desired track (using the "Erase Track" menu item). See page 120.
- Copying all data on a track and pasting it to another track (using the "Copy Paste Track" menu item). See page 121.
- Moving the desired track data to the other track(s) (using the "Move Track" menu item). See page 123.
- Exchanging all track data between tracks (using the "Change Track" menu item). See page 125.
- Deleting the desired part (using the "Erase Part" menu item). See page 128.
- Pasting the desired part(s) to the other track(s) (using the "Copy Paste Part" menu item or the "Copy Part" and "Paste Part" menu items). See pages 129 and 131.
- Moving the desired part(s) to the other track(s) (using the "Move Part" menu item). See page 134.
- Exchanging parts between tracks (using the "Change Part" menu item). See page 136.

<About "part">: A "part" is defined as audio data between the "LOCATE A" and "LOCATE B" points. Therefore, you have to set the "LOCATE A" and "LOCATE B" points when editing a "part".
The punch-in and punch-out points set for the auto punch in/out function also can be used as the "LOCATE A" and "LOCATE B" points.

Using effects

The MR16 provides the input equalizer and the insert effects for recording (microphone and amplifier simulation effects), the delay/reverb effects for track bounce or mixdown (for tracks 1 through 8 only), and the mastering effects for L/R mix. You can also use an external effect device connected to the **[INSERT]** connector.

Using the input EQ for recording

The MR16 provides the input EQ (equalizer) for each of input channels (A through D). You can apply the input EQ to each recording source to tailor the sound as you wish. You can select a desired setting from among 33 presets in the EQ library.

Turning of the input EQ

To turn on the input EQ for a desired input channel, press the appropriate [INPUT EQ] key. Each press of the [INPUT EQ] key alternates On and Off of the input EQ. When On, the key is lit. When Off, it is unlit.

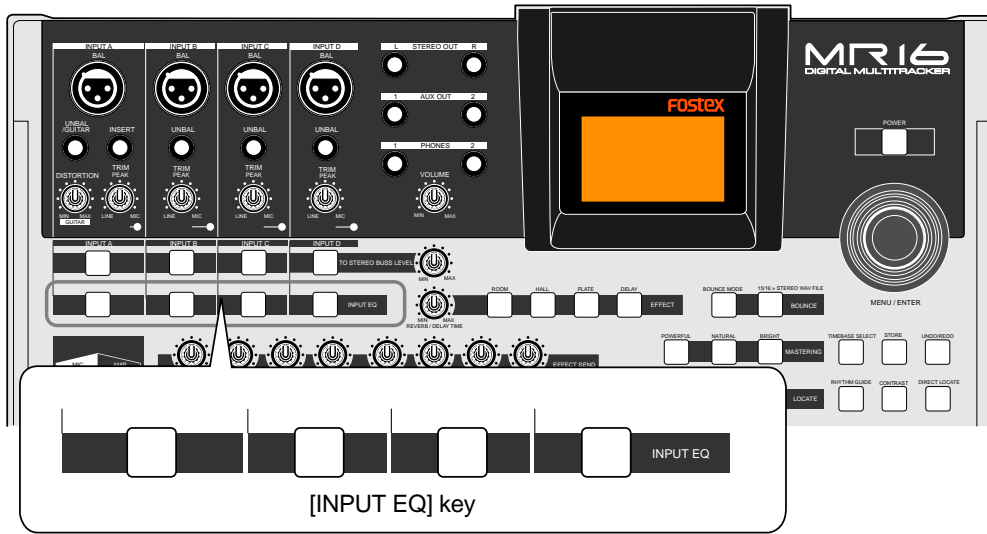

Selecting a desired EQ preset entry

You can select a desired EQ preset in the EQ library by the procedure below. The selected input EQ preset setting is enabled by turning on the [INPUT EQ] key. You can select a desired input EQ preset to each input individually (see the table on the next page for details of EQ library).

- 1) While the recorder is stopped, press and hold the appropriate [INPUT EQ] key for the desired input channel until the "Input" menu screen of the MENU mode is shown on the display. The following shows the screen example which appears by pressing the [INPUT EQ] key for Input A. You can now select a desired EQ preset.

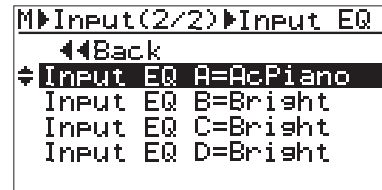
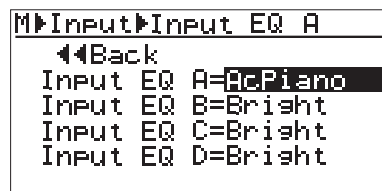
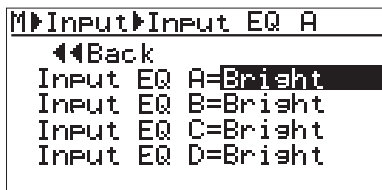

- 2) Rotate the [MENU/ENTER] knob to select the desired EQ preset and press the [MENU/ENTER] knob. The selected EQ preset is applied. The following screen examples show when you select "AcPiano" to Input A.

Execute the similar operations as above for setting EQ for other Inputs.

- 3) Press the [STOP] key to exit the setting screen.

<Hint>: You can also make input EQ setting by the following procedure.

- (1) While the recorder is stopped, press the [MENU/ENTER] knob to enter the MENU mode.
- (2) Rotate the [MENU/ENTER] knob to select "Input" on the second page and press the [MENU/ENTER] knob.
- (3) Use the [MENU/ENTER] knob to select the EQ setting item for the desired input channel and press the [MENU/ENTER] knob.
- (4) Use the [MENU/ENTER] knob to select the desired input EQ preset and press the [MENU/ENTER] knob.
- (5) Press the [STOP] key to exit the MENU mode.

EQ library

<Note>: The contents of EQ library may change with the software upgrade in the future.

L01	Bright	Enhances the brightness of a sound.
L02	Loudness	Enhances the loudness to a sound.
L03	Warm	Adds a warm feel to a sound.
L04	TightDrs	Used for the top microphone for a drum kit. Also used for drum kit channels for stereo mixing. You can get a tight sound by cutting the mid frequency range.
L05	LoudDrums	Used for the top microphone for a drum kit. Also used for drum kit channels for stereo mixing. You can get a natural drum sound by enhancing the low and high frequency ranges moderately.
L06	HeavyKick	Adds thickness.
L07	TightKick	Adds fatness to the low frequency range and emphasizes attack.
L08	NormSnare	Enhances a snappy feel to a snare.
L09	FatSnare	Enhances fatness to a snare, as well as sharpness of high frequency range.
L10	WarmBass	Add warmth to a bass sound.
L11	TightBass	Tightens a bass sound.
L12	AcGuitar	Enhances presence to an acoustic guitar sound.
L13	DistGtr	Adds fatness and presence to a distorted guitar sound.
L14	AcPiano	Good for an acoustic piano in ensemble.
L15	WarmVocal	Adds a warm feel to a vocal.
L16	BrightVoc	Adds brightness to a vocal.
L17	B.G.Vocal	Good for backing vocals.

L18	Narration	Good for narration.
L19	Radio1	Radio sound 1
L20	Radio2	Radio sound 2
L21	Radio3	Radio sound 3
L22	HPF-50	Applies a 50 Hz high-pass filter to cut the unnecessary low frequency range.
L23	HPF-100	Applies a 100 Hz high-pass filter to cut the unnecessary low frequency range.
L24	HPF-160	Applies a 160 Hz high-pass filter to cut the unnecessary low frequency range.
L25	HPF-250	Applies a 250 Hz high-pass filter. Effective for cutting the wind noise.
L26	LPF-12K	Applies a 12 kHz low-pass filter to cut the unnecessary high frequency range.
L27	LPF-6.3K	Applies a 6.3 kHz low-pass filter to cut the unnecessary high frequency range.
L28	HumRmv50	Removes 50 Hz hum noise.
L29	HumRmv60	Removes 60 Hz hum noise.
L30	NoiseRmv1	Removes white noise. Effective for a brighter sound.
L31	NoiseRmv2	Removes white noise. This is stronger than L30. Effective for a too bright sound.
L32	NoiseRmv3	Removes white noise. This is stronger than L31. Effective for a too bright sound.
L33	PhaseInv	Inverts phase. Note that when more than one microphone is used for an instrument, inverting phase may boost the low frequency range.

Using the insert effects for recording

The insert effects can be applied only to the Input A channel.

The insert effects include the mic simulation and amplifier simulation effects, which simulate popular microphones and guitar amplifiers. Depending on the setting of the [INPUT A SEL] switch on the rear panel, the appropriate simulation effect (mic simulation or amplifier simulation) is applied.

If you use the microphone simulation effect when you record an acoustic guitar through your microphone, you can make recording as if you are using a famous microphone. If you use the guitar amplifier simulation effect when you record an electric guitar directly connected to the MR16, you can make recording as if you are using a famous guitar amplifier.

Note that you cannot get exactly the same sound as the original microphone/guitar amplifier by using simulation effects.

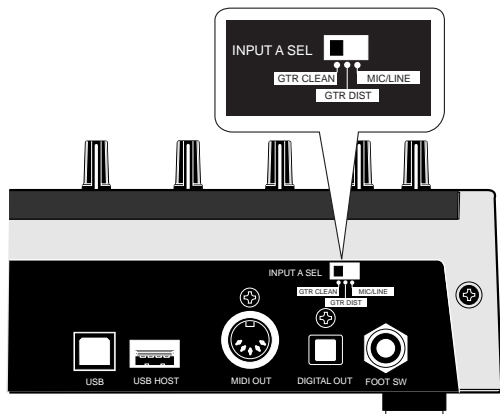

When the mic simulation effect is enabled, you can select the type from DYNAMICS, CONDENSER and TUBE. The key for the selected type is lit.

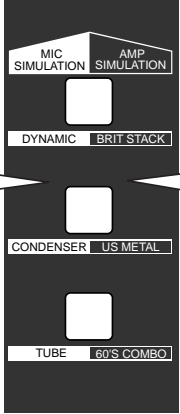

When the amplifier simulation effect is enabled, you can select the type from BRIT STACK, US METAL and 60'S COMBO. The key for the selected type is lit.

Mic simulation effects

You can use mic simulation effects when the [INPUT A SEL] switch on the rear panel is set to "MIC/LINE".

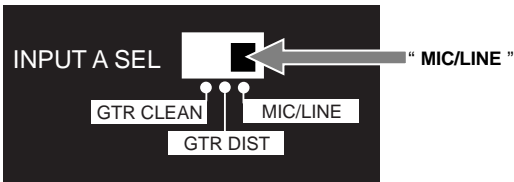

• Details of each mic simulation effect

DYNAMIC	Simulates the sound of a popular dynamic microphone.
CONDENSER	Simulates the sound of a popular condenser microphone for professional use.
TUBE	Simulates the sound of a popular tube microphone for professional use.

Amp simulation effects

You can use mic simulation effects when the [INPUT A SEL] switch on the rear panel is set to "GTR DIST" or "GTR CLEAN". Only when the switch is set to "GTR DIST", you can also use the distortion (adjusted by the [DISTORTION] control), as well as the insert effects.

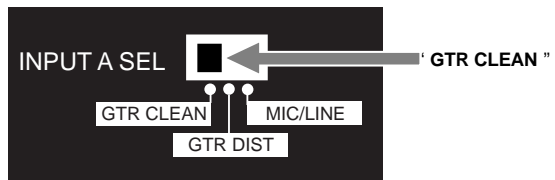
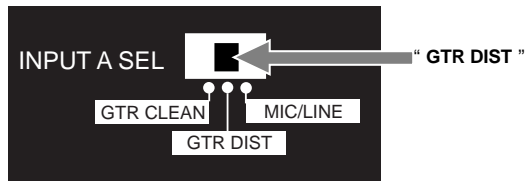

• Amp simulation effects details

BRIT STACK	Simulates a popular British 800-series tube guitar amp head.
US METAL	Simulates a popular US high gain metal guitar amplifier.
60's COMBO	Simulates a popular tube combo guitar amplifier.

Using external effects for recording

During recording, you can apply external effects to a sound source connected to an input connector in the [INPUT A] channel.

The [INPUT A] channel has the [INSERT] connector (phone jack). You can connect an external effect unit (typically, a compressor/limiter) to this connector using a Y-cable, as shown below.

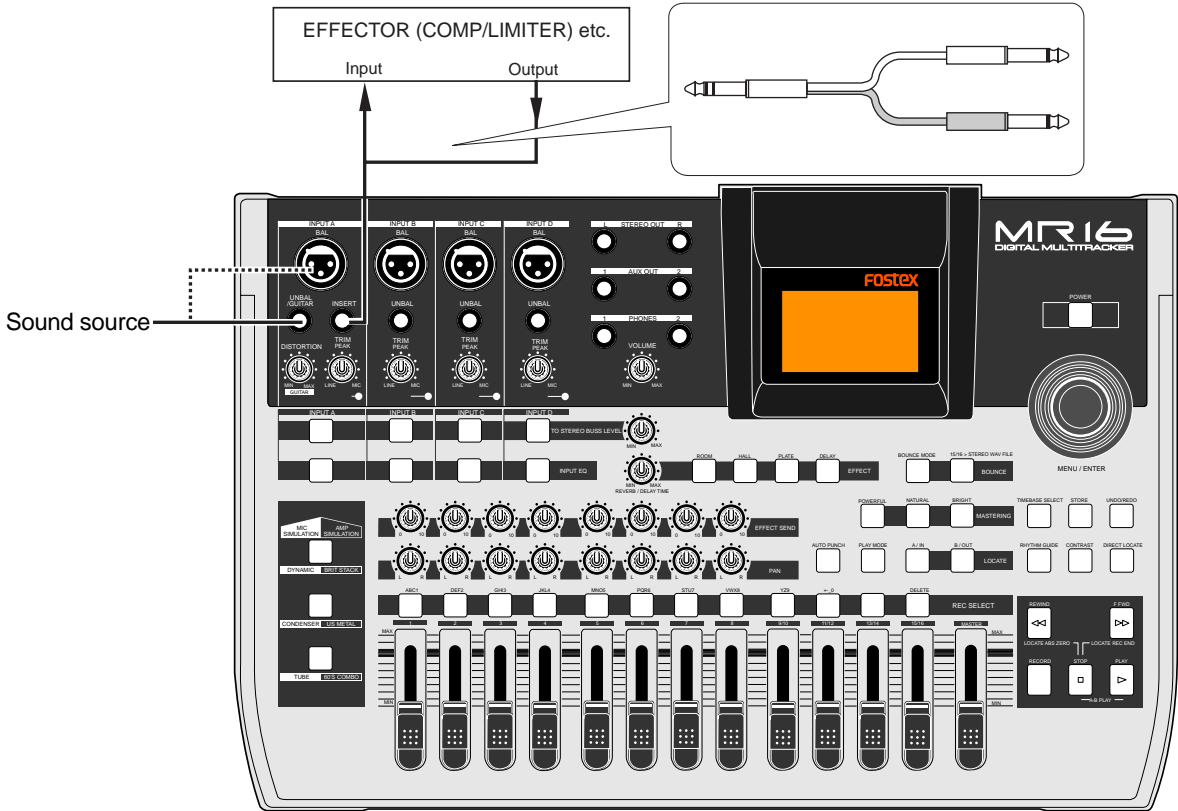

The source (dry) signal fed to the [INPUT A] channel is sent to the external effect unit connected to the [INSERT] connector and the wet (effect) signal returns to the [INPUT A] channel. Thus, you can apply effects to the "INPUT A" signal by connecting an external effect unit.

See the manual of your effect unit for details about how to use it.
A Y-cable is not supplied with the MR16, therefore, purchase an appropriate Y-cable available in the market.

<Hint>: The unit provides two pairs of the [AUX OUT] connectors. During mixdown, you can apply an effect to the desired tracks by connecting an external effect unit to the [AUX OUT] connectors. For details about how to use the [AUX OUT] connectors, see "Application examples" on page 149.

Using the internal reverb or delay

The MR16 has the original built-in reverb/delay processor featuring the newly-developed algorithm. You can apply the reverb or delay to playback signals of tracks 1 through 8 during mixdown and track bouncing.

Selecting an effect type

You can select an effect type from among three reverb options (ROOM, HALL and PLATE) and a delay (DELAY) by using the keys in the [EFFECT] section shown below (the currently selected key is lit).

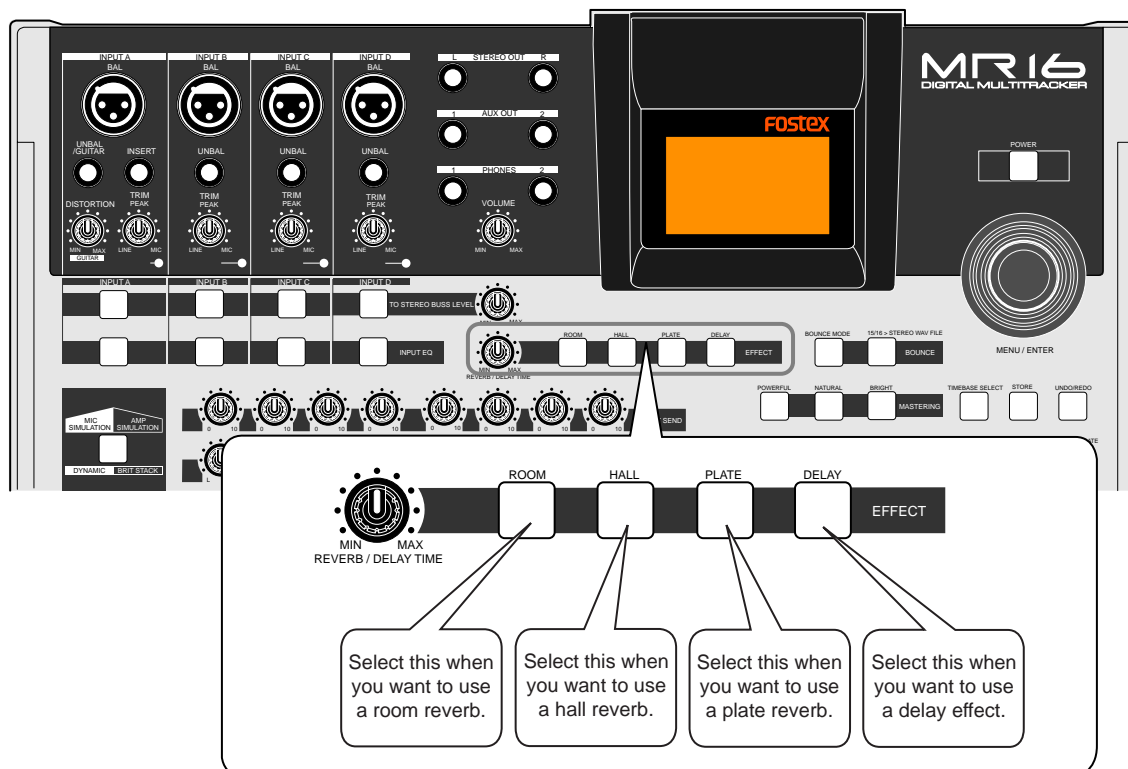

Details of each effect type

ROOM	Simulates reverberation in a medium-sized room. When you select "ROOM", you can adjust the reverb time using the [REVERB/DELAY TIME] control.
HALL	Simulates reverberation in a hall with moderate early reflection. When you select "HALL", you can adjust the reverb time using the [REVERB/DELAY TIME] control.
PLATE	Simulates a plate reverb with a wide frequency range. When you select "PLATE", you can adjust the reverb time using the [REVERB/DELAY TIME] control.
DELAY	<p>Adds delay effects. You can select the desired delay types using the "Delay Type" item of the System menu in the menu mode (you can easily access to the "Delay Type" setting screen by a long press of the [DELAY] key).</p> <p>Three delay types are available: Mono, L-R and Diff. See below for details.</p> <p>When you select "ROOM", you can adjust the delay time using the [REVERB/DELAY TIME] control.</p>

Selecting a delay type

When you use the delay effect, you can select a delay type.

- 1) While the recorder is stopped, press the [MENU/ENTER] knob to enter the menu mode. The display now shows the first page of the menu selection screen, where "◀◀ Back" is highlighted initially.

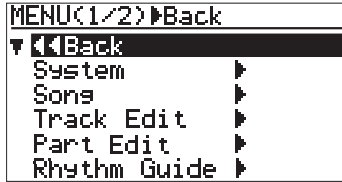

- 2) Rotate the [MENU/ENTER] knob to select "System ▶", and press the [MENU/ENTER] knob. The display now shows the system menu screen, where "◀◀ Back" is highlighted.

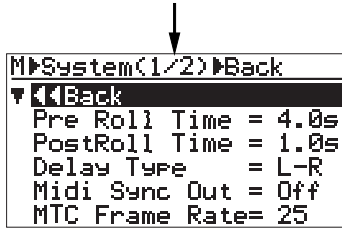
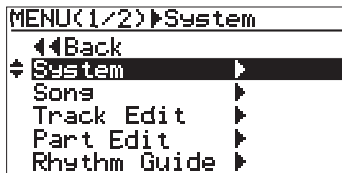

- 3) Rotate the [MENU/ENTER] knob to select "Delay Type" and press the [MENU/ENTER] knob.

The current delay type starts flashing and you can now select from among three options shown below ("L-R" is initially selected).

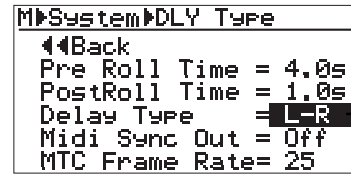
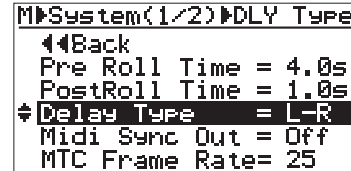

You can choose from among the following three delay types.

L - R	L-R delay (default)
Mono	Mono delay
Diff	Diffusion delay

- 4) Rotate the [MENU/ENTER] knob to select the desired delay type and press the [MENU/ENTER] knob. The selected delay type is set, while the display returns to the previous screen.
- 5) Press the [STOP] key to quit the menu mode.

Adjusting the delay/reverb time

You can adjust the reverb time or delay time using the [REVERB/DELAY TIME] control, depending on the selected effect type.

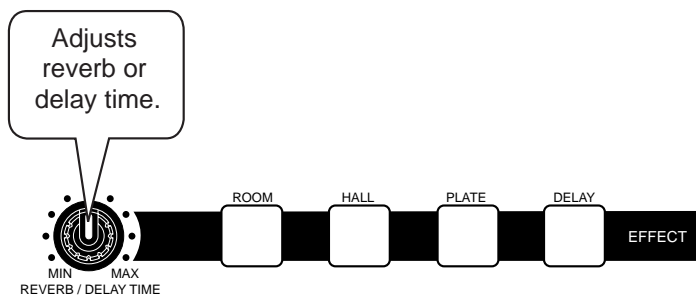

HALL	Adjusts the reverb time within the range between 1.0 s and 6.0 s (center position: 3.0 s)
ROOM	Adjusts the reverb time within the range between 0.1 s and 2.0 s (center position: 1.0 s)
PLATE	Adjusts the reverb time within the range between 0.5 s and 4.0 s (center position: 2.0 s)
DELAY	Adjusts the delay time within the range between 100 ms to 1000 ms (center position: 300 ms)

Adjusting the effect send levels

To apply the effect (reverb or delay) to tracks 1 through 4, adjust the [EFFECT SEND] control for each track to adjust the level of the track signal sent to the effect processor.

In the example as illustrated below, tracks 1 and 2 signals are sent to the effect processor.

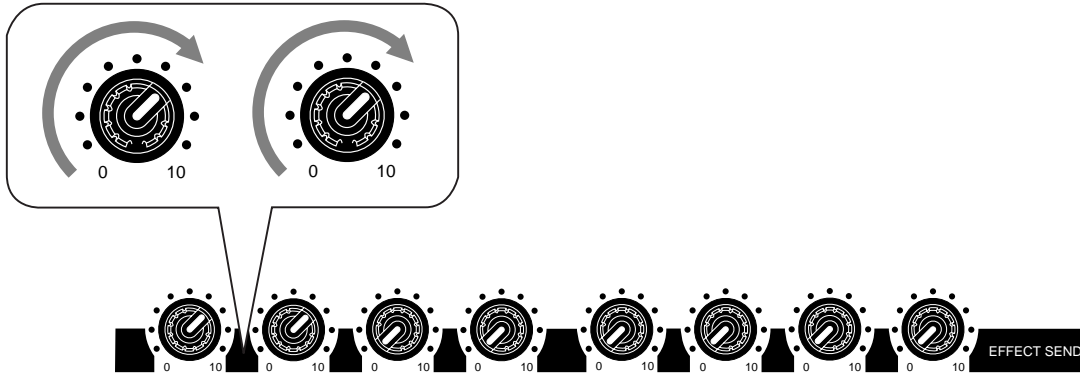

As shown in the signal flowchart below, a track (playback) signal after the track fader is fed to the [EFFECT SEND] control and adjusted, then fed to the effect processor input.

The effect processor's stereo output signals (wet signals) and stereo (L/R) signals (dry signals) are merged together and then output from the [STEREO OUT L, R] jacks.

As you can see in the flowchart below, the signal sent to the effect processor is affected by the track fader (i.e. a track fader must be raised to send track signal to the effect processor). The signal which passes through a fader is generally called a "post fader signal".

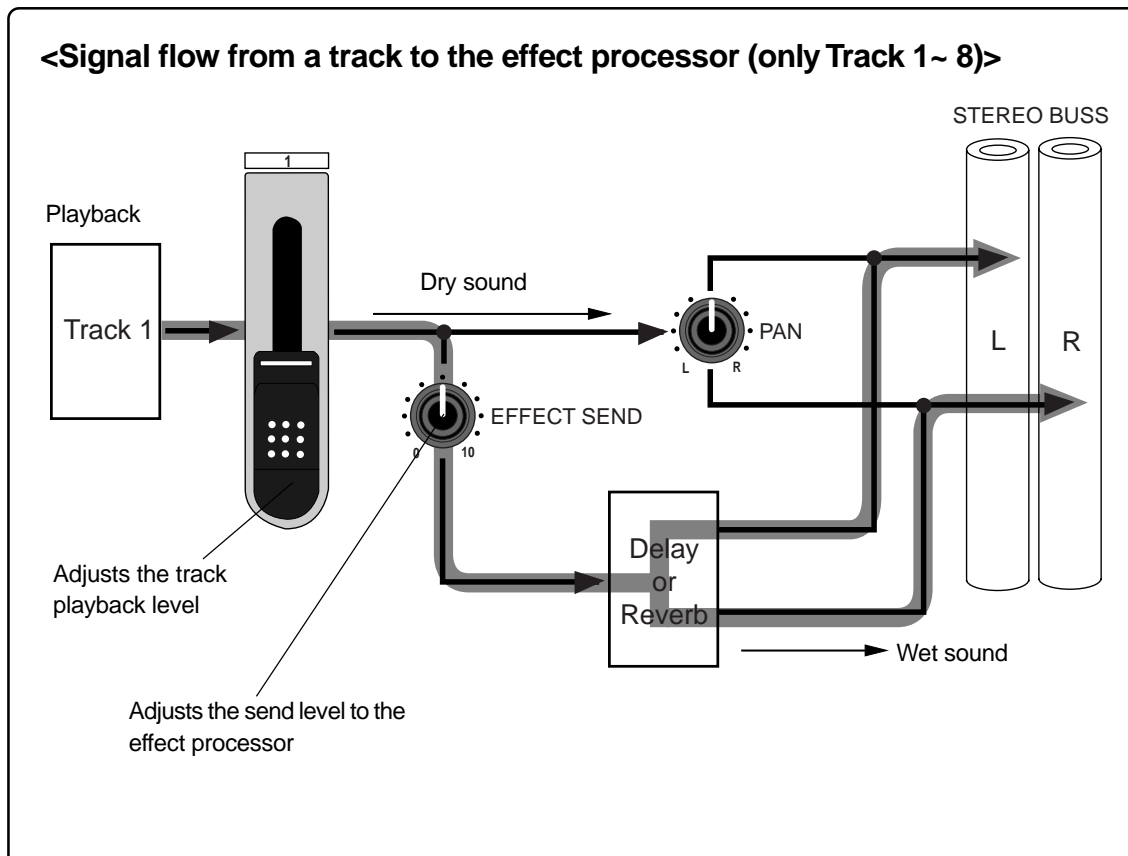

Using the mastering effects

The MR16 provides the mastering effects dedicated for the stereo buses (L and R). You can select the desired effect type using the [MASTERING] keys. The mastering effect can be used when you bounce multiple tracks to two tracks or when you mix tracks 1 through 16 down to stereo and record to an external master recorder.

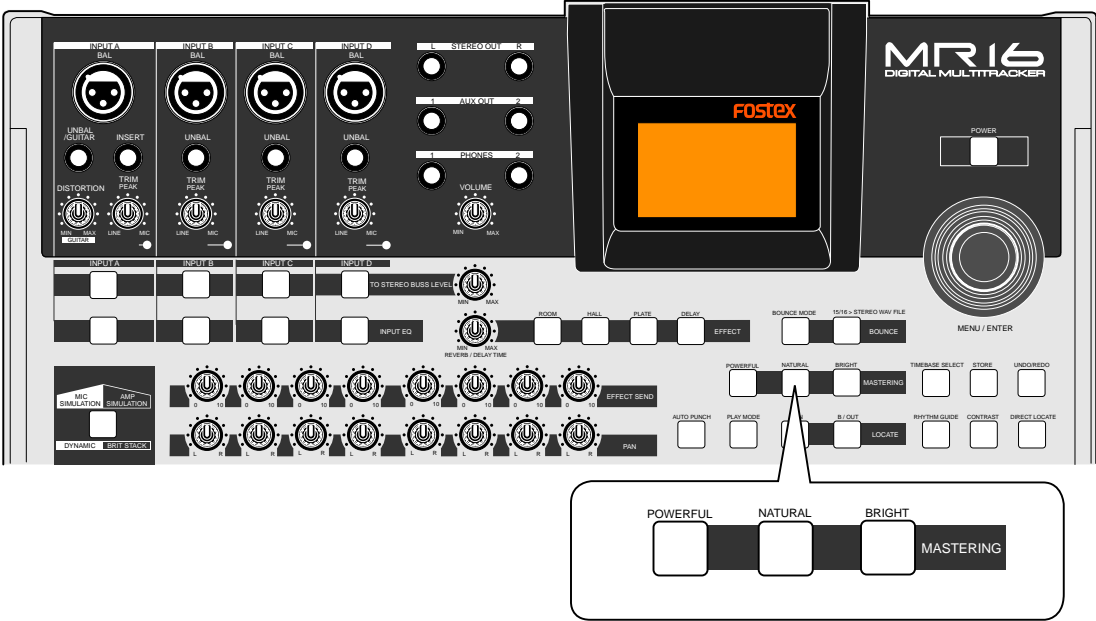

<Bouncing tracks 1 through 8 to tracks 9/10>

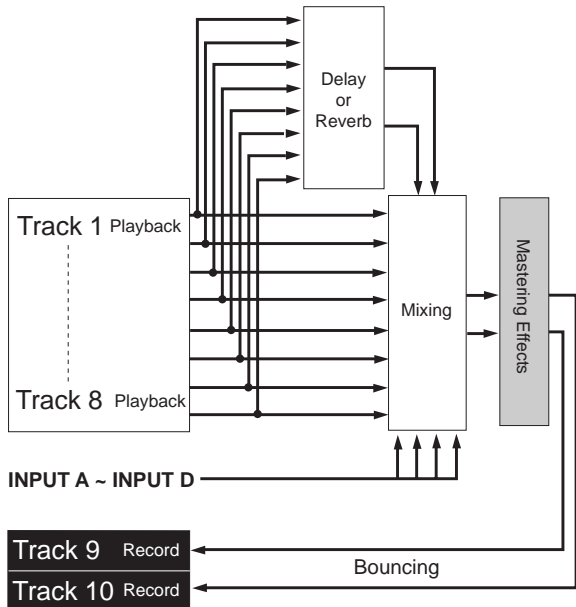

<Bouncing tracks 1 through 14 to tracks 15/16>

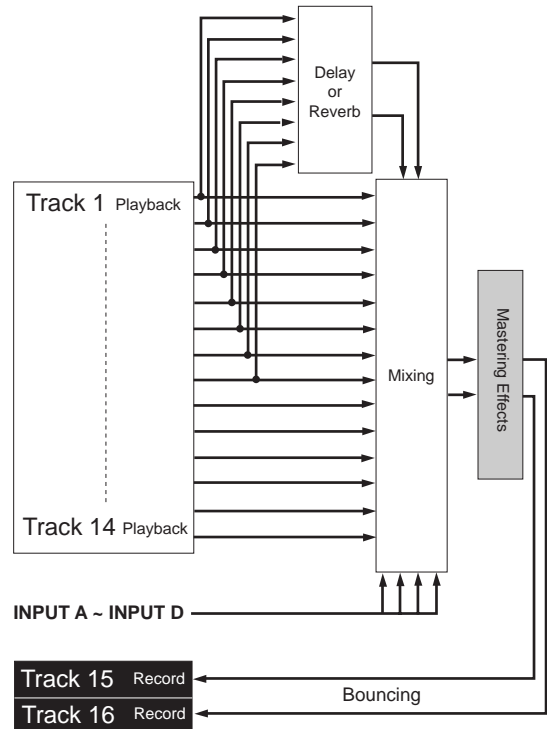

In addition to the bouncing examples above, you can also apply the mastering effects in the "Bounce 1-10 >11/12" and "Bounce 1-12 >13/14" mode.

Bouncing tracks 1 through 16 to a New song.

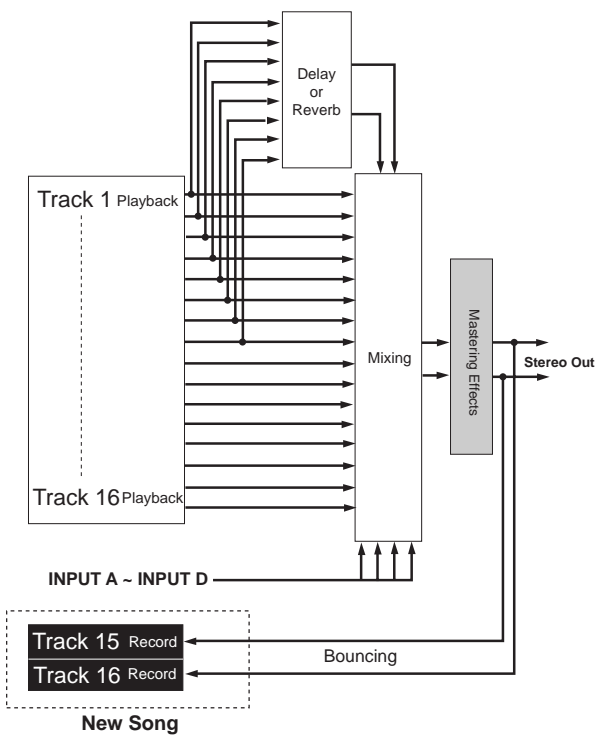

Mixing tracks 1 through 16 down

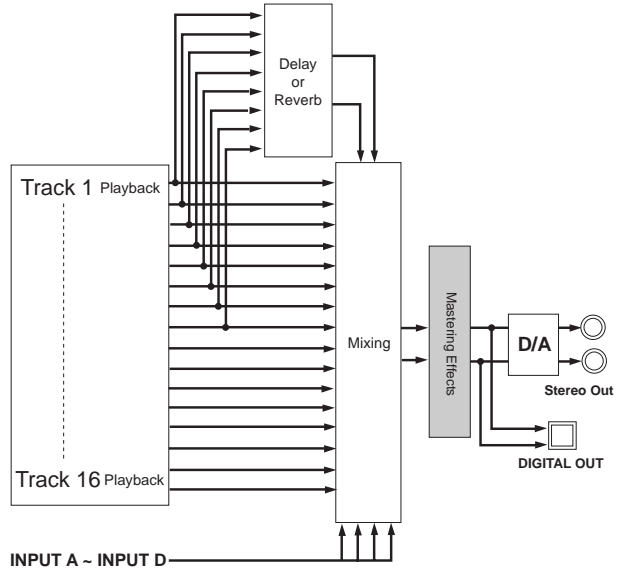

See "Track bounce" on page 75 for details about track bounce which allows mixing multiple tracks to stereo. See "Mixdown" on page 43 for details about mixdown.

Selecting the desired effect type

Three mastering effect types are available. You can select the desired type using the [MASTERING] keys (POWERFUL, NATURAL and BRIGHT).

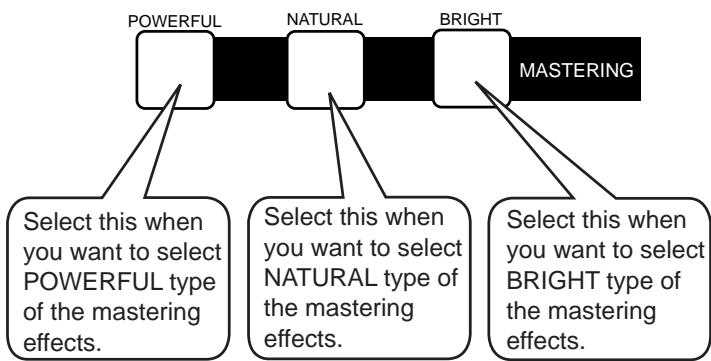

Each effect type has the following character. Select the appropriate type.

POWERFUL	Adds power to the sound. Good for rock.
NATURAL	Slightly adds power to the sound. Good for acoustic music.
BRIGHT	Add brightness to the sound. Good for use when the mixed sound is dark.

<Note>: By activating the mastering effect, the output level raises. Therefore, be careful of the level change when monitoring via headphones or monitor speakers, as well as when adjusting the recording level of an external recorder.

Track bouncing

This chapter describes track bouncing which is an important function in the recording process.

The track bouncing mixes several tracks and records onto other two tracks. By using this function, you can record more sound materials to the MR16 tracks.

Five track bouncing modes are available:

- (1) Bouncing tracks 1 through 8 to tracks 9/10.**
- (2) Bouncing tracks 1 through 10 to tracks 11/12.**
- (3) Bouncing tracks 1 through 12 to tracks 13/14.**
- (4) Bouncing tracks 1 through 14 to tracks 15/16.**
- (5) Bouncing tracks 1 through 16 to tracks 15/16 of a new song.**

In any mode, you can apply a reverb (or delay) to tracks 1 through 8 when bouncing to two tracks in stereo. Furthermore, you can apply the mastering effect to the mixed signals.

You can also execute track bouncing while mixing sound sources from inputs A through D.

The mixed data (stereo song data) bounced to tracks 15/16 can be converted to a stereo WAV file and export to a PC for burning an audio CD (CD-DA).

Preliminary knowledge

Before executing track bouncing, read "Track bouncing example" below and "Track bouncing signal flow" on the next page.

Track bouncing example

You can record more than sixteen materials using the track bouncing function as shown in the following example.

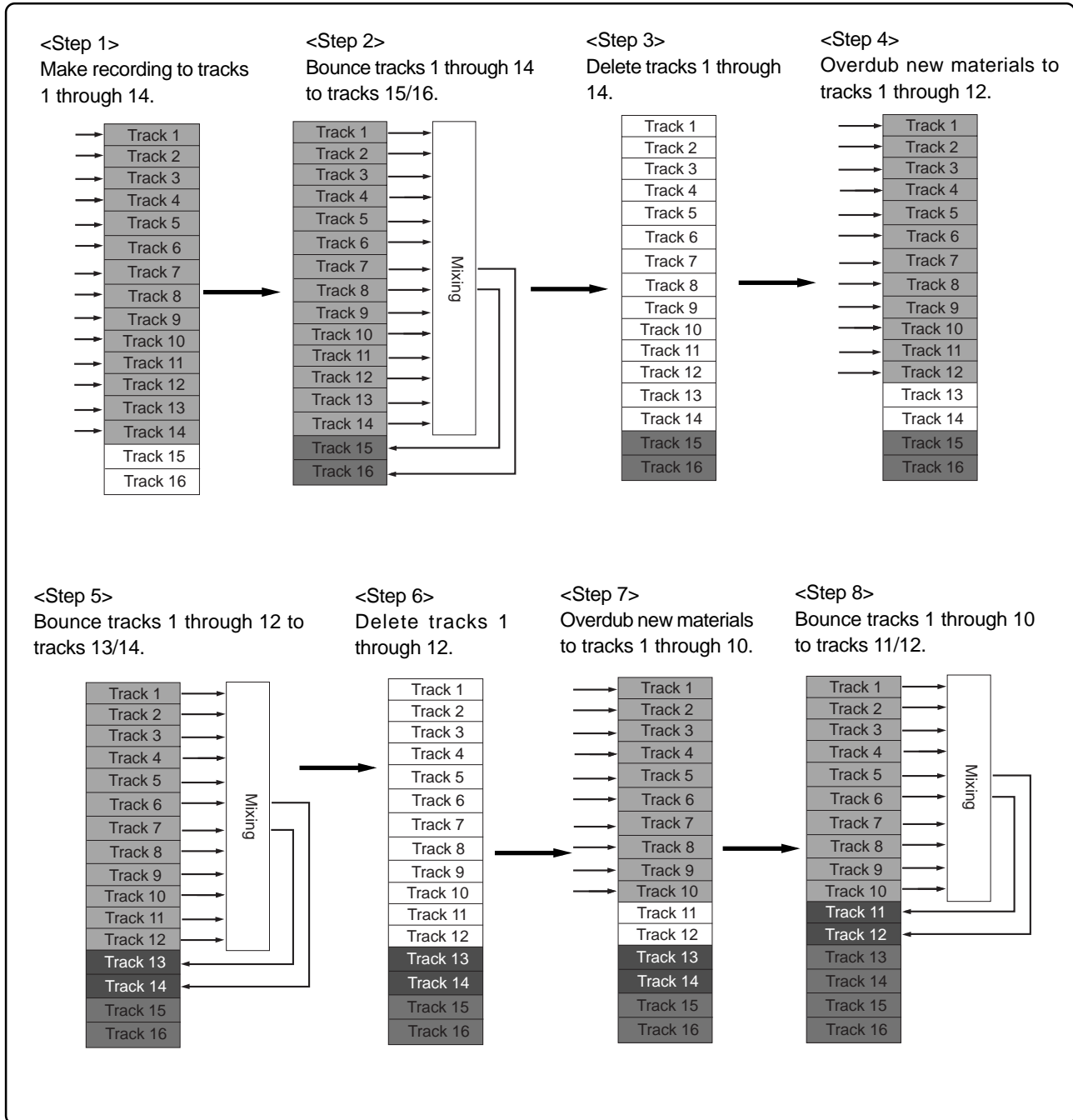

Track bouncing modes

The five track bouncing modes described below are available.

"1-8 > 9/10" mode

In the "1-8 > 9/10" mode, tracks 1 through 8 are played back, mixed down to stereo, and bounced to tracks 9/10. You can apply a reverb (or delay) to tracks 1 through 8, as well as apply the mastering effect to the mixed signals.

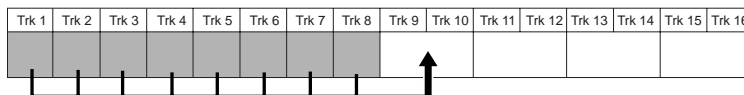

"1-10 > 11/12" mode

In the "1-10 > 11/12" mode, tracks 1 through 10 are played back, mixed down to stereo, and bounced to tracks 11/12. You can apply a reverb (or delay) to tracks 1 through 8, as well as apply the mastering effect to the mixed signals.

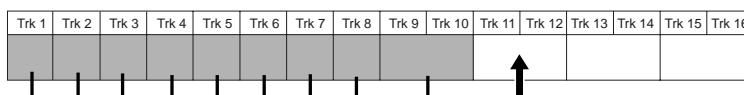

"1-12 > 13/14" mode

In the "1-12 > 13/14" mode, tracks 1 through 12 are played back, mixed down to stereo, and bounced to tracks 13/14. You can apply a reverb (or delay) to tracks 1 through 8, as well as apply the mastering effect to the mixed signals.

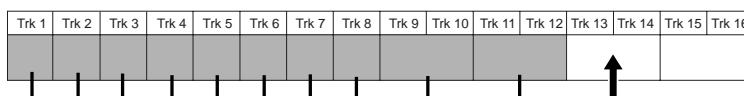

"1-14 > 15/16" mode

In the "1-14 > 15/16" mode, tracks 1 through 14 are played back, mixed down to stereo, and bounced to tracks 15/16. You can apply a reverb (or delay) to tracks 1 through 8, as well as apply the mastering effect to the mixed signals. You can convert song data bounced to tracks 15/16 to a stereo WAV file, which can be burned to an audio CD.

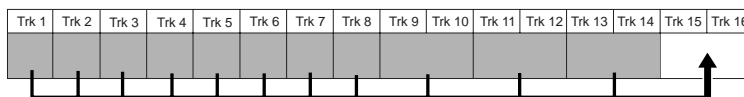

"1-16 > New Song" mode

In the "1-16 > New Song" mode, tracks 1 through 16 are played back, mixed down to stereo, and bounced to tracks 15/16 of the new song which is automatically created. By using this mode, you can create a master song in the MR16 itself without the need of using an external master recorder. You can apply a reverb (or delay) to tracks 1 through 8, as well as apply the mastering effect to the mixed signals. You can convert song data bounced to tracks 15/16 of the new song to a stereo WAV file, which can be burned to an audio CD.

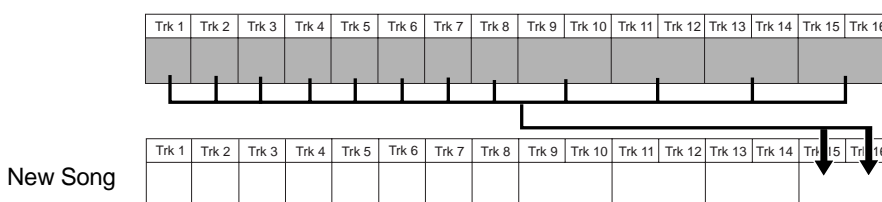

Selecting the track bouncing mode

You can select the desired track bouncing mode from among the five modes by pressing the [BOUNCE MODE] key.

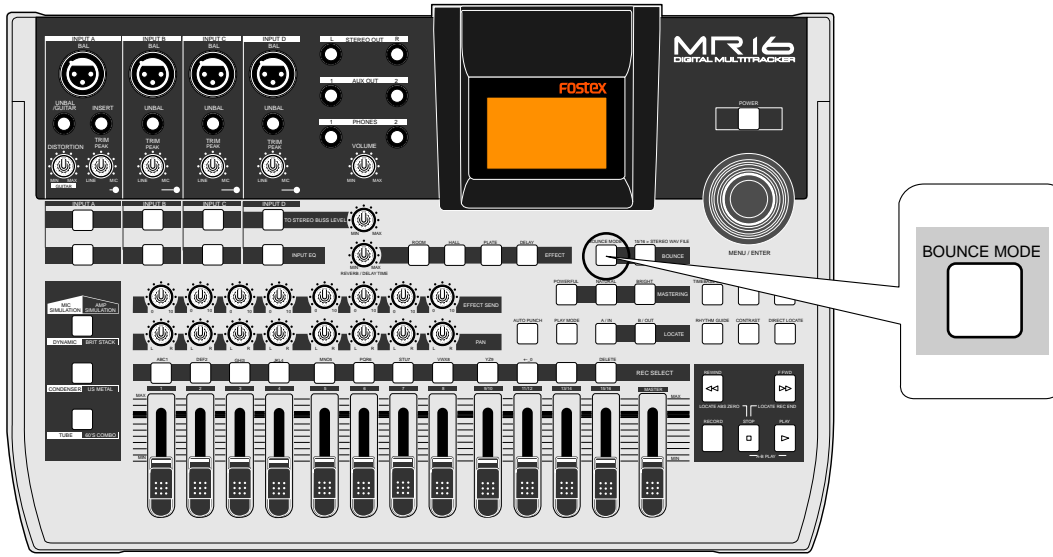

While the recorder is stopped, each press of the [BOUNCE MODE] key switches the bouncing mode. The display shows the appropriate screen for the selected mode, while the [REC SELECT] keys for the bounced tracks start flashing and the input monitor mode is enabled.

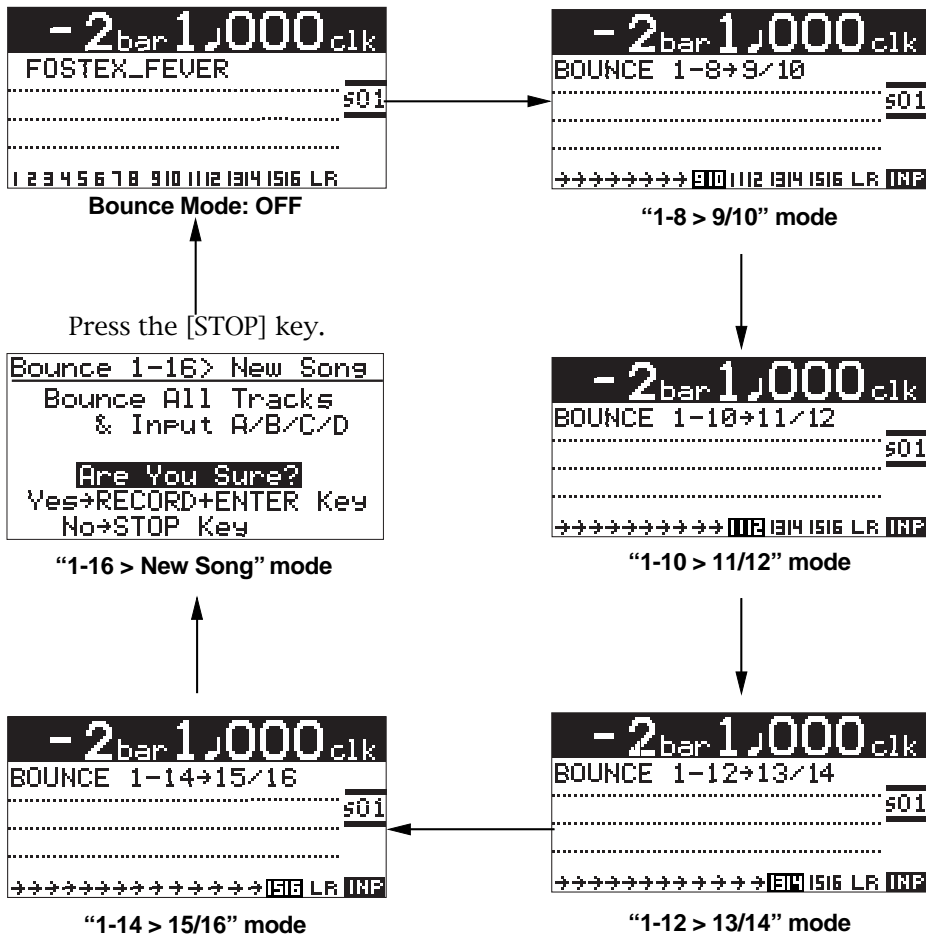

Bounce tracks 1 through 14 to tracks 15/16

The following describes how to mix tracks 1 through 14 and bounce to tracks 15/16 of the current song.

You can bounce tracks 1 through 8 to tracks 9/10, tracks 1 through 10 to tracks 11/12, tracks 1 through 12 to tracks 13/14 in the similar manners.

Before executing actual track bouncing, we recommend you to rehearse the bouncing operation repeatedly until you are satisfied with the setting of the level and balance of each playback track, as well as delay/reverb setting for tracks 1 through 8.

<Using track data bounced to tracks 15/16>

By converting track data (a pair of mono WAV files) bounced to tracks 15/16 to a stereo WAV file, you can export it to a PC or burn it to an audio CD using the internal or external CD-R/RW drive.

For details about exporting a WAV file to a PC, see page 107. For details about creating an audio CD using the internal or external CD-R/RW drive, see the "How to use the CD-R/RW drive" supplementary manual.

Rehearsal of track bouncing

Before executing track bouncing, you can rehearse it. While rehearsing track bouncing, you can control the playback level, panning and reverb (or delay) send setting of each source track, as well as apply the mastering effect to the mixed L/R signals. We recommend to make rehearsal thoroughly until you are satisfied with the sound. The following assumes that the song you are going to execute track bouncing is loaded.

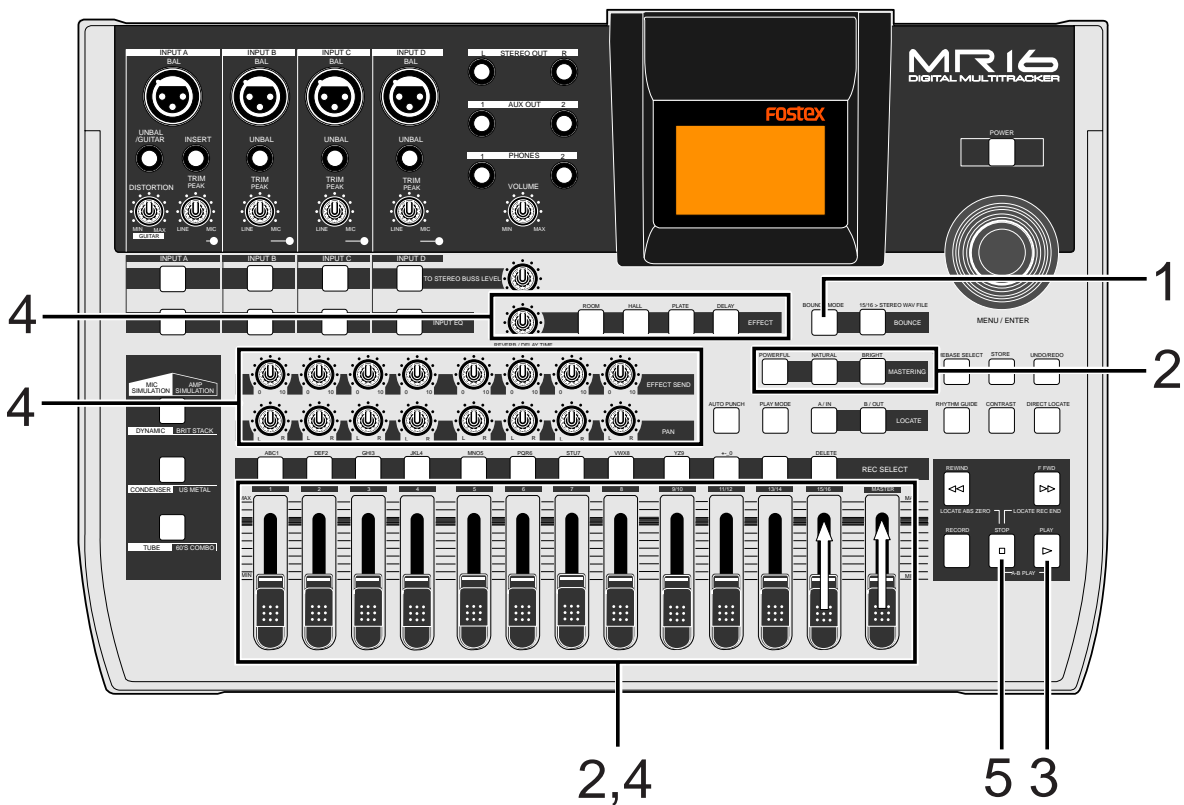

- 1) **Use the [BOUNCE MODE] key to select the "1-14 > 15/16" bounce mode.**
 Selecting this bounce mode automatically arms tracks 15/16 and changes the monitoring mode for these tracks to input monitoring mode. The display looks like this:

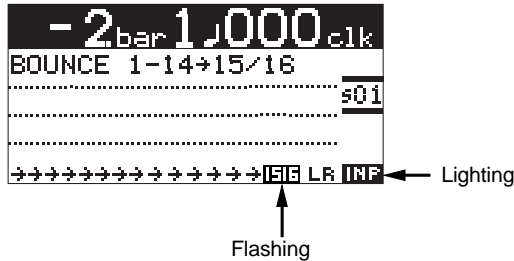

- 2) **Raise the [9/10] fader and [MASTER] fader to the "≡" position. Set all the other track faders down to the minimum position.**
- 3) **Press the [PLAY] key to start playback from the beginning of the song.**
- 4) **While playing back the song, adjust playback levels of tracks 1 through 14 using the track faders.**

You can apply the delay/reverb to tracks 1 through 8 and the mastering effects to the stereo L and R signals. See "Using effects" on page 65 for details about the delay/reverb and mastering effects.

<Panning control>
 You can freely adjust panning for tracks 1 through 8 using the PAN controls. For example, a guitar to left, a vocal to center, etc.

By raising the [PHONES VOL] control, you can hear the signals bounced to tracks 15/16.

Use the [15/16] fader to control the monitor output levels, and use the [MASTER] fader to adjust the recording levels of the bounced signals appropriately while checking meters 15/16.

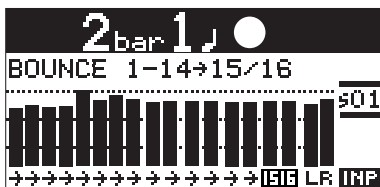

- 5) **After finishing rehearsal, press the [STOP] key to stop the recorder and locate it to the beginning of the song.**
 Do not move the controls and faders after finishing rehearsal.

During rehearsal and actual track bouncing, the track faders and [MASTER] fader control the following signals.

Faders 1 through 14	Playback levels of tracks 1 through 14 for bouncing.
Fader 15/16	Monitor levels of tracks 15/16.
[MASTER] fader	Recording master level of tracks 15/16.

During rehearsal and actual track bouncing, level meters on the screen show the following signal levels.

Meters 1 through 14	Playback levels of tracks 1 through 14.
Meters 15/16	Recording levels of tracks 15/16.
Meters L and R	Monitor output levels of STEREO OUT (L, R).

The following tables show the signals controlled by the faders and the levels displayed by the meters in other track bouncing modes.

• In the "1-8 > 9/10" mode

Faders 1 through 8	Playback levels of tracks 1 through 8 for bouncing.
Fader 9/10	Monitor levels of tracks 9/10.
[MASTER] fader	Recording master level of tracks 9/10.

Meters 1 through 8	Playback levels of tracks 1 through 8.
Meters 9/10	Recording levels of tracks 9/10.
Meters L and R	Monitor output levels of STEREO OUT (L, R).

• In the "1-10 > 11/12" mode

Faders 1 through 10	Playback levels of tracks 1 through 10 for bouncing.
Fader 11/12	Monitor levels of tracks 11/12.
[MASTER] fader	Recording master level of tracks 11/12.

Meters 1 through 10	Playback levels of tracks 1 through 10.
Meters 11/12	Recording levels of tracks 11/12.
Meters L and R	Monitor output levels of STEREO OUT (L, R).

• In the "1-12 > 13/14" mode

Faders 1 through 12	Playback levels of tracks 1 through 12 for bouncing.
Fader 13/14	Monitor levels of tracks 13/14.
[MASTER] fader	Recording master level of tracks 9/10.
Meters 1 through 12	Playback levels of tracks 1 through 12.
Meters 13/14	Recording levels of tracks 13/14.
Meters L and R	Monitor output levels of STEREO OUT (L, R).

Actual track bouncing

After finishing rehearsal, let's carry out actual track bouncing. Make sure that the recorder stops at the beginning of the song.

- 1) **Before carrying out actual track bouncing, make sure that the bounce mode is selected to "1-14 > 15/16".**
- 2) **Press the [PLAY] key while holding down the [RECORD] key.**
Track bouncing starts with the effect/level settings made in the rehearsal mode. The mixed signals are recorded onto tracks 15/16.
- 3) **After track bouncing completes, press the [STOP] key to stop the recorder.**

Stopping the recorder automatically turns off the input monitoring mode of tracks 15/16, while the display changes to show the screen below, prompting you to play back tracks 15/16 for confirming the result.

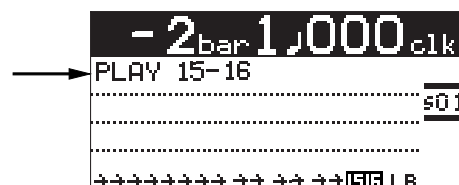

Checking the bounced signals on tracks 15/16

You can check the bounced signals while the bounce mode is active.

- 1) **Press the [REWIND] key while holding down the [STOP] key to locate the recorder to the beginning of the song.**
- 2) **Make sure that the input monitoring mode is turned off.**
- 3) **Press the [PLAY] key to start playback from the beginning of the song.**
- 4) **Use the [15/16] fader to control the playback level of the bounced signals.**
By playing back the recorder while the bounce mode ("1-14 > 15/16") is active, only tracks 15/16 can be monitored.

If you want to redo track bouncing, use the undo function to go back to the condition before carrying out track bouncing, and try again.

<Auto punch in/out of track bouncing>
You can bounce only the desired part (between the IN and OUT points) using the auto punch in/out function (see page 87).

<Track bouncing while mixing signals from [INPUT A] through [INPUT D]>
When you bounce tracks 1 through 8 to tracks 9/10, you can also mix signals from [INPUT A] through [INPUT D] together (see page 85).

In this condition, you cannot monitor playback signals of tracks 1 through 14 even if you raise their faders.

Bouncing tracks 1 through 16 to a new song

You can bounce tracks 1 through 16 to tracks 15/16 of a new song. A new song is automatically created when executing track bouncing (<Note>: In the "1-16 > NEW SONG" mode, you cannot bounce the desired part of a song by using the track bouncing and auto punch in/out functions together).

<Using bounced track data>
 By converting bounced track data (in two mono WAV files) to a stereo WAV file, you can export it to a personal computer or create an original audio CD using the internal (or an external) CD-R/RW drive. See page 107 for details about how to export a file to a personal computer. See the supplementary manual "How to use the CD-R/RW drive" for details about burning an audio CD using the internal (or an external) CD-R/RW drive.

<Hint>: When bouncing tracks to a new song, the settings for the following parameters are copied to the new song.
Rhythm guide On/Off, Internal click level, Signature, Tempo, Conductor map On/Off, Signature map, Tempo map, Bar offset, Locate A point, Locate B point

Rehearsal of track bouncing

Before executing track bouncing, you can rehearse it. While rehearsing track bouncing, you can control the playback level, panning and reverb (or delay) send setting of each source track, as well as apply the mastering effect to the mixed L/R signals. We recommend to make rehearsal thoroughly until you are satisfied with the sound. The following assumes that the song you are going to execute track bouncing is loaded.

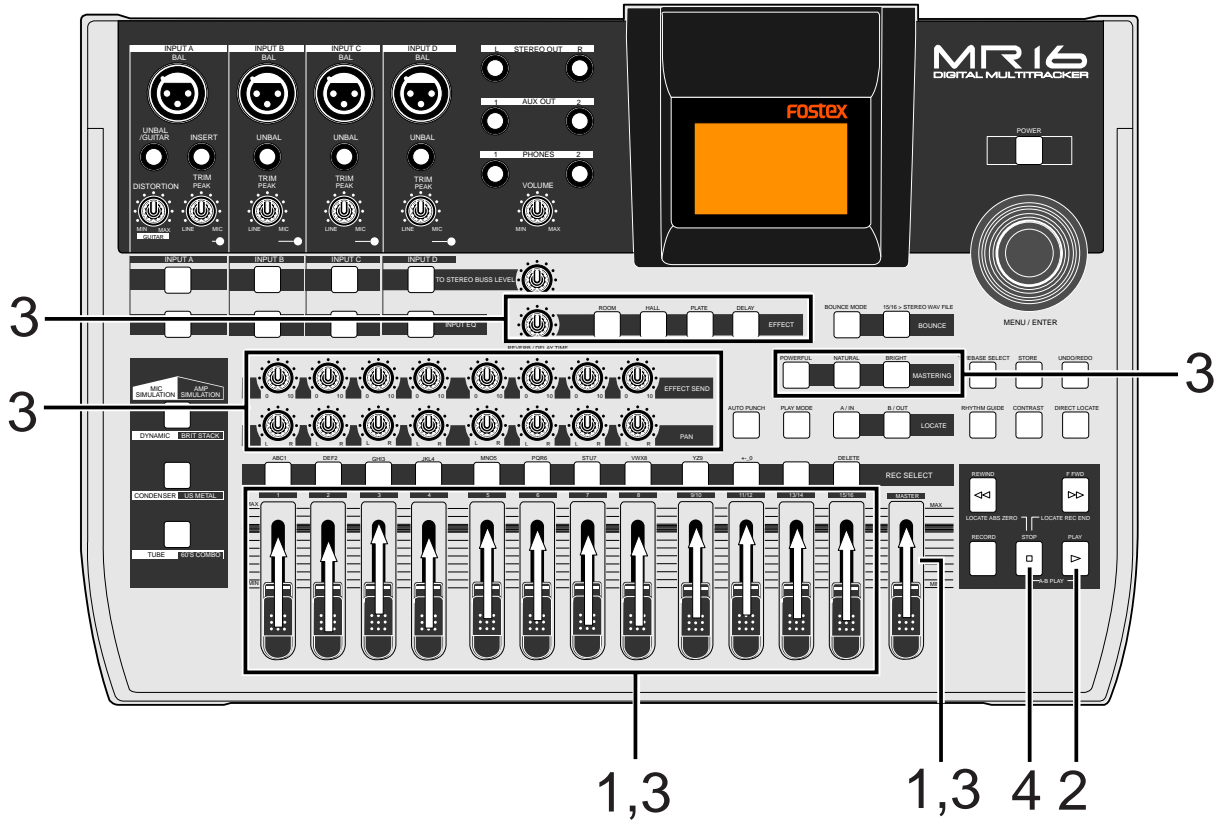

- 1) Raise the [MASTER] fader to the "≡" position. Set all the track faders down to the minimum position.
- 2) Press the [PLAY] key to start playback from the beginning of the song.
- 3) While playing back the song, adjust playback levels of tracks 1 through 16 using the track faders. You can also adjust panning for tracks 1 through 8 and apply the reverb or delay to these tracks, as well as apply the mastering effect to the mixed sound.

Use the track faders (1 through 16) to control the track output levels, and use the [MASTER] fader to adjust the master recording levels of the bounced signals appropriately while checking meters L/R.

See "Using effects" on page 65 for details about the delay/reverb and mastering effects.

By raising the [PHONES VOL] control, you can hear the bounced signals.

During rehearsal and actual track bouncing, the track faders and [MASTER] fader control the following signal levels.

Faders 1 through 16	Playback levels of tracks 1 through 16 for bouncing.
[MASTER] fader	Recording master levels of bouncing.

During rehearsal and actual track bouncing, the level meters on the screen show the following signal levels.

Meters 1 through 16	Playback levels of tracks 1 through 16.
Meters L and R	Output levels of STEREO OUT (= recording levels of bouncing)

- 4) After finishing rehearsal, press the [STOP] key to stop the recorder and locate it to the beginning of the song.

Do not move the controls and faders after finishing rehearsal.

Actual track bouncing

After finishing rehearsal, let's carry out actual track bouncing.



- 1) While the recorder is stopped, press the [1-8 > NEW SONG] key.

The [1-16 > NEW SONG] key lights up and the display shows the screen below. If you execute track bouncing, press the [MENU/ENTER] knob while holding down the [RECORD] key.

If you cancel track bouncing, press the [STOP] key.

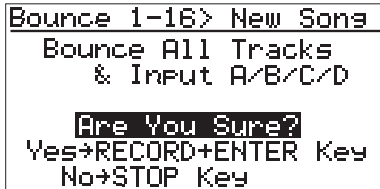

<Note>: When you are going to execute track bouncing, if there is not enough space on the hard disk or 99 songs already exist on the disk, a warning message appears and the operation is canceled.

<Track bouncing while mixing signals from [INPUT A] through [INPUT D]>
When you bounce tracks 1 through 16 to tracks 15/16 of the new song, you can also mix signals from [INPUT A] through [INPUT D] together (see next page).

- 2) Press the [MENU/ENTER] knob while holding down the [RECORD] key.

Track bouncing starts. The mixed (bounced) signals are recorded to tracks 15/16 of a new song. The screen example below shows that tracks 1 through 16 of Song01 (whose name is "Moonlit") is now being bounced to tracks 15/16 of the new song (Song04).

Meters 1 through 16 show the playback levels of tracks 1 through 16, while the L and R meters shows the recording levels of tracks 15/16 of Song04.

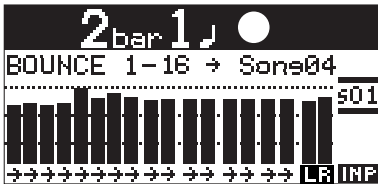

When track bouncing to a new song completes, the recorder automatically stops and the display shows the home screen of the new song. The song name of the new song is given by the name of the original song with "-**" (** is a two-digit number).



You can check the result by following the procedure described in "Checking the bounced signals on tracks 15/16" on page 81.

<Note>: To cancel track bouncing in the middle, press the [STOP] key. Pressing the [STOP] key automatically deletes the new song created in step 2 above and turns off the bounce mode.

Mixing signals of inputs A through D

The MR16 can mix input signals of [INPUT A] through [INPUT D]. The following diagram shows an example of mixing signals of INPUT A through INPUT D when bouncing tracks 1 through 8 to tracks 9/10. As you can see, the signals of INPUT A through INPUT D are mixed to the L/R stereo buss together with the bounced signals.

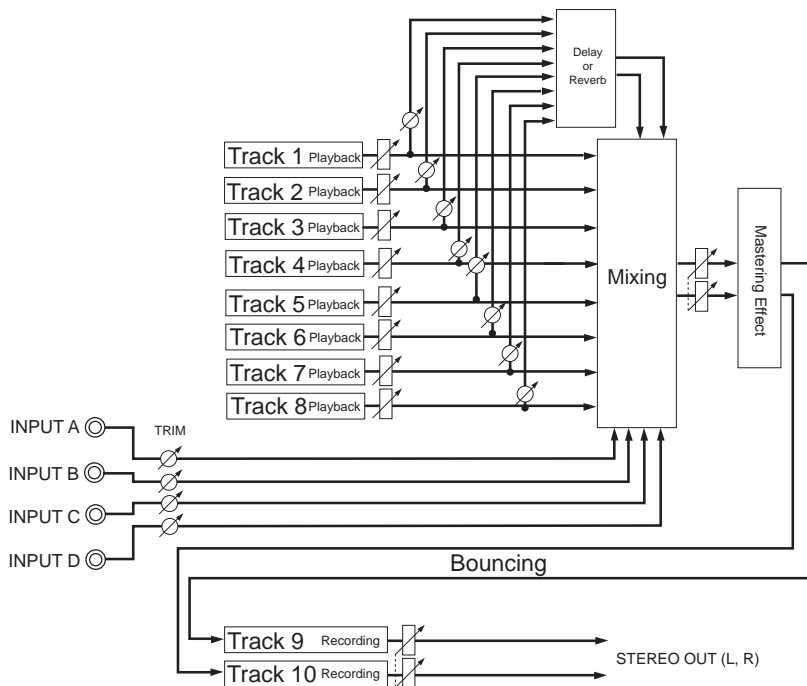

Connecting sound sources to INPUT A through INPUT D

Before starting track bouncing, connect the desired sound source(s) to any desired input(s) between INPUT A and INPUT D.

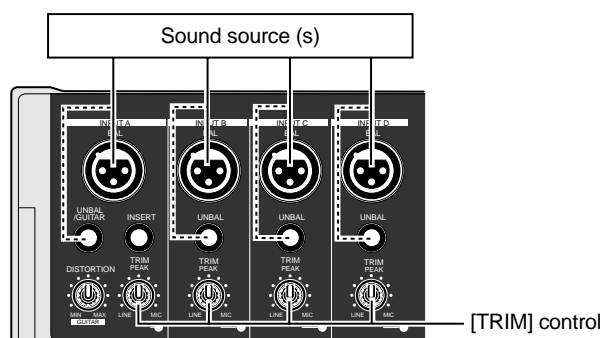

Adjust the input level of each input using the [TRIM] control to match the balance with the bounced track levels.

Also, you can adjust panning of each input for stereo mix. See the next page for details about how to set panning.

[TO STEREO BUSS] key setting

To send an input signal of any of the [INPUT A] through [INPUT D] to the stereo L/R buss, turn on the corresponding [TO STEREO BUSS] key and adjust the send level using the [LEVEL] control.

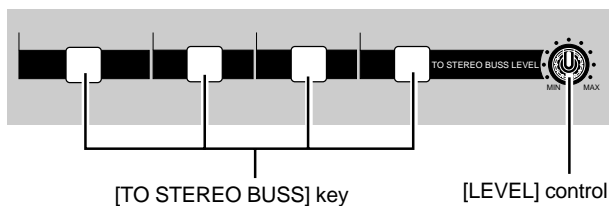

When the [TO STEREO BUSS] key is turned on, the key illuminates in green. That is, when the key illuminates, input signal is sent to the stereo L/R buss. (Note that when the key flashes, the corresponding input is assigned to any recording track.)

<Note>: If you press the [TO STEREO BUSS] key when make recording other than track bouncing, the key lamp may flash. This shows the input signal is routed to the armed track. That is, the input signal will be recorded to the armed track, in stead of mixed to the stereo buss.

Panning setting for INPUT A through INPUT D

You can independently set panning for each of INPUT A through INPUT D. Each input signal is positioned in the mix according to the panning setting here.

- 1) While the recorder is stopped, press the [MENU/ENTER] knob to enter the menu mode. The display now shows the first page of the menu selection screen.

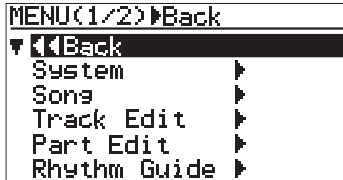

- 2) Rotate the [MENU/ENTER] knob to select "Input ▶" on the second page, and press the [MENU/ENTER] knob. The display now shows the input menu screen.

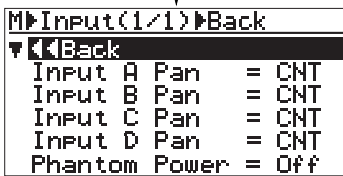
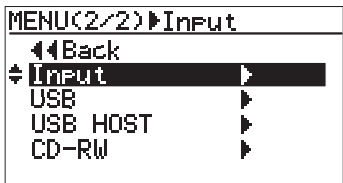

The default panning settings are as below. You can set each input to the desired panning position from L10 (hard left) to R10 (hard right).

Input A	CNT (center position)
Input B	CNT (center position)
Input C	CNT (center position)
Input D	CNT (center position)

<Tip>: You can directly access to the input menu screen by a long press of the [TO STEREO BUSS] key of the desired input channel. On the input menu screen accessed in this way, the panning setting item for the corresponding input is highlighted. For example, a long press of the [TO STEREO BUSS] key of [INPUT D] directly accesses to the screen shown below.

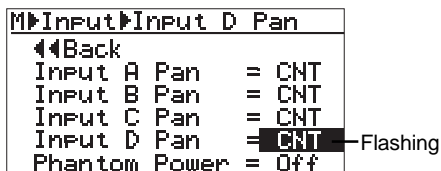

- 3) Rotate the [MENU/ENTER] knob to select the desired item (any one of "Input A Pan" through "Input D Pan"), and press the [MENU/ENTER] knob.

The display shows the screen for making panning setting of the selected input. The current setting flashes. In the screen example below, "Input A Pan" is selected and the default "CNT" is flashing.

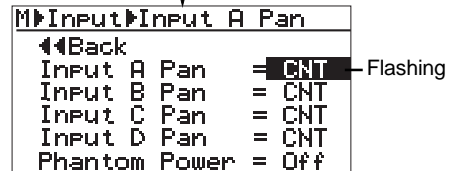
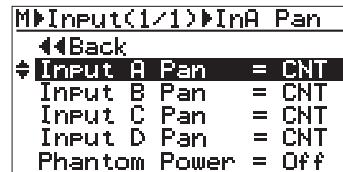

You can select the desired panning value from among R01 through R10 and L01 through L10, as well as "CNT" (center).

- 4) Rotate the [MENU/ENTER] knob to select the desired value, and press the [MENU/ENTER] knob. The panning is set and the display returns to the previous screen.

In the screen example below, "Input A Pan" is set to "R10".

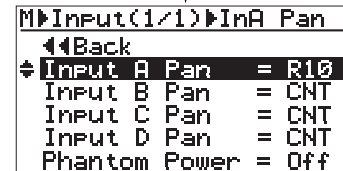
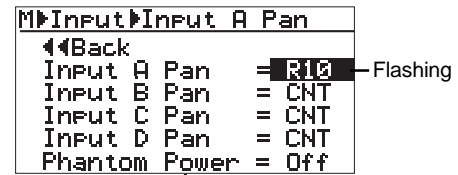

You can also make panning setting of another input in the same manner as above.

- 5) Press the [STOP] key to exit the menu mode. By selecting "◀◀ Back" and pressing the [MENU/ENTER] knob, the display returns to the previous screen. Therefore, you can also exit the menu mode by repeating this operation.

Bouncing the desired part of a song

Typically, bouncing is executed from the beginning to the end of a song, as shown in Figure 1 below. However, you can bounce only the desired part by using the track bouncing and punch in/out functions together. The following assumes that the song you are going to execute track bouncing is loaded and you finished rehearsal of track bouncing.

The following procedure shows the example of bouncing the desired part of a song in the "Bounce 1-8 > 9/10" mode (<Note>: In the "1-16 > NEW SONG" mode, you cannot bounce the desired part of a song by using the track bouncing and auto punch in/out functions together).

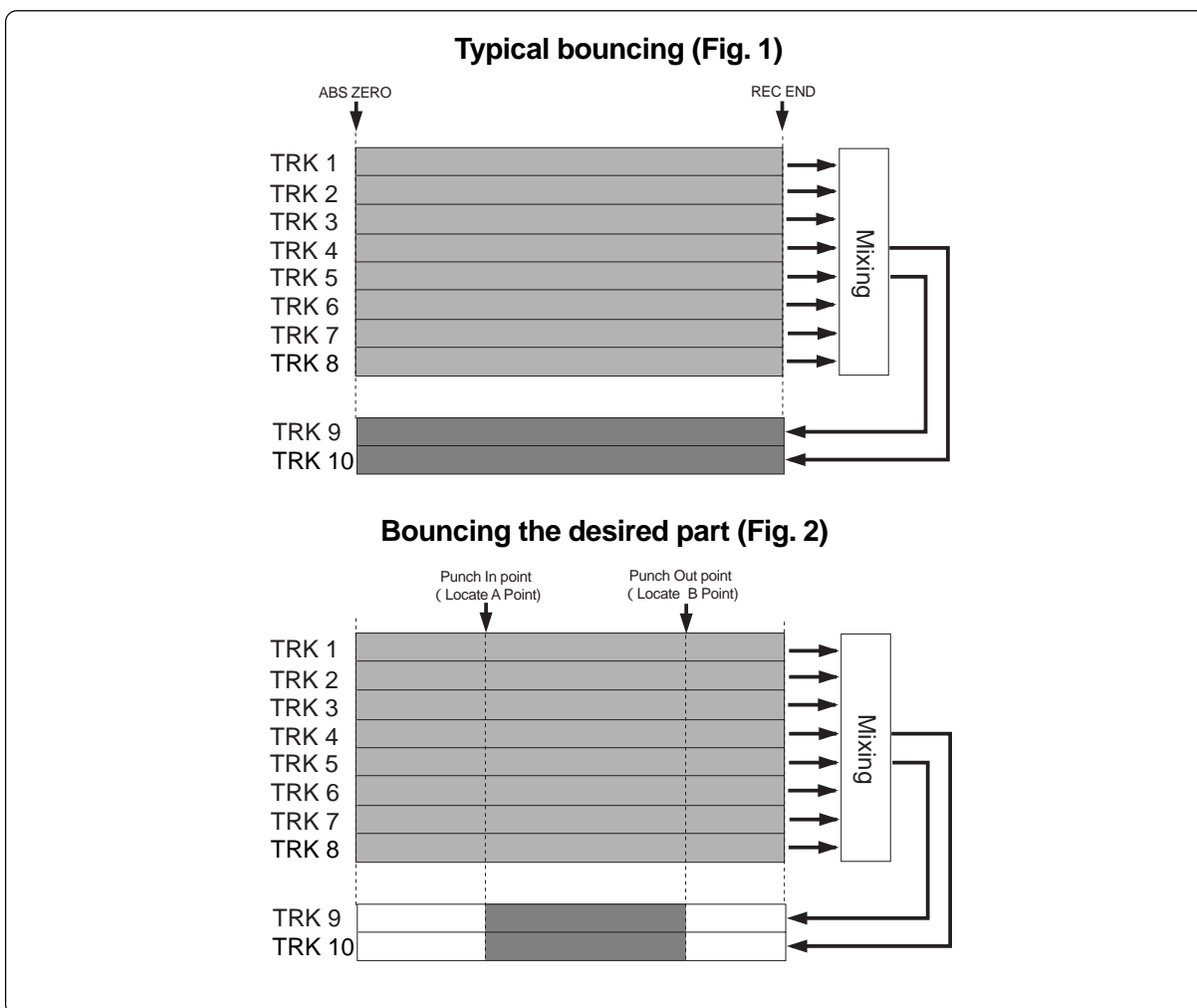

- 1) **Set the punch-in and punch-out points (see page 62).**

By pressing the [PLAY] key while holding down the [STOP] key, you can play back the part between the punch-in and punch-out points (see page 48).

- 2) **Locate the recorder to a position before the punch-in point.**

- 3) **Press the [BOUNCE MODE] key to set the bounce mode to "1-8 > 9/10".**

When setting the bounce mode to "1-8 > 9/10", tracks 9/10 automatically enter the input monitor mode and "IMP" lights on the home screen.

- 4) **Press the [AUTO PUNCH] key to activate the auto punch mode.**

The [AUTO PUNCH] key is lit when the auto punch mode is active.

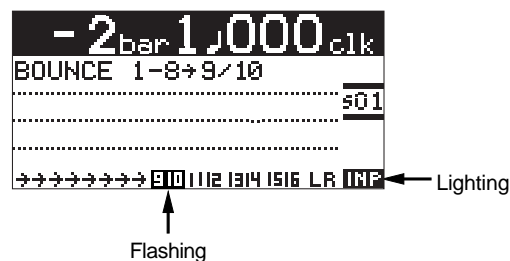

- 5) Press the [RECORD] key while holding down the [PLAY] key.
 "TAKE" is shown in the upper part of the screen and the recorder starts playback.
 It automatically starts recording (bouncing) when it reaches the punch-in point.

Before the punch-in point

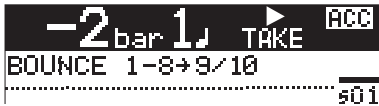

Between the punch-in and punch-out points

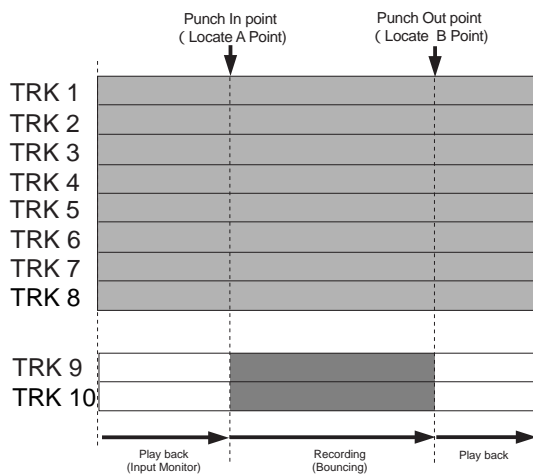

The recorder stops recording (bouncing) at the punch-out point and returns to playback, while the auto punch mode exits and "TAKE" in the screen turns off.

<Note>: During playback in the operation above, you cannot monitor the sound. You can monitor the sound (bounced sound) only during recording between punch-in and punch-out points.

- 6) Press the [STOP] key to stop the recorder.
 Check the result by playing back the bounced tracks, as described earlier.

<Note>: If you are not satisfied with the result, press the [UNDO/REDO] key to redo the operation.

Rhythm guide function

The MR16 offers the rhythm guide function, which allows outputting the rhythm guide click during recording.

This chapter describes how to output the rhythm guide, set the time signature/tempo and create the conductor map.

Using the rhythm guide function

The MR16 provides the metronome function which can output the rhythm guide click during recording. You can easily output the guide click from the [STEREO OUT L, R] jacks by pressing the [RHYTHM GUIDE] key on the top panel. Two types of the rhythm guide are available: one has the constant time signature/tempo throughout a song, while the other has the programmed time signature/tempo map.

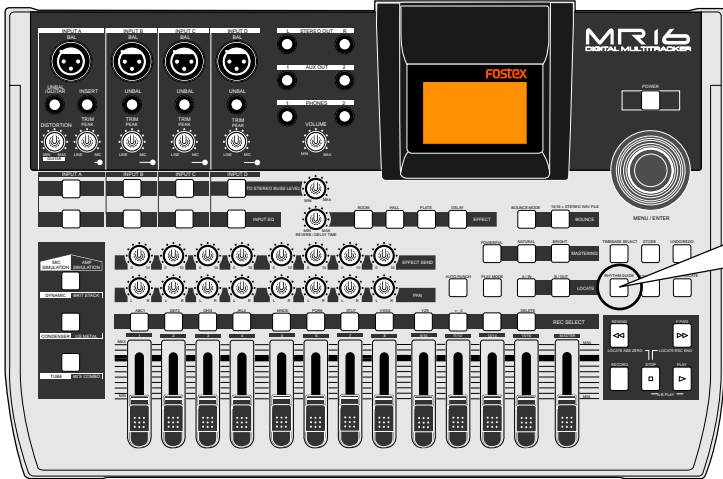

To output the rhythm guide click, turn on the [RHYTHM GUIDE] key. By default, the guide click is output at time signature=4/4, tempo=120.

You can output the rhythm guide click according to the desired constant time signature and tempo, as well as the programmed rhythm guide click based on the conductor map.

When recording starts, the MR16 simultaneously starts feeding the rhythm guide click from the [STEREO OUT L, R] jacks at the selected level (the default is 80). Note that the rhythm guide click is not output during track bouncing. The output level of the rhythm guide click is shown on the L and R level meters. Note that you can monitor the rhythm guide click via headphones or (a) monitor speaker(s). You cannot record the rhythm guide click to any MR16 track(s). If you do not want to output the rhythm guide click, turn off the [RHYTHM GUIDE] key.

Setting the time signature and tempo

You can set the default rhythm guide (time signature: 4/4, tempo: 120), output level, etc. using the "Rhythm Guide" menu in the menu mode.

- 1) While the recorder is stopped, press the [MENU/ENTER] knob to enter the menu mode. The display now shows the first page of the menu selection screen, where "◀◀ Back" is highlighted initially (selecting "◀◀ Back" returns to the previous screen).

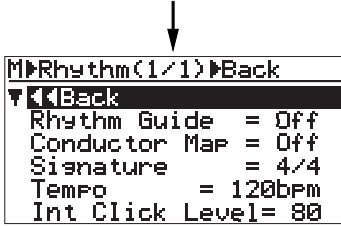
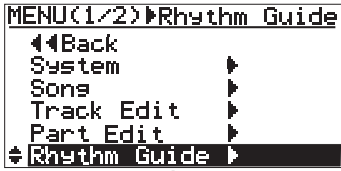
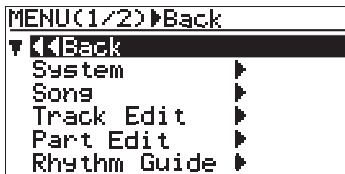

- 2) Rotate the [MENU/ENTER] knob to select "Rhythm Guide ▶", and press the [MENU/ENTER] knob. The display now shows the screen for setting the rhythm guide, where "◀◀ Back" is highlighted.

Tip! While the home screen is shown and the recorder is stopped, long press of the [RHYTHM GUIDE] key directly brings up the screen for setting the rhythm guide.

- 3) Rotate the [MENU/ENTER] knob to select the desired item, and press the [MENU/ENTER] knob. The current setting of the selected item starts flashing. On the screen examples below, the "Rhythm Guide" item is highlighted (see the upper screen) and the [MENU/ENTER] knob is pressed (see the lower screen).

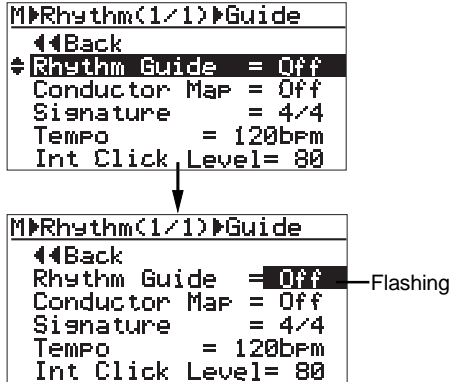

- 4) Rotate the [MENU/ENTER] knob to select the desired option, and press the [MENU/ENTER] knob. The selected option (in the example above, "On" or "Off") is confirmed and the display returns to the previous screen.

You can make setting for each item similarly. The rhythm guide setting screen has the following items.

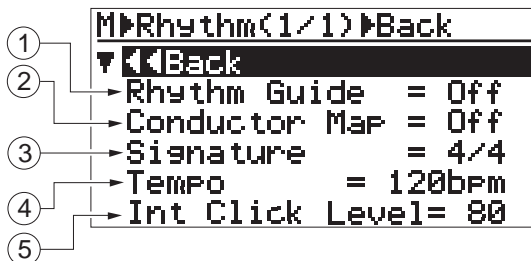

1. **Rhythm Guide: On/off selection of the rhythm guide**
The setting you make here is reflected to the [RHYTHM GUIDE] key (the key is lit when ON, while it is unlit when OFF). Conversely, when you turn on or off the rhythm guide using the [RHYTHM GUIDE] key, the status is reflected to this screen. See the table on the right for details.
2. **Conductor Map: On/off selection of the conductor map**
This item enables or disables the conductor map (see "Conductor map" described later). The default is "Off". See the table on the right for details.
3. **Signature: Time signature setting**
The default is "4/4". You can select from among 1/4 through 5/4 and 1/8 through 8/8. The setting here is effective from the beginning to the end of the song when the "Conductor Map" item is set to "Off" (i.e. the same time signature all through the song). When the "Conductor Map" item is set to "On", the setting here is ineffective. See the table on the right for details.

4. **Tempo: Tempo setting**

The default is "120bpm". You can select between 30 and 250 bpm. The setting here is effective from the beginning to the end of the song when the "Conductor Map" item is set to "Off" (i.e. the same tempo all through the song). When the "Conductor Map" item is set to "On", the setting here is ineffective. See the table on the below for details.

5. **Int ClickLevel: Internal click output level**

The default is "80". You can set it between 0 and 99.

To exit the menu mode, press the [STOP] key, or select "◀◀ Back" and press the [MENU/ENTER] knob repeatedly.

The table below shows how the "Rhythm Guide" and "Conductor Map" item settings affect the conditions of rhythm guide output and bar/beat indication.

On/off conditions	Rhythm guide	Bar/beat indication
Rhythm Guide: Off Conductor Map: Off	No output	The "Signature" and "Tempo" item settings are effective.
Rhythm Guide: Off Conductor Map: On	No output	The conductor map is effective.
Rhythm Guide: On Conductor Map: Off	Output: The tempo and time signature setting on this screen is effective.	The "Signature" and "Tempo" item settings are effective.
Rhythm Guide: On Conductor Map: On	Output: The conductor map setting is effective.	The conductor map is effective.

<Note>: When "Conductor Map" is set to "On", the "Signature" and "Tempo" fields show "---" as below. This indicates that the signature and tempo values set on this screen are ineffective, while the conductor map setting is effective.

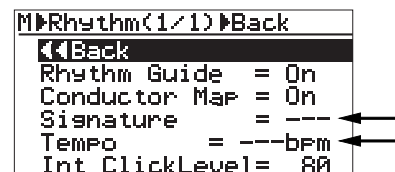

See the next page for details about how to set the conductor map.

Creating the conductor map

The MR16 can output the rhythm guide click which follows the "conductor map" during recording. It can also output MIDI clock and song position pointer which follows the "conductor map" from the [MIDI OUT] connector.

The conductor map consists of the time signature map and tempo map. You can add "events" to each map. Each event specifies the time signature or tempo, as well as the position from which the specified time signature or tempo is effective. The time signature or tempo specified by each event is effective until the next event in the map appears.

For example, if the time signature map has two events -- one sets "4/4" at the first bar 1, while the other sets "2/4" at the third bar --, the song is played in 4/4 from bar 1 to 2, and played in 2/4 from bar 3 to the end.

For another example, if the tempo map has two events -- one sets "120" at the first bar 1/first beat while the other sets "90" at bar 12/beat 2 --, the song is played at 120 bpm from bar 1 to bar 12/beat 1, while it is played at 90 from bar 12/beat 2 to the end.

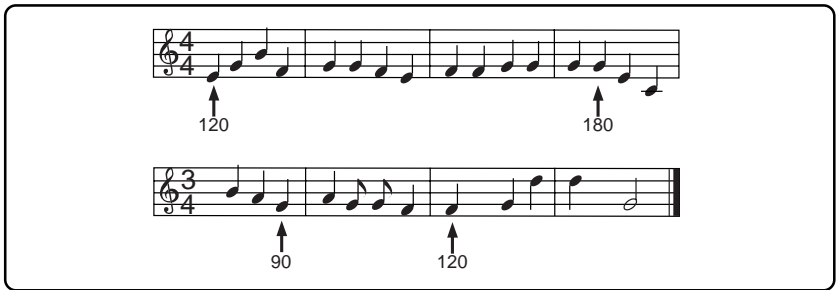

Setting the signature map

- 1) While the recorder is stopped, press the [MENU/ENTER] knob to enter the menu mode. The display now shows the first page of the menu selection screen, where "◀◀Back" is high lighted initially (selecting "◀◀Back" returns to the previous screen). You can also return to the previous screen by pressing the [REWIND] key.

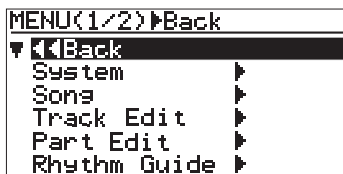

- 2) Rotate the [MENU/ENTER] knob to select "Song ▶", and press the [MENU/ENTER] knob. The display now shows the song editing screen, where "◀◀Back" is highlighted.

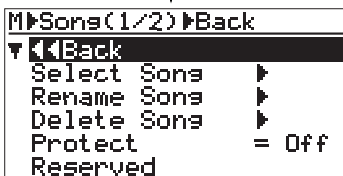
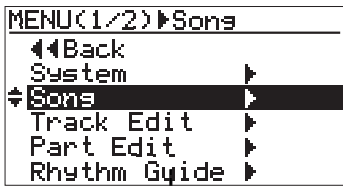

- 3) Rotate the [MENU/ENTER] knob to select "Signature Map ▶" on the second page, and press the [MENU/ENTER] knob. The display shows the signature map screen on which the current time signature events are listed. Each event specifies the bar number and time signature. By default, "1Bar -> 4/4" and "---Bar -> ---" are listed. In this condition, the song is played in 4/4 from the beginning to the end. "---Bar -> ---" is used to create a new event.

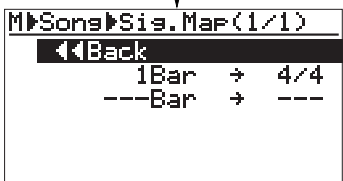
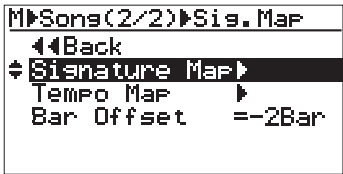

The procedure example below shows how to add the following events to the signature map.

Bar 1 through bar 3	----->	4/4
Bar 4 through bar 7	----->	3/4
Bar 8 through bar 11	----->	4/4
Bar 12 through bar 15	----->	5/8
Bar 16 through the last bar	----->	3/4

- 4) Rotate the [MENU/ENTER] knob to select "**---Bar ->---**", and press the [MENU/ENTER] knob. The display now shows the screen for setting the new time signature event, where "**◀◀Back**" is highlighted.

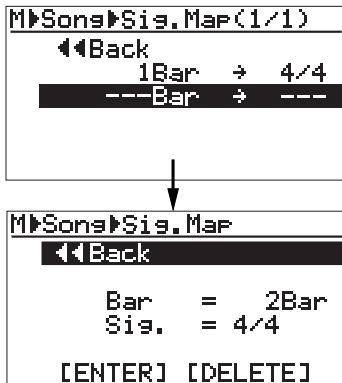

- 5) Rotate the [MENU/ENTER] knob to select "**Bar = 2Bar**", and press the [MENU/ENTER] knob. "2Bar" starts flashing and you can now set the bar number.

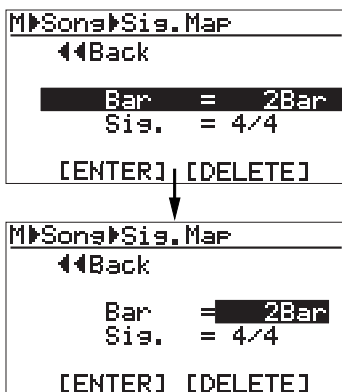

- 6) Rotate the [MENU/ENTER] knob to enter the desired bar number, and press the [MENU/ENTER] knob. In this procedure example, enter "4Bar". The display returns to the previous screen.

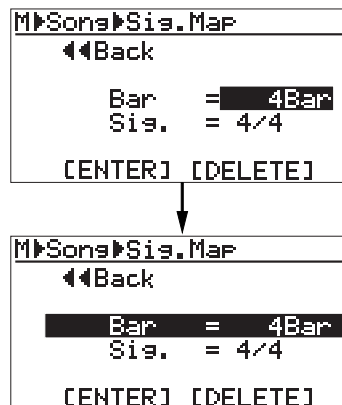

- 7) Rotate the [MENU/ENTER] knob to select "**Sig. = 4/4**", and press the [MENU/ENTER] knob. "4/4" starts flashing and you can now set the time signature.

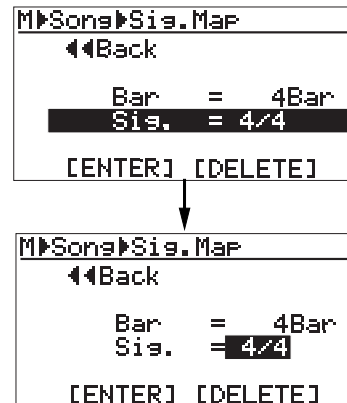

- 8) Rotate the [MENU/ENTER] knob to select the desired time signature, and press the [MENU/ENTER] knob. In this procedure example, enter "3/4". The display returns to the previous screen.

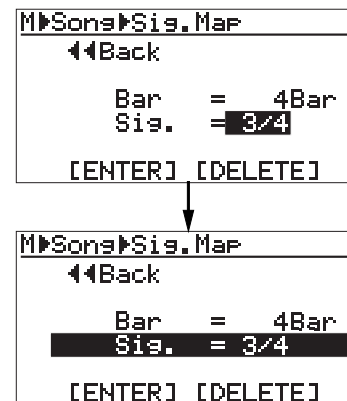

- 9) Rotate the [MENU/ENTER] knob to select "[ENTER]" at the bottom, and press the [MENU/ENTER] knob. The new time signature event is set and the display shows the screen as below. In this condition, the song is played in 4/4 from bar 1 to bar 3 and in 3/4 from bar 4.

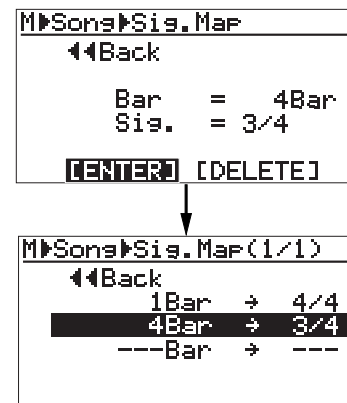

Repeat steps 5 through 9 until creating all necessary events.

• **Editing a time signature event**

You can edit a time signature event.

- 1) **On the time signature map screen, rotate the [MENU/ENTER] knob to select the event you want to edit, and press the [MENU/ENTER] knob.**
As with the description on the previous page, the display now shows the screen for setting the event. For example, let's select "8Bar -> 4/4".

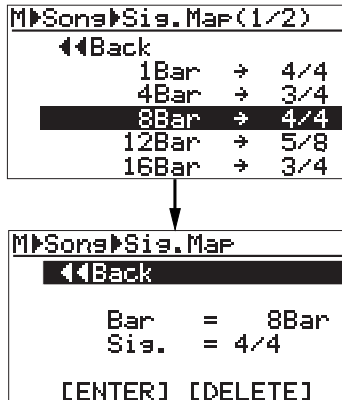

- 2) **To change the bar number, rotate the [MENU/ENTER] knob to select "Bar = 8Bar", and press the [MENU/ENTER] knob.**
To change the time signature, rotate the [MENU/ENTER] knob to select "Sig. = 4/4", and press the [MENU/ENTER] knob.
As with the procedure described on the previous page, you can now set the bar number or time signature.
- 3) **Rotate the [MENU/ENTER] knob to edit the value, and press the [MENU/ENTER] knob.**
In this procedure example, enter "10" for the bar number.
- 4) **Rotate the [MENU/ENTER] knob to select "[ENTER]" at the bottom, and press the [MENU/ENTER] knob.**
The editing is confirmed and the display returns to the signature map screen.

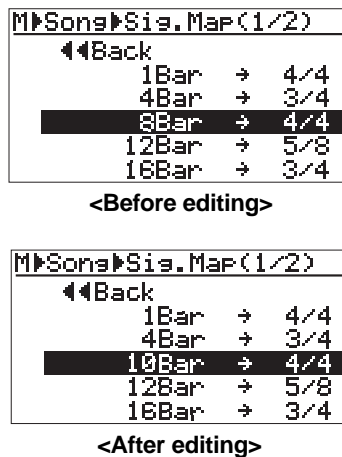

To exit the menu mode, press the [STOP] key.

• **Deleting an unnecessary time signature event**

You can delete an unnecessary time signature event.

- 1) **On the time signature map screen, rotate the [MENU/ENTER] knob to select the event you want to delete, and press the [MENU/ENTER] knob.**
As with the description on the previous page, the display now shows the screen for setting the event. For example, let's select "8Bar -> 4/4".

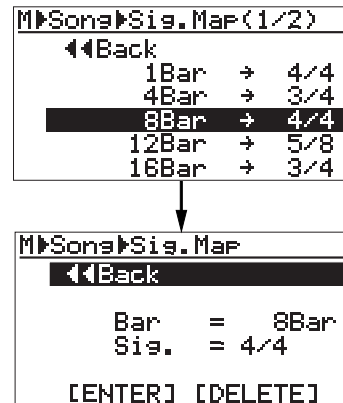

- 2) **Rotate the [MENU/ENTER] knob to select "[DELETE]" at the bottom, and press the [MENU/ENTER] knob.**
The event is immediately deleted and the display returns to the signature map screen.

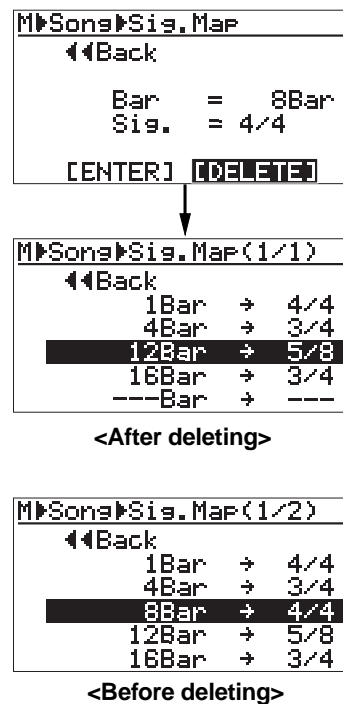

To exit the menu mode, press the [STOP] key.

Editing the bar offset

By default, the bar/beat value at the beginning (ABS ZERO) of the song is set to "bar -2/beat 1". This offset (the bar/beat value at ABS ZERO) is called "bar offset". You can change the default bar offset to the desired value.

- 1) On the second page of the song editing menu screen, highlight "Bar Offset" and press the [MENU/ENTER] knob.
The current offset value (by default, "-2Bar") starts flashing.

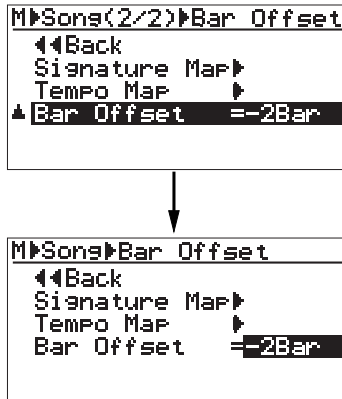

The table below shows the available offset values.

Option	Meaning	Option	Meaning
-8Bar	ABS Zero= bar -8	-3Bar	ABS Zero= bar -3
-7Bar	ABS Zero= bar -7	-2Bar	ABS Zero= bar -2
-6Bar	ABS Zero = bar -6	-1Bar	ABS Zero= bar -1
-5Bar	ABS Zero= bar -5	0Bar	ABS Zero= bar 1
-4Bar	ABS Zero= bar -4		

- 2) Rotate the [MENU/ENTER] knob to select the desired offset value, and press the [MENU/ENTER] knob.
The selected offset value is confirmed, while the display returns to the previous screen.

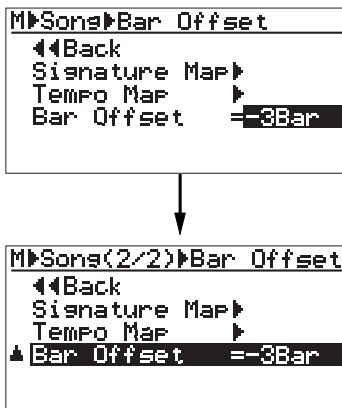

To exit the menu mode, press the [STOP] key.

You can see the bar offset value on the home screen when the recorder is at the beginning of the song (ABS 0).

The screen example below shows the home screen when the bar offset is set to "-4 bars".



The default home screen (bar offset = -2 bars).



The home screen when the bar offset is set to "-4 bars".

Setting the tempo map

After setting the time signature map, you have to create the tempo map by adding the necessary tempo event(s). Like a time signature event, a tempo event specifies the tempo at the tempo changing point. Each tempo specified by a tempo event is effective until the next event appears. For example, you can set the tempo to 120 at the third beat in bar 4, and set to 90 at the second beat in bar 4, etc.

- 1) While the recorder is stopped, press the [MENU/ENTER] knob to enter the menu mode. The display now shows the first page of the menu selection screen, where "◀◀ Back" is highlighted initially (selecting "◀◀ Back" returns to the previous screen). You can also return to the previous screen by pressing the [REWIND] key.

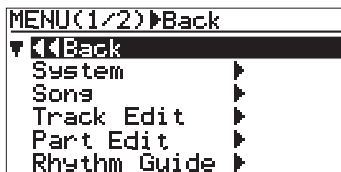

- 2) Rotate the [MENU/ENTER] knob to select "Song ▶", and press the [MENU/ENTER] knob. The display now shows the song editing screen, where "◀◀ Back" is highlighted.

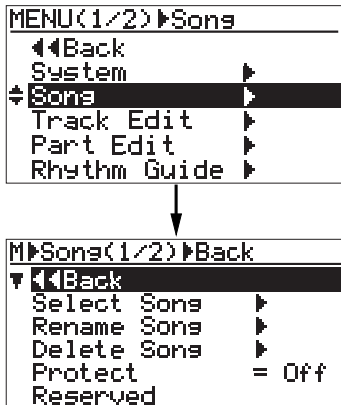

- 3) Rotate the [MENU/ENTER] knob to select "Tempo Map ▶" on the second page, and press the [MENU/ENTER] knob. The display shows the tempo map screen on which the current tempo events are listed. Each event specifies the bar/beat position and tempo. By default, "1Bar 1♪ → 120 bpm" and "--Bar -♪ → --bpm" are listed. In this condition, the song starts in 120 bpm and there is no tempo change. "--Bar -♪ → --bpm" is used to create a new tempo event.

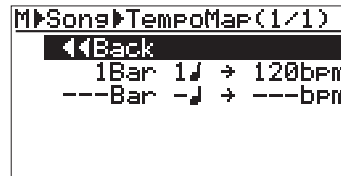
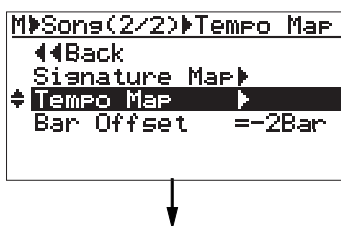

The procedure example below shows how to add the following tempo events to the tempo map.

Bar 1/beat 1	----->	120 bpm
Bar 4/beat 2	----->	180 bpm
Bar 8/beat 3	----->	90 bpm
Bar 12/beat 1	----->	120 bpm
Bar 16/beat 4	----->	250 bpm

- 4) Rotate the [MENU/ENTER] knob to select "--Bar -♪ → --bpm", and press the [MENU/ENTER] knob. The display now shows the screen for setting the new tempo event, where "◀◀ Back" is highlighted.

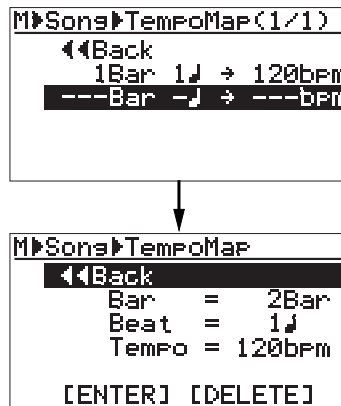

- 5) Rotate the [MENU/ENTER] knob to select "Bar = 2Bar", and press the [MENU/ENTER] knob. "2Bar" starts flashing and you can now set the bar number. You can enter the bar number between 1 and 999.

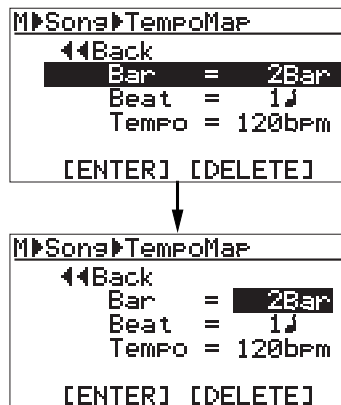

- 6) Rotate the [MENU/ENTER] knob to enter the desired bar number, and press the [MENU/ENTER] knob.
In this procedure example, enter "4Bar".
The display returns to the previous screen.

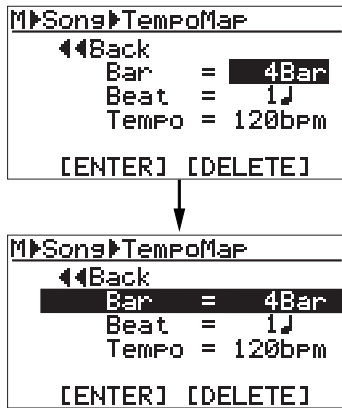

- 7) Rotate the [MENU/ENTER] knob to select "Beat = 1", and press the [MENU/ENTER] knob.
"1" starts flashing and you can now set the beat number. You can enter the beat number between 1 and 8.

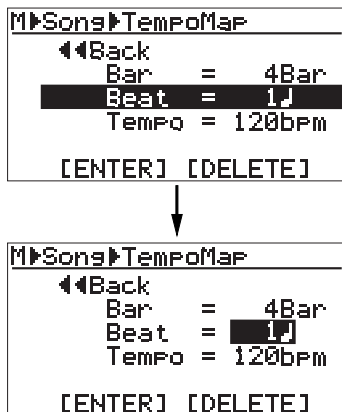

- 8) Rotate the [MENU/ENTER] knob to enter the desired beat number, and press the [MENU/ENTER] knob.
In this procedure example, let's enter "2".
The display returns to the previous screen.

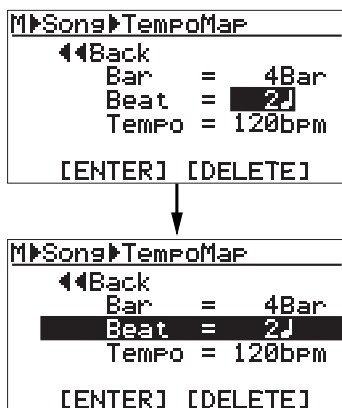

- 9) Rotate the [MENU/ENTER] knob to select "Tempo = 120bpm", and press the [MENU/ENTER] knob.

"120bpm" starts flashing and you can now set the tempo. You can enter the tempo between 30 and 250.

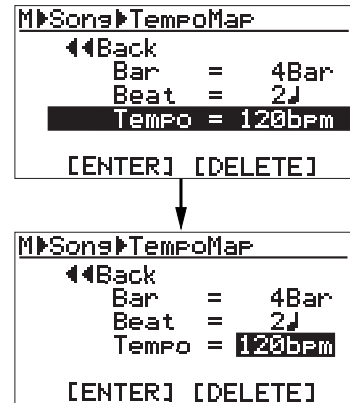

- 10) Rotate the [MENU/ENTER] knob to enter the desired tempo, and press the [MENU/ENTER] knob.
In this procedure example, enter "180bpm".
The display returns to the previous screen.

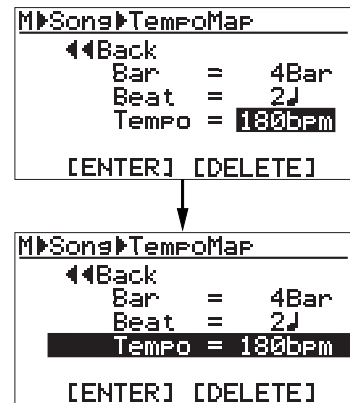

- 11) Rotate the [MENU/ENTER] knob to select "[ENTER]" at the bottom, and press the [MENU/ENTER] knob.
The new tempo event is set and the display shows the screen as below. In this condition, the song is played in 120 bpm from the beginning to bar 4/beat 1 and in 180 from bar 4/beat 2 to the end.

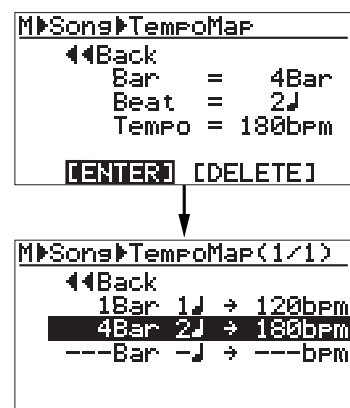

Repeat steps 4 through 11 until creating all necessary tempo events.

• Editing a tempo event

You can edit a tempo event.

- 1) On the tempo map screen, rotate the [MENU/ENTER] knob to select the event you want to edit, and press the [MENU/ENTER] knob.

As with the description on the previous page, the display now shows the screen for setting the event.

For example, let's select "12Bar 1 ↘ 120bpm".

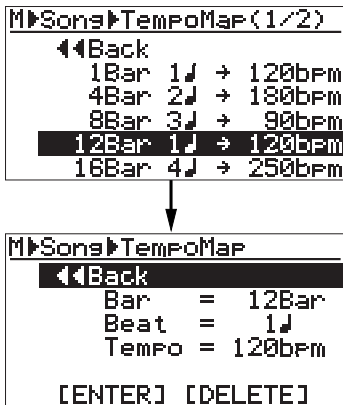

- 2) To change the bar number, rotate the [MENU/ENTER] knob to select "Bar = 12Bar", and press the [MENU/ENTER] knob. To change the beat number, rotate the [MENU/ENTER] knob to select "Beat = 1 ↘", and press the [MENU/ENTER] knob. To change the tempo, rotate the [MENU/ENTER] knob to select "Tempo = 120bpm", and press the [MENU/ENTER] knob.

As with the procedure described on the previous page, you can now set the bar number, beat number or tempo.

- 3) Rotate the [MENU/ENTER] knob to edit the value, and press the [MENU/ENTER] knob.

In this procedure example, let's enter "10" for the bar number.

- 4) Rotate the [MENU/ENTER] knob to select "[ENTER]" at the bottom, and press the [MENU/ENTER] knob.

The editing is confirmed and the display returns to the tempo map screen.

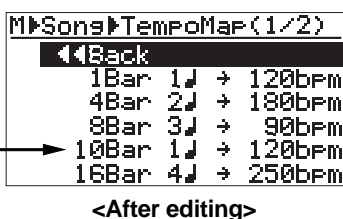
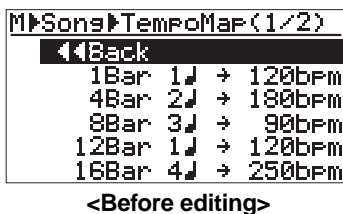

To exit the menu mode, press the [STOP] key, or select "◀◀Back" and press the [MENU/ENTER] knob repeatedly.

• Deleting an unnecessary tempo event

You can delete an unnecessary tempo event.

- 1) On the tempo map screen, rotate the [MENU/ENTER] knob to select the event you want to delete, and press the [MENU/ENTER] knob.

As with the description on the previous page, the display now shows the screen for setting the event.

For example, let's select "12Bar 1 ↘ 120bpm".

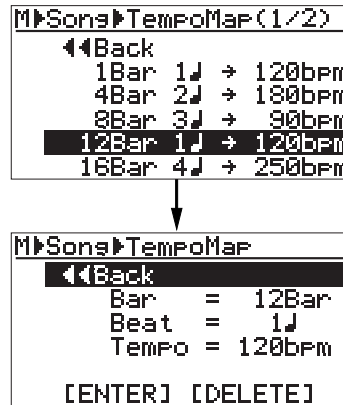

- 2) Rotate the [MENU/ENTER] knob to select "[DELETE]" at the bottom, and press the [MENU/ENTER] knob.

The event is immediately deleted and the display returns to the tempo map screen.

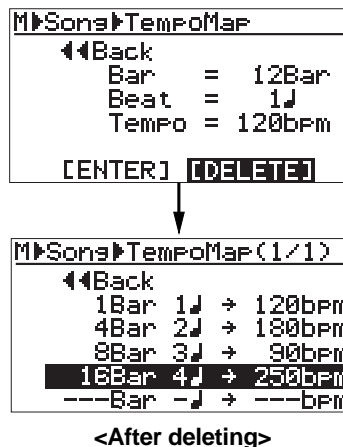

To exit the menu mode, press the [STOP] key, or select "◀◀Back" and press the [MENU/ENTER] knob repeatedly.

MIDI synchronization

By connecting the external MIDI devices (such as a sequencer, sound module, computer, etc.) via the [**MIDI OUT**] connector of the MR16, you can make powerful recording.

For example, by synchronizing a sequencer with the MR16 during playback, you can mix down signals (such as a vocal, guitar, etc.) recorded on the MR16 tracks and audio from a sound module.

You can synchronize MIDI with the MR16 by connecting a MIDI device to the [**MIDI OUT**] connector on the MR16 and sending out MTC (MIDI time code) or MIDI clock (with Song Position Pointer) from the MR16.

Synchronization using MTC

The following describes how to synchronize a sequencer to the MR16 which supports MTC (MIDI Time code).

Connection

Connect the **[MIDI OUT]** connector of the MR16 to the **[MIDI IN]** connector of an external MIDI sequencer using a MIDI cable. (Note that no MIDI cable is supplied with the MR16. Use a commercially available MIDI cable.)

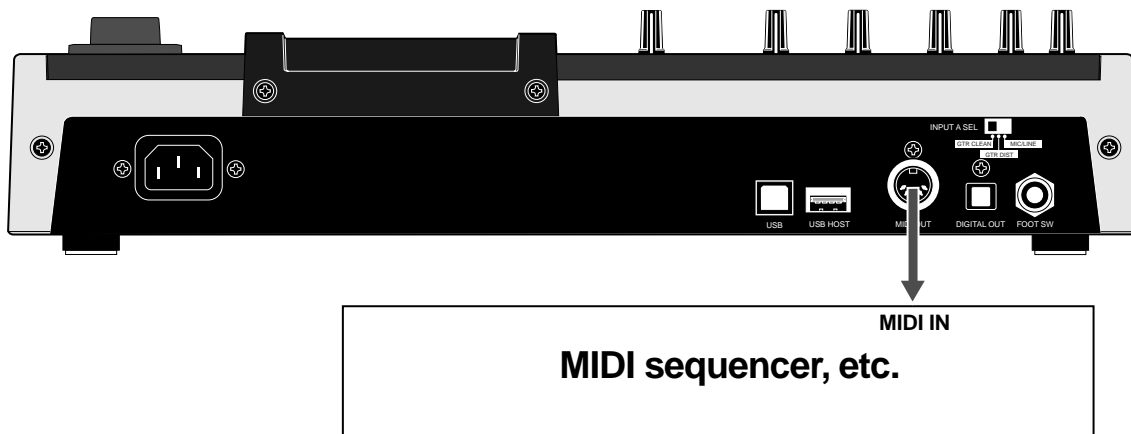

Settings of the MR16 & MIDI sequencer

- 1) **Set the "Midi Sync Out" item in the "System" menu of the menu mode to "MTC" and the "MTC Frame Rate" to an appropriate frame rate.**
See "MIDI sync/MTC frame rate settings" described below for details.
- 2) **Enable the external MIDI sequencer to synchronize to MTC.**
See the operation manual of the sequencer for details.
- 3) **Press the [PLAY] key of the MR16 to start playback.**
The sequencer automatically starts playback while synchronizing to the MR16.

MIDI sync/MTC frame rate settings

While the MR16 is stopped, you can set the reference of MIDI synchronization to "MTC" and the MTC frame rate appropriately to match the sequencer.

<MTC start time>

The MTC from the MR16 has one hour offset to the ABS time (the offset value is fixed). Therefore, when you start the MR16 from the beginning of a song (ABS ZERO), the MTC starts from "01h 00m 00s 00f".

- 1) While the recorder is stopped, press the [MENU/ENTER] knob to enter the menu mode. The display now shows the first page of the menu selection screen, where "◀◀ Back" is highlighted initially (selecting "◀◀ Back" returns to the previous screen).

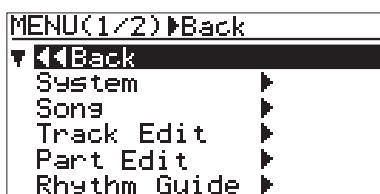

- 2) Rotate the [MENU/ENTER] knob to select "System ▶", and press the [MENU/ENTER] knob. The display now shows the first page of the system menu screen, where "◀◀ Back" is highlighted initially.

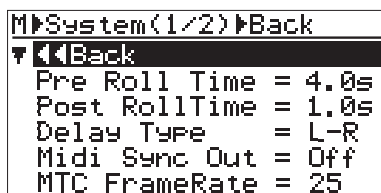
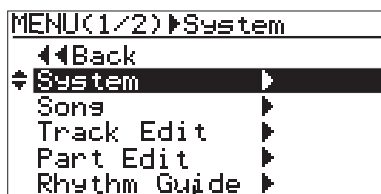

- 3) Rotate the [MENU/ENTER] knob to select "Midi Sync Out=***", and press the [MENU/ENTER] knob. The current option (the default is "Off") flashes. You can now select the desired option (the available options are Off, CLK and MTC).

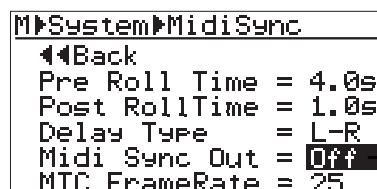
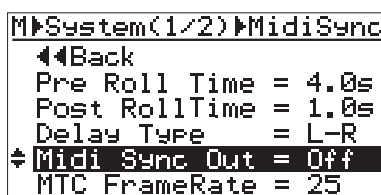

Flashing

Off	No signal is output from the [MIDI OUT] connector. This is the default.
CLK	MIDI clock with Song Position Pointer is output from the [MIDI OUT] connector.
MTC	MIDI time code is output from the [MIDI OUT] connector.

- 4) Rotate the [MENU/ENTER] knob to select "MTC", and press the [MENU/ENTER] knob. "Midi Sync Out" is now set to "MTC", while "Midi Sync Out" is highlighted on the screen.
- 5) Rotate the [MENU/ENTER] knob to select "MTC FrameRate=***", and press the [MENU/ENTER] knob. The current option (the default is "25") flashes. You can now select the desired frame rate (the options are "24", "25", "30nd" and "30df").

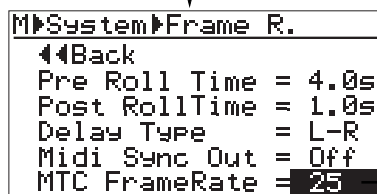
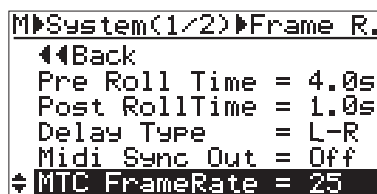

Flashing

- 6) Rotate the [MENU/ENTER] knob to select the desired frame rate, and press the [MENU/ENTER] knob. The selected frame rate is now effective, while "MTC FrameRate=***" is highlighted on the screen.
- 7) Press the [STOP] key to exit the menu mode.

Synchronization using MIDI clock

The following describes how to synchronize a sequencer to the MR16 using MIDI clock. Use this method if the sequencer does not support MTC (MIDI Time code).

<Notes>

- To synchronize a sequencer to the MR16 using MIDI clock, you have to make the signature/tempo map in the MR16.
The MIDI clock is output based on the signature/tempo map in the MR16.
When you record MIDI sounds, synchronize the sequencer to the MIDI clock fed from the MR16.
- Generally, a sequencer supporting MIDI song position pointer as well as MIDI clock can synchronize to the MR16 when you start playback of the MR16 from the middle of a song. It locates the current song position and chases the MR16.
However, note that some sequencer may not synchronize to the MR16.

Connection

As with the connection for MTC synchronization, connect the [MIDI OUT] connector of the MR16 to the [MIDI IN] connector of an external MIDI sequencer using a MIDI cable.

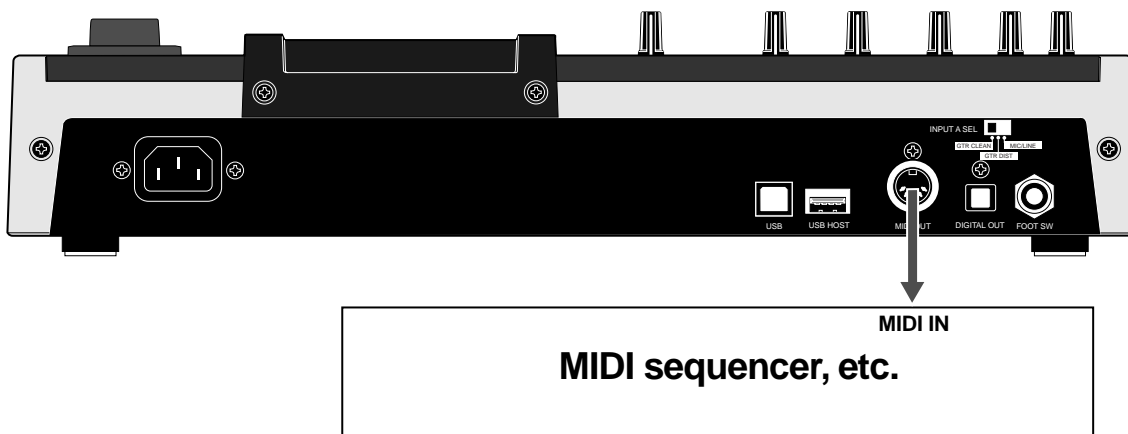

Settings of the MR16 & MIDI sequencer

- 1) **Set the "Midi Sync Out" item in the "System" menu of the menu mode to "Clk".**
See "MIDI sync/MTC frame rate settings" described above about how to set.
- 2) **Create the signature/tempo map by setting "Signature Map" and "Tempo Map" items in the "Song" menu of the menu mode appropriately.**
See "Using the rhythm guide function" on page 90 for details about how to set these items.
- 3) **Enable the external MIDI sequencer to synchronize to MIDI clock.**
See the operation manual of the sequencer for details.
- 4) **Press the [PLAY] key of the MR16 to start playback.**
The sequencer also starts playback in sync with the MR16.

Data export to a personal computer

This chapter describes how to export song data bounced to tracks 15/16 of the current or new song to a personal computer.

To export song data to a personal computer, you must convert it to a stereo WAV file.

You can export the converted (WAV) file to the personal computer via the [USB] port and create an audio CD using a CD burning function on the personal computer.

Note that you can also create an audio CD by connecting the external CD-R/RW drive to the [USB HOST] port of the unit, or using the internal CD-R/RW drive if it is provided to your MR16 (see the "How to use the CD-R/RW drive" supplementary manual).

<Notes on USB connection with Mac OS>

When making USB connection with a Macintosh computer, note that only Mac OS X or higher is supported. Do not connect to a Macintosh computer with the earlier version. The song data on the MR16 may be damaged.

WAV file conversion

The following describes how to convert track data (bounced to track 15/16 of the same song or the new song, or recorded to tracks 15/16 in stereo) to a stereo WAV file. You can export a converted WAV file to your personal computer and burn it to an audio CD using the CD-R function of the personal computer. You can also burn track data to an audio CD by connecting the external CD-R/RW drive to the [USB HOST] port of the unit, or using the internal CD-R/RW drive if it is provided to your MR16 (see the "How to use the CD-R/RW drive" supplementary manual). For details about how to export a converted WAV file to your personal computer, see page 107 below. For details about how to burn track data to an audio CD using the external or internal CD-R/RW drive, see the "How to use the CD-R/RW drive" supplementary manual.

Two mono WAV files recorded on tracks 15/16 are converted to a stereo WAV file as shown below. (Note that only files recorded on tracks 15/16 can be converted to a stereo WAV file.)

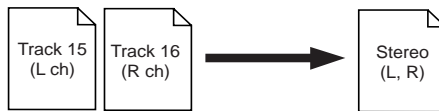

<Note>: If you are going to make conversion when no WAV data exists on tracks 15/16, the error message ("Track 15/16 Empty!") appears and the operation is canceled.

You can convert all track data (from ABS ZERO to REC END) or data of a specified part (between the LOCATE A and LOCATE B points).

<Note>: If you want to convert a part of track data, you have to set the LOCATE A and LOCATE B points in advance.

<Hint>: You can play back a converted stereo WAV file for checking, as well as set CUE points for dividing file data into individual CD tracks before writing it to a CD-R/RW disc. See the supplementary manual "How to use the CD-R/RW drive" for details.

Enabling the file conversion

You can enable the WAV file conversion function by pressing the [15/16 > STEREO WAV FILE] key. You can disable the WAV file conversion function by pressing the [STOP] key. When the WAV file conversion function is active, the display shows the screen as below.

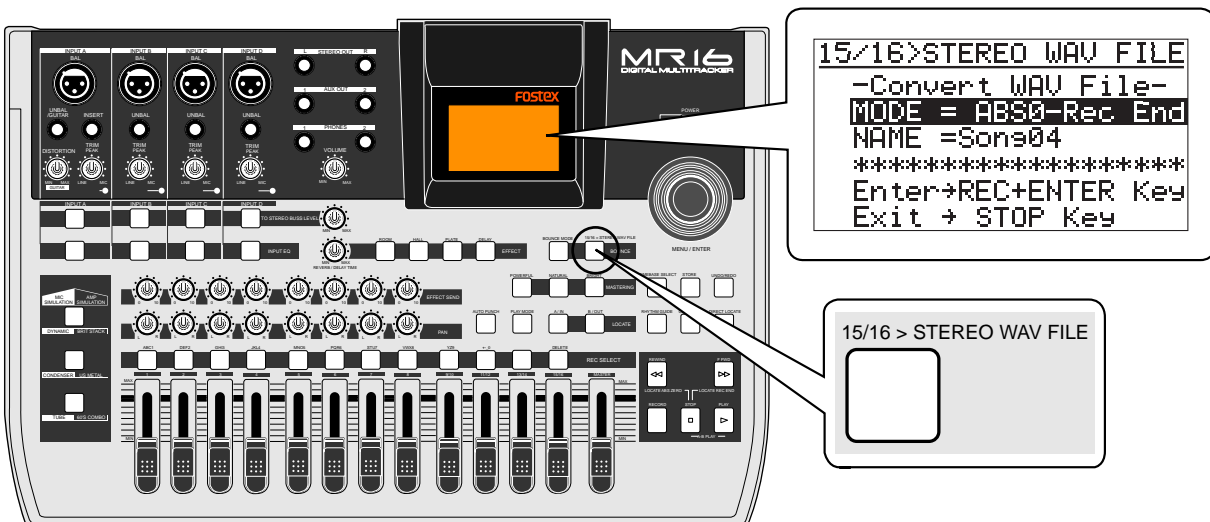

Procedure of file conversion

The following assumes that the song whose track data you want to convert is loaded.

- 1) While the recorder is stopped, press the [15/16 > STEREO WAV FILE] key to enable the file conversion function.

The display shows the "15/16 > STEREO WAV FILE" screen, on which "ABS0-Rec End" is highlighted.

```
15/16>STEREO WAV FILE
-Convert WAV File-
MODE = ABS0-Rec End
NAME =Sone04
*****
Enter→REC+ENTER Key
Exit → STOP Key
```

- 2) Press the [MENU/ENTER] knob. "ABS0-Rec End" starts flashing, and you can now select the conversion range between "ABS0-Rec End" and "LOCATE A - LOCATE B".

```
15/16>STEREO WAV FILE
-Convert WAV File-
MODE = ABS0-Rec End
NAME =Sone04
*****
SEL → MENU dial
Exit → STOP Key
```

Flashing

To convert all track data, select "ABS0-Rec End". To convert a specified range, select "LOCATE A - LOCATE B".

- 3) Rotate the [MENU/ENTER] knob to select the conversion range and press the [MENU/ENTER] knob.

The selection is confirmed and the display returns to the previous screen.

"NAME = *****" shows the name for the converted file, and you can enter a desired name. Initially, it shows the name of the source file, therefore, if you do not change the name, the same file name is given.

The following assumes that the file name is not changed. For details about how to edit a name, see "Editing a file name" on the next page.

When you convert data in the same song more than once, you have to give a different name for each converted file. See the <Note> on the next page.

- 4) Press the [MENU/ENTER] knob while holding down the [RECORD] key.

The file conversion starts and the percent number on the screen counts up as the conversion progresses.

To cancel the conversion in the middle, press the [STOP] key.

```
15/16>STEREO WAV FILE
-Convert WAV File-
Converting...
00 %
Cancel → STOP Key
```

<Note>: If you cancel the conversion in the middle, no file (incomplete file) is created.

When the conversion is completed, the display shows "Completed".

```
15/16>STEREO WAV FILE
-Convert WAV File-
Completed
Press ENTER Key
```

- 5) Press the [MENU/ENTER] knob.

The MR16 quits the conversion function and the display returns to the home screen.

<Note>: If you convert data with the same name as previously converted data, the following screen appears on the display. This screen warns you that the WAV file with the same name already exists and asks you to carry out the conversion by overwriting the existing file or cancel the conversion.

```
15/16>STEREO WAV FILE
- Convert WAV File -
Same file name
exists!
Overwrite Prev File?
[NO] [YES]
```

If you carry out the conversion by overwriting the existing file, rotate the [MENU/ENTER] knob to move the cursor to "[YES]", and press the [MENU/ENTER] knob.

If you do not want to overwrite the existing file, rotate the [MENU/ENTER] knob to move the cursor to "[NO]", then press the [MENU/ENTER] knob. The display returns to show the screen for editing the file name, so you can enter a different file name and then carry out the conversion.

If you want to cancel the conversion when the screen above is shown, rotate the [MENU/ENTER] knob to move the cursor to "[NO]" and press the [MENU/ENTER] knob to show the screen for editing the file name, and then press the [STOP] key to quit the conversion function.

<Editing a file name>

You can edit a file name by the following procedure.

- 1) **After selecting the range of track data to be converted, rotate the [MENU/ENTER] knob to move the cursor to "NAME" and press the [MENU/ENTER] knob.**

The rightmost character of the file name starts flashing. You can now start editing.

```
15/16>STEREO WAV FILE
-Convert WAV File-
MODE = ABS0-Rec End
NAME =Sona04
*****
Enter→REC+ENTER Key
Exit → STOP Key
```

```
15/16>STEREO WAV FILE
-Convert WAV File-
MODE = ABS0-Rec End
NAME =Sona04
*****
SEL → MENU dial
Exit → STOP Key
```

Flashing

While the rightmost character is flashing, pressing the [DELETE] key repeatedly deletes the current file name.

- 2) **Enter a new name using the character entry keys.**
Pressing a different character entry key automatically moves the cursor right. If two successive characters are assigned to the same character entry key, rotate the [MENU/ENTER] knob after selecting the first character to move the cursor right.

- 3) **After entering a new name, press the [MENU/ENTER] knob.**

The entered name is set and the display returns to the previous screen. The screen example below shows the name is set to "Original Name".

```
15/16>STEREO WAV FILE
-Convert WAV File-
MODE = ABS0-Rec End
NAME =Original Name
*****
Enter→REC+ENTER Key
Exit → STOP Key
```

Then, by pressing the [MENU/ENTER] knob while holding down the [RECORD] key to carry out the WAV file conversion.

Exporting data to a personal computer

The unit is equipped with the [USB] port for directly connecting to a personal computer using a USB cable. Via USB connection, you can export audio data converted to a stereo WAV file to a personal computer. The exported file can be played back or edited on the personal computer, or can be burned to an original audio CD using the software application (WAV Manager) provided by Fostex. You can also use the export function for data backup purpose.

Connection to a personal computer

Connect the [USB] port of the MR16 to the USB port of a personal computer using a USB cable, as shown above. (A USB cable is not supplied with the MR16.)

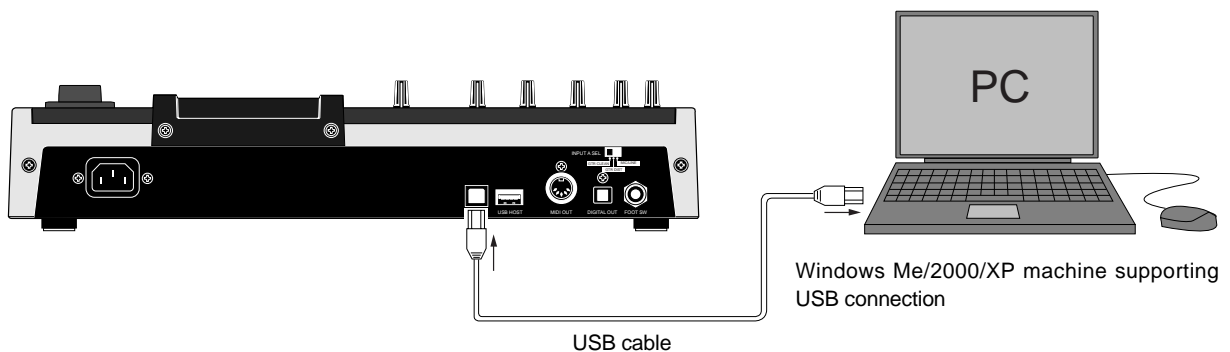

<Caution>: Use the [USB] port for connection to a personal computer. Do not connect the [USB HOST] port to a personal computer.



<Note>: Only Windows Me, 2000 and XP computers, as well as Macintosh computers with OS X or higher, can be used with the MR16. Other computers cannot be used. Check your computer before making connection.

<Notes on USB connection with Mac OS>

When making USB connection with a Macintosh computer, note that only Mac OS X or higher is supported. Do not connect to a Macintosh computer with the earlier version. The song data on the MR16 may be damaged.

* All company names and model names mentioned in this manual are trademarks or registered trademarks of their respective holders.

<About downloading WAV Manager>

You can download WAV Manager, a software application for multitrack recording provided by Fostex, from Fostex web site (<http://www.fostex.com>). Before importing a WAV file from the MR16 or creating an audio CD, download WAV Manager and install it to your personal computer. For details about how to use WAV Manager, see the manual supplied with the downloaded file.

Exporting a WAV file to a personal computer

The following describes the procedure for exporting a WAV file to a Windows ME computer.

<Note>: You can export only a stereo WAV file which is converted from a pair of mono WAV files on tracks 15/16, as described earlier in "WAV file conversion". A mono WAV file or undo file cannot be exported to a personal computer.

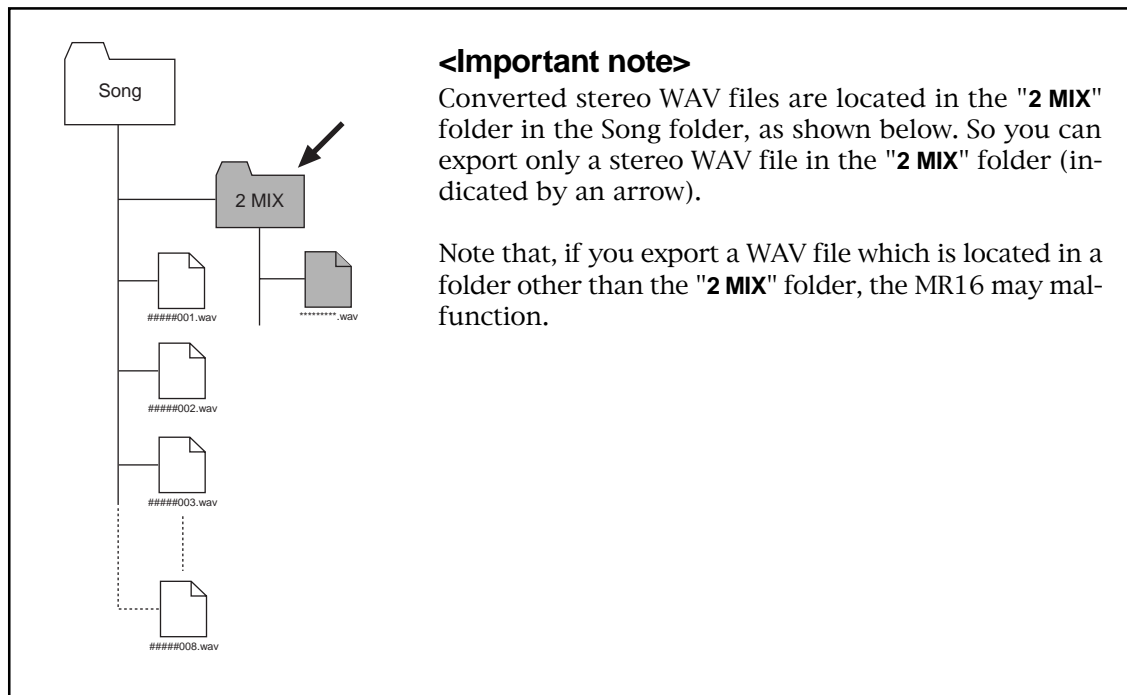

<Important note>

Converted stereo WAV files are located in the "2 MIX" folder in the Song folder, as shown below. So you can export only a stereo WAV file in the "2 MIX" folder (indicated by an arrow).

Note that, if you export a WAV file which is located in a folder other than the "2 MIX" folder, the MR16 may malfunction.

<Disk protection>

By default, the "disk protect" function which is effective in the USB mode is set to "On". In this condition, the MR16 can export data to a personal computer but cannot import data from a computer. This is for protecting the MR16 internal hard disk from importing a file from a computer inappropriately and destroying the MR16 song data.

You can enable or disable this function, however, we recommend using the MR16 by setting it to "On".

If you use the MR16 by setting the "disk protect" function to "Off", read "Archiving a song" on page 111 before using. See page 110 for details about how to make the "disk protection" setting.

<Note on backup>

When exporting song data on the hard disk to a personal computer for backup, always export the whole song folder. You cannot export individual track data.

See "Archiving a song" on page 111 for details about song data backup.

- 1) Turn on the power of the personal computer and the MR16.
- 2) Press the [MENU/ENTER] knob to enter the menu mode.

The display now shows the first page of the menu selection screen, where "◀◀ Back" is highlighted initially.

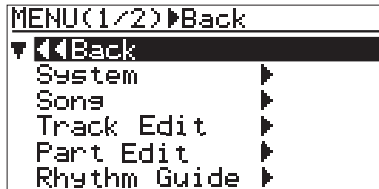

- 3) Highlight "USB ▶" by rotating the [MENU/ENTER] knob, then press the [MENU/ENTER] knob. The display shows the USB menu screen.

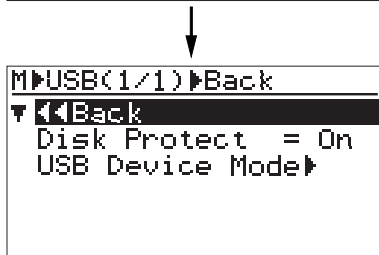
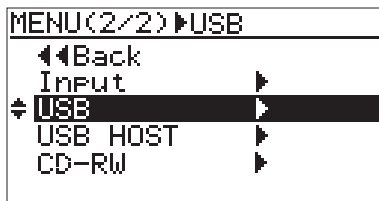

- 4) Rotate the [MENU/ENTER] knob to move the cursor to "USB Device Mode ▶", and press the [MENU/ENTER] knob. The MR16 enters the USB mode and the display shows the screen as below.

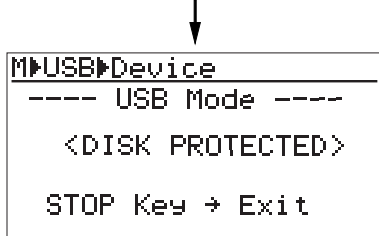
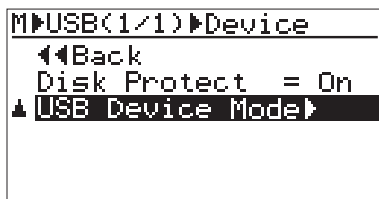

<Note>: By default, the disk protect function is enabled. In this condition, when the MR16 enters the USB mode, "<DISK PROTECTED>" is shown in the USB screen, as above.

<Note>: While the MR16 is in the USB mode, all keys except the [STOP] key are ineffective. Pressing the [STOP] key exits the USB mode.

- 5) Connect the MR16 to a personal computer using a USB cable.
- 6) Open "My computer" on the computer screen. You see the "Removable disk" drive added on the computer. The first time you connect the MR16, the device driver is installed automatically.
- 7) Open the added Removable disk drive, and select the stereo WAV file in the desired song folder, then copy to the computer.

When you open the added Removable disk drive, the contents of the MR16 hard disk are shown, in which you can see all the song folders.

Open the "2 MIX" folder in the desired song folder, and select the stereo WAV file, then copy it to the computer.

<Note>: After copying a WAV file in the folder to a computer, the original file remains. However, if you execute "move to another folder", the original file on the disk is lost.

- 8) When the data export completes, disconnect the MR16 from the personal computer.

<Note>: To disconnect the MR16 from the personal computer after completing the data export, make sure that the [RECORD] key indicator is not lit, and follow the procedure for hardware disconnection of Windows.

- 9) Press the [STOP] key to exit the menu mode.

Protecting the hard disk

The MR16 internal hard disk is protected by default.

The protection is effective only in the USB mode in which the MR16 is used with a personal computer. You can make the hard disk “**read only**” (protected) or “**read/write enabled**” (unprotected). The default is “**read only**”. As mentioned earlier in “<Disk protection>” on page 108, if you transfer song data from a computer to the MR16 improperly, the data may be damaged. To avoid such an accident, we recommended enabling hard disk protection. To disabling the disk protection, follow the procedure below.

- 1) While the recorder is stopped, press the [MENU/ENTER] knob to enter the menu mode.

```
MENU(1/2)▶Back
▼◀◀Back
System ▶
Songs ▶
Track Edit ▶
Part Edit ▶
Rhythm Guide ▶
```

- 2) Rotate the [MENU/ENTER] knob to select “USB▶” on the second page, and press the [MENU/ENTER] knob.

The display now shows the USB menu screen, where “◀◀ Back” is highlighted.

```
MENU(2/2)▶USB
◀◀Back
Input ▶
◄ USB ▶
USB HOST ▶
CD-RW ▶
```

```
M▶USB(1/1)▶Back
▼◀◀Back
Disk Protect = On
USB Device Mode▶
```

- 3) Rotate the [MENU/ENTER] knob to highlight “Disk Protect=***”, and press the [MENU/ENTER] knob. The current setting (the default is “On”) flashes.

```
M▶USB(1/1)▶Protect
◀◀Back
◄ Disk Protect = On
USB Device Mode▶
```

```
M▶USB(1/1)▶Protect
◀◀Back
Disk Protect = On
USB Device Mode▶
```

- 4) Rotate the [MENU/ENTER] knob to select “Off”, and press the [MENU/ENTER] knob.

The selection is confirmed and the display returns to the previous screen.

```
M▶USB(1/1)▶Protect
◀◀Back
Disk Protect = Off
USB Device Mode▶
```

```
M▶USB(1/1)▶Protect
◀◀Back
◄ Disk Protect = Off
USB Device Mode▶
```

Off	The disk is “ read/write enabled ” (unprotected). You can transfer data between the MR16 and a computer in both ways.
On	The disk is “ read only ” (protected). You can transfer data only from the MR16 to a computer (default setting).

- 5) Press the [STOP] key to exit the menu mode.

<Note>: When you enter the USB mode while the disk protection is disabled, the screen as below is shown. In this condition, the hard disk is “**read/write enabled**” and you can bi-directionally transfer song data between a computer and the MR16.

```
M▶USB▶Device
---- USB Mode ----

STOP Key → Exit
```

Archiving a song

You can archive song data recorded by the MR16 by using either of the following methods.

(1) Using the WAV Manager supplied by Fostex

The WAV Manager converts each track data to a single mono file. Data is compressed so you can save the file in small size to a personal computer. This method is useful for exporting data to a PC software application for multitrack recording.

For details about how to use the WAV Manager, see the owner's manual supplied with the WAV Manager. You can download the WAV Manager from Fostex web site (<http://www.fostex.com>).

(2) Using drag & drop technique

You can copy a song folder using drag & drop technique. This method allows saving all data in the folder (including the history data, etc.).

• Exporting data to a personal computer

- 1) **Connect the MR16 to a personal computer via USB, and open the root folder.**
You can copy each song folder in the root folder to the personal computer.
- 2) **Copy a desired song folder to the personal computer using drag & drop technique.**
- 3) **After making copy, exit the USB mode.**

<Note>: When drag & drop the folder on your personal computer, use the "copy" function. If you use the "move" function, not only the song on the MR16 is deleted but also other songs on the MR16 may be destroyed. We recommend to enable the disk protection (the default is "enabled") when executing data copy.

Using this method, you can also copy the hidden folder which includes hidden files "deleted" by the MR16 song management operation. Copied hidden files can be used as a normal song files by turning off the hidden attribute by the computer.

<Note>: If you cannot see the hidden folder, consult the manual of your personal computer.

• Importing data from a personal computer

When importing data from a personal computer to the MR16, there is the danger that the MR16 file system may be destroyed. Especially, deleting or adding files many times may cause the fragmentation of FAT32, resulting in sound jump caused by performance deterioration. Therefore, before loading data from a personal computer to the MR16, save all necessary folders to the personal computer and format the MR16 hard disk.

- 1) **Format the MR16 internal hard disk (see page 140).**
- 2) **Disable the disk protection (see page 110).**
- 3) **Connect the MR16 to a personal computer via USB (see page 109).**
- 4) **Copy the desired song folder on the personal computer to the root folder of the MR16 hard disk.**

<Note>: Do not use "move" operation, as with saving data to a computer.

- 5) **Repeat step 4) as many times as required.**

<Note>: Usually, the song order follows the copied order. However, it may be different depending on a computer OS.

- 6) **After making copy of all necessary folders, exit the USB mode.**

(3) Copy data to a CD-R/RW disc using the internal CD-R/RW drive.

As with (1), each track data is converted to a single mono WAV file.

The data is compressed to a small size and saved to a CD-R/RW disc. See the supplementary manual "How to use the CD-R/RW drive" for details.

<Note>: The operation above can be done with the MR16 with the built-in CD-R/RW drive. You cannot do above with the MR16 without a CD-R/RW drive.

Song management

This chapter explains the following five operation procedures for song management.

- 1) **Selecting the desired song.**
- 2) **Editing a song name.**
- 3) **Deleting an unnecessary song.**
- 4) **Protecting a song.**

<Notes>

While a menu screen is shown, you can go up the menu screen level or directly exit the menu mode by the following operations.

- (1) **Select “◀ Back” on a menu screen and press the [MENU/ENTER] knob.**
The display returns to the previous (upper level) screen.
Repeating this operation finally exits the menu mode.
- (2) **Press the [REWIND] key.**
The display returns to the previous (upper level) screen.
Repeating this operation finally exits the menu mode.
- (3) **Press the [STOP] key.**
The menu mode exits and the display shows the home screen.

Selecting the desired song

The following describes how to select the desired song from the disk when more than one song is created on the disk. You can also create a new song by the similar procedure. See "Basic operations" (page 33) for details about how to create a new song.

- 1) While the recorder is stopped, press the [MENU/ENTER] knob to enter the menu mode. The display now shows the first page of the menu selection screen.

```
MENU(1/2)▶Back
▼◀◀Back
System ▶
Songs ▶
Track Edit ▶
Part Edit ▶
Rhythm Guide ▶
```

- 2) Rotate the [MENU/ENTER] knob to select "Song ▶", and press the [MENU/ENTER] knob. The display now shows the song menu screen, where "◀◀ Back" is highlighted.

```
MENU(1/2)▶Songs
◀◀Back
System ▶
◀◀Songs ▶
Track Edit ▶
Part Edit ▶
Rhythm Guide ▶
```

```
M▶Songs(1/2)▶Back
▼◀◀Back
Select Songs ▶
Rename Songs ▶
Delete Songs ▶
Songs Protect = Off
Select 2mix ▶
```

- 3) Rotate the [MENU/ENTER] knob to select "Select Song ▶" and press the [MENU/ENTER] knob. The display now shows the song list screen.

```
M▶Songs(1/2)▶Select
◀◀Back
◀◀Select Songs ▶
Rename Songs ▶
Delete Songs ▶
Songs Protect = Off
Select 2mix ▶
```

```
M▶Songs▶SelectSongs(1/1)
◀◀Back
S01:*****
S02:*****
S03:*****
S04:*****
---:(New Song)
```

The screen example above shows that four songs are currently created on the hard disk. The song list is shown on a single page.

When more songs are created, the song list screen has more than one page, and you can scroll the list by rotating the [MENU/ENTER] knob.

"---:(New Song)" at the bottom of the screen is used when you create a new song.

- 4) Rotate the [MENU/ENTER] knob to select the desired song number/song name, and press the [MENU/ENTER] knob.

The display returns to the song menu screen, where "Select Song ▶" is highlighted.

```
M▶Songs▶SelectSongs(1/1)
◀◀Back
S01:*****
◀◀S02:*****
S03:*****
S04:*****
---:(New Song)
```

```
M▶Songs(1/2)▶Select
◀◀Back
◀◀Select Songs ▶
Rename Songs ▶
Delete Songs ▶
Songs Protect = Off
Select 2mix ▶
```

- 5) Press the [STOP] key to exit the menu mode. The display shows the home screen of the selected song.

Editing a song name

You can edit a current song name save the edited song name. Only the current song can be edited.

- 1) Load the desired song of which you are going to edit the song name.
- 2) While the recorder is stopped, press the [MENU/ENTER] knob to enter the menu mode. The display now shows the first page of the menu selection screen.

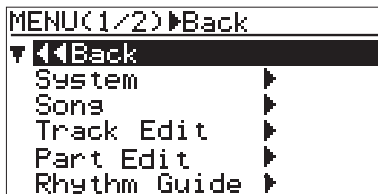

- 3) Rotate the [MENU/ENTER] knob to select "Song ▶", and press the [MENU/ENTER] knob. The display now shows the song menu screen, where "◀ Back" is highlighted.

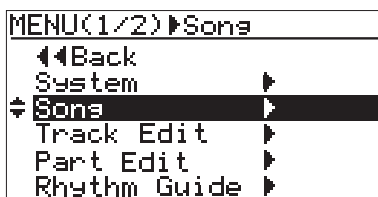

- 4) Rotate the [MENU/ENTER] knob to select "Rename Song ▶", then press the [MENU/ENTER] knob. The display now shows the screen for song name editing of the current song, on which the rightmost character of song name flashes.

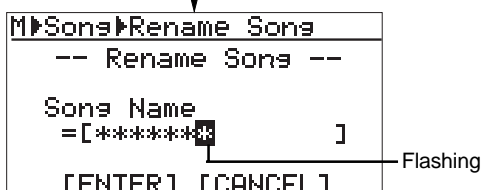
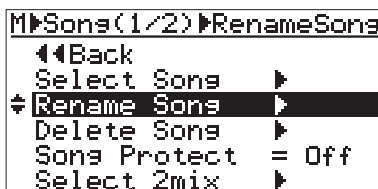

- 5) Use the character entry keys to enter the desired character to the flashing point.

You can move the cursor (flashing point) by rotating the [MENU/ENTER] knob (or by pressing another character entry key).

<Character entry keys>

A B C 1

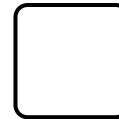

[REC SELECT] keys on the MR16 top panel act as character entry keys in the menu mode. For example, the [REC SELECT] key for track 1 (shown on the left) can be used for entering A, B, C, a, b, c and 1.

<[DELETE] key>

DELETE

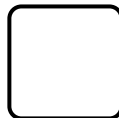

Pressing the [DELETE] key (the [REC SELECT] key of the track 15/16) deletes the character at the flashing point. By pressing this key repeatedly, you can delete all characters under the flashing point.

<Note>: If you enter the same name as an existing song or do not enter a name in step 5 and press the [MENU/ENTER] knob in step 6 below, the display shows "Illegal Song Name!" and returns to the song name editing screen.

- 6) After entering the name, press the [MENU/ENTER] knob.

The cursor moves to "[ENTER]" at the bottom of the screen. To cancel the operation, use the [MENU/ENTER] knob to highlight "[CANCEL]" and press the [MENU/ENTER] knob.

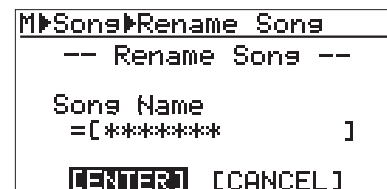

- 7) Press the [MENU/ENTER] knob again. The edited name is stored and the display returns to the song menu screen, where "Rename Song ▶" is highlighted.
- 8) Press the [STOP] key to exit the menu mode. The MR16 exits the menu mode and the display shows the home screen where the edited song name is displayed.

Deleting an unnecessary song

You can delete a song created on the hard disk.

<Notes>

- You cannot delete a song which is protected. To delete such a song, release the protection of the song first (see the next page).
- A deleted song file still remains as a "hidden file" on the hard disk. So deleting a song file does not increase the remaining (recordable) space of the hard disk.
- You can export a "hidden file" to your personal computer via USB connection and use it on the computer (see page 111).

- 1) While the recorder is stopped, press the [MENU/ENTER] knob to enter the menu mode. The display now shows the first page of the menu selection screen.

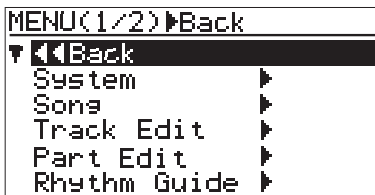

- 2) Rotate the [MENU/ENTER] knob to select "Song ▶", and press the [MENU/ENTER] knob. The display now shows the song menu screen.

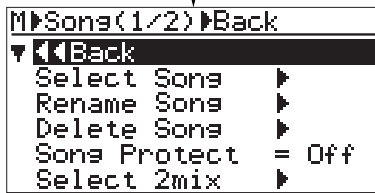
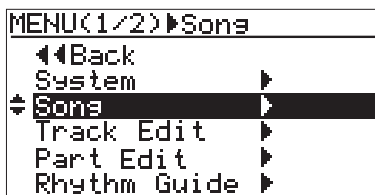

- 3) Rotate the [MENU/ENTER] knob to select "Delete Song ▶", and press the [MENU/ENTER] knob. The display now shows the list of songs created on the hard disk, from which you select a song to be deleted. In the screen example below, five songs are created so the list has only one page.

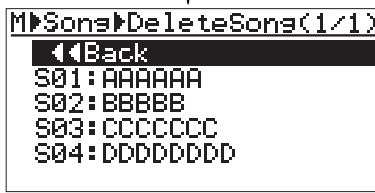
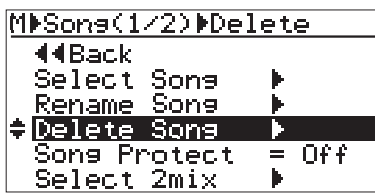

- 4) Rotate the [MENU/ENTER] knob to select a song to be deleted, and press the [MENU/ENTER] knob. The display shows warning and confirmation for deleting the song.

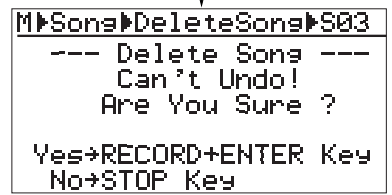
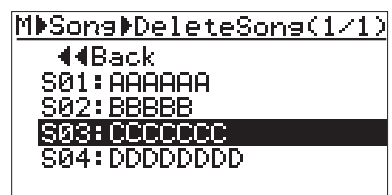

- 5) Press the [MENU/ENTER] knob while holding down the [RECORD] key. The selected song is deleted, and the display returns to the song list screen.

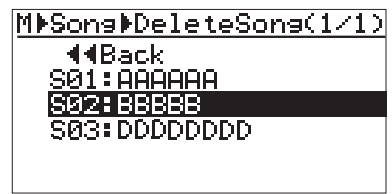

Any song number greater than the song number of the deleted song is moved up. In the screen example above, after Song 03 is deleted, ex-Song 04 is moved up to Song 03 and ex-Song 05 is moved up to Song 04.

- 6) Press the [STOP] key to exit the menu mode. In the example above, the display now shows the home screen of new Song 03 (ex-Song 04).

If you delete all songs on the hard disk by repeating the procedure above, "(New Song)" is shown. Then, create a new song (see page 33).



Protecting a song

You can protect a song to prevent an accidental erasure. The protection can be released whenever you want. To keep a recorded song safely, we recommend protecting it. You can make protection setting only for the current song.

- 1) Load the song you want to protect.
- 2) While the recorder is stopped, press the [MENU/ENTER] knob to enter the menu mode. The display now shows the first page of the menu selection screen.

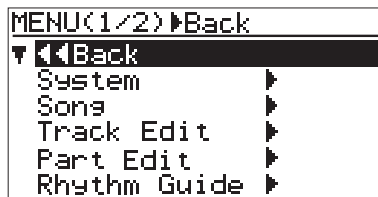

- 3) Rotate the [MENU/ENTER] knob to select "Song", and press the [MENU/ENTER] knob. The display now shows the song menu screen.

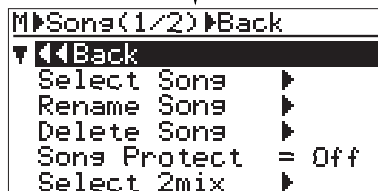
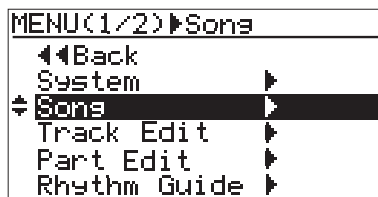

- 4) Rotate the [MENU/ENTER] knob to select "Protect=***", then press the [MENU/ENTER] knob. The current option ("On" or "Off") flashes. The default option is "Off".

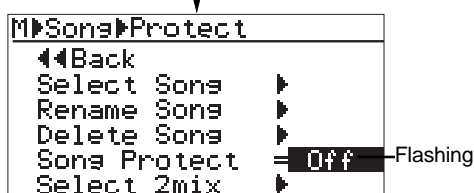
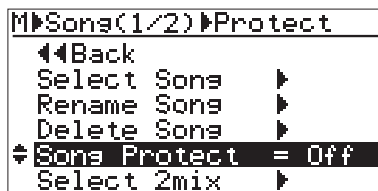

- 5) Rotate the [MENU/ENTER] knob to select "On", and press the [MENU/ENTER] knob. The current song is now protected. The display returns to the previous screen.

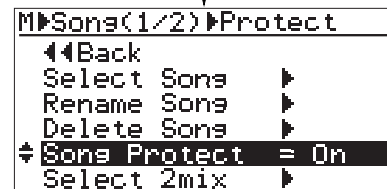
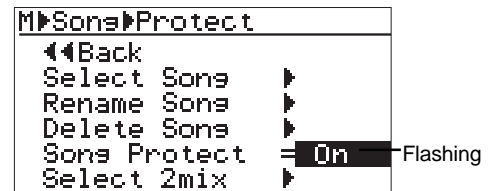

To release the protection, carry out the same procedure above but select "Off" and press the [MENU/ENTER] knob in step 5.

<Note>: You cannot make recording or editing to a protected song. If you want to make recording or editing to a protected song, you must release the protection first.

<Note>: When you set the protection to "On", all the recording-related keys, such as the [REC SELECT] and [BOUNCE MODE] keys, are turned off.

- 6) Press the [STOP] key to exit the menu mode.

<Tips>

When the protected song is loaded, "🔒" is shown in the upper left corner of the Home screen (indicated by the arrow in the screen example below).

When this icon is shown, you cannot make recording or edit the song.



Track editing

This chapter describes how to edit whole data of a selected (mono or stereo) track. Track editing does not consume the hard disk space. Therefore, the remaining space of the disk does not change by executing track editing.

<Undo/redo of track editing>

By pressing the [UNDO/REDO] key after executing track editing, you can undo the editing. By pressing the [UNDO/REDO] key after the undo operation, you can return the track(s) to the condition after being edited.

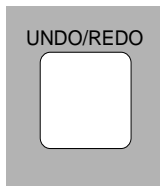

<Notes>

Also note that, if you carry out any of the following after editing, you cannot undo the editing anymore.

1. Making new recording
2. Making new editing
3. Turning off the power
4. Loading another song

<Notes>

While a menu screen is shown, you can go up the menu screen level or directly exit the menu mode by the following operations.

- (1) **Select “◀ Back” on a menu screen and press the [MENU/ENTER] knob.**
The display returns to the previous (upper level) screen.
Repeating this operation finally exits the menu mode.
- (2) **Press the [REWIND] key.**
The display returns to the previous (upper level) screen.
Repeating this operation finally exits the menu mode.
- (3) **Press the [STOP] key.**
The menu mode exits and the display shows the home screen.

Erasing track data

You can erase whole data (from ABS ZERO to REC END) of the desired track(s) of the song currently loaded.

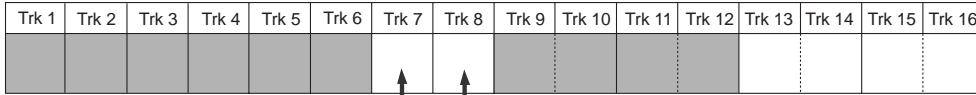
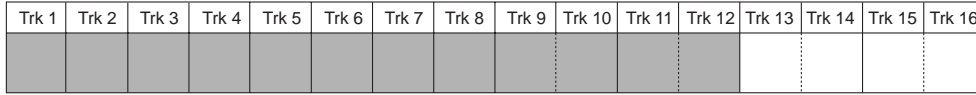

Deleting data of tracks 7 and 8.

<Note>: You cannot erase track data of a song protected.

- 1) Load the song you want to edit.
- 2) While the recorder is stopped, press the [MENU/ENTER] knob to enter the menu mode. The display now shows the first page of the menu selection screen.

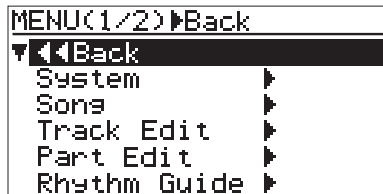

- 3) Rotate the [MENU/ENTER] knob to select "Track Edit >", and press the [MENU/ENTER] knob. The display now shows the track edit menu screen.

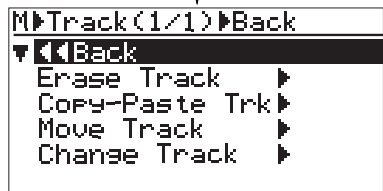

- 4) Rotate the [MENU/ENTER] knob to select "Erase Track >", and press the [MENU/ENTER] knob. The display now shows the screen for selecting the track(s) to be erased.

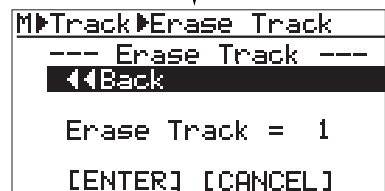
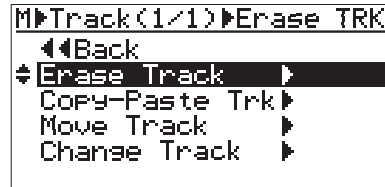

- 5) Rotate the [MENU/ENTER] knob to select "Erase Track = *", and press the [MENU/ENTER] knob. The currently selected option flashes and you can now select the desired option by rotating the [MENU/ENTER] knob. The available options are:

- 1 through 8 (mono track)
- 1/2, 3/4, 5/6, 7/8, 9/10, 11/12, 13/14 and 15/16 (stereo tracks)

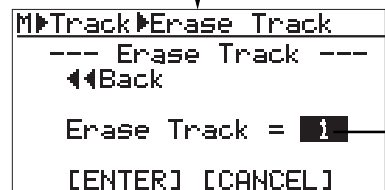
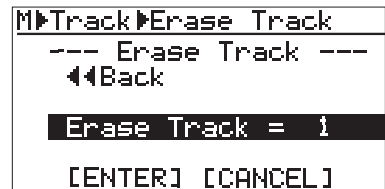

- 6) Rotate the [MENU/ENTER] knob to select the desired option, and press the [MENU/ENTER] knob. "Erase Track = *" is now highlighted on the screen.
- 7) Rotate the [MENU/ENTER] knob to move the cursor to "[ENTER]" on the screen, and press the [MENU/ENTER] knob. The display shows "Please Wait", immediately followed by "Completed" when the MR16 completes erasing.

- 8) Press the [MENU/ENTER] knob. The display now returns to the track edit menu screen, where "Erase Track ▶" is highlighted.
- 9) Press the [STOP] key to exit the menu mode.

<Note>: If you are not satisfied with the result, press the [UNDO/REDO] key to undo the operation (see page 119).

<Note>: If you want to cancel the erase operation, move the cursor to "[CANCEL]" on the screen, and press the [MENU/ENTER] knob.

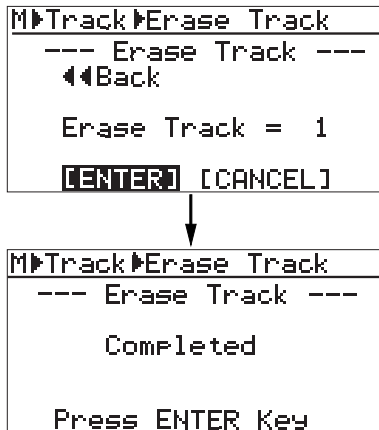

Copying/pasting track data

You can copy whole data (from ABS ZERO to REC END) of the desired track(s) of the song currently loaded and paste it to the other desired track(s). The data on the source track(s) still remains after the copy/paste operation. Copy/paste operation can be done within the currently loaded song.

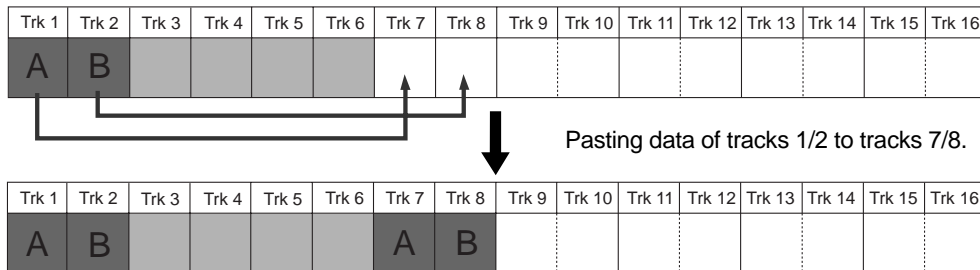

<Note>: You cannot copy/paste track data of a song protected. Release the protection before copying/pasting track data.

- 1) Load the song you want to edit.
- 2) While the recorder is stopped, press the [MENU/ENTER] knob to enter the menu mode. The display now shows the first page of the menu selection screen.

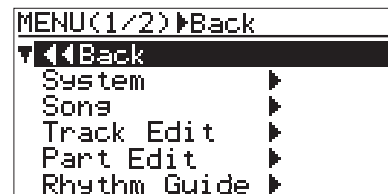

- 3) Rotate the [MENU/ENTER] knob to select "Track Edit ▶", and press the [MENU/ENTER] knob. The display now shows the track edit menu screen.

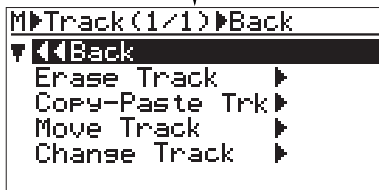
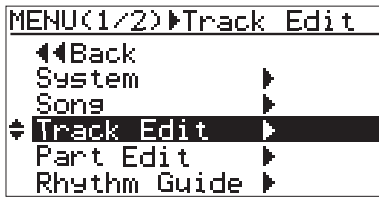

- 4) Rotate the [MENU/ENTER] knob to select "Copy-Paste Trk ▶", and press the [MENU/ENTER] knob. The display now shows the screen for selecting the source track(s) and destination track(s) of copy/paste operation. "Source Track" selects the copy source track(s), while "Dest. Track" selects the paste destination track(s).

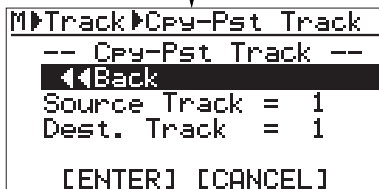
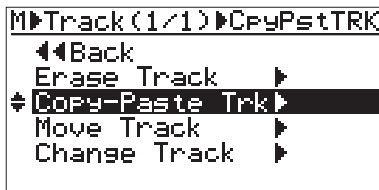

- 5) Rotate the [MENU/ENTER] knob to select "Source Track = *", and press the [MENU/ENTER] knob. You can now select the desired copy source track(s) by rotating the [MENU/ENTER] knob. The available options are:

- 1 through 8 (mono track)
- 1/2, 3/4, 5/6, 7/8, 9/10, 11/12, 13/14 and 15/16 (stereo tracks)

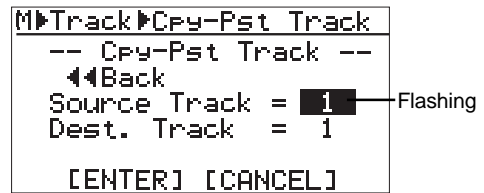
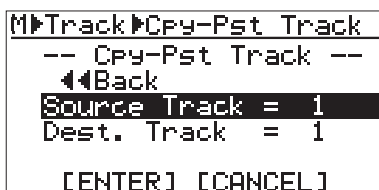

- 6) Rotate the [MENU/ENTER] knob to select the source track(s) to be copied, and press the [MENU/ENTER] knob. You can now select the desired copy destination track(s)

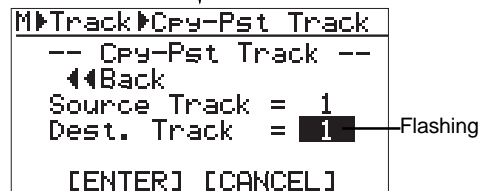
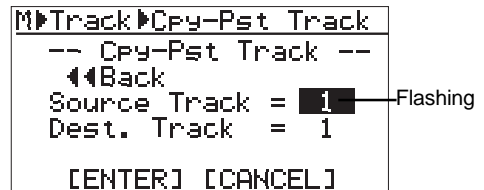

You can select the same number of tracks as the copy source track(s). For example, if you select a mono track for the source, you can only select a mono track for the destination.

<Note>: You cannot select the same track(s) for the copy source and destination.

- 7) Rotate the [MENU/ENTER] knob to select the destination track(s), and press the [MENU/ENTER] knob. "Dest.Track = *" is now highlighted on the screen.

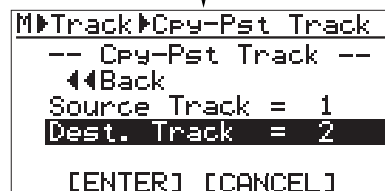
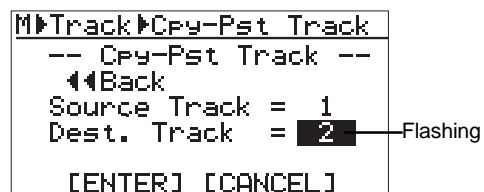

- 8) Rotate the [MENU/ENTER] knob to move the cursor to "ENTER" at the bottom of the screen, then press the [MENU/ENTER] knob. The display shows "Please Wait", immediately followed by "Completed" when the MR16 completes the copy/paste operation.

<Note>: If you want to cancel the copy/paste operation, move the cursor to "[CANCEL]" on the screen, and press the [MENU/ENTER] knob.

```

M▶Track▶Cpy-Pst Track
-- Cpy-Pst Track --
◀◀Back
Source Track = 1
Dest. Track = 2
[MENU/ENTER] [CANCEL]
    
```

```

M▶Track▶Cpy-Pst Track
-- Cpy-Pst Track --
Completed
Press ENTER Key
    
```

<Note>: If a destination track has recorded data, pasting the copied data overwrites the previous data.

- 9) Press the [MENU/ENTER] knob. The display now returns to the track edit menu screen, where "Copy-Paste Trk▶" is highlighted.
- 10) Press the [STOP] key to exit the menu mode.

<Note>: If you are not satisfied with the result, press the [UNDO/REDO] key to undo the operation (see page 119).

Moving track data

You can move whole data (from ABS ZERO to REC END) of the desired track(s) to the other desired track(s). After the data is moved, the original track(s) is(are) silent. You can only move track data within the current song.

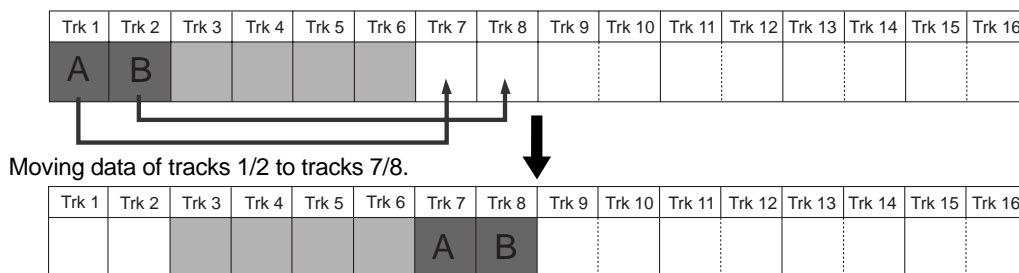

<Note>: Unlike the copy/paste operation, the data on the source track(s) disappears after the move operation.

<Note>: You cannot move track data of a song protected. Release the protection before moving track data.

- 3) Rotate the [MENU/ENTER] knob to select "Track Edit▶", and press the [MENU/ENTER] knob. The display now shows the track edit menu screen.

- 1) Load the song you want to edit.
- 2) While the recorder is stopped, press the [MENU/ENTER] knob to enter the menu mode. The display now shows the first page of the menu selection screen.

```

MENU(1/2)▶Back
▶◀◀Back
System ▶
Song ▶
Track Edit ▶
Part Edit ▶
Rhythm Guide ▶
    
```

```

MENU(1/2)▶Track Edit
▶◀◀Back
System ▶
Song ▶
▶◀◀Track Edit ▶
Part Edit ▶
Rhythm Guide ▶
    
```

```

M▶Track(1/1)▶Back
▶◀◀Back
Erase Track ▶
Copy-Paste Trk▶
Move Track ▶
Change Track ▶
    
```

- 4) Rotate the [MENU/ENTER] knob to select "Move Track", and press the [MENU/ENTER] knob. The display now shows the screen for selecting the source track(s) and destination track(s) of the move operation. "Source Track" selects the move source track(s), while "Dest. Track" selects the move destination track(s).

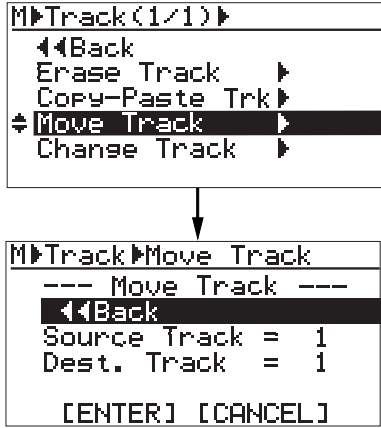

- 5) Rotate the [MENU/ENTER] knob to select "Source Track = *", and press the [MENU/ENTER] knob. You can now select the desired move source track(s) by rotating the [MENU/ENTER] knob. The available options are:

- 1 through 8 (mono track)
- 1/2, 3/4, 5/6, 7/8, 9/10, 11/12, 13/14 and 15/16 (stereo tracks)

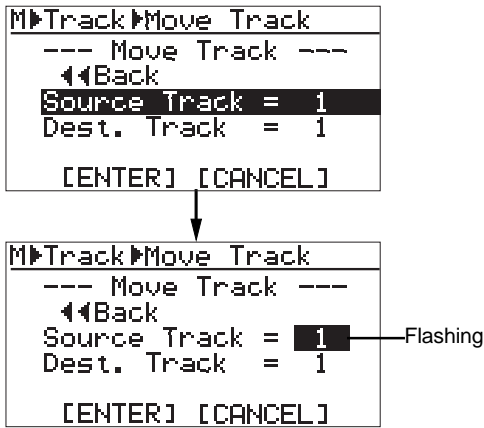

- 6) Rotate the [MENU/ENTER] knob to select source track(s), and press the [MENU/ENTER] knob. You can now select the desired destination track(s).

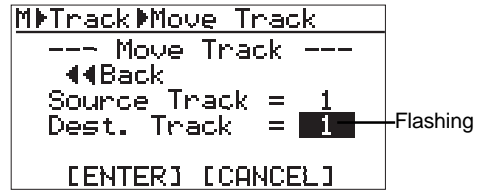
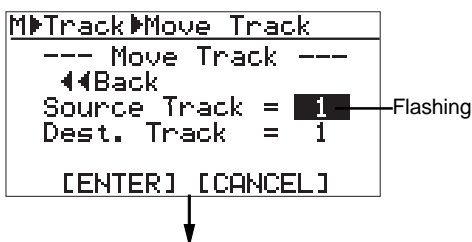

You can select the same number of tracks as the move source track(s). For example, if you select a mono track for the move source, you can only select a mono for the move destination.

<Note>: You cannot select the same track(s) for the move source and destination.

- 7) Rotate the [MENU/ENTER] knob to select destination track(s), and press the [MENU/ENTER] knob. "Dest.Track = *" is now highlighted on the screen.

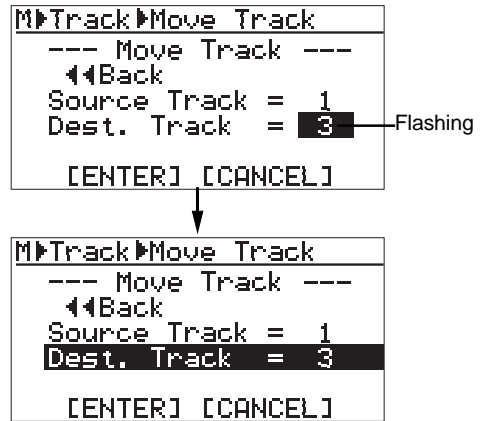

- 8) Rotate the [MENU/ENTER] knob to move the cursor to "[ENTER]" on the screen, and press the [MENU/ENTER] knob. The display shows "Please Wait", immediately followed by "Completed" when the MR16 completes the move operation.

<Note>: If you want to cancel the move operation, move the cursor to "[CANCEL]" on the screen, and press the [MENU/ENTER] knob.

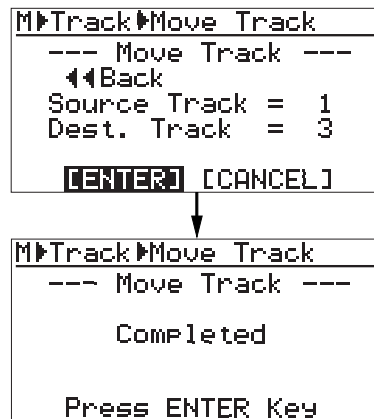

<Note>: If a destination track has recorded data, moving data overwrites the previous data.

- 9) Press the [MENU/ENTER] knob.
The display now returns to the track edit menu screen, where "Move Track ▶" is highlighted.
- 10) Press the [STOP] key to exit the menu mode.

<Note>: If you are not satisfied with the result, press the [UNDO/REDO] key to undo the operation (see page 119).

Exchanging whole track data

You can exchange whole data (from ABS ZERO to REC END) between the desired track(s).

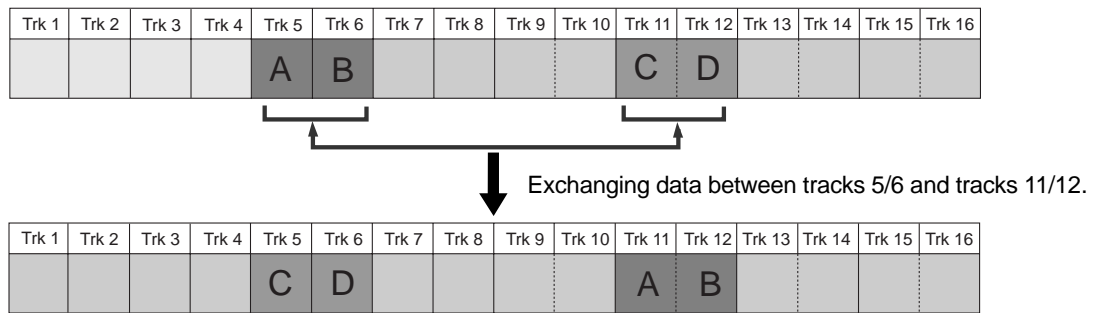

<Note>: You cannot exchange track data of a song protected. Release the protection before exchanging track data.

- 1) Load the song you want to edit.
- 2) While the recorder is stopped, press the [MENU/ENTER] knob to enter the menu mode.
The display now shows the first page of the menu selection screen.

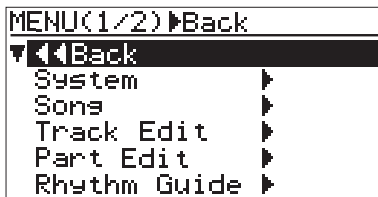

- 3) Rotate the [MENU/ENTER] knob to select "Track Edit ▶", and press the [MENU/ENTER] knob.
The display now shows the track edit menu screen.

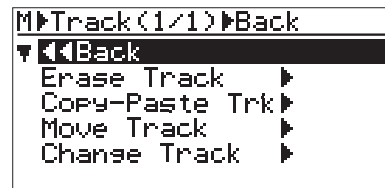
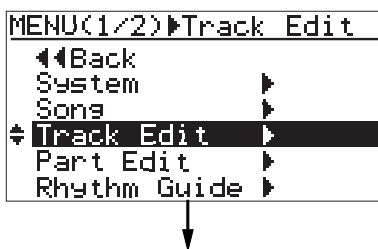

- 4) Rotate the [MENU/ENTER] knob to select "Change Track ▶", and press the [MENU/ENTER] knob.

The display now shows the screen for selecting the source track(s) and destination track(s) of the exchange operation. "Source Track" selects the exchange source track(s), while "Dest. Track" selects the exchange destination track(s).

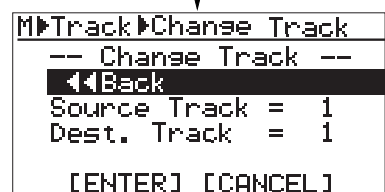
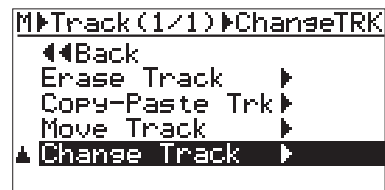

- 5) Rotate the [MENU/ENTER] knob to select "Source Track = *", and press the [MENU/ENTER] knob.

You can now select the desired exchange source track(s) by rotating the [MENU/ENTER] knob. The available options are:

- 1 through 8 (mono track)
- 1/2, 3/4, 5/6, 7/8, 9/10, 11/12, 13/14 and 15/16 (stereo tracks)

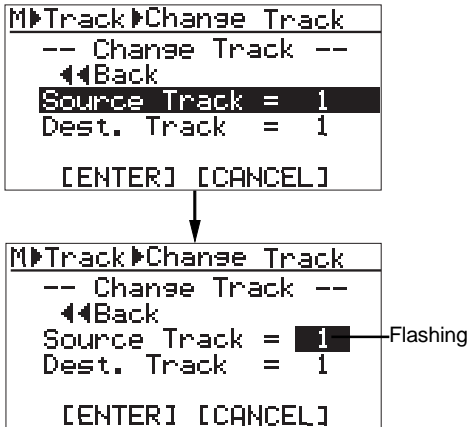

- 6) Rotate the [MENU/ENTER] knob to select the source track(s), and press the [MENU/ENTER] knob. You can now select the desired destination track(s).

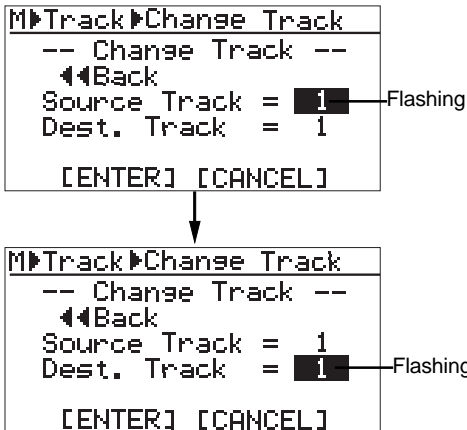

You can select the same number of tracks as the exchange source track(s). For example, if you select a mono track for the exchange source, you can only select a mono track for the exchange destination.

<Note>: You cannot select the same track(s) for the exchange source and destination.

- 7) Rotate the [MENU/ENTER] knob to select the destination track(s), and press the [MENU/ENTER] knob. "Dest.Track = *" is now highlighted on the screen.

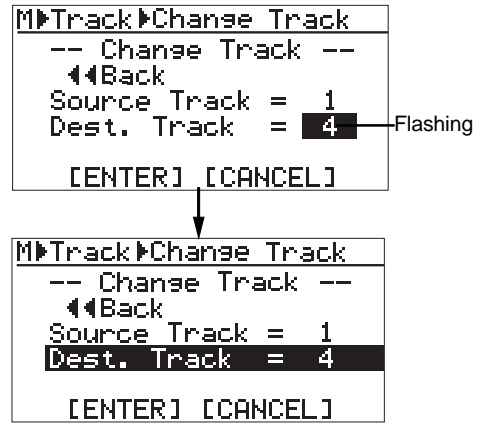

- 8) Rotate the [MENU/ENTER] knob to move the cursor to "[ENTER]" on the screen, and press the [MENU/ENTER] knob. The display shows "Please Wait", immediately followed by "Completed" when the MR16 completes the exchange operation.

<Note>: If you want to cancel the exchange operation, move the cursor to "[CANCEL]" on the screen, and press the [MENU/ENTER] knob.

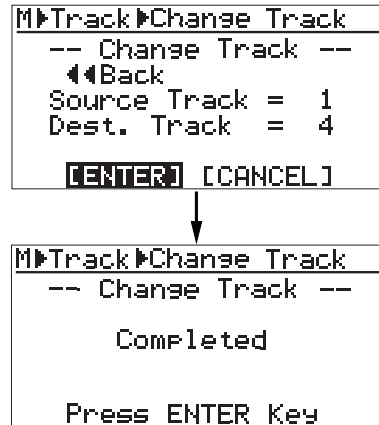

- 9) Press the [MENU/ENTER] knob. The display now returns to the track edit menu screen, where "Change Track ►" is highlighted.
- 10) Press the [STOP] key to exit the menu mode.

<Note>: If you are not satisfied with the result, press the [UNDO/REDO] key to undo the operation (see page 119).

Part editing

This chapter describes how to edit a "part" (*) of recorded song. You can edit data of a track or tracks between the "LOCATE A" and "LOCATE B" points. Part editing does not consume the hard disk space. Therefore, the remaining space of the disk does not change by executing part editing.

<(*) About "part">

A "part" is defined as audio data between the "LOCATE A" and "LOCATE B" points. You can edit a "part" as described later.

Therefore, before carrying out part editing, the "LOCATE A" and "LOCATE B" points must be set. See page 53 for details about how to set these points.

<Undo/redo of editing>

You can undo part editing. By pressing the [UNDO/REDO] key after executing part editing, the song returns to the original condition before editing.

By pressing the [UNDO/REDO] key after undoing part editing, you can again return the song to the condition after being edited.

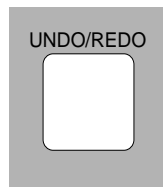

[UNDO/REDO] key

<Notes>

Also note that if you carry out any of the following after editing, you cannot undo the editing anymore.

1. **Making new recording**
2. **Making new editing**
3. **Turning off the power**
4. **Loading another song**

<Notes>

While a menu screen is shown, you can go up the menu screen level or directly exit the menu mode by the following operations.

- (1) **Select "◀◀ Back" on a menu screen and press the [MENU/ENTER] knob.**
The display returns to the previous (upper level) screen.
Repeating this operation finally exits the menu mode.
- (2) **Press the [REWIND] key.**
The display returns to the previous (upper level) screen.
Repeating this operation finally exits the menu mode.
- (2) **Press the [STOP] key.**
The menu mode exits and the display shows the home screen.

Erasing the part(s)

You can erase the part(s) on the selected track(s) of the current song.

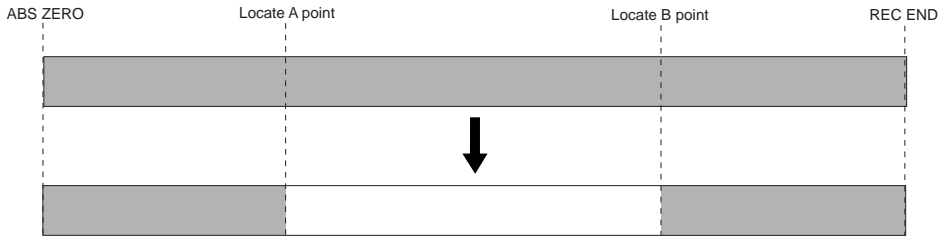

You can delete the desired part(s) on the desired track(s).

<Note>: You cannot erase the part(s) of a song which is protected. Release the song protection before erasing the part(s).

- 1) Load the song you want to edit.
- 2) Set the LOCATE A and LOCATE B points (see page 53).
You can check the part(s) by playing back the recorder between the LOCATE A and LOCATE B points (see page 48).
- 3) While the recorder is stopped, press the [MENU/ENTER] knob to enter the menu mode. The display now shows the first page of the menu selection screen.

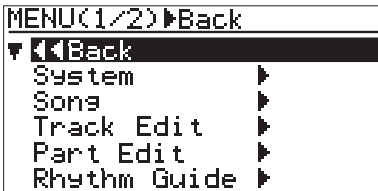

- 4) Rotate the [MENU/ENTER] knob to select "Part Edit", and press the [MENU/ENTER] knob. The display now shows the part edit menu screen.

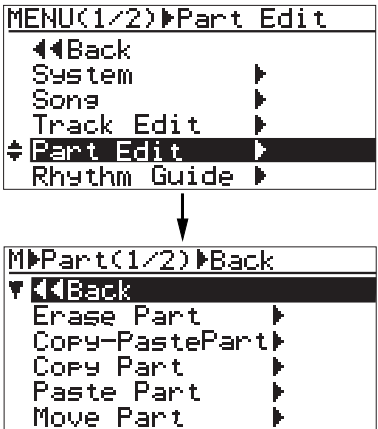

- 5) Rotate the [MENU/ENTER] knob to select "Erase Part", and press the [MENU/ENTER] knob. The display now shows the screen for selecting a track or tracks of which you want to erase the part(s).

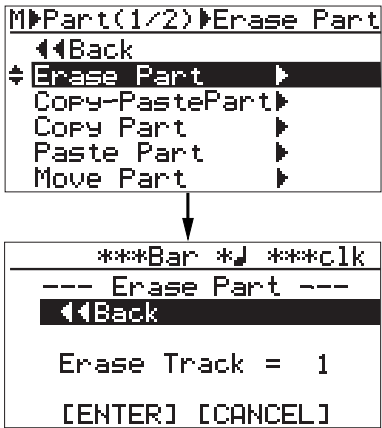

- 6) Rotate the [MENU/ENTER] knob to select "Erase Track = *", and press the [MENU/ENTER] knob. The current option starts flashing and you can now select the desired track(s) by rotating the [MENU/ENTER] knob. The available options are:

- 1 through 8 (mono track)
- 1/2, 3/4, 5/6, 7/8, 9/10, 11/12, 13/14 and 15/16 (stereo tracks)

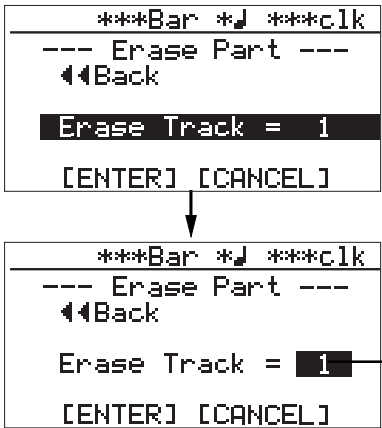

- 7) Rotate the [MENU/ENTER] knob to select the desired option, and press the [MENU/ENTER] knob. The display returns to the previous screen.

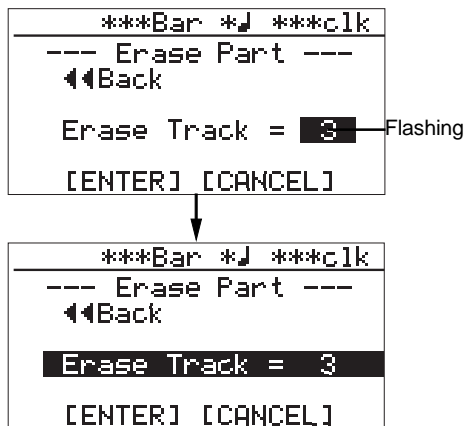

- 8) Rotate the [MENU/ENTER] knob to move the cursor to "[ENTER]" on the screen, and press the [MENU/ENTER] knob.

The display shows "Please Wait", immediately followed by "Completed" when the MR16 completes erasing.

If you want to cancel the part erase operation, move the cursor to "[CANCEL]" on the screen, and press the [MENU/ENTER] knob.

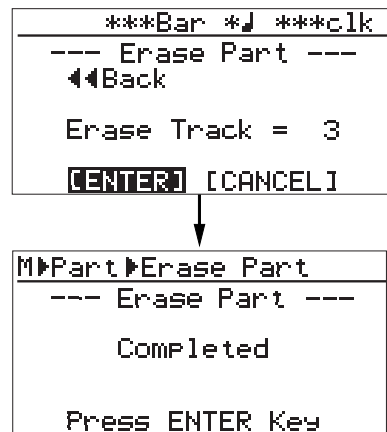

- 9) After pressing the [MENU/ENTER] knob, press the [STOP] key to exit the MENU mode.

<Note>: If you are not satisfied with the result, press the [UNDO/REDO] key to undo the operation (see page 127).

Copying/pasting the desired part(s)-1

You can copy the desired part(s) of the selected track(s) and paste it(them) to the same time position of the other desired track(s). The copy/paste operation of a part or parts can be made only within the current song. You can also make the copy/paste operation of a part or parts using another method described later in "Copying/pasting the desired part(s)-2".

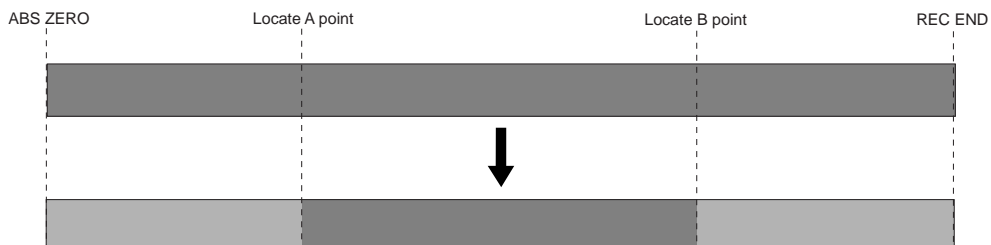

You can copy and paste the desired part(s) on the desired track(s) into the other desired track(s).

<Note>: You cannot copy/paste track data of a song protected. Release the protection before making the copy/paste operation.

<Note>: If you want to paste the copied part(s) to the desired time position of other track(s) other than the position between the LOCATE A and LOCATE B points, use the method described later in "Copying/pasting the desired part(s)-2".

- 3) While the recorder is stopped, press the [MENU/ENTER] knob to enter the menu mode. The display now shows the first page of the menu selection screen.

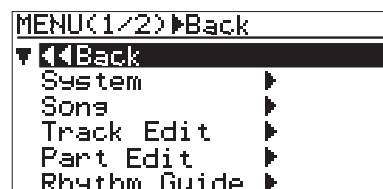

- 1) Load the song you want to edit.
- 2) Set the LOCATE A and LOCATE B points for specifying the desired part(s) (see page 53). You can check the part(s) by playing back between the LOCATE A and LOCATE B points (see page 48).
- 4) Rotate the [MENU/ENTER] knob to select "Part Edit ▶", and press the [MENU/ENTER] knob. The display now shows the part edit menu screen.

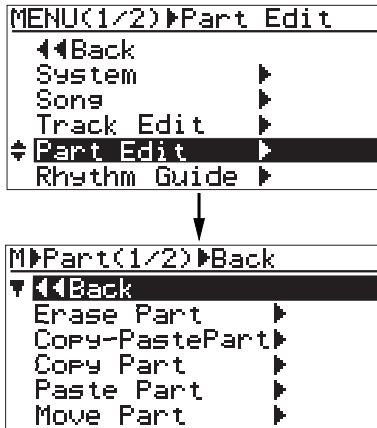

- 5) Rotate the [MENU/ENTER] knob to select "Copy-PastePart", and press the [MENU/ENTER] knob. The display now shows the screen for selecting the source track(s) and destination track(s) of copy/paste.

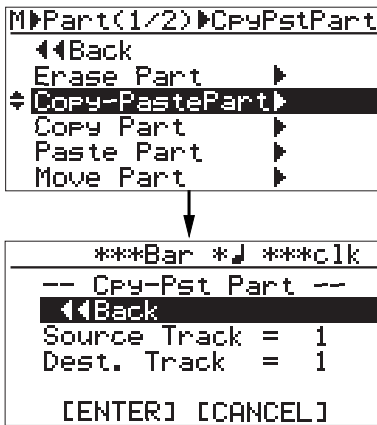

- 6) Rotate the [MENU/ENTER] knob to select "Source Track = *", and press the [MENU/ENTER] knob. The display now shows the screen for selecting the copy source track(s). You can select the copy source track(s) by rotating the [MENU/ENTER] knob. The available options are:

- 1 through 8 (mono track)
- 1/2, 3/4, 5/6, 7/8, 9/10, 11/12, 13/14 and 15/16 (stereo tracks)

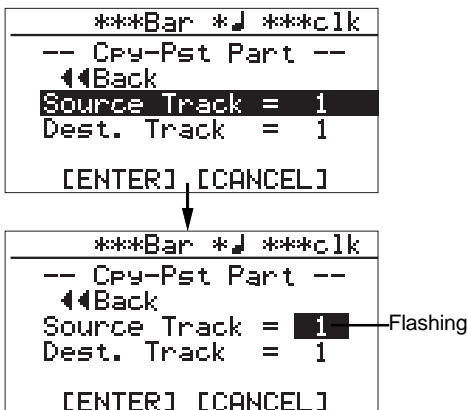

- 7) Rotate the [MENU/ENTER] knob to select the source track(s) to be copied, and press the [MENU/ENTER] knob. You can select the destination track(s) by rotating the [MENU/ENTER] knob. You can select the same number of tracks as the paste source track(s). For example, if you select a mono track for the copy source, you can only select a mono track for paste destination.

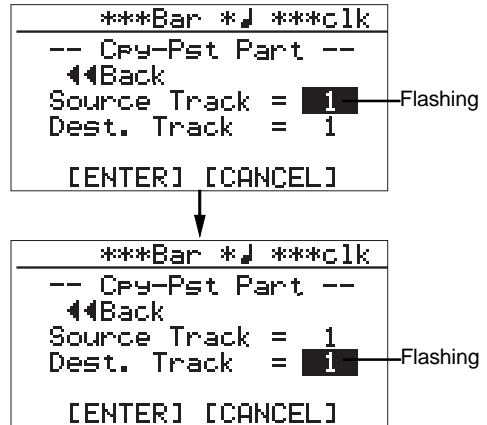

<Note>: You cannot select the same track(s) for the copy source and destination.

- 8) Rotate the [MENU/ENTER] knob to select the destination track(s), and press the [MENU/ENTER] knob. The display returns to the previous screen.

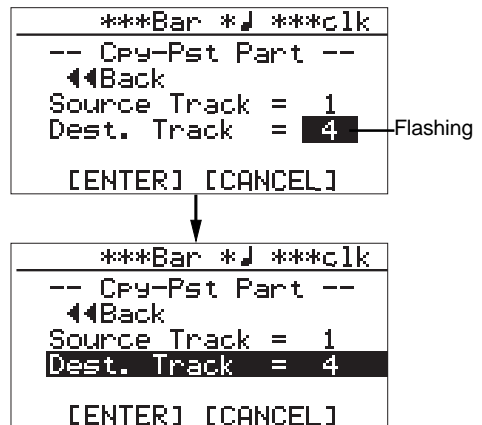

- 9) Rotate the [MENU/ENTER] knob to move the cursor to "[ENTER]" at the bottom of the screen, then press the [MENU/ENTER] knob. The display shows "Please Wait", immediately followed by "Completed" when the MR16 completes the copy/paste operation. To cancel the copy/paste operation, move the cursor to "[CANCEL]" at the bottom of the screen, and press the [MENU/ENTER] knob.

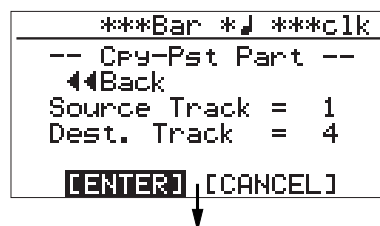



- 10) After pressing the [MENU/ENTER] knob, press the [STOP] key to exit the MENU mode.

<Note>: If you are not satisfied with the result, press the [UNDO/REDO] key to undo the operation (see page 127).

Copying/pasting the desired part(s)-2

You can copy the desired part(s) of the selected track(s) and paste it(them) to the other time position of the desired track(s). Unlike the method described above in "**Copying/pasting the desired part(s)-1**", the part data is copied to the (virtual) clipboard and then pasted to the specified position of the other specified track(s).

The copy/paste operation of a part or parts can be made only within the current song.

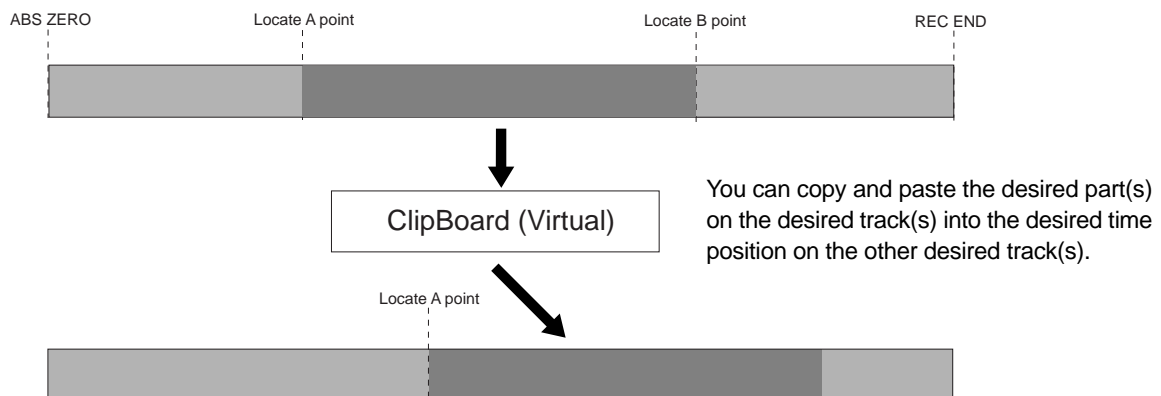

<Note>: If you paste the part(s) to the same time position of the other track(s), we recommend using the method described above in "**Copying/pasting the desired part(s)-1**", because it works faster.

<Note>: You cannot copy/paste track data of a song protected. Release the protection before making the copy/paste operation.

<Note>: If you turn off the MR16 after copying the part data to the clipboard, the data on the clipboard is lost. Also note that you cannot undo copying data to the clipboard.

Copying to the clipboard

Firstly, you must copy the desired part data to the clipboard.

<Note>: You cannot undo/redo copying to the clipboard.

- 1) Load the song you want to edit.
- 2) Set the LOCATE A and LOCATE B points (see page 53).
You can check the edited part(s) by playing back between the LOCATE A and LOCATE B points (see page 48).

- 3) While the recorder is stopped, press the [MENU/ENTER] knob to enter the menu mode. The display now shows the first page of the menu selection screen.

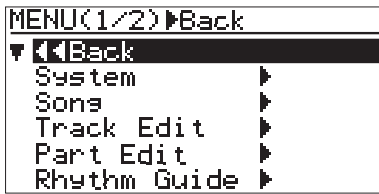

- 4) Rotate the [MENU/ENTER] knob to select "Part Edit", and press the [MENU/ENTER] knob. The display now shows the part edit menu screen.

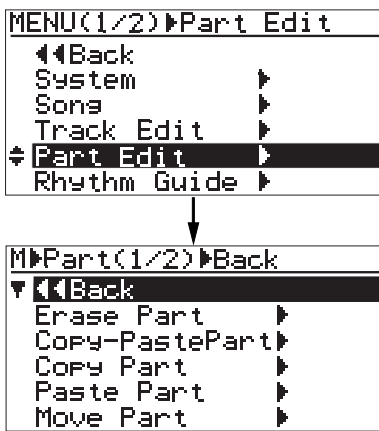

- 5) Rotate the [MENU/ENTER] knob to select "Copy Part", and press the [MENU/ENTER] knob. The display now shows the screen for selecting the source track(s).

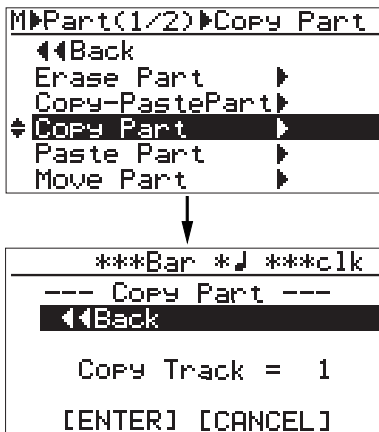

- 6) Rotate the [MENU/ENTER] knob to select "Copy Track", and press the [MENU/ENTER] knob. The display now shows the screen for selecting the copy source track(s). You can select the copy source track(s) by rotating the [MENU/ENTER] knob. The available options are:

- 1 through 8 (mono track)
- 1/2, 3/4, 5/6, 7/8, 9/10, 11/12, 13/14 and 15/16 (stereo tracks)

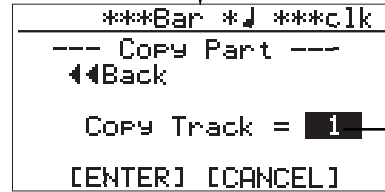
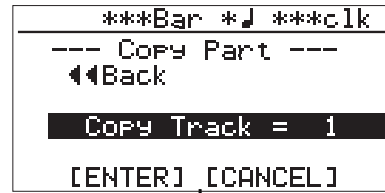

- 7) Rotate the [MENU/ENTER] knob to select the track(s) to be copied, and press the [MENU/ENTER] knob. The display returns to the previous screen.

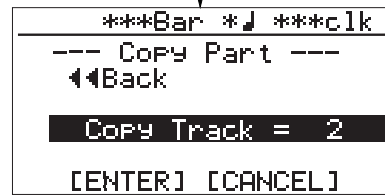
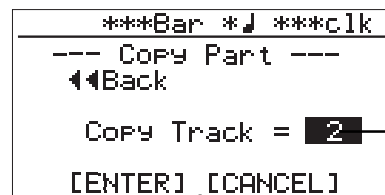

- 8) Rotate the [MENU/ENTER] knob to move the cursor to "[ENTER]" at the bottom of the screen, then press the [MENU/ENTER] knob. The display shows "Please Wait", immediately followed by "Completed" when the MR16 completes the part copy operation. To cancel the part copy operation, move the cursor to "[CANCEL]" at the bottom of the screen, and press the [MENU/ENTER] knob.

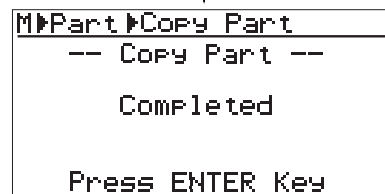
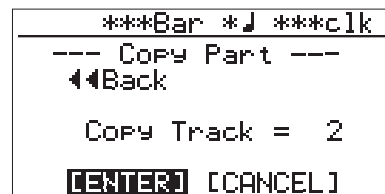

- 9) Press the [MENU/ENTER] knob. The display now returns to the part edit menu screen, where "Copy Part" is highlighted. The procedure example below shows how to paste the copied part data on the clipboard to the LOCATE A point of the selected track.

Pasting clipboard data

The following procedure is assumed that the LOCATE A point, the paste destination, is set

- 1) Rotate the [MENU/ENTER] knob to select "Paste Part >", and press the [MENU/ENTER] knob. The display now shows the screen for selecting the paste destination track(s).

```

M▶Part(1/2)▶Paste Part
◀◀Back
Erase Part ▶
Copy-PastePart▶
Copy Part ▶
▶ Paste Part ▶
Move Part ▶
  
```

```

***Bar *↓***clk
--- Paste Part ---
◀◀Back
Paste Track = 1
[ENTER] [CANCEL]
  
```

- 2) Rotate the [MENU/ENTER] knob to select "Paste Track = *", and press the [MENU/ENTER] knob. You can now select the desired paste destination track(s) by rotating the [MENU/ENTER] knob.

```

***Bar *↓***clk
--- Paste Part ---
◀◀Back
Paste Track = 1
[ENTER] [CANCEL]
  
```

```

***Bar *↓***clk
--- Paste Part ---
◀◀Back
Paste Track = 1
[ENTER] [CANCEL]
  
```

Flashing

You can select the same number of tracks as the paste destination track(s). For example, if you select a mono track for the copy source, you can only select a mono track for paste destination.

- 3) Rotate the [MENU/ENTER] knob to select the paste destination track(s), and press the [MENU/ENTER] knob. The display returns to the previous screen.

```

***Bar *↓***clk
--- Paste Part ---
◀◀Back
Paste Track = 3
[ENTER] [CANCEL]
  
```

Flashing

```

***Bar *↓***clk
--- Paste Part ---
◀◀Back
Paste Track = 3
[ENTER] [CANCEL]
  
```

- 4) Rotate the [MENU/ENTER] knob to move the cursor to "[ENTER]" on the screen, and press the [MENU/ENTER] knob.

The display shows "Please Wait", immediately followed by "Completed" when the MR16 completes the paste operation.

If you want to cancel the part paste operation, move the cursor to "[CANCEL]" on the screen, and press the [MENU/ENTER] knob.

```

***Bar *↓***clk
--- Paste Part ---
◀◀Back
Paste Track = 3
[ENTER] [CANCEL]
  
```

```

M▶Part▶Paste Part
--- Paste Part ---
Completed
Press ENTER Key
  
```

<Note>: If you are going to carry out the paste operation when no data is pasted on the clipboard, the error message ("Clipboard Empty!") is shown on the display and the MR16 does not accept the operation. Press the [STOP] key to exit the menu mode and copy the desired data to the clipboard before carrying out the paste operation.

- 5) After pressing the [MENU/ENTER] knob, press the [STOP] key to exit the MENU mode.

<Note>: If you are not satisfied with the result, press the [UNDO/REDO] key to undo the operation (see page 127).

Moving the part(s)

You can move the desired part(s) of the desired track(s) to the other desired track(s). The part move operation can be made only within the current song. After the part move operation is carried out, the source part(s) becomes silent.

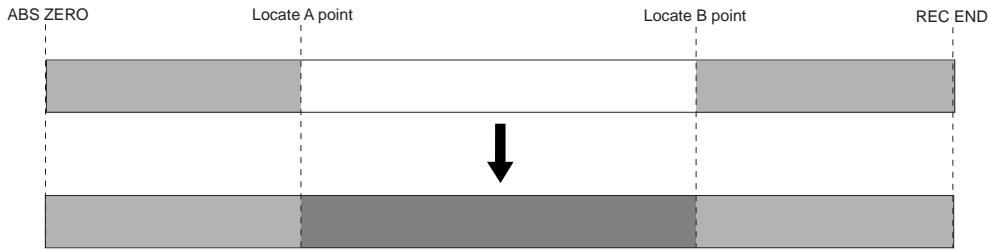

You can move the desired part(s) on the desired track(s) to the other desired track(s).

<Note>: You cannot move data of a song protected. Release the protection before moving data.

- 1) Load the song you want to edit.
- 2) Set the LOCATE A and LOCATE B points (see page 53).
You can check the part(s) by playing back between the LOCATE A and LOCATE B points (see page 48).

- 3) While the recorder is stopped, press the [MENU/ENTER] knob to enter the menu mode. The display now shows the first page of the menu selection screen.

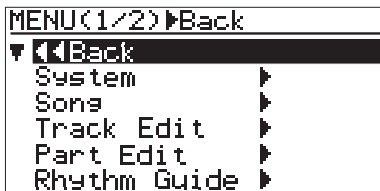

- 4) Rotate the [MENU/ENTER] knob to select "Part Edit", and press the [MENU/ENTER] knob. The display now shows the part edit menu screen.

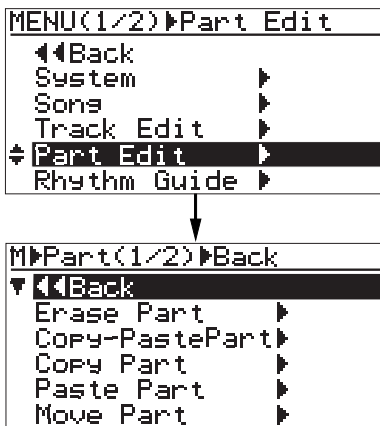

- 5) Rotate the [MENU/ENTER] knob to select "Move Part", and press the [MENU/ENTER] knob. The display now shows the screen for selecting the source track(s) and destination track(s) of the move operation.

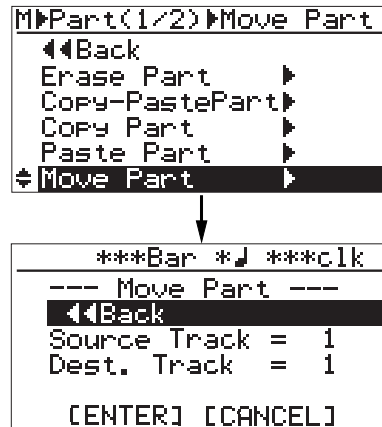

- 6) Rotate the [MENU/ENTER] knob to select "Source Track =", and press the [MENU/ENTER] knob.

You can now select the move source track(s) by rotating the [MENU/ENTER] knob. The available options are:

- 1 through 8 (mono track)
- 1/2, 3/4, 5/6, 7/8, 9/10, 11/12, 13/14 and 15/16 (stereo tracks)

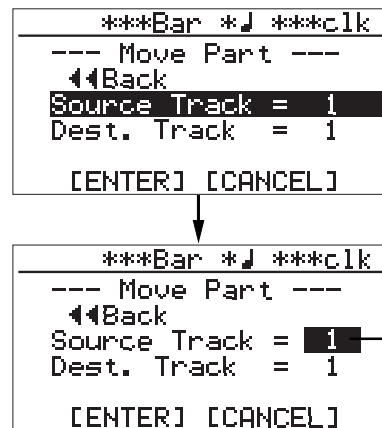

- 7) Rotate the [MENU/ENTER] knob to select the move source track(s), and press the [MENU/ENTER] knob.

You can now select the move destination track(s) by rotating the [MENU/ENTER] knob.

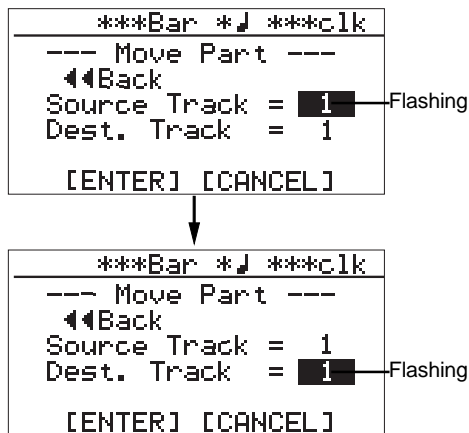

You can select the same number of tracks as the move destination track(s). For example, if you select a mono track for the move source, you can only select a mono track for move destination.

<Note>: You cannot select the same track(s) for the move source and destination.

- 8) Rotate the [MENU/ENTER] knob to select the destination track(s), and press the [MENU/ENTER] knob.

The display returns to the screen where "Dest. Track = *" is highlighted.

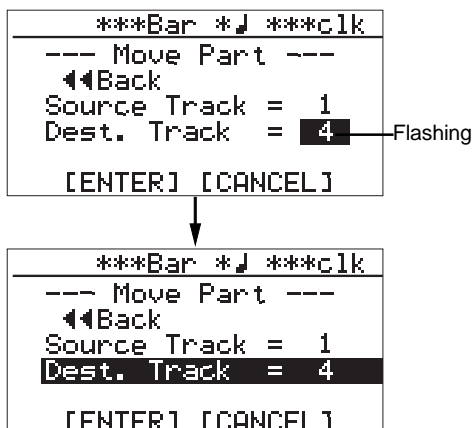

- 9) Rotate the [MENU/ENTER] knob to move the cursor to "[ENTER]" on the screen, and press the [MENU/ENTER] knob.

The display shows "Please Wait", immediately followed by "Completed" when the MR16 completes the move operation.

If you want to cancel the move operation, move the cursor to "[CANCEL]" on the screen, and press the [MENU/ENTER] knob.

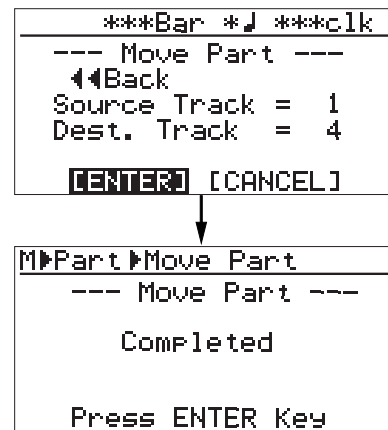

- 10) After pressing the [MENU/ENTER] knob, press the [STOP] key to exit the MENU mode.

<Note>: If you are not satisfied with the result, press the [UNDO/REDO] key to undo the operation (see page 127).

Exchange the part(s)

You can exchange the parts between the desired tracks. The part exchange operation can be made only within the current song.

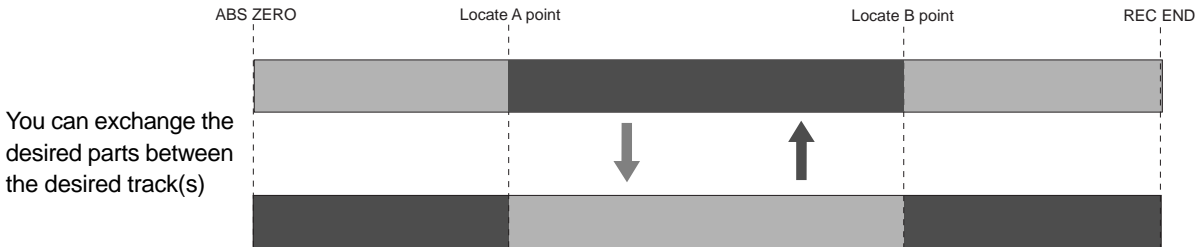

You can exchange the desired parts between the desired track(s)

<Note>: You cannot exchange data of a song protected. Release the protection before exchanging parts.

- 1) Load the song you want to edit.
- 2) Set the LOCATE A and LOCATE B points (see page 53).
You can check the parts by playing back between the LOCATE A and LOCATE B points (see page 48).

- 3) While the recorder is stopped, press the [MENU/ENTER] knob to enter the menu mode. The display now shows the first page of the menu selection screen.

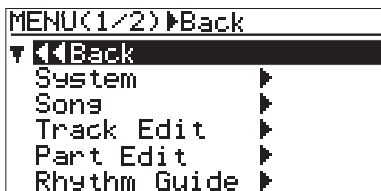

- 4) Rotate the [MENU/ENTER] knob to select "Part Edit", and press the [MENU/ENTER] knob. The display now shows the part edit menu screen.

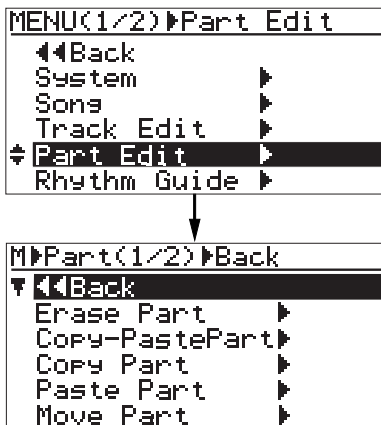

- 5) Rotate the [MENU/ENTER] knob to select "Change Part" in the second page, and press the [MENU/ENTER] knob.

The display now shows the screen for selecting the source track(s) and destination track(s) of the exchange operation.

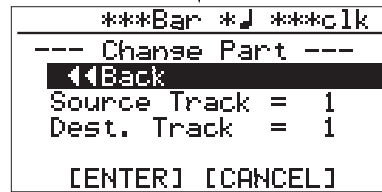
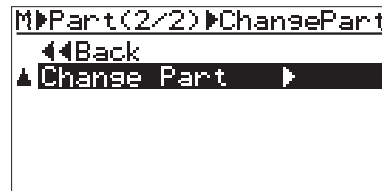

- 6) Rotate the [MENU/ENTER] knob to select "Source Track=", and press the [MENU/ENTER] knob.

You can now select the exchange source track(s) by rotating the [MENU/ENTER] knob. The available options are:

- 1 through 8 (mono track)
- 1/2, 3/4, 5/6, 7/8, 9/10, 11/12, 13/14 and 15/16 (stereo tracks)

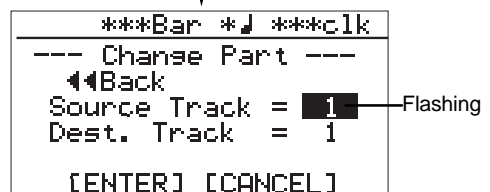
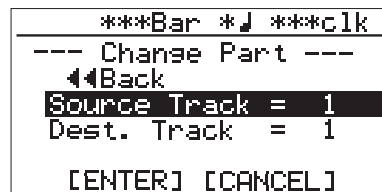

- 7) Rotate the [MENU/ENTER] knob to select the source track(s) to be exchanged, and press the [MENU/ENTER] knob.

You can now select the exchange destination track(s) by rotating the [MENU/ENTER] knob.

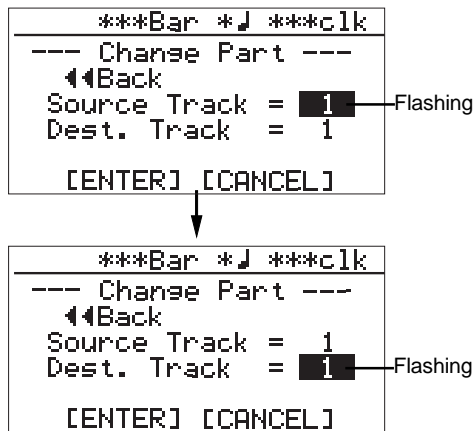

You can select the same number of tracks as the exchange destination track(s). For example, if you select a mono track for the exchange source, you can only select a mono track for exchange destination.

<Note>: You cannot select the same track(s) for the exchange source and destination.

- 8) Rotate the [MENU/ENTER] knob to select the destination track(s), and press the [MENU/ENTER] knob.

The display shows the screen where "Dest. Track = **" is highlighted.

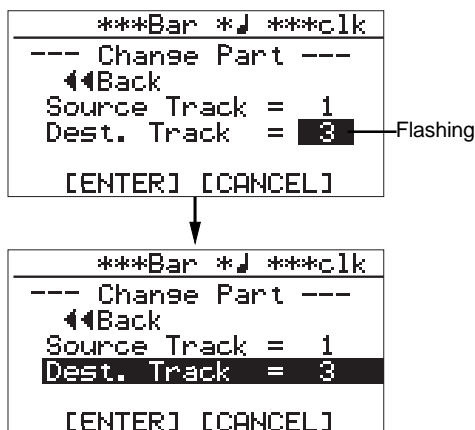

- 9) Rotate the [MENU/ENTER] knob to move the cursor to "[ENTER]" on the screen, and press the [MENU/ENTER] knob.

The display shows "Please Wait", immediately followed by "Completed" when the MR16 completes the exchange operation.

If you want to cancel the exchange operation, move the cursor to "[CANCEL]" on the screen, and press the [MENU/ENTER] knob.

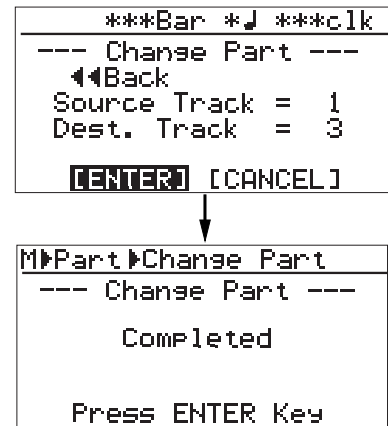

- 10) After pressing the [MENU/ENTER] knob, press the [STOP] key to exit the MENU mode.

<Note>: If you are not satisfied with the result, press the [UNDO/REDO] key to undo the operation (see page 127).

Other functions

This chapter describes the following functions which are important for using the MR16.

- (1) **Hard disk formatting**
- (2) **Peak hold time setting**
- (3) **Pre-roll/post-roll time setting**
- (4) **Beat resolution mode on/off**
- (5) **Phantom power on/off**
- (6) **AUX OUT 1/2 output mode setting**
- (7) **Initializing the MR16**

<Notes>

While a menu screen is shown, you can go up the menu screen level or directly exit the menu mode by the following operations.

- (1) **Select “◀◀ Back” on a menu screen and press the [MENU/ENTER] knob.**
The display returns to the previous (upper level) screen.
Repeating this operation finally exits the menu mode.
- (2) **Press the [REWIND] key.**
The display returns to the previous (upper level) screen.
Repeating this operation finally exits the menu mode.
- (3) **Press the [STOP] key.**
The menu mode exits and the display shows the home screen.

Hard disk formatting

You can reformat the MR16 internal hard disk by using the FAT32 file system. By reformatting the hard disk, all existing song data on the hard disk is erased a new song (Song01) is automatically created.

<Note>: You cannot undo hard disk formatting. Therefore, before executing hard disk formatting, make sure that all song data on the hard disk is not necessary.

- 1) While the recorder is stopped, press the [MENU/ENTER] knob to enter the menu mode. The display now shows the first page of the menu selection screen.

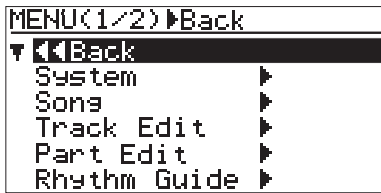

- 2) Rotate the [MENU/ENTER] knob to select "System", and press the [MENU/ENTER] knob. The display now shows the first page of the system menu screen.

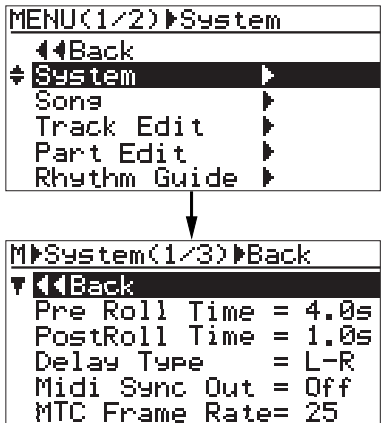

- 3) Rotate the [MENU/ENTER] knob to select "Disk Format" on the second page and press the [MENU/ENTER] knob. The display shows the screen where "Are You Sure?" flashes. As this screen indicates, formatting the hard disk deletes all songs on the disk and you cannot undo disk formatting. To stop formatting, press the [STOP] key to exit the menu mode.

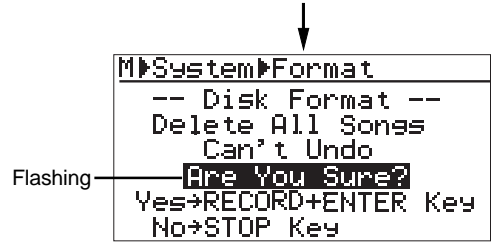
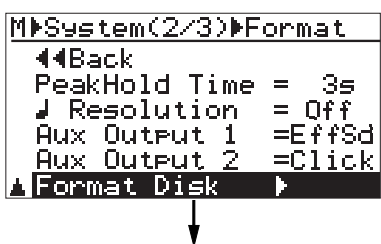

- 4) Press the [MENU/ENTER] knob while holding down the [RECORD] key. Formatting starts. When formatting completes, "Completed" is shown on the display and the MR16 stops disk access.

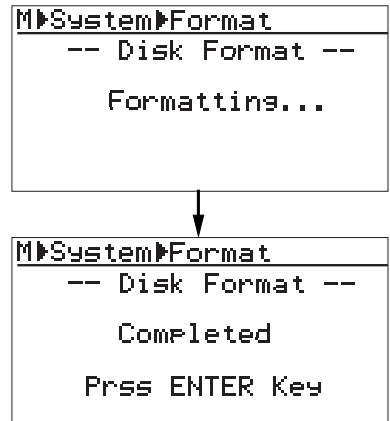

- 5) Press the [MENU/ENTER] knob. The MR16 exits the menu mode. The display changes to the home screen for Song01 (song name: Song01) which is automatically created after formatting.



Peak hold time setting

The level meters shown on the display have the peak hold function. When it is enabled, the meter peak value during recording is held for the specified time. The default meter peak hold time is three seconds. You can disable the peak hold function or change the peak hold time.

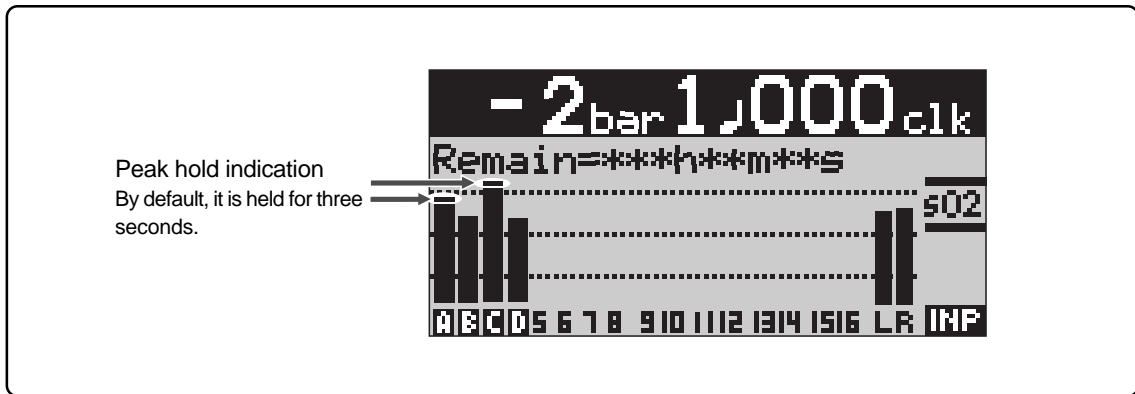

- 1) While the recorder is stopped, press the [MENU/ENTER] knob to enter the menu mode. The display now shows the first page of the menu selection screen.

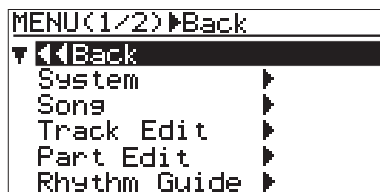

- 2) Rotate the [MENU/ENTER] knob to select "System", and press the [MENU/ENTER] knob. The display now shows the first page of the system menu screen.

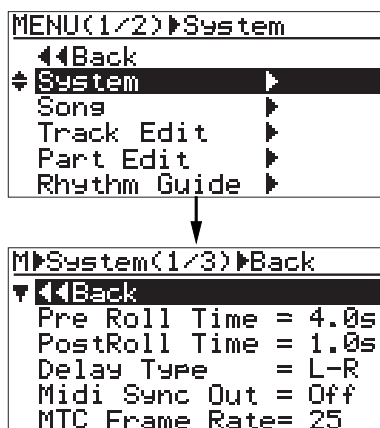

- 3) Rotate the [MENU/ENTER] knob to select "PeakHold Time=*.s" on the second page and press the [MENU/ENTER] knob. The currently selected peak hold time (by default, "3s") flashes. You can now make the desired peak hold setting.

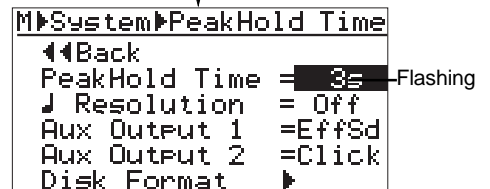
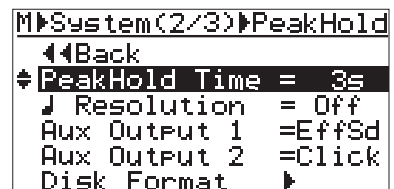

You can select from "3s" (3 seconds, default), "1s", "2s", "4s", "5s" and "Off".

When "Off" is selected, the peak hold function is disabled (the peak value is not held).

- 4) Rotate the [MENU/ENTER] knob to select the desired hold time, and press the [MENU/ENTER] knob. The peak hold setting is confirmed and the display returns to the previous screen.
- 5) Press the [STOP] key to exit the menu mode. The peak hold setting is effective to all songs.

Pre-roll/post-roll time setting

As described earlier on page 51, when both the auto punch in/out and loop modes are active, the pre-roll and post-roll are effective in the loop function. You can set the pre-roll and post-roll time value by the following procedure.

When both the auto punch in/out and loop modes are active, the loop starts from "the LOCATE A point minus the pre-roll time" and ends by "the LOCATE B point plus the post-roll time". The pre-roll time is initially set to four seconds, while the post-roll time is set to one second.

In other words, with the default pre-roll and post-roll time settings, when executing auto punch in/out, the MR16 starts playback four seconds before the punch-in point, and ends playback one second after the punch-out point.

- 1) While the recorder is stopped, press the [MENU/ENTER] knob to enter the menu mode. The display now shows the first page of the menu selection screen.

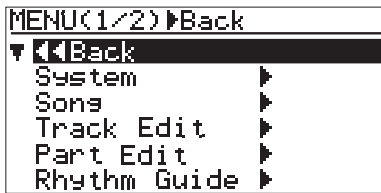

- 2) Rotate the [MENU/ENTER] knob to select "System", and press the [MENU/ENTER] knob. The display now shows the first page of the system menu screen.

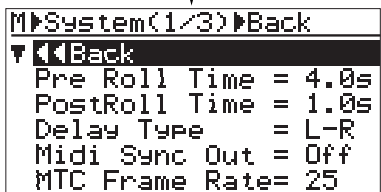
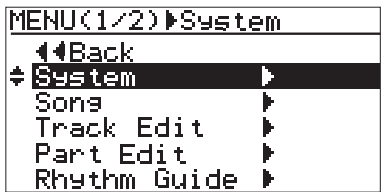

- 3) Rotate the [MENU/ENTER] knob to select "Pre Roll Time=*s" and press the [MENU/ENTER] knob. The currently selected pre-roll time (by default, "4.0s") flashes. You can now set the desired pre-roll time.

You can select between "0.1s" and "10s" in 0.1 second steps.

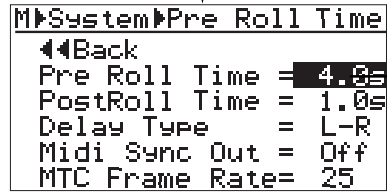
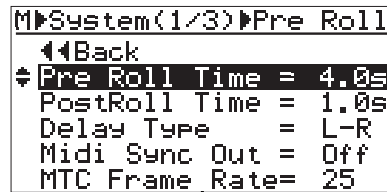

- 4) Rotate the [MENU/ENTER] knob to select the pre-roll hold time, and press the [MENU/ENTER] knob. The pre-roll time setting is confirmed and the display returns to the previous screen. To set the post-roll time, follow the procedure below.

- 5) Rotate the [MENU/ENTER] knob to select "Post Roll Time" and press the [MENU/ENTER] knob. The currently selected post-roll time (by default, "1.0s") flashes. You can now set the desired post-roll time.

You can select between "0.1s" and "10s" in 0.1 second steps.

- 6) Rotate the [MENU/ENTER] knob to select the post-roll hold time, and press the [MENU/ENTER] knob. The post-roll time setting is confirmed and the display returns to the previous screen.

- 7) Press the [STOP] key to exit the menu mode.

Beat resolution mode on/off

While the time base is set to the bar/beat mode, if you set the "Beat resolution" item in the menu to "On", the LOCATE A and B points are set in beat resolution.

When "Beat resolution" is set to "On", the clock digit in the bar/beat/clock value is automatically rounded down or up, so that the clock digit is always "000".

Let's see an example when the time base is set to the bar/beat mode and the "Beat resolution" is set to "On". If you set the LOCATE A point to "Bar 1/1/clock 468" and the LOCATE B point to "Bar 12/4/clock 485", the rounded values are stored as below.

"Bar 1 / 1 / clock 468" -> "Bar 1 / 1 / clock 000"
(The clock value "468" is rounded down.)

"Bar 12 / 4 / clock 485" -> "Bar 13 / 1 / clock 000"
(The clock value "485" is rounded up.)

- 1) While the recorder is stopped, press the [MENU/ENTER] knob to enter the menu mode. The display now shows the first page of the menu selection screen.

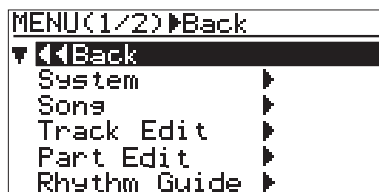

- 2) Rotate the [MENU/ENTER] knob to select "System", and press the [MENU/ENTER] knob. The display now shows the first page of the system menu screen.

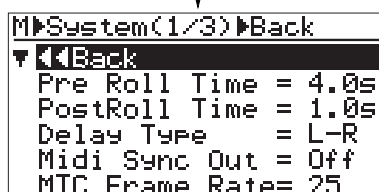
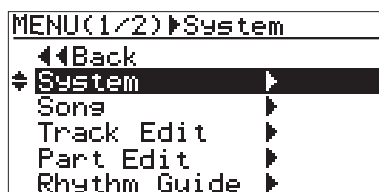

- 3) Rotate the [MENU/ENTER] knob to select "Resolution" on the second page and press the [MENU/ENTER] knob. The current option (by default, "Off") flashes. You can now set the desired option.

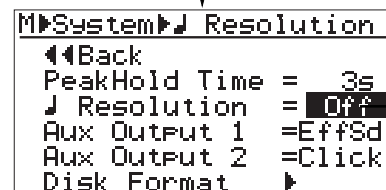
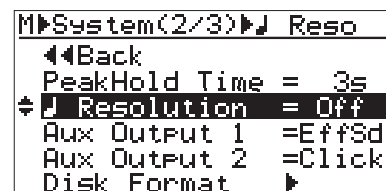

- 4) Rotate the [MENU/ENTER] knob to select "On" or "Off", and press the [MENU/ENTER] knob. The selection is confirmed and the display returns to the previous screen.
- 5) Press the [STOP] key to exit the menu mode.

Phantom power on/off

The MR16 can supply phantom power (+48 V) to the XLR balanced connectors of [INPUT A] through [INPUT D].

So you can connect condenser microphones which require phantom power.

You can turn on or off phantom power to the XLR connectors via the menu mode.

<Note>: The phantom power can be supplied to the XLR balanced connectors of [INPUT A] through [INPUT D]. Therefore, to connect a sound source which does not require the phantom power, use any of the unbalanced phone input jacks on [INPUT A] through [INPUT D].

If any plug is inserted to the unbalanced phone input jack, the phantom power is not supplied to the balanced XLR connector on the same channel.

The phantom power setting returns to "Off" (default) when you turn off the MR16 power.

- <Notes on using phantom power>**
- Confirm that the connected microphone needs +48 V phantom power.
 - Turn on the phantom power after making microphone connection.
 - Mute the outputs of the MR16 when turning on or off the phantom power or plugging/unplugging the microphone.

<Tip>
 You can directly access to the input menu screen by a long press of the desired [TO STEREO BUSS ON/OFF] key.

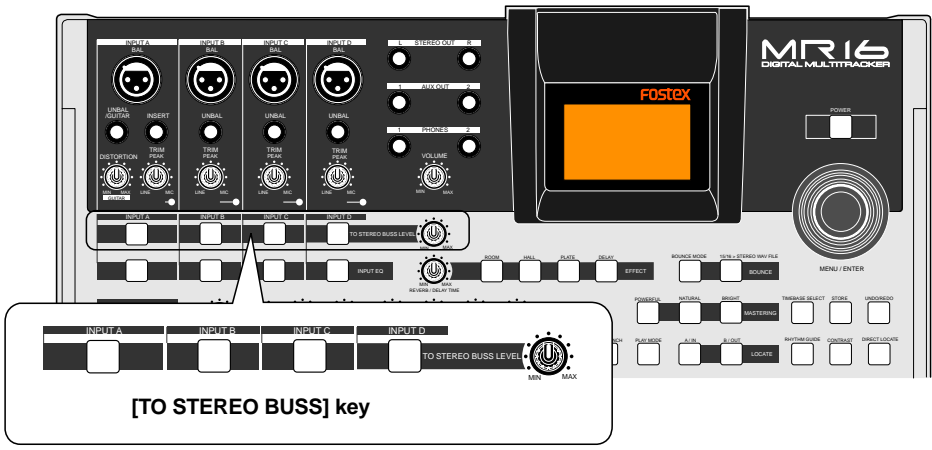

For example, a long press of the [TO STEREO BUSS ON/OFF] key of [INPUT A] directly accesses to the screen shown below.

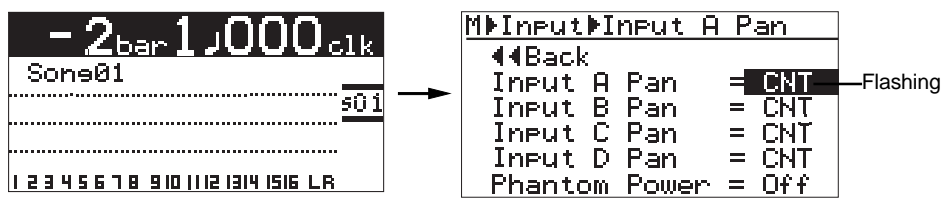

- 1) While the recorder is stopped, press the [MENU/ENTER] knob to enter the menu mode. The display now shows the first page of the menu selection screen.

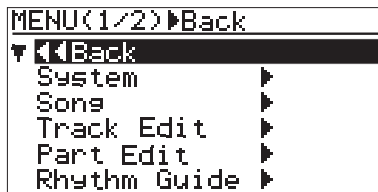

- 2) Rotate the [MENU/ENTER] knob to select "Input ▶" on the second page, and press the [MENU/ENTER] knob. The display now shows the input menu screen.

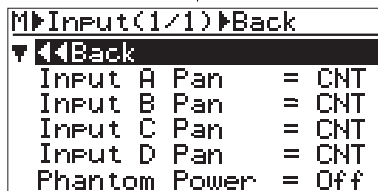
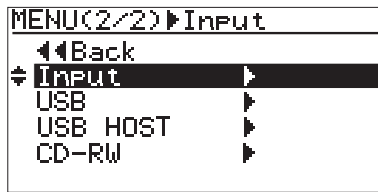

- 3) Rotate the [MENU/ENTER] knob to select "Phantom Power=***", and press the [MENU/ENTER] knob. The current option (by default, "Off") flashes. You can now set the desired option.

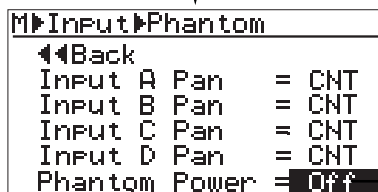
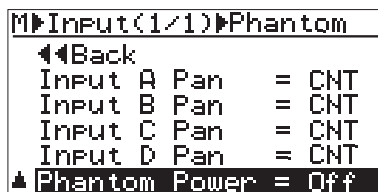

- 4) Rotate the [MENU/ENTER] knob to select "On", and press the [MENU/ENTER] knob. The screen shows a warning message for few seconds, and returns to the previous screen.

While the message is shown, all input channels are muted. When the message is dismissed, the mute is released.

If you select "Off" from "On", a warning message appears and all channels are muted.

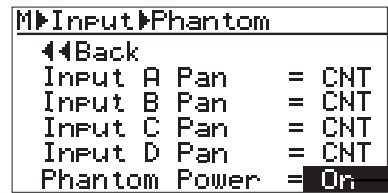

Flashing

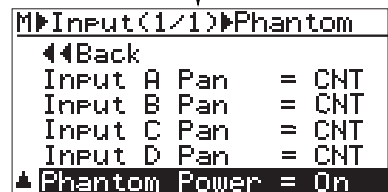
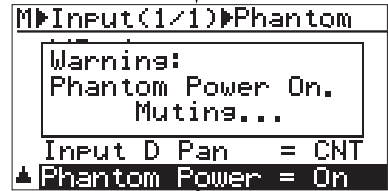

- 5) After making "Phantom Power" setting, press the [STOP] key to exit the menu mode. The display returns to the home screen.

When "Phantom Power" is set to "On", "48" lights on the home screen, as below.



AUX OUT 1/2 output mode setting

You can individually select the output signal of AUX OUT 1 and AUX OUT 2 from among the track signals, the effect send signal and the internal click. See "Application examples" on page 149 for details about how to use AUX OUT.

- 1) While the recorder is stopped, press the [MENU/ENTER] knob to enter the menu mode. The display now shows the first page of the menu selection screen.

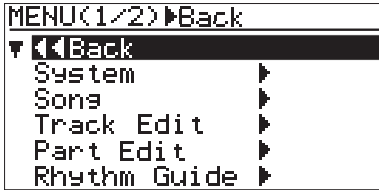

- 2) Rotate the [MENU/ENTER] knob to select "System", and press the [MENU/ENTER] knob. The display now shows the first page of the system menu screen.

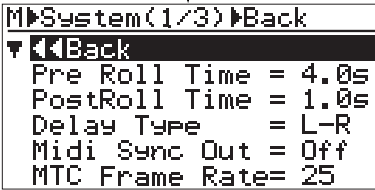
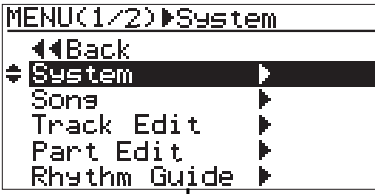

- 3) Rotate the [MENU/ENTER] knob to select "Aux Output 1" (or "Aux Output 2") on the second page and press the [MENU/ENTER] knob. The current option flashes. By default, "EffSd" flashes for "Aux Output 1" while "Click" flashes for "Aux Output 2". You can now set the desired option.

•When "Aux Output 1" is selected

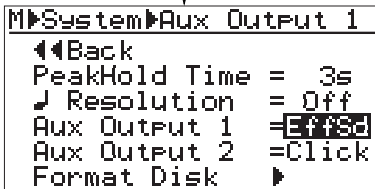
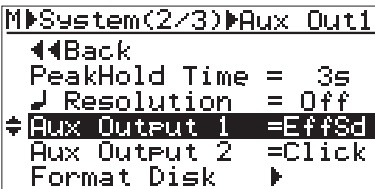

•When "Aux Output 2" is selected

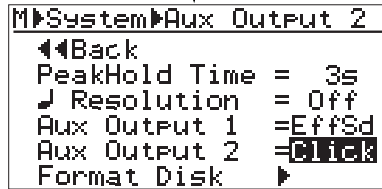
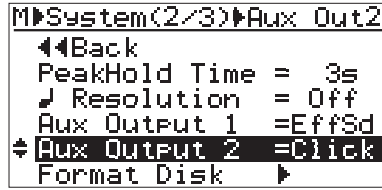

You can select the output signal for each Aux output from among the following options.

1	
.	
.	
16	
EffSd	Effect send buss (see page 72)
Click	Internal click (see page 89)
Off	No output

<Note>: The level of the [AUX OUT] signal is fixed. There is no master level control for the Aux output signal.

<Note>: The level of the [AUX OUT] signal is fixed. There is no master level control for the Aux output signal.

- 4) Rotate the [MENU/ENTER] knob to select the desired option, and press the [MENU/ENTER] knob. The selection is confirmed and the display returns to the previous screen.

The display now shows the first page of the system menu screen.

- 5) Press the [STOP] key to exit the menu mode.

Initializing the MR16

By initializing the MR16, you can initialize all global menu settings common to all songs, as well as the time base and display contrast level.

Initialized item	Default setting
Pre-roll time setting	4 seconds
Post-roll time setting	1 second
Delay type setting	L-R (stereo) delay
MIDI sync out setting	Off
MTC frame rate setting	25 frames
Beat resolution mode setting	Off
Peak hold time setting	3 seconds
Time base (shown when turning on the power)	Bar/Beat
Display contrast level	Factory present level

- 1) While the recorder is stopped, press the [MENU/ENTER] knob to enter the menu mode. The display now shows the first page of the menu selection screen.

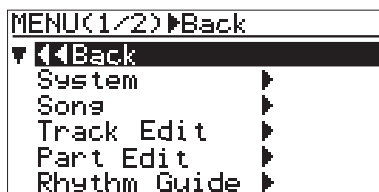

- 2) Rotate the [MENU/ENTER] knob to select "System ▶", and press the [MENU/ENTER] knob. The display now shows the first page of the system menu screen.

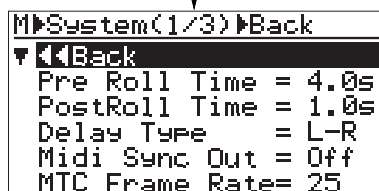
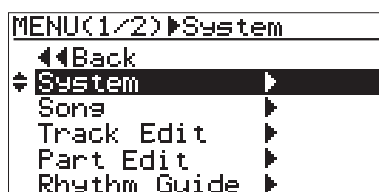

- 3) Rotate the [MENU/ENTER] knob to select "Init System ▶" on the second page, and press the [MENU/ENTER] knob. The display now shows the confirmation screen for initializing.

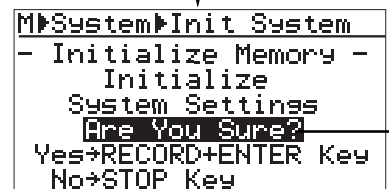
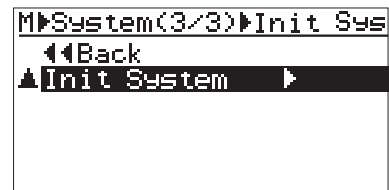

- 4) Press the [MENU/ENTER] knob while holding down the [RECORD] key. The settings are immediately initialized. The initialize is confirmed and the display returns to the previous screen.

The settings are immediately initialized. The initialize is confirmed and the display returns to the previous screen.

To cancel the initialization, press the [STOP] key.

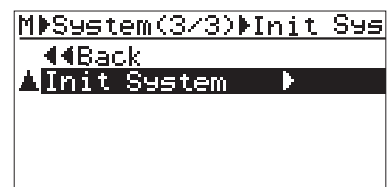

- 5) Press the [STOP] key to exit the menu mode.

Application examples

This chapter describes practical examples of using the MR16.

Application example 1 (Mixing)

This example uses the AUX OUT and TO STEREO BUSS functions. It is assumed that you want to do the following.

- (1) When mixing down tracks 1 through 16, you want to insert a delay effect to track 8 using an external delay unit.
- (2) You also want to insert an amplifier simulation effect to track 4 using an external amplifier simulator.

Connection between the MR16 and external units

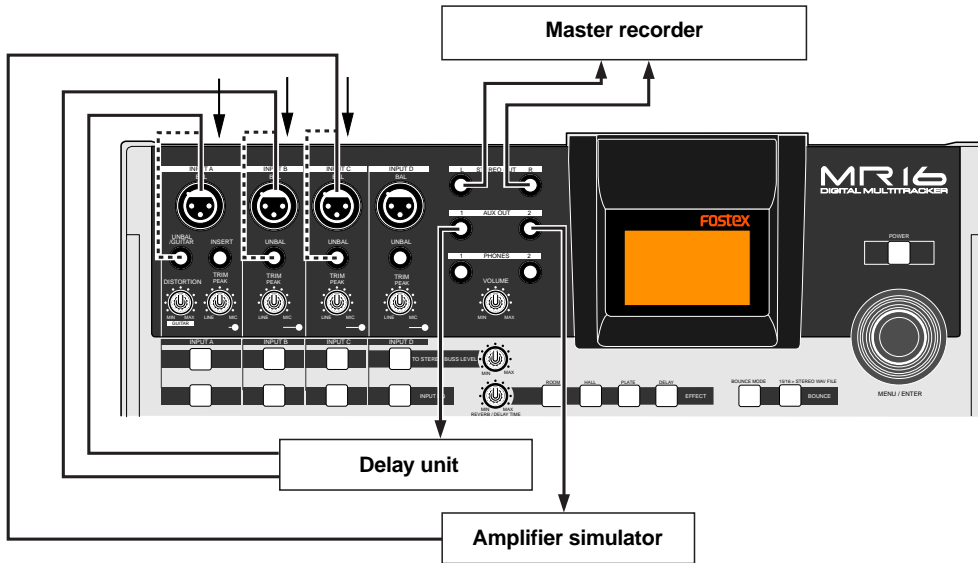

Operation procedure

- Set the output source of AUX OUT 1 to track "8".
- Set the output source of AUX OUT 2 to track "4".
See page 146 for details about how to make settings above.

```

M\System>Aux Output 1
<<Back
PeakHold Time = 3s
Resolution = Off
Aux Output 1 = 8
Aux Output 2 = 4
Format Disk >
    
```

- Set the panpot of INPUT A to "L10".
- Set the panpot of INPUT B to "R10".
- Set the panpot of INPUT C to "CNT".
See page 86 for details about how to make settings above.

```

M>Input>Input A Pan
<<Back
Input A Pan = L10
Input B Pan = R10
Input C Pan = CNT
Input D Pan = CNT
Phantom Power = Off
    
```

- Turn on the [TO STEREO BUSS] keys for [INPUT A] through [INPUT C].

- Use the [TO STEREO BUSS LEVEL] control to adjust the effect (wet) sound level.
- Use the faders for tracks 1 through 16 to adjust the track signal levels.
The output levels of AUX OUT 1 and AUX OUT 2 are fixed and not affected by the corresponding track fader settings.

<Notes>

- You can independently assign any one of tracks 1 through 16, the effect send and the internal click to AUX OUT 1 and AUX OUT 2 (you cannot assign more than one signal to each AUX OUT).
- You can set pan for each of INPUT A through D at the desired position between L10 and R10.
- The mixing levels of INPUTs A through D are collectively controlled by the [TO STEREO BUSS LEVEL] control.
- The balance among INPUTs A through D is adjusted using the TRIM control for each input channel or the output level control of each external device. If you do not want to mix any of the input channels, you can mute it.
- The input channel which is assigned to a recorder track for recording is not mixed.

Application example 2 (Live)

As example 1, this example also uses the AUX OUT and TO STEREO BUSS functions. It is assumed that you want to do the following.

- (1) You want to use the MR16 in the live performance of a band, which uses synchronization between the recorder tracks and keyboard live playing.
- (2) The backing tracks (tracks 3 through 16) are played back by the MR16, while two keyboards are played live.
- (3) A click (recorded on tracks 1 and 2) is fed to the keyboard players.

Connection between the MR16 and external units

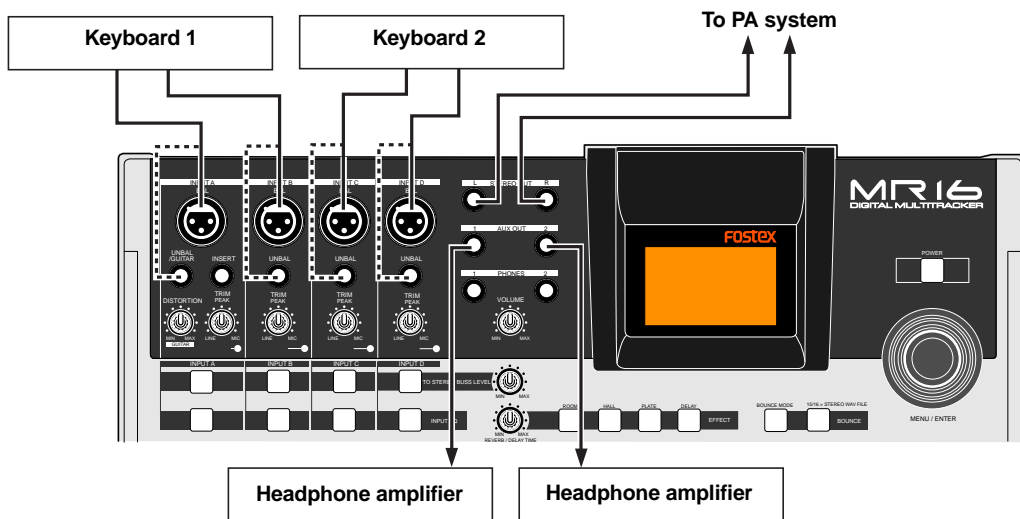

Operation procedure

- Set the output source of AUX OUT 1 to track "1".
- Set the output source of AUX OUT 2 to track "2".
See page 146 for details about how to make settings above.

```

M>System>Aux Output 1
<<Back
PeakHold Time = 3s
J Resolution = Off
Aux Output 1 = 1
Aux Output 2 = 2
Format Disk >
```

- Set the panpot of INPUT A to "L10".
- Set the panpot of INPUT B to "R10".
- Set the panpot of INPUT C to "L10".
- Set the panpot of INPUT D to "R10".
See page 86 for details about how to make settings above.

```

M>Input>Input A Pan
<<Back
Input A Pan = L10
Input B Pan = R10
Input C Pan = L10
Input D Pan = R10
Phantom Power = Off
```

- Turn on the [TO STEREO BUSS] keys for [INPUT A] through [INPUT D].

- Use the [To STEREO BUSS LEVEL] control to adjust the keyboard sound levels.
- Use the faders for tracks 3 through 16 to adjust the track signal levels.
- Turn down the faders for tracks 1 and 2 (because tracks 1 and 2 are click tracks).

<Notes>

- You can independently assign any one of tracks 1 through 16, the effect send and the internal click to AUX OUT 1 and AUX OUT 2 (you cannot assign more than one signal to each AUX OUT).
- You can set pan for each of INPUT A through D at the desired position between L10 and R10.
- The mixing levels of INPUTs A through D are collectively controlled by the [TO STEREO BUSS LEVEL] control.
- The balance among INPUTs A through D is adjusted using the TRIM control for each input channel or the output level control of each external device. If you do not want to mix any of the input channels, you can mute it.
- The input channel which is assigned to a recorder track for recording is not mixed.

Troubleshooting

If you encounter any problem while operating the MR16, check the following for the possible cause of the problem before contacting our service station or dealer.

Troubles for recording

<Trouble 1>: I cannot record the sound source connected to [INPUT B] to track 1.

- **When recording a sound source to a mono track, you can only use the [INPUT A] section.**
Connect the source to [INPUT A].

<Trouble 2>: I cannot record the sound sources connected to [INPUT C] and [INPUT D] to tracks 1 and 2.

- **When recording two sound sources simultaneously, you must use [INPUT A] and [INPUT B]. You cannot use [INPUT C] and [INPUT D].**
Reconnect the sources to [INPUT A] and [INPUT B].

<Trouble 3>: The input level of the track to which I am going to record is too low.

- **Is the [TRIM] control of the input to which the sound source is connected adjusted appropriately?**
To set the input level (= recording level) appropriately, use the [TRIM] control so that the peak indicator does not light continuously.

<Trouble 4>: I cannot hear the input signal via the headphones though the [REC SELECT] key is active.

- **Did you press the [RECORD] key to make the armed track in the input monitor mode? Is the [PHONES VOL] control raised?**
You cannot hear the input signal unless the assigned track is in the input monitor mode by pressing the corresponding [REC SELECT] key to turn on the indicator. Also, you cannot hear any signal if the [PHONES VOL] control is set to minimum.

<Trouble 5>: The meter shows very low level and the recording level is too low.

- **Is the [TRIM] control for the input section the sound source is connected adjusted appropriately?**
Set the [TRIM] control just below the position where the [PEAK] indicator in the [INPUT A] section lights at the loudest part.

<Trouble 6>: The meter shows good level for recording, but no signal can be monitored via headphones though the [PHONES VOL] control is raised.

- **Are the track fader for the recording track and the [MASTER] fader raised?**
Both of these faders, as well as the [PHONES VOL] control, have to be raised in order to monitor the recording signal via headphones.
We recommend to raise both the track fader for the recording track and the [MASTER] fader to the "≡" position.
- **Is the recording track in the input monitor mode?**
Make sure that the [RECORD] key flashes and "🎧" is shown on the display.
If not, press the [RECORD] key to set the armed track to the input monitor mode.

<Trouble 7>: During overdubbing, I cannot monitor the playback signal of the recorded track.

- **Is the track fader for the playback track raised?**
During overdubbing, raise the faders for both the playback and recording tracks appropriately. Otherwise, you cannot make overdubbing while listening to the recorded track(s).

<Trouble 8>: I cannot execute auto punch in/out.

- **Is the auto punch in/out mode effective?**
If it is not, press the [AUTO PUNCH] key to make the auto punch in/out function active.
- **Are the punch-in and punch-out points set correctly?**
To check each point, press the [LOCATE A/IN] or [LOCATE B/OUT] key.
The recorder locates to the punch-in or punch-out point, while the screen shows the appropriate time data.
If the punch-out point is earlier than the punch-in point, set these points appropriately so that the punch-in point is earlier than the punch-out point.

<Trouble 9>: I cannot record audio data of a song onto an external digital recorder.

- **Is the connection between the [DIGITAL OUT] connector on the MR16 and the optical input connector of the digital recorder made correctly?**
Check the connection, as well as the optical cable.
- **Is the digital recorder set correctly for recording the signal fed to the digital input?**
See the manual of the digital recorder for details about the setting.

Troubles for playback

<Trouble 1>: During playback, the recorder suddenly executes locating.

- **Is "[FF] (auto return)" or "[LE] (loop)" shown on the display?**
If so, the play mode is set to the auto return or loop mode. Press the [PLAY MODE] key until "Off" is selected.

<Trouble 2>: Cannot monitor the playback sound.

- **Are the track fader(s) for the playback track(s) and the [MASTER] fader brought up to the appropriate positions?**
Raise the fader(s) for the track(s) you want to monitor, as well as the [MASTER] fader. If you monitor via headphones, also raise the [PHONES VOL] control.

<Trouble 3>: I press the [PLAY] key while holding down the [STOP] key, but I cannot execute loop playback.

- **Are the LOCATE A and LOCATE B points set correctly?**
By default, both of these points are set to the beginning of a song (i.e. "0m 00s 000ms" or "-2bar 1beat 00clk"). In this condition, you cannot execute loop playback. Also, if the LOCATE B point is earlier than the LOCATE A point, you cannot execute loop playback.

Troubles for effect

<Trouble 1>: I cannot apply the effects.

- **Are the [EFFECT SEND] control for the track you want to apply the effect and track fader raised appropriately?**

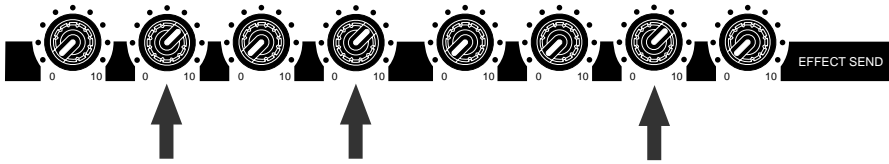

Raise the [EFFECT SEND] control(s) for the track(s) (1 through 4) you want to apply the effect to send signal(s) to the internal digital effects. Also, make sure that the fader(s) for the track(s) you want to apply the effect is(are) raised.

<Trouble 2>: I cannot apply the mic simulation effects.

- Is the [INPUT A SELECT] switch on the rear panel is set to "MIC/LINE" position?

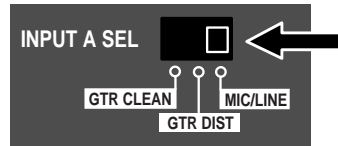

To apply the mic simulation effects to [INPUT A], the [INPUT A SELECT] switch on the rear panel must be set to "MIC/LINE" position. When you set the switch to any other position, you can use the amp simulation effects for insert effects.

Troubles for USB connection

<Trouble 1>: Cannot export a WAV file to a personal computer.

- **Is the USB cable connected correctly?**
Check the connection, as well as the USB cable.
- **Is the personal computer meets the requirement?**
The MR16 can export a WAV file to a personal computer which runs on any of the following OS systems.

Windows Me, 2000 or XP
Macintosh OS X or higher

<Trouble 2>: The MR16 drive icon is not shown on the personal computer screen.

- **It may take some times for showing a removable drive depending on a personal computer.**
It may take some times for reading the drive data. Wait for a while until the drive icon appears.

On a Windows machine, the MR16 is shown as "removable drive". On a Macintosh machine, it is shown as "MR16".

Other troubles

<Trouble 1>: I cannot hear the rhythm guide click.

- **Is the [RHYTHM GUIDE] key is illuminated?**
When the [RHYTHM GUIDE] key is not illuminated, the rhythm guide function is not active and you cannot hear the rhythm guide click.
- **Is the "Int Click level" item in the "Rhythm Guide" menu set correctly?**
If the "Int Click level" item is set to "00" or a small value, you cannot hear the rhythm guide click.

<Trouble 2> : I want to hear the rhythm guide click based on the "Signature" and "Tempo" settings on the rhythm guide setting screen but the rhythm guide click based on the conductor map is output.

- **Is the "Conductor Map" setting on the rhythm guide setting screen set to "On"?**
As shown on the screen below, if "Conductor Map" on the rhythm guide setting screen is set to "On", the rhythm guide click based on the conductor map is output. In this condition, the "Signature" and "Tempo" fields on this screen indicate "-" as below, showing that they are disabled.

```

M▶Rhythm(1/1)▶Back
┌───┴───┐
└─┬─┬─┘
  ◀ Back
  Rhythm Guide = On
  Conductor Map = On
  Signature     = --- ←
  Tempo        = ---bpm ←
  Int ClickLevel= 80
  
```

Set "Conductor Map" to "Off" (see page 91).

MR16 Specifications

Specifications

[Inputs/Outputs]

0dBu=0.775Vrms, 0dBV=1.0Vrms, Reference level: -12dBfs

Analog input [INPUT A - INPUT D]

- Connectors : XLR-3-31 type (#2: hot balanced)
: 1/4-inch, phone type
- Input level : -48dBu (MIC) to +4dBu (LINE)
- Input impedance : 1.5kΩ or more
: 400kΩ or more (When the INPUT A SEL switch is set to "GTR".)
- Phantom power : P48V (Phantom power ON/OFF is selected in the "Input" menu of the MENU mode.)

Insert [INSERT (input A only)]

- Connector : 1/4-inch, TRS phone type
(Tip: output, Ring: input)
- Norminal output level : -10dBV
- Load impedance : 10kΩ or more
- Norminal input level : -10dBV
- Input impedance : 10kΩ or more

Stereo analog output [STEREO OUT (L, R)]

- Connectors : 1/4-inch, phone type
- Norminal output level : -10dBV (unbalanced)
- Load impedance : 10kΩ or more

Auxiliary output [AUX OUT 1, 2]

- Connectors : 1/4-inch, phone type
- Norminal output level : -10dBV (unbalanced)
- Load impedance : 10kΩ or more

Headphones output [PHONES 1, 2]

- Connectors : 1/4-inch, stereo phone type
- Max. output power : 50mW or more (at 32Ω load)
- Load impedance : 16Ω or more

MIDI output [MIDI OUT]

- Connector : DIN 5-pin
- Format : Conformed to the MIDI standard

Digital output [DIGITAL OUT]

- Connector : Toslink optical type
- Format : IEC 60958 (S/P DIF)

Footswitch [FOOT SW]

- Connector : 1/4-inch, phone type
- Level : TTL level

USB (USB 2.0 HI-SPEED)

- Connector : B type (standard)

USB HOST (USB 1.1)

- Connector : A type (standard)

[Record / playback]

- Recording medium : 3.5-inch hard disk drive
- Sampling frequencies: 44.1kHz
- Quantization : 16-bits, linear (non expanded)
- File format : FAT32
- Audio recording type : Conformed to AES-31
- Audio file type : BWF
- The number of tracks : 16
* the number of simultaneously recordable tracks: 4
- ADC/DAC : 24-bits, delta-sigma
- Frequency response : 20Hz to 20kHz
- Dynamic range : 93dB or more (TYPICAL)
- Total harmonic distortion : 0.01% or less (TYPICAL)

[General]

- Weight (net) : Approx. 3.3 kg
: Approx. 3.5 kg (CD-R/RW drive built-in model)
- Dimensions : 400 (W) x 265 (D) x 85 (H) mm
- Power supply : 120VAC 50/60Hz
: 230VAC 50/60Hz
: 240VAC 50/60Hz
- Power consumption : 14 W
: 20 W (CD-R/RW drive built-in model)
- Supplied Accessories : Power cord, Owner's Manual

* Changes in specifications and features may be made without notice or obligation.

[Pin assignment of XLR connectors]

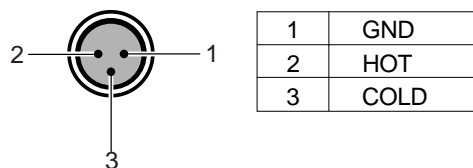

[Pin assignment of USB port]

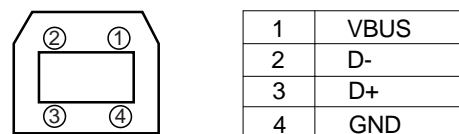

[Pin assignment of USB HOST port]

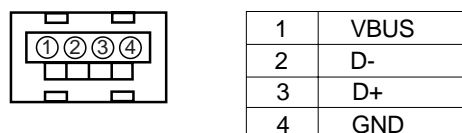

Physical dimensions

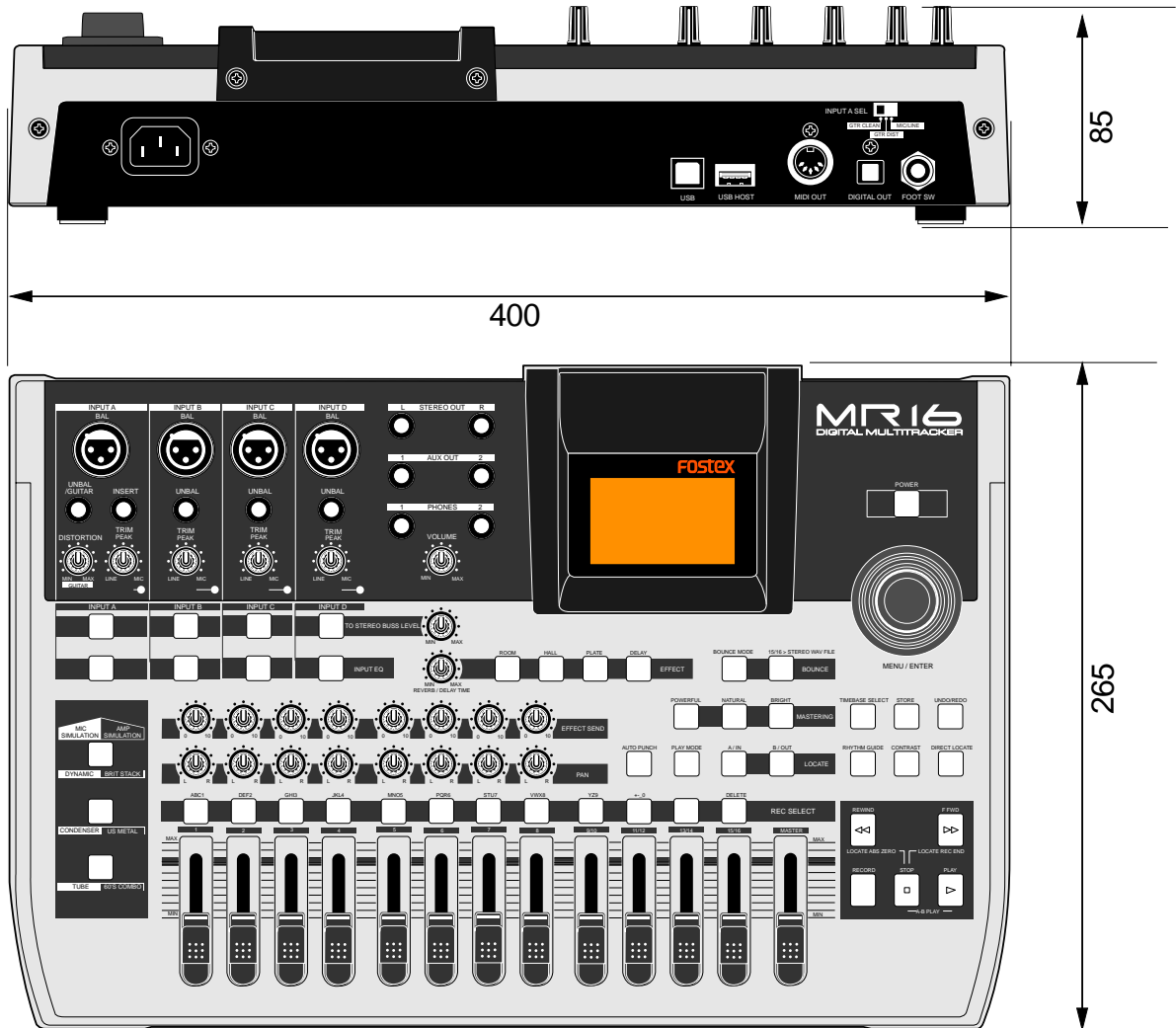

Block diagram

When using the normal mode

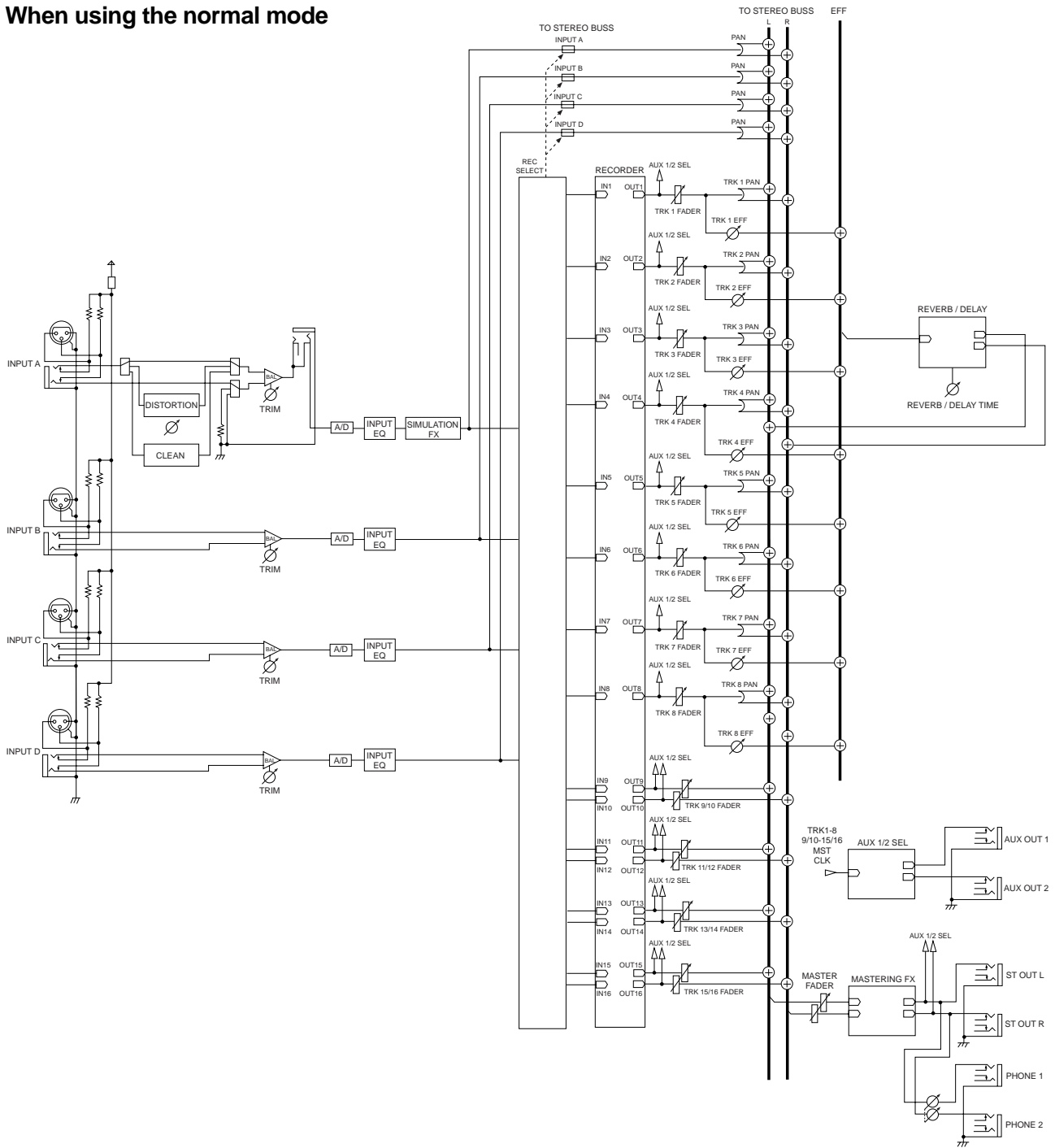

MIDI implementation chart

<Digital multitracker>

Model MR16

Date:
Version: V1.00

Function.....	Transmitted	Recognized	Remarks
Basic Default	X	X	
Channel Changed	X	X	
Mode Default	X	X	
Message	X	X	
Altered	*****	X	
Note	X	X	
Number: True Voice	*****	X	
Velocity Note ON	X	X	
Note OFF	X	X	
After Key's	X	X	
Touch Channel's	X	X	
Pitch Bend	X	X	
Control Change	X	X	
Program Change: True #	X *****	X X	
System Exclusive	○ rem. 1	X	
Common : Quarter Frame	○	X	
: Song Position	○	X	
: Song Select	X	X	
: Tune	X	X	
System Real Time : Clock	○	X	
: Commands	○ rem. 2	X	
Aux. Message : Local ON/OFF	X	X	
: All Notes OFF	X	X	
: Active Sense	X	X	
: Reset	X	X	
Notes	rem.1 : MTC rem. 2 : START, STOP, CONTINUE		

Mode 1: OMNI ON, POLY
Mode 3: OMNI OFF, POLYMode 2: OMNI ON, MONO
Mode 4: OMNI OFF, MONO○: Yes
X: No

Index

<A>

Amp simulation	68
Auto return	49
Auto play	49
ABS time	15
Archiving a song	111
Analog mixdown	44
Auxiliary output	150 and 151
Audio CD	17

Bounce	75
Bar/Beat	15, 27 and 143
Beginning a song	15 and 52
Bar offset	95

<C>

Cueing	48
Clipboard	131
Click level	91
Clock	102
Contrast	27
Copy	121, 129 through 133
Copyrights	10
Conductor map	92
Changing track	125
Character entry key	34 and 115
Creating a song	33

<D>

Delay	70
Distortion	35 and 68
Display	26
Demo song	31
Digital mixdown	45
Direct locate	55
Delete song	116
Damage	10

<E>

Effector	65
Effect send	72
Erasing track	120
Erase part	128
Event	93 through 98
Exchange the track	125
Exchange the parts	136

<F>

Format	140
Foot switch	61

<G>

Gain	16, 37 through 42
------------	-------------------

<H>

Hard disk	110, 111 and 140
Hidden file	95 and 116

<I>

Internal CD-R/RW drive	25
Insert effect	68
Input A select switch	35 and 68
Input monitor	15, 37 through 42
Insert	69
Input	35
Input EQ	66
Initialize	147

<L>

Loop	49
Locate	52
Locate accuracy	56

<M>

Master recorder	43 through 45
Mastering effect	73
Mic simulation	68
MIDI	99
MIDI implementation chart	163
Mixdown	43 through 45
Move	123 and 134
MENU mode	28

<O>

Overdubbing	39
Offset	95
Optical cable	24 and 45

<P>

Playback	32, 38, 40, 42 and 47
Power supply	30
Power switch	30
Personal computer	107
Part	127
Punch in/out	59
Punch in/out points	62
Play mode	49
Pre roll	51 and 142
Peak LED	16
Peak hold	141
Phantom power	144
Protect	110 and 117
Paste	121, 129 and 131
Post roll	51 and 142
Preview	58

<Q>

Quantization	160
--------------------	-----

<R>

Recording	37 through 45
Recording level	37 through 45
Recording track	36
Recording method	13
Reverb	70
Redo	38, 40, 42, 119, 127
Remain	14, 26, 38, 40 and 42

Rehearsal	63, 79 and 82
Repro monitor	15
Resolution	143
REC END	13 and 52
Rhythm guide	89

<S>

Signature	90 through 94
Simulation	68
Sequencer	99
Signature map	92
Standby mode	30
Song	14 and 113
Select a song	114
Song name	33 and 115
Synchronization	99
Song protect	117
S/P DIF	45

<T>

Track	36
Trouble shooting	153
Trim	16, 37 through 42
Track fader	37 through 42
Time base	15 and 27
Tempo map	96

<U>

Undo	38, 40, 42, 119 and 127
USB	107
USB HOST	Supplementary manual

<W>

WAV file	14 and 103
WAV file conversion	104
WAV manager	17 and 111
Warning	28

<Y>

Y cable	20 and 69
---------------	-----------

Declaration of EC Directive

This equipment is compatible with the EMC Directive (89/336/EEC) - Directive on approximation of member nation's ordinance concerning the electromagnetic compatibility and with the Low Voltage Directive (73/23/EEC) - Directive on approximation of member nation's ordinance concerning electric equipment designed to be used within the specified voltage range.

The Affect of Immunity on This Equipment

The affect of the European Specification EN61000-6-1 (coexistence of electromagnetic waves - common immunity specification) on this equipment are as shown below.

In the electrical fast transient/burst requirements, surge, conducted disturbances by radio-frequency fields, power frequency magnetic field, radiate electromagnetic field requirements and static electricity discharging environment, this could be affected by generation of noise in some cases.

FOSTEX DISTRIBUTORS LIST IN EUROPE

* Including non-EU countries (as of January, 2005)

<AUSTRIA>

NAME: ATEC Audio-u. Videogeraete
VertriebsgesmbH.
ADD: Im Winkel 5, A-2325 Velm, Austria
TEL: (+43) 2234-74004, FAX: (+43) 2234-74074

<BELGIUM>

NAME: General Audio
ADD: Raymond Pelgrimslaan 101, B-1702 Groot-Bijgaarden, Belgium
TEL: (+32) 2-4630650, FAX: (+32) 2-4661500

<DENMARK>

NAME: SC Sound ApS
ADD: Malervej 2, DK-2630 Taastrup, Denmark
TEL: (+45) 4399-8877, FAX: (+45) 4399-8077

<FINLAND>

NAME: Noretron Oy Audio
ADD: P. O. Box 22, FIN-02631 Espoo, Finland
TEL: (+358) 9-5259330, FAX: (+358) 9-52593352

<FRANCE>

NAME: Sennheiser France
ADD: 128 bis, avenue Jean-Jaures, 94851 Ivry-sur-Seine Cedex, France
TEL: (+33) 1 4987 0300, FAX: (+33) 1 4987 0324

<GERMANY>

NAME: Mega Audio GmbH
ADD: Stromberger Str. 32, D-55411 Bingen, Germany
TEL: (+49) 6721-94330, FAX: (+49) 6721-32046

<GREECE>

NAME: Bon Studio S. A.
ADD: 6 Zaimi Street, Exarchia, 106.83 Athens, Greece
TEL: (+30) 210-3809-605, 606, 607, 608
FAX: (+30) 210-3845-755, 210-3827-868

<ICELAND>

NAME: I. D. elfr. electronic Ltd.
ADD: ARMULA 38 108 REYKJAVIK, ICELAND
TEL: (+354) 588 5010, FAX: (+354) 588 5011

<ITALY>

NAME: Proel S. p. A.
ADD: Zona Via Alla Ruenia, 37/43 64027 - Sant'Omero (Teramo), Italy
TEL: (+39) 0861-81241, FAX: (+39) 0861-887862

<THE NETHERLANDS>

NAME: IEMKE ROOS AUDIO B. V.
ADD: Kuiperbergweg 20, 1101 AG Amsterdam, The Netherlands
TEL: (+31) 20-697-2121, FAX: (+31) 20-697-4201

<NORWAY>

NAME: Siv. Ing. Benum AS
ADD: P.O. Box 145, Vinderen, 0319 Oslo, Norway
TEL: (+47) 2213 9900, FAX: (+47) 2214 8529

<PORTUGAL>

NAME: Caius - Tecnologias Audio e Musica, Lda.
ADD: Praca do Bom Sucesso, No 61 Bom Sucesso Trade Center, Escritorio 701/702, 4150-1460 Porto, Portugal
TEL: (+351) 22-608-06-10, FAX: (+351) 22-608-06-29

<SPAIN>

NAME: Letusa S. A.
ADD: C/Laguna 10, 28923 Alcorcon, Madrid, Spain
TEL: (+34) 91-4862800, 91-4470898
FAX: (+34) 91-6414597

<SWEDEN>

NAME: Sennheiser AB
ADD: John Ericssonsgatan 10, P.O. Box 22035, SE-104 22 Stockholm, Sweden
TEL: (+46) 8 566 16400, FAX: (+46) 8 566 16490

<SWITZERLAND>

NAME: Audio Bauer Pro AG
ADD: Bernerstrasse-Nord 182, CH-8064 Zurich, Switzerland
TEL: (+41) 1-4323230, FAX: (+41) 1-4326558

<UK>

NAME: SCV London
ADD: 40 Chigwell Lane, Oakwood Hill Industrial Estate, Loughton, Essex IG10 3NY U. K.
TEL: (+44) 20-8418-0778, FAX: (+44) 20-8418-0624

FOR THE US CUSTOMERS ONLY

FOSTEX AMERICA LIMITED WARRANTY

The following statement defines specific legal rights. You may also have additional rights depending on the state in which the Fostex product was purchased.

WARRANTY PROTECTION

All Fostex parts are warranted for one (1) year from the date of original purchase, except for recording media, such as hard disc drives and compact flash cards, heads, lamps and fuses, which are warranted, for one hundred-eighty (180) days. Fostex America will repair and / or replace parts during the term of this warranty. Labor costs are also covered by Fostex America for one (1) year from the date of original purchase. Except as specified below, this warranty covers all defects in material and workmanship in this product.

The following are not covered by this warranty:

1. Batteries.
2. Damage to any product that has been altered.
3. Damage to any product on which the original serial number has been defaced, modified or removed.
4. Damage to or deterioration of the external cabinet.
5. Damage occurring during shipment of the product. (**NOTE:** Shipping claims must be presented to the carrier.)
6. Damage resulting from accident, misuse, abuse or neglect.
7. Damage resulting from failure to perform routine maintenance and / or calibration procedures.
8. Damage resulting from failure to follow instruction in the owner's manual.
9. Damage resulting from repair or attempted repair or by someone other than a Fostex America Service technician or a technician at an authorized Fostex America service station.
10. Damage resulting from causes other than product defects, including lack of technical skill, competence or experience on the part of the user.
11. External appearance items such as cosmetic parts, knobs, liquid crystal displays, buttons, etc.
12. Replacements or repairs necessitated by loss or damages resulting from any cause beyond the control of Fostex America.
13. Damage resulting from misuse or abuse on rental units.

NOTE: FOSTEX AMERICA IS NOT RESPONSIBLE FOR DATA LOST OR DAMAGED DURING OPERATION OF THIS PRODUCT. CALIBRATION AND MAINTENANCE PROCEDURES ARE NOT COVERED BY THIS WARRANTY.

Fostex America reserves the right to inspect all products submitted pursuant to this warranty. If such an inspection shows reasonable cause to believe that any of the above exclusions to the above warranty are applicable, then Fostex America or the authorized service station will charge prevailing service rates and parts, costs for any repairs.

FOSTEX AMERICA LIMITED WARRANTY

To claim all warranty service, first access www.fostex.com to receive service authorization (RMA number). Then present the authorization together with the bill of sale, which shows the date of original purchase to Fostex America. This warranty is not transferable.

SHIPPING

If this product needs service, you must take it, or package it carefully, using ample packaging materials to prevent damage during shipment and mail it to the distributor from whom you have purchased this product, postage pre-paid and insured.

NOTE: Fostex America will not assume responsibility for damages or losses occurred in transit, but will reasonably assist the sender in processing any claims whenever possible (such as submitting statements to the carriers when applicable).

Any collect or C.O.D. shipments will be refused. In order to obtain warranty repairs, you must include the following:

1. Date proof of original purchase (copy of bill of sale or charge slip).
2. A note describing the problem with sufficient particularity to allow Fostex America to inspect or adjust the problem.
3. All accessory items appurtenant to that problem.

LIMITATIONS OF IMPLIED WARRANTIES AND EXCLUSIONS OF CERTAIN DAMAGES

Unless considered unenforceable or unlawful under applicable law:

- A. All implied warranties ? including warranties of merchantability and fitness for a particular purpose ? are limited in duration to term of this warranty and to the express coverage of this warranty;
- B. Fostex America's liability for any defect product is expressly limited to repair or replacement of the product, at the sole discretion and / or option of Fostex America. Fostex America shall not under any circumstances be liable for:
 1. Damaged based on inconvenience, loss of use of the product, loss of time, interrupted operation or commercial loss, OR;
 2. Any damages, whether incidental, consequential or otherwise, except damages which may not be excluded by under applicable law.
- C. Fostex America makes no other warranties, express or implied, above and / or beyond the representations made herein.

WARRANTY APPLIES ONLY TO THOSE PRODUCTS SOLD AND DISTRIBUTED BY FOSTEX AMERICA

Service Department

FOSTEX AMERICA

13701 Cimarron Avenue Gardena, CA 90249

TEL: (310)-329-2960 FAX: (310)-329-1230

www.fostex.com

Fostex[®]

FOSTEX CO.

3-2-35, Musashino, Akishima-shi, Tokyo, Japan, 196-0021

FOSTEX AMERICA

13701 Cimarron Avenue Gardena, CA 90249 U.S.A.

© PRINTED IN CHINA JANUARY 2007 8588 088 000

452187