

# MR-8HD/CD

## DIGITAL MULTITRACKER

### MR-8HD/CD Supplementary manual

#### How to use the CD-R/RW drive

This manual is supplement of the MR-8HD/CD owner's manual. It describes how to use the CD-R/RW drive built in the MR-8HD/CD, as well as an external CD-R/RW drive connected to the [USB HOST] port of the MR-8HD/CD. Before you use a CD-R/RW drive, read this supplementary manual together with the MR-8HD/CD owner's manual.

For using the internal CD-R/RW drive, this supplementary manual explains the following four items.

- (1) **How to create an audio CD**
- (2) **How to import audio data from a CD-DA disc**
- (3) **How to convert song data to a mono WAV file and export it**
- (4) **How to import a mono WAV file from a CD-R/RW disc**

For using an external CD-R/RW drive, it only explains "**how to create an audio CD**". Note that you can only create an audio CD using an external CD-R/RW drive.

## Table of contents

<b>Please read before using .....</b>	<b>3</b>
Usable discs .....	3
Handling of discs .....	3
Track data for creating an audio CD .....	4
<b>Before creating an audio CD (playing back a stereo WAV file) .....</b>	<b>5</b>
Selecting a stereo WAV file for playback .....	5
Playing back a stereo WAV file .....	6
Storing CUE points .....	6
<b>Creating an audio CD using the internal CD-R/RW drive .....</b>	<b>9</b>
<b>Viewing the TOC information .....</b>	<b>13</b>
Viewing the TOC information before finalizing .....	13
Viewing the TOC information after finalizing .....	14
<b>Importing track data on a CD-DA disc .....</b>	<b>15</b>
<b>Exporting song data to a CD-R/RW disc .....</b>	<b>17</b>
<b>Importing a mono WAV file .....</b>	<b>19</b>
<b>Creating an audio CD using an external CD-R/RW drive .....</b>	<b>22</b>
<b>Viewing the TOC information .....</b>	<b>26</b>
Viewing the TOC information before finalizing .....	26
Viewing the TOC information after finalizing .....	27

## Please read before using

Before using the internal CD-R/RW drive of the MR-8HD/CD (or an external CD-R/RW drive), read the following.

### Usable discs

Only discs with any of the following logos can be used with the internal CD-R/RW drive of the MR-8HD/CD (or an external CD-R/RW drive connected to the MR-8HD/CD [USB HOST] port).



#### <CD-R disc>

You can make additional recording to a CD-R disc until it is finalized if it is brand new and still has enough recordable area (additional recording is possible only in the "Track at once" mode).



#### <CD-RW disc>

You can make additional recording to a CD-RW disc until it is finalized if it is brand new and still has enough recordable area (additional recording is possible only in the "Track at once" mode).



#### <CD disc>

You can view TOC information of a disc with this logo (such as a commercially available CD) but you cannot make recording.

**<Note>**: Using the internal CD-R/RW drive of the MR-8HD/CD (or an external CD-R/RW drive connected to the MR-8HD/CD [USB HOST] port), you cannot play back CD-DA discs you created (or commercially available audio CDs).

### Handling of CD-R/RW discs

- Handle a disc with care by holding them by the rim or by a finger through the center hole, rather than touching the surface. Do not get fingerprints, dust, scratch, etc. on the signal side.
- Do not affix any labels or stickers to the label side of the disc. Do not make a scratch on the label side. A scratch may make recording or playback impossible. Do not write on the label side of a disc with a hard pen such as a ballpoint pen and a pencil. Only use a soft pen.
- Do not use a curved or cracked disc, which may cause malfunction of the drive.
- If dust or fingerprint is attached to the signal side, wipe the disc gently with a soft dry cloth or a cloth with ethyl alcohol from the center towards the outside edge. Do not wipe it from the outside towards the center.

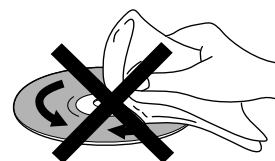
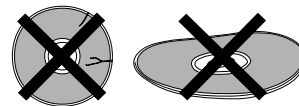
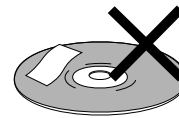
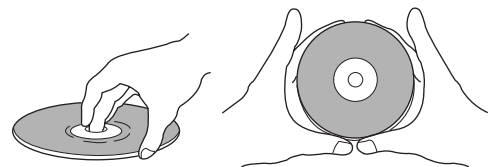

## Track data which can be recorded to a CD-R/RW disc

You can record a stereo WAV file converted from two mono files on tracks 7 and 8 (final mixed-down files) to a CD-R/RW disc in the CD-DA format. Mixed-down files on tracks 7 and 8 can be created by in either of the following track bouncing methods.

(1) Bouncing tracks 1 through 6 to tracks 7/8 of the same song.

(2) Bouncing tracks 1 through 8 to tracks 7/8 of the new song.

See pages 63 through 74 of the MR-8HD/CD owner's manual for details about track bouncing. See pages 90 and 91 of the MR-8HD/CD owner's manual for details about how to convert files on tracks 7 and 8 to a stereo WAV file.

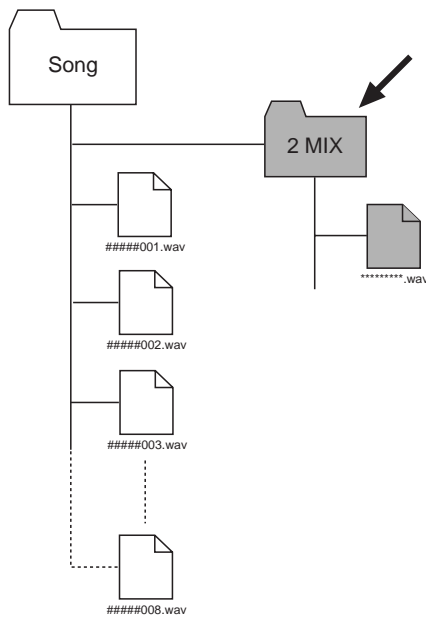

On the MR-8HD/CD, a stereo WAV file converted from track 7/8 data is stored to the "2 MIX" folder in the Song folder of the original song (see the illustration on the left). Also see page 93 of the MR-8HD/CD owner's manual.

When creating an audio CD using the internal CD-R/RW drive (or an external CD-R/RW drive), only stereo WAV files in the "2 MIX" folder can be burned to a CD-R/RW disc in the CD-DA format. Therefore, you must load the song in which one or more desired stereo WAV files are stored.

Before creating an audio CD, read the <Note> on the next page.

**<Hint!>** Before creating an audio CD, you can check a stereo WAV file in the "2 MIX" folder by playing back in the "2 MIX file playback" mode (see page 5 for details), as well as can set CUE points for track division. If you make an audio CD from a stereo WAV file which contains more than one song (such as a file of "live" recording), you can divide the file into tracks by setting a CUE to the beginning of each song. In this case, select the burning mode to "Disk at once" when creating an audio CD (for details about how to set a CUE, see "Stereo WAV file playback" from the next page).

**<Note>**: To play back a stereo WAV file or create an audio CD, you must load the song in which the bounced track data on tracks 7/8 has been converted to the stereo WAV file (see the example below).

**<Example>**: If five songs (01 through 05) are recorded on the hard disk and the stereo WAV file to be burned to a CD-R/RW disc is stored in the "2 MIX" folder of Song 03;

**Load Song 03 before starting the operation.**

To load the desired song, use the "Select Song" menu item in the "Song" menu of the MENU mode. See page 98 of the MR-8HD/CD owner's manual for details about the "Select Song" menu item.

## Before creating an audio CD (playing back a stereo WAV file)

The unit provides the "2 MIX file playback mode". In this mode, you can playback a stereo WAV file converted for creating an audio CD in the CD-DA format. You can not only check the file but also set CUE points for track division.

**<Note>**: To activate the "2 MIX file playback mode", the current song has a stereo WAV file in the "2 MIX folder". If the song does not have a stereo WAV file in the "2 MIX folder", you cannot use the "2 MIX file playback mode". In the "2 MIX file playback mode", you can play back the stereo WAV file, as well as store or edit CUE points, but cannot record audio or make track/part editing.

### Selecting a stereo WAV file for playback

The following shows how to select a desired stereo WAV file from the "2 MIX folder" of the current song. It is assumed that a song which has a stereo WAV file in the "2 MIX folder" is currently loaded.

- 1) While the unit is stopped, press the [MENU/ENTER] knob to enter the MENU mode. The display now shows the menu selection screen, where "◀◀ Back" is initially highlighted.

```
MENU(1/2)▶Back
▼◀◀Back
System ▶
Songs ▶
Track Edit ▶
Part Edit ▶
Rhythm Guide ▶
```

- 2) Use the [MENU/ENTER] knob to select "Song ▶" and press the [MENU/ENTER] knob. The display now shows the song menu screen.

```
MENU(1/2)▶Songs
◀◀Back
System ▶
◀ Songs ▶
Track Edit ▶
Part Edit ▶
Rhythm Guide ▶
```

```
M▶Songs(1/2)▶Back
▼◀◀Back
Select Song ▶
Rename Song ▶
Delete Song ▶
Protect = Off
Select 2mix ▶
```

- 3) Use the [MENU/ENTER] knob to select "Select 2mix ▶" and press the [MENU/ENTER] knob. The display now shows the list of stereo WAV files available in the "2 MIX folder" of the current song.

```
M▶Songs(1/2)▶Back
◀◀Back
Select Song ▶
Rename Song ▶
Delete Song ▶
Protect = Off
◀ Select 2mix ▶
```

↓

```
M▶Songs▶Sel. 2mix(1/1)
▼◀◀Back
01: Songs01.wav
02: Songs02.wav
03: Songs03.wav
04: Songs04.wav
```

**<Note>**: If no stereo WAV file is available in the "2 MIX folder" of the current song, the display pops up "No stereo files!" and returns to the screen where "Select 2mix▶" is highlighted. In such a case, exit the MENU mode and reselect a song.

- 4) Use the [MENU/ENTER] knob to select the desired stereo WAV file and press the [MENU/ENTER] knob.

The display now shows the Home screen of the "2 MIX file playback mode".

```
0m 00s 000ms
File Songs01.wav
CUE-01 Cue 01
L: : : : : : : : : : : :
060 44 28 20 1310 8 6 4 2 00L
R: : : : : : : : : : : :
```

While this Home screen is shown, you can playback the stereo WAV file or store CUE points.

**<Note>**: To exit the Home screen of the "2 MIX file playback mode", execute steps 1 and 2 above, and select "Select Song ▶" and press the [MENU/ENTER] knob. Then use the [MENU/ENTER] knob to select the desired song and press the [MENU/ENTER] knob. The song is loaded.

## Playing back a stereo WAV file

While the Home screen of the "2 MIX file playback mode" is shown, pressing the [PLAY] key plays back the stereo WAV file. The L and R channels of the stereo WAV file are assigned to tracks 1 and 2 respectively. The L and R playback levels of the stereo WAV file are controlled by the faders for tracks 1 and 2.

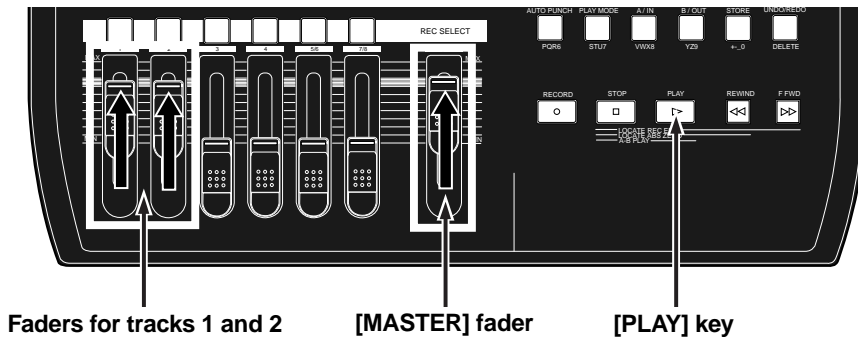

## Storing CUE points (up to 99 cue points can be set per file)

In the "2 MIX file playback mode", you can set CUE points at the desired positions during playback or while stopped. When you create an audio CD by burning the stereo WAV file which contains one or more CUE points in the "Disk at once" mode, the TOC (Table of contents) is created by reflecting the CUE point list (see page 10 for details about "Disk at once"). When you make an audio CD from a stereo WAV file which contains more than one song such as a file of live recording, you can divide the file into tracks by setting a CUE to the beginning of each song.

- 1) After pressing the [PLAY] key to start playback of the file, press the [STORE] key at the desired position to set a CUE point. (You can also set a CUE point while the recorder is stopped.) The display shows the CUE list screen.

The screen example below is the CUE list screen which is shown after setting the first CUE point. "<New Entry>" and "C01 (Cue 01)" are listed.

On the right of "<New Entry>", the time of the CUE point when you have pressed the [STORE] key is shown.

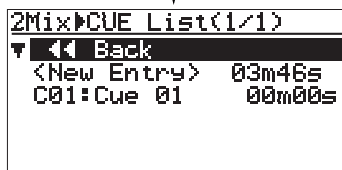
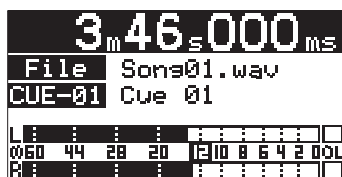

**<Note>:** "C01 (Cue 01)" in the CUE list shows the CUE point automatically set at the beginning of the file. You cannot delete or edit "C01".

- 2) Use the [MENU/ENTER] knob to select "<New Entry>" and press the [MENU/ENTER] knob. "<ENTER>" is now highlighted on the screen.

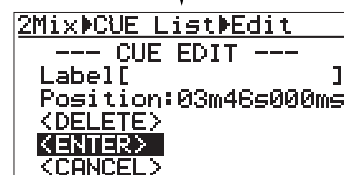
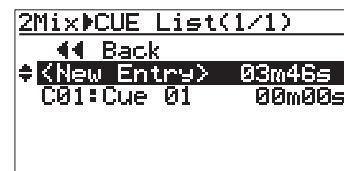

**<Note>:** If you execute step 3) below while the screen above is shown, the new CUE point is stored with no label. You can enter a label after storing a CUE point. See "Entering a label" on the next page for details about how to enter a label.

- 3) While "<ENTER>" is highlighted, press the [MENU/ENTER] knob. The position where you pressed the [STORE] key is stored as C02. In this procedure example, the CUE point is stored with no label.

```

2Mix▶CUE List▶Edit
--- CUE EDIT ---
Label[ ]
Position:03m46s000ms
<DELETE>
<ENTER>
<CANCEL>

```

```

2Mix▶CUE List(1/1)
◀◀ Back
▶◀ <New Entry> 03m46s
C01:Cue 01 00m00s
C02: 03m46s

```

**<Note>**: The distance between two adjacent CUE points must be over four seconds. If you attempt to set a new CUE point within four seconds after or before another existing CUE point, "Error Overlap Position!" is popped up and you cannot store the CUE point.

- 4) Press the [STOP] key to show the Home screen of the "2 MIX file playback mode".

To store another CUE point, repeat steps 1 through 4 above. In the following screen example, multiple CUE points are stored.

```

2Mix▶CUE List(1/1)
◀◀ Back
▶◀ <New Entry> 13m26s
C01:Cue 01 00m00s
C02: 03m46s
C03: 08m38s
C04: 13m26s

```

For details about how to enter a CUE label, how to edit time data and how to delete an unnecessary CUE point, see the right of this page and the next page.

- 5) After storing the desired CUE label(s), press the [STOP] key, or use the [MENU/ENTER] knob to select "◀◀ Back" and press the [MENU/ENTER] knob.

The display returns to the Home screen of the "2 MIX file playback mode".

**<Hint>**: To bring up the Home screen of the song when the Home screen of the "2 MIX file playback mode" is shown, follow the procedure below.

- 1) While the Home screen of the "2 MIX file playback mode" is shown, press the [MENU/ENTER] knob to enter the MENU mode.
- 2) Use the [MENU/ENTER] knob to select "Song ▶" and press the [MENU/ENTER] knob.
- 3) Use the [MENU/ENTER] knob to select "Select Song ▶" and press the [MENU/ENTER] knob.
- 4) Use the [MENU/ENTER] knob to select a desired song and press the [MENU/ENTER] knob.

**<Hint>**: If you select a desired CUE point in the CUE list and press the [LOCATE A/IN] or [LOCATE B/OUT] key, the recorder quickly locates to the CUE point.

### Entering a CUE label

You can enter a CUE label by the following procedure. It is assumed that the Home screen of the "2 MIX file playback mode" is shown.

- 1) While the unit is stopped, press the [STORE] key. The display now shows the CUE list screen.

```

2Mix▶CUE List(1/1)
◀◀ Back
▶◀ <New Entry> 13m26s
C01:Cue 01 00m00s
C02: 03m46s
C03: 08m38s
C04: 13m26s

```

- 2) Use the [MENU/ENTER] knob to select the desired CUE and press the [MENU/ENTER] knob.

In the upper screen example below, "C02" is selected. Then pressing the [MENU/ENTER] knob brings up the lower screen example below, where "<ENTER>" is highlighted on the screen.

```

2Mix▶CUE List(1/1)
◀◀ Back
<New Entry> 13m26s
C01:Cue 01 00m00s
▶◀ C02: 03m46s
C03: 08m38s
C04: 13m26s

```

```

2Mix▶CUE List▶Edit
--- CUE EDIT ---
Label[ ]
Position:03m46s000ms
<DELETE>
<ENTER>
<CANCEL>

```

- 3) Use the [MENU/ENTER] knob to select "Label [ ]" and press the [MENU/ENTER] knob. The cursor flashes at the leftmost point of the [ ] and you can now enter the desired label.

```

2Mix▶CUE List▶Edit
--- CUE EDIT ---
Label[ ]
Position:03m46s000ms
<DELETE>
<ENTER>
<CANCEL>

```

```

2Mix▶CUE List▶Edit
--- CUE EDIT ---
Label[ ]
Position:03m46s000ms
<DELETE>
<ENTER>
<CANCEL>

```

Flashing

Use the alphanumeric keys to enter the desired CUE label. When you press a different alphanumeric key, the cursor automatically moves right.

If you enter a character using the same key as the previous character, use the [MENU/ENTER] knob to move the cursor right.

In this procedure example, it is assumed that "Cue 02" is entered as a CUE label.

- 4) After entering a desired CUE label, press the [MENU/ENTER] knob.

"Label [Cue 02 ]" is highlighted on the screen.

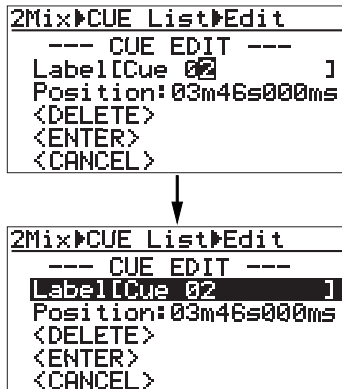

- 5) Use the [MENU/ENTER] knob to select "<ENTER>" and press the [MENU/ENTER] knob.

The CUE label is stored, while the display changes as below.

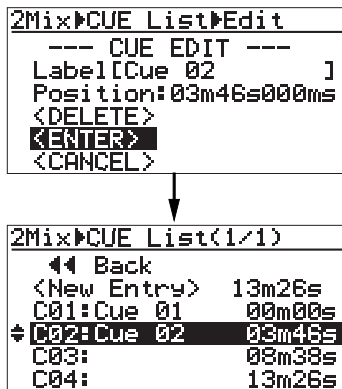

To enter or edit the label of another CUE, repeat the same procedure.

- 6) After storing the desired CUE label(s), press the [STOP] key, or use the [MENU/ENTER] knob to select "◀ Back" and press the [MENU/ENTER] knob.

The display returns to the Home screen of the "2 MIX file playback mode".

To exit the "2 MIX file playback mode", select any desired song by following the procedure described in <Hint> on page 7.

## Editing a CUE position

You can edit a CUE position (time) by following the procedure below, which is similar to the procedure for entering a CUE label as described above. The following assumes that the CUE list screen is shown.

- 1) Use the [MENU/ENTER] knob to select the CUE you want to edit and press the [MENU/ENTER] knob.
- 2) Use the [MENU/ENTER] knob to select "Position" and press the [MENU/ENTER] knob. "\*\*\*" of "\*\*\*ms" starts flashing.
- 3) Use the [MENU/ENTER] knob to enter a numeric value at the flashing point. You can move the flashing point by using the [REWIND] or [F FWD] key.
- 4) After editing the time, press the [MENU/ENTER] knob to confirm the edited time.
- 5) Use the [MENU/ENTER] knob to select "<ENTER>" and press the [MENU/ENTER] knob. The edited time is stored.
- 6) Press the [STOP] key, or use the [MENU/ENTER] knob to select "◀ Back" and press the [MENU/ENTER] knob. The display returns to the Home screen of the "2 MIX file playback mode".

To exit the "2 MIX file playback mode", select any desired song by following the procedure described in <Hint> on page 7.

## Deleting a CUE

You can delete an existing CUE in the similar manner. The following assumes that the CUE list screen is shown.

- 1) Use the [MENU/ENTER] knob to select the CUE you want to delete and press the [MENU/ENTER] knob.
- 2) Use the [MENU/ENTER] knob to select "<DELETE>" and press the [MENU/ENTER] knob. The selected CUE is deleted and the display returns to the CUE list screen.
- 3) Press the [STOP] key, or use the [MENU/ENTER] knob to select "◀ Back" and press the [MENU/ENTER] knob. The display returns to the Home screen of the "2 MIX file playback mode".

To exit the "2 MIX file playback mode", select any desired song by following the procedure described in <Hint> on page 7.



## Creating an audio CD using the internal CD-R/RW drive

Using the internal CD-R/RW drive, you can burn a stereo WAV file in the "2 MIX folder" to a CD-R/RW disc for creating an audio CD in the CD-DA format.

By finalizing a burned disc, you can play it back by a common CD player.

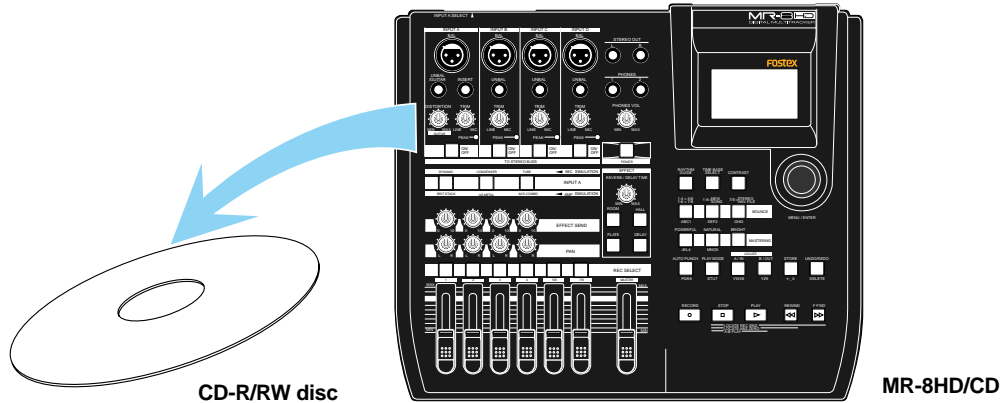

**CD-DA:** It stands for "Compact Disc-Digital Audio" and is the formal name of audio CD. The format is specified in the "Red Book". An audio signal is converted to PCM-coded stereo digital data with 44.1kHz sampling frequency and 16-bit quantization.

### <How to handle the internal CD-R/RW drive>

Handle the internal CD-R/RW drive correctly by following the description below.

#### (1) Opening the tray

When the MR-8HD/CD is powered on, press the eject switch on the front of the tray.

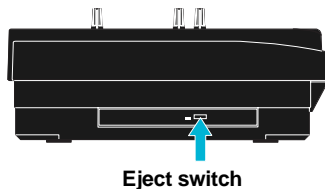

Eject switch

By pressing the eject switch, the tray comes out a little. Then pull it out by hand (arrow direction).

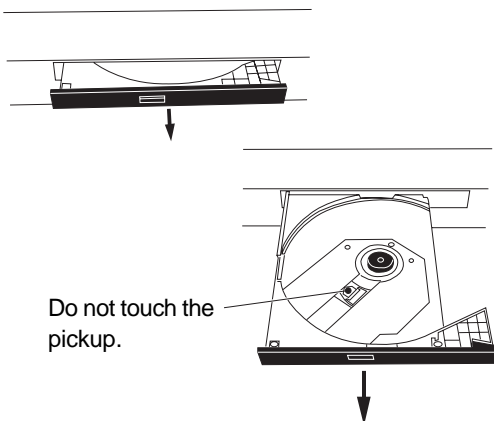

#### (2) Setting a disc and closing the tray

Set a disc while supporting the tray from the bottom by hand.

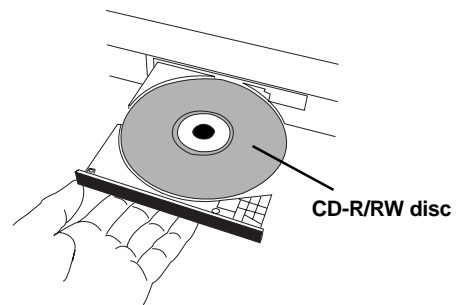

CD-R/RW disc

After setting a disc, push the tray gently to close it.

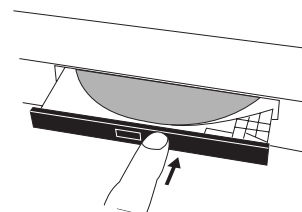

Push the tray gently until it clicks. Do not operate the unit until the access indicator turns off.

### About "Track at once" and "Disk at once"

The MR-8HD/CD provides two burning modes for creating an audio CD in the CD-DA format.

#### "Track at once"

The unit burns a stereo WAV file to a CD-R/RW disc as a track. You can burn an additional track at a later time until the disc is finalized. Each time you burn a file, a TOC is created. Approximately two-second silence is automatically inserted between tracks.

#### "Disk at once"

The unit burns a stereo WAV file and automatically finalizes the disc. You cannot burn an additional data. As described earlier in "2 MIX file playback mode", when one or more CUE points are set to the stereo WAV file, file data is divided into tracks at the CUE points. In this mode, no mute space is created between tracks. (Note that if the stereo WAV file does not have any CUE point, it is burned as a single track.)

The following is assumed that a song which has a stereo WAV file in the "2 MIX folder" is loaded.

- 1) **Set a blank CD-R/RW disc to the CD-R/RW drive.**
- 2) **While the unit is stopped, press the [MENU/ENTER] knob to enter the MENU mode.**  
The display now shows the first page of the menu selection screen.

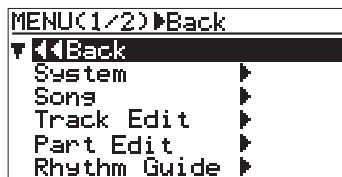

- 3) **Use the [MENU/ENTER] knob to select "CD-RW" on the second page and press the [MENU/ENTER] knob.**  
The display now shows the CD-RW menu screen.

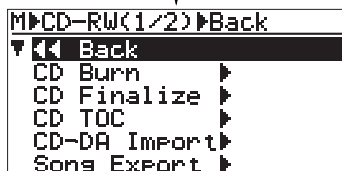
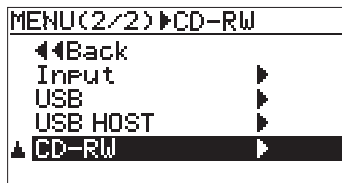

- 4) **Use the [MENU/ENTER] knob to select "CD Burn" and press the [MENU/ENTER] knob.**  
The display now shows the Burning mode selection screen.

You can select between "Track at once" and "Disk at once".

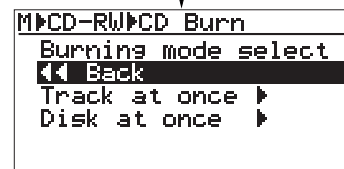
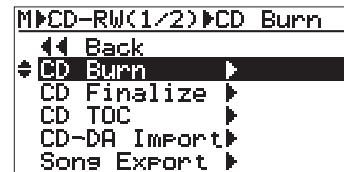

- 5) **Use the [MENU/ENTER] knob to select the desired burning mode and press the [MENU/ENTER] knob.**  
The display now shows the screen for selecting a stereo WAV file in the "2 MIX folder" of the current song.  
In the screen example below, only one stereo WAV file is stored.

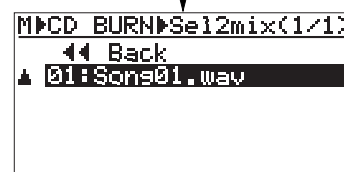
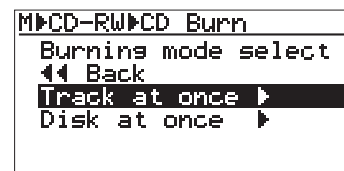

**<Note>**: When more than one stereo WAV file is stored in the "2 MIX folder" (as shown in the example below), you can use the [MENU/ENTER] knob to select a desired file for "CD Burn" (The maximum number of displayed files in the list is ten).

```

M▶CD BURN▶Sel2mix(1/2)
  ◀◀ Back
  ◀ 01: Sons01.wav
    02: Sons02.wav
    03: Sons03.wav
    04: Sons04.wav
    05: Sons05.wav
  
```

- 6) Use the [MENU/ENTER] knob to select the desired WAV file and press the [MENU/ENTER] knob.

The unit starts writing the file to the CD-R/RW disc. Depending on the selected burning mode, either of the following screens is shown.

While the unit is writing data to the disc, "Writing..." is popped up and "ACC" is flashing on the screen.

Also the ACCESS indicator of the CD-R/RW drive is flashing. Do not turn off the power or press the eject switch of the drive while writing.

While writing data to the disc, any operational keys are disabled.

```

M▶CD-RW▶CD Burn
  -- CD BURN TRACK --
  Writing...
  0 50 100%
  
```

Now writing in the  
Track at once mode

```

M▶CD-RW▶CD Burn
  -- CD BURN DISK --
  Writing...
  0 50 100%
  
```

Now writing in the  
Disk at once mode

**<Note>**: If the selected stereo WAV file is larger than the available disc space of the current CD-R/RW disc, the following message pops up and you cannot start writing (you can dismiss the message by pressing the [MENU/ENTER] knob). Change the disc to another one with enough space and carry out the same operation procedure.

```

Not Enough Remain
Press ENTER Key
  
```

When writing is completed, "Completed!" is shown and the disc access stops.

```

M▶CD-RW▶CD Burn
  -- CD BURN TRACK --
  Completed!
  0 50 100%
  Press ENTER Key!
  
```

Now writing in the  
Track at once mode is completed

```

M▶CD-RW▶CD Burn
  -- CD BURN DISK --
  Completed!
  0 50 100%
  Press ENTER Key!
  
```

Now writing in the  
Disk at once mode is completed

- 7) Press the [MENU/ENTER] knob. The display returns to the CD-RW menu screen, where "CD Burn ▶" is highlighted.

```

M▶CD-RW(1/2)▶CD Burn
  ◀◀ Back
  ◀ CD Burn ▶
  CD Finalize ▶
  CD TOC ▶
  CD-DA Import▶
  Song Export ▶
  
```

When the disc is burned in the "Disk at once" mode, it is automatically finalized after writing is completed, and then ejected.

You can check the TOC information if desired. See "Viewing the TOC information after finalizing" on page 14 for details.

When the disc is burned in the "Track at once" mode, go to step 8 for finalizing the disc.

If you want to write more than one stereo WAV file, repeat steps 4 through 6 above, and go to step 8 for finalizing after writing all the desired stereo WAV files.

You can check the TOC information any time (both before and after finalizing). It is recommended to check the remaining time (the recordable time left) from the TOC information whenever you write an additional stereo WAV file (see "Viewing the TOC information" on page 13 for details).

- 8) Use the [MENU/ENTER] knob to select "CD Finalize ▶" and press the [MENU/ENTER] knob.

The display now shows the confirmation screen for finalizing, where "[CANCEL]" is highlighted.

To cancel finalizing, highlight "[CANCEL]" and press the [MENU/ENTER] knob.

To start finalizing, highlight "[EXECUTE]" and press the [MENU/ENTER] knob.

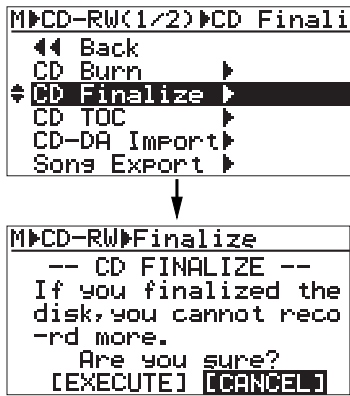

- 9) Use the [MENU/ENTER] knob to select "[EXECUTE]" and press the [MENU/ENTER] knob. The display now shows the status of finalizing. When finalizing is completed, "Completed!" is shown and the disc is automatically ejected from the CD-R/RW drive.

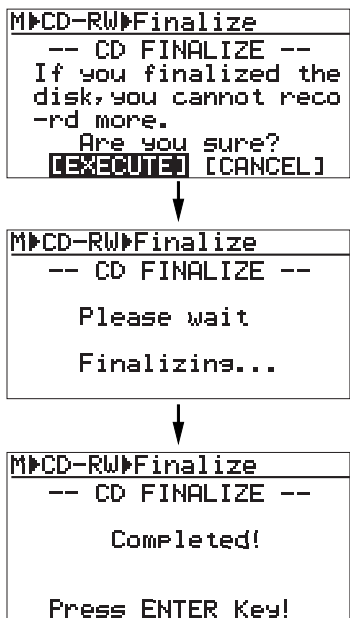

**<Note>**: Once you finalize a disc written in the "Track at once" mode, you cannot make additional writing any more. If you reload the finalized disc and attempt to write a file, "Already Finalized" is popped up and operation is cancelled.

- 10) Press the [MENU/ENTER] knob. The display returns to the CD-RW menu screen, where "CD Finalize" is highlighted.

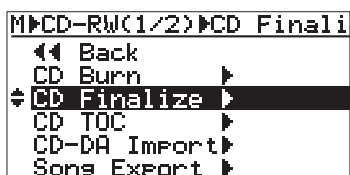

You can check the TOC information after finalizing. See "Viewing the TOC information after finalizing" on page 14 for details.

- 11) Press the [STOP] key to exit the MENU mode. You can also exit the MENU mode by selecting "Back" and pressing the [MENU/ENTER] knob repeatedly.

The following shows how audio CD data is written to a CD-R/RW disc in the "Track at once" or "Disk at once" mode.

- Writing a single stereo WAV file in the "Track at once" mode:



- Writing four stereo WAV files in the "Track at once" mode:

A two-second silence is automatically inserted between tracks.



█ : Approximately two-second silence (mute)

- Writing a single stereo WAV file with only CUE01 in the "Disk at once" mode:



- Writing a single stereo WAV file with three CUE points in addition to CUE01 in the "Disk at once" mode:

The file is divided into four tracks with no silence between tracks.



## Viewing the TOC information

You can view the TOC information of a burned disc both before finalizing and after finalizing (for a disc burned by "Disk at once", you can view the TOC only after finalizing, of course). It is recommended to check the remaining time (the recordable time left) from the TOC information whenever you write an additional stereo WAV file in the "Track at once" mode.

**<TOC>**: TOC stands for Table of Contents. TOC lists number of CD tracks, their starting locations, playing time of each track on the disc, etc.

### Viewing the TOC information before finalizing (only for a disc burned by "Track at once")

The following assumes that a disc contains a track burned by "Track at once" and has not yet been finalized, while "CD Burn ►" is highlighted on the CD-RW screen.

- 1) Use the [MENU/ENTER] knob to select "CD TOC ►" and press the [MENU/ENTER] knob. The display shows "Please Wait...", followed by the track number and playing time, as well as the disc remaining time.



- 2) After viewing TOC, use the [MENU/ENTER] knob to select "◀◀ Back" and press the [MENU/ENTER] knob. The display returns to the screen where "CD TOC ►" is highlighted.

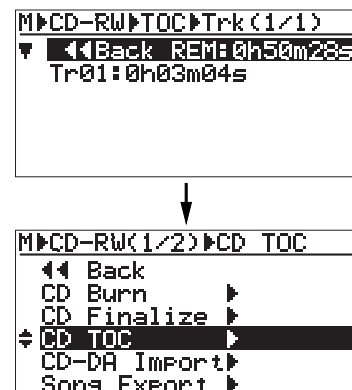

To burn an additional track by "Track at once" after viewing the TOC information, select "CD Burn ►" and press the [MENU/ENTER] knob, then select a desired stereo WAV file, as described earlier (see page 11).

To finalize the disc after viewing the TOC information, select "CD Finalize ►" and press the [MENU/ENTER] knob (see page 11).

**<Note>**: The following shows the screen example when you burn multiple WAV files by "Track at once". You can check the playing time of each track as well as the disc remaining time.

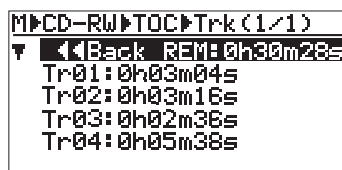

## Viewing the TOC information after finalizing

The following assumes that a disc automatically finalized after "Disk at once" writing or a disc finalized after "Track at once" writing is ejected from the internal CD-R/RW drive, while the display shows the CD-RW menu screen where "CD Finalize ▶" is highlighted.

- 1) **Close the ejected disc tray of the CD-R/RW drive.**

Push the front of the disc tray gently by hand. The finalized disc is loaded. Confirm that the "CD Finalize ▶" is highlighted on the screen.

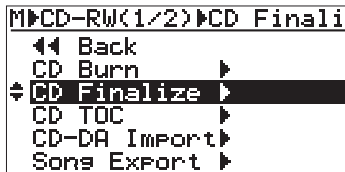

**<Note>:** When you close the tray, the drive starts reading the disc and the access indicator starts flashing. Therefore, do not carry out the next operation until the drive stops accessing and the access indicator gets unlit.

- 2) **Use the [MENU/ENTER] knob to select "CD TOC ▶" and press the [MENU/ENTER] knob.**

The display shows "Please Wait...", followed by the TOC information, as with "Viewing the TOC information before finalizing".

However, in this case, the remaining time is shown as "0h 00m 00s", which means no more track can be recorded to this finalized disc.

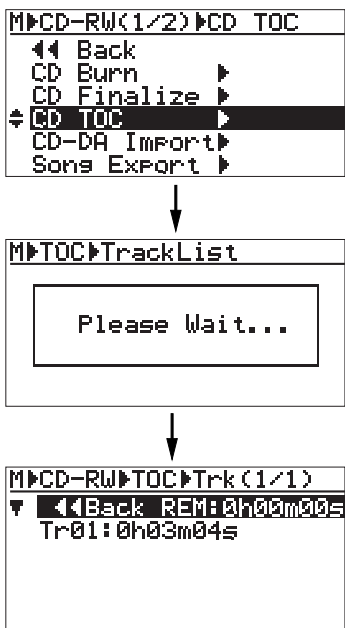

- 3) **After checking the TOC information, use the [STOP] key to exit the MENU mode.**

The display returns to the Home screen.

**<Note>:** When you burn multiple stereo WAV files by "Track at once" and finalized or you burn a stereo WAV file with multiple CUE points by "Disk at once", the Track list screen looks like the one below (the remaining time is shown as "0h 00m 00s", of course).

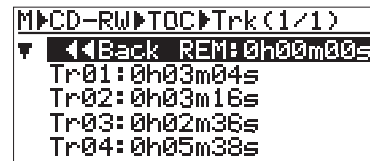

**<Note>:** You can also view the TOC of a commercially available audio CD, as with an audio CD you create using the MR-8HD/CD. (Note that some commercially available audio CDs may not show the TOC information.)

To do this, set an audio CD to the CD-R/RW drive and carry out the same operation as described above using the "CD-RW" menu in the MENU mode.

Note that you can view only the playing time of each track. You cannot view track titles.

## Importing track data on a CD-DA disc

You can import (copy) track data on a CD-DA (audio CD) disc (including a commercially available audio CD) to a stereo track pair (1/2, 3/4, 5/6 or 7/8) of the currently loaded song. When importing track data, data is converted to a pair of mono WAV files.

In the following description, it is assumed that a CD-DA disc is set to the internal CD-R/RW drive and the song of the import destination is loaded.

**<Note>**: You can import track data on a CD-DA disc only to the internal CD-R/RW drive. You cannot import data to an external CD-R/RW drive connected to the [USB HOST] port.

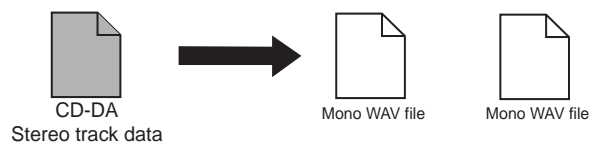
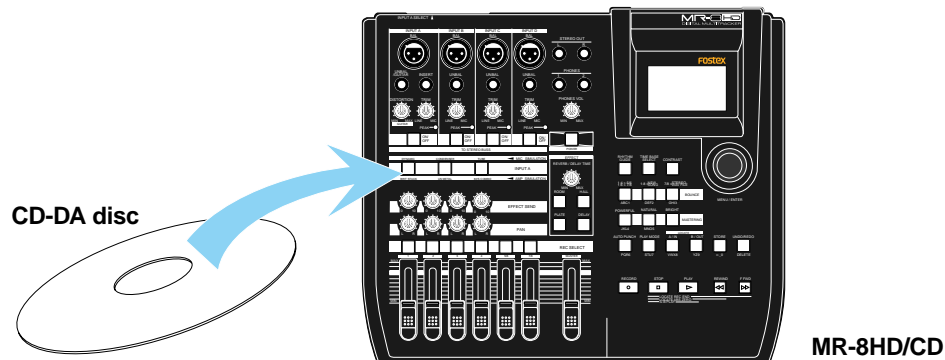

Stereo track data on a CD-DA disc is converted to two mono WAV files for L and R channels.

The WAV file for L channel is imported (copied) to the odd channel of a channel pair, while the file for R channel is imported (copied) to the even channel.

- 1) While the unit is stopped, press the [MENU/ENTER] knob to enter the MENU mode. The display now shows the first page of the menu selection screen.

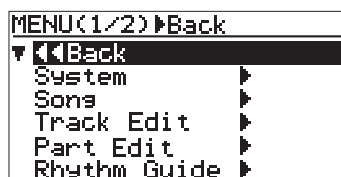

- 2) Use the [MENU/ENTER] knob to select "CD-RW ▶" on the second page and press the [MENU/ENTER] knob. The display now shows the CD-RW menu screen.

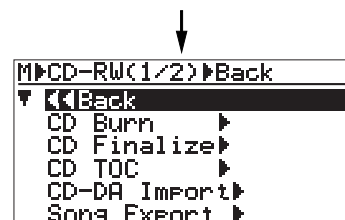
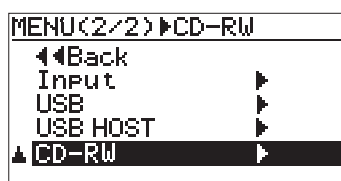

- 3) Use the [MENU/ENTER] knob to select "CD-DA Import ▶" and press the [MENU/ENTER] knob. The display now shows the screen for selecting the source CD track number and the destination track pair of the MR-8HD/CD.

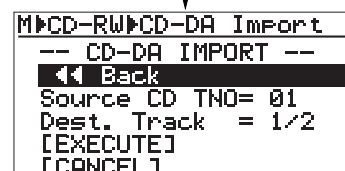
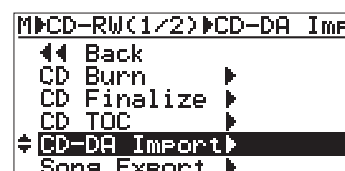

- 4) Use the [MENU/ENTER] knob to select "Source CD TNO=\*" and press the [MENU/ENTER] knob.  
 You can now select the desired track number of the CD-DA disc.

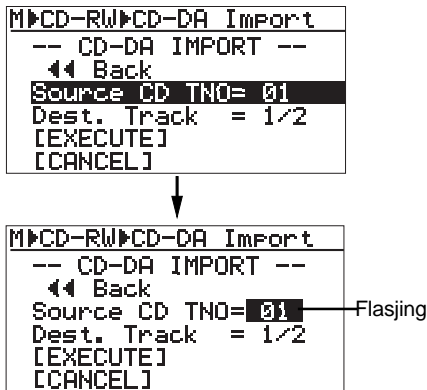

- 5) Use the [MENU/ENTER] knob to select the desired track number and press the [MENU/ENTER] knob.  
 The display now highlights "Source CD TNO=\*".
- 6) Use the [MENU/ENTER] knob to select "Dest. Track=\*" and press the [MENU/ENTER] knob.  
 You can now select the desired destination track pair of the currently loaded song.

You can select a track pair from among "1/2", "3/4", "5/6" and "7/8".

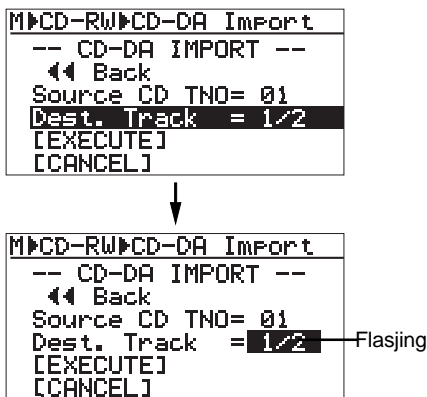

- 7) Use the [MENU/ENTER] knob to select the desired destination track pair and press the [MENU/ENTER] knob.  
 The display now highlights "Dest. Track=\*".
- 8) Use the [MENU/ENTER] knob to select "[EXECUTE]" and press the [MENU/ENTER] knob.  
 The unit starts importing track data from the CD-DA disc. When completed, "Completed!" is shown on the display.

**<Note>**: CD track data is imported from the beginning of each MR-8HD/CD tracks (ABS 0).

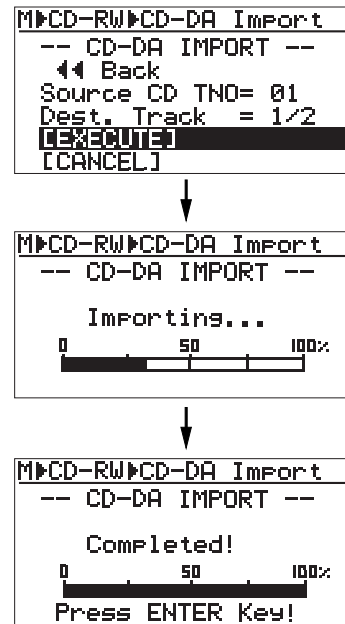

- 9) Press the [MENU/ENTER] knob.  
 The display returns to the CD-RW menu screen, where "CD-DA Import" is highlighted.

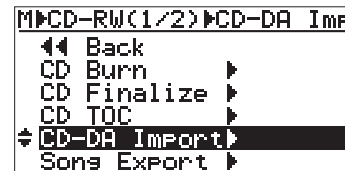

- 10) Press the [STOP] key to exit the MENU mode.

You can also exit the MENU mode by selecting "Back" and pressing the [MENU/ENTER] knob repeatedly.

**<Note>**: If you do not satisfy with the result, press the [UNDO/REDO] key to undo the import operation. The unit returns to the condition before importing a track. Note that, however, once you eject the disc, load another song or turn off the power, you cannot undo the import operation.



## Exporting song data to a CD-R/RW disc

You can convert song data (tracks 1 through 8) of the currently loaded song to mono WAV files and export (copy) them to a CD-R/RW disc. Not only for data backup, the copied mono WAV files on a CD-R/RW disc also can be exported to a personal computer for use in the multitrack recording application.

Note that you can directly export song data to a personal computer using the WAV Manager by Fostex (see page 92 of the original manual for details).

The following description assumes that a blank CD-R/RW disc is set to the internal CD-R/RW drive and a source song is loaded to the MR-8HD/CD.

**<Note>:** You can copy converted mono WAV files to a CD-R/RW disc only using the internal CD-R/RW drive. You cannot copy mono WAV files to a CD-R/RW disc using an external CD-R/RW drive connected to the [USB HOST] port.

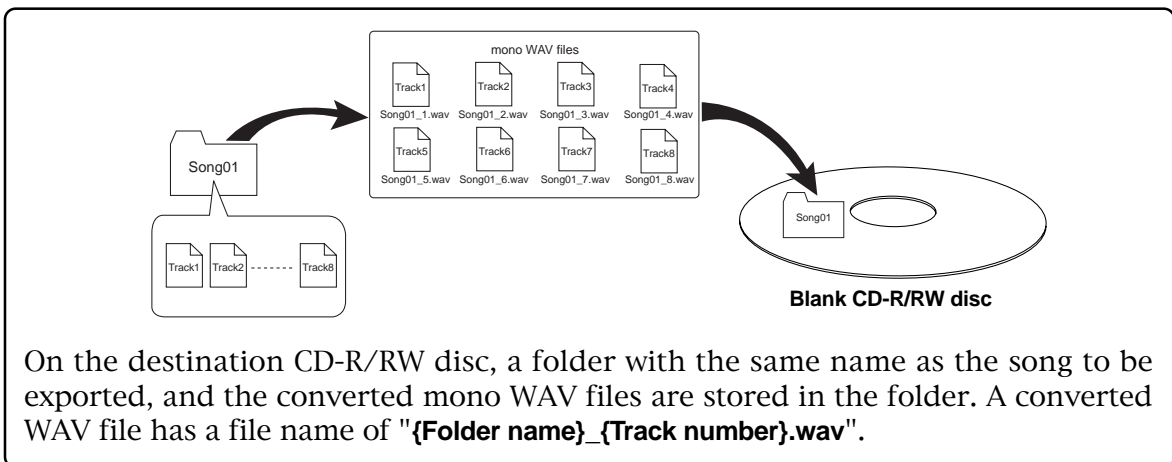
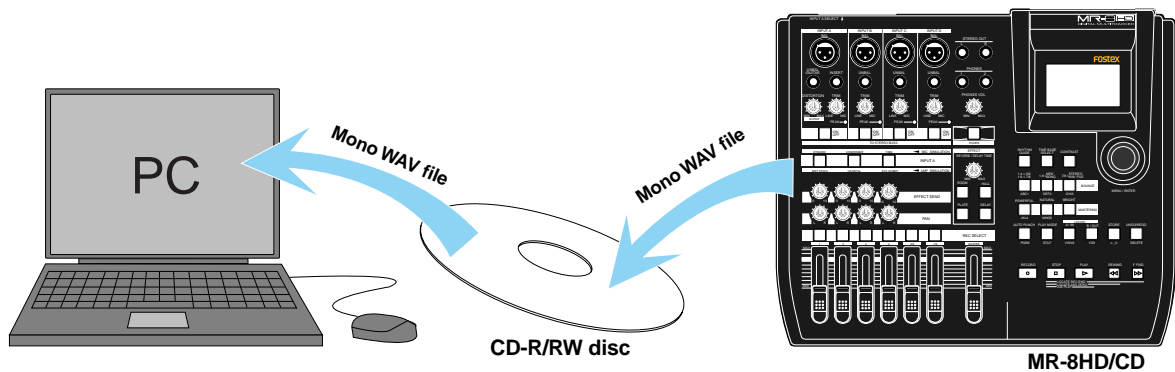

On the destination CD-R/RW disc, a folder with the same name as the song to be exported, and the converted mono WAV files are stored in the folder. A converted WAV file has a file name of "{Folder name}\_{Track number}.wav".

- 1) While the unit is stopped, press the [MENU/ENTER] knob to enter the MENU mode. The display now shows the first page of the menu selection screen.

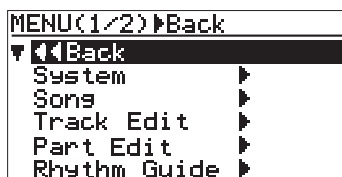

- 2) Use the [MENU/ENTER] knob to select "CD-RW" on the second page and press the [MENU/ENTER] knob. The display now shows the CD-RW menu screen.

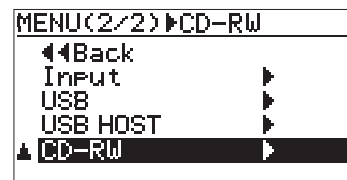

- 3) Use the [MENU/ENTER] knob to select "Song Export ▶" and press the [MENU/ENTER] knob. The display now shows the screen for setting the start time, end time and exported tracks. The display now highlights "[EXECUTE]".



By default, these items are set as follows.

- Start time: The beginning of a song (ABS 0)
- End time: The last recording position of a song
- Track selection: All tracks (1 through 8)

In other words, by default, you can export full length of all tracks. If you export a song data with the default setting above, skip to step 10. If you edit the setting, go to steps 4 through 9.

- 4) Use the [MENU/ENTER] knob to select "Start Time: 0m 00s 000" and press the [MENU/ENTER] knob. You can now edit the start time of the exported file(s).



**<How to edit a time>**  
 To edit the start or end time of the exported file(s), use either of the following operation methods.

- **Using the [MENU] dial:**  
 Use the [REWIND] or [F FWD] key to move the editing point and use the [MENU/ENTER] knob to edit the value.
- **Using the numeric keys:**  
 Directly enter a desired number using the appropriate numeric key. Each time you press a numeric key, the entered numbers on the screen move from the right towards the left. You can also use the [REWIND] or [F FWD] key to move the editing point.

- 5) After editing the start time, press the [MENU/ENTER] knob. "Start Time: \*m \*\*s \*\*\*" is now highlighted.

- 6) Use the [MENU/ENTER] knob to select "End Time" and press the [MENU/ENTER] knob. You can now edit the end time of the exported file(s).



- 7) After editing the end time, press the [MENU/ENTER] knob. "End Time: \*m \*\*s \*\*\*" is now highlighted.

- 8) Use the [MENU/ENTER] knob to select "TRK" and press the [MENU/ENTER] knob. You can now select the exported tracks. Selected tracks are highlighted. Only TRK "1" flashes.

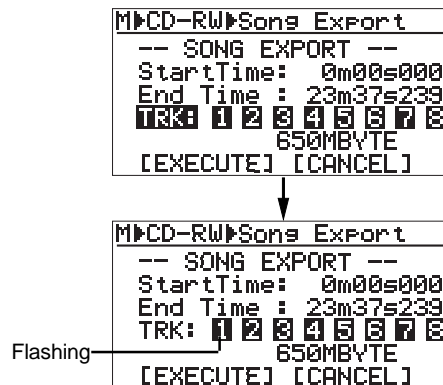

**<Note>:** A blank track is not highlighted.

**<How to select or deselect a track>**  
 Rotating the [MENU/ENTER] knob left deselects the flashing track, while rotating the [MENU/ENTER] knob right selects the flashing track.  
 Use the [F FWD] and [REWIND] keys to select the flashing track.

- 9) After selecting/deselecting the exported tracks, press the [MENU/ENTER] knob. "TRK" is now highlighted.

- 10) Use the [MENU/ENTER] knob to select "[EXECUTE]" and press the [MENU/ENTER] knob. The unit starts exporting track data to the CD-R/RW disc. When completed, "Completed" is shown on the display and the disc is automatically ejected. If you want to cancel exporting, select to "[CANCEL]" and press the [MENU/ENTER] knob.



- 11) Press the [MENU/ENTER] knob. The display now shows the CD-RW menu screen, where "Song Export" is highlighted.
- 12) Press the [STOP] key to exit the MENU mode.

You can also exit the MENU mode by selecting "◀ Back" and pressing the [MENU/ENTER] knob repeatedly.

## Importing a mono WAV file

You can import (copy) a mono WAV file of track data recorded/edited on a PC or backup data from a CD-R/RW disc to the hard disk of the MR-8HD/CD.

The following description assumes that a CD-R/RW disc which contains one or more mono WAV files is set to the internal CD-R/RW drive, while a "New Song" is loaded to the MR-8HD/CD (see page 31 of the original manual for details about how to create a "New Song").

**<Note>**: You can import a mono WAV file from a CD-R/RW disc only using the internal CD-R/RW drive. You cannot import a mono WAV file from a CD-R/RW disc using an external CD-R/RW drive connected to the [USB HOST] port.

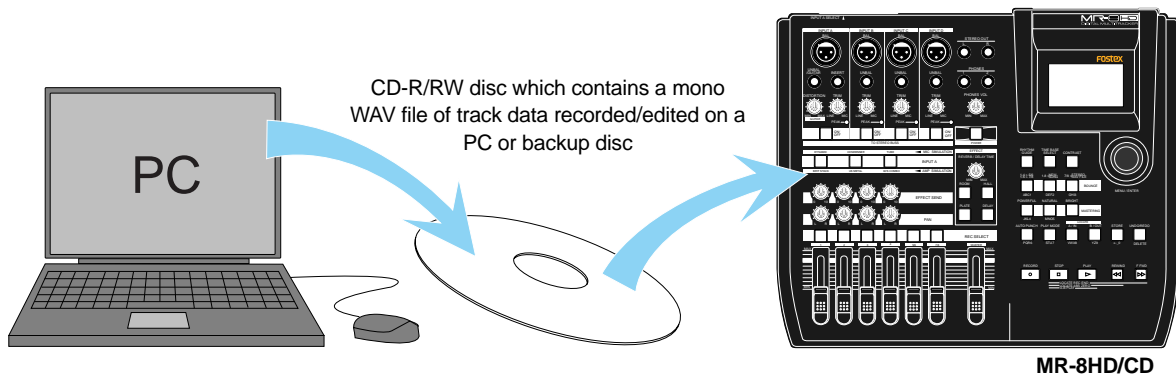

**<Note>**: When you copy a mono WAV file of track data recorded/edited on a PC to a CD-R/RW disc and then import it to the MR-8HD/CD, give the file name as below.

"{Song name}\_{Track number}"  
(Example: "My Song\_1", "My Song\_2" .... "My Song\_8")

By giving the file name as above, a file is automatically imported to the corresponding track of the destination song ("My Song\_1" to track 1, "My Song\_2" to track 2, etc.).

Note that when you import data of a backup disc created by the procedure described in "Exporting song data to a CD-R/RW" above, a file is copied to the same track from which data has been exported.

**<Note>**: If you import a WAV file to a recorded song, the imported file overwrites the existing track data. Note that if the time length of the imported file is shorter than the length of the existing track data, the imported file only overwrites the overlapping part. The rest part of the original data still remains. Also note that you cannot undo the import operation. If you do not satisfy with the result, press the [UNDO/REDO] key to undo the import operation. The unit returns to the condition before importing a track.

- 1) While the unit is stopped, press the [MENU/ENTER] knob to enter the MENU mode. The display now shows the first page of the menu selection screen.

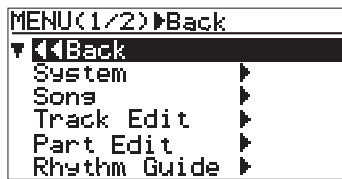

- 2) Use the [MENU/ENTER] knob to select "CD-RW" on the second page and press the [MENU/ENTER] knob. The display now shows the CD-RW menu screen.

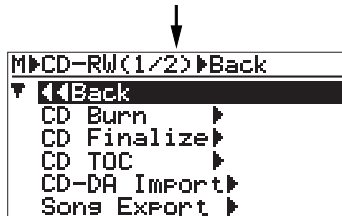
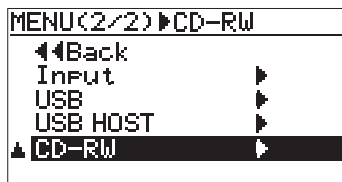

- 3) Use the [MENU/ENTER] knob to select "Song Import" on the second page and press the [MENU/ENTER] knob. The display now shows the screen for selecting the folder on the CD-R/RW disc.

The folders you can import a mono WAV file from are limited to the root folder and subfolder in the next level.

The following screen example shows the root folder (<Root>) and four subfolders (Folder1 through Folder4).

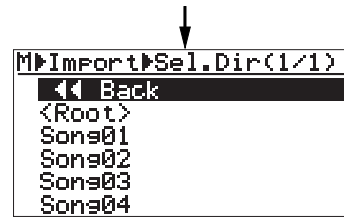
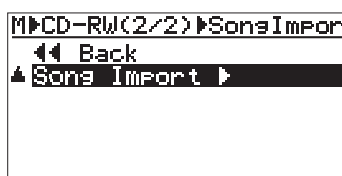

- 4) Use the [MENU/ENTER] knob to select a folder from which you import a mono WAV file and press the [MENU/ENTER] knob.

The display now shows the screen as below. You can see the name of the file to be imported to each track.

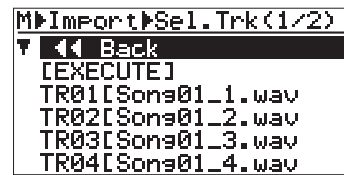

**<Note>**: If there are files for all tracks (1 through 8) in the screen example above, you can see the screen as below by scrolling down the list.



If no appropriate file to be imported exists for a track in the folder, "-----" is shown instead of a file name.

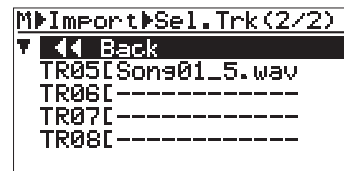

The screen example below shows that there are no files for tracks 6, 7 and 8, or there are mono WAV files but file names do not conform to the specified format. In other words, The names of tracks 6, 7 and 8 do not conform to the "{Song name}\_{Track number}" format.

In such a case, you can manually set files for tracks 6, 7 and 8 by following the procedure shown on the next page. To continue file import operation in the above condition, go to the next step (5).

- 5) Use the [MENU/ENTER] knob to select "[EXECUTE]" and press the [MENU/ENTER] knob.

The display now shows the confirmation screen for import, where "[NO]" is highlighted.

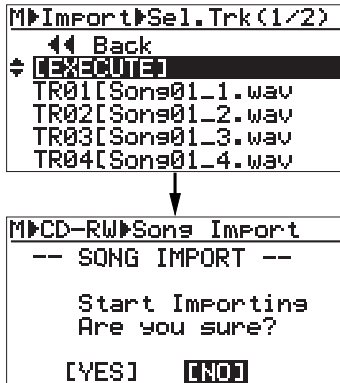

To start importing files, select "[YES]".  
To cancel importing files, select "[NO]".

- 6) Use the [MENU/ENTER] knob to select "[YES]" and press the [MENU/ENTER] knob.

The unit starts importing files. When importing is completed, "Completed!" is shown and the disc access stops.

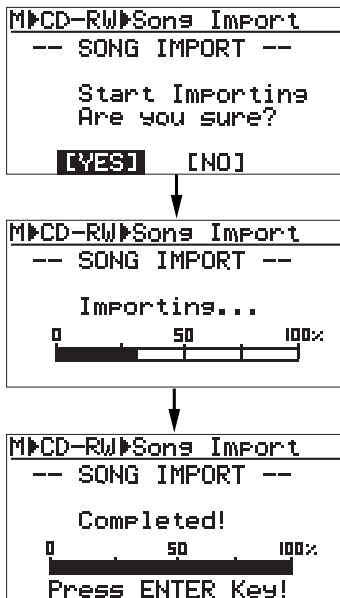

- 7) Press the [MENU/ENTER] knob.  
The display now shows the CD-RW menu screen where "Song Import ►" is highlighted.
- 8) Press the [STOP] key to exit the MENU mode.

You can also exit the MENU mode by selecting "<<Back" and pressing the [MENU/ENTER] knob repeatedly.

**<Hint>:** As mentioned in <Note> on page 20, if a file to be imported exists in the folder but does not have a proper file name which conforms to the specified format, it is not automatically set as an imported file. In such a case, you can manually set the file by following the procedure below.

### <How to select a file manually>

The following procedure shows how to set a file to be imported to "TR06". To set a file to "TR07" or "TR08", follow the similar procedure.

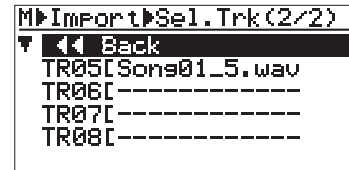

- 1) Use the [MENU/ENTER] knob to select "TR06" and press the [MENU/ENTER] knob.

The display now shows the screen for selecting a file to be imported. On the right of "<<Back", the selected track is shown ("TR06", in this example).

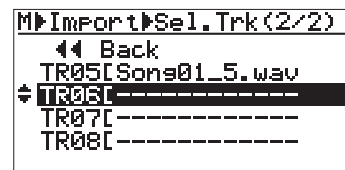

On the second page of the screen, files with no track number in their names are shown.

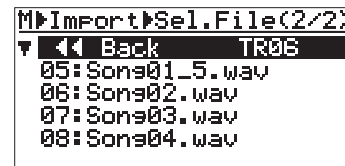

- 2) Use the [MENU/ENTER] knob to select the desired file and press the [MENU/ENTER] knob.

The selected file is set to "TR06" and the display returns to show the screen for selecting a file to be imported (in the screen example below, Song02.wav is set to "TR06").

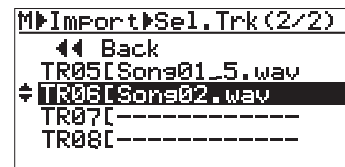

**<Hint>:** Using the method above, you can replace the currently selected WAV file with another file. If you want to delete the currently selected WAV file, press the [MENU/ENTER] knob after selecting the desired track, and after confirming that "[DELETE]" is highlighted on the screen above, press the [MENU/ENTER] knob again.

## Creating an audio CD using an external CD-R/RW drive

You can create an audio CD using an external CD-R/RW drive. Connect an external CD-R/RW drive to the [USB HOST] port on the rear panel of the MR-8HD/CD using a USB cable as show below (a USB cable is not supplied with the MR-8HD/CD).

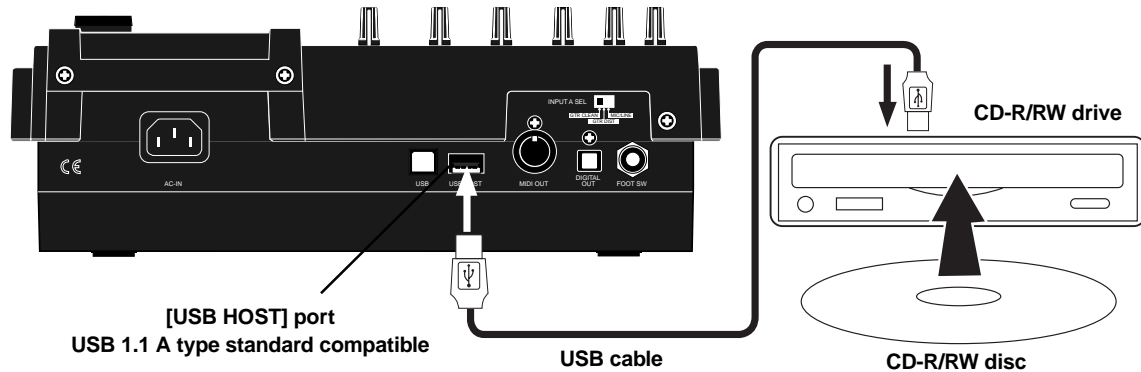

### **Important! CD-R/RW drives which can be connected to the MR-8HD/CD**

You can connect the MR-8HD/CD [USB HOST] port to any CD-R/RW drive which has a [USB] port and can be powered by AC main or batteries. The MR-8HD/CD does not provide USB bus power facility (which allows supplying power to an external device from the unit), therefore, you cannot connect a CD-R/RW drive which only can be powered by USB connection.

Also note that the models which can be used with the MR-8HD/CD may change. Check the update information of the currently available CD-R/RW drives from Fostex website (<http://www.fostex.com>) before purchasing a drive unit.

### **About "Track at once" and "Disk at once"**

The MR-8HD/CD provides two burning modes for creating an audio CD in the CD-DA format.

#### **"Track at once"**

The unit burns a stereo WAV file to a CD-R/RW disc as a track. You can burn an additional track at a later time until the disc is finalized. Each time you burn a file, a TOC is created. Approximately two-second silence is automatically inserted between tracks.

#### **"Disk at once"**

The unit burns a stereo WAV file and automatically finalizes the disc. You cannot burn an additional data. As described earlier in "2 MIX file playback mode", when one or more CUE points are set to the stereo WAV file, file data is divided into tracks at the CUE points. In this mode, no mute space is created between tracks. (Note that if the stereo WAV file does not have any CUE point, it is burned as a single track.)

In the procedure described below, it is assumed that the following preparations are made.

- Both the MR-8HD/CD and the CD-R/RW drive are powered, while a CD-R/RW disc is set to the CD-R/RW drive .
- The song which has the stereo WAV file to be burned is loaded.

- 1) Connect the MR-8HD/CD to the CD-R/RW drive using a USB cable.
- 2) While the MR-8HD/CD is stopped, press the [MENU/ENTER] knob to enter the MENU mode. The display now shows the first page of the menu selection screen.

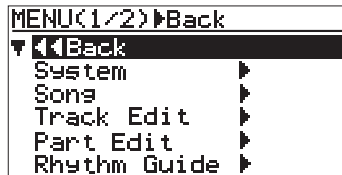

- 3) Use the [MENU/ENTER] knob to select "USB HOST ▶" on the second page and press the [MENU/ENTER] knob. The display now shows the USB HOST menu screen.

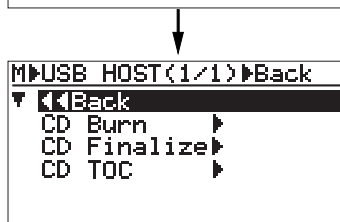
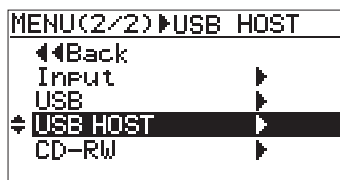

- 4) Use the [MENU/ENTER] knob to select "CD Burn ▶" and press the [MENU/ENTER] knob. The display now shows the Burning mode selection screen.

You can select between "Track at once" and "Disk at once" (see the previous page).

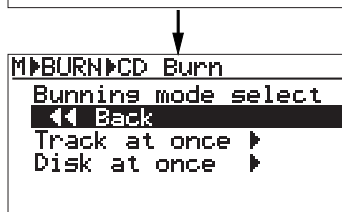
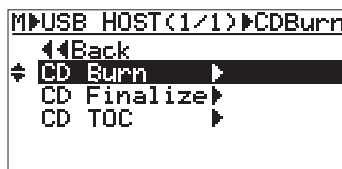

**<Note>:** If "Not Mounted" is shown when you select "USB HOST▶" using the [MENU/ENTER] knob in step 3) above, an external CD-R/RW drive is not connected to the MR-8HD/CD correctly.

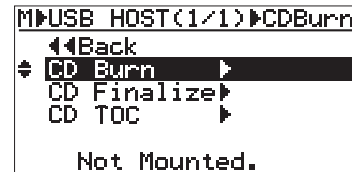

If you press the [MENU/ENTER] knob in the above condition, the following message pops up.

```

Warning:
Not Mounted!
  
```

In such a case, check the USB cable connection while the MR-8HD/CD stops accessing to the HDD drive or CD-R/RW drive. Then confirming that the display does not show "Not Mounted", press the [MENU/ENTER] knob.

- 5) Use the [MENU/ENTER] knob to select the desired burning mode and press the [MENU/ENTER] knob.

The display now shows the screen for selecting a stereo WAV file in the "2 MIX folder" of the current song. In the screen example below, only one stereo WAV file is stored.

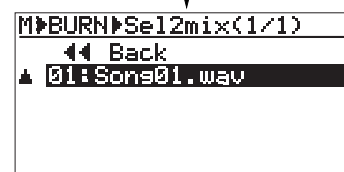
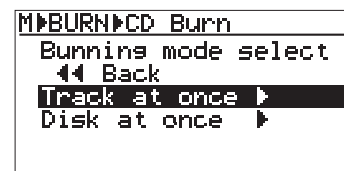

**<Note>:** When more than one stereo WAV file is stored in the "2 MIX folder" (as shown in the example below), you can use the [MENU/ENTER] knob to select a desired file for "CD Burn" (The maximum number of displayed files in the list is ten).

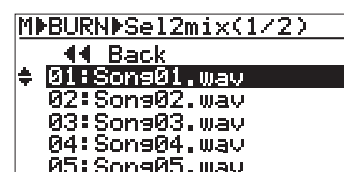

- 6) Use the [MENU/ENTER] knob to select the desired WAV file and press the [MENU/ENTER] knob.

The unit starts writing the file to the CD-R/RW disc. Depending on the selected burning mode, either of the following screens is shown.

While the unit is writing data to the disc, "Writing..." is popped up and "ACC" is flashing on the screen.

Also the ACCESS indicator of the CD-R/RW drive is flashing. Do not turn off the power or press the eject switch of the drive while writing.

While writing data to the disc, any operational keys of the MR-8HD/CD are disabled.

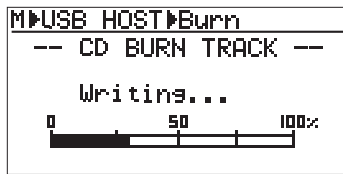

Now writing in the Track at once mode



Now writing in the Disk at once mode

**<Note>**: If the selected stereo WAV file is larger than the available disc space of the current CD-R/RW disc, the following message pops up and you cannot start writing (you can dismiss the message by pressing the [MENU/ENTER] knob). Change the disc to another one with enough space and carry out the same operation procedure.

Not Enough Remain  
Press ENTER Key

When writing is completed, "Completed!" is shown and the disc access stops.



Now writing in the Track at once mode is completed



Now writing in the Disk at once mode is completed

- 7) Press the [MENU/ENTER] knob. The display returns to the USB HOST menu screen, where "CD Burn ▶" is highlighted.

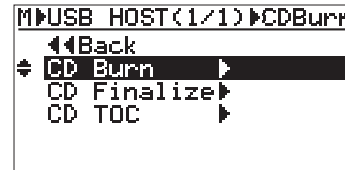

When the disc is burned in the "Disk at once" mode, it is automatically finalized after writing is completed, and then ejected.

You can check the TOC information if desired. See "Viewing the TOC information after finalizing" on page 27 for details.

When the disc is burned in the "Track at once" mode, go to step 8 for finalizing the disc.

If you want to write more than one stereo WAV file, repeat steps 4 through 6 above, and go to step 8 for finalizing after writing all the desired stereo WAV files.

You can check the TOC information any time (both before and after finalizing). It is recommended to check the remaining time (the recordable time left) from the TOC information whenever you write an additional stereo WAV file (see "Viewing the TOC information" on page 26 for details).

- 8) Use the [MENU/ENTER] knob to select "CD Finalize ▶" and press the [MENU/ENTER] knob.

The display now shows the confirmation screen for finalizing, where "[CANCEL]" is highlighted.

To cancel finalizing, highlight "[CANCEL]" and press the [MENU/ENTER] knob.

To start finalizing, highlight "[EXECUTE]" and press the [MENU/ENTER] knob.

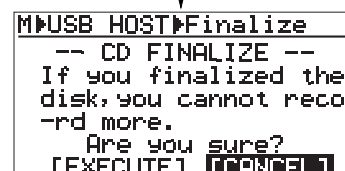
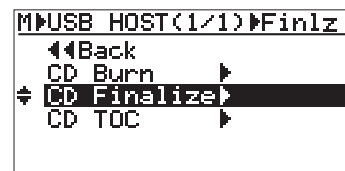



- 9) Use the [MENU/ENTER] knob to select "[EXECUTE]" and press the [MENU/ENTER] knob.

The display now shows the status of finalizing. When finalizing is completed, "Completed" is shown and the disc is automatically ejected from the CD-R/RW drive.

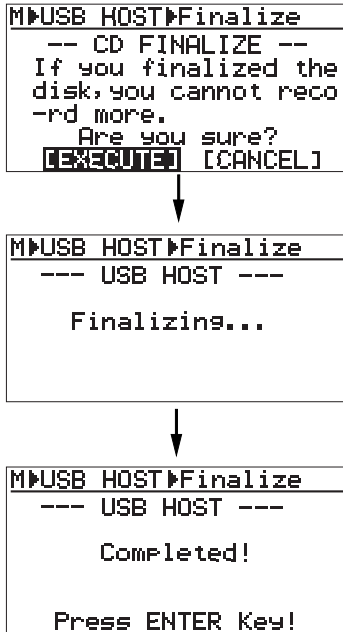

**<Note>**: Once you finalize a disc written in the "Track at once" mode, you cannot make additional writing any more. If you reload the finalized disc and attempt to write a file, "Already Finalized" is popped up and operation is cancelled.

- 10) Press the [MENU/ENTER] knob. The display returns to the USB HOST menu screen, where "CD Finalize ▶" is highlighted.

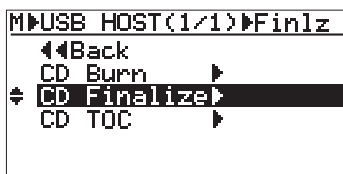

You can check the TOC information after finalized. See "Viewing the TOC information after finalizing" for on page 27 details.

- 11) Press the [STOP] key to exit the MENU mode.

You can also exit the MENU mode by selecting "◀◀Back" and pressing the [MENU/ENTER] knob repeatedly.

The following shows how audio CD data is written to a CD-R/RW disc in the "Track at once" or "Disk at once" mode.

- Writing a single stereo WAV file in the "Track at once" mode:



- Writing four stereo WAV files in the "Track at once" mode:

A two-second silence is automatically inserted between tracks.

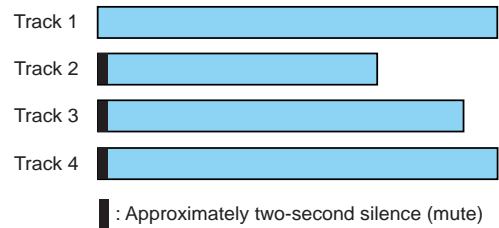

- Writing a single stereo WAV file with only CUE01 in the "Disk at once" mode:



- Writing a single stereo WAV file with three CUE points in addition to CUE01 in the "Disk at once" mode:

The file is divided into four tracks with no silence between tracks.



## Viewing the TOC information

You can view the TOC information of a burned disc both before finalizing and after finalizing (for a disc burned by "Disk at once", you can view the TOC only after finalizing, of course). It is recommended to check the remaining time (the recordable time left) from the TOC information whenever you write an additional stereo WAV file in the "Track at once" mode.

**<TOC>**: TOC stands for Table of Contents. TOC lists number of CD tracks, their starting locations, playing time of each track on the disc, etc.

### Viewing the TOC information before finalizing (only for a disc burned by "Track at once")

The following assumes that a disc contains a track burned by "Track at once" and has not yet been finalized, while "CD Burn ▶" is highlighted on the USB HOST screen.

- 1) Use the [MENU/ENTER] knob to select "CD TOC ▶" and press the [MENU/ENTER] knob. The display shows "Please Wait...", followed by the track number and playing time, as well as the disc remaining time.

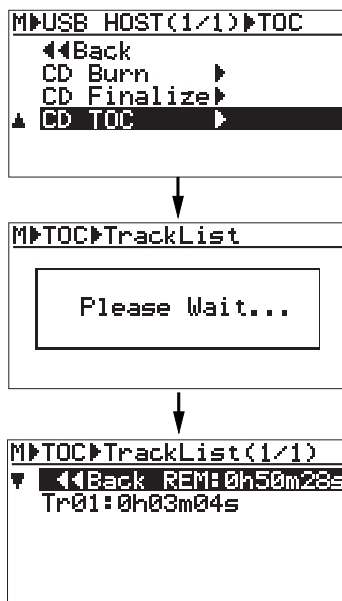

- 2) After viewing TOC, use the [MENU/ENTER] knob to select "◀ Back" and press the [MENU/ENTER] knob. The display returns to the screen where "CD TOC ▶" is highlighted.

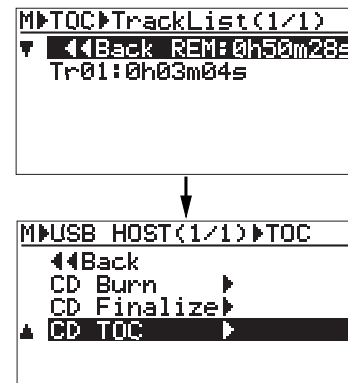

To burn an additional track by "Track at once" after viewing the TOC information, select "CD Burn ▶" and press the [MENU/ENTER] knob, then select a desired stereo WAV file, as described earlier (see page 24).

To finalize the disc after viewing the TOC information, select "CD Finalize ▶" and press the [MENU/ENTER] knob (see page 24).

**<Note>**: The following shows the screen example when you burn multiple WAV files by "Track at once". You can check the playing time of each track as well as the disc remaining time.

```

M>TOC>TrackList(1/1)
▼ <<Back REM:0h30m28s
Tr01:0h03m04s
Tr02:0h03m16s
Tr03:0h02m36s
Tr04:0h05m38s

```

## Viewing the TOC information after finalizing

The following assumes that a disc automatically finalized after "Disk at once" writing or a disc finalized after "Track at once" writing is ejected from an external CD-R/RW drive, while the display shows the CD-RW menu screen where "CD Finalize ▶" is highlighted.

- 1) **Close the ejected disc tray of the CD-R/RW drive.**

Push the front of the disc tray gently by hand.  
The finalized disc is loaded.  
Confirm that the "CD Finalize ▶" is highlighted on the screen.

```

M▶USB HOST(1/1)▶Finlz
  ◀◀Back
  CD Burn ▶
  ◀◀CD Finalize▶
  CD TOC ▶
  
```

**<Note>:** When you close the tray, the drive starts reading the disc and the access indicator starts flashing. Therefore, do not carry out the next operation until the drive stops accessing and the access indicator gets unlit.

- 2) **Use the [MENU/ENTER] knob to select "CD TOC ▶" and press the [MENU/ENTER] knob.**  
The display shows "Please Wait...", followed by the TOC information, as with "Viewing the TOC information before finalizing".

However, in this case, the remaining time is shown as "0h 00m 00s", which means no more tracks can be recorded to this finalized disc.

```

M▶USB HOST(1/1)▶TOC
  ◀◀Back
  CD Burn ▶
  CD Finalize▶
  ▲ CD TOC ▶
  
```

↓

```

M▶TOC▶TrackList
  Please Wait...
  
```

↓

```

M▶TOC▶TrackList(1/1)
  ◀◀Back REM:0h00m00s
  Tr01:0h03m04s
  
```

- 3) **After checking the TOC information, use the [STOP] key to exit the MENU mode.**

The display returns to the Home screen.

**<Note>:** When you burn multiple stereo WAV files by "Track at once" and finalized or you burn a stereo WAV file with multiple CUE points by "Disk at once", the Track list screen looks like the one below (the remaining time is shown as "0h 00m 00s", of course).

```

M▶TOC▶TrackList(1/1)
  ◀◀Back REM:0h00m00s
  Tr01:0h03m04s
  Tr02:0h03m16s
  Tr03:0h02m36s
  Tr04:0h05m38s
  
```

**<Note>:** You can also view the TOC of a commercially available audio CD, as with an audio CD you create using the MR-8HD/CD. (Note that some commercially available audio CDs may not show the TOC information.)

To do this, set an audio CD to the CD-R/RW drive and carry out the same operation as described above using the "USB HOST" menu in the MENU mode.

Note that you can view only the playing time of each track. You cannot view track titles.

**Fostex**<sup>®</sup>

**FOSTEX CO.**

3-2-35 Musashino, Akishima-shi, Tokyo, Japan 196-0021

**FOSTEX AMERICA**

13701 Cimarron Avenue, Gardena, CA 90249 U.S.A.