



Model No. FMPW11.0/FMRPM11.0

QUESTIONS?

If you have questions, or if parts are damaged or missing, please see HOW TO CONTACT CUSTOMER CARE on the back cover of this manual.

USER'S MANUAL

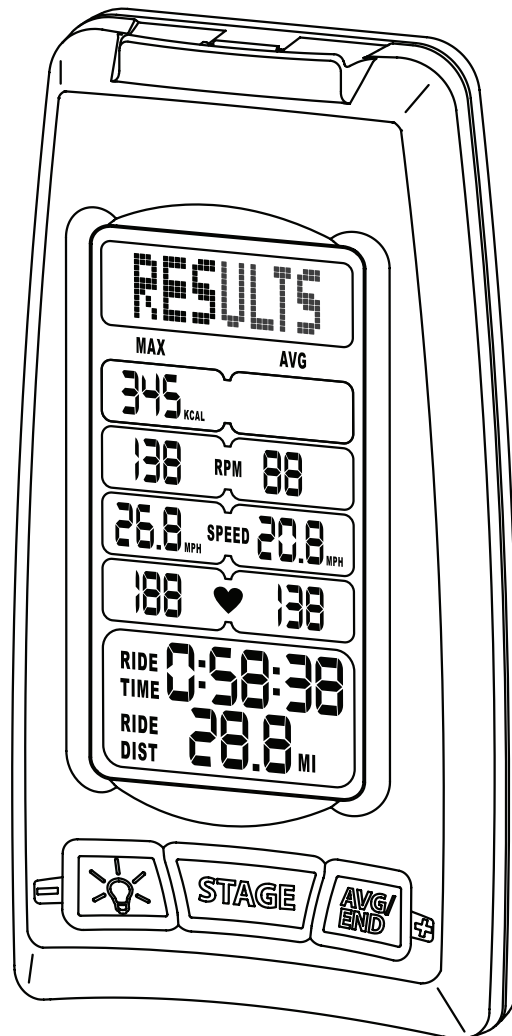

CAUTION

Read all precautions and instructions in this manual before using this equipment. Keep this manual for future reference.

TABLE OF CONTENTS

COMPLIANCE INFORMATION.....	2
IMPORTANT PRECAUTIONS.....	3
CONSOLE FEATURES.....	4
SPECIFICATIONS.....	4
CONSOLE DIAGRAM.....	5
POWER SENSOR DIAGRAM.....	6
DISPLAY DIAGRAM.....	7
DISPLAY DEFINITIONS.....	8
HOW TO USE THE CONSOLE.....	11
HOW TO LINK ANT+ COMPATIBLE DEVICES.....	18
HOW TO CONFIGURE THE CONSOLE.....	20
MAINTENANCE.....	28
TROUBLESHOOTING.....	29
HOW TO CONTACT CUSTOMER CARE.....	Back Cover

COMPLIANCE INFORMATION

This Class B digital apparatus complies with Canadian ICES-003.

This device complies with Part 15 of the FCC Rules. Operation is subject to the following two conditions: (1) this device may not cause harmful interference, and (2) this device must accept any interference received, including interference that may cause undesired operation.

Note: This equipment has been tested and found to comply with the limits for a Class B digital device, pursuant to Part 15 of the FCC Rules. These limits are designed to provide reasonable protection against harmful interference in a residential installation. This equipment generates, uses, and can radiate radio frequency energy and, if not installed and used in accordance with the instructions, may cause harmful interference to radio communications. However, there is no guarantee that interference will not occur in a particular installation. If this equipment does cause harmful interference to radio or television reception, which can be determined by turning the equipment off and on, try to correct the interference by one of the following measures:

- Reorient or relocate the receiving antenna.
- Increase the separation between the equipment and the receiver.
- Consult the dealer or an experienced radio/TV technician for help.

FCC/IC CAUTIONS: To assure continued compliance, use only shielded interface cables when connecting to computer or peripheral devices. Changes or modifications not expressly approved by the party responsible for compliance could void the user's authority to operate this equipment.

The console and the sensor are sensitive devices; the RF link between the console and the sensor may be disturbed by strong electromagnetic interference such as electro-static discharge. If this happens, please press the AVG/END button, and then press the STAGE button to relink the sensor.

IMPORTANT PRECAUTIONS

⚠ WARNING: To reduce the risk of serious injury, read all important precautions and instructions in this manual and all warnings on your console before using your console. FreeMotion Fitness assumes no responsibility for personal injury or property damage sustained by or through the use of this product.

1. Before beginning any exercise program, consult your physician. This is especially important for persons over age 35 or persons with pre-existing health problems.
2. If you have an implanted medical device, such as a pacemaker, consult your physician before using a heart rate monitor.
3. If you are taking medication regularly, consult your physician to find out if the medication will affect your exercise heart rate.
4. Use the console only as described in this manual.
5. It is the responsibility of the owner to ensure that all users of the console are adequately informed of all precautions.
6. Keep the console indoors, away from moisture and dust. Do not put the console in a garage or covered patio, or near water.
7. Inspect and properly tighten all parts regularly. Replace any worn parts immediately.
8. Keep children under age 12 and pets away from the console at all times.
9. To avoid damage to the console, keep liquids away from the console and keep the console out of direct sunlight.
10. Clean the console with a soft, damp cloth only. Do not use abrasives or solvents to clean the console.
11. When storing the console and/or the sensor, remove the batteries. Store the console and/or the sensor in a clean, dry location away from moisture and dust.
12. Over exercising may result in serious injury or death. If you feel faint or if you experience pain while exercising, stop immediately and cool down.

CONSOLE FEATURES

OVERMOLDED CONSOLE COVER

To prevent moisture from entering the console, the entire upper surface of the console, including the buttons, is overmolded in a thin rubber membrane. This surface can be easily cleaned with a soft, damp, non-abrasive cloth.

BACKLIT LCD DISPLAY

The console has an LCD display that features a backlight, fixed displays that provide ride data, and an active dot matrix message banner. During a ride, the message banner displays useful text messages relating to the other ride data. The message banner also functions as a menu in the SETTINGS mode.

HEART RATE MONITOR COMPATIBLE

The console is compatible with popular heart rate monitor telemetric chest straps, including ANT+ Sport (2.4 GHz) models and Polar®-compatible 5kHz models. The console will link to the strongest heart rate monitor signal in a range of approximately 2 to 3 meters. Note: A heart rate monitor is not included with the console.

USB DATA STORAGE

The console has a USB port that can be used with commercially-available USB drives. The ride data for each STAGE and the total RESULTS can be saved to a USB drive in a .csv file format that will allow users to track and analyze their ride data. This file format is common to standard spreadsheet software programs and can also be uploaded to many training websites.

SPECIFICATIONS

CONSOLE

Dimensions

Height: 3.1 in. (80 mm)
Length: 6.9 in. (175 mm)
Width: 3.3 in. (85 mm)

Weight with Batteries

1 lb. (2.2 kg)

Batteries Required

Three (3) C batteries (LR14)

POWER SENSOR

Dimensions

Height: 1.7 in. (44 mm)
Length: 8.4 in. (214 mm)
Width: 1.7 in. (44.5 mm)

Weight with Batteries

2.2 lbs. (4.8 kg)

Batteries Required

Two (2) AA batteries (LR6)

RPM SENSOR

Dimensions

Height: 1.1 in. (29 mm)
Length: 1.3 in. (35 mm)
Width: 0.5 in. (11.7 mm)

Weight with Batteries

0.1 lb. (0.5 kg)

Batteries Required

One (1) CR2032 battery

CONSOLE DIAGRAM

FRONT

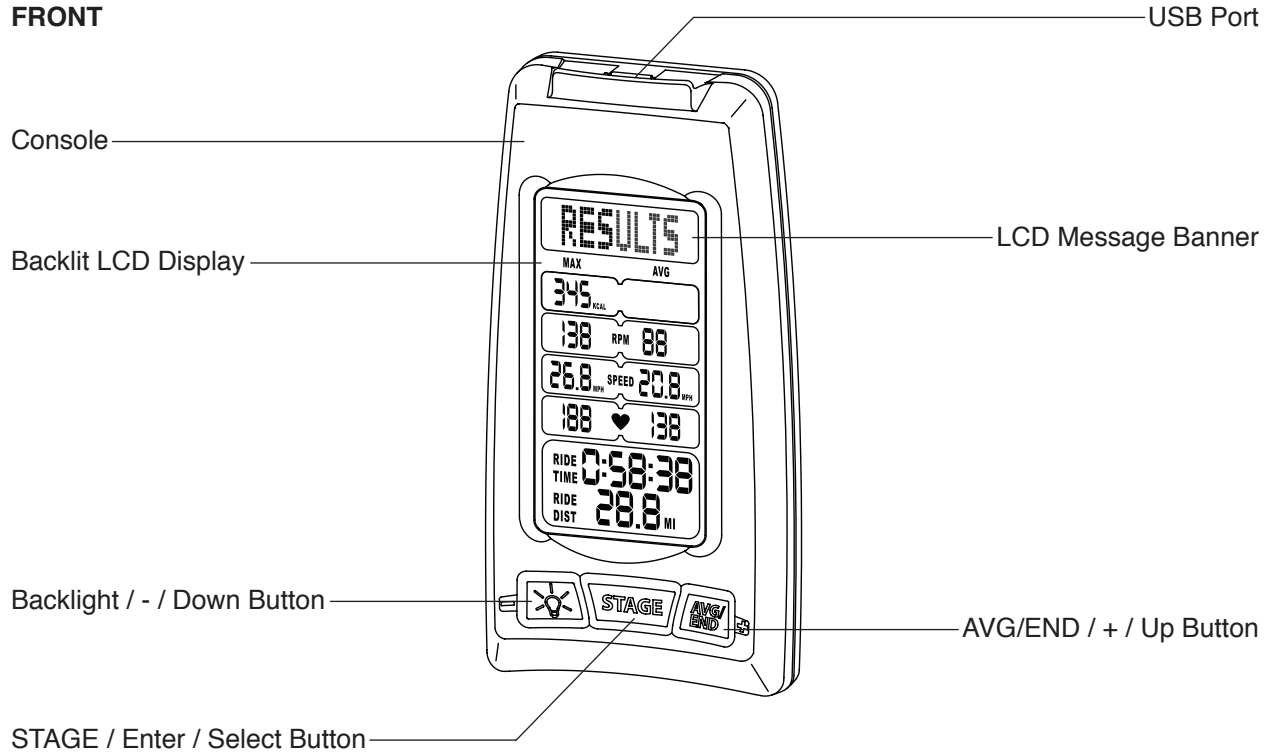

REAR

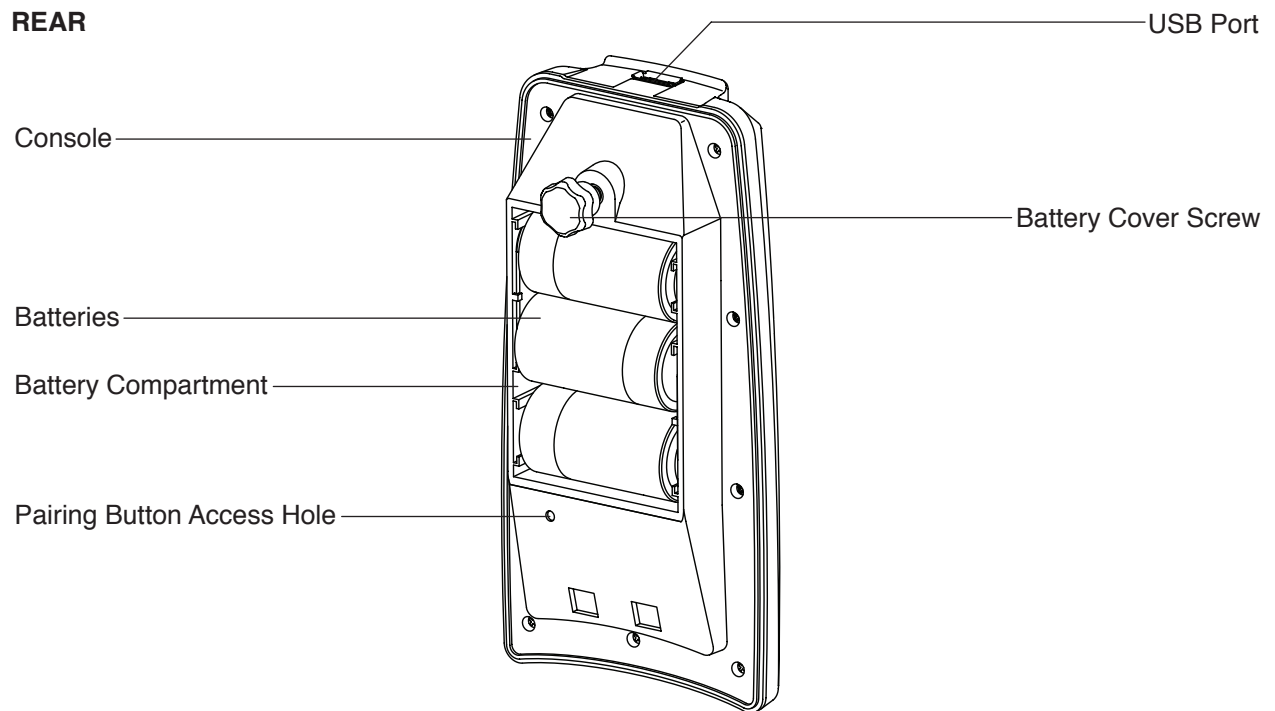

POWER SENSOR DIAGRAM

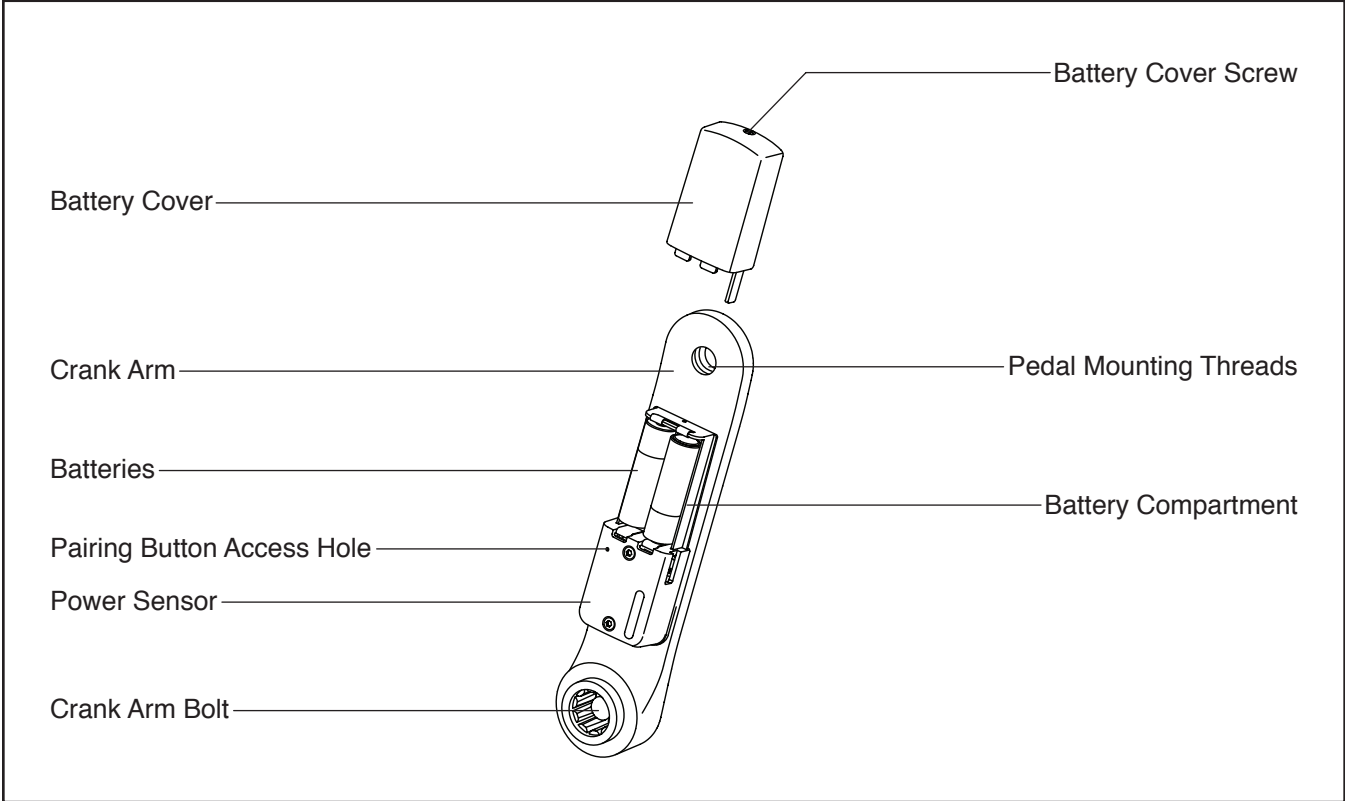

DISPLAY DIAGRAM

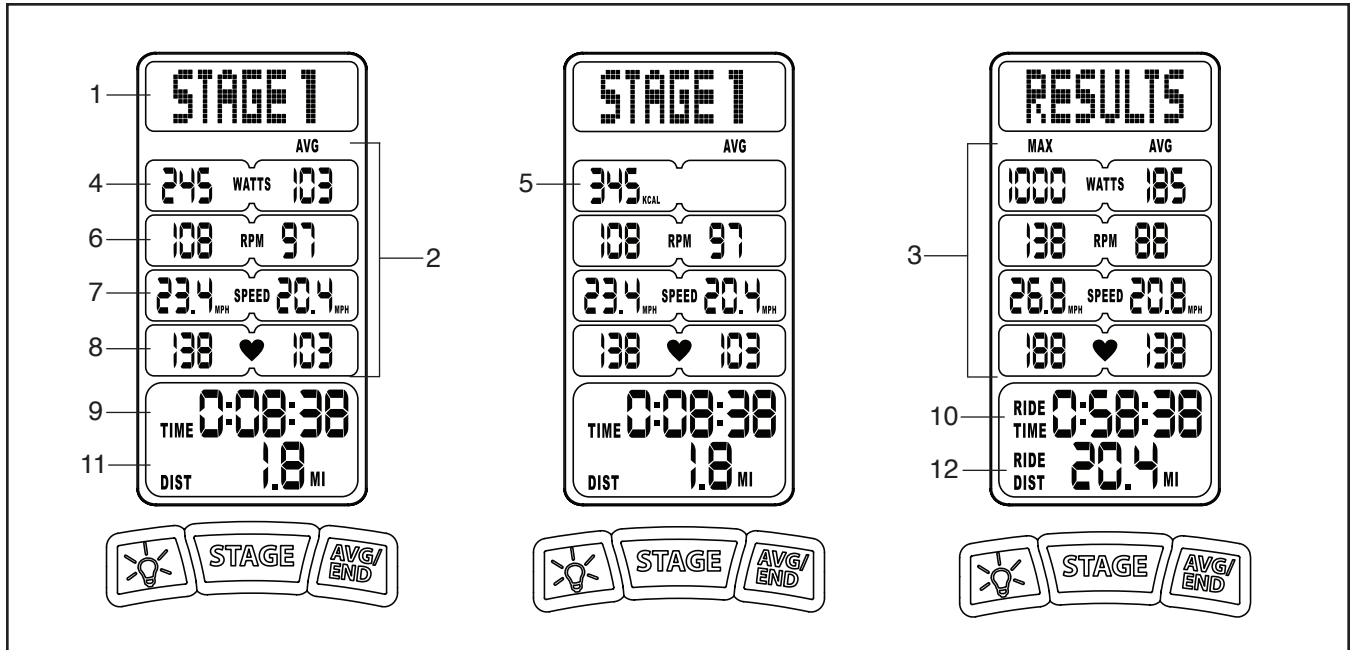

Number	Display	Description
1	Message Banner	Displays text messages indicating the current mode or menu option. Examples: WARM UP, STAGE #, RESULTS, RIDE.
2	AVG	Displays the average values for the current stage or the entire ride.
3	MAX	In the RESULTS mode and the RIDE mode, displays the maximum values.
4	WATTS*	Displays power output in watts—instantaneous, average, and maximum. *This display is only active on consoles that have the power sensor.
5	KCAL**	Displays the cumulative kilocalories (KCAL) value during the ride. **This display is only active on consoles that have the RPM sensor.
6	RPM	Displays pedaling cadence in revolutions per minute (RPM)—instantaneous, average, and maximum.
7	SPEED	Displays pedaling speed in miles per hour (MPH) or kilometers per hour (KMH)—instantaneous, average, and maximum.
8	Heart Rate (heart symbol)	If the user wears a compatible heart rate monitor (not included), displays the heart rate—instantaneous, average, and maximum.
9	TIME	Displays the elapsed time for the stage.
10	RIDE TIME	Displays the elapsed time for the entire ride.
11	DIST	Displays the distance traveled in miles (MI) or kilometers (KM) for the stage.
12	RIDE DIST	Displays the distance traveled in miles (MI) or kilometers (KM) for the entire ride.

DISPLAY DEFINITIONS

WARM UP

The console has a WARM UP mode designed to allow a user to adjust the exercise bike, to warm up, and to prepare for an actual ride. In a studio cycling class, users can use this mode to warm up before the class begins.

While the WARM UP mode is selected, the console will provide instantaneous data in the left displays for a user to reference. However, the console will not record the elapsed time, will not show average values, and will not save ride data to a USB drive.

To exit the WARM UP mode, a user will press the STAGE button to enter the STAGE mode and begin the ride.

STAGE

During the ride, the console will be in the STAGE mode.

The STAGE mode can have 1 to 99 numbered stages. To enter a new STAGE, a user will press the STAGE button. The message banner will show the STAGE number.

For each stage, the console will record the elapsed time and distance, will show instantaneous data in the left displays, and will show average values in the right displays.

Ride data for each STAGE will also be saved in the console memory for the RESULTS mode. If a user inserts a USB drive into the USB port before entering the STAGE mode, the ride data will also be saved to the USB drive in the RESULTS mode.

RIDE

During the ride, a user can press the AVG/END button to select the RIDE mode and view data for the entire ride.

While the RIDE mode is selected, the console will show the time and distance for the entire ride. The left displays will show the maximum values achieved for the ride so far and the right displays will show the average values for the ride so far.

WATTS

IMPORTANT: The console will measure watts if it is used with the power sensor. If the console is used with the RPM sensor, the console will not measure watts.

The console will measure and show a user's power output in WATTS. A watt is an instantaneous measurement of power and is a product of two factors: force and movement.

When a user rides an exercise bike, force equates to how hard the user pushes the pedals. Movement equates to the user's pedaling cadence—measured in revolutions per minute (RPM).

A watt is the international standard unit for power. However, power output is often expressed in horsepower as well. For reference, 746 watts is equal to 1 horsepower.

KJ (KILOJOULES)

IMPORTANT: The console will measure kilojoules if it is used with the power sensor. If the console is used with the RPM sensor, the console will not measure kilojoules.

The console will measure and show the amount of work a user has accomplished during a ride in kilojoules (KJ). The console will show the kilojoules value only in the RESULTS mode.

The kilojoules value is a direct measurement that can be converted into a food energy equivalent (kilocalories). However, the formula for this conversion makes assumptions about the mechanical efficiency of the human body.

A kilojoule is equal to 1000 joules. In turn, 1 joule is equal to 1 watt applied for 1 second.

KCAL (KILOCALORIES)

The console will measure and show the approximate amount of food energy used by a user's body in kilocalories (KCAL). Note: Kilocalories are also known as large calories or Calories. In nutritional contexts, kilocalories are known as Calories.

A kilocalorie is equal to 1000 small calories. Note: Small calories are also known as gram calories. Small calories are very small units and are not used in nutritional contexts.

If the console is used with the power sensor, the console will measure kilocalories as described below:

The console will use the following formula to convert the kilojoules value to the kilocalories value:

First, the kilojoules value is converted to the kilocalories equivalent (4.186 kilojoules = 1 kilocalorie). Then, this value is divided by the standard assumption of human mechanical efficiency (22 percent). The result is the approximate amount of food energy used.

If the console is used with the RPM sensor, the console will measure kilocalories as described below:

The console will show a kilocalories value using formulas and assumptions based on the user's weight and heart rate. The user's weight can be entered into the console in the User Setup mode. The user's heart rate will be provided when the user wears a compatible heart rate monitor (not included).

RPM (REVOLUTIONS PER MINUTE)

The console will measure and show the user's pedaling cadence in revolutions per minute (RPM).

A user's pedaling cadence is the number of times the user's foot travels a complete pedal stroke (360-degree circle or revolution) in one minute.

HEART RATE

If a user wears a compatible heart rate monitor (not included), the console will measure and show a user's heart rate in beats per minute.

When the console detects a signal from the user's heart rate monitor, the heart symbol in the display will flash and the user's heart rate will be shown.

SPEED

The console will measure and show the user's pedaling speed in miles per hour (MPH) or kilometers per hour (KMH). Note: The unit of measurement can be changed in the SETTINGS mode.

If the console is used with the power sensor, the console will measure speed as described below:

The console will calculate pedaling speed using a formula based on the amount of power required by an average-sized cyclist to increase pedaling speed while traveling on a flat surface in calm winds.

When a cyclist rides a road bike, the wind resistance the cyclist encounters increases exponentially. Thus, it requires more power output (watts) for a cyclist to increase pedaling speed from 20 miles per hour to 30 miles per hour than it does for a cyclist to increase pedaling speed from 10 miles per hour to 20 miles per hour.

The speed value calculated by the console is based directly on the amount of power produced by the user. This speed value is more realistic and consistent than the speed value produced by other consoles. Other consoles calculate a user's pedaling speed based simply on the rotational speed of the flywheel on the exercise bike.

If the console is used with the RPM sensor, the console will measure speed as described below:

The console will calculate a user's pedaling speed based on the rotational speed of the flywheel on the exercise bike.

DISTANCE

The console will measure and show the distance traveled in miles (MI) or kilometers (KM). Note: The unit of measurement can be changed in the SETTINGS mode.

If the console is used with the power sensor, the console will measure distance as described below:

The console will calculate the distance traveled based on the user's average speed for a given amount of time.

The speed value used to produce the distance value is based directly on the amount of power produced by the user (see SPEED at the left). Thus, the console will produce a realistic distance value that will allow the user to compare the distances traveled on rides of similar duration.

If the console is used with the RPM sensor, the console will measure speed as described below:

The console will calculate the distance traveled based on the user's pedaling speed, which is based on the rotational speed of the flywheel on the exercise bike.

HOW TO USE THE CONSOLE

To activate the console, see this page. To turn off the console, see this page. To use the backlight, see this page. To set up the console, see page 12. To use the WARM UP mode, see page 13. To use the STAGE mode, see page 14. To use the RIDE mode, see page 15. To use the Auto Pause mode, see page 16. To use the Auto Pause Off mode, see page 16. To use the RESULTS mode, see page 17.

HOW TO ACTIVATE THE CONSOLE

IMPORTANT: If the console has been exposed to cold temperatures, allow it to warm to room temperature before installing batteries and activating the console. If you do not do this, you may damage the console displays or other electrical components.

Press any button on the console to activate the console. The displays will then light and the console will be ready for use.

HOW TO TURN OFF THE CONSOLE

To conserve battery power, the console will automatically enter the Sleep Mode in the following conditions:

When the User Setup mode is selected—The console will enter the Sleep Mode after 45 seconds if the pedals do not move at a pedaling cadence of at least 10 RPM or if no buttons are pressed.

When the WARM UP mode or the Auto Pause mode is selected—The console will enter the Sleep Mode after 3 minutes if the pedals do not move at a pedaling cadence of at least 5 RPM.

When the RESULTS mode is selected—The console will enter the Sleep Mode after 3 minutes.

When the console is in the Sleep Mode, no data will be shown in the displays.

HOW TO USE THE BACKLIGHT

Press the Backlight button repeatedly to turn the backlight on. To change the backlight duration, see step 3 on page 23.

HOW TO SET UP THE CONSOLE

1. Activate the console.

See HOW TO ACTIVATE THE CONSOLE on page 11.

2. Select the User Setup mode.

When you activate the console, the User Setup mode will be selected automatically.

3. Insert a USB drive into the USB port if desired.

The display will prompt you to insert a USB drive into the USB port on the console. If you insert a USB drive into the USB port, your ride data will be saved to the USB drive in the RESULTS mode.

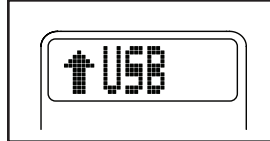

If the console detects a USB drive, a check mark will appear in the display.

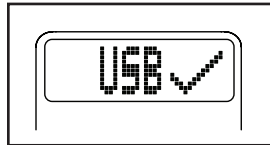

If the console does not detect a USB drive, a cross-out symbol will appear in the display.

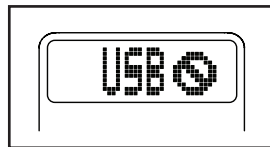

Note: If desired, you can disable the USB port. See step 3 on page 24.

4. Enter your weight if applicable.

If the console is used with the RPM sensor, the console will prompt you to enter your weight. Note: Your weight is used to calculate KCAL values.

Press the AVG/END or BACKLIGHT button to increase or decrease the weight value. Note: If you do not enter a weight value, the console will use the default weight value to calculate KCAL values.

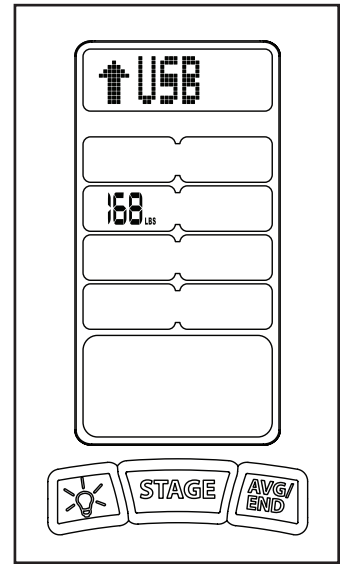

5. Exit the User Setup mode.

Press the STAGE button to exit the User Setup mode and enter the WARM UP mode.

The console will automatically exit the User Setup mode and enter the WARM UP mode in the following conditions:

The console will enter the WARM UP mode after 10 seconds if no buttons are pressed and the pedals move at a pedaling cadence greater than 15 RPM.

The console will enter the WARM UP mode immediately if the pedals move at a pedaling cadence greater than 60 RPM.

HOW TO USE THE WARM UP MODE

1. Activate the console.

See HOW TO ACTIVATE THE CONSOLE on page 11.

2. Set up the console if desired.

When you activate the console, the User Setup mode will be selected automatically. See steps 2 to 4 on page 12 to set up the console.

3. Select the WARM UP mode.

Press the STAGE button to exit the User Setup mode and enter the WARM UP mode.

The console will exit the User Setup mode and enter the WARM UP mode after 10 seconds if you do not press any buttons and your pedaling cadence is greater than 15 RPM.

The console will also exit the User Setup mode and enter the WARM UP mode immediately if your pedaling cadence is greater than 60 RPM.

When the WARM UP mode is selected, the words WARM UP will appear in the message banner.

The WARM UP mode is designed to allow you to adjust the exercise bike, to warm up, and to prepare for an actual ride. In a studio cycling class, you can use this mode to warm up before the class begins.

4. Follow your progress with the displays.

See the DISPLAY DIAGRAM on page 7.

When the WARM UP mode is selected, the console will show instantaneous data in the left displays. However, the console will not show the elapsed time, will not show average values, and will not save ride data to a USB drive.

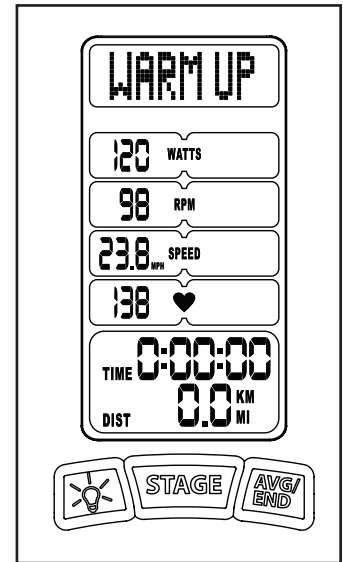

5. Exit the WARM UP mode.

To exit the WARM UP mode, press the STAGE button. The console will then enter the STAGE mode and begin the ride.

HOW TO USE THE STAGE MODE

1. Activate the console.

See HOW TO ACTIVATE THE CONSOLE on page 11.

2. Set up the console if desired.

When you activate the console, the User Setup mode will be selected automatically. See HOW TO SET UP THE CONSOLE on page 12.

3. Begin pedaling and warm up if desired.

When you press the STAGE button or begin pedaling, the console will enter the WARM UP mode. See HOW TO USE THE WARM UP MODE on page 13.

4. Select the STAGE mode.

To exit the WARM UP mode and enter the STAGE mode, press the STAGE button. The STAGE number will appear in the message banner.

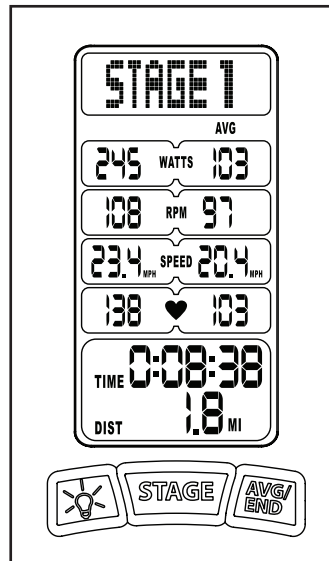

5. Divide your ride into stages if desired.

The STAGE mode can have 1 to 99 numbered stages. To enter a new STAGE, press the STAGE button. The message banner will show the current STAGE number.

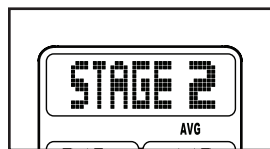

The STAGE mode is designed to allow you to divide your ride into specific elements that can be tracked and analyzed. For example, you can divide the high-intensity and low-intensity portions of an interval ride into separate stages. You can also save the data for each stage to a USB drive (see step 3 on page 12).

6. Follow your progress with the displays.

See the DISPLAY DIAGRAM on page 7.

During each stage, the console will show the elapsed time and distance. The left displays will show instantaneous data and the right displays will show average values.

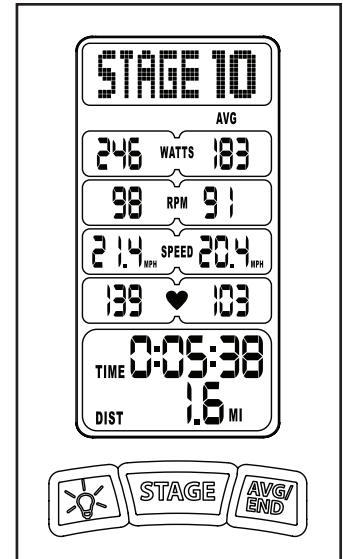

When you select a new stage, the console will reset the time, distance, and average values to zero.

7. Pause the console if desired.

See HOW TO USE THE AUTO PAUSE MODE on page 16.

8. View the RIDE mode if desired.

See HOW TO USE THE RIDE MODE on page 15.

9. End the ride.

To end the ride, press and hold the AVG/END button for 3 seconds. The console will then enter the RESULTS mode.

HOW TO USE THE RIDE MODE

1. Select the STAGE mode.

See steps 1 to 4 on page 14 and select the STAGE mode.

2. Select the RIDE mode.

To view the RIDE mode at any time during any stage, press the AVG/END button. The word RIDE will appear in the message banner.

3. View data for the entire ride.

When the RIDE mode is selected, the console will show data for the entire ride so far.

See the DISPLAY DIAGRAM on page 7.

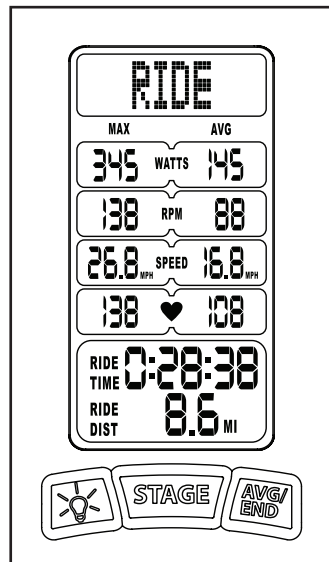

The time and distance displays will show the elapsed time for the entire ride and the distance for the entire ride. The left displays will show the maximum values achieved for the ride and the right displays will show the average values for the ride.

Note: When the RIDE mode is selected, you can still press the STAGE button to enter a new stage.

4. Exit the RIDE mode.

To exit the RIDE mode and view the current STAGE mode, press the AVG/END button.

The console will also exit the RIDE mode automatically after 6 seconds.

HOW TO USE THE AUTO PAUSE MODE

The console has an Auto Pause mode that allows you to stop your ride temporarily and then resume your ride without affecting the average value data shown and saved by the console.

The console will enter the Auto Pause mode when your pedaling cadence is less than 5 RPM for 3 or more seconds.

Note: The console will not enter the Auto Pause mode when the WARM UP mode is selected.

When the console enters the Auto Pause mode, a pause symbol will appear in the message banner. The time display will pause and the left displays will not show instantaneous data.

The console will exit the Auto Pause mode and return to the current stage if the console detects a pedaling cadence greater than 5 RPM during the first 3 minutes of the Auto Pause mode.

The console will exit the Auto Pause mode and enter the Sleep Mode if no pedaling cadence greater than 5 RPM is detected after 3 minutes.

Note: If desired, you can disable the Auto Pause mode. See HOW TO USE THE AUTO PAUSE OFF MODE at the right.

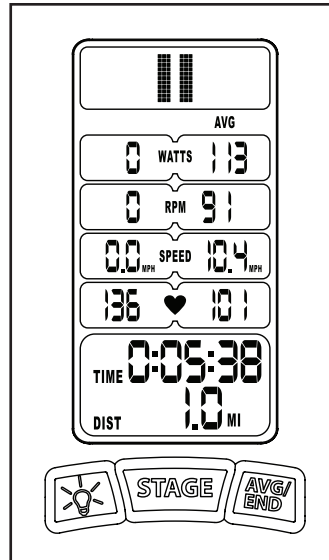

HOW TO USE THE AUTO PAUSE OFF MODE

The console has an Auto Pause Off mode designed to be used by studio cycling class instructors.

Since most studio cycling classes must be completed in a set period of time, instructors may not want the console to pause the time when they stop pedaling or get off their exercise bikes for short periods of time.

When the Auto Pause Off mode is selected, a pause symbol will appear in the message banner when the console detects a pedaling cadence of less than 5 RPM for 3 or more seconds; **however, the time display will not pause.**

The console will exit the Auto Pause Off mode and return to the current stage if the console detects a pedaling cadence greater than 5 RPM during the first 3 minutes of the Auto Pause Off mode.

The console will exit the Auto Pause Off mode and enter the Sleep Mode if no pedaling cadence greater than 5 RPM is detected after 5 minutes.

To disable or enable the Auto Pause mode, see step 2 on page 24.

HOW TO USE THE RESULTS MODE

1. Select the RESULTS mode.

To end a ride and select the RESULTS mode, press and hold the AVG/END button for 3 seconds (see steps 1 to 9 on page 14).

The word RESULTS will appear in the message banner.

2. View and save data for the ride.

When the RESULTS mode is selected, the console will show the data for the ride.

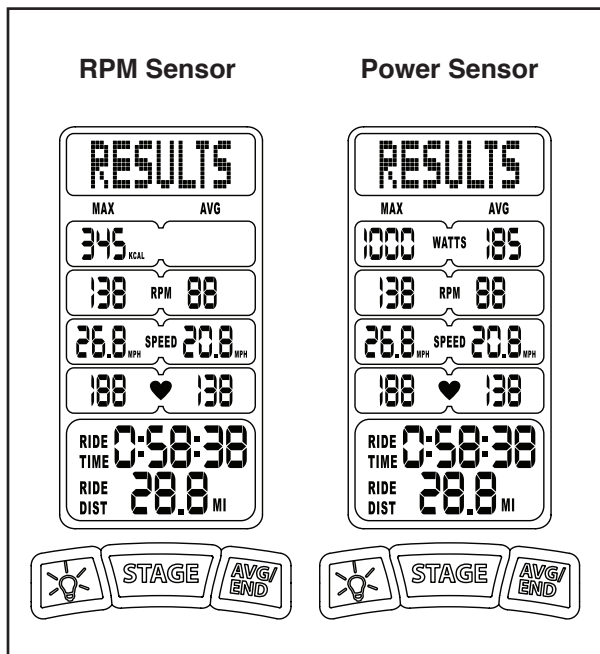

If there is a USB drive inserted into the USB port (see step 3 on page 12), the data for the ride will also be saved to the USB drive.

See the DISPLAY DIAGRAM on page 7.

The time and distance displays will show the time for the entire ride and the distance for the entire ride. The left displays will show the maximum values achieved for the ride and the right displays will show the average values for the ride.

If the console is used with the power sensor, the message banner will also show the KJ (kilojoules) and the KCAL (kilocalories) values in a repeating cycle.

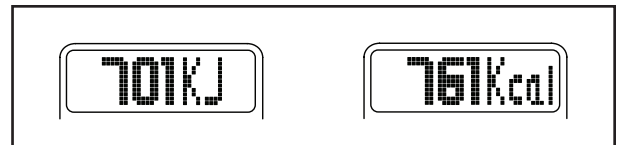

3. Turn off the console.

See HOW TO TURN OFF THE CONSOLE on page 11.

HOW TO LINK ANT+ COMPATIBLE DEVICES

THE ANT+ MODULE AND COMPATIBLE DEVICES

The console has a secure, digital ANT+ module that allows the console to communicate with ANT+ compatible heart rate monitors, fitness watches, and mobile devices.

There are many brands of ANT+ compatible heart rate monitor telemetric chest straps available. The symbol shown here indicates that a heart rate monitor is compatible with the ANT+ module in the console.

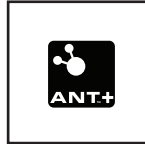

There are also many brands of ANT+ compatible fitness watches and mobile devices available. These devices can capture your ride data wirelessly, so you do not have to insert a USB drive into the USB port on the console to save your ride data. Many of these devices can also transfer your ride data wirelessly to training programs on computers, mobile devices, and websites.

The symbol shown here indicates that a fitness watch or mobile device is compatible with the ANT+ module in the console and can communicate wirelessly with other devices.



Before you can use the ANT+ module with a compatible device, you must link (pair) the device to the ANT+ module.

See HOW TO LINK A HEART RATE MONITOR at the right to link your ANT+ compatible heart rate monitor to the ANT+ module.

See HOW TO LINK A FITNESS WATCH OR MOBILE DEVICE on page 19 to link your ANT+ compatible fitness watch or mobile device to the ANT+ module.

HOW TO LINK A HEART RATE MONITOR

Follow the manufacturer's instructions to use your ANT+ compatible heart rate monitor.

1. **Put on the heart rate monitor and position yourself near the console.**

You must be within 12 inches (30 centimeters) of the console to link the heart rate monitor to the ANT+ module in the console.

2. **Activate the console and select the WARM UP mode.**

See HOW TO ACTIVATE THE CONSOLE on page 11. Then, press the STAGE button to enter the WARM UP mode.

Note: The console must be in the WARM UP mode to link to an ANT+ compatible heart rate monitor. The heart rate monitor cannot link to the ANT+ module when the console is in the STAGE mode.

3. **Link the heart rate monitor to the ANT+ module in the console.**

When the WARM UP mode is selected, the ANT+ module will link to the heart rate monitor.

The heart symbol will flash in the heart rate display and the console will show heart rate data.

Note: After the heart rate monitor is linked to the ANT+ module in the console, the ANT+ module will be able to receive heart rate signals within an area encompassing all the riding positions of the exercise bike.

HOW TO LINK A FITNESS WATCH OR MOBILE DEVICE

Follow the manufacturer's instructions to use your ANT+ compatible fitness watch or mobile device.

1. Make sure that your device is in linking mode and position the device near the console.

See the manufacturer's instructions for your fitness watch or mobile device to select the linking mode.

The fitness watch or mobile device must be within 6 inches (15 centimeters) of the console.

2. Activate the console and select the WARM UP mode.

See HOW TO ACTIVATE THE CONSOLE on page 11. Then, press the STAGE button to enter the WARM UP mode.

Note: The console must be in the WARM UP mode to link to an ANT+ compatible fitness watch or mobile device. The fitness watch or mobile device cannot link to the ANT+ module when the console is in the STAGE mode.

3. Link the fitness watch or mobile device to the ANT+ module in the console.

When the WARM UP mode is selected, the ANT+ module will link to the fitness watch or mobile device.

The fitness watch or mobile device will indicate a successful link to the ANT+ module in the console.

Note: After the fitness watch or mobile device is linked to the ANT+ module in the console, the ANT+ module will be able to receive signals within an area encompassing all the riding positions of the exercise bike.

HOW TO CONFIGURE THE CONSOLE

To select the settings mode, see this page. To pair the console, see page 21. To change display settings, see page 23. To change system settings, see page 24. To manage console firmware, see page 25. To use a bike number, see page 27.

HOW TO USE THE SETTINGS MODE

To select the SETTINGS mode, press and hold the Backlight and AVG/END buttons for 5 seconds. The settings menu will appear in the message banner.

To exit the SETTINGS mode, press the AVG/END button. The word BACK will appear in the message banner. Then, press the STAGE button. The console will exit the SETTINGS mode.

You can use the console buttons to navigate through the menus and change console settings.

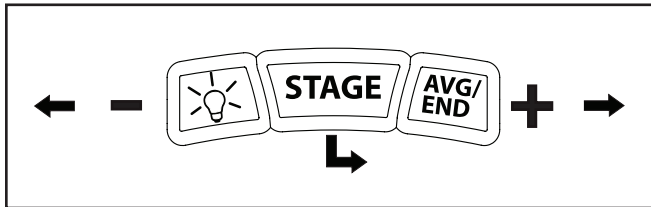

The menu options will appear in the message banner. Press the STAGE button to select a menu option or enter a setting. Press the Backlight button to move to the previous menu option. Press the AVG/END button to move to the next menu option.

The settings menu contains the following menu options:

PAIRING—Select this menu option to pair the console to a power sensor or an RPM sensor.

DISPLAY—Select this menu option to select a unit of measurement for the console, to change the backlight duration, and to change the contrast level of the displays.

SYSTEM—Select this menu option to enable or disable the Auto Pause mode, to enable or disable the USB port, to view information about console usage, and to manage the console firmware.

BIKE #—Select this menu option to assign an identification number to the console. Note: This will ensure that the console remains attached to the correct exercise bike and paired power or RPM sensor.

BACK—Select this menu option to exit the settings menu.

To exit a menu or to exit the SETTINGS mode, select the BACK menu option repeatedly.

HOW TO PAIR THE CONSOLE

IMPORTANT: The console must be paired to a power sensor or to an RPM sensor. The console cannot pair to more than one sensor at a time.

Pairing allows the console to communicate with a power sensor or an RPM sensor mounted to the exercise bike. The pairing process uses ANT+ digital wireless technology to link the console to the sensor.

The paired console and sensor will have a secure relationship; they will communicate only with each other and will not be influenced by other devices in the area.

It is strongly recommended that each exercise bike in a fitness club be numbered for easy identification. To communicate properly, a paired console and sensor must be mounted to the same exercise bike. To make sure that the correct console stays with the correct sensor and exercise bike, you can assign an identification number to the console (see HOW TO USE A BIKE NUMBER on page 27).

IMPORTANT: Only one console and one sensor should be paired at a time. During the pairing process, other consoles and sensors in the area must not be in use. This will ensure that the console pairs to the desired sensor without interference from other devices.

Tip: It is easier and more convenient to pair the console and the sensor before you mount the sensor to the exercise bike.

1. **Make sure that fresh batteries are installed in the console and the sensor.**

See HOW TO REPLACE BATTERIES on page 28.

2. **Locate the pairing button on the power sensor or the RPM sensor.**

Note the location of the pairing button or the pairing button access hole on the power sensor or the RPM sensor. This button will be used later in the pairing process.

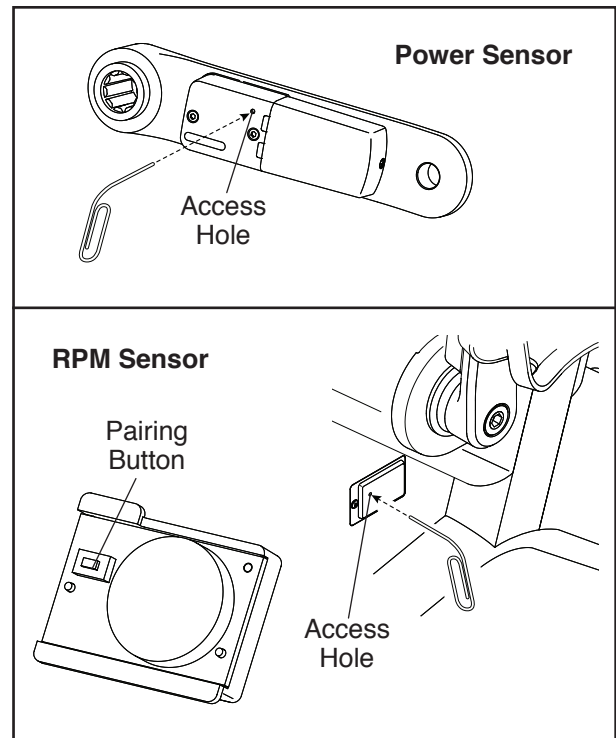

You will need a paper clip to press the pairing button on the power sensor. You will also need a paper clip to press the pairing button on the RPM sensor if the RPM sensor has been mounted to the exercise bike.

3. **Activate the console and select the PAIRING menu option.**

See HOW TO ACTIVATE THE CONSOLE on page 11.

Then, see HOW TO USE THE SETTINGS MODE on page 20.

The pairing menu will appear in the message banner.

4. Select the type of sensor to be paired.

Select the RPM SENSOR or the PWR (power) SENSOR menu option.

Make sure that the menu option you select matches the type of sensor that will be mounted on the exercise bike.

IMPORTANT: If you do not select the correct menu option for the type of sensor being used, the console will either fail to pair to the sensor or the console will show incorrect data in the displays.

5. Begin the pairing process.

Press the STAGE button on the console and press the pairing button on the sensor to begin the pairing process.

During the pairing process, the console will attempt to link to the designated sensor. The console will show a 30-second countdown.

During the 30-second countdown, press the pairing button on the sensor.

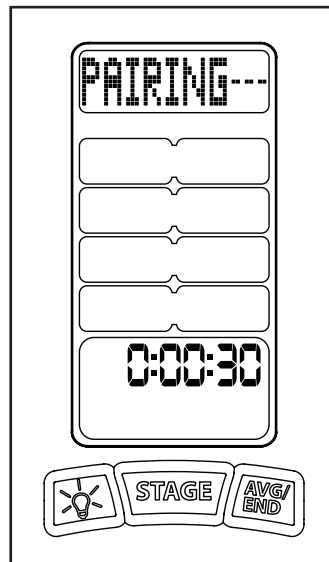

6. Complete the pairing process.

If the pairing process is successful, the word PAIRED will appear in the message banner.

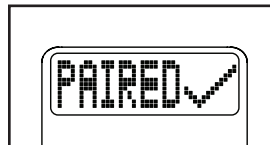

If the pairing process fails, the word FAILED will appear in the message banner. **Go to step 7.**

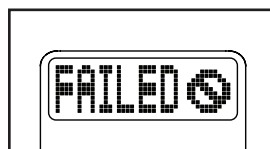

7. Troubleshoot the pairing process if necessary.

If the pairing process fails, follow these steps:

- Make sure that fresh batteries are installed in the sensor.
- Place the sensor next to the console, so that they are side by side.
- Make sure that no other ANT+ devices in the area are active. Pair only one console and one sensor at a time.
- See steps 3 to 6 starting on page 21 and repeat the pairing process.

8. Use the shortcut pairing process if desired.

This pairing process can be used when the console is not mounted to the exercise bike. You will need a paper clip to press the pairing button on the back of the console.

- Locate the pairing button access hole on the back of the console near the battery compartment.
- Using a paper clip, press the pairing button. The console will enter the PAIRING menu automatically.
- See steps 3 to 6 starting on page 21 and complete the pairing process.

9. Exit the pairing menu.

See HOW TO USE THE SETTINGS MODE on page 20.

HOW TO CHANGE DISPLAY SETTINGS

1. Activate the console and select the **DISPLAY** menu option.

See HOW TO ACTIVATE THE CONSOLE on page 11.

Then, see HOW TO USE THE SETTINGS MODE on page 20.

The display menu will appear in the message banner.

2. Select the **UNITS** menu option and change the unit of measurement if desired.

The console can display speed and distance in miles (ENGLISH) or kilometers (METRIC).

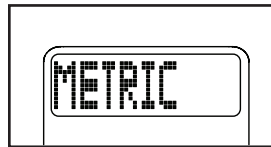

The currently selected unit of measurement will be displayed with a dark background.

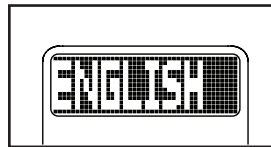

Select the desired ENGLISH or METRIC unit of measurement. Then, return to the display menu.

3. Select the **BACKLIGHT** menu option and change the backlight duration if desired.

You can change the amount of time the backlight will stay lit after you press the Backlight button.

The console has ON, OFF, and BK LT TIME (backlight time) backlight durations.

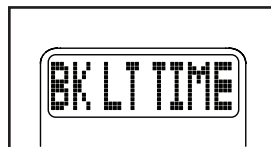

The currently selected backlight duration will be displayed with a dark background.



Note: The backlight duration you select will affect the battery life. To extend the battery life, it is recommended that you select a short backlight duration.

When the ON backlight duration is selected, the backlight will stay lit the entire time the console is activated. Note: This backlight duration is not recommended for high-use environments, such as fitness clubs.

When the OFF backlight duration is selected, the backlight will not light.

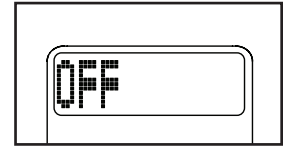

When you select the BK LT TIME menu option, you can select a backlight duration from the backlight time menu.

Note: The default backlight duration is 5 seconds.

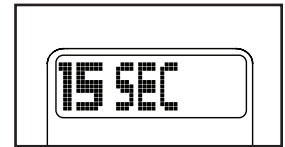

Select the desired backlight duration. Then, return to the display menu.

4. Select the **CONTRAST** menu option and change the contrast level of the LCD display if desired.

You can adjust the contrast level of the LCD display from 0 to 100 percent. Note: The default contrast level is 100 percent.

The currently selected contrast level will be shown in one of the right displays.

Tip: It is recommended that you adjust the console to a high contrast level in bright or mixed lighting conditions.

However, adjusting the console to a lower contrast level can improve battery life.

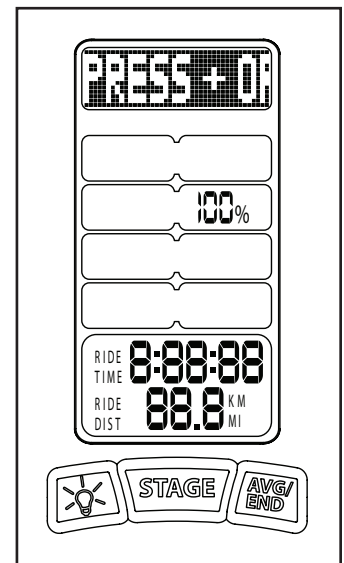

Press the AVG/END or Backlight button to increase or decrease the contrast level. Then, press the STAGE button to confirm your selection.

5. Exit the display menu.

See HOW TO USE THE SETTINGS MODE on page 20.

HOW TO CHANGE SYSTEM SETTINGS

1. Activate the console and select the **SYSTEM** menu option.

See HOW TO ACTIVATE THE CONSOLE on page 11.

Then, see HOW TO USE THE SETTINGS MODE on page 20.

The system menu will appear in the message banner.

2. Select the **AUTO PAUSE** menu option and enable or disable the Auto Pause mode if desired.

You can enable (PAUSE ON) or disable (PAUSE OFF) the Auto Pause mode. See HOW TO USE THE AUTO PAUSE MODE on page 16 for more information about the Auto Pause mode.

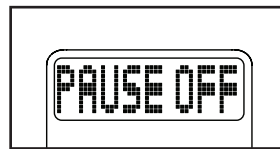

The currently selected option will be displayed with a dark background.

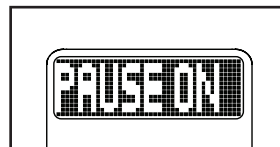

Tip: It is recommended that studio cycling class instructors who manage their classes based on time select the PAUSE OFF option for the consoles on their exercise bikes.

Select the desired PAUSE ON or PAUSE OFF option. Then, return to the system menu.

3. Select the **USB** menu option and enable or disable the USB port if desired.

You can enable (USB ON) or disable (USB OFF) the USB port on the console. Note: The default option is USB ON.

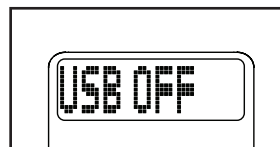

The currently selected USB option will be displayed with a dark background.

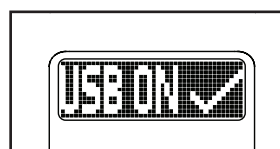

When the USB OFF option is selected, the USB port cannot be used to save ride data (see step 3 on page 12) and cannot be used to save or import custom console settings (see page 26).

Select the desired USB ON or USB OFF option. Then, return to the system menu.

4. Select the **STATS** menu option and view console usage information if desired.

The console keeps track of usage information (STATS) that can be viewed and saved on a USB drive. Note: The USB port must be enabled to save console usage information on a USB drive (see step 3 on this page).

The stats menu will appear in the message banner. View the desired console usage information.

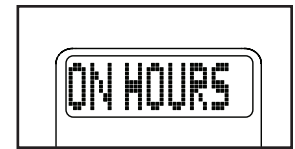

To save the console usage information to a USB drive, select the SAVE TO USB option. The console will then save the information in a .csv file format.

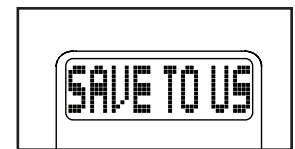

Return to the system menu.

5. Select the **FIRMWARE** menu option and manage the console firmware if desired.

The firmware menu will appear in the message banner.

See HOW TO MANAGE CONSOLE FIRMWARE on page 25.

6. Exit the system menu.

See HOW TO USE THE SETTINGS MODE on page 20.

HOW TO MANAGE CONSOLE FIRMWARE

Firmware is the programming that allows the console and sensor to function. Using the firmware menu, you can do the following:

- View information about the console firmware and the power sensor firmware
- Import upgraded firmware
- Save and import custom console settings
- Restore console settings to the manufacturer's default settings

The firmware menu contains the following menu options:

CNSL V.X (console version number)—Select this menu option to view the current firmware version number for the console.

PWR V.X (power sensor version number)—Select this menu option to view the current firmware version number for a power sensor paired to the console.

UPGRD FIRMWARE—Select this menu option to replace the current firmware with upgraded firmware. See HOW TO UPGRADE FIRMWARE at the right.

SAVE CONFIG—Select this menu option to save your custom console settings to a USB drive. Your custom console settings can then be used on other consoles. See HOW TO SAVE CUSTOM CONSOLE SETTINGS on page 26.

IMPRT CONFIG—Select this menu option to import saved custom console settings from a USB drive into the console. See HOW TO IMPORT CUSTOM CONSOLE SETTINGS on page 26.

RESET TO DEFAULT—Select this menu option to reset your custom console settings to the manufacturer's default settings. See HOW TO RESTORE DEFAULT SETTINGS on page 27.

How to Upgrade Firmware

IMPORTANT: Upgrading the firmware is an advanced procedure. Make sure to read all instructions before upgrading the firmware.

1. The manufacturer will provide the upgraded firmware file in a specific xxxx.HEX file format.
2. You must save the file on a USB drive. The file must be in the top level of the drive directory. The file cannot be within any other folder. You can save only one firmware file on the USB drive at a time.
3. Make sure that the USB port on the console is enabled (see step 3 on page 24).

4. Select the CNSL V.X menu option on the firmware menu. View and note the current console version number.

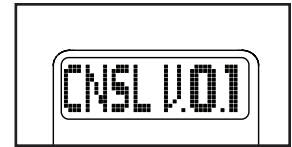

5. Insert the USB drive containing the upgraded firmware file into the USB port on the console.

6. Select the UPGRD FIRMWARE menu option on the firmware menu. The console will begin the firmware upgrade.



7. During the firmware upgrade, the LCD display will freeze for approximately 10 seconds and then all the displays will light for a moment. After this occurs, the console is using the upgraded firmware.
8. Select the CNSL V.X menu option on the firmware menu. View and note the upgraded console version number.
9. Restore your custom console settings if desired. During the firmware upgrade, the console settings will be reset to the manufacturer's default settings.

Note: If the console has been paired to a sensor, you do not need to re-pair the console to the sensor; the paired relationship will survive the firmware upgrade.

How to Save Custom Console Settings

The following custom console settings can be saved to a USB drive:

- Unit of measurement
- Backlight duration
- Contrast level
- Auto pause setting
- USB port setting

The custom console settings will be saved in an import.cfg file format.

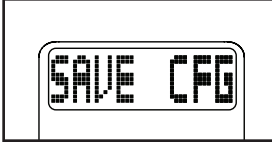
1. Make sure that the USB port on the console is enabled (see step 3 on page 24).
2. Insert your USB drive into the USB port on the console.
3. Select the SAVE CFG menu option on the firmware menu. The console will begin saving the custom console settings to the USB drive and the word SAVE--- will appear in the message banner. 
4. If the custom console settings are saved successfully to the USB drive, the word DONE will appear in the message banner.
5. If the custom console settings are not saved to the USB drive, the word FAILED will appear in the message banner. **Go to TROUBLESHOOTING on page 29.**

How to Import Custom Console Settings

You can import saved custom console settings from a USB drive to the console.

1. Make sure that the USB port on the console is enabled (see step 3 on page 24).
2. Make sure that the desired custom console settings file (import.cfg) is saved on your USB drive (see HOW TO SAVE CUSTOM CONSOLE SETTINGS at the left).

3. Insert your USB drive into the USB port on the console.

4. Select the IMPRT CFG menu option on the firmware menu. The console will begin importing the custom console settings to the console and the word IMPRT--- will appear in the message banner.

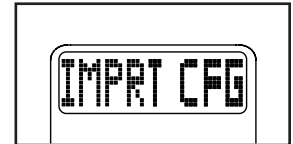

Tip: You can also use this shortcut to select the IMPORT CFG menu option: Press and hold the Backlight and STAGE buttons for 3 seconds.

5. If the custom console settings are imported successfully to the console, the word DONE will appear in the message banner.
6. If the custom console settings are not imported to the console, the word FAILED will appear in the message banner. **Go to TROUBLESHOOTING on page 29.**

How to Restore Default Settings

You can restore the following console settings to the manufacturer's default settings. The default settings are indicated in parentheses:

- Unit of measurement (ENGLISH)
- Backlight duration (5 SEC)
- Contrast level (100 %)
- Auto pause setting (PAUSE ON)
- USB port setting (ON)

Select the RESET TO DEFAULT menu option on the firmware menu. The word DONE will appear in the message banner to indicate that the console is restored to the default settings.

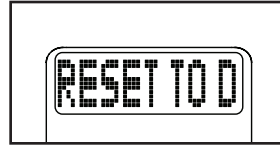

HOW TO USE A BIKE NUMBER

Tip: It is strongly recommended that each exercise bike in a fitness club be numbered for easy identification.

To communicate properly, a paired console and sensor must be mounted to the same exercise bike.

To make sure that the correct console stays with the correct sensor and exercise bike, you can assign an identification number to the console that matches the identification number of the exercise bike.

If there is a communication problem between the console and the sensor, you can view the bike number and make sure that the console is attached to the correct exercise bike.

To assign the bike number, see HOW TO ASSIGN THE BIKE NUMBER at the right. **To view the bike number**, see HOW TO VIEW THE BIKE NUMBER at the right.

How to Assign the Bike Number

1. Activate the console and select the BIKE # menu option.

See HOW TO ACTIVATE THE CONSOLE on page 11.

Then, see HOW TO USE THE SETTINGS MODE on page 20.

The bike number will appear in the message banner.

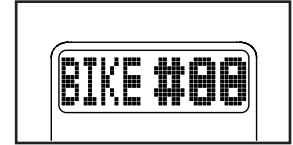

2. Assign a bike number to the console.

You can assign a bike number from 1 to 99.

Press the AVG/END and Backlight buttons to assign the desired bike number. Then, press the STAGE button to confirm your selection.

3. Exit the bike number menu.

See HOW TO USE THE SETTINGS MODE on page 20.

How to View the Bike Number

When the console is in the User mode, press and hold the STAGE and AVG/END buttons. The bike number assigned to the console will appear in the message banner for as long as the buttons are held.

MAINTENANCE

HOW TO CLEAN THE CONSOLE

To clean the console, use a soft, damp, non-abrasive cloth. Do not use abrasives or solvents to clean the console. **IMPORTANT: To avoid damage to the console, keep liquids away from the console and keep the console out of direct sunlight.**

HOW TO REPLACE BATTERIES

When the batteries for the console, the power sensor, or the RPM sensor need to be replaced or recharged, one of the low battery warnings shown will appear in the message banner.

IMPORTANT: Replace or recharge the batteries as soon as possible when the low battery warning appears. If you do not replace or recharge the batteries, the console may shut down or the sensor may stop transmitting data to the console.

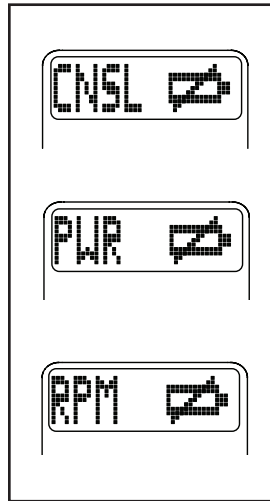

The console can use three C standard alkaline batteries. The power sensor can use two AA standard alkaline batteries. Standard alkaline batteries have an extended shelf life (low discharge rate) and provide good battery life when used.

The console and the power sensor can also use C and AA NiMH (nickel-metal hydride) rechargeable batteries. These batteries have longer battery life for each charge compared to standard alkaline batteries and can be charged up to five hundred times. These rechargeable batteries are a good option for high-use environments, such as fitness clubs. Make sure to use low discharge rechargeable batteries that have at least a 2500mAh capacity.

To replace the console batteries, remove the console from the battery cover and insert the batteries into the battery compartment. **Make sure to orient the batteries as shown by the diagram inside the battery compartment.** Then, reattach the console to the battery cover.

To replace the power sensor batteries, remove the battery cover from the power sensor and insert the batteries into the battery compartment. **Make sure to orient the batteries as shown by the diagram inside the battery compartment.** Then, reattach the battery cover.

The RPM sensor requires one CR2032 lithium battery. This is the only battery that can be used with the RPM sensor.

To replace the RPM sensor battery, remove the cover and the RPM sensor from the shield on the exercise bike and insert the battery into the clip on the RPM sensor. Then, reattach the RPM sensor and the cover to the exercise bike.

TROUBLESHOOTING

Problem	Possible Cause	Solution
Console does not activate	Console batteries dead or improperly installed	Make sure fresh batteries are properly installed in console.
Console does not display data	Console not attached to correct paired sensor and exercise bike	Press and hold STAGE and AVG/END buttons to view bike number. Attach console to correct paired sensor and exercise bike.
	Sensor magnet for power sensor not attached to exercise bike	See power sensor installation guide and attach sensor magnet to exercise bike.
	Console not paired to sensor	Make sure that console is paired to the power sensor or the RPM sensor on the exercise bike.
	Sensor batteries dead	Make sure fresh batteries are properly installed in sensor.
Console receives data from another exercise bike	Console not attached to correct paired sensor and exercise bike	Press and hold STAGE and AVG/END buttons to view bike number. Attach console to correct paired sensor and exercise bike.
Console paired to power sensor shows RPM but not WATTS in displays	Power sensor incorrectly paired as RPM sensor	Re-pair the console and power sensor. Make sure to select the PWR SENSOR menu option.
Sensor does not pair to console	Batteries dead or improperly installed	Make sure fresh batteries are properly installed in console and sensor.
	Console and sensor too far apart	Place console and sensor side by side and attempt to pair.
	Interference in the area	Pair only one console and sensor at a time. Make sure that no other ANT+ devices are being used in the area.
Console does not show heart rate in display	Heart rate monitor not in contact with skin	Wet contacts on heart rate monitor and make sure that heart rate monitor is in contact with skin.
	Heart rate monitor does not work	Make sure that heart rate monitor works. Test heart rate monitor on other equipment. Make sure fresh batteries are properly installed in heart rate monitor.
	Console not receiving ANT+ signal	If using ANT+ heart rate monitor, stand within 1 foot (30 centimeters) of console during WARM UP mode and allow console to link to heart rate monitor.
	Console not receiving 5.3kHz signal	Electromagnetic interference in area may be disrupting signal. Make sure that no other devices in area are causing interference.
Console paired to RPM sensor does not display KCAL value	User not wearing heart rate monitor	KCAL calculations require user to wear heart rate monitor when console is paired to RPM sensor.
Backlight does not turn on	Backlight duration set to OFF	Select SETTINGS mode, select Backlight Time, and set backlight duration.
Backlight stays on	Backlight duration set to ON	Select SETTINGS mode, select Backlight Time, and set backlight duration.
USB drive does not connect to console	USB port set to OFF	Select SETTINGS mode, select USB, and set USB port to ON.
Cannot save or import settings	USB port set to OFF	Select SETTINGS mode, select USB, and set USB port to ON.
Cannot upgrade firmware	USB port set to OFF	Select SETTINGS mode, select USB, and set USB port to ON.
	Firmware file error	Make sure that only one firmware upgrade file is on USB drive. File must be in top drive directory and cannot be in a folder.
Time display runs when console is paused	Auto Pause set to OFF	Select SETTINGS mode, select AUTO PAUSE, and set Auto Pause to ON.
Link between sensor and console interrupted	Electromagnetic interference	Press the AVG/END button and then press the STAGE button to relink sensor to console.

HOW TO CONTACT CUSTOMER CARE

If you have questions after reading this manual, if parts are damaged or missing, or to order replacement parts, please contact Customer Care at the phone numbers or addresses listed below. **Please note the model number and the name of the product (see the front cover of this manual) before contacting Customer Care.**

In the United States and Canada

Call: 1-800-201-2109, Mon.–Fri. 8 a.m.–5 p.m. MT

Write:

FreeMotion Fitness
1500 South 1000 West
Logan, UT 84321-9813
United States

Outside the United States and Canada

Call: 001-435-786-3521

Email: intlcustomercare@freemotionfitness.com