

**R872**

**Mobile Hotspot**

**User Guide**

# Table of Contents

---

Introduction .....	3
Before You Begin .....	3
Compatible Operating Systems (OS).....	4
Package Contents.....	4
SSID and Security Key .....	5
Additional Information .....	5
Get Started.....	6
Parts and Functions .....	6
Home Screen .....	7
Data Transfer Volume and Transfer Speed.....	8
SIM Card .....	9
Battery Use .....	12
Turn Your Device On and Off .....	15
Connect with Wi-Fi (WLAN) .....	16
Wi-Fi (WLAN) Overview .....	16
Activate Wi-Fi (WLAN) Function .....	16
Connect Windows PCs with Wi-Fi .....	17
Connect Mac Computers with Wi-Fi .....	17
Connect iOS devices (iPhone/iPod Touch/iPad) .....	18
Connect an Android™ Device.....	20
Hotspot Settings.....	22
Launch the Web UI page .....	22
Home.....	23
Connected Devices .....	24
Settings .....	26
About.....	44
Support Tab .....	45
Appendix .....	46
Troubleshooting .....	46
Specifications .....	49
Warranty and Service.....	51
Customer Service.....	51

Trademarks and Copyrights.....	52
Safety and Notices .....	53
Safety Precautions .....	53
Important Notice .....	53
Safety and Hazards .....	53
Proper Battery Use and Disposal .....	54
Index.....	55

# Introduction

---

The following topics describe the basics of using this guide and your new mobile broadband device.

## Before You Begin

Thank you for purchasing your new R872 Mobile Hotspot!

The following topics explain how best to use this guide to get the most out of your mobile broadband device.

### Before Using Your Device

Read [Safety and Notices](#) thoroughly for proper usage.

Accessible services may be limited by subscription contract conditions.

### Guide Usage Notes

Note that most descriptions in this guide are based on your device's default settings at the time of purchase.

### Screenshots and Key Labels

Screenshots and Key labels are provided for reference only. Actual windows, menus, etc. may differ in appearance.

### Other Notations

In the user guide, the mobile broadband device may be referred to either as "mobile broadband device," "hotspot," "device," or "R872."

# Compatible Operating Systems (OS)

The table below outlines the compatible operating systems (OS) for your device. Use outside these environments may affect performance. Additional factors (hardware, connected peripherals, installed applications, etc.) may also affect performance.

- For computer support, OS version upgrade information, etc., see the corresponding manufacturer's product support documentation.
- The information for operating system (compatible OS) listed below is the current information for your device sold as of Feb.2016. Check [Compatible Operating Systems](#) for the latest information in regards to operating environment.

Item	Description
<b>Compatible operating systems (OS)</b>	Windows 7, 8, 10 MacOS 10.5 or later Android 2.1 or later
<b>Compatible browsers</b>	Chrome 36.0 or later Internet Explorer 8.0 or later Firefox 3.1 or later Safari 5.0 or later

# Package Contents

See below for details on everything you will find in the box for your R872.

- R872 Mobile Hotspot (Battery and battery cover)
- AC Charger with micro USB
- Get Started Guide

# SSID and Security Key

Before connecting Wi-Fi devices to your R872, you will need to confirm the WiFi Name and WiFi Password.

- Once your device is completely powered on, shortly press the menu button (power button) 1 time for the WiFi Name and twice to obtain WiFi Password specific to your device (Note: when the device display is off, the first press wakes up the display.)
  - ❖ You will see the WiFi Name and WiFi Password.

## Additional Information

The following list describes additional information useful to know before you begin using your R872.

- Your mobile broadband device accommodates software updates. Always use the latest software.
- Note that connection speeds may drop or connections may be disabled depending on line traffic or connection environments.

# Get Started

---

The following topics give you all the information you need to set up your device and wireless service the first time.

## Parts and Functions

Learn your device's primary parts and functions.

### Device Layout

The following illustration outlines your device's primary external features and buttons.

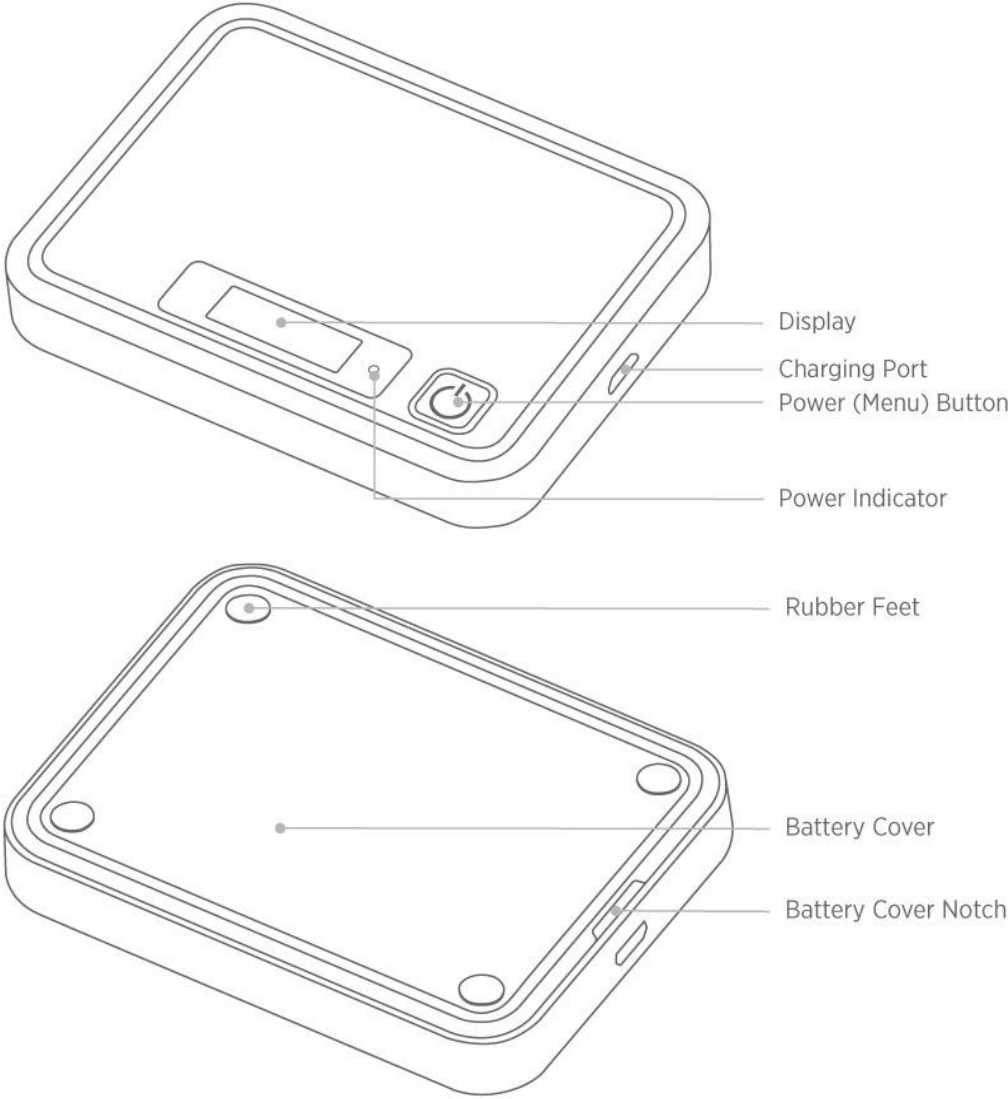

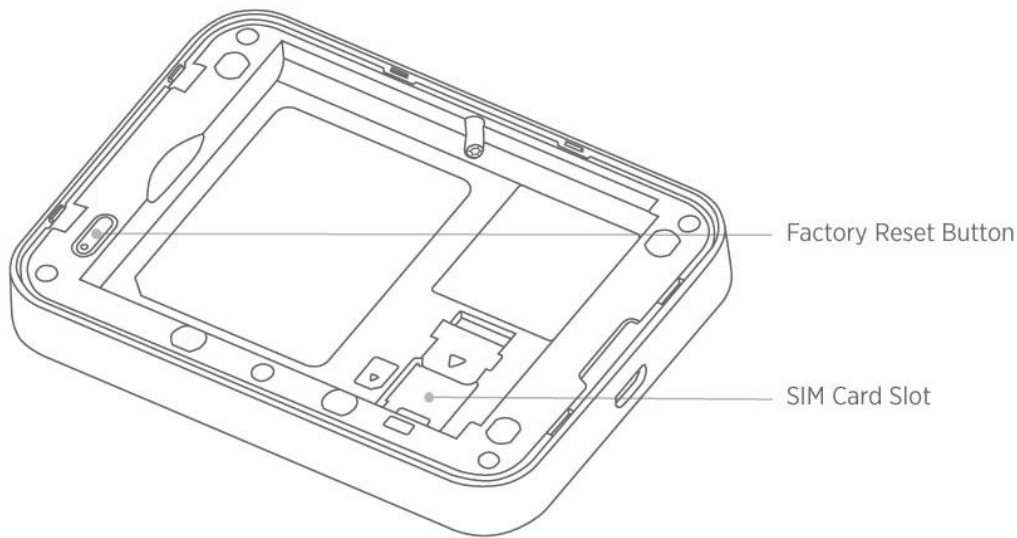

Part	Description
Display	View device status and information
SIM card slot	Install the SIM card.
Charging Port	Connect the micro USB cable for charging.
Battery cover	Remove the battery cover to remove or insert the battery or SIM card.
Factory Reset Button	Long press to reset your device to its default settings.
Power (Menu) button 	Long press to toggle power on or off. Short press to navigate device information

## Home Screen

The following topics describe the details of your device's display layout, icons, data usage and information.

### Home Screen Layout

Explore your device's home screen layout.

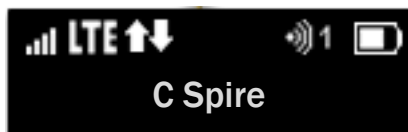













Part	Description
Status bar	Displays status indicators including connection status, signal strength, devices connected, battery level, and more.

## Status Bar Icons

The home screen's status bar may feature the following icons, depending on current status.

Icon	Description
	Mobile networks connected
	Service signal strength. The more bars, the better service signal received
	Out of service area
	Appears when roaming
	The number of connected WLAN devices
	Battery full
	Battery low
	No battery. Battery icon blinking (charging required)
	Invalid SIM
	No SIM
	SIM Lock

## Data Transfer Volume and Transfer Speed

Wireless Mode	Maximum Downlink Speed	Typical Downlink Speed
4G LTE	150 Mbps	50 Mbps

**Note:** Actual speeds depend on several factors, including network conditions.

# **SIM Card**

The SIM card is an IC card containing your device's phone number and other customer information.

## **Handling a SIM Card**

Keep the following in mind when handling a SIM card.

- Customer is responsible for any damage caused by inserting the SIM card in another-brand IC card reader, etc. The company is not responsible in such case.
- Always keep the IC chip clean.
- Wipe clean with a dry, soft cloth.
- Avoid applying labels. May damage the SIM card.
- See instructions included with the SIM card for handling.
- The SIM card is the property of the company.
- The SIM card is replaceable (at cost) in case of loss/damage.
- Return the SIM card to the company when cancelling subscription.
- Returned SIM cards are recycled for environmental purposes.
- Note that SIM card specifications and performance may change without notice.
- It is recommended that you keep a separate copy of information that is stored on the SIM card. The company is not responsible for damages from stored information that is lost.
- Always follow emergency procedures to suspend service if your SIM card or device (SIM card inserted) is lost or stolen. For details, contact Customer Service.
- Always power off the mobile broadband device before inserting or removing the SIM card.

## Installing / removing a SIM Card

Follow these instructions to insert or remove a SIM card. Remember to power off your device before inserting or removing a SIM card.

1. Press and hold the **Power** key  to turn off the device before inserting or removing the SIM card.

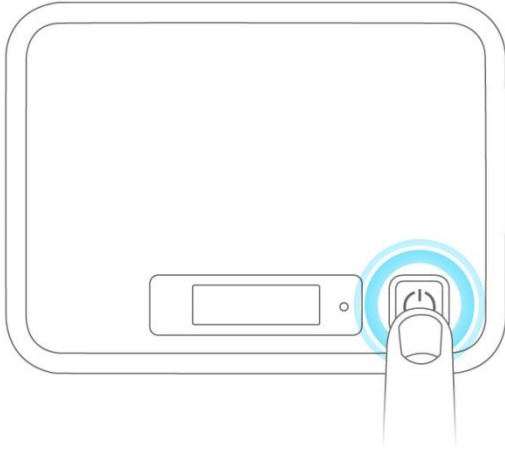

2. Remove the battery cover.

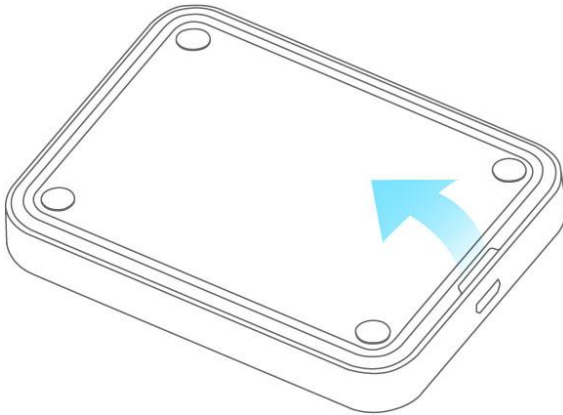

3. Open the SIM card cover.

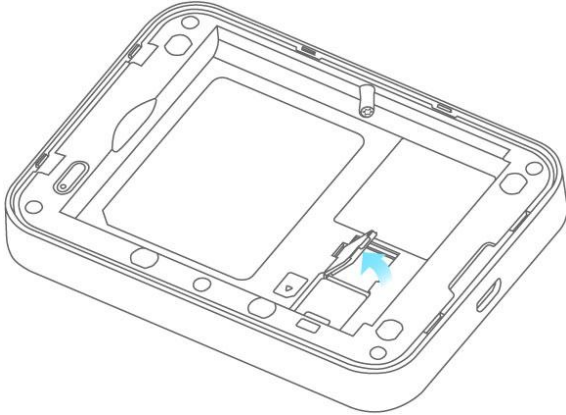

4. Insert the SIM card gently with gold IC chip facing downward

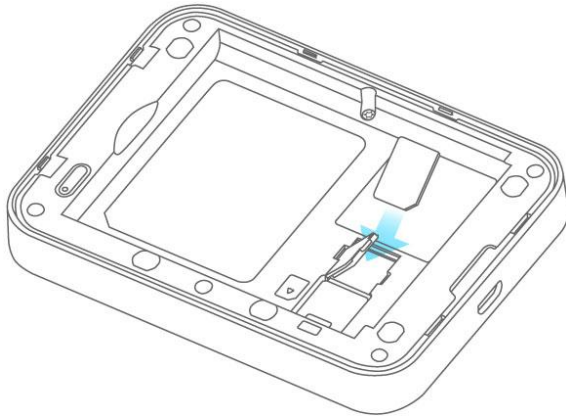

5. Remove the SIM card by gently pressing down and sliding outwards.

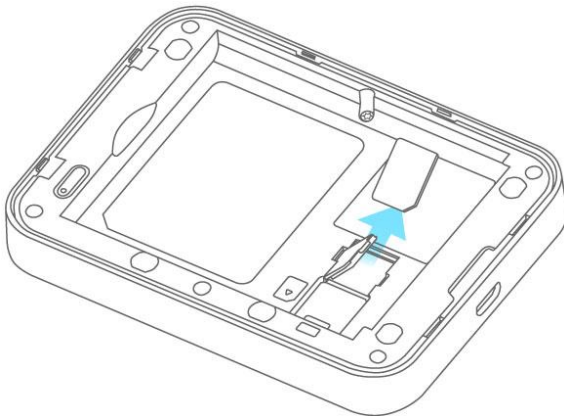

6. Close the SIM card cover and insert the battery.

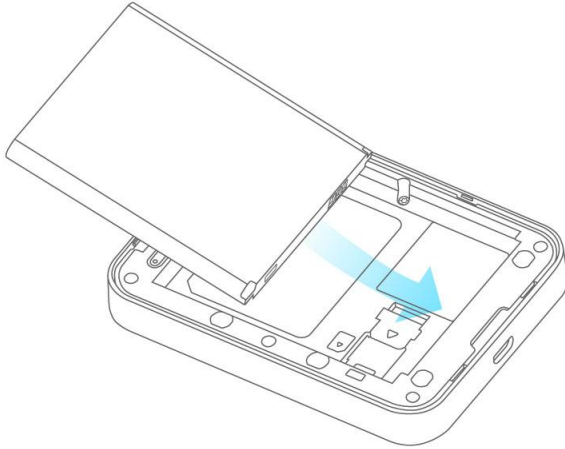

- Align the contacts of the battery with the contacts in the device.
7. Attach the battery cover.

## Battery Use

The following topics explain how to insert and remove your device's battery.

### Battery Cautions

**Storage:** Avoid storing or leaving the battery with no charge remaining. Saved information and settings may become lost or changed, or battery may become unusable. Charge once every six months before storing or leaving unused for a long period.

**Bulges:** Depending on use, bulges may appear near end of battery life. This does not affect safety.

**Replacing the Battery:** The battery is a consumable item. It needs to be replaced if operating time shortens noticeably. Purchase a new battery.

**Cleaning:** Clean soiled terminals between battery and device with a clean, dry cotton swab. Soiled terminals can result in a poor connection and prevent charging, etc.

### Inserting / Removing the Battery

Follow these instructions to insert your device's battery safely and properly.

1. Press and hold the **Power** key  to turn off the device before inserting or removing the battery.

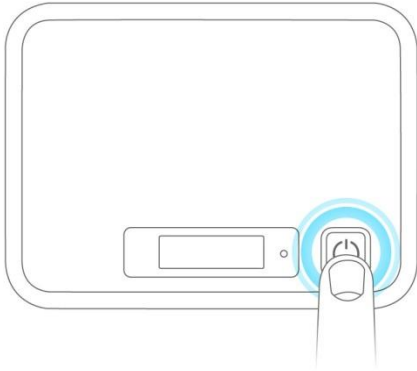

2. Remove the battery cover.
3. Remove the battery / Insert the battery.

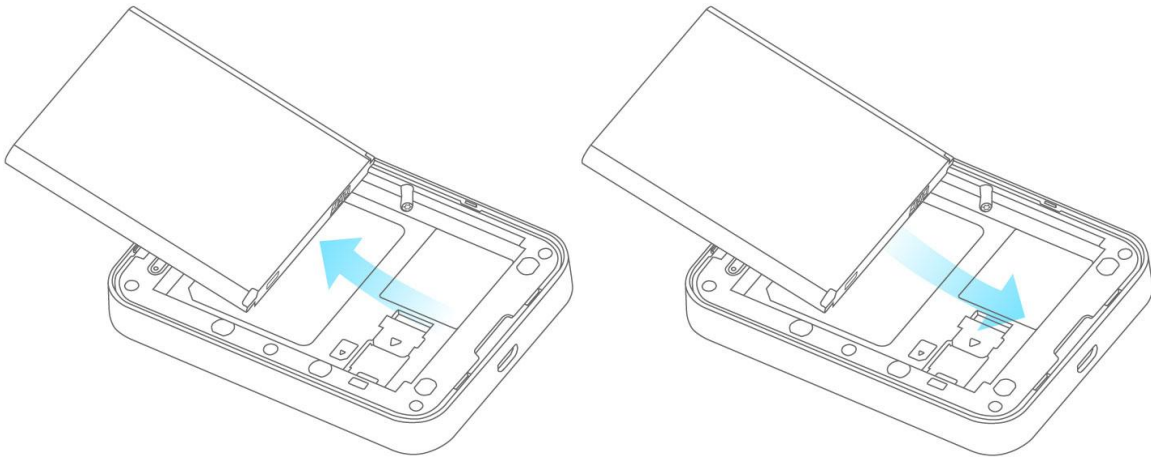

4. Replace the battery cover.

## Charge the Battery

### **Follow these instructions to charge your device's battery using the included AC adapter. Battery Charging Cautions**

**Charging Conditions:** Under low temperatures charging performance decreases. Charge in temperatures between 5°C ~ 35°C. Do not charge in places where there is high humidity. USB charging may be unavailable depending on Wi-Fi router temperature.

**Use Supplied Accessories:** Always use the supplied AC adapter.

**Precaution for Extended Use:** Your device may become hot when used for a long time or while charging, especially in high temperatures. Prolonged contact with skin may cause low-temperature burn injuries.

**The R872 and AC Adapter Becoming Warm or Hot:** Your device and the AC adapter may become warm while charging. This is not a malfunction. However, stop using them immediately if they become extremely hot; this could indicate a malfunction.

## Charge Using the AC Adapter

Use the supplied AC adapter.

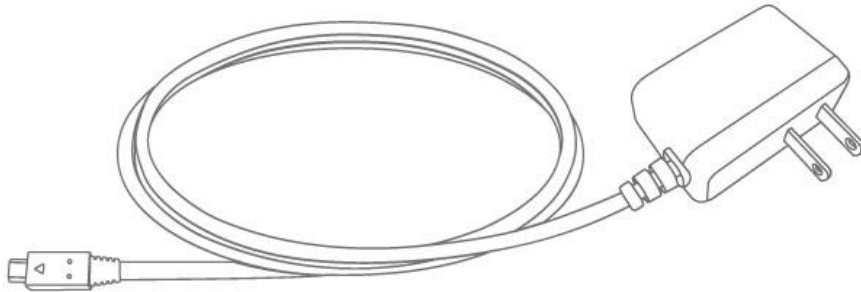

1. Plug the AC adapter into an electrical outlet.
  - ❖ The indicator light on the power button illuminates red when charging starts. The light turns green when the battery is fully charged. Fully charging a battery may take up to three hours.
2. After charging, disconnect the device from the charger.

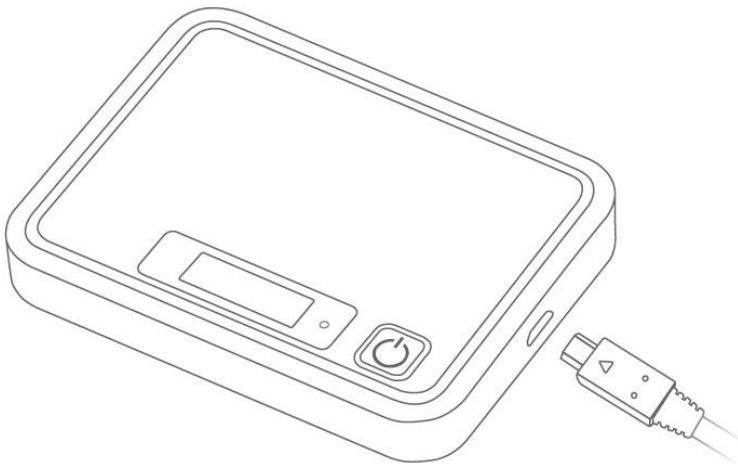

- Unplug the AC adapter from the outlet, and remove the micro USB connector from the device.

# Turn Your Device On and Off

The instructions below explain how to turn your device on and off, or to restart your device if it cannot be powered on and off using the **Power** button .

## Turn Your Device On

- Press and hold the **Power** button  until the device displays "Welcome".

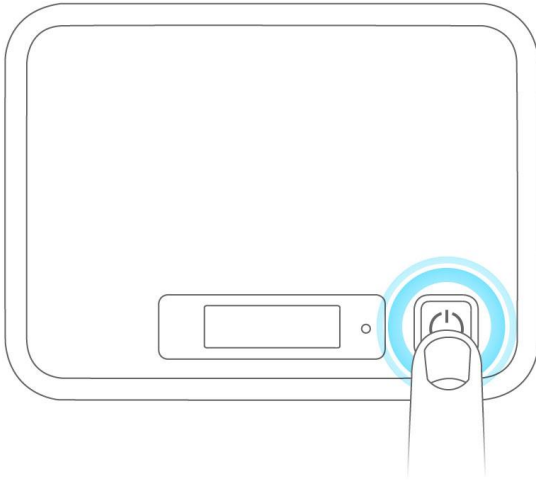

## Turn Your Device Off

Press and hold the **Power** button  until the device displays "Goodbye".

## Restart Your Device

If your device will not turn on or off using the Power button, remove and re-insert the battery (see the section "[Inserting / Removing the Battery](#)"), then press and hold the power button again.

**Note:** Restarting your device does not reset the device settings.



# Connect with Wi-Fi (WLAN)

---

The following topics outline basic features and operations of your device's Wi-Fi (WLAN) connections, including connecting with various OS and device types.

## Wi-Fi (WLAN) Overview

Below are some basics of your device's Wi-Fi (WLAN) function.

### Wi-Fi (WLAN) Information

- **Advanced Settings:** Change your device's Wi-Fi (WLAN) settings as required. See [Wi-Fi Basic Settings](#)
- **Simultaneous Connection:** Use your device to connect up to 10 Wi-Fi devices simultaneously.
- **Automatic Updates for Optimizing Wi-Fi Connection:** When connected by Wi-Fi, connection optimizing settings may be automatically received and updated.

### Wi-Fi (WLAN) Usage Cautions

For added security, it is recommended that you change the default Wi-Fi network name (SSID) and Wi-Fi password after setting up your device.

### Wi-Fi (WLAN) Overview

- Your device supports IEEE 802.11 b/g/n standards. Connect Wi-Fi devices (PC, game console, etc.) via Wi-Fi for wireless data transfers.

## Activate Wi-Fi (WLAN) Function

Follow the instructions below to activate your device's Wi-Fi function and connect to the Internet via an available 4G LTE connection. Use the Web UI to select a network.



Press and hold the **Power** button  until the device displays "Welcome".

- Your device's Wi-Fi function activates and automatically connects to the Internet.

## Connect Windows PCs with Wi-Fi

The following topics describe how to connect your device with various versions of Windows PCs via Wi-Fi.

Connect Windows PCs to your device with Wi-Fi.

1. Press and hold the **Power** button  to power on your R872.
  - ❖ Your device's Wi-Fi function activates and automatically connects to the Internet.
2. Activate your PC's Wi-Fi function.
  - The operations depicted are based on Window 10.
  - For other Window versions, consult your PC's operation manual for details on activating Wi-Fi.
3. On your PC, select WLAN icon   
Select your device's Wi-Fi Name (SSID) from the list, and click **Connect**.
4. Enter the Wi-Fi password.
  - ❖ The PC connects to your device. The connected status icon on your device will show an additional device has been connected.

## Connect Mac Computers with Wi-Fi

Follow the instructions below to connect a Mac computer to your device via Wi-Fi.

**Note:** The operations depicted are based on Mac OS X 10.10.5

1. Press and hold the **Power** button  to power on your R872.
  - ❖ Your device's Wi-Fi function activates and automatically connects to the Internet.
2. On your Mac, in the Apple menu, click **System Preferences... > Network**.



3. Click **Wi-Fi** > **Turn Wi-Fi On**.

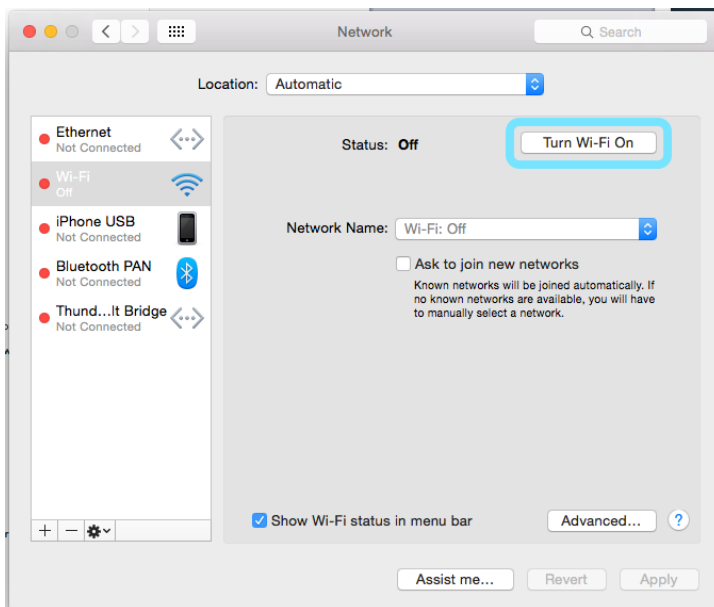

❖ Your computer's Wi-Fi function activates.

4. Select your R872's Wi-Fi Name (SSID) from the Network Name pull-down list.

5. Enter the Wi-Fi password in the Password field, check **Remember this network**, and then click **Join**.

❖ The computer connects to your device. The connected status icon on your device will show an additional device has been connected.

## Connect iOS devices (iPhone/iPod Touch/iPad)

The following topics outline how to connect your iPhone, iPod Touch, or iPad to your device via Wi-Fi.

1. Press and hold the **Power** button  to power on your R872..

❖ Your device's Wi-Fi function activates and automatically connects to the Internet.

2. Select **Settings > Wi-Fi**.

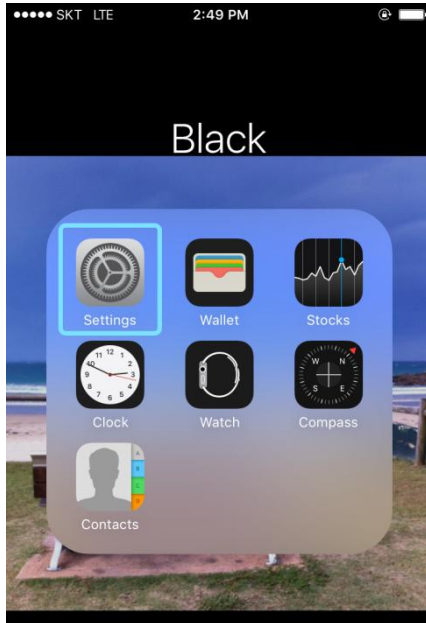

3. Select **Turn on Wi-Fi**.



❖ The iPhone or iPod Touch's Wi-Fi function activates.

4. In the Choose a Network list, tap your R872's Wi-Fi Name (SSID).

5. Enter the Wi-Fi password and then tap **Join**.

❖ The iPhone or iPod Touch connects to your device. The connected status icon on your device will show an additional device has been connected.

## Connect an Android™ Device

You can share your device's connection with compatible Android devices, such as wireless phones, tablets, and Chromebook computers.

1. Press and hold the **Power** button  to power on your R872.
  - ❖ Your device's Wi-Fi function activates and automatically connects to the Internet.
2. On your Android device, from home, select **Menu > Settings**.

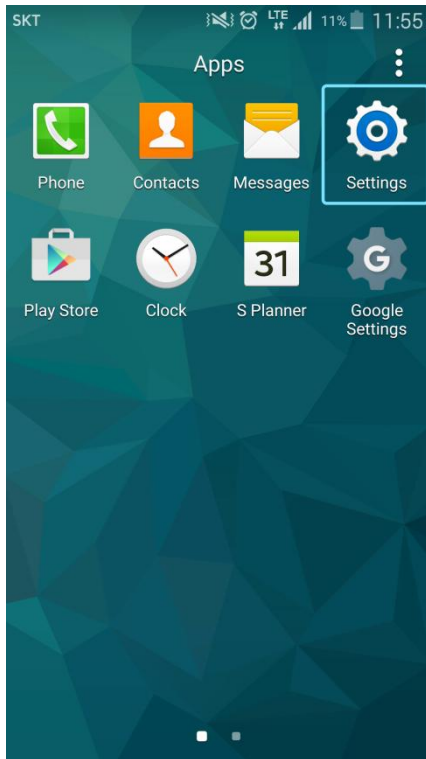

3. Tap or click **Wi-Fi**.

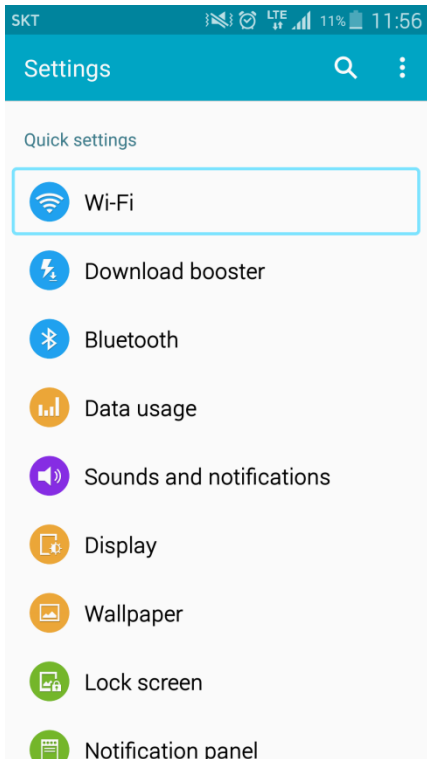

❖ The Wi-Fi settings menu appears.

4. Tap or click the Wi-Fi slider to turn Wi-Fi on.

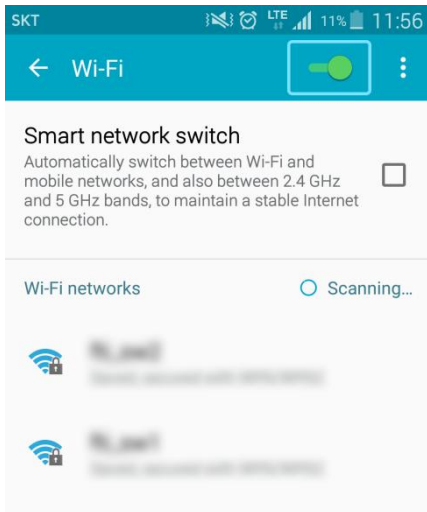

❖ Wi-Fi is enabled on the Android device.

5. Tap or click your R872's Wi-Fi Name (SSID) from the list, and tap **Connect**
6. Enter the Wi-Fi password and then tap or click **Connect**.

❖ The Android device connects to your mobile broadband device. The connected status icon on your device will show an additional device has been connected.

# Hotspot Settings

---

The following topics provide an overview of items you can change using the device **settings** menu accessed through the Web UI.

## Launch the Web UI page

Use the device Web UI in a browser to check or change your R872 settings from a device connected via Wi-Fi.

1. Connect your R872 to an external device via a Wi-Fi connection.
2. Launch a browser and access the Web UI via <http://my.hotspot>
3. The Web UI launches and displays the main window.
4. Log In with the Admin Password.

## Admin Log in

Accessing other menus from the home screen requires admin log in.

Click "**Log in**" on the upper right corner of the main screen to log in. (Clicking other menus on the main screen will prompt the log in page as well.)

Enter the password and click the "Login" button.

The default password is "**password**". It's recommended to change the password for your security.

**!** *Incorrect passwords are tried 5th times, access will be suspended **while 3 minutes.***

- From the device LCD, You can view Admin Password

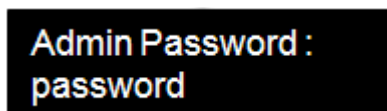

Admin Password :  
password

# Home

Check current status of network connection and data usage on the Home page.

- From the Web UI, click the **Home** tab.

The screenshot displays the cspire Home page. At the top left is the cspire logo. Below it, the text reads "Welcome to your R872". On the top right, there are icons for LTE, signal strength, and battery, along with a language dropdown menu set to "English" and a "Log out" link. A navigation bar contains five tabs: "Home" (selected), "Connected Devices", "Settings", "About", and "Support".

The main content area is divided into two panels:

- Connection Panel:** Shows "Network Status" as "Disconnected", "Network" as "LTE", "Time Connected" as blank, and "Data Used" as "0 Byte". A "Connect" button is present. Below this, it lists "Main Wi-Fi" with a device named "PM-Sally-PC" and "Guest Wi-Fi" with "No Connected Device".
- Data Usage Panel:** Features a green progress bar at the top. Below it, it states "0 byte of 10 GB Used" and "100% Remaining". A "Reset" button is located on the right side. A note at the bottom says "You can reset usage or change usage meter from settings page."

At the bottom right of the page, the copyright notice reads: "© 2016 C Spire. All rights reserved."

## Connection

The Connection Status display Network Status, LTE Status, Connection time, current Data Used and Connect control button. Also Wi-Fi connected devices name.



# Connected Devices

The Connected Devices tab lets you confirm the names and MAC addresses of devices currently connected to your device and set access permissions.

## Check the Connected Devices

- From the Web UI, click **Connected Devices > Connected** to display the list of connected devices.



From the device LCD, You can view Wi-Fi enabled devices currently connected to your Hotspot on the display



## Edit the Connected Device

- Click the Edit button. A page opens allowing you to edit a Main Wi-Fi Devices.
- You can change a devices name on the Main Wi-Fi Devices.
- To save, click the OK button

## Set Access Permissions

Control user's ability to access main or guest Wi-Fi. Changing this status will immediately update the status of devices listed ability to access Wi-Fi from this device, even if they have the password.

- From the Web UI, click **Connected Devices > Access Permissions**.



2. Select an access status and then click **Save Changes**.

## Add Permitted Devices

The Access Permissions menu allows you to restrict access only to specific users, instead of anyone who enters the password. To restrict access in this manner, you need to add permitted users from the menu.

3. From the Access Permissions menu, select **Allow only users on Permitted list**.

❖ The Add Devices option will appear onscreen.

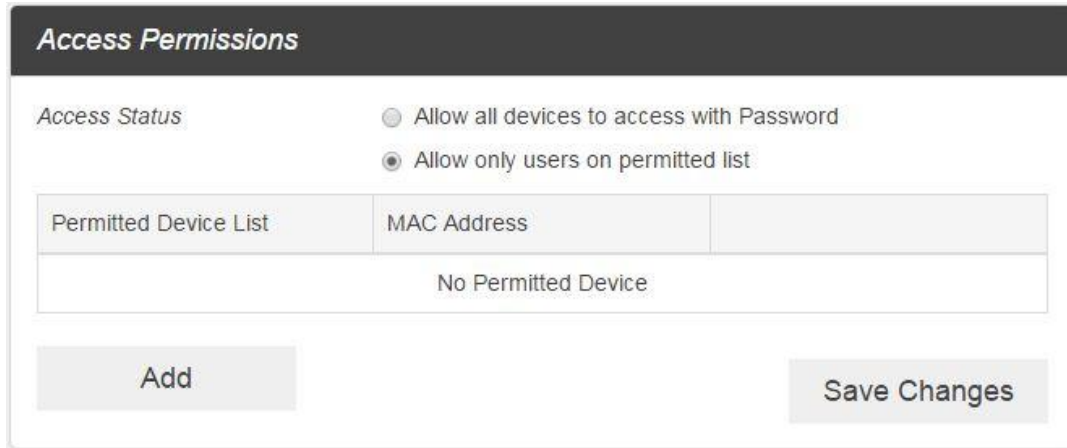

The screenshot shows the 'Access Permissions' dialog box. At the top, the title is 'Access Permissions'. Below the title, there are two radio button options under the heading 'Access Status': 'Allow all devices to access with Password' (unselected) and 'Allow only users on permitted list' (selected). Below these options is a table with two columns: 'Permitted Device List' and 'MAC Address'. The table is currently empty, with the text 'No Permitted Device' centered in the first row. At the bottom of the dialog, there are two buttons: 'Add' on the left and 'Save Changes' on the right.

4. Click > next to **Add Devices** to open the Add Devices menu, and then click **Add More**.
5. Enter a Friendly Name (optional) and the MAC address of the permitted device.
  - A sample MAC address might be 00:1D:0F:10:2D:D9.

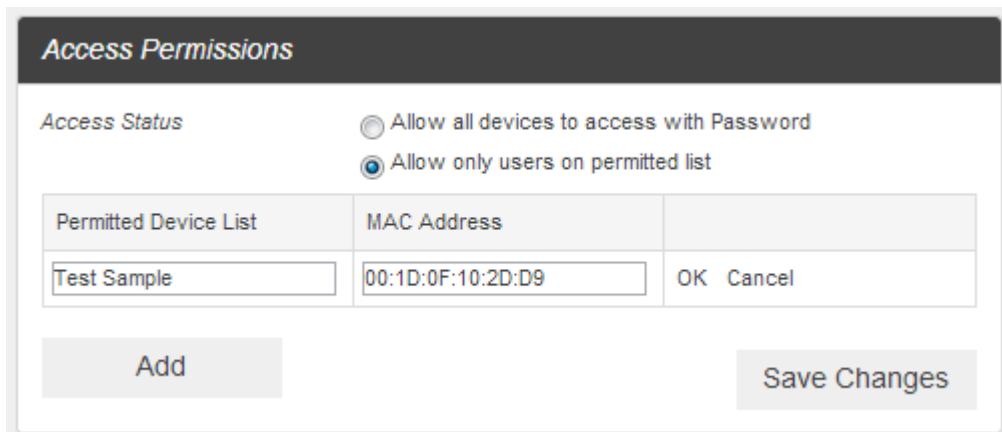

The screenshot shows the 'Access Permissions' dialog box with the same settings as the previous screenshot. The table now has one row with the following data: 'Test Sample' in the 'Permitted Device List' column and '00:1D:0F:10:2D:D9' in the 'MAC Address' column. To the right of the table, there are two buttons: 'OK' and 'Cancel'. At the bottom of the dialog, there are two buttons: 'Add' on the left and 'Save Changes' on the right.

6. Click **Add More** to add more permitted devices.
7. When you are finished adding permitted devices, click **Save Changes**.

❖ Access to your device will be restricted to the devices in your list.

# Settings

Set your device options, including Wi-Fi, Mobile Network, Device and Advance Router.

## Wi-Fi Basic Settings

Set the basic Wi-Fi settings for your device.

**!** *These advanced settings should only be changed for specific circumstances. Changes to the advanced settings could result in loss of Wi-Fi connection with your devices. Consult your devices' manuals for Wi-Fi specifications.*

- From the Web UI, click **Settings > Wi-Fi > Basic** to display the basic wireless network parameters.

The screenshot shows the 'Wi-Fi Basic Settings' page. At the top, there is a header 'Wi-Fi Basic Settings'. Below it, the 'Multi SSID' option is set to 'OFF'. The 'Main W-Fi' section contains the following settings: 'W-Fi Name' is 'C Spire R872a FF50', 'W-Fi Password' is 'bae24118', 'Authentication Method' is 'WPA/WPA2-PSK', and 'Encryption Method' is 'AES-TKIP'. The 'Maximum Connections' section shows 'Maximum Connections' set to '10'. The 'Display Settings' section has 'Display W-Fi Name' and 'Display W-Fi Password' both set to 'ON'. At the bottom right, there is a 'Save Changes' button. Below that, the 'W-Fi Settings Reset' section contains the text 'This operation will return all Wi-Fi settings to the default.' and a 'Reset' button.

- **Multi SSID:** Select ON if you like to set up a separate guest Wi-Fi network. Your R872 will broadcast two Wi-Fi Names.
  - ❖ If ON is selected for Multi SSID, **Guest Wi-Fi** menu will appears below Main Wi-Fi part. And Main Wi-Fi shared Maximum Connections with Guest Wi-Fi. And selected Off, Guest Wi-Fi menu will disappears.

*Guest W-Fi*

---

*W-Fi Name*

*Authentication Method*

- **Wi-Fi Name:** Service Set Identifier (SSID). To change it, enter a string less than 32 characters as the name for your wireless local area network (WLAN).
- **Wi-Fi Password:** To change, enter the new Wi-Fi password. The password needs to be at least 8 characters long.
- **Authentication Method:** Use this setting to select the desired type of Wi-Fi security used to encrypt the wireless network. WPA2 is the latest and most secure method and should be used whenever possible..
  - ❖ **Open** : Authentication and encryption won't be performed. There are risks that private info will be intercepted or network will be used by unauthorized individuals
  - ❖ **SHARED** : Authentication via Shared Key protocol.
  - ❖ **WPA2-PSK** : WPA-PSK is the securer version of WPA with implementation of the 802.11i standard.
  - ❖ **WPA-PSK/WPA2-PSK** : Apply both the WPA-PSK and WPA2-PSK scheme.
- **Encryption Method:** Use this setting to select the desired type of Encryption Method used to encrypt the wireless network Advanced Encryption Standard (AES) is the latest and most secure encrypt the wireless network. Advanced Encryption Standard (AES) is the latest and most secure option and should be used whenever possible..
- **Maximum Connections:** Choose the maximum number of the devices which connect to your device simultaneously.
- **Display Wi-Fi Name:** If ON is selected, the Wi-Fi Name will be displayed on your R872 device display menu.
- **Display Wi-Fi Password:** If ON is selected, the Wi-Fi password will be displayed on your R872 device display menu.

- **Save Changes:** Select your desired setting from the Authentication, Wi-Fi password and/or available Wi-Fi connections drop down menu(s) and click Save Changes whenever you make a change to save the new setting.
- **Wi-Fi Settings Reset:** Click the **Reset** button to reset all Wi-Fi settings to the default.

## Wi-Fi Advanced Settings

1. From the Web UI, click **Settings > Wi-Fi > Advanced**.

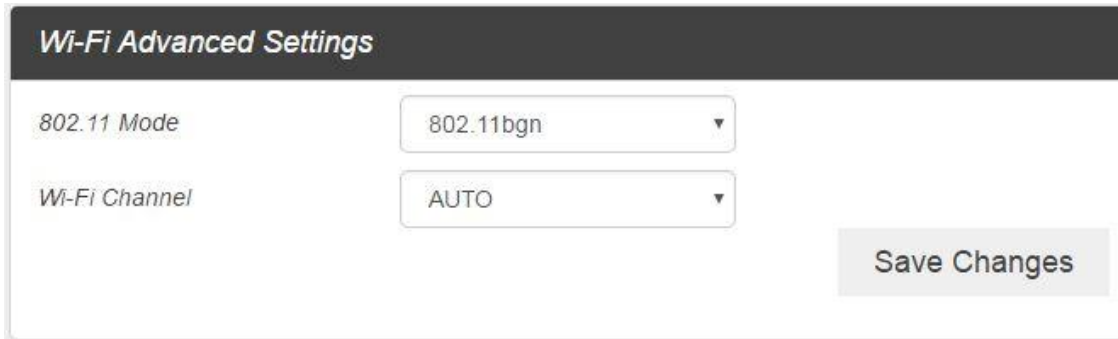

The screenshot shows a web interface for configuring Wi-Fi settings. At the top, there is a dark header with the text "Wi-Fi Advanced Settings". Below the header, there are two settings: "802.11 Mode" with a dropdown menu currently showing "802.11bgn", and "Wi-Fi Channel" with a dropdown menu currently showing "AUTO". To the right of these settings is a grey button labeled "Save Changes".

- **802.11 Mode:** Use this setting to change the Wi-Fi mode. The wireless network technology used. 802.11g+ 802.11b + 802.11n is most compatible, allowing both 802.11b,802.11g,and 802.11n devices to connect to the wireless network..
2. Click **Save Changes** to save your settings.

## Mobile Settings

1. From the Web UI, click **Settings > Mobile Network > Mobile Settings**. The Mobile Settings page is shown in the following figure.

**Mobile Settings**

Manage your mobile broadband data connection

**Cellular Data**  ON  OFF Turn off cellular data to prevent all internet traffic from using the mobile broadband connection

Manage Connection Mode You Prefer

**Auto Connect**  ON  OFF Select auto-connection

**Connection Mode** Automatic Select connection mode with your plan

Roaming

**Data Roaming**  ON  OFF

Save Changes

- **Cellular data:** Turn Cellular data on or off. Turn it OFF to prevent all Internet traffic from using the mobile broadband connection.
  - **Auto Connect:** Turn Auto Connect on or off. And select connection mode with your plan.
  - **Roaming:** Turn Roaming on or off.
2. Click **Save Changes** to save your settings.

## APN

- From the Web UI, click **Settings > Mobile Network > APN**. The default APN parameters are shown in the following figure. You can use the default APN to connect to the Internet. You can also add new APNs.

Active	Name	APN	Username	Password	Auth	PDP Type	Delete
<input type="radio"/>	profile1	ims.cs4glte.com			None	IPv4v6	Edit Delete
<input type="radio"/>	profile2	admin.cs4glte.com			None	IPv4v6	Edit Delete
<input checked="" type="radio"/>	profile3	internet.cs4glte.com			None	IPv4v6	Edit
<input type="radio"/>	profile4	tethering.cs4glte.com			None	IPv4v6	Edit Delete

**Add** **Save Changes**

**EHRPD / HRPD**

**EHRPD**  ON  OFF

**Active Profile** 104

**Save Changes**

- To add a new APN, follow the steps below:
  - Click **Add** to access the following page.

**APN Settings**

LTE APN

Active	Name	APN	Username	Password	Auth	PDP Type	Del
<input type="radio"/>	profile1	ims.cs4glte.com			None ▾	IPv4v6 ▾	Edit Del
<input type="radio"/>	profile2	admin.cs4glte.com			None ▾	IPv4v6 ▾	Edit Del
<input checked="" type="radio"/>	profile3	internet.cs4glte.com			None ▾	IPv4v6 ▾	Edit
<input type="radio"/>	profile4	tethering.cs4glte.com			None ▾	IPv4v6 ▾	Edit Del
<input type="radio"/>	<input type="text"/>	<input type="text"/>	<input type="text"/>	<input type="text"/>	None ▾	IPv4 ▾	OK Can

**Add** **Save Changes**

2. Enter the related parameters as described in the following table.

Parameters	Description
<b>Name</b>	Type the profile name.
<b>APN</b>	Type the APN string.
<b>User name</b>	User name is used to obtain authentication from the ISP when the connection is established.
<b>Password</b>	Password is used to obtain authentication from the ISP when the connection is established.
<b>Authentication</b>	Password Authentication Protocol (PAP) provides a simple method without encryption for the peer to establish its identity using a 2-way handshake. Challenge-Handshake Authentication Protocol (CHAP) is used to periodically verify the identity of the peer using a 3-way handshake.
<b>PDP Type</b>	PDP type is used to obtain IP address type from the ISP when the connection is established. IPv4v6 is used to get both IPv4 and IPv6. IPv4 or IPv6 is used to get each type only.

3. Click **Save** to add the new APN.



- **Additional APN Options**

**APN Settings**

*LTE APN*

Active	Name	APN	Username	Password	Auth	PDP Type	Del
<input type="radio"/>	profile1	ims.cs4glte.com			None ▼	IPv4v6 ▼	Edit Del
<input type="radio"/>	profile2	admin.cs4glte.com			None ▼	IPv4v6 ▼	Edit Del
<input type="radio"/>	profile3	internet.cs4glte.com			None ▼	IPv4v6 ▼	Edit Del
<input type="radio"/>	profile4	tethering.cs4glte.com			None ▼	IPv4v6 ▼	Edit Del
<input checked="" type="radio"/>	Test	testwork	test	test001	PAP ▼	IPv4 ▼	OK Can

◀

▶

Add
Save Changes

- To activate the new APN, check the circle in front of it and then click **Save Changes**.
- To edit the new APN, click **Edit**, change the settings, and then click **Save**.
- To delete the new APN, click **Delete**.

**Note:** The default APN cannot be edited or deleted.

## SIM

- From the Web UI, click **Settings > Mobile Network > SIM**. The SIM PIN lock is disabled by default. You can enable it by entering SIM PIN.

The screenshot shows the 'SIM' settings page. At the top, there is a header 'SIM'. Below it, a paragraph explains that the SIM card can be locked with a PIN and that the PIN must be entered to connect to the internet. The 'SIM Status' is currently 'Disabled'. Under 'Desired Action', there is a dropdown menu with 'Enable PIN' selected. Below that is a text input field for 'Enter Current PIN'. A warning message states that 0 attempts remain until the SIM is PUK locked and that entering an incorrect PIN too many times will PUK lock the SIM, requiring contact with the service provider. A 'Save Changes' button is located at the bottom right.

- Enter the SIM PIN and press “Save Changes”. The SIM Status will be changed to Enabled. Once the SIM PIN Lock is enabled, you need to enter SIM PIN to connect to the mobile broadband network each time you power on your R872.

**Note:** If you enter the wrong SIM PIN three times, your SIM will be disabled permanently until you enter the PUK code from your service provider.

## Advanced

- From the Web UI, click **Settings > Mobile Network > Advanced** to set the mobile network advanced settings on this interface.

The screenshot shows the 'Advanced' settings page. At the top, there is a header 'Advanced'. Below it, a paragraph says 'Manage your mobile broadband data connection'. Under 'Factory Reset', there is a paragraph explaining that this operation, also called Reverse Logistics, will display provisioning information and reset the modem to factory default values, and that the SPC is needed to perform a reset. A 'Factory Reset' button is located at the bottom right.

- **Factory Reset:** Click **Factory Reset** to reset the modem to the factory default value.

## Device

The Device settings menu lets you set display brightness, manage account password, update software, back up, restore and check system log.

## Preferences

1. From the Web UI, click **Settings > Device > Preferences**. You can set the display timeout on this page.

The screenshot shows the 'Preferences' web interface. It has a dark header with the title 'Preferences'. Below the header, there are two main sections: 'Display' and 'Data Usage'. In the 'Display' section, there is a label 'Device Display Timeout' and a dropdown menu currently set to '30 seconds'. In the 'Data Usage' section, there is a label 'Usage Limit', a text input field containing '10', and a dropdown menu set to 'GB'. To the right of the input field, there is an example text 'ex) 500MB, 1500MB, 10GB'. At the bottom right of the form, there is a 'Save Changes' button.

- **Display Timeout:** Select a timeout time from the drop-down list. Your R872 display turns off after this timeout period if there is no menu button action.
  - **Data Usage:** If you set maximum packet bytes that you want, maximum bytes of usage is changed in home page.
2. Click **Save Changes** to save your settings.

## Web Interface

1. From the Web UI, click **Settings > Device > Web Interface**. You can manage your Web UI admin password on this page.

### Web Interface

Display Password  ON  OFF

Save Changes

### Change Password

You can change the password for this Web Interface. You will be locked out if you enter an incorrect password too many times.

Enter Current Password

Enter New Password

Confirm New Password

Save Changes

- **Display Password:** If ON is selected, the Web Interface admin password is displayed on your R872 device display menu.

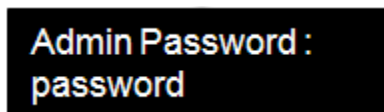

Admin Password :  
password

- **Change Password**
    - **Current Password:** Enter the current password.
    - **New Password:** Enter the new password.
    - **Confirm New Password:** Enter the new password again.
2. Click **Save Changes** to save your settings.

## Software Update

1. From the Web UI, click **Settings > Device > Software Update**. You can update the software on this page.

**Software Update**

Firmware

Current Software Version R872F10.FR.A621

Upload Software

Choose File No file chosen

Upload Software

Check for New Software

Check

2. Read the onscreen options and click the update you would like to initiate.

- **Upload Software:** If you have a new software file provided by your service provider, you can select the file and update your R872 manually by pressing Update Software button.

## Backup and Restore

- From the Web UI, click **Settings > Device > Backup and Restore** to access menus to back up your device settings to your computer, restore from the backup and restore your device to its factory default settings.

### Backup and Restore

Back up your device settings and preferences to your computer. Please note the backup will only with this particular device.

*Download Backup*

Download a copy of your device settings so you can restore it later. Back Up Now

*Restore from Backup*

Upload settings from a previously saved backup file. Restore Now

Choose File No file chosen

*Restore Device to Factory Defaults*

Restore all user settings to the default settings. Restore Factory Defaults

To back up your device settings to your computer, follow the steps below:

1. Click **Back Up Now**.
2. Click **Save** on the pop-up window.
3. Choose a location on your computer to save the backup file.
4. Click **Save**.

To restore from the backup, follow the steps below:

1. Click **Choose File** to select the backup file in your computer.
2. Click **Restore now**.

To restore your device to its factory default settings, follow the steps below:

1. Click **Restore factory default**.
2. Click **Yes** to confirm the command.

## System Logs

- From the Web UI, click **Settings > Device > System logs**, and then click **Download logs** to download the system logs on this page.

## System Logs

Enable Logs  ON  OFF Save Changes

```

Jan 12 23:23:38 mdm9607 syslog.info syslogd started: BusyBox v1.23.1
Jan 12 23:23:42 mdm9607 user.info thermal-engine: Thermal daemon started
Jan 12 23:23:42 mdm9607 user.info thermal-engine: No target config file, falling back to
/etc/thermal-engine.conf
Jan 12 23:23:42 mdm9607 user.info thermal-engine: devices_manager_init: Init
Jan 12 23:23:42 mdm9607 user.info thermal-engine: Unable to open /sys/class/kgsl
Jan 12 23:23:42 mdm9607 user.info thermal-engine: Number of gpus :0
Jan 12 23:23:42 mdm9607 user.info thermal-engine: Number of cpus :1
Jan 12 23:23:42 mdm9607 user.info thermal-engine: update_cpu_topology: Cluster info
node not found/sys/module/msm_thermal/cluster_info
Jan 12 23:23:42 mdm9607 user.info thermal-engine: tmd_init_cluster_devs: No clusters
found
Jan 12 23:23:42 mdm9607 user.info thermal-engine: vdd_rstr_init: Init KTM VDD RSTR
enabled: 0
Jan 12 23:23:42 mdm9607 user.info thermal-engine: cpr_band_init: Could not read
/sys/module/msm_thermal/cpr_band/curr_cpr_band
Jan 12 23:23:42 mdm9607 user.info thermal-engine: sensors_manager_init: Init
Jan 12 23:23:42 mdm9607 user.err thermal-engine: bcl_setup: Unexpected node error
Jan 12 23:23:42 mdm9607 user.err thermal-engine: add_tgt_sensors_set: Error adding bcl
Jan 12 23:23:42 mdm9607 user.err thermal-engine: sensors_init: Error adding BCL TS
Jan 12 23:23:42 mdm9607 user.info thermal-engine: Loading configuration file
/etc/thermal-engine.conf
Jan 12 23:23:42 mdm9607 user.info thermal-engine: Parsing section global

```

Refresh
Clear Logs
Download Logs

**Note:** System logs are used for engineering purposes by your service provider. Keep it OFF during regular usage of your device.

## Advanced Router

### LAN Settings

1. From the Web UI, click **Settings > Advanced Router > LAN Settings** to display the router information shown in the following figure.

**LAN Settings**

Manage your mobile broadband data connection

**IP Address** 192.168. 10 . 1 **Network Access Identifier**

**Subnet Mask** 255.255.255.0

**VPN Passthrough**  ON  OFF

**DHCP Server**  ON  OFF

**DHCP IP Range** 192.168. 10 . 10 ~ 192.168. 10 . 100

**DHCP Lease Time** 86400

**DNS Mode**

Your device automatically selects a Domain Name Server (DNS) or you can manually select one.

**DNS Manual Mode**  ON  OFF

**Out of Service Notification**  ON  OFF

**NAT Timeout** 200

**Save Changes**

- **IP Address:** IP address for Web User Interface.
- **Subnet Mask:** Subnet mask for the IP address.
- **VPN passthrough:** VPN passthrough must be enabled if you want to allow VPN tunnels to pass through your device's firewall.
- **DHCP Server:** Enable or disable DHCP Server function.
- **DHCP IP Range:** Allocate begin and end IP address for IP Range.



- **DHCP Lease Time:** Define how long the leased IP address will be expired. The new IP address will be relocated after the IP address is expired.
- **DNS manual mode:** Turn DNS manual mode on or off.
- **NAT Timer:** Set TCP NAT time.

2. Click **Save Changes** to save your settings.

## Firewall

1. From the Web UI, click **Settings > Advanced Router > Firewall**. You may set up firewall rules to protect your network from virus and malicious activity on the Internet.



**Firewall**

IP address filter function and WAN port ping reply function are only available when firewall is enabled.

Firewall Switch  ON  OFF

Save Changes

### ■ IP Address Filtering

To set IP Address Filtering rules, follow the steps below:

**Firewall**

IP address filter function and WAN port ping reply function are only available when firewall is enabled.

Firewall Switch  ON  OFF

**IP Address Filtering**

IP Address Filtering  ON  OFF

Filter packets using the following rules when specified with protocol, port and IP address.

**Portmapping**

Portmapping  ON  OFF

Portmapping enables computers to access WWW, FTP or other services provided by the LAN

**Save Changes**

- ① Turn on the Firewall Switch.
- ② Turn on the IP Address Filtering.
- ③ Click **Add**.

**IP Address Filtering**

IP Address Filtering  ON  OFF

Filter packets using the following rules when specified with protocol, port and IP address.

- LAN/WAN port: The Value range is 1 ~ 65535.

- Settings not enabled until applied.

Name	WAN IP Address	WAN Port	Protocol	Status	Options
<input type="text"/>	<input type="text"/>	<input type="text"/>	TCP ▼	ON ▼	OK Cancel

**Add**

- ④ Enter the related parameters as described in the following table.

Parameters	Description
<b>Name</b>	Enter a name for the rule.
<b>WAN IP address</b>	Enter the WAN IP address.
<b>WAN port</b>	Set the WAN port.
<b>Protocol</b>	Set which protocol will be used for filtering.
<b>Status</b>	Set how to handle the packet if it matches with the rule.

- ⑤ Click **Save Changes** to add the new filtering rule.

### ■ Portmapping

To set portmapping rules, follow the steps below:

- ① Turn on the Firewall Switch
- ② Turn on the Portmapping.
- ③ Click **Add**

*Portmapping*

*Portmapping*  ON  OFF

Portmapping enables computers to access WWW, FTP or other services provided by the LAN

- IP Address: Specify LAN address. Packets which match the specified conditions will be forwarded to this address.
- LAN/WAN port: Port of the computer providing services. It is a single port with value range of 1 ~ 165535.
- Protocol: Protocols applied by services.
- Settings not enabled until applied.

Name	WAN Port	LAN IP Address	LAN Port	Protocol	Status	Options
<input type="text"/>	<input type="text"/>	<input type="text"/>	<input type="text"/>	TCP ▼	ON ▼	OK Cancel

**Add**

**Save Changes**

- ④ Enter the related parameters as described in the following table.

Parameters	Description
<b>Name</b>	Enter a name for the rule.
<b>WAN port</b>	Set the WAN port.
<b>LAN IP address</b>	Enter the LAN IP address.
<b>LAN port</b>	Set the LAN port.
<b>Protocol</b>	Set which protocol will be used for filtering.
<b>Status</b>	Set how to handle the packet if it matches with the rule.

2. Click **Save Changes** to save your settings.

# About

Show your device's connection information, firmware information, WWAN information, Wi-Fi details and device information.

- From the Web UI main screen, Click the **About** tab to view the available information.

The screenshot displays the 'About' page with the following sections:

- Account**
  - My Number
  - MSID
  - MEID: 99000095741938
  - ICCID
  - IMSI
  - IMEI: 990000957419387
- Device**
  - Model: Franklin R872
  - Manager: my.hotspot
  - Hardware Revision: P2
  - Power State: Online
  - Current Temperature: 40°C
  - Current Voltage: 3.974V
  - Battery Charge Level: 52%
  - Battery Status: Charging
- Wi-Fi Details**
  - W-Fi Name: C Spire R872a FF50
  - W-Fi Password: bae24118
  - MAC Address: 00:01:73:01:FF:50
  - Encryption: WPAWPA2 AESTKIP
  - W-Fi Devices: 1
  - Max W-Fi Devices: 10
  - Broadcast Network Name: Show
- Firmware**
  - Firmware Version: R872F10.FR.M657
  - Build Date: Oct 21 2016
  - Web App Version: R872F10.FR.A657
  - Bootloader Version: R872F10.FR.B657
- WWAN Info**
  - IP Address
  - Lifetime Transferred: 0 byte
- Debug Info**
  - View detailed diagnostic information about your device.
  - Debug

A 'Save to File' button is located to the right of the WWAN Info section.

# Support Tab

Obtain support information on this interface.

- From the Web UI main screen, click the **Support** tab to view the available options.

<p><i>User Guide</i></p> <p><a href="#">Download</a></p>	<p><i>c spire Web Address</i></p> <p><a href="#">Device Support</a> Go to Support, find information on your device along with videos, tutorials, and community forums for your device.</p>
<p><i>Customer Care</i></p> <p><a href="tel:(855)-277-4735">(855)-277-4735</a></p>	<p><i>Manufacturer</i></p> <p><a href="http://franklinwireless.com">franklinwireless.com</a> Check out troubleshooting and other help manuals at the manufacturer's website.</p>

# Appendix

---

The following topics cover items such as troubleshooting, device specifications, applicable warranty and service information, customer service contacts, and applicable trademark and copyright notices.

## Troubleshooting

When properly installed, your device is highly reliable product. If you are having problems, consult this list of common problems and their solutions.

### Problems and Solutions

**No service is available, or, I get a "No Services" message.**

- Reorient your device. Inside of a building or near a structure that maybe blocking the signal, change the position or location of the device. For example, try moving your device close to a window.
- You are outside the service coverage area, or there may be a problem with your account.
- From device LCD

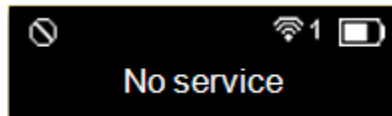

**The device has no power, or the LED indicator does not come on when the power button is pressed.**

- Make sure the battery is properly seated in the device.
- Make sure the battery is fully charged. Plug in the AC charger for at least four hours.

**I forgot my password.**

- Reset the device to factory defaults using the master reset button. Hold the button down for three seconds to reset your router hardware and for three seconds to reset both your router hardware and your device software. (Check the master reset button on [Parts and Functions > Device Layout](#))
- You can also connect your device to an electrical outlet using the AC adapter and go to the operating system (<http://my.hotspot>) to view your security code.

**I cannot connect to my device.**

- Make sure your Windows Wi-Fi adapter/Mac Wi-Fi is turned on.
- (Refer to your computer's Help if you need assistance.)

- Open your wireless network connection list:
  1. Windows: Right-click icon and select **View Available Networks**.
    - Or –
  - Mac: Pull down list from Wi-Fi icon.
  2. Windows: Click **Connect**.
    - Or –
  - Mac: Select the network name.
  3. When your device is connected to the network, the Wi-Fi connected device icon displayed on LCD Screen.

#### **My network does not appear in the wireless network list.**

- Verify that your device's LCD doesn't display Wi-Fi connected device icon.
- Windows: Click **Refresh Network List** on the left side of the Wireless Network Connection screen. If that does not work you can try the following:
  1. Open **Network Connections**.
  2. Right-click **Wireless Network Connection** and select **Properties**.
  3. Click the **Wireless Networks tab**.
  4. Delete any unused wireless connections from the Preferred Networks list and click **OK**.
  5. Restart your computer.
- Mac: Click the AirPort icon and select **Turn Wi-Fi Off**. Then click it again and select **Turn Wi-Fi On**.

#### **I see the network name but cannot connect to my device.**

- Check the Wi-Fi Name, Wi-Fi Password in your connection profile. If any of these are incorrect, you will not be able to connect to the network

#### **How do I disconnect from the network?**

1. Open your device's landing page.
2. Log in as the administrator if you have not already done so.
3. Click Disconnect.

#### **How can I find out how many users are connected to my device?**



- See the device's LCD. The number of clients (users) currently connected to your device is in the Wi-Fi connected device icon at the top of the LCD. You can also see the number of clients currently connected on the Connected Devices page on Web UI.

#### **Where can I find information about Internet connectivity and my Wi-Fi setup?**

- Open the [Settings](#) page on Web UI.

#### **How do I check the model number and firmware versions of my device?**

- Open the [About](#) page on Web UI.

#### **How can I check the battery level of my device?**

- From the Web UI: Open the About. You can find Device sector, there are **Battery Charge Level**.
- On the device: Battery icon displayed at the top of the LCD Screen,

#### **How do I check the available space on the Nano-SIM card?**

- Open the Web UI. Open **Settings > Mobile Network > SIM** page and see the SIM Card status information.

#### **How do I turn off my device?**

- Press and hold the power button for three seconds until the LCD turns off. Your device is connected to the AC adapter and being charged.

#### **What is the default administrative/login password?**

- password

#### **How do I access information on the Wi-Fi network and Wi-Fi clients?**

- Open the WebUI and choose **Settings > Wi-Fi > Basic** and see the current Wi-Fi Network and Wi-Fi Clients information.

#### **I am having trouble connecting to my office VPN.**

- Open the WebUI and choose **Settings > Advanced Router > LAN Settings**. Select the VPN Passthrough ON checkbox and click **Save Changes**.

#### **Using the Factory reset button**

- Your device comes with a factory reset button that allows you to return it to its factory default state.
- The factory reset button is accessed through an opening labeled "RESET" on the back cover of the device. You need a paperclip or similar object to press the button.

**Note:** To reset both the router hardware and the device software to the original factory settings:

1. Make sure your device is powered on.

2. Remove the back cover and locate the opening on the back of the device labeled “RESET.”
3. Insert a paper clip in to the hole and hold the button down for three seconds until the displayed "Factory Reset Restarting...".

- Your list of wireless networks will now show the original default network when you first configured your device.
- Connect to your device again and reconfigure it. You will need to use the original password (“password”) to complete the setup and assign a new unique password.

## Specifications

The following tables list the specifications for the mobile broadband device, the AC charger, and the materials.

### Mobile Broadband Device Specifications

Item	Description
<b>Model name</b>	R872 Mobile Hotspot
<b>Dimensions<sup>1</sup></b>	12.5mm (H) x 90.1mm (W) x 67mm (D)
<b>Weight</b>	97g
<b>Interface</b>	Web UI
<b>Power consumption</b>	Normal state: 1.26 Watts Max state : 2.52 Watts
<b>Operating system</b>	Linux OS
<b>Frequency</b>	LTE B13 DL: 746 ~ 756 MHz      UL: 777 ~ 787 MHz CDMA BC0 DL: 869 ~ 894 MHz      UL: 824 ~ 849 MHz CDMA BC1 DL: 1930 ~ 1990 MHz      UL: 1850 ~ 1910 MHz WIFI(B/G/N) 2412MHz ~ 2462MHz

Item	Description
Compatible networks	LTE category 4 / Wi-Fi IEEE802.11 b/g/n
Charging time <sup>2</sup>	4 hours 20 minutes
Continuous standby time <sup>3</sup>	26 hours
Continuous communication time <sup>3</sup>	6 hours @ Tx pwr 10dBm
Communication speed	LTE category 4 DL : 150Mbps UP : 50Mbps

<sup>1</sup> Approximate values

<sup>2</sup> Varies by ambient temperature, battery usage, etc.

<sup>3</sup> Varies by environment, signal conditions, etc.

### AC Charger Specifications

Item	Description
Rated input voltage	100-240Vac
Operating range	90-264Vac
Rated input frequency	50/60Hz +/- 3Hz
Nominal dc output voltage	+5.0V (±5%)
Rating load current	1.0A

### Materials Specifications

Parts	Materials/Finishing
A cover	PC(Black),SF coating
B cover	PC(Black)

Parts	Materials/Finishing
Battery cover	PC(Black),SF coating
A deco	PC(Black),UV(Gloss 80%)
Power key	PC(Milky White),Spray(Black),UV(Gloss 80%)
LCD Bracket	PC(Black)
Rubber feet	Silicon(Black)

## Warranty and Service

The following topics outline your device's warranty and service information.

### Warranty

Your device purchase includes Warranty.

- Confirm shop name and purchase date.
- Read contents of Warranty and keep it in a safe place.
- Check warranty period in the Warranty.

### Services

Before submitting your device for repairs, contact Customer Service or General Information; be prepared to describe problem in detail.

- During the warranty period, repairs will be made under the terms and conditions described in the Warranty.
- After the warranty period, repairs will be upon request; if said repairs can be made, you will be charged for them.

## Customer Service

For mobile broadband device or service information, call general information. For repairs, call customer assistance.

### C Spire Customer Service

You can reach C Spire Customer Service online or by calling.

- Sign in to your account at <http://www.cspire.com/cms/wireless/my-cspire/>
- Call 1-855-CSPIRES (277-4735)

## **Trademarks and Copyrights**

The names of companies, products, and services used in this guide are registered trademarks or trademarks of the respective companies.

- Franklin Wireless logo is trademarks or registered trademarks of Franklin Wireless Corporation in US. Copyright © 2016 Franklin Wireless Corporation. All rights reserved.

# Safety and Notices

---

The following topics address important safety precautions, general notes, and required RF exposure information for your mobile broadband device.

## Safety Precautions

The following topics outline important safety precautions that must be observed when using your device.

### Important Notice

Due to the nature of wireless communications, transmission and reception of data can never be guaranteed. Data may be delayed, corrupted (i.e., have errors) or be totally lost. Although significant delays or losses of data are rare when wireless devices such as the Pocket Wi-Fi are used in a normal manner with a well-constructed network, your device should not be used in situations where failure to transmit or receive data could result in damage of any kind to the user or any other party, including but not limited to personal injury, death, or loss of property. C Spire accepts no responsibility for damages of any kind resulting from delays or errors in data transmitted or received using your device, or for failure of your device to transmit or receive such data.

### Safety and Hazards

Do not operate your device under the following conditions.

- In areas where blasting is in progress
- Where explosive atmospheres may be present
- Near medical equipment
- Near life support equipment, or any equipment that may be susceptible to any form of radio interference.

In such areas, your device **MUST BE POWERED OFF**. Your device can transmit signals that could interfere with this equipment.

Do not operate your device in any aircraft, whether the aircraft is on the ground or in flight. In aircraft, your device **MUST BE POWERED OFF**. When operating, your device can transmit signals that could interfere with various onboard systems.

**Note:** Some airlines may permit the use of cellular phones while the aircraft is on the ground and the door is open. Your device may be used at this time.

The driver or operator of any vehicle should not operate the device while in control of a vehicle. Doing so will detract from the driver or operator's control and operation of that vehicle. In some jurisdictions, operating such communications devices while in control of a vehicle is an offense.

## Proper Battery Use and Disposal

Follow these guidelines to ensure safe and responsible battery use.

- Do not open, disassemble, puncture, crush, bend, or shred.
- Do not expose to water or other liquids, fire, explosion, or other hazards.
- Use the battery only in the Pocket Wi-Fi.
- If using with a charger, use only the AC charger supplied with your device.
- Do not short circuit the battery.
- When replacing a battery, use the same model of battery that was supplied with your device.
- Follow local regulations when disposing of a used battery.
- Avoid dropping your device or the battery. If dropped and you suspect damage, take it to a service center for inspection.
- Battery usage by children should be supervised.

**Note:** Improper battery use may result in a fire, explosion, or other hazard.

# Index

---

- Android Device
  - Connect Wi-Fi, 20
- Battery
  - Charge, 13
  - Install, 12
- Customer Service, 52
- Data Transfer Speed, 8
- Device Layout (illustration), 6
- Home Screen, 7
- Mac
  - Connect Wi-Fi, 17
- Network Name, 5
- Operating System, 4
- OS, 4
- Package Contents, 4
- Power Key, 7
- Power Off, 15
- Power On, 15
- Safety Precautions, 53
- Security Key, 5
- Services, 52
- Settings, 22
- SIM Card, 9
- Insert, 10
- Specifications
  - AC charger, 51
  - Materials, 51
  - Mobile broadband device, 49
- SSID, 5
- Status Bar Icons, 8
- Transfer Speed, 8
- Troubleshooting, 46
- Turn Device Off, 15
- Turn Device On, 15
- USIM Card, 9
  - Insert, 10
- Warranty, 51
- Wi-Fi
  - Activate, 16
  - Connect Mac, 17
  - Overview, 16
- Wi-Fi Network Name, 5
- WLAN
  - Activate, 16
  - Overview, 16