

FRIGIDAIRE

All about the

Use & Care

of your Gas Range

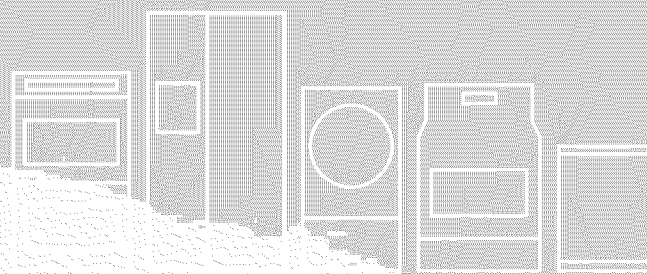

TABLE OF CONTENTS

Important Safety Instructions	3-6	Setting Oven Controls	14-28
Before Setting Oven Controls	7-9	Self-Cleaning	29-31
Before Setting Surface Controls	10-11	Care & Cleaning	32-35
Setting Surface Controls	12	Before You Call	36-39
Oven Control Functions (540 probe)	13	Major Appliance Warranty	back cover

PRODUCT RECORD AND REGISTRATION

Contents

Product Registration	2
Important Safety Instructions	3-6
Before Setting Oven Controls	7-9
Oven racks	7-8
Effortless™ Oven Rack system and assembly	9
Before Setting Surface Controls	10-11
Cookware material types	10
Checking for proper burner cap placement	11
Using the griddle (some models)	11
Setting Surface Controls	12
Setting a surface burner	12
Home canning	12
Oven Controls Functions	13
Setting Oven Controls	14-28
Setting the clock	14
Changing between 6-Hour Energy Saving feature or continuous bake setting	14
Setting 12 or 24 hour display modes	14
Changing oven temperature display mode	15
Setting for audible or silent keypad operation	15
Setting oven lock	15
Setting the timer	16
Add a minute feature	16
Quick preheat	16
Bake	17
Bake time	17
Delay start	18
Convect bake	19
Convect roast	19
Convect convert	20
Probe	20-23
Broil	24
Setting pizza feature	25
Setting keep warm	25
Adjusting oven temperature	26
Restoring to factory default settings	26
Operating oven light	26
Setting the Sabbath mode feature	27-28
Self-Cleaning	29-31
Care & Cleaning	32-35
Cleaning recommendation table	32
Cleaning the cooktop and surface burners	33-34
Replacing the oven light	34
Removing & replacing oven door	35
Before You Call - Solutions to common problems. 36-39	
Appliance Warranty	back cover

Thank you for choosing **Frigidaire**.

This Use & Care Guide is part of our commitment to customer satisfaction and product quality throughout the service life of your new appliance. We view your purchase as the beginning of a relationship. To ensure our ability to continue serving you, please use this page to record important product information.

Need help??

Visit the Frigidaire web site at www.frigidaire.com
Before you call for service, there are a few things you can do to help us serve you better.

Read this Use & Care manual.

It contains instructions to help you use and maintain your range properly.

If you received a damaged range ...

immediately contact the dealer (or builder) that sold you the range.

Save time and money.

Check the section "Before You Call". This section helps step you through some common problems that might occur. If you do need service, help is only a phone call away. Call Frigidaire Customer Services at **1-800-944-9044**.

Product Registration

Registering your product with Frigidaire enhances our ability to serve you. You can register online at **www.frigidaire.com** or by dropping your Product Registration Card in the mail.

Serial plate location

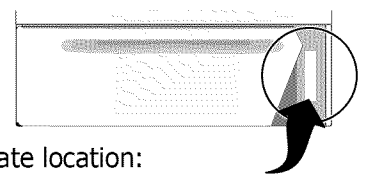

Serial plate location:
open storage drawer (some models) or
remove lower front panel (some models).

Record model & serial numbers here

Purchase date

Model number

Serial number

Be sure to visit us online at
www.frigidaire.com
for a complete line of accessories.

IMPORTANT SAFETY INSTRUCTIONS

Read all instructions before using this appliance.

Do not attempt to install or operate your appliance until you have read the safety precautions in this manual. Safety items throughout this manual are labeled with a WARNING or CAUTION statement based on the risk type.

Definitions

⚠ This is the safety alert symbol. It is used to alert you to potential personal injury hazards. Obey all safety messages that follow this symbol to avoid possible injury or death.

⚠ WARNING

WARNING indicates a potentially hazardous situation which, if not avoided, may result in death or serious injury.

⚠ CAUTION

CAUTION indicates a potentially hazardous situation which, if not avoided, may result in minor or moderate injury.

➡ IMPORTANT

IMPORTANT indicates installation, operation, maintenance or valuable information that is not hazard related.

Important Safety Instructions

- **Remove all tape and packaging before using the range.** Destroy the carton and plastic bags after unpacking the range. Never allow children to play with packaging material.
- **Proper Installation—Be sure your appliance is properly installed and grounded by a qualified technician in accordance with the National Fuel Gas Code ANSI Z223.- latest edition, or in Canada CAN/CGA B149.1, and CAN/CGA B149.2, and the National Electrical Code ANSI/NFPA No.70-latest edition, or in Canada CSA Standard C22.1, Canadian Electrical Code, Part 1, and local code requirements.** Install only per installation instructions provided in the literature package for this range. Ask your dealer to recommend a qualified technician and an authorized repair service. Know how to disconnect the power to the range at the circuit breaker or fuse box in case of an emergency.

⚠ WARNING

If the information in this manual is not followed exactly, a fire or explosion may result causing property damage, personal injury or death.

FOR YOUR SAFETY:

- **Do not store or use gasoline or other flammable vapors and liquids in the vicinity of this or any other appliance.**
- **WHAT TO DO IF YOU SMELL GAS:**
 - **Do not try to light any appliance.**
 - **Do not touch any electrical switch; do not use any phone in your building.**
 - **Immediately call your gas supplier from a neighbor's phone. Follow the gas supplier's instructions.**
 - **If you cannot reach your gas supplier, call the fire department.**
- **Installation and service must be performed by a qualified installer, servicer or the gas supplier.**

⚠ WARNING



Tip Over Hazard

- **A child or adult can tip the range and be killed.**
- **Verify the anti-tip device has been installed to floor or wall.**
- **Ensure the anti-tip device is re-engaged when the range is moved to floor or wall.**
- **Do not operate the range without the anti-tip device in place and engaged.**
- **Failure to follow these instructions can result in death or serious burns to children and adults.**



Range leveling leg

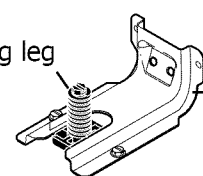

Anti-Tip bracket

To check if the anti-tip bracket is installed properly, use both arms and grasp the rear edge of range back. Carefully attempt to tilt range forward. When properly installed, the range should not tilt forward.

Refer to the anti-tip bracket **installation instructions** supplied with your range for proper installation.

Save these instructions for future reference.

IMPORTANT SAFETY INSTRUCTIONS

WARNING

- **Stepping, leaning or sitting on the door or drawers of a range can result in serious injuries and also cause damage to the appliance.** DO NOT allow children to climb or play around the range. The weight of a child on an open oven door may cause the range to tip, resulting in serious burns or other injury.
- **NEVER use this appliance as a space heater to heat or warm the room. Doing so may result in carbon monoxide poisoning.**
- **NEVER cover any slots, holes or passages in the oven bottom or cover an entire rack with materials such as aluminum foil. Doing so blocks air flow through the oven and may cause carbon monoxide poisoning. Aluminum foil linings may trap heat, causing a fire hazard.**
- **Storage in or on appliance — to avoid a fire hazard, flammable materials should not be stored in an oven, near surface units or in the storage drawer, warmer drawer or lower oven.** This includes paper, plastic and cloth items, such as cookbooks, plasticware and towels, as well as flammable liquids. Do not store explosives, such as aerosol cans, on or near the range.
- **DO NOT LEAVE CHILDREN ALONE — to avoid injuries or burns children should not be left alone or unattended in the area where the range is in use.** They should never be allowed to sit or stand on any part of the range including the storage drawer, lower broiler drawer, lower oven or warmer drawer.

CAUTION

- **Do not store items of interest to children in the cabinets above a range or on the backguard of the range.** Children climbing on the range to reach items could be seriously injured.
- **Do not touch surface burners, areas near these burners, oven burners or interior surfaces of the oven.** Both surface and oven burners may be hot even though flames are not visible. Areas near surface burners may become hot enough to cause burns. During and after use, do not touch, or let clothing or other flammable materials touch these areas until they have had sufficient time to cool. Among these areas are the cooktop, surfaces facing the cooktop, the oven vent openings and surfaces near these openings, oven door and window.

CAUTION

- **Wear proper apparel—loose-fitting or hanging garments should never be worn while using the appliance.** Do not let clothing or other flammable materials contact hot surfaces.
- **Do not use water or flour on grease fires — flour may be explosive. Smother the fire with a pan lid, or use baking soda, a dry chemical or foam-type extinguisher.**
- **When heating fat or grease, watch it closely.** Fat or grease may catch fire if allowed to become too hot.
- **Use dry potholders - moist or damp potholders on hot surfaces may result in burns from steam.** Do not let potholders touch hot heating elements. Do not use a towel or other bulky cloth instead of a potholder.
- **Do not heat unopened food containers - buildup of pressure may cause container to burst and result in injury.**
- Be sure to always have an appropriate foam-type **fire extinguisher** available, visible and easily accessible located near the appliance.
- **Never modify or alter the construction of a range by removing the leveling legs, panels, wire covers, anti-tip bracket/screws, or any other part of the range.**
- **Remove the oven door from any unused range if it is to be stored or discarded.**
- **User servicing — Do not repair or replace any part of the appliance unless specifically recommended in the manuals.** All other servicing should be done only by a qualified technician. This may reduce the risk of personal injury and damage to the range.

IMPORTANT

For electric ignition models only: Do not attempt to operate the range during a power failure. If the power fails, always turn off the range. If the range is not turned off and the power resumes, the range will begin to operate again. Once the power resumes, reset the clock and oven function.

IMPORTANT SAFETY INSTRUCTIONS

IMPORTANT INSTRUCTIONS FOR USING YOUR OVEN

- **Use care when opening oven door , warmer drawer or lower oven door**—Stand to the side of the range when opening the door of a hot oven. Let hot air or steam escape before you remove or replace food in the oven.
- **Keep Oven Vent Ducts Unobstructed.** The oven vent is located below the backguard. Touching the surfaces in this area when the oven is operating may cause severe burns. Also, do not place plastic or heat-sensitive items on or near the oven vent. These items could melt or ignite.
- **Placement of Oven Racks.** Always place oven racks in desired location while oven is cool. If rack must be moved while oven is hot use extreme caution. Use potholders and grasp the rack with both hands to reposition. Do not let potholders contact the hot heating elements in the oven. Remove all utensils from the rack before moving.
- **Do not use the broiler pan without its insert.** The broiler pan and its insert allow dripping fat to drain and be kept away from the high heat of the broiler.
- **Do not cover the broiler insert with aluminum foil. Exposed fat and grease could ignite.**
- **Protective liners**—Do not use aluminum foil to line the oven bottom. Only use aluminum foil as recommended in this manual. Improper installation of these liners may result in risk of electric shock, or fire.

Important Safety Notice

The California Safe Drinking Water and Toxic Enforcement Act requires the Governor of California to publish a list of substances known to the state to cause cancer, birth defects or other reproductive harm, and requires businesses to warn customers of potential exposure to such substances.

IMPORTANT INSTRUCTIONS FOR USING YOUR COOKTOP

WARNING

Use Proper Flame Size—Adjust flame size so it does not extend beyond the edge of the utensil. The use of undersized utensils will expose a portion of the burner flame to direct contact and may result in ignition of clothing. Proper relationship of utensil to flame will also improve efficiency.

- **Know which knob controls each surface burner.** Place a pan of food on the burner before turning it on, and turn the burner off before removing the pan.
- **Always turn knob to the full LITE position when igniting top burners.** Visually check that burner has lit. Then adjust the flame so it does not extend beyond the edge of the utensil.
- **Utensil handles should be turned inward and not extend over adjacent surface burners**—To reduce the risk of burns, ignition of flammable materials, and spillage due to unintentional contact with the utensil, the handle of the utensil should be positioned so that it is turned inward, and does not extend over adjacent surface burners.
- **Never leave surface burners unattended at high heat settings**—Boilovers cause smoking and greasy spillovers that may ignite, or a pan that has boiled dry may melt.
- **Glazed cooking utensils**—Only certain types of glass, glass/ceramic, ceramic, earthenware, or other glazed utensils are suitable for cook top service without breaking due to the sudden change in temperature. Check the manufacturer's recommendations for cook top use.
- **When flaming foods under a ventilating hood, turn the fan on.**
- **Air curtain or other overhead range hoods**, which operate by blowing a downward air flow on to a range, shall not be used in conjunction with gas ranges other than when the hood and range have been designed, tested and listed by an independent test laboratory for use in combination with each other.

IMPORTANT SAFETY INSTRUCTIONS

SELF-CLEANING OVENS

! WARNING

- **Do not touch** the oven during the self-clean cycle.
- Keep children away from oven during self-clean cycle.
- Failure to follow these instructions can result in burns.

- **Clean in the self-cleaning cycle only the parts listed in this Use & Care Manual.** Before self-cleaning the oven, remove the broiler pan and any utensils or foods from the oven.
- **Do not use oven cleaners**—No commercial oven cleaner or oven liner protective coating of any kind should be used in or around any part of the oven.
- **Do not clean door gasket**—The door gasket is essential for a good seal. Care should be taken not to rub, damage or move the gasket.
- The health of some birds is extremely sensitive to the fumes given off during the self-cleaning cycle of any range. Move birds to another well-ventilated room.

IMPORTANT INSTRUCTIONS FOR CLEANING YOUR RANGE

- **Clean the range regularly to keep all parts free of grease that could catch fire.** Pay particular attention to the area around each surface element. Do not allow grease to accumulate.
- **Kitchen cleaners and aerosols**—Always follow the manufacturer's recommended directions for use. Be aware that excess residue from cleaners and aerosols may ignite causing damage and injury.
- **Clean ventilating hoods frequently**—Grease should not be allowed to accumulate on the hood or filter. Follow the manufacturer's instructions for cleaning hoods.

Conversion to Liquefied Petroleum Gas

! WARNING

Personal injury or death from electrical shock may occur if the range is not installed by a qualified installer or electrician. Any additions, changes or conversions required in order for this appliance to satisfactorily meet the application needs **must be made by a qualified technician.**

If your gas range model design allows for L.P. conversion, the L.P. conversion kit may be obtained from your local appliance dealer and should be installed by a qualified service technician. Before installing the kit be sure to follow the L.P. Installation Instructions carefully.

Grounding Instructions

! WARNING

Avoid fire hazard or electrical shock. Do not use an adapter plug, an extension cord, or remove grounding prong from electrical power cord. Failure to follow this warning can cause serious injury, fire or death.

This appliance is equipped with a 3-prong grounding plug for your protection against shock hazard and should be plugged directly into a properly grounded receptacle. **DO NOT** cut or remove the grounding prong from this plug.

For personal safety, the range must be properly grounded. For maximum safety, the power cord must be plugged into an electrical outlet that is correctly polarized and properly grounded.

If a 2-prong wall receptacle is the only available outlet, it is the personal responsibility of the consumer to have it replaced with a properly grounded 3-prong wall receptacle installed by a qualified electrician.

Grounding type wall receptacle

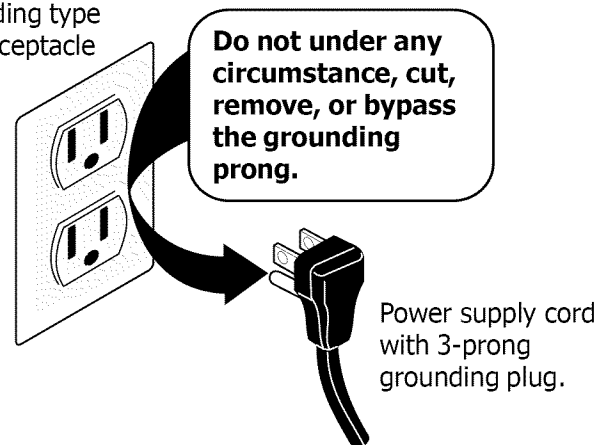

See the **Installation Instructions** packaged with this range for complete installation and grounding instructions.

BEFORE SETTING OVEN CONTROLS

Oven vent location

The oven vent is located below the control panel (Fig. 1). When the oven is heating, warm air passes through this vent. This venting is necessary for proper air circulation in the oven which helps to provide good baking results. **Do not block the oven vent.**

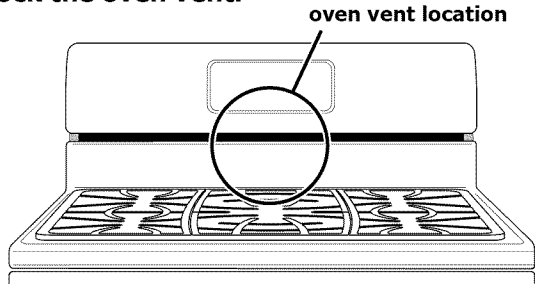

Fig. 1

Oven racks



CAUTION

Always use **oven mitts** to protect hands from possible burns when using the oven or cooktop. The oven, oven racks and cooktop will become **very hot**.



IMPORTANT

Do not remove or attempt to arrange oven racks with cookware still on the racks. To avoid damaging cookware or spilling food items, always remove any cookware first.

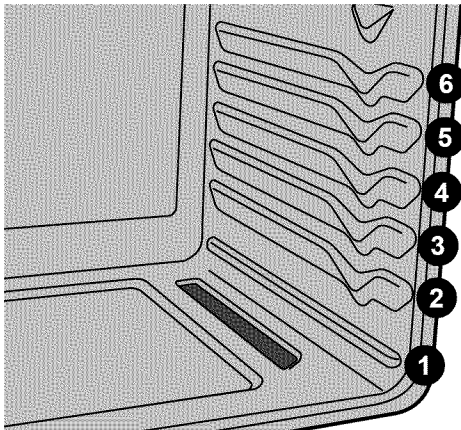

Oven rack positions - Fig. 2

Recommended oven rack positions by food type

Food type	Position
Broiling meats	See broil
Cookies, cakes, pies, biscuits & muffins	3 or 4
Frozen pies, angel food cake, yeast, bread and casseroles	1 or 2
Small cuts of meat or poultry	1 or 2
Turkey, roast or ham	1

Oven rack stop

Most oven racks slide on rack guides provided along the oven cavity sides. The rack guides are curved near the front of each guide. The curve will catch and hold the oven rack stable into a stop position when an oven rack is extended straight out from the oven.

For better access to food items in the oven, **slowly** pull the oven rack straight out to the oven rack stop position (Fig. 3) before checking on food items or removing food dishes from the oven.

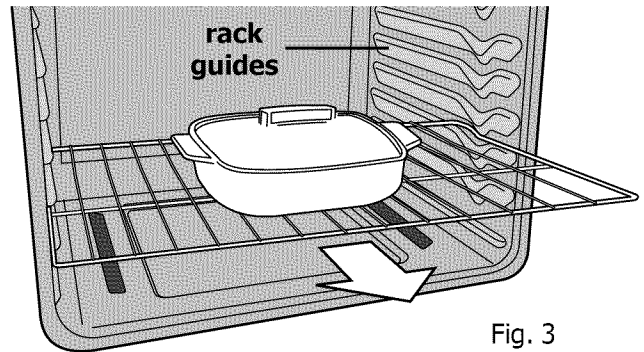

Fig. 3

Removing, replacing & arranging most oven racks types

Arranging - always arrange oven racks when the oven is cool (prior to operating the oven).

To remove - Pull the oven rack straight out until it reaches the stop position. Tilt up front of oven rack to slide past the stop position and pull the rack out of the oven cavity (Fig. 4).

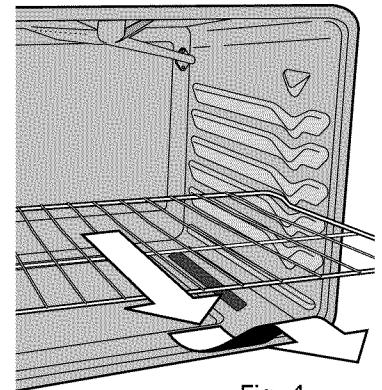

Fig. 4

To replace - Rest the oven rack at the front of a left and right rack guide along the oven walls so that the oven rack rests level. Tilt front of rack upward and slide rack in past the stop position. Then bring the rack to a level position and slide the rack completely inside oven (Fig. 5).

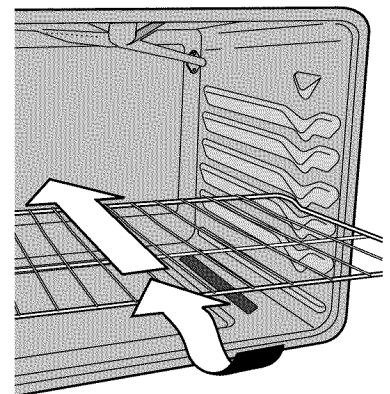

Fig. 5

BEFORE SETTING OVEN CONTROLS

Types of oven racks

Your range may be equipped with one or more of the following oven rack types listed below:

The **flat oven rack** may be used for most cooking needs and may be placed in most rack positions.

The **flat handle oven rack** (some models) may be used for most cooking needs and may be placed in most rack positions. Similar to the flat rack but comes with a handle.

The **offset oven rack** (some models) provides additional stepdown positions from the standard flat rack design. The offset design positions the base of the rack about 1/2 of a rack position lower than the flat rack.

The **half rack** (some models) has a removable section to allow for taller cooking utensils in the oven. When the removable section is in place, the rack may be used like a flat rack.

The **Effortless™ Oven Rack** (some models) instructions are provided later in this section. Be sure to read the important notes.

The **bottom oven rack** (some models) should only be used in the lowest oven rack position. This rack may be used when placing large cuts of meat in the oven.

Air circulation in the oven

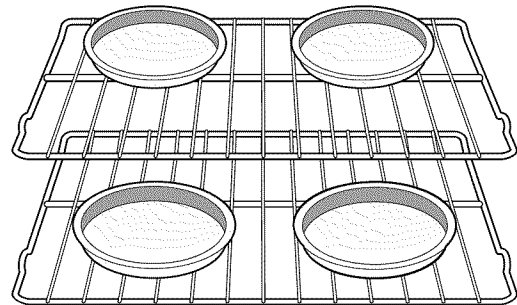

Fig. 1

For best baking results allow 2 to 4 inches (5-10 cm) around the cookware for proper air circulation and be sure pans and cookware do not touch each other, the oven door, sides or back of the oven cavity. For even heating, hot air must be able to circulate freely around the pans and cookware (See Fig. 1).

Baking layer cakes with 1 or 2 oven racks

For best results when baking cakes using 2 oven racks, place cookware on rack in positions 2 & 4. For best results when using a single or an offset oven rack, place cookware on rack in position 2, 3 or 4.

flat oven rack

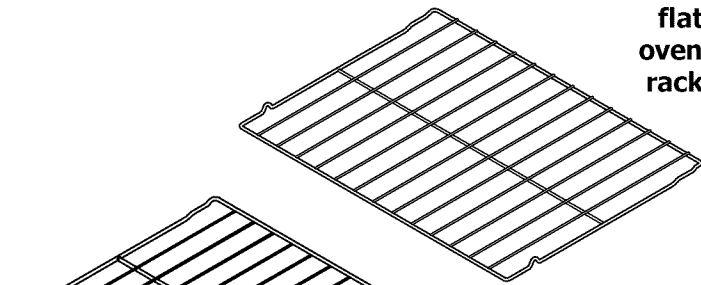

flat handle oven rack
(some models)

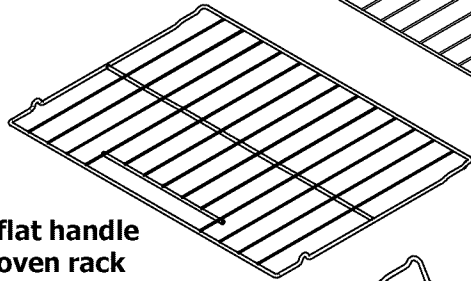

offset oven rack
(some models)

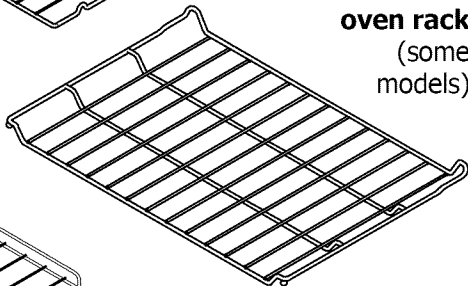

Effortless™ Oven Rack
(some models)

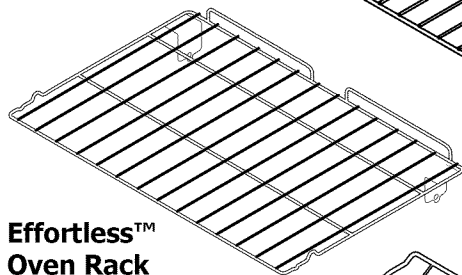

bottom oven rack
(some models)

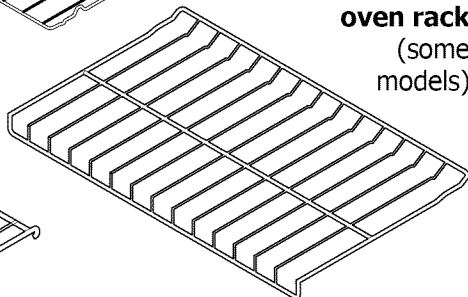

half oven rack with removable shelf
(some models)

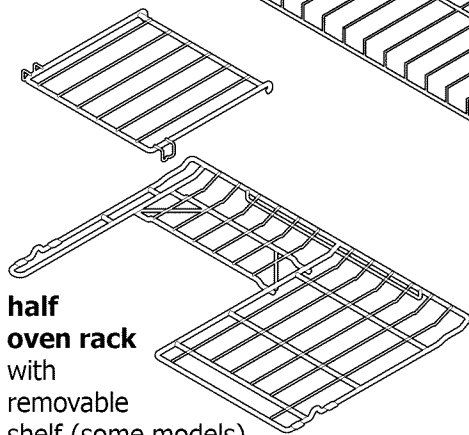

BEFORE SETTING OVEN CONTROLS

Effortless™ Oven Rack system (some models)

Some models are equipped with a special oven rack system that automatically partially extends the oven rack from the interior oven glides to assist in easier access to your food items. This feature works whenever the oven door is opened or closed.

To assemble the Effortless™ Oven Rack system:

1. Locate all required parts. You will need the supplied oven rack (Effortless™ Oven Rack is a flat rack with a special **dark coating** on the **left and right rack sides**) and the 2 supplied chrome connector arms.
2. Open the oven door. Be sure the oven is completely cool before proceeding.
3. Place the oven rack in positions **2, 3 or 4 only**. Be sure the rack connector brackets are at the rear of the range and pointing towards oven bottom (See Fig. 2).
4. Assemble one connector arm at a time. With the oven door open and the oven rack in place, install one end of the connector arm to the hole in the **door connector bracket** (Fig. 1) and the other end in the hole in the **rack connector bracket** (Fig. 2 and as in Fig. 3). The oven rack may need to be adjusted in or out in the rack position to match the length of the connector arm.
5. While holding the connector arm in place, twist the connector arm so the ends of the connector arm point **upwards** (See Figs. 4 & 5). The connector arm should now be locked into position.
6. Repeat steps 4 and 5 for the other connector arm.
7. Once both connector arms are properly in place, be sure to test the oven rack operation by gently closing the oven door. The oven rack should move in and out of the oven freely when the door is opened or closed.

CAUTION

Never pick up hot oven rack parts. Make sure the oven and oven racks are **COMPLETELY** cool and safe to touch before attempting to assemble or disassemble the Effortless™ Oven Rack.

IMPORTANT

Remove ALL oven racks and accessories before starting a self-clean cycle. If the oven racks are left in the oven during self-clean, the glide ability of the Effortless™ Oven Rack system will be damaged and will cause oven racks to lose their shiny finish. Remove **ALL** oven racks and clean according to instructions provided in the Care & Cleaning section of this manual.

IMPORTANT

- **Only the Effortless™ Oven Rack system should be used in oven rack position 2.** Placing ANY other rack in oven rack position 2 **will prevent the oven door from fully closing** and **may damage** the oven door, oven cavity or the door connector brackets.
- If the rack system is not assembled with the connector arms the Effortless™ Oven rack may be used in oven rack positions 2 thru 6. Do not attempt to use the Effortless™ Oven rack in rack position 1.

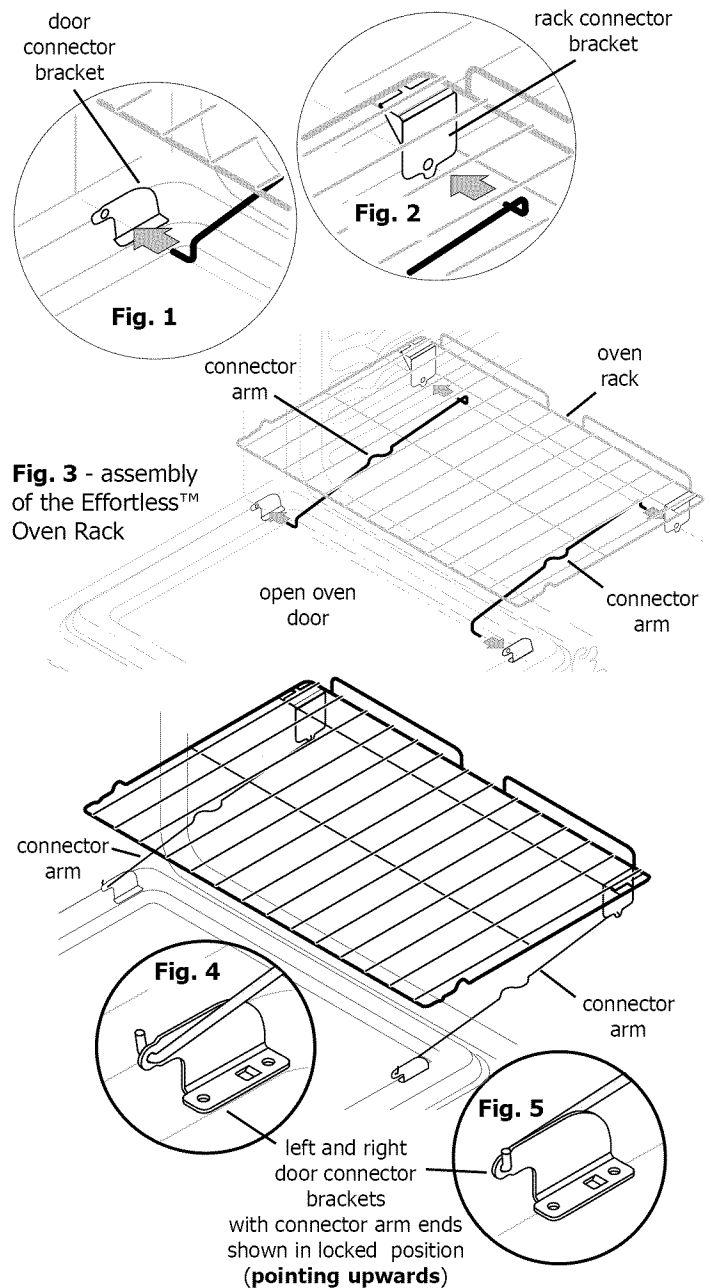

Fig. 6 - Effortless™ Oven Rack after assembly

BEFORE SETTING SURFACE CONTROLS

Before operating the cooktop, check for proper burner cap placement

Visually check for proper burner cap placement **before operating** any of the surface burners (See Fig.1).

WARNING

To prevent flare-ups and avoid creation of harmful by-products, **do not** use the cooktop without all burner caps properly installed to insure proper ignition and gas flame size.

CAUTION

To avoid possible burns **DO NOT** touch burner caps or surface burner grates after using any of the surface burners. The surface burner grates, caps, and areas around them **may still be very hot**. Provide sufficient time for these areas and the parts to completely cool before handling.

If any of the surface burner caps appears to be resting unevenly, not centered or appears unlevel on the burner head (Fig. 2), be sure to correct the burner cap position on the burner head **before** starting the surface burner.

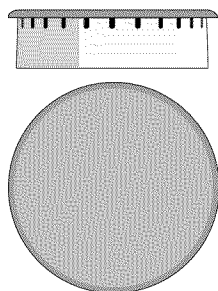

Fig. 1 - correct burner cap placement

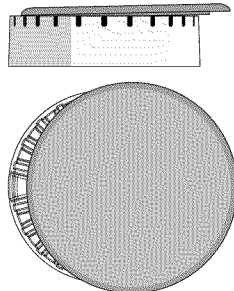

Fig. 2 - incorrect burner cap placement

Be sure to review the **Care & Cleaning** section for complete detailed information about cleaning the burner caps and proper burner cap placement.

Using the griddle (some models)

Before first use:

- Wash griddle in hot soapy water.
- Rinse and dry completely.

Using the griddle:

Remove the center burner grate (some models) and carefully replace with the griddle.

For best results, preheat the griddle for 5 minutes on **medium** or a **medium low** setting. Slow preheating provides more even heat distribution during the cooking process. **Do not** preheat the griddle on Hi setting. Preheating using a Hi burner setting may warp the griddle and prevent even heat distribution.

After each use:

- To prevent possible rusting, store in a dry place and keep uncovered.
- After each use, clean with a stiff brush and hot water only, then rinse.
- Dry immediately.
- **Do not clean griddle in the dishwasher.**

BEFORE SETTING SURFACE CONTROLS

Cookware material types

The most popular materials available are:

Aluminum - Excellent heat conductor. Some types of food will cause it to darken (Anodized aluminum cookware resists staining & pitting).

Copper - Excellent heat conductor but discolors easily.

Stainless - Slow heat conductor with uneven cooking results. Is durable, easy to clean and resists staining.

Cast Iron - A slow heat conductor however will retain heat very well. Cooks evenly once cooking temperature is reached.

Porcelain-enamel on metal - Heating characteristics will vary depending on base material.

Glass - Slow heat conductor.

Use quality cookware in good condition

For the best possible cooking results when using the cooktop, always use quality cookware in good condition. Pans should have flat bottoms that sit level on the burner grate. Before using cookware, check for flatness by rotating a ruler across the bottom of the cookware (Fig. 1).

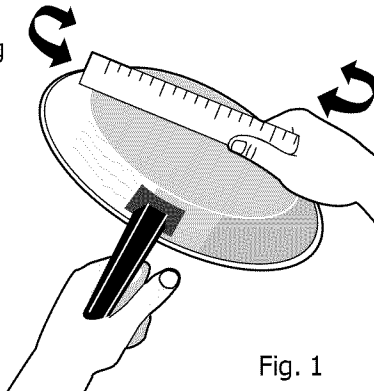

Fig. 1

CAUTION

Do not place flammable items such as plastic wrappings, spoon holders or plastic salt and pepper shakers on the cooktop when it is in use. These items could melt or ignite. Potholders, towels or wooden spoons could catch fire if placed too close to the range cooktop.

IMPORTANT

Do not place aluminum foil, or ANY material that can melt on the range cooktop. If these items melt they may damage the cooktop.

NOTE

The size and type of utensil used, the amount and type of food being cooked will influence the settings needed to obtain the best cooking results.

Set proper burner flame size

The color of the flame is the key to proper burner adjustment. A good flame is clear, blue and hardly visible in a well-lighted room. Each cone of flame should be steady and sharp. Adjust or clean burner if flame is yellow-orange.

For most cooking; start on the highest setting and then turn to a lower setting to complete the process. Use the recommendations below as a guide for determining proper flame size for various types of cooking (Fig. 2)

For deep fat frying; use a thermometer and adjust the surface knob accordingly. If the fat is too cool, the food will absorb the fat and be greasy. If the fat is too hot, the food will brown so quickly that the center will be undercooked. Do not attempt to deep fat fry too much food at once as the food will neither brown or cook properly.

Flame size*	Type of cooking
High flame	Start most foods; bring water to a boil; pan broiling.
Medium flame	Maintain a slow boil; thicken sauces, gravies; steaming.
Low flame	Keep foods cooking; poach; stewing.

*These settings are based for medium-weight metal or aluminum pans with lids. Settings may vary when using other types of pans.

Fig. 2

SETTING SURFACE CONTROLS

Setting surface controls

The ability to heat food quicker and in larger volumes increases as the burner size increases. Your gas appliance may be equipped with many different sized surface burners.

It is important to select cookware that is suitable for the amount and type of food being prepared. Select a burner and flame size appropriate for the cookware size.

The standard size burner or burners may be used for most surface cooking needs. Use the smaller **simmer** burner (some models) when simmering delicate sauces, etc.

The larger **quick boil** (some models) burner or burners are best when used to bring large quantities of liquid to temperature or when heating larger quantities of food.

Setting a surface burner:

1. Place cooking utensil on center of surface burner grate. Be sure the cooking utensil rests stable on the burner grate.
2. Push the desired surface control knob in and turn **counterclockwise** out of the OFF position (Fig. 1).
3. Release the surface control knob and rotate to the **lite** position. Visually check that the burner has a steady gas flame.
4. Once the surface burner has a flame, push the surface control knob in and turn **counterclockwise** to the desired flame size setting. Use the knob markings and adjust the flame as needed.

CAUTION

Do not place flammable items such as plastic wrappings, spoon holders or plastic salt and pepper shakers on the cooktop when it is in use. These items could melt or ignite. Potholders, towels or wooden spoons could catch fire if placed too close to the range cooktop.

IMPORTANT

- **DO NOT** cook with a surface control knob left in the **lite** position. The electronic ignitor will continue to spark. Turn control knob out of **lite** position and adjust the flame size.
- **Do not place aluminum foil, or ANY material that can melt on the range cooktop.** If items melt they may permanently damage the appearance of the cooktop.

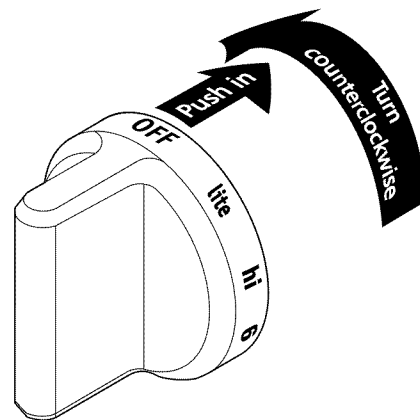

OFF lite hi 6 5 4 3 2 lo

Fig. 1

NOTES

- When setting a surface control knob to the **lite** position, all the electronic surface ignitors will spark at the same time. However, only the surface burner you are setting will ignite.
- In the event of an electrical power outage, the surface burners may be lit manually. To light a surface burner, hold a lit match to the burner head, then slowly turn the surface control knob to **lite**. Once the burner ignites, push in and turn knob out of **lite** then to the desired flame setting. Use caution when lighting surface burners manually.

Home Canning

Be sure to read and observe all the following points when home canning with your appliance. Check with the USDA (United States Department of Agriculture) website and be sure to read all the information they have available as well as follow their recommendations for canning procedures.

- Use only quality flat bottom canners when home canning. Use a straight-edge to check canner bottom.
- Start with hot tap water to bring water to boil more quickly.
- Use the highest heat setting when first bringing the water to a boil. Once boiling is achieved, reduce heat to lowest possible setting to maintain that boil.
- When using two canners at the same time, stagger the canners on the burners. This will allow for better air flow to the burners. Do not block air to the burners.
- **NEVER** place or straddle a cooking utensil over two different surface cooking areas at the same time. This may cause uneven heating results.

OVEN CONTROL FUNCTIONS

READ THE INSTRUCTIONS CAREFULLY BEFORE USING THE OVEN.

For satisfactory use of your oven, become familiar with the various keypad functions as described below.

bake time — Use to enter the length of baking time needed.

timer on•off — Use to set or cancel the minute timer.

bake — Use to set the bake feature.

broil — Use to set broil feature.

convect — Use to set the convect bake or convect roast features.

convect convert — Use to convert a standard bake recipe to a convection bake recipe.

0 thru 9 keypads — Use to enter temperature and times.

delay start — Add to quick preheat, bake, convect, convect convert and self-clean features to program a delay start time or delay start self-cleaning cycle.

self-clean — Use to set a 2, 3 or 4 (some models) hour self-clean cycle.

set clock — Use to set the time of day.

oven light — Use to turn the oven light ON or OFF.

oven lock — Use to activate oven lock setting.

add a minute — Use to add additional minutes to the timer.

probe — Use to set and adjust settings for the probe.

keep warm — Use to set the keep warm feature.

pizza — Use to set the pizza feature.

quick preheat — Use to preheat the oven.

start — Use to activate most oven features (except oven light).

cancel — Use to cancel any oven mode previously set except the oven lock, set clock & timer. Press **cancel** to stop cooking.

Minimum & maximum control settings

The features listed have minimum and maximum time or temperature settings that may be entered or adjusted using the oven control numeric keypads.

Feature	Min. temp. /time	Max. temp. /time
quick preheat temperature setting	170°F / 77°C	550°F / 288°C
bake temperature setting	170°F / 77°C	550°F / 288°C
broil temperature setting	400°F / 205°C	550°F / 288°C
timer	1 min.	11 hrs., 59 mins.
bake time	1 min.	6 hours
delay start	1 min.	11 hrs., 59 mins.
self-clean duration	2 hours	4 hours
convect bake temperature setting (gas)	300°F / 149°C	550°F / 288°C
convect roast temperature setting (gas)	300°F / 149°C	550°F / 288°C
pizza temperature settings (gas)	300°F / 149°C	550°F / 288°C
probe sensor reading	32°F / 0°C	240°F / 116°C
probe target temperature setting	140°F / 60°C	210°F / 98°C

An entry **acceptance tone** (1 beep) will sound each time a keypad is touched (the oven lock keypad tone is delayed 3 seconds).

An entry **error tone** (3 short beeps) will sound if the entry of the temperature or time is below the minimum or above the maximum settings for the feature.

SETTING OVEN CONTROLS

Setting the clock

When the appliance is powered up for the first time or when the electric supply to the appliance has been interrupted, the display will **flash** "12:00" (Fig. 1).



Fig. 1

To set the clock for 1:30:

- | Step | Press |
|----------------------------------|----------------------|
| 1. Press set clock . | set
clock |
| 2. Enter 1 3 0 . | 1 3 0 |
| 3. Press start to accept. | start |

NOTES

- Be sure to set the clock with the correct time of day before using the oven.
- The clock cannot be adjusted when the oven is active with any cooking function or during self-clean.

Changing between 6-Hour Energy Saving or continuous bake mode settings

The oven control is factory preset with to the 6 Hour Energy Saving mode that will automatically turn the oven off after 6 hours. The control may also be programmed to override this feature to continuously bake.

To switch between 6-Hour Energy Saving or continuous bake modes:

- | Step | Press |
|--|---------------------------|
| 1. Press and hold timer on • off for 6 seconds. | timer
on • off |
| 2. Press self-clean to toggle between "6 Hr OFF" (Fig. 2) or "StAY On" (Fig. 3) and release keypad. | self
clean |
| 3. Press start to accept. | start |

Fig. 2

Fig. 3

NOTE

Changing between the 6-Hour Energy Saving or continuous bake mode will not change how the cooktop controls operate.

Setting 12 or 24 hour display mode

The oven control is factory preset to show the time of day with a 12 hour clock. This setting may be changed to provide the time of day with a 24 hour clock.

To set 12 or 24 hour display mode:

- | Step | Press |
|---|-----------------------|
| 1. Press and hold set clock for 6 seconds. | set
clock |
| 2. Press self-clean to toggle between "12 Hr dAY" or "24 Hr dAY" display modes (See Figs. 4 & 5) and release keypad when the mode you prefer is displayed. | self
clean |
| 3. Press start to accept. | start |

Fig. 4

Fig. 5

SETTING OVEN CONTROLS

Changing oven temperature display mode

The oven control is preset to display the oven temperature with Fahrenheit values. The control may be changed to display either Fahrenheit or Celsius temperatures.

To change the temperature display mode:

- | Step | Press |
|--|-------------------|
| 1. Press and hold broil for 6 seconds. | broil |
| 2. Press self-clean to toggle between Fahrenheit or Celsius temperature display modes and release keypad when the mode you prefer is displayed. | self clean |
| 3. Press start to accept. | start |

NOTE

The temperature display mode option cannot be changed when the oven is active with any cooking function or during self-clean.

Setting for audible or silent keypad operation

Normally a beep will sound each time a keypad is pressed. If desired, the control may be set for silent keypad operation.

To switch between audible or silent keypad operation modes:

- | Step | Press |
|---|--------------------|
| 1. Press and hold delay start for 6 seconds. | delay start |
| 2. Press self-clean to toggle between "bEEP On" (Fig. 1) or "bEEP OFF" (Fig. 2). Release keypad when the mode you prefer is displayed. | self clean |
| 3. Press start to accept. | start |



Fig. 1



Fig. 2

NOTE

When the control is set for silent keypad operation the **timer, preheat** and any **end** of cycle or **error** tone alerts will remain audible.

Setting oven lock

The control may be programmed to lock the oven door and lock the oven control keypad operations.

To activate the oven lock feature:

- | Step | Press |
|--|---|
| Press and hold lock keypad for 3 seconds. "door Loc" will appear in the display until the oven door is completely locked. |  |

To cancel the oven lock feature:

- | Step | Press |
|--|---|
| Press and hold lock keypad for 3 seconds. Once the oven door has unlocked the "door Loc" message will no longer display (See Fig. 3). |  |



Fig. 3

NOTES

- To avoid possible damage to the oven door latching mechanism, do not attempt to force open the oven door whenever the **door Loc** message is displayed.
- If a control keypad is pressed when oven lock is active, the oven control may produce an error tone (triple beep) indicating the keypad action requested is not available when the oven lock feature is active.

SETTING OVEN CONTROLS

Timer

The timer helps keep track of cooking times without interfering with the cooking process. The timer may be set for 1 minute up to 11 hours and 59 minutes.

To set the timer for 5 minutes:

- | Step | Press |
|------------------------------------|-----------------------|
| 1. Press timer on•off . | timer on • off |
| 2. Enter 5 minutes. | 5 |
| 3. Press start to activate. | start |

To cancel the timer at any time press **timer on•off**.

When the timer countdown expires, "End" will appear in the display and alert the user with 3 beeps 1 second apart. The alert will continue until the **timer on•off** keypad is pressed.

NOTES

- The timer **does not start or stop** the cooking process. The timer may be started alone or with any other active oven feature.
- The timer will display hours and minutes until 1 hour remains. When less than 1 hour remains, the display will count down in minutes and seconds. Once the timer has less than 1 minute remaining only seconds will display.
- If both the oven and timer are active, the timer information will display by default. To momentarily display information for any other active oven feature, press the keypad once for the active feature.

Add a minute

Use the add a minute feature to set additional minutes to the timer. When the timer is active, each press of the keypad will add one additional minute to the timer.

To add two additional minutes to the timer:

- | Step | Press |
|---|------------------|
| Press add a minute keypad twice. | add a min |

NOTE

If the **add a minute** keypad is pressed once when the timer is inactive, the timer will activate and start counting down from one minute.

Quick preheat

Use this feature to quickly preheat the oven. For best results use when baking with a **single rack only**. A reminder tone will sound indicating when to place the food in the oven. Quick preheat may be set for 170°F (77°C) to 550°F (288°C). The quick preheat default oven temperature is 350°F (177°C).

CAUTION

Always use pot holders or oven mitts when working with a hot oven. When cooking, the oven, oven racks and cooktop will become **hot** enough to cause burns.

To set quick preheat using the default temperature of 350°F:

- | Step | Press |
|---------------------------------|----------------------|
| 1. Press quick preheat . | quick preheat |
| 2. Press start . | start |



To stop quick preheat at any time press **cancel**.

IMPORTANT

Once the oven has fully preheated, the **quick preheat** feature will perform like **bake** and continue to bake until cancelled.

NOTE

bake time and **delay start** settings may be added to quick preheat.

To set quick preheat with oven temperature of 325°F:

- | Step | Press |
|---------------------------------|----------------------|
| 1. Press quick preheat . | quick preheat |
| 2. Enter 3 2 5 . | 3 2 5 |
| 3. Press start . | start |

To stop quick preheat at any time press **cancel**.

SETTING OVEN CONTROLS

Bake

Use the bake feature to prepare most food items when the recipe calls for normal baking. A reminder tone will sound once the oven finishes preheating. Bake may be set for any temperature from 170°F (77°C) to 550°F (288°C). If bake is programmed with no temperature, the control will default to 350°F (177°C).

CAUTION

Always use pot holders or oven mitts when working with a hot oven. When cooking, the oven interior, oven racks and cooktop will become **hot** enough to cause burns.

To set bake with oven temperature of 425°F:

- | Step | Press |
|-------------------------|--------------|
| 1. Press bake . | bake |
| 2. Enter 4 2 5 . | 4 2 5 |
| 3. Press start . | start |



To stop bake at any time press **cancel**.

IMPORTANT

Dark or dull pans absorb more heat than shiny bakeware resulting in dark or overbrowning of foods. It may be necessary to reduce the oven temperature or cook time to prevent overbrowning of some foods. Dark pans are recommended for pies. Shiny pans are recommended for cakes, cookies and muffins.

NOTES

- If bake is active without **bake time** instructions and bake is not cancelled, the oven will continue to bake for 6 hours before automatically turning off.
- A **bake time** instruction may be added even when the bake feature is already active.

Bake time

A bake time setting may be added to most oven baking features. Use the bake time setting to start the oven immediately and to turn off automatically after the set bake time runs out.

To set bake using a default temperature of 350°F and to stop baking after 30 minutes:

- | Step | Press |
|------------------------------------|------------------|
| 1. Press bake time . | bake time |
| 2. Enter 3 0 minutes. | 3 0 |
| 3. Press start . | start |
| 4. Press bake . | bake |
| 5. Press start to activate. | start |

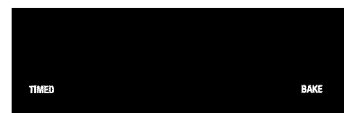

To stop baking at any time press **cancel**.

When the set bake time runs out:

1. "**End**" will appear in the display window and the oven will shut-off automatically.
2. The control will beep 3 times every 30 seconds as a reminder until the **cancel** keypad is pressed.

WARNING

FOOD POISONING HAZARD. Do not let food sit for more than one hour before or after cooking. Doing so can result in food poisoning or sickness.

NOTES

- The maximum **bake time** setting is 6 hours.
- Whenever cooking with bake time settings, press **bake time** keypad once to momentarily display the remaining bake time.
- When bake is active with bake time settings you may remove the bake time instructions at anytime by setting a new bake time of **0:00**.
- **bake time** settings cannot be added when broiling or to the self-clean cycle.
- **bake time** settings may be added to **quick preheat** and the **convect** features.

SETTING OVEN CONTROLS

Delay start

Use this keypad to add delay start time instructions for most timed cooking features or with the self-clean feature.



WARNING

FOOD POISONING HAZARD. Do not let food sit for more than one hour before or after cooking. Doing so can result in food poisoning or sickness.



CAUTION

Use caution when setting **bake time** or **delay start** instructions. Foods that can easily spoil such as milk, eggs, fish, meat or poultry, should be chilled in the refrigerator first. Even when chilled, they should not stand in the oven for more than 1 hour before cooking begins, and should be removed promptly when finished cooking.

To program the oven for delay start and to shut-off automatically (example for baking at 375°F for 50 minutes and to start at 5:30):

Step	Press
1. Press bake time .	bake time
2. Enter 50 minutes.	5 0
3. Press start .	start
4. Press delay start (See Fig. 1).	delay start
5. Enter 530 .	5 3 0
6. Press start .	start
7. Press bake .	bake
8. Enter 375 .	3 7 5
9. Press start to activate.	start

To stop baking with a delay start setting at any time press **cancel**.

When the set bake time runs out:

1. "**End**" will appear in the display window and the oven will shut-off automatically (See Fig. 2).
2. The control will beep 3 times every 30 seconds as a reminder until the **cancel** keypad is pressed.



Fig. 1



Fig. 2



NOTES

- A **delay start** setting may be set with **self-clean**. The self-clean feature will not accept bake time instructions. Refer to the self-clean section for details on how to select different self-clean cycle times.
- The delay start setting may be added to the **quick preheat**, **convect** or **convect convert** features. A delay start setting cannot be added to **broil**.
- Once the **delay start** feature has started the cooking process, press the **bake time** keypad once to display any bake time remaining.

Convect

Benefits of the convection features

- Foods cook more evenly
- Multiple rack baking
- No special pans or bakeware needed

The **convect** feature uses a fan to circulate the oven's heat uniformly around the oven. This improved heat distribution allows for fast, even cooking and browning results. Heated air flows around the food from all sides, sealing in juices and flavors. Convect provides better results when baking using multiple oven racks. Most foods cooked with a bake setting will cook faster and more evenly when using the **convect** features.

Convect bake

Suggestions for convect baking

- For optimum results it is recommended to preheat the oven before baking foods such as cookies, biscuits and breads.
- Reduce the oven temperature 25°F from the recipe's recommended oven temperature. Follow the remainder of the recipe's instructions using the minimum recommended cook time.
- When using 2 oven racks at the same time, place in positions 2 & 4 for best results (Fig. 1).

To set convect bake with a default oven set temperature of 350°F:

Step	Press
1. Press convect .	convect
2. Press start .	start



To stop convect bake at any time press **cancel**.

NOTES

- When using the convect features, any cook time reductions used may need to vary depending on the oven set temperature.
- When baking layer cakes, use the **bake** feature to obtain the best possible results.
- The convect fan will not start until 6 minutes after setting the **convect bake** or **convect roast** features.
- If the oven door is opened when a convect feature is active, the convect fan will stop rotating until the oven door is closed.

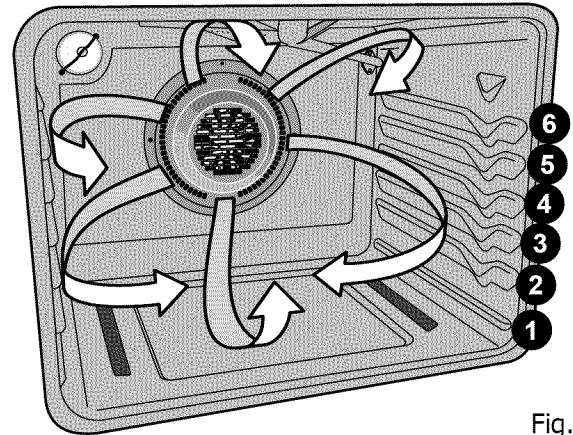

Fig. 1

Convect roast

Suggestions for convect roasting

- Preheating is not necessary when roasting foods using **convect roast**.
- Since **convect roast** cooks faster, reduce cook times by 25% from the recommended time of your recipe (check the food at this time). Then if needed, increase cook time until the desired doneness is obtained.
- Do not cover foods when dry roasting - this will prevent the meat from browning properly.

To set convect roast with a default oven set temperature of 350°F:

Step	Press
1. Press convect .	convect
2. Press convect again.	convect
3. Press start .	start



To stop convect roast at any time press **cancel**.

NOTE

When choosing the different convect features, use the **convect** keypad to toggle between the choices.

SETTING OVEN CONTROLS

Convect convert

The **convect convert** feature allows you to convert any baking recipe for the convect feature. The control uses the normal recipe settings and adjusts to a lower temperature for convection baking. The **convect convert** feature may only be used when convect baking.

To set convect using default oven set temperature of 350°F and adding the convect convert:

Step	Press
1. Press convect keypad.	convect
2. Press convect convert .	convect convert

To stop convect convert at any time press **cancel**.

When convect convert is active with a bake time or a delay start setting, the convect convert feature will display the message "CF" for **check food** when the bake time is 75% complete (See Fig. 1). At this time the oven control will sound 1 long beep at regular intervals until the set bake time has finished.



Fig. 1

NOTES

- When using convect convert, any cook time reductions needed may vary depending on the oven set temperature.
- When baking layer cakes, use the **bake** feature to obtain the best results.
- The convection fan will not start until 6 minutes after setting the **convect convert** feature.
- The minimum **bake time** setting allowed using the **convect convert** feature is 20 minutes.

Probe

Be sure to use the **probe** feature for best results when cooking foods such as roasts, hams or poultry. This feature also works well with other foods such as meat loaf and casseroles.

For some food types, especially poultry and roasts, using a probe to check the internal temperature is the safest possible method to insure properly cooked food.

The **probe** feature, when set correctly, will alert when the internal food temperature reaches the desired "target" temperature.

When active, the probe will display the internal food temperature, eliminating the need for any guesswork.

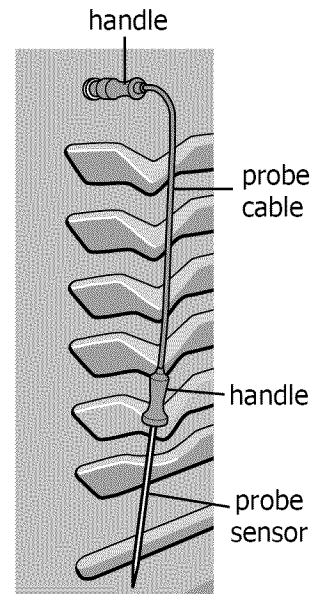

Fig. 2

CAUTION

To avoid the possibility of burns after cooking with the probe, use care when disconnecting the probe from the receptacle or food. **The probe may be hot.** Be sure to always use a pot holder to protect hands.

IMPORTANT

- To avoid damaging the probe, **do not** use kitchen utensils such as tongs to pull on the probe cable or handles. Always insert and remove the probe using the provided handles (See Fig. 2) and always use a pot holder to protect hands from possible burns.
- **Do not** store the probe inside the oven. Always remove the probe from the oven when finished.
- **Use only the original probe** provided with this appliance. Connecting any other probe or device into the probe receptacle could result in damage to the oven control, electronics and the receptacle.
- Before starting **self-clean**, double check that the probe is removed from the oven interior. The high temperatures generated by self-clean may damage or destroy the probe.
- To avoid damaging the probe, defrost frozen foods completely before inserting the probe.

Probe (cont'd)

Proper probe placement in food:

- Always insert the probe so that the probe tip rests inside at the center of the thickest part of meat or food (See Fig. 1). For best results, do not allow the probe temperature sensor to contact bone, fat, gristle or the cookware.
- For bone-in ham or lamb, insert the probe into the center of lowest large muscle or joint. For dishes such as meat loaf or casseroles, insert the probe into center of food. When cooking fish, insert meat probe just above the gill.
- For whole poultry or turkey, fully insert the probe sensor into the thickest part of inner thigh, just below the leg (See Fig. 2).

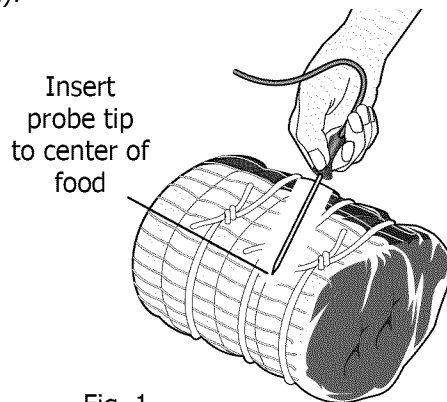

Fig. 1

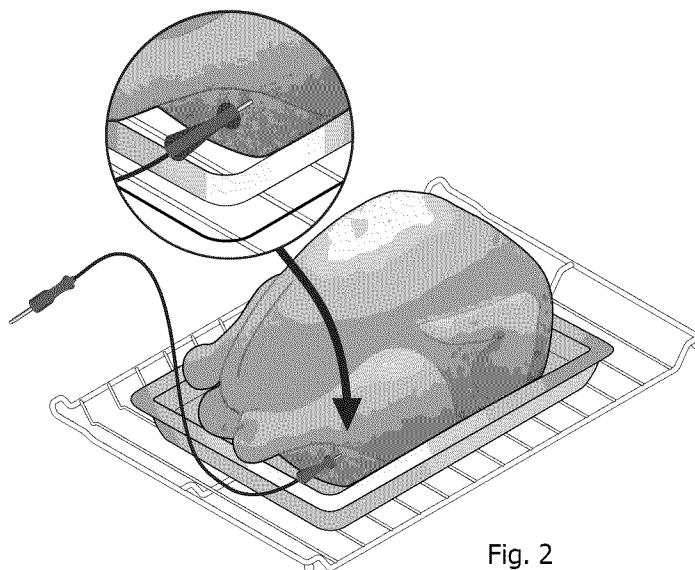

Fig. 2

Choosing a setting for how the oven will operate once the probe reaches the target temperature

Your oven is factory preset to automatically stop cooking and start the keep warm feature once the probe sensor reaches the set target temperature. This setting may be changed to **continue cooking** if desired.

➔ IMPORTANT

Setting the option for how the oven will heat once the probe reaches the target temperature must be done when the oven is inactive. The probe is not required to be connected to the probe receptacle when setting this option.

To set the oven to continue cooking after reaching the target temperature:



1. Press  keypad and hold for 6 seconds.
2. Press  keypad and toggle until the "Continu" message appears (Fig. 3) then press **start** to accept.



Fig. 3

To set the oven to automatically stop cooking and start keep warm once reaching target temperature:



1. Press  keypad and hold for 6 seconds.
2. Press  keypad and toggle until "CANCEL" message appears (Fig. 4) then press **start** to accept.



Fig. 4

SETTING OVEN CONTROLS

Probe (cont'd)

USDA recommended minimum internal cooking temperatures:

Food type	Internal temp.
Ground meat & meat mixtures	
Beef, Pork, Veal, Lamb	160°F (71°C)
Turkey, Chicken	165°F (74°C)
Fresh beef, veal, lamb	
Medium rare†	145°F (63°C)
Medium	160°F (71°C)
Well done	170°F (77°C)
Poultry	
Chicken & Turkey, whole	165°F (74°C)
Poultry Breasts, Roasts	165°F (74°C)
Poultry Thighs, Wings	165°F (74°C)
Duck & Goose	165°F (74°C)
Stuffing (cooked alone or in bird)	165°F (74°C)
Fresh pork	160°F (71°C)
Ham	
Fresh (raw)	160°F (71°C)
Pre-cooked (to reheat)	140°F (60°C)
Eggs & egg dishes	
Eggs	Cook until yolk & white are firm.
Egg dishes	160°F (71°C)
Leftovers & Casseroles	165°F (74°C)

Fig. 1

Information courtesy the U.S. Department of Agriculture Food Safety and Inspection Service.

† The U.S. Department of Agriculture states, "**Rare fresh beef is popular, but you should know that cooking it to only 140°F/60°C means some food poisoning organisms may survive.**" (Source: Safe Food Book, Your Kitchen Guide, USDA Rev. June 1985.)

Visit the U.S. Department of Agriculture Food Safety and Inspection Service website at www.fsis.usda.gov

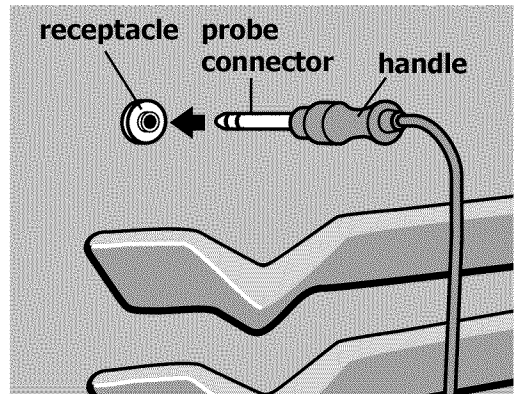



Fig. 2 -

To set probe:

1. Insert the probe into the food.
2. Place prepared food on the desired oven rack position and slide into the oven.
3. Plug the connector end of the probe all the way into the probe receptacle while the oven is still cool. The **receptacle** is located on the upper left front oven cavity wall (Fig. 2).
4. When the probe is detected, an acceptance tone will sound, the  icon will illuminate and the current actual probe temperature will appear in the display (Fig. 3). Close the oven door.

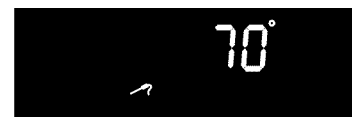



Fig. 3

5. Press  keypad.
6. Enter the desired **target** food temperature using the numeric keypads and set temperature for food type (Refer to Fig. 1). The minimum target setting is 140°F/60°C; the maximum target setting is 210°F/99°C. The default target is 170°F/77°C.
7. Press **start** to accept the target temperature.
8. Set for **quick preheat, bake, convection bake, convection roast or convection convert** and if necessary adjust the oven temperature accordingly.
9. The control will provide 3 beeps when the internal target temperature is reached. By default the oven will automatically change to a **keep warm setting** ("HLd" and the actual probe temperature will alternate in the display). **keep warm** will maintain the oven temperature at 170° F (77°C) for 3 hours unless otherwise cancelled.

To stop cooking at any time press **cancel**.

Probe (cont'd)



Fig. 1

Probe error message:

If the error message "**Pr ob ERR**" displays (Fig. 1), check to be sure that the probe connector is fully inserted into the receptacle. If the probe is fully inserted in the receptacle and the error message continues, the probe may be defective and need replaced.

When "**Pr ob ERR**" displays, the oven control will not permit any oven feature to activate until corrected or the probe is removed. If the error message continues, remove the probe from the receptacle and oven.

"Probe Too Hot" message:

When the message "**Pr ob**" ... "**Too**"... "**Hot**" ... flashes in the display, the probe sensor temperature has exceeded 250°F (121°C). If the probe is not removed this message may continue until the sensor reaches 300°F (149°C) or higher, at which time the oven will automatically turn OFF and display "**Pr ob ERR**" message.

This message may have been generated if the probe **sensor is exposed to direct oven heat** or the food internal temperature is over 250°F (121°C). Be sure the probe sensor is fully covered by the food or if the food is done, press **cancel** and remove food and probe from the oven.

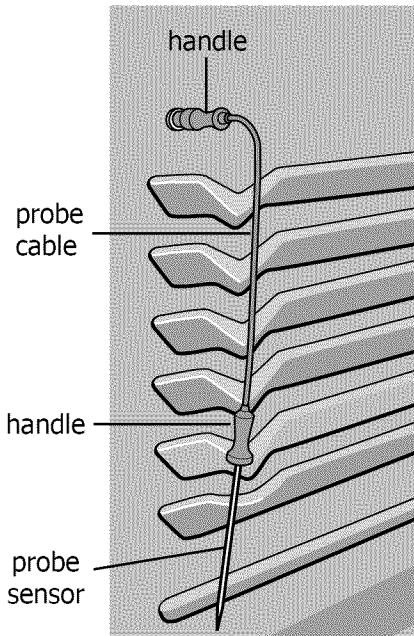



Fig. 2

NOTES

- During the cooking process the internal food temperature will display by default. To review the target temperature press the  keypad once. After 6 seconds the display will revert back to the internal food temperature.
- To assure temperature accuracy, do not remove the probe from the food or receptacle until the desired internal temperature is met.
- If the probe is active and the probe is removed from the receptacle only, the probe feature will cancel but the oven will continue to cook.
- If the probe is active and the probe is removed from the food only, the probe feature will remain active, but the displayed internal food temperature may no longer be reliable. This may eventually generate a "**Probe Too Hot**" message.
- The oven will automatically turn OFF if the probe sensor reaches 300°F (149°C) or more.
- The probe feature cannot be set with **broil** or **self-clean**.
- To change the target temperature while cooking, press the  keypad once. Use the numeric keypads to change the target temperature. Press the **start** keypad to accept any change.

SETTING OVEN CONTROLS

Broil

Use the broil feature to cook meats that require direct exposure to flame heat for optimum broiling results. When broiling, always remember to arrange the oven racks while the oven is still cool.

To set broil:

Step

1. Arrange the oven racks when cool (See Figs. 2 & 4). For optimum browning results, preheat the oven for about 5 minutes before adding food.
2. Be sure to place prepared food directly under upper oven burner.

Close the oven door.

3. Press **broil** (See Fig. 1).
4. Press **start** to activate.
5. Broil food on one side until browned. Turn and broil food on other side.



Fig. 1

To stop broil at any time press **cancel**.



WARNING

Should an oven fire occur, close the oven door and turn the oven OFF. If the fire continues, use a fire extinguisher. **DO NOT** put water or flour on the fire. Flour may be explosive.

Press

broil

start

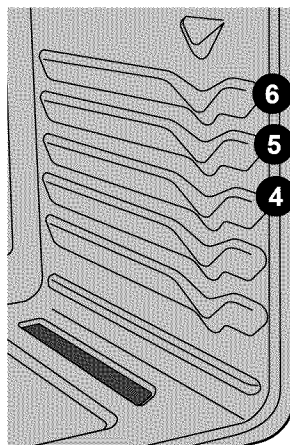

Fig. 2

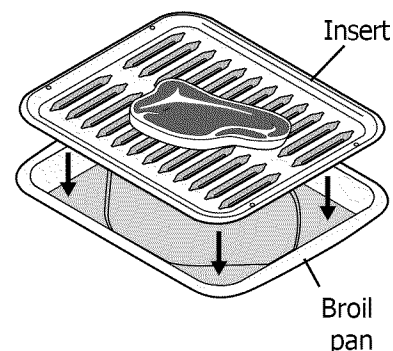

Fig. 3

NOTES

- For better access to food while broiling, use oven mitts and pull the oven rack out to the rack stop position before turning or removing the food.
- If needed, lower the oven temperature to avoid over browning or drying of food items that should be cooked to the well-done stage.
- **bake time** or **start time** instructions cannot be added to the broil feature.
- When broiling the oven control does not provide a preheat indicator or reminder tone when the oven reaches set temperature.
- When broiling with a pan, be sure to use only Electrolux Home Products, Inc. approved broil pan & insert (Fig. 3).

Suggested broil settings table (gas oven)

Food	Rack position	Setting	Cook time in minutes		Doneness
			1st side	2nd side	
Steak 1" thick	5th or 6th*	550°F	8	6	Medium
Steak 1" thick	5th or 6th*	550°F	10	8	Medium-well
Steak 1" thick	5th or 6th*	550°F	11	10	Well
Pork chops 3/4" thick	5th	550°F	12	8	Well
Chicken-bone in	4th	450°F	25	15	Well
Chicken-boneless	5th	450°F	10	8	Well
Fish	5th	550°F	- as directed -	-	Well
Shrimp	4th	550°F	- as directed -	-	Well
Hamburger 1" thick	6th*	550°F	12	10	Medium
Hamburger 1" thick	5th	550°F	14	12	Well

* Use the off-set rack if you choose to use rack position 6.

Fig. 4

SETTING OVEN CONTROLS

Setting pizza feature

For your convenience the pizza feature provides 2 different settings. You may use the pizza feature whether starting with fresh or frozen pizza.

To set the pizza feature:

- | Step | Press |
|--|--------------|
| 1. Press pizza once to cook frozen pizza (Fig.1) or twice when setting for fresh pizza (Fig. 2). You may adjust the oven temperature to fit your needs. | pizza |
| 2. Press start . | start |

To stop pizza feature at any time press **cancel**.



Fig. 1



Fig. 2

NOTES

- Use only one oven rack for best results with the pizza feature.
- The pizza feature is not timed. Be sure to monitor the time needed to finish cooking the pizza. Follow package directions for baking time. Check pizza at the minimum recommended time.
- The preset oven temperature for the frozen pizza setting is 425°F and the fresh pizza is 400°F.

Setting keep warm

The keep warm feature will keep oven cooked foods warm for serving up to 3 hours. After 3 hours the keep warm feature will automatically turn OFF.

The keep warm feature may be used independently. This feature may also be set as a "trailing keep warm".

WARNING

FOOD POISONING HAZARD. Do not let food sit for more than one hour before or after cooking. Doing so can result in food poisoning or sickness.

To set oven for keep warm:

- | Step | Press |
|---|------------------|
| 1. Press keep warm . | keep warm |
| 2. Press start .
"HLd" for hold will appear in the display. | start |

To stop keep warm at any time press **cancel**.

To set to bake for 30 minutes with the default temperature of 350°F; after baking the keep warm feature will automatically activate:

- | Step | Press |
|--|------------------|
| 1. Press bake time . | bake time |
| 2. Enter 3 0 minutes. | 3 0 |
| 3. Press start . | start |
| 4. Press bake . | bake |
| 5. Press start to activate. | start |
| 6. Press keep warm . "HLd" for hold will appear in the display. | keep warm |
| 7. To accept, press start . | start |

NOTES

- Once activated, the **keep warm** feature will automatically turn the oven OFF after 3 hours.
- If a **keep warm** setting is added to bake as a "trailing keep warm" for example, the setting must include bake time instructions.

SETTING OVEN CONTROLS

Adjusting the oven temperature

Your appliance has been factory calibrated and tested to ensure an accurate baking temperature. For the first few uses, follow your recipe times and temperature recommendations carefully. If you think the oven is cooking too hot or too cool for your recipe times, you can adjust the control so the oven cooks hotter or cooler than the temperature displayed.

The oven temperature may be increased +35°F (+19°C) or decreased -35°F (-19°C) from the factory settings.

Example: increase the oven temperature by 30°F:

Step	Press
1. Press and hold bake for 6 seconds.	bake
2. Enter 30.	3 0
3. To accept, press start .	start

Example: decrease the oven temperature by 30°F:

Step	Press
1. Press and hold bake for 6 seconds.	bake
2. Enter 30.	3 0
3. Press self clean .	self clean
4. To accept, press start .	start

NOTES

- Oven temperature adjustments made will not affect the broil or self-clean operating temperatures.
- If the temperature shows an adjustment of -30°F, and a +30°F adjustment is needed, you can toggle between the (-) or (+) in the display by pressing **self clean**.
- Do not use oven thermometers such as those found in grocery stores to check the temperature settings inside your oven. These oven thermometers may vary as much as 20 to 40 degrees from actual temperatures.

Restoring to factory default settings

When new, your appliance was set with preset oven control settings. Over time, the user may make changes to these default settings.

The following features have user program options or adjustments that may have been modified from the factory default settings:

- **12 or 24 hour clock** display mode.
- **6-Hour Energy Savings** or **continuous bake** mode.
- **Silent** or **audible** keypad operation.
- Oven **temperature display** mode (F° or C°).
- Any oven **temperature offset** adjustment made.
- **Temp probe** options (some models).
- Any **stored favorite recipes** (some models).

IMPORTANT

Before restoring the settings, be aware that **all changes** made to the oven control settings will be erased once the start keypad is pressed. This includes any temperature offset made for the oven.

To restore oven control to factory settings:

Step	Press
1. Press and hold 7 keypad until acceptance tone sounds (about 6 seconds).	7
2. To accept, press start .	start

Operating the oven light

The oven light will automatically turn ON when the oven door is opened.

Press  to turn the oven light ON and OFF whenever the oven door is closed.

The oven light is located at the upper left rear wall of the oven interior and is covered with a glass shield held by a wire holder. The glass shield must be in place whenever the oven is in use.

NOTE

The oven light will not operate when self-clean is active. If the oven light is ON when setting self-clean, the oven light will turn off.

SETTING OVEN CONTROLS

To Set the Sabbath Feature (for use on the Jewish Sabbath & Holidays)



For further assistance, guidelines for proper usage and a complete list of models with the Sabbath feature, please visit the web at <http://www.star-k.org>.



WARNING

FOOD POISONING HAZARD. Do not let food sit for more than one hour before or after cooking. Doing so can result in food poisoning or sickness.

The **bake time** and **delay start** keypads are used to set the Sabbath feature. The Sabbath feature may only be used with the **bake** feature. The oven temperature may be set higher or lower after setting the Sabbath feature (oven temperature adjustments should be used only during Jewish Holidays), however the display will not be visible and no audible tones will be provided when a change occurs.

Once the oven is properly set using the **bake** feature with the Sabbath mode active, the oven will remain continuously ON until cancelled. The Sabbath mode will override the factory preset 6-Hour Energy Saving feature.

If the oven light is needed during the Sabbath, turn on the **oven light before** activating the Sabbath feature. Once the oven light is turned on and the Sabbath feature is active, the oven light will remain on until the Sabbath feature is turned OFF. If the oven light needs to be off, be sure to turn the oven light off before activating the Sabbath feature.

It is recommended that any oven temperature change with the Sabbath feature active be followed with 2 presses of the **start** keypad. This will insure the oven remains ON even if the attempt to set the oven temperature was lower or higher than the oven control can accept. If the oven temperature is set incorrectly, the oven temperature will default to 170°F or 550°F. Try to set the desired oven temperature again.

To program the oven for 350°F bake and activate the Sabbath feature:

- | Step | Press |
|---|--------------------------------|
| 1. Be sure that the clock is set with the correct time of day. | |
| 2. Arrange the oven racks. | |
| 3. Press bake . | bake |
| 4. Press start . | start |
| 5. If a bake time or delay start is needed then enter the time in this step. If not, skip this step and continue to step 6. Refer to the bake time or delay start instructions. Remember the oven will shut-off after completing a bake time or delay start and therefore may only be used once during the Sabbath/Jewish Holidays. The maximum delay start time is 11 hours & 59 minutes. | |
| 6. Press and hold both the | bake time + delay start |
| bake time and delay start keypads for at least 3 seconds simultaneously. The control will beep and SAb will appear in the display (See Fig. 1). The oven is properly set for the Sabbath once SAb appears in the display. | |



Fig. 1

SETTING OVEN CONTROLS

To Set the Sabbath Feature (cont'd)

To turn off the oven but keep the Sabbath feature active:

Press **cancel**. cancel

To turn off the Sabbath feature:

Press and hold both the bake + delay
time + start
bake time and delay start pads
for at least 3 seconds. The control will beep and **SAb** will disappear from the display. The oven is no longer programmed for the Sabbath feature.

What to do during a power failure or power interruption after the Sabbath feature was activated:

Should you experience a power failure or interruption, the oven will shut-off. When power is restored the oven will not turn back on automatically. The oven will remember that it is set for the Sabbath and the oven display will show the message "SF" for Sabbath failure (Fig. 1).

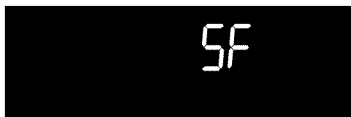

Fig. 1

The food may be safely removed from the oven while still in the Sabbath feature, however the oven cannot be turned back on until after the Sabbath/Holidays.

After the Sabbath observance turn OFF the Sabbath feature. At the same time **press and hold both** the

bake + delay
time + start keypads for at least 3 seconds.

SF will disappear from the display and the oven may be used with all normal functions.

NOTES

- If a delay start time longer than 12 hours (maximum of 24 hours) is desired, set the display mode for the 24 hour setting. For detailed instructions see the section "Setting 12 or 24 hour display modes".
- It is not advised to attempt to activate any other program feature except **bake** while the Sabbath feature is active. ONLY the following keypads will function correctly with the Sabbath feature: **0-9 number keypads, bake, start & cancel**. All other keypads should not be used once the Sabbath feature is active.
- You may change the oven temperature once baking has started. Press **bake**, enter the oven temperature change (170 to 550F°) and press start (for Jewish Holidays only). Remember that the oven control **will no longer beep or display any further changes** once the oven is set for the Sabbath feature.
- If the **keep warm** feature was activated and the Sabbath feature was set the keep warm feature will automatically shut-off the oven off after 3 hours.

Preparing for self-clean

A self-cleaning oven cleans itself using high temperatures that are well above normal cooking temperatures. The self-clean feature, if used properly, will eliminate soils from the oven completely or reduce them to a fine powdered ash. Once the oven has cooled, simply wipe away the ash using a damp cloth.

Your oven provides three self-cleaning duration choices. A 3-hour cleaning time for normal cleaning; a 2-hour clean for lighter soils and a 4-hour option for heavier burnt-on soils (some models).

WARNING

- **Do not touch** the oven during the self-clean cycle.
- Keep children away from oven during self-clean cycle.
- Failure to follow these instructions can result in burns.

CAUTION

The health of some birds is extremely sensitive to the fumes given off during the self-cleaning cycle of any range. Move birds to another well-ventilated room.

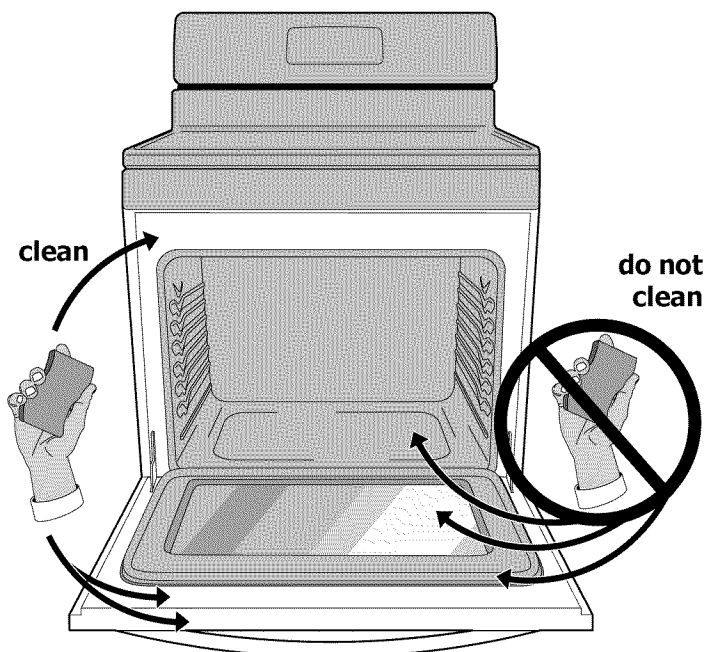

Fig. 1

Read before starting self-clean

IMPORTANT

- Remove **all items** from the oven and cooktop, including **food, cookware, utensils, plastic** and **any aluminum foil** and **probe** (if equipped). Aluminum foil will not withstand high temperatures generated during a self-clean cycle.
- Remove **all oven racks** and **any accessories** from the oven to avoid possible heat damage. If the oven racks are not removed they may discolor. The Effortless™ Oven Rack (some models) must be removed before starting self-clean to avoid damaging the glide ability of the rack.
- Be sure the **oven vent area is clear**.
- Remove **all items** from the storage drawer (some models) or warming drawer (some models).
- Be sure the oven light shield is in place.
- **Remove any excessive spillovers.** Spills on the oven bottom should be wiped-up and removed **before starting self-clean**. To clean, use hot, soapy water and a cloth. Large food spillovers can cause heavy smoke or a fire during self-clean.
- Remove any food spills from oven that have a high sugar or acid content (such as milk, tomatoes, sauerkraut, fruit juices or pie filling) before starting a self-clean cycle. If they are not removed they may leave a dull spot even after self-cleaning.
- Clean any soil from the outer oven frame, the door liner outside the oven door gasket and the small area at the front center of the oven bottom. Clean using soap and water before starting self-clean. These areas (See Fig. 1) heat sufficiently to burn soil on.
- **Do not clean the oven door gasket** (See Fig. 1). Do not use any cleaning materials on the oven door gasket. Doing so could cause damage to the door gasket. The woven material of the oven door gasket is essential for a good seal. Care should be taken not to rub, damage or remove the gasket.
- **Do not** use commercial oven cleaners or protective coatings of any kind inside oven. Residue from oven cleaners may damage the porcelain during the next self-clean cycle.

SELF-CLEANING

Read before starting self-clean (cont'd)

→ IMPORTANT

- It is normal for odors to occur during self-clean, especially during the first self-clean cycle. It is recommended to ventilate the kitchen. Open any windows and if available turn on an exhaust fan or overhead range hood during the self-clean cycle.
- Be aware that during self-clean temperatures inside the oven will become hot enough to melt or destroy some types of materials, including cookware made with materials having a low melting point and **aluminum foil**.

Setting a self-clean cycle

Example: To start an immediate self-clean cycle:

- | Step | Press |
|--|-------------------|
| 1. The oven should be empty and all oven racks removed. Remove all items from the cooktop. Be sure the oven door is completely closed. | |
| 2. Press self clean once for a 3-hour clean time, press self clean twice for 4-hour clean and press 3 times for a 2-hour self-clean cycle time. | self clean |
| 3. Press start to activate. | start |
- Once the door has locked, "CLn" will appear in the display indicating the oven has started heating for the self-clean cycle (Fig. 2).

Press **cancel** at any time to stop self-clean.



door Loc

Fig. 1



CLn

Fig. 2

→ IMPORTANT

After pressing start, the door lock motor will activate. "door Loc" will appear in the display (Fig. 1). **DO NOT** attempt to open the oven door when the "door Loc" message is displayed (allow about 15 seconds for the oven door to completely lock). **DO NOT** force the oven door open. This may damage the automatic door locking system.

⚠ CAUTION

To avoid possible burns use caution when opening the oven door when the self-clean cycle is finished. The oven may still be **VERY HOT**. **Stand to the side of the oven** when opening the door to allow hot air or steam to escape.

When the self-clean cycle is done:

1. The time of day and "Hot" will show in the display (See Fig. 3).
2. Once the oven has cooled (about 1 hour) and "Hot" is no longer displayed the "door OPn" message will appear (Fig. 4). When this message turns off the door is finished unlocking. Use **caution** and avoid possible burns when opening the door after the self-cleaning cycle. The oven may still be **VERY HOT**.



Hot

Fig. 3



door OPn

Fig. 4

📌 NOTES

- Whenever the self-clean feature is active you may check the amount of clean time remaining by pressing the **self clean** keypad once. The oven door will remain locked until the range has cooled sufficiently. You will need to allow about **1 additional hour** to the time displayed before you can open the oven door.
- When the oven is cool, wipe away any residue or powdered ash from the oven interior using a damp cloth or paper towel.

If it becomes necessary to cancel self-clean:

1. Press **cancel** keypad.
2. If the self-clean cycle has heated the oven to a high temperature, the "**Hot**" (Fig. 1) message will show in the display. Allow enough time for the oven to cool and for the "**door OPn**" message to display (Fig. 2). When this message turns off the oven door may be opened.



Fig. 1

Fig. 2

Restarting a self-clean cycle after a power outage:

If a self-clean cycle was interrupted by a power failure, your oven may not have thoroughly cleaned. If so, once power is restored, the oven has cooled and the oven door has unlocked, if needed, set again for self-clean.

Starting another self-clean after cancellation:

If a self-clean cycle was cancelled **using the cancel keypad** before the oven was finished cleaning, you may wish to set for another self-clean cycle.

If self-clean was cancelled shortly after being started, and the oven interior did not reach high self-clean temperatures, the next clean cycle may be set as soon as the oven door unlocks from the cancelled clean cycle.

If the oven became hot enough from the cancelled self-clean cycle, you may be required to wait up to 4 hours before the control will allow another self-clean cycle to start.

NOTE

If attempting to set "back to back" self-clean cycles, the control may display the messages "**CLEAn**", then "**dELAY**" followed by the length of time to wait before the next self-clean may be set. For example, if the message displayed shows "**4:00**", the control will not allow for another self-clean cycle to start for the next 4 hours.

Setting a delay start self-clean cycle

Example: To program a self-cleaning cycle with a delay start time of 9:00 o'clock:

- | Step | Press |
|--|--------------|
| 1. The oven should be empty and all oven racks removed. Remove all items from the cooktop. Be sure the oven door is completely closed. | |
| 2. Press delay start . | delay start |
| 3. Enter 9 0 0 . | 9 0 0 |
| 4. Press start . | start |
| 5. Press self clean once for a 3-hour clean time, press self clean twice for 4-hour clean and press 3 times for a 2-hour self-clean cycle time. | self clean |
| 6. Press start to accept. | start |
- Press **cancel** at any time to stop self-clean.

NOTES

- Check to be sure the oven is **empty** before setting a self-clean cycle using a **delay start** setting. Immediately after setting self-clean with **delay start** the oven door will lock. The self-clean feature will not start heating the oven for cleaning until reaching the delay start time
- The maximum **delay start** setting is 11 hours & 59 minutes.

CARE & CLEANING

Cleaning recommendation table

Surface type	Recommendation
<ul style="list-style-type: none">• Control knobs (some models)• Painted body parts• Painted decorative trim• Aluminum, plastic or vinyl trim	For general cleaning, use hot, soapy water and a cloth. For more difficult soils and built-up grease, apply a liquid detergent directly onto the soil. Leave on soil for 30-60 minutes. Rinse with a damp cloth and dry. Do not use abrasive cleaners on any of these materials; they can scratch. To remove control knobs, turn to OFF position; grasp firmly and pull straight off the shaft. To replace knobs after cleaning, line up the flat sides of both knob and shaft; then push knob into place.
<ul style="list-style-type: none">• Control panel• Control key pad membrane• Decorative trim (some models)	Before cleaning the control panel, turn all controls OFF, activate oven lockout (on some models) and if needed remove any knobs from panel. Do not use abrasive cleaners on any of these materials; they can scratch. Clean using hot, soapy water and a dishcloth. Be sure to squeeze excess water from dishcloth before wiping control panel; especially when wiping around the controls area. Excess water in or around the controls may cause damage to the appliance. When rinsing, use clean water and a dishcloth and be sure to squeeze excess water from dishcloth before wiping the control panel.
<ul style="list-style-type: none">• Easy Care™ Stainless Steel (some models)	If your range finish is Easy Care™ Stainless Steel (some models), clean the stainless with warm soapy water using a clean sponge or cloth. Rinse with clean water and dry with a soft clean cloth. DO NOT use ANY store bought cleaners like Stainless Steel cleaners or any other types of cleaners containing any abrasive, chlorides, chlorines or ammonia. It is recommended to use mild dish soap and water or a 50/50 solution of water and vinegar.
<ul style="list-style-type: none">• Porcelain enamel parts• Porcelain enamel broiler pan and broiler pan insert (if equipped)	Gentle scrubbing with a soapy no-scratch cleaning pad will remove most spots. Rinse with a 1:1 solution of clear water and ammonia. If necessary, cover difficult spots with an ammonia-soaked paper towel for 30 to 40 minutes. Rinse with clean water and a damp cloth, and then scrub with a soap-filled no-scratch cleaning pad. Rinse and wipe dry with a clean cloth. Do not allow food spills with high sugar or acid content (milk, tomatoes, sauerkraut, fruit juices or pie filling) to remain on the surface; they may cause a dull spot even after cleaning.
<ul style="list-style-type: none">• Oven interior	Remove excessive spillovers from oven cavity bottom before starting self-clean . Clean any soils from oven frame and door liner outside the oven door gasket. For very important preparation information be sure to read all the instructions in the self-cleaning section.
<ul style="list-style-type: none">• Oven racks	Oven racks must be removed from oven. Do not clean oven racks in oven during the self-clean cycle. Remove and clean using a mild, abrasive cleaner following manufacturer's instructions. Thoroughly rinse and dry.
<ul style="list-style-type: none">• Oven door	Use soap & water to thoroughly clean the top, sides and front of the oven door. Rinse well. You may use a glass cleaner on the outside glass of the oven door. Do not immerse the door in water. Do not spray or allow water or the glass cleaner to enter the door vents. Do not use oven cleaners, cleaning powders or any harsh abrasive cleaning materials on the outside of the oven door. Do not clean the oven door gasket. On self-cleaning models the oven door gasket is made of a woven material which is essential for a good seal. Care should be taken not to rub, damage or remove this gasket.
<ul style="list-style-type: none">• Cooktop surface, contoured well area, burner heads & burner caps	See "Cleaning the cooktop and surface burners" instructions provided in the Care & Cleaning section.

Cleaning the cooktop and surface burners

CAUTION

To avoid possible burns **DO NOT** attempt the cleaning instructions provided below before turning OFF the surface burners and provide sufficient time for the cooktop and all cooktop parts to cool.

To clean recessed and contoured areas of cooktop

Routinely clean the cooktop. Wipe with a clean, damp cloth and wipe dry to avoid scratches. If a spill occurs on or in the recessed or contoured areas, blot up spill with an absorbent cloth. Rinse with a clean, damp cloth and wipe dry.

To clean burner grates

- Clean when the grates are cool.
- Use nonabrasive plastic scrubbing pad and mild abrasive cleanser.
- Food soils containing acids may affect the finish. Clean immediately after the grates are cool.
- Thoroughly dry grates immediately following cleaning.

To clean burner caps

- Remove caps from burner heads after they have cooled.
- Clean heavy soils with a plastic scrubbing pad and absorbent cloth.
- Thoroughly dry burner caps immediately following cleaning including the bottom and inside of cap.
- Do not use abrasive cleaners. They can scratch porcelain.
- Do not clean burner caps in the dishwasher.
- Check for correct burner cap placement after having removed and replaced the burner caps for cleaning.

Checking for proper burner cap placement

Always check for proper burner cap placement **before operating any surface burner**.

WARNING

To prevent flare-ups and avoid creation of harmful by-products, **do not** use the cooktop without all burner caps properly installed to insure proper ignition and gas flame size.

IMPORTANT

When placing burner caps, be sure that all burner caps are **seated firmly** and rest level on top of burner heads.

Checking for proper burner cap placement (cont'd)

On round style burners, the burner cap lip should fit snug into the center of burner head and rest level (Fig. 1).

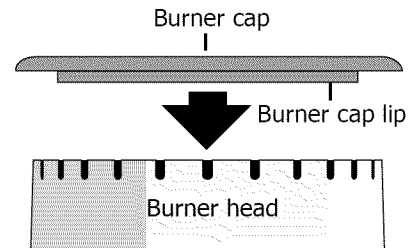

Fig. 1

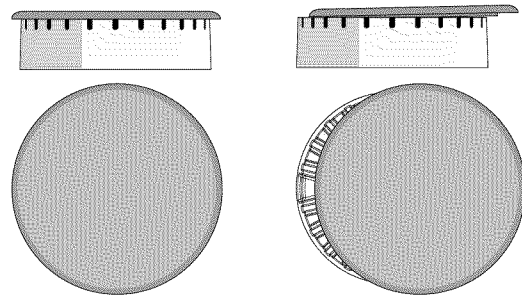
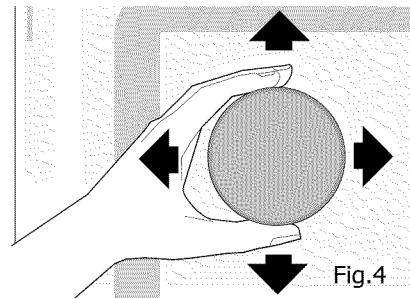

Fig. 2
Correct

Fig. 3
Incorrect



Refer to Figs. 2 & 3 for correct and incorrect burner cap placement. Once in place, you may check the fit by gently sliding the burner cap from side to side (Fig. 4) to be sure it is centered and firmly seated. When the burner cap lip makes contact inside the center of the burner head you will be able to hear the burner cap click. Please note that the burner cap should NOT move off the center of the burner head when sliding from side to side. Check and be sure that all **oval** style (some models) burner caps are correctly in place on oval burner heads.

IMPORTANT

Any additions, changes or conversions required in order for this appliance to satisfactorily meet the application needs must be made by an authorized qualified Agency.

CARE & CLEANING

Cleaning the cooktop and surface burners

CAUTION

To avoid possible burns **DO NOT** attempt any of the cleaning instructions provided below before turning OFF all of the surface burners and allow them to cool.

IMPORTANT

- The burner heads are secured to the cooktop and must be cleaned in place. **DO NOT** remove from cooktop.
- For proper flow of gas and ignition of burners **DO NOT allow spills, food, cleaning agents or any other material to enter the orifice port opening.**

To clean the surface burner heads

For proper gas flow it may be necessary to clean the burner head and slots. To clean, remove burner cap and use a clean DAMP cloth to soak up any excessive spills.

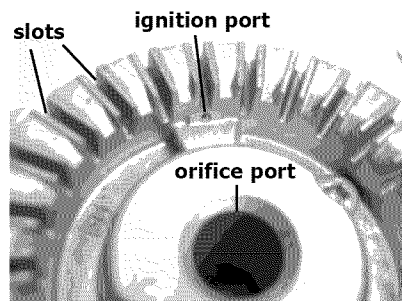

Fig. 1 - Cooktop burner head

Remove any food from between the burner slots using a small nonabrasive brush like a toothbrush. Afterwards wipe up using a damp cloth. For stubborn soils, use a small-gauge wire or needle to clean.

To clean the burner head ignition ports

Each burner head has a small ignition port (Fig. 1). Should you experience ignition problems it may be that this port hole is partially blocked with soil. With the burner head in place, use a small wire gauge needle or the end of a paper clip to clear the ignition port (center burner not shown).

After cleaning the burner heads or ignition ports, be sure to replace the **burner caps properly** on the burner heads. See section "Checking for proper burner cap placement".

Aluminum foil and oven liners

WARNING

NEVER cover any slots, holes or passages in the oven bottom or cover an entire rack with materials such as aluminum foil. Doing so blocks air flow through the oven and may cause carbon monoxide poisoning. Aluminum foil linings may trap heat, causing a fire hazard.

Aluminum foil and oven liners (cont'd)

Do not use oven bottom liners or use aluminum foil to cover the oven bottom or any oven racks.

Using a liner in the oven restricts the heat and air flow needed to obtain the best possible cooking results for any oven, including the warmer drawer (on some models).

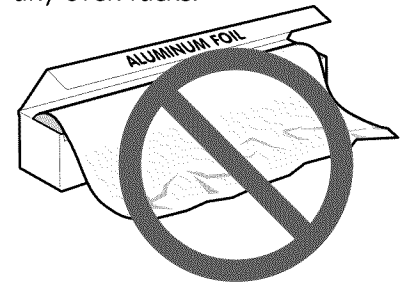

During self-clean the oven temperature can become hot enough to melt aluminum cooking utensils or aluminum foil if left in the oven. This could result in damage to the oven interior porcelain finish.

Replacing interior oven light

CAUTION

Be sure the range is unplugged and all parts are COOL before replacing the oven light. Wear a leather-faced glove for protection against possible broken glass.

The interior oven light is located at the rear of the oven interior back wall and is protected with a glass shield held by a wire holder.

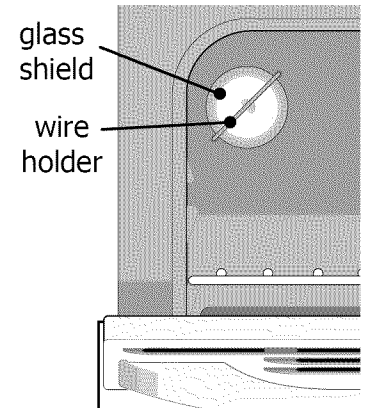

The glass shield should always be in place to protect and shield the oven interior light whenever using the oven.

To replace the interior oven light:

1. Turn electrical power off at the main source or unplug the range.
2. While holding the glass shield in place, press wire holder to one side to release the glass shield.
3. Remove glass shield. Replace bulb with a new 40 watt appliance bulb.
4. Replace glass shield over bulb and snap wire holder into place.
5. Turn power back on again at the main source (or plug the range back in).
6. The clock will need to be reset. To reset review "Setting the clock" section in this manual.

Removing and replacing the lift-off oven door

CAUTION

To avoid possible injury when removing or replacing the oven door, follow the instructions below carefully and always handle the oven door with both hands positioned away from the door hinge areas.

IMPORTANT

The door is heavy. For safe, temporary storage, lay the door flat with the inside of the door facing down.

To remove oven door:

1. Open oven door (horizontal with floor - See Fig. 1).
2. Pull the door hinge locks on both left and right door hinges down from the oven frame completely towards the oven door to unlock (See Fig. 2). A tool such as a small flat-blade screwdriver may be required.
3. Close the door to the broil stop position. The oven door will stop into this position just before fully closing.
4. Firmly grasp both sides of oven door along the door sides (Do not use the oven door handle).
5. With the oven door in the broil stop position (Fig. 3), lift the oven door hinge arms over the roller pins located on each side of the oven frame (See Fig. 4). To avoid damage to oven finish, be careful not to allow the oven door hinges to contact the oven front frame.

To replace oven door:

1. Firmly grasp both sides of oven door along the door sides (Do not use the oven door handle).
2. Holding the oven door at the same angle as the removal position (See Fig. 3), seat the hook of the hinge arm over the roller pins located on each side of the oven door frame (See Fig. 4). The hook of the hinge arms must be fully seated onto the roller pins.
3. Fully open the oven door (horizontal with floor - See Fig. 1).
4. Push the door hinge locks up towards and into the oven frame for both left and right oven door hinges to the lock position (See Fig. 2).
5. Close the oven door.

Special door care instructions - Most oven doors contain glass that can break.

Read the following recommendations:

- DO NOT close the oven door until all the oven racks are fully positioned inside the oven.
- Do not hit door glass with cookware or other objects.
- Scratching, hitting, jarring or stressing the glass may weaken its structure causing an increased risk of breakage at a later time.

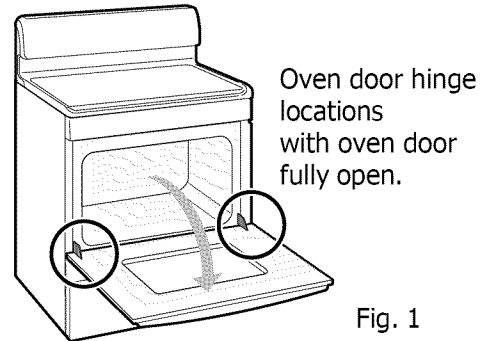

Fig. 1

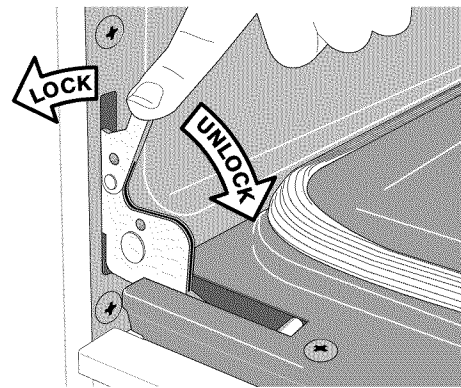

Fig. 2

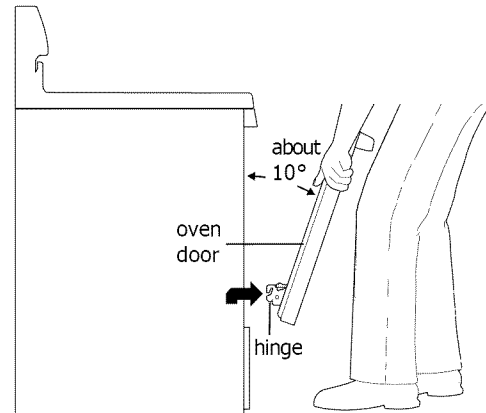

Fig. 3

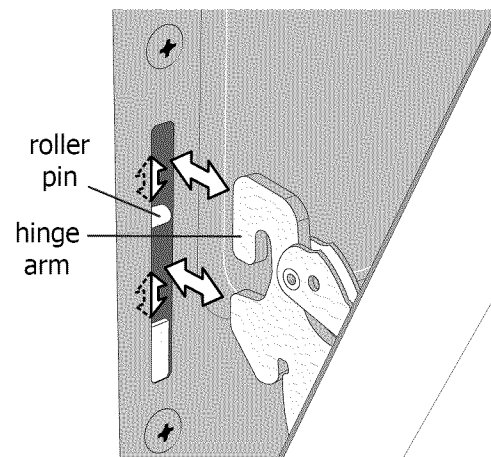

Fig. 4

BEFORE YOU CALL • Solutions to common problems

Problem	Possible Causes	Solutions
Display flashes time.	Power interruption.	Press cancel then set the correct time of day.
Oven control displays F__ (followed with a number) and oven control beeps.	The oven control has detected a fault or error condition.	Press cancel to clear the display & stop beeping. Try bake or broil feature again. If the F code error repeats, remove electric power from appliance, wait 5 minutes and then repower appliance and set clock. Try bake or broil feature again.
	Error condition recurs.	Record fault code and call your authorized service agent.
The oven does not respond or error tone sounds when a keypad is pressed.	Pressed outside keypad area.	Be sure to press center of keypad using flat portion of finger.
	Oven lock may be active.	Cancel the oven lock feature.
	No electric service.	See "Entire appliance does not operate" in this checklist.
New oven cooks hotter or cooler than previous experience.	Difference in oven temperature settings between the old and new range.	For the first few uses, follow your recipe times and temperature recommendation carefully. If you feel the oven is too hot or cool from your previous cooking experience, try adjusting the oven temperature. See "Adjusting the oven temperature" in Setting Oven Controls section.
Odor or some smoking coming from the oven during first few uses.	New appliance.	It is possible to experience some odors and/or a small amount of smoke from a new range. The odor will diminish after first using the oven. Before cooking for the first time, turn the oven ON to 400°F for 30 minutes to one hour. This will allow for an initial burn-in period and help eliminate odors. If necessary, ventilate the kitchen by opening a window.
Appliance makes popping sounds.	Oven expands and contracts while heating and self-clean.	This is normal.
Control panel makes clicking noises.	The oven control is cycling the oven ON and OFF.	This is normal.
Warm air or steam from oven vent area.	Moisture coming from food while cooking in oven.	This is normal. To ensure the best possible results, do not block the oven vent area when cooking.
Poor baking or roasting results.	Incorrect oven control setting.	See Setting Oven Controls section and review instructions for the desired cooking function.
	Oven vent may be blocked.	Clear any cookware or items that is blocking the oven vent area.
	Incorrect cookware type or size.	Dark or dull pans absorb more heat than shiny bakeware resulting in overbrowning of some foods. Try reducing the oven temperature or cook time to prevent overbrowning. Dark pans are recommended for pies; shiny pans for cakes, cookies and muffins.
	Bake started with cold oven.	Try preheating the oven before placing food on oven rack.
	Incorrect oven rack position.	Adjust oven rack position upward or downward as needed.
	Inadequate space around food items or air flow is blocked by oven liner or using aluminum foil as a liner.	Try centering food in oven for single items. When cooking multiple food items space cookware to allow air to circulate completely around the food items. Review "Aluminum foil and liners" in the Care & Cleaning section.
	Oven temperature or time settings.	Try adjusting the recipe's recommended temperature or cooking time. If you still feel the oven is too hot or cool, try adjusting the oven temperature. See "Adjusting the oven temperature" in Setting Oven Controls section.

Problem	Possible Causes	Solutions
Oven portion of appliance does not operate. Gas cooktop burners operate.	Gas regulator shut-off valve may have been moved to OFF at installation.	Be sure gas regulator valve is set to the ON position. See installation instructions.
	Incorrect oven control setting.	Be sure the oven control was set correctly for the requested feature. See Setting Oven Controls section and review instructions for the desired cooking function in this manual or see "Entire appliance does not operate" in this checklist.
Entire appliance does not operate.	Power supply to appliance disconnected or electrical power outage.	Be sure appliance power cord is plugged properly to electrical outlet. Check house circuit breaker; reset if needed. If the electric service to the house is out, call your local electric utility for service.
	Service wiring is incomplete.	Contact your dealer, installing agent or authorized service agent for assistance.
Range is not level.	Floor is not level, weak or unstable.	If floor under range is sagging or sloping, contact a carpenter to correct the problem.
	The cooktop or oven racks are not level.	To correct, place oven rack in center of oven. Place a bubble level centered on the oven rack. Adjust by turning leveling legs at bottom of range until the oven rack rests level.
	Cabinet alignment may make range appear not level.	Be sure kitchen cabinets are square and have sufficient room for appliance clearance.
Cannot move appliance easily. Appliance must be accessible for service.	Gas line is hard-plumbed.	Replace gas supply line with a flexible CSA International approved metal appliance connector.
	Carpet interferes with range.	Provide sufficient space so appliance may be lifted over carpet.
	Cabinets are built in too tightly to appliance sides.	Contact builder or installer to make appliance accessible.
Convect fan makes noise (some models).	The convect fan may turn ON or OFF automatically.	This is normal. On some cooking features the convect fan may run until the feature is done or the oven door is opened.
Convect fan does not start immediately or turns ON and OFF while cooking (some models).	The convect fan start time is delayed.	This is normal. The convect fan will take 6 minutes to begin rotating after starting any convect feature.
	Oven door is open.	The convect fan will turn OFF if the oven door is opened while any convect feature is active. Close oven door.
Convect fan turns on with features that should run without a fan (some models).	The convect fan may turn ON while preheating.	This is normal (on some models).
Oven control displays " Prob ERR ". The probe is not recognized by the oven control.	The probe is not fully inserted into the probe receptacle.	Double check that the temp probe is fully inserted into probe receptacle. Use only the probe originally supplied with range.
	If the error code persists, the probe may be damaged or the probe cable has a short.	Remove the probe from receptacle and oven. The oven may still be used normally without the probe. Call your authorized service agent.

BEFORE YOU CALL • Solutions to common problems

Problem	Possible Causes	Solutions
bake or self-clean did not start at the time expected.	The time of day is incorrect.	Set clock with correct time of day before adding a delay start setting. See "Setting the clock" in Setting Oven Controls section.
Strong odor from range or smells hot.	Self-clean was started for the first times or from a new range.	It is normal for odors to occur during self-clean, especially during the first self-clean cycle. It is recommend to ventilate the kitchen area. Open any windows and if available turn on an exhaust fan or overhead range hood during the self-clean cycle.
Unable to remove items from oven after starting self-clean.	Oven door locks immediately after setting self-clean.	Press cancel to stop self-clean. Wait for the oven door to unlock. Once unlocked, remove any items left in the oven, close the oven door and set for self-clean again.
Oven door did not unlock after the self-clean cycle.	Oven is too hot.	Allow about 1 hour after the self-clean cycle for the oven to cool enough before the oven door will unlock.
Self-clean feature will not start.	Incorrect control setting.	Carefully follow the preparation and programming instructions under Self-cleaning .
	Oven door open.	The oven door must lock before the self-clean cycle will start. Be sure the oven door is closed before starting self-clean.
Self-clean will not restart.	The control has determined oven is still too hot to restart self-clean (some models).	In some cases after cancelling self-clean, you may be required to wait up to 4 hours before the self-clean feature may be used again. Watch display for any messages.
Soil not completely removed after self-cleaning cycle.	Heavy soils. Clean time too short or spillovers were left inside oven.	Set self-clean feature for maximum cleaning time. Remove any excessive spillovers from oven before starting self-clean . Carefully follow preparation instructions under "Self-cleaning".
	Failure to clean soil from the oven frame, the door liner outside the oven door gasket and the small area at the front center of the oven bottom.	These areas are not within the self-cleaning area, but get hot enough to burn on residue. Clean these areas before starting a self-clean cycle. Burned-on residue may be cleaned with a stiff nylon brush and water or a nylon scrubber. Be careful not to damage the oven gasket.
	Interrupted by power outage.	Once power is restored restart self-clean.
Powdered ash inside the oven cavity after self-clean cycle.	This is normal. The temperature of the self-clean feature turned dirt to ash.	Wait for the oven to completely cool. Wipe away any residue or powdered ash from the oven interior using a clean damp cloth or paper towel.
Oven rack finish is dull or discoloring.	Oven racks left inside oven during self-clean.	Remove all racks from oven before starting self-clean. Clean after removing from the oven using a mild, abrasive cleaner following manufacturer's instructions. Thoroughly rinse and dry.
Oven rack no longer slides in or out of oven easily.	Oven racks left inside oven during self-clean.	Remove all racks from oven before starting self-clean. To ease rack movement, remove from oven and clean if needed. Then apply a small amount of vegetable oil to a paper towel and wipe oil on edges of oven racks. Do not use lubricant sprays.

Problem	Possible Causes	Solutions
Oven smokes excessively when broiling.	Oven door was left open.	Be sure oven door is closed when broiling.
	Meat too close to upper burner.	Reposition oven rack lower to provide proper clearance between the food & the upper burner.
	Meat not prepared for broil.	Remove excess fat from meat. Remove fatty edges.
	Insert placed incorrectly on broil pan (some models).	Always place insert on the broil pan with ribs up and slot holes downward. This will allow grease to drip into pan.
	Excessive spillovers or grease built up inside oven.	Regular cleaning is needed when broiling frequently.
Flames inside oven or smoking from oven vent.	Excessive food spillovers in oven.	Wipe up any excessive spillovers before starting the oven. Should an oven fire occur, close the oven door and turn the oven OFF. If the fire continues, use a fire extinguisher. DO NOT put water or flour on the fire! Flour may be explosive.
Surface burners will not ignite.	Surface control knob not set to the lite position.	Push in and turn the surface control knob to the lite position until burner ignites; then turn knob out of the lite position and adjust to desired flame size.
	Burner caps are missing or not seated properly.	Check that all surface burner caps are level and seated correctly on surface burner heads. See "Cleaning the cooktop and surface burners" in the Care & Cleaning section.
	Burner ports are clogged.	With all surface burners turned OFF, use a small-gauge wire or needle to burner head slots and ignition ports. See "Cleaning the cooktop and surface burners" in the Care & Cleaning section for additional cleaning instructions.
	Electric power outage.	If needed, surface burners may be lit manually. See section on Setting Surface Controls .
	Power cord is disconnected.	Plug power cord into the power outlet.
Surface burner flame uneven or only part way around burner cap.	Burner caps are not seated properly.	Check that all surface burner caps are level and seated correctly on surface burner heads. See "Cleaning the cooktop and surface burners" in the Care & Cleaning section.
	Moisture may be present after cleaning.	Lightly fan the flame & allow burner to operate until flame is full. Dry the surface burners thoroughly following the instructions under "Cleaning the cooktop and surface burners" provided in the Care & Cleaning section.
	Burner slots or ports are clogged.	With all surface burners turned OFF, use a small-gauge wire or needle to burner head slots and ignition ports. See "Cleaning the cooktop and surface burners" in the Care & Cleaning section for additional cleaning instructions.
Surface burner flame is too high.	Surface knob is set too high.	Adjust surface control knob to a lower flame setting.
	Burner caps are not seated properly.	Burner caps are not seated properly. Check that all surface burner caps are level and seated correctly on surface burner heads. See "Cleaning the cooktop and surface burners" in the Care & Cleaning section.
Surface burner flame is orange.	Dust particles in gas line.	Allow burner to operate a few minutes until flame turns blue.
	Residence near salt water.	A slightly orange flame may be unavoidable from salt content in air.

MAJOR APPLIANCE WARRANTY

Your appliance is covered by a one year limited warranty. For one year from your original date of purchase, Electrolux will pay all costs for repairing or replacing any parts of this appliance that prove to be defective in materials or workmanship when such appliance is installed, used and maintained in accordance with the provided instructions.

Exclusions

This warranty does not cover the following:

1. Products with original serial numbers that have been removed, altered or cannot be readily determined.
2. Product that has been transferred from its original owner to another party or removed outside the USA or Canada.
3. Rust on the interior or exterior of the unit.
4. Products purchased "as-is" are not covered by this warranty.
5. Food loss due to any refrigerator or freezer failures.
6. Products used in a commercial setting.
7. Service calls which do not involve malfunction or defects in materials or workmanship, or for appliances not in ordinary household use or used other than in accordance with the provided instructions.
8. Service calls to correct the installation of your appliance or to instruct you how to use your appliance.
9. Expenses for making the appliance accessible for servicing, such as removal of trim, cupboards, shelves, etc., which are not a part of the appliance when it is shipped from the factory.
10. Service calls to repair or replace appliance light bulbs, air filters, water filters, other consumables, or knobs, handles, or other cosmetic parts.
11. Surcharges including, but not limited to, any after hour, weekend, or holiday service calls, tolls, ferry trip charges, or mileage expense for service calls to remote areas, including the state of Alaska.
12. Damages to the finish of appliance or home incurred during installation, including but not limited to floors, cabinets, walls, etc.
13. Damages caused by: services performed by unauthorized service companies; use of parts other than genuine Electrolux parts or parts obtained from persons other than authorized service companies; or external causes such as abuse, misuse, inadequate power supply, accidents, fires, or acts of God.

DISCLAIMER OF IMPLIED WARRANTIES; LIMITATION OF REMEDIES

CUSTOMER'S SOLE AND EXCLUSIVE REMEDY UNDER THIS LIMITED WARRANTY SHALL BE PRODUCT REPAIR OR REPLACEMENT AS PROVIDED HEREIN. CLAIMS BASED ON IMPLIED WARRANTIES, INCLUDING WARRANTIES OF MERCHANTABILITY OR FITNESS FOR A PARTICULAR PURPOSE, ARE LIMITED TO ONE YEAR OR THE SHORTEST PERIOD ALLOWED BY LAW, BUT NOT LESS THAN ONE YEAR. ELECTROLUX SHALL NOT BE LIABLE FOR CONSEQUENTIAL OR INCIDENTAL DAMAGES SUCH AS PROPERTY DAMAGE AND INCIDENTAL EXPENSES RESULTING FROM ANY BREACH OF THIS WRITTEN LIMITED WARRANTY OR ANY IMPLIED WARRANTY. SOME STATES AND PROVINCES DO NOT ALLOW THE EXCLUSION OR LIMITATION OF INCIDENTAL OR CONSEQUENTIAL DAMAGES, OR LIMITATIONS ON THE DURATION OF IMPLIED WARRANTIES, SO THESE LIMITATIONS OR EXCLUSIONS MAY NOT APPLY TO YOU. THIS WRITTEN WARRANTY GIVES YOU SPECIFIC LEGAL RIGHTS. YOU MAY ALSO HAVE OTHER RIGHTS THAT VARY FROM STATE TO STATE.

If You Need Service

Keep your receipt, delivery slip, or some other appropriate payment record to establish the warranty period should service be required. If service is performed, it is in your best interest to obtain and keep all receipts. Service under this warranty must be obtained by contacting Electrolux at the addresses or phone numbers below.

This warranty only applies in the USA and Canada. In the USA, your appliance is warranted by Electrolux Major Appliances North America, a division of Electrolux Home Products, Inc. In Canada, your appliance is warranted by Electrolux Canada Corp. Electrolux authorizes no person to change or add to any obligations under this warranty. Obligations for service and parts under this warranty must be performed by Electrolux or an authorized service company. Product features or specifications as described or illustrated are subject to change without notice.

USA
1.800.944.9044
Electrolux Home Products, Inc.
10200 David Taylor Drive
Charlotte, NC 28262



Canada
1.800.265.8352
Electrolux Canada Corp.
5855 Terry Fox Way
Mississauga, Ontario, Canada
L5V 3E4