

Contents

In the Box	2
Speaker controls	2
Charging and battery charge status	4
Checking your battery charge status	4
Charging your speaker	4
Charging another device from your speaker	4
Powering on the speaker	5
Connecting to a source device	5
Connecting through an audio cable	5
Pairing and connecting with another Bluetooth device	5
Disconnecting from another Bluetooth device	6
Reconnecting	6
Clearing all Bluetooth pairings	6
Audio playback	6
Adjusting the volume	6
Playback	6
Taking a phone call - speakerphone mode	7
Taking a call	7
Voice Response mode	7
Customization / other functions	7
Normal and Loud modes	7
Voice prompts: normal, low, off	7
Power Save on / off	8
Resetting the speaker	8
Updating the firmware	8
Care and maintenance	9
Cleaning the core	9
Cleaning the Style and Sport jackets	9
Cleaning the Tough jacket	9
Changing jackets	9
Specifications	9
Optional accessories	11
Remote control	11
Carry Handle	11
Shoulder Strap	11
Pole Strap	11
Customer support	11
FCC and legal notices	11

In the box

- Fugoo XL Bluetooth Speaker, with one jacket –Style, Sport, or Tough
- AC adapter / charger with power cord
- Micro USB cable-- for firmware updates
- 3.5mm audio cable • Accessory pouch • Startup Guide
- Thumbscrews
- Hex wrench– for Tough model only



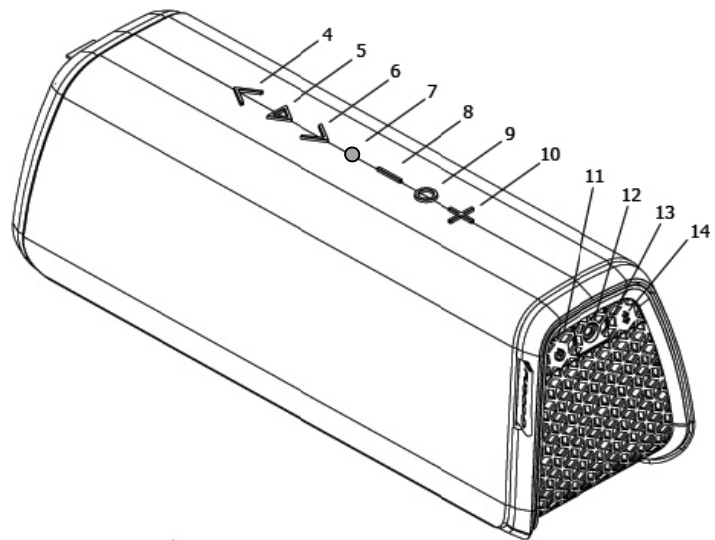
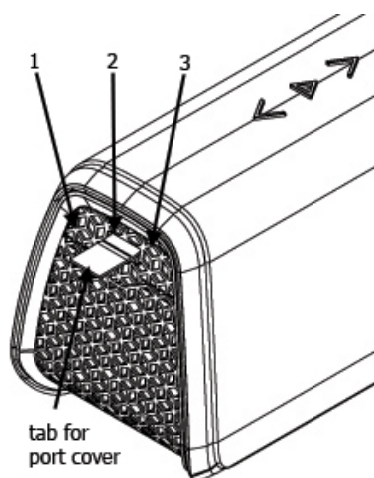



Fugoo XL Bluetooth Speaker controls







Connectors 1, 2, and 3 are behind the port cover.

	part	description
1	Micro-USB connector	For updating the speaker's firmware
2	DC input connector	For charging the speaker
3	USB charge output	For charging other devices
4	Previous track (<)	Skips to the previous track
5	Play / Pause (▶)	Plays / Pauses audio
6	Nexttrack (>)	Skips to the next track
7	Microphone	For speakerphone
8	Volume down button (–)	Decreases loudness
9	Action button (○)	Voice Response and speakerphone control.
10	Volume up button (+)	Increases loudness
11	Power button (⏻)	Turns the speaker on / off
12	3.5 mm audio input jack	For playing music from a headphones output
13	LED indicator	Indicates status of the speaker
14	Bluetooth button (📶)	For pairing with Bluetooth source devices

POWERING UP AND CONNECTIONS







Power On / Off Hold  1 second
Battery status Click 
Pair with a device Hold  3 seconds
Disconnect device Click 
Clear all paired devices Hold  10 seconds
Reset Hold  and  10 seconds

PLAY CONTROL





Play / Pause Click 
Volume up Click 
Volume down Click 
Previous track Click 
Next track Click 

Voice Control Hold  1 second

(The speaker must be off for the following three functions to work.)

Normal / Loud mode Hold  and 
Power Save On / Off Hold  and 
Voice prompts level: Hold  and  and 

SPEAKERPHONE

Answer / end call Click 
Reject a call Double-click 
Mute microphone in a call Click  and 

-
- **CAUTION:** Never use your Fugoo XL Bluetooth Speaker without one of its jackets (Style, Sport, or Tough). The jacket is an essential part of your speaker because it protects the speaker drivers from damage.

-
- **CAUTION:** Never expose the USB ports or the DC input connector to water, or any other liquid. The port cover must always be closed whenever there is any risk of exposing these connectors to liquid. Keep the port cover closed whenever no cables are plugged into the any of the connectors.

- **CAUTION:** Never connect a cable to any of these connectors if they are wet, or are at risk of getting wet.
-

Charging and battery charge status

Checking the battery level

- With the speaker powered on, click the  (Power) button momentarily. The LED indicator blinks green one to six times to indicate the charge status of the battery.
- If voice prompts are enabled, the speaker responds with "Battery is almost full." or another indication of the state of the battery's charge, per the table below.
- If the battery charge gets very low, the LED indicator will blink red, and after several minutes, the speaker will say "Please recharge the battery. Powering off.", and the speaker will turn off.

LED indicator	Voice prompt
six green blinks	Battery is full.
five green blinks	Battery is almost full.
four green blinks	Battery is three quarters.
three green blinks	Battery is half.
two green blinks	Battery is one quarter.
one green blink	Battery is low.

- While the speaker's battery is being charged, the LED will slowly pulse on/off green.
- When the speaker's battery has reached full charge, the LED will glow solid green.

Charging your speaker

- Connect the cable of the supplied AC adapter to the speaker's DC input jack.
- Plug the power cord into the AC adapter.
- Plug the other end of the power cord into an AC power outlet.



Charging another device from your speaker

If you have a smartphone, table or other device that can be charged from a USB port, you can charge it from the Fugoo XL speaker's USB charge out port.

- Connect your other device to the speaker's USB charge port with the USB cable that is supplied with the device.
- The speaker's USB charge port can supply up to 500mA of current, enough to charge most devices that are charged through a USB port.
- The speaker must be either turned on or running from its AC adapter in order to charge other devices.



Powering on your speaker

- Click the  (Power) button momentarily to power the speaker on.
- When the speaker runs from battery power, it will power itself off after a period of inactivity, unless the Power Save feature is Off. (See the Power Save Mode section for further detail.)
- Hold the  (Power) button for one second to turn the speaker off.

Connecting your speaker to smartphones and other devices

You can connect to your Fugoo XL Bluetooth Speaker either through its audio input jack or through a Bluetooth wireless link. Only one of these inputs can be active at a time.

Connecting through an audio cable to the audio input jack

- Connect one end of the supplied 3.5 mm audio cable to your Fugoo Bluetooth Speaker's audio input jack, then connect the other end to the headphones jack of your audio source device.
- The LED glows blue and a voice prompt says, "Disconnected. Bluetooth off. Connected".
- Plugging an audio cable into the speaker's audio input jack turns off the Bluetooth wireless link, to save power and maximize battery life.

Pairing and connecting with another Bluetooth device

1. Make sure that a 3.5 mm audio cable is *not* connected to the speaker's audio input.
2. Place your Fugoo XL Bluetooth Speaker and your other Bluetooth device within 33 feet (10 meters) of each other.
3. Turn the speaker and the other device on.
4. Hold the  (Bluetooth) button for three seconds. The LED blinks blue and red repeatedly. If voice prompts are enabled, the speaker says, "Pairing mode. Use the Bluetooth settings of your device to connect." The speaker will remain in pairing mode for three minutes, or until it pairs with your device.
5. On your other Bluetooth device, turn on Bluetooth, which will allow it to discover the speaker. (See the Bluetooth settings information for your device.)
6. Select 'Fugoo XL Speaker' on your Bluetooth device.
7. Wait briefly for the speaker to discover your Bluetooth device. If voice prompts are enabled, the speaker will say, "Pairing successful" and "Connected".
If you hear "Pairing is unsuccessful. Please try again." Try pairing again.

If you are using an iPhone or an iPad that has been previously paired to the speaker, and all Bluetooth pairings have been cleared, it may be necessary to 'Forget this Device', as follows:

1. Tap Settings.
2. Tap Bluetooth.
3. Tap the  icon to the right of 'Fugoo XL Speaker'.
4. Tap 'Forget this Device'.
5. Tap 'Forget Device'.

As long as the speaker is in pairing mode, the iPhone should find the speaker again, and pair with it.

Disconnecting from another Bluetooth device

To disconnect your Fugoo XL Bluetooth Speaker from a Bluetooth source device, you can:

- Click the  (Bluetooth) button on your speaker.
- Move your speaker and the Bluetooth source device apart until they disconnect.
- Turn off your speaker.
- Turn off the Bluetooth source device.
- Turn off Bluetooth on your Bluetooth source device.
- Plug an audio cable into the speaker's audio input jack.
- Disconnecting temporarily interrupts the Bluetooth wireless link between the speaker and the currently paired source device, which permits the speaker to re-connect with another source device to which it has been previously paired. The disconnected device will still be paired with the speaker, allowing them to automatically reconnect at another time.

Reconnecting

- To reconnect to a Bluetooth source device to which you have previously paired, just turn on the speaker and the source device, and place them within 33 feet (10 meters) of each other.
It's also necessary that no cable be plugged into the audio input jack. Typically, speaker and the source device will reconnect automatically.
- If voice prompts are enabled, the speaker says "Connected".

Clearing all Bluetooth source device pairings



- To clear all of the Bluetooth pairings with source devices, turn the speaker on, and then hold the  (Bluetooth) button for ten seconds, until the speaker says "All Bluetooth pairings cleared. Pairing mode. Please use the Bluetooth settings of your device to connect."

Audio playback

Adjusting the volume

- Click the **+** (Volume up) or **-** (Volume down) buttons to raise or lower the volume.

Playback

- **Play / pause** – Click  (Play / Pause) to toggle playing and pausing your audio.
- **Next track**: click  to skip to the next track of the recording you're listening to.
- **Previous track**: click  to skip to the previous track of the recording you're listening to.

Taking a phone call – Speakerphone mode

Your Fugoo Bluetooth Speaker can act as a speakerphone for your cell phone or smartphone. You can receive and end calls and manage a call on hold.

Taking a call

If you take a call on your phone when it is connected to the speaker, you'll hear it ringing through the speaker.

- Click the **O** (Action) button to receive (pick up) the call.
- Talk and listen through during the call.
- Click **+** or **-** to raise or lower the volume.
- Click **+** and **-** simultaneously to mute / un-mute the microphone.
- Click **O** to end (hang up) the call.
- If you have a call on hold, press **O** to switch back and forth between the two calls.
- Double-click **O** to end the active call and switch to the call on hold.
- Use your phone's controls if you would like to transfer the call from the speaker back to your phone.

Voice Response mode

- While your phone or other device is paired to the speaker (and a call is not in progress) hold **O** (Action) for one second. A tone sounds through the speaker to activate a voice response service, such as Siri, Google Now, or Cortana.
- Speak voice response commands through the speaker's microphone.
- Click **+** or **-** to raise or lower the volume.
- Click the **O** (Action) button to cancel voice response mode.

Customization / other functions

Normal and Loud modes

- There are two loudness modes for your Fugoo XL Bluetooth Speaker. **Normal mode** is the default, and is designed for best overall sound with most types of music. **Loud mode** boosts the maximum loudness level, and is ideal for playing music outdoors, and in large rooms. Both modes employ dynamic realtime equalization to boost the loudness of songs that have been recorded at lower volume levels.
- To switch from one mode to the other, start with the speaker off, then press and hold the Action (**O**) button and press the power button. The speaker will turn on, and announce which mode it's in.

Voice prompts level

- There are three voice prompt levels: Normal, Low and Off. Normal is the default volume level – the level for voice prompts you will hear when you first turn on your Fugoo Bluetooth Speaker. The Low level is about 20% lower than the Normal level.
- To change the voice prompt level from Normal to Low, start with the speaker off, then press and hold the **-** (volume down) and **+** (volume up) buttons, then also press the **⏻** (Power) button for one second. The speaker will turn on, and announce that voice prompts have been set to Low.
- Follow the same steps as above to change the voice prompt level from Low to Off.
- Follow the same steps again to change the voice prompt level from Off to Normal.

Power Save mode On / Off



The speaker can shut itself off to conserve power, after a period of inactivity. Power Save mode can be toggled on and off by holding the –(volume down) button while turning the speaker on with the  (Power) button.

If Power Save mode is on, then the speaker will shut itself off as follows...

- If the speaker is **not connected** to a source device and is **not charging**, the speaker turns off after **15 minutes** of inactivity.
- If the speaker is **not connected** to a source device and is **charging**, the speaker turns off after **30 minutes** of inactivity.
- If the speaker is **connected** to a source device and is **not charging**, the speaker turns off after **1 hour** of inactivity.
- If the speaker is **connected** to a source device and is **charging**, the speaker will not shut off automatically.

If Power Save mode is off, then the speaker will remain on until you turn it off by pressing the  (Power) button for one second.

Resetting the speaker

- If the speaker becomes unresponsive, or behaves differently than you believe it should, try resetting it. Hold the  (Bluetooth) and  (Action) buttons for ten seconds. This will reset the speaker, without clearing its pairing list.
- The speaker can be reset whether it's on or off.

Updating your Fugoo Bluetooth Speaker's firmware

Fugoo posts new versions of the speaker firmware from time to time to add features, improve the sound quality and loudness, and enhance the user interface.

The firmware updates are installed by an Update Utility that is compatible with Windows 8, Windows 7, Windows Vista, Windows XP, and Mac OSX 10.6 and higher.

Please visit the [Start](#) page on our website to download the Update Utility and the latest speaker firmware.

Care and maintenance

Cleaning the core

- After a day at the sandy beach or the muddy trail, remove your speaker core from its jacket and rinse it off with warm water from a sink faucet. Don't use soap, detergents, or any chemical cleaning products. Don't use a garden hose, compressed air, or any other high-pressure stream to clean it, as this may damage the speaker drivers. Don't use a brush of any kind, for the same reason.

Cleaning the Style and Sport jackets

- Remove your sandy or muddy Style or Sport jacket from the speaker core, and rinse it off with warm water from a sink faucet. Don't use a garden hose or any other high-pressure stream to clean it, as this may damage the jacket's fabric covering. Don't use a brush of any kind, for the same reason. Feel free to use soap or detergent.

Cleaning the Tough jacket

- Remove your sandy or muddy Tough jacket from the speaker core, and rinse it off with soap or detergent, and a nylon or natural bristle brush to help remove debris. Never use a metal brush, which may scratch the surface of the jacket.

Changing jackets

You can easily remove the jacket on your speaker, or swap it with another one.

Watch this helpful video **How To:** [Changing Jackets on the Fugoo XL Speakers](#):

- **CAUTION:** Never use your Fugoo XL Bluetooth Speaker without one of its jackets (Style, Sport, or Tough). The jacket is an essential part of your speaker because it protects the speaker drivers from damage.

Specifications

Audio

- Six proprietary, custom-designed acoustic drivers:
 - Four 28mm tweeters
 - Two 62mm woofers
 - Two 105mm x 66mm passive radiators
- Drivers face all directions, with an 8-degree upward tilt for better dispersion
- 25W (12.5W per channel)
- Full-range frequency response: 50Hz - 20KHz
- Supports aptX®, AAC and SBC codecs for high-quality Bluetooth stereo sound

Connectivity

- Bluetooth 4.0 for wireless connectivity up to 33 feet
- Bluetooth Low Energy for link to Fugoo remote control
- Bluetooth Audio/Video Remote Control Profile (AVRCP 1.5) enables control from your audio device and the optional Remote Control.

-
- Other Bluetooth profiles: Advanced Audio Distribution Profile (A2DP) 1.3, Hands-Free Profile (HFP) 1.6, Headset Profile (HSP) 1.2
 - 3.5mm stereo input for wired connection
 - USB type A charging other USB devices
 - Micro USB for firmware updates
 - DC input jack for charging the speaker's battery

Microphone

- Omnidirectional microphone
- Full-duplex capable in speakerphone mode
- Digital signal processor for echo cancellation and noise reduction

Power

- Up to 25 hours continuous play at 50% volume
- Built-in lithium-Ion rechargeable battery
- Charged by 19VDC international AC adapter (included)
- Battery life displayed on devices running iOS 6 and higher

Environmental

- Operating Temp, connected to AC adapter: 32° to 104° F (0° to 40° C)
- Operating Temp, not connected to AC adapter: 32° to 131° F (0° to 55° C)
- Storage Temp: -4° to 140° F (-20° to 60° C)
- IP67 rated: Dustproof and waterproof to 1 meter for 30 minutes

Size & Weight

Speaker core

- 11.34" x 3.89" x 3.38" (288 x 99 x 86mm)
- 3.37lbs (1.53 Kg)

...with Style jacket

- 11.34" x 4.37" x 3.82" (288 x 111 x 97mm)
- 3.97 lbs (1.80 Kg)

...with Sport jacket

- 12.05" x 4.72" x 4.25" (306 x 120 x 108mm)
- 4.32lbs (1.96 Kg)

...with Tough jacket

- 13.19" x 4.65" x 4.37" (335 x 118 x 111mm)
- 4.65lbs (2.11 Kg)

Optional accessories

For more information, visit Fugoo's [Accessories](#) webpage.

Remote Control

Please see the separate **Fugoo Remote Control User Manual**.

Product support

- Visit Fugoo's Support page at support.fugoo.com for help with connecting, to view our FAQs, or to ask us a question.
- Visit Fugoo's downloads page at fugoo.com/downloads, for firmware updates, alternative voice prompts, and mobile wallpaper images,
- Send us a support request at <mailto:support@fugoo.com>.

Legal notices

FCC Statement

This equipment has been tested and found to comply with the limits for a Class B digital device, pursuant to part 15 of the FCC Rules. These limits are designed to provide reasonable protection against harmful interference in a residential installation. This equipment generates uses and can radiate radio frequency energy and, if not installed and used in accordance with the instructions, may cause harmful interference to radio communications. However, there is no guarantee that interference will not occur in a particular installation. If this equipment does cause harmful interference to radio or television reception, which can be determined by turning the equipment off and on, the user is encouraged to try to correct the interference by one or more of the following measures:

- Reorient or relocate the receiving antenna.
- Increase the separation between the equipment and receiver.
- Connect the equipment into an outlet on a circuit different from that to which the receiver is connected.
- Consult the dealer or an experienced radio/TV technician for help.

This device complies with FCC radiation exposure limits set forth for an uncontrolled environment.

This device complies with Part 15 of the FCC Rules. Operation is subject to the following two conditions: (1) this device may not cause harmful interference, and (2) this device must accept any interference received, including interference that may cause undesired operation.

Caution!

Any changes or modifications not expressly approved by the party responsible for compliance could void the user's authority to operate the equipment.

IC Statement

This device complies with Industry Canada licence-exempt RSS standard(s).

Operation is subject to the following two conditions: (1) this device may not cause interference, and (2) this device must accept any interference, including interference that may cause undesired operation of the device.

Le présent appareil est conforme audio CNR d'Industrie Canada applicables audio appareils radio exempts de licence. L'exploitation est autorisée audio deux conditions suivantes : (1) l'appareil ne doit pas produire de brouillage, et (2) l'utilisateur de l'appareil doit accepter tout brouillage radioélectrique subi, même si le brouillage est susceptible d'en compromettre le fonctionnement.

The device meets the exemption from the routine evaluation limits in section 2.5 of RSS 102 and compliance with RSS-102 RF exposure, users can obtain Canadian information on RF exposure and compliance.

Le dispositif rencontre l'exemption des limites courantes d'évaluation dans la section 2.5 de RSS 102 et la conformité à l'exposition de RSS-102 rf, utilisateurs peut obtenir l'information canadienne sur l'exposition et la conformité de rf.

COFETEL

La operación de este equipo está sujeta a las siguientes dos condiciones: (1) es posible que este equipo o dispositivo no cause interferencia perjudicial y (2) este equipo o dispositivo debe aceptar cualquier interferencia, incluyendo la que pueda causar su operación no deseada.