

 FUJIFILM

DIGITAL CAMERA

# *FinePix 6900 Zoom*



**SUPER  
CCD**

Getting Ready

**1**

Basic Photography

**2**

Advanced Features

**3**

Advanced Features  
Playback

**4**

Settings

**5**

PC Connection

**6**

**OWNER'S MANUAL**

This manual will show you how to use your FUJIFILM DIGITAL CAMERA  
FinePix6900 ZOOM correctly. Please follow the instructions carefully.

BL00004-200(1) **E**

**digital**  
Think for the imagination.

## Warning

To prevent fire or shock hazard, do not expose the unit to rain or moisture.

 <b>CAUTION</b> RISK OF ELECTRIC SHOCK DO NOT OPEN
<b>CAUTION :</b> TO REDUCE THE RISK OF ELECTRIC SHOCK, DO NOT REMOVE COVER (OR BACK). NO USER-SERVICEABLE PARTS INSIDE. REFER SERVICING TO QUALIFIED SERVICE PERSONNEL.
The graphical symbols are located on the bottom of the case.

 This symbol is intended to alert the user to the presence of uninsulated "dangerous voltage" within the product's enclosure that may be of sufficient magnitude to constitute a risk of electric shock to persons.

 This symbol is intended to alert the user to the presence of important operating and maintenance (servicing) instructions in the literature accompanying the appliance.

### For customers in the U.S.A.

#### FCC Statement

This device complies with part 15 of the FCC Rules. Operation is subject to the following two conditions : (1) This device may not cause harmful interference, and (2) this device must accept any interference received, including interference that may cause undesired operation.

#### CAUTION

This equipment has been tested and found to comply with the limits for a Class B digital device, pursuant to Part 15 of the FCC Rules. These limits are designed to provide reasonable protection against harmful interference in a residential installation. This equipment generates, uses, and can radiate radio frequency energy and, if not installed and used in accordance with the instructions, may cause harmful interference to radio communications. However, there is no guarantee that interference will not occur in a particular installation. If this equipment does cause harmful interference to radio or television reception, which can be determined by turning the equipment off and on, the user is encouraged to try to correct the interference by one or more of the following measures :

- Reorient or relocate the receiving antenna.
- Increase the separation between the equipment and receiver.
- Connect the equipment into an outlet on a circuit different from that to which the receiver is connected.

— Consult the dealer or an experienced radio/TV technician for help.

You are cautioned that any changes or modifications not expressly approved in this manual could void the user's authority to operate the equipment.

#### Notes on the Grant:

To comply with Part 15 of the FCC rules, this product must be used with a Fujifilm-specified ferrite-core video cable, USB cable, and DC supply cord.

### For customers in Canada

#### CAUTION

This Class B digital apparatus complies with Canadian ICES-003.

Please read the Safety Notes (→P.127) and make sure you understand them before using the camera.

# Contents

Warning	2
Preface	6
Camera Features and Accessories	7
Nomenclature	8
Shutter Speed and Aperture Setting Displays	13

## 1 Getting Ready

ATTACHING THE LENS CAP AND SHOULDER STRAP	14
Using the Lens Cap Holder	15
LOADING THE BATTERY	16
CHARGING THE BATTERY	17
USING THE AC POWER ADAPTER	18
LOADING THE SmartMedia™	19
REMOVING THE SmartMedia™	20
SWITCHING ON AND OFF	21
SETTING THE DATE AND TIME	22

## 2 Basic Photography

TAKING PICTURES (AUTO MODE)	24
Number of Available Frames	29
USING AF/AE LOCK	30
FRAMING GUIDELINE FUNCTION	32
VIEWING YOUR IMAGES (PLAYBACK)	33
FAST FORWARDING IMAGES	34
PLAYBACK ZOOM	35
Saving Trimmed Images	36
MULTI-FRAME PLAYBACK	37
ERASING SINGLE FRAME	38
4 USING A TV MONITOR	40

## 3 Advanced Features

ADVANCED FEATURES	41
■ Photography mode specifications	41
[PHOTOGRAPHY MENU]	
AUTO/SP: SCENE POSITION	42
Portrait	43
Landscape	43
Sports	43
Night Scene	43
Black and white	43
P: PROGRAMMED/S: SHUTTER-PRIORITY	
A: APERTURE PRIORITY	44
Program Shift	45
M: MANUAL	46
Shutter Speed Setting	46
Aperture Setting	47
M: MOVIE	48
FLASH PHOTOGRAPHY	51
AS Auto Flash Mode	52
Red-Eye Reduction	52
Forced Flash	53
Slow Synchro	53
Red-Eye Reduction + Slow Synchro	53
Suppressed Flash	54
MACRO (CLOSE-UP) PHOTOGRAPHY	55
E1: USING AE LOCK	56
EXPOSURE COMPENSATION	57
SETTING THE MANUAL FOCUS	58
One-touch AF Function	59
Focus Check Function	59
DIGITAL ZOOM	60
CONTINUOUS SHOOTING	61

## 4 Advanced Features Playback

ADVANCED PLAYBACK	77
Playback mode menu	77
PLAYBACK INFORMATION	78
MOVIE PLAYBACK	79
Playing Back Movies	80
[PLAYBACK MENU]	
ERASING SINGLE - ALL FRAMES/FORMATTING	81
PLAYBACK (AUTOMATIC PLAYBACK)	83
SETTING AND REMOVING SINGLE FRAME PROTECTION	84
SETTING AND REMOVING PROTECTION FOR ALL FRAMES	86
HOW TO SPECIFY PRINT OPTIONS	88
DPOF DATE SETTING	89
DPOF SET FRAME	90
DPOF REVIEW/RESET	92
DPOF RESET ALL	93

## 5 Settings

SET SET-UP MODE	95
SET USING THE SET-UP SCREEN	96
SET SETTING THE FILE SIZE AND QUALITY (COMPRESSION RATIO)	97
SET IMAGE DISPLAY	98
Preview Zoom	98
Selecting Recorded Images	99
SET AUTO POWER SAVE SETTING	100
SET FRAME NO. MEMORY	101
ADJUSTING THE MONITOR BRIGHTNESS	102

## 6 PC Connection

IN PC CONNECTION	103
CONNECTING TO A PERSONAL COMPUTER	104
DISCONNECTING THE CAMERA FROM YOUR COMPUTER	106
CAMERA CUSTOMIZING	107

System Expansion Options	108
Overview of the Conversion Lens/Adapter Ring	109
Accessories Guide	110
Explanation of Terms	112
Notes on Using Your Camera Correctly	113
Notes on the Power Supply	114
Notes on Using the Battery	114
AC Power Adapter	116
Notes on the SmartMedia™	117
Warning Displays	119
Troubleshooting	122
Specifications	125
Safety Notes	127
EC Declaration of Conformity	131

## Preface

- **Test Shots Prior to Photography**  
For particularly important photography (such as weddings and overseas trips), always take a test photograph and view the image to make sure that the camera is functioning normally.
- **Fuji Photo Film Co., Ltd cannot accept liability for any incidental losses (such as the costs of photography or the loss of income from photography) incurred as a result of faults with this product.**
- **Notes on Copyright**  
Images recorded using your digital camera system cannot be used in ways that infringe copyright laws without the consent of the owner, unless intended only for personal use. Note that some restrictions apply to the photographing of stage performances, entertainments and exhibits, even when intended purely for personal use. Users are also asked to note that the transfer of memory cards containing images or data protected under copyright laws is only permissible within the restrictions imposed by those copyright laws.
- **Liquid Crystal**  
If the LCD monitor or LCD panel is damaged, take particular care with the liquid crystal in the monitor or panel. If any of the following situations arise, take the urgent action indicated.
  - If liquid crystal comes in contact with your skin  
Wipe the area with a cloth and then wash thoroughly with running water and soap.
  - If liquid crystal gets into your eye  
Flush the affected eye with clean water for at least 15 minutes and then seek medical assistance.
  - If liquid crystal is swallowed  
Flush your mouth thoroughly with water. Drink large quantities of water and induce vomiting. Then seek medical assistance.





- **Notes on Electrical Interference**  
If the camera is to be used in hospitals or aircrafts, please note that this camera may cause interference to other equipment in the hospital or aircraft.  
For details, please check with the applicable regulations in that place.
- **Handling Your Digital Camera**  
This camera contains precision electronic components. To ensure that images are recorded correctly, do not subject the camera to impacts or shocks while an image is being recorded.
- **Trademark Information**
  - IBM PC/AT is a registered trademark of International Business Machines Corp. of the U.S.A.
  - Mac and Macintosh are registered trademarks of Apple Computer, Inc.
  - Windows is a registered trademark of the Microsoft Corporation of the U.S.A. registered in the U.S.A. and other countries.  
Windows is an abbreviated term referring to the Microsoft Windows Operating System.
  - SmartMedia is a trademark of Toshiba Corporation.
  - Other company or product names are trademarks or registered trademarks of the respective companies.
- **Explanation of Color Television System**  
NTSC: National Television System Committee, color television broadcasting specifications adopted mainly in the U.S.A., Canada and Japan.  
PAL: Phase Alternation by Line, a color television system adopted mainly by European countries and China.

## Camera Features and Accessories

### Features

- The newly developed "Super CCD" (featuring a total of 3.3 million pixels) used in the FinePix500 ZOOM provides ultra-high resolution image file with 6.03 million (2032 × 2128) pixels.
- 6× optical zoom that uses aspherical lenses for superb optical performance
- Maximum 4.4x seamless Digital Zoom at VGA mode
- 0.55-inch 110,000 pixel Electronic Viewfinder
- The wide range of exposure modes, which includes a manual photography mode, allows you to precisely tailor the photography settings to the conditions.
- Quick, responsive operation with a 3-second startup and as little as 1-second between shots.
- Fast ISO 400 film speed (compared to a standard film speed of ISO 100) and a built-in automatic flash allow shooting in a wider range of situations.
- Hot shoe for synchronizing an external flash unit
- Auto focus with macro photography function (manual focus also available)
- Automatic shooting modes for different types of shots allow settings that are matched to your subject
- Convenient preview function so you can quickly check your shots
- Continuous shooting function even at maximum resolution
- Histogram display function lets you instantly check exposure levels after you take a shot.
- Trimmed recording function saves only that part of the image you want to keep.
- Playback zoom function (up to 16x)
- Multi-level exposure and black-and-white photography functions allow even more scope for photographic expression
- Information button shows a list of the camera settings at one touch whenever you need it
- Magnesium alloy body
- Easy high-speed image file transfer via the USB connection

### Accessories

- SmartMedia (18MB, 33V) (1)  
Supplied with:
  - Anti-static case (1)
  - Index label (1)
- Shoulder strap (1)  

- Lens cap holder (1)  
● Lens cap holder (1)  

- Video Cable (approx. 1.5 m (4.9 ft.), mini-plug (3.5 mm dia.) to plug cable) (1)  

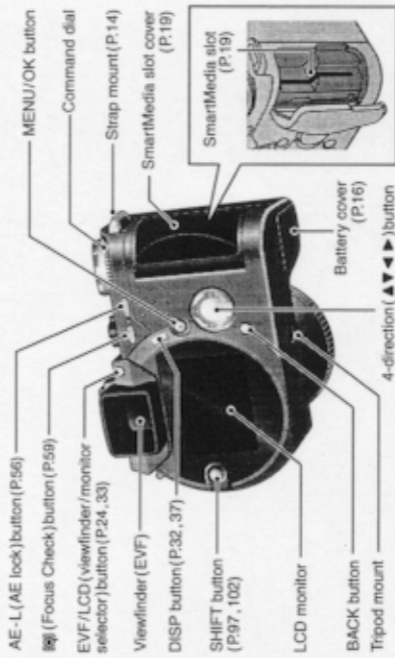
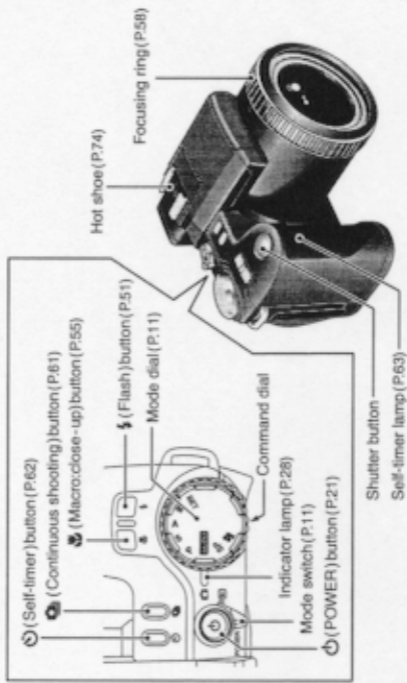
- Interface Set (1)
  - CD-ROM (1)
  - Special USB cable with Noise Suppression core (1)
  - Software Quick Start Guide (1)
- Owner's Manual (this manual) (1)
- NP-80 Rechargeable Battery (1)  

- AC Power Adapter AC-SYS/AC-3VH (approx. 2 m (6.6 ft.) connection cord) (1)  

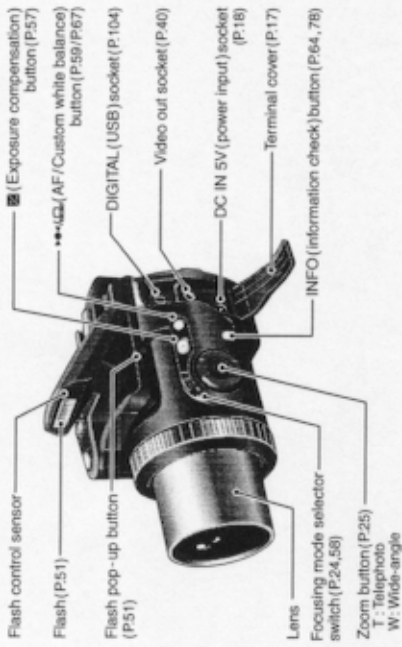
## Nomenclature

\* Refer to the pages in parentheses for more details



## Nomenclature



## Mode switch



## Mode dial

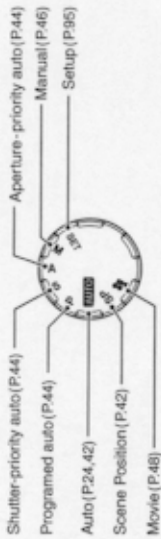

## Nomenclature

### Example of Monitor Text Display : Shooting

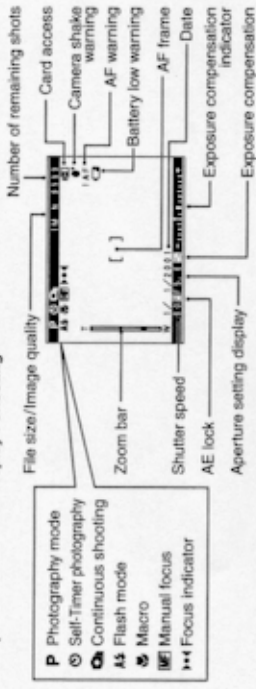

### Example of Monitor Text Display : Playback

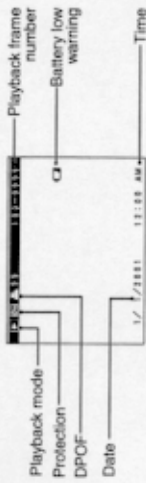

## Shutter Speed and Aperture Setting Displays

If you exceed the control range for a photography mode (as with a scene that is extremely overexposed or underexposed), the shutter speed or aperture is displayed in red on the screen. For dimly lit scenes, "----" is displayed on the screen as the shutter speed and aperture setting. When this occurs, press the shutter button down halfway so that the camera takes the measurements and displays the settings.

### Photography modes and Responses

	Photography mode	Response
Overexposure	<b>Auto</b> (Auto) <b>SP</b> (Scene Position) <b>P</b> (Program)	Use the optional Adapter Ring and ND (Light Adjustment) Filter (→P.109).
	<b>S</b> (Shutter-priority)	Select a faster shutter speed (up to 1/1000 sec.) (→P.44). *
	<b>A</b> (Aperture-priority)	Select a higher aperture setting (up to F11) (→P.44). **
	<b>M</b> (Manual)	Select a faster shutter speed (up to 1/1000 sec.) or a higher aperture setting (up to F11) (→P.46). **
		Use the flash.
Underexposure	<b>Auto</b> (Auto) <b>SP</b> (Scene Position) <b>P</b> (Program)	Select a slower shutter speed (up to 3 sec.) (→P.44). **
	<b>S</b> (Shutter-priority)	Select a lower aperture setting (down to F2.8) (→P.44). **
	<b>A</b> (Aperture-priority)	Select a slower shutter speed (up to 3 sec.) or a lower aperture setting (down to F2.8) (→P.46). **
	<b>M</b> (Manual)	

\*1 If you change the settings and the image is still overexposed, use the optional Adapter Ring and ND (Light Adjustment) Filter (→P.109).

\*2 If the image is underexposed even after you change the shutter speed, use the flash (→P.51).

\*3 If you do not use a flash, the shutter speed will be slow and a tripod should be used.

# 1 Getting Ready

## ATTACHING THE LENS CAP AND SHOULDER STRAP

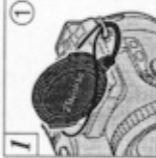

- 1 Pull the lens cap cord through the strap mount.
- 2 Fit and remove the lens cap by squeezing the left and right sides of the cap.

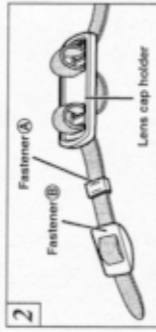

- Remove fasteners **A** and **B** from only one side of the shoulder strap. Then pass the shoulder strap through the lens cap holder and then back through fasteners **A** and **B**.



- Attach the shoulder strap to the strap mounts. After attaching the shoulder strap, check carefully that the strap is firmly secured.



### Using the Lens Cap Holder

- 1 To prevent the lens cap from appearing in the shot when you take pictures, attach the lens cap to the lens cap holder.



## LOADING THE BATTERY



- 1 Slide the battery cover and lift it open.
- 2 Insert the battery in the direction indicated by the arrow "▼" on the battery.



- 1 Hold the battery in.
- 2 and close the battery cover.

- Do not use excessive force to open the battery cover.
- When replacing the battery, always switch the camera off beforehand. If you open the battery cover without switching the camera off, the camera settings may revert to the factory defaults.

### Battery Type

NP-80 rechargeable battery.



- The battery is not fully charged at shipment. You must charge the battery before you use it.
- See P. 114 - 116 for more information on the battery.

## CHARGING THE BATTERY

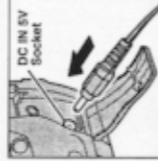

- Check that the camera is switched off. Open the terminal cover and plug the AC power adapter connector into the "DC IN 5V" socket. Then plug the AC power adapter into a power outlet.



- 1 The indicator lamp lights (orange) and battery charging begins. When charging is completed, the indicator lamp goes off.

- A fully discharged battery takes about 5 hours to recharge.
- An almost fully charged battery will not charge. This is normal and does not indicate a fault.
- If you switch the camera on while the battery is charging, the charging will stop.
- By using the optional Battery Charger BC-60, you can reduce the charging time to approximately 70 minutes (see P. 110).

- Problems arising from the use of products other than genuine FUJIFILM products are not covered by your warranty.
- See P. 116, 117 for additional notes on the AC power adapter.

## USING THE AC POWER ADAPTER

Connecting the AC-5V AC Power Adapter to your camera allows you to take pictures or play back images (using a TV connection, etc.) without worrying about the battery running out. You can also use the AC power adapter to recharge the camera's battery, making it very convenient for travelling, etc.

- **Compatible AC power adapters**

Model: AC-5VS/AC-5VH (provided as an accessory or sold separately)



Check that the camera is switched off. Open the terminal cover and plug the AC power adapter connector into the "DC IN 5V" socket. Then plug the AC power adapter into a power outlet.

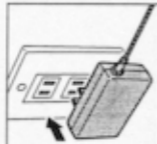

## LOADING THE SmartMedia™

### SmartMedia™

- **Only use 3.3V SmartMedia**

MG-4S (4MB), MG-16SW (16MB, ID)  
MG-8S (8MB), MG-32SW (32MB, ID)  
MG-16S (16MB), MG-64SW (64MB, ID)  
MG-32S (32MB), MG-128SW (128MB, ID)  
MG-64S (64MB)

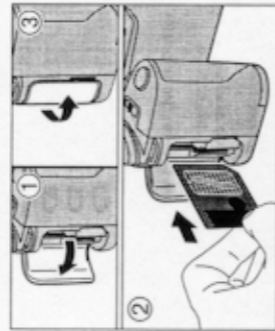

- ① Check that the camera is switched off and open the slot cover.
- ② Push the SmartMedia firmly into the SmartMedia slot as far as it will go.
- ③ Close the slot cover.
- ④ If you open the slot cover while the camera is switched on, the camera is automatically switched off to protect the SmartMedia.
- ⑤ The SmartMedia will not slide fully into the slot if it is inserted facing the wrong way. Be careful not to apply undue force to the SmartMedia.

- ⑥ Images cannot be recorded or erased if a write-protect sticker is affixed to the SmartMedia.
- ⑦ Operation of this camera is only guaranteed when it is used with FUJIFILM SmartMedia.
- ⑧ Some 3.3V SmartMedia are labelled as "3V" or "1D" cards.
- ⑨ See P.117, 118 for more information on SmartMedia.

- ⑩ Problems arising through the use of products other than genuine FUJIFILM products are not covered by your warranty.
- ⑪ See P.116 for additional notes on the AC power adapter.

## SETTING THE DATE AND TIME

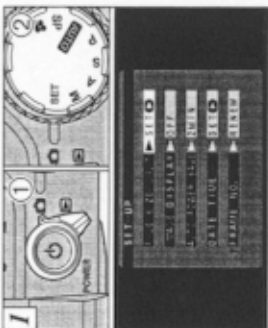

① Set the Mode switch to "SET". ② Set the Mode dial to "SET". The SET-UP screen appears on the monitor.

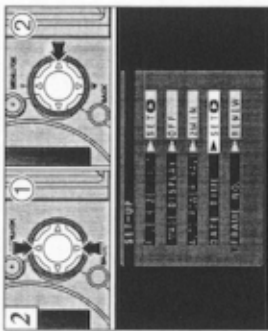

① Use "▲" or "▼" to select "DATE/TIME".  
② Press "▶".

③ See P.96 for more information on the "SET" (setup) menu.

④ If at least 3 hours have passed since the AC power adapter was connected or the battery inserted and date and time set, then those settings will be maintained for roughly 1 hour even when the camera has no power supply (when the AC power adapter is disconnected and the battery is removed).

If the date was cleared and you selected "SET DATE/TIME", proceed from step [3]. (→P.23)

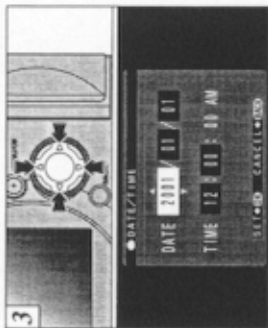

Use the "◀▶" button to select the desired item and then use the "▲" and "▼" buttons to correct the setting.

⑤ If you hold down "▲" or "▼", the numbers change continuously.

⑥ When the time displayed passes "12:00:00", the AM/PM setting automatically switches.

⑦ To set the time precisely, press the "MENU/OK" button when the time is at zero seconds.



When you have finished setting the date and time, press the "MENU/OK" button to confirm the setting.

When the SET-UP screen reappears, move the Mode dial to a setting other than "SET" to exit the SET-UP screen.

If the date setting was cleared and you have set the date and time from the confirmation screen, pressing the "MENU/OK" button returns you to the selected photography or playback mode.

### TAKING PICTURES (AUTO MODE)

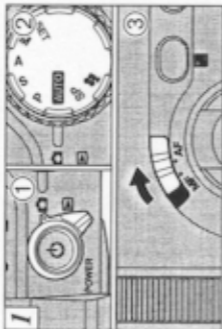

- 1 Set the Mode switch to "O" ② and set the Mode dial to "AUTO". ③ Then slide the focus mode selector switch to "AF".

#### ● Effective Photography Range

Wide-angle: Approx. 50 cm to infinity  
 Telephoto : Approx. 90 cm to infinity

- For close-up photography, set the mode to MACRO (P.55).
- Check that the lens is clean. If it is dirty, clean the lens as described on P.113.

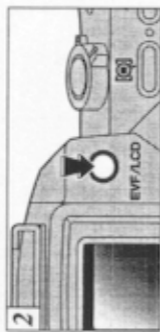

You can switch between using the viewfinder (EVF) and the monitor (LCD) to take pictures by pressing the EVF/LCD button.

- If "LENS ERASE", "LENS RELEASE" or "LENS ERASE" is displayed, first wipe the contact surface on the SmartMedia (gold-colored area) thoroughly with a soft, dry cloth and then reload the SmartMedia. If this does not resolve the problem, format the card.

The EVF/LCD selection setting is retained when the mode is switched or the camera is switched off.

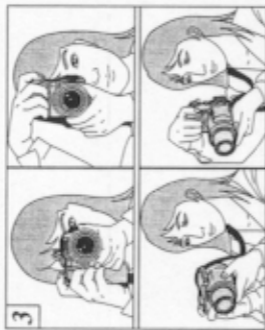

Put your arm through the shoulder strap so that the strap is looped around your shoulder. Hold the camera grip with your right hand and use your left hand to support the camera (lens) securely.

- Use of the automatic flash is recommended (P.52).
- Moving the camera when you take a picture can result in a blurred image. You should use the flash or a tripod to prevent camera shake, particularly when you are shooting in dark locations.

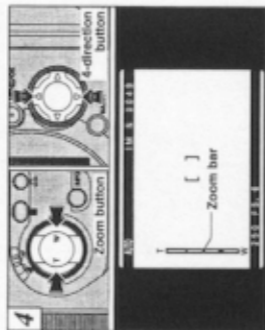

You can use the Zoom button or "▲" and "▼" on the 4-direction button to zoom in and out. To zoom in on the subject, press the T side of the button. To zoom out, press the W side. When you use the zoom, a "zoom bar" appears on the screen.

- Zooming pauses briefly when you switch between the optical zoom and the digital zoom (P.60).
- When you are shooting with the camera held on its side, you should use the 4-direction button to operate the zoom.
- The FreePixel ZOOM uses a 6x optical zoom with a focal length equivalent to 35 - 210 mm on a 35 mm camera. The focal length when the camera is switched on is equivalent to roughly 50 mm.

## TAKING PICTURES (AUTO MODE)



Frame the shot so that the subject fills the entire AF (Auto Focus) frame.



When you press the shutter button down halfway, the camera emits a short double-beep and focuses on your subject. At that point, the AF frame on the screen becomes smaller and the camera sets the shutter speed and aperture.

- If the camera does not emit a short double-beep and "JAF" appears on the screen, the camera cannot focus.
- When you press the shutter button down halfway, the image on the screen freezes temporarily. However, this image is not the recorded image.
- If "JAF" is displayed on the screen (e.g. the shot is too dark for the camera to focus), try standing about 2 m from your subject to take the picture.



If you press the shutter button down halfway and then press the shutter button down fully without releasing it, the camera beeps once and takes the picture. The "AF" icon then appears on the screen and the shot is recorded as an image file.

- When the "AF" icon appears on the screen, image recording is in progress. Do not remove the SmartMedia while the icon is displayed.
- You cannot take the next shot when the number of available shots is displayed in red.

### ◆ Taking Pictures ◆

If the camera cannot focus, the AF frame does not change and the camera does not beep.

- To focus on your subject, use the AF/AE lock and focus on another subject that is roughly the same distance away and has about the same brightness (→P.30).
- You can also focus the camera manually. (An easy solution is to use the one-touch AF function to focus on a subject that is roughly the same distance away. →P.59)
- If it is too dark to focus, move to roughly 2 m away from the subject and then take the picture.

- When you take a picture, the indicator lamp turns orange (photographs cannot be taken). When the indicator lamp turns green again, the camera is ready to take pictures.
- If you press the shutter button down fully in a single motion, the AF frame does not change size and the camera does not beep when the picture is taken.
- The indicator lamp flashes orange while the flash is charging.
- Refer to P.120 for information on warning displays. 27

## USING AF/AE LOCK



In a shot with this type of composition, the subjects (two people in this case) are not in the AF frame. If the shot is taken at this point, the subjects will not be in focus.

Check that the focus mode selector switch is set to "AF".

### AF (Autofocus)/AE (Autoexposure) Lock

On the FinePix6900 ZOOM, pressing the shutter button down half way locks the focus and exposure settings (AF and AE lock). If you want to focus on a subject that is not centered in the frame or change the picture composition after the exposure is set, you can obtain good results by changing the composition after the AF and AE settings are locked.

When you cannot focus and AF/AE lock does not give the correct exposure

- Position the AF frame over your main subject and apply the AE lock (P.56). Move the AF frame to another subject at roughly the same distance and press the shutter button halfway. Holding the shutter button down halfway, recompose your original shot and take the picture.



Move the camera slightly so that one of the subjects in the AF frame.



Press and hold the shutter button down halfway (AF/AE lock). The AF frame on the screen becomes smaller and the camera determines the shutter speed and aperture setting.

With the shutter button still held down halfway (AF/AE lock), move the camera back to the original image and press the shutter button down fully.

- You can reapply the AF/AE lock as many times as you like before releasing the shutter.
- The AF/AE lock operates in all photography modes and can be used to ensure excellent results.

## FRAMING GUIDELINE FUNCTION

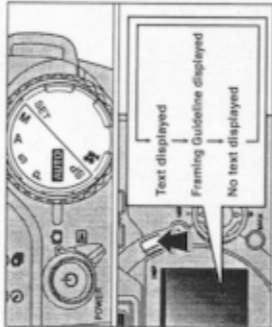

This function can be selected in the **SP** • **SP** • **P** • **S** • **A** and **M** photography modes. The screen display changes each time you press the "DISP" button. Press the "DISP" button to display the framing guideline.

- ① The framing guideline is not recorded on the image.
- ② The lines in the scene frame roughly divide the recorded pixels into three equal parts horizontally and vertically. When the image is printed, the resulting print may be shifted slightly from the scene frame.

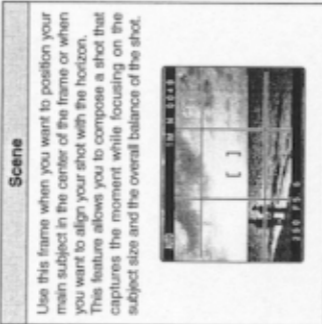

### ◆ Important ◆

Always use the AF/AE lock to compose your picture. Failing to use the AF/AE lock may result in the image being out of focus.

## VIEWING YOUR IMAGES (PLAYBACK)

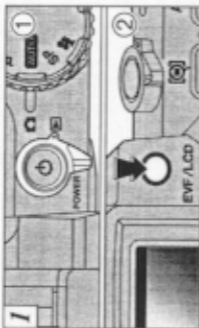

- ① Set the Mode switch to "P".
- ② The setting toggles between the viewfinder (EVF) and the monitor (LCD) each time you press the "EVF/LCD" button.

When you set the Mode switch to "P", the last image shot is displayed.

The EVF/LCD selection setting is retained when the mode is switched or the camera is switched off.

### ◆ Images That Can Be Viewed on the FinePix6900 ZOOM ◆

You can use this camera to view (excluding some uncompressed data) images recorded on an FinePix6900 ZOOM or images recorded onto a 3.3V SmartMedia using a FUJIFILM FinePix series, MX series and DX series digital camera.

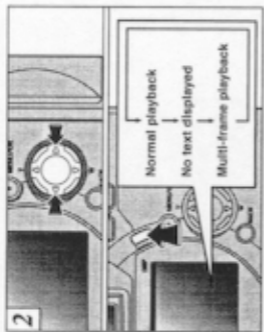

You can use "P" and "M" buttons to move forward and backward respectively through your images. The monitor display changes each time you press the "DISP" button.

- ③ If image on the monitor is difficult to see, adjust the monitor brightness (→P.102).

## FAST FORWARDING IMAGES

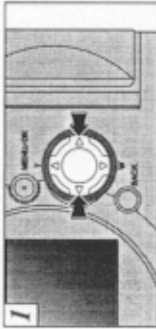

1 You can fast forward through the frames by holding down "←" or "▶" button for about 1 second during playback.



2 During fast forward, 3 frames are shown together in miniature on the monitor. When you stop fast forward, the image enclosed in the frame is displayed on the monitor as a single image.

• A progress bar is displayed to show the approximate playback position on the SmartMedia.

## PLAYBACK ZOOM



1 Pressing "▲" or "▼" during single-frame playback zooms in or out on the still image. A "zoom bar" is displayed during zooming.

### • Zoom scales:

- **GA** 2832 x 2128 pixel images: Max 18x
- **SA** 2048 x 1536 pixel images: Max 13x
- **LA** 1280 x 960 pixel images: Max 8x
- **VA** 640 x 480 pixel images: Max 4x

2 Pressing "←" or "▶" during zooming cancels zooming and moves to the next image.



After you have zoomed in on your image,

- 1 Press the "DISP" button.
- 2 Use the "▲" and "◀" buttons to zoom in on different parts of the image.
- 3 Press the "DISP" button again to revert to zoomed display.

• Press the "BACK" button to return to normal unzoomed display.



## PLAYBACK ZOOM

### Saving Trimmed Images

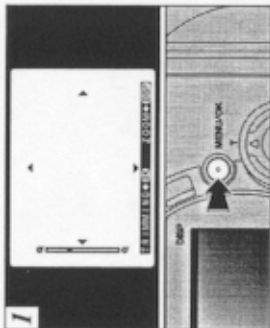

After you use the playback zoom, press the "MENU/OK" button to trim the image.

The size of the saved image varies depending on the zoom scale. In VGA mode, "TRIMMING" is displayed in yellow. At resolutions below VGA, "TRIMMING" is no longer displayed.

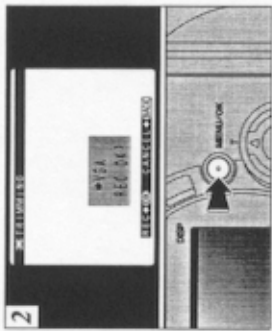

Check the size at which the image will be saved and then press the "MENU/OK" button. The trimmed image is saved as a separate file.

#### Image Sizes

613	Suitable for A5 printing
619	Suitable for A6 printing
625	"TRIMMING" is displayed in yellow since the quality is too low for printing.

\* Because images with resolutions of less than 625 are not suitable for printing, "TRIMMING" is no longer displayed and trimmed images cannot be saved.

## MULTI-FRAME PLAYBACK



The displayed playback mode switches each time you press the "DISP" button. Press the "DISP" button to switch to multi-frame playback (9-frame).



- Select a frame by using "▲", "▼", "◀" and "▶" to move the cursor (the orange box) to the desired frame. Press "▲" or "▼" several times to switch to the previous page or the next page.
- You can enlarge the selected image by pressing the "DISP" button again.

- Multi-frame playback is also useful for specifying erase, protect and DPOF settings for single frames and for selecting images when you want to check or cancel DPOF settings.

- The text displayed on screen disappears after about 3 seconds.

- Multi-frame playback cannot be used at the same time as playback zoom.

## ERASING SINGLE FRAME



- 1 Set the Mode switch to "FRAME".
- 2 Press the "MENU/OK" button to display the menu screen on the monitor.

See P.81 for more information on Erasing all frames and Formatting.  
Multi-frame playback (P.37) is an easy way to select images to be protected.

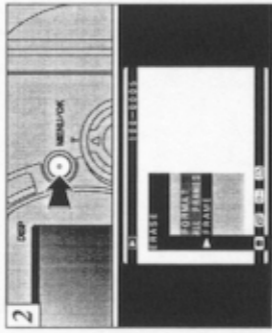

- Select "FRAME" in the "ERASE" menu and press the "MENU/OK" button.

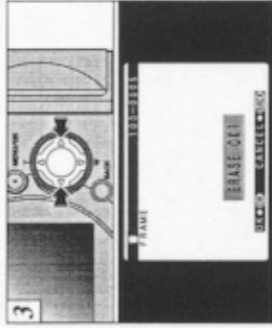

- Press "←" or "→" button to display the image to be erased.



- Press the "MENU/OK" button to erase the displayed image. When erasing is complete, the next image appears and the "ERASE OK" message is displayed.

- If "ERASE OK" is displayed, the image protection must be removed to erase the image (P.84).
- If the "DPOF SPECIFIED IMAGE" message is displayed, DPOF is specified. When you press the "MENU/OK" button, the image is erased and the DPOF settings are updated.

To continue erasing images, repeat steps 1, 2, 3, 4.

## USING A TV MONITOR



1 Switch off the camera and the TV. Plug the video cable (provided) into the "VIDEO OUT" socket on the camera.

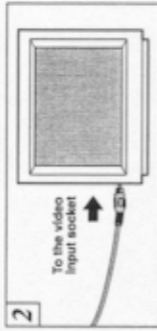

2 Plug the other end of the cable into the video input socket on the TV. Then switch the camera and TV on and take pictures or play back images as you would normally.

Ⓜ If there is a power outlet available, connect the AC-5VS/AC-5VH AC Power Adapter.

Ⓜ Refer to the instructions provided with your TV for more information on video input for your TV.

## 3 Advanced Features

## ADVANCED FEATURES

The Advanced Photography section introduces a range of camera functions that you can access by setting the Mode switch to **Q**.

### Photography mode specifications

Photography mode	Accessible menu settings	Factory default	Flash Photography (p.51)	Macro Photography (p.55)	AE lock (p.56)	Economy Converter (p.57)	MF (p.58)	CyberShot Shooting (p.61)	Self-Timer Photography (p.62)
<b>Q</b> Auto (p.42)	—	—	A5 - <b>Q</b> 5 - 5	○	○	×	○	○	○
<b>SP</b> Scene Position (p.42)									
<b>Q</b> Portrait (p.43)			A5 - <b>Q</b> 5 - 5						
<b>Q</b> Landscape (p.43)			<b>Q</b>	×	○		○	○	○
<b>Q</b> Sports (p.43)			A5 - 5			×			
<b>Q</b> Night Scene (p.43)			5 - 5						
<b>Q</b> Back and White (p.43)			A5 - <b>Q</b> 5 - 5	○					
<b>P</b> Programmed Auto (p.44)	<b>Q</b> Flash (p.66) <b>Q</b> White balance (p.66) <b>Q</b> Multi (p.66)	0 MULTI	<b>Q</b> - 5 5 - 5	○	○	○	○	○	○
<b>S</b> Shutter-priority Auto (p.44)	<b>Q</b> Photometry (p.70) <b>Q</b> Sensitivity (p.70)	100 OFF	<b>Q</b> - 5	○	○	○	○	○	○
<b>A</b> Aperture-priority Auto (p.44)	<b>Q</b> Auto bracketing (p.72) <b>Q</b> Sharpness (p.72)	NORMAL OFF	<b>Q</b> - 5 5 - 5	○	○	○	○	○	○
<b>M</b> Manual (p.46)	<b>Q</b> Multi-exp (p.72) <b>Q</b> External Flash (p.74)	OFF	<b>Q</b> - 5	○	×	×	○	○	○
<b>M</b> Movie (p.46)	—	—	×	×	×	×	×	×	×

Ⓜ The flash cannot be used when **Q** Continuous Shooting or **Q** Auto Bracketing is selected. 41



1 Turn the Mode dial to select the setting.

#### **AUTO** Auto

This is the simplest mode for taking pictures and can be used in a wide range of situations.

#### **SP** : Scene Position

This mode provides photography settings tailored to particular types of shot.



In "SP Scene Position" mode, you can select 5 types of shot (P, A, S, X, C). Turn the command dial to select the setting.

#### **P** Portrait

Use this mode for shots of people. Portrait mode provides soft-tone images with natural skin colors.

- When using the flash  
Auto Flash, Red-Eye Reduction, Forced Flash, Slow Synchro.

#### **L** Landscape

Use this mode for daytime shots of scenery. Landscape mode provides crisp, clear shots of buildings, mountains and other scenery.

- When using the flash  
The Flash mode is automatically set to Suppressed Flash. This setting cannot be changed.

#### **S** Sports

Use this mode for moving objects. Sports mode gives priority to faster shutter speeds.

- Shutter  
Takes pictures using fast shutter speeds.
- When using the flash  
Auto Flash or Forced Flash only.

#### **N** Night Scene

Use this mode for shots taken in the evening or at night. Night Scene mode gives priority to slower shutter speeds.

- Shutter  
Slow shutter speed mode with speeds as slow as 3 seconds.
- When using the flash  
Slow Synchro, Red-Eye Reduction+Slow Synchro only.

#### **B/W** Black and white

You can use this option to shoot in black and white regardless of the type of scene.

- Using flash  
Auto flash, Red-Eye Reduction, Forced Flash, Slow Synchro.

**PHOTOGRAPHY MODE****P: PROGRAMED / S: SHUTTER-PRIORITY / A: APERTURE-PRIORITY**

Turn the Mode dial to select a setting.

**P: Programed Auto**

This is an automatic mode that selects the shutter speed and aperture for you but still allows you to select the other camera settings. Like the Shutter-priority and Aperture-priority modes, this mode is relatively simple to use (Program Shift).

**S: Shutter-priority Auto**

This is an automatic mode that allows you to set the shutter speed. You can use this mode to take shots that freeze movement (fast shutter speeds) or that give the impression of movement (slow shutter speeds).

**A: Aperture-priority Auto**

This is an automatic mode that allows you to set the aperture. You can use this mode to take shots with a blurred background (wide aperture) or with both foreground and background in sharp focus (narrow aperture).



Turning the Command dial gives you access to the following :

**P:** Program Shift

**S:** Shutter speed setting (1step: 1/3 EV)

ISO 100 3 sec. to 1/1000 sec.

ISO 200 3 sec. to 1/1000 sec.

ISO 400 1.6 sec. to 1/1000 sec.

**A:** Aperture setting

F2.8 to F11 in 1/3 EV steps

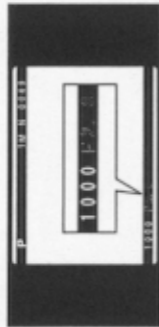

If you exceed the control range for the photography mode (as with a scene that is extremely overexposed or underexposed), the shutter speed or aperture is displayed in red on the screen (→P.13).

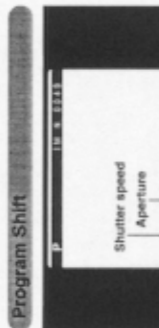
**Program Shift**

This function allows you to select different shutter speed and aperture setting combinations without changing the exposure setting. In Program Shift mode, the shutter speed and aperture settings are displayed in yellow. Program Shift is cancelled when you switch modes or switch the camera off.

See P.65 - 76 for information on the Photography menu.

See P.65 - 76 for information on the Photography menu.

See P.65 - 76 for information on the Photography menu.