

 FUJIFILM

DIGITAL CAMERA

FinePix A101



Temporary

Getting Ready **1**

Basic Photography **2**

Advanced Features
Photography **3**

Advanced Features
Playback **4**

Settings **5**

PC Connection **6**

OWNER'S MANUAL

This manual will show you how to use your FUJIFILM DIGITAL CAMERA FinePixA101 ZOOM correctly. Please follow the instructions carefully.

BL00034-200 (1) **E**

Warning

To prevent fire or shock hazard, do not expose the unit to rain or moisture.

 CAUTION RISK OF ELECTRIC SHOCK DO NOT OPEN
CAUTION : TO REDUCE THE RISK OF ELECTRIC SHOCK, DO NOT REMOVE COVER (OR BACK). NO USER-SERVICEABLE PARTS INSIDE. REFER SERVICING TO QUALIFIED SERVICE PERSONNEL.
The graphical symbols are located on the bottom of the case.

 This symbol is intended to alert the user to the presence of uninsulated "dangerous voltage" within the product's enclosure that may be of sufficient magnitude to constitute a risk of electric shock to persons.

 This symbol is intended to alert the user to the presence of important operating and maintenance (servicing) instructions in the literature accompanying the appliance.

For customers in the U.S.A.

FCC Statement

This device complies with part 15 of the FCC Rules. Operation is subject to the following two conditions : (1) This device may not cause harmful interference, and (2) this device must accept any interference received, including interference that may cause undesired operation.

CAUTION

This equipment has been tested and found to comply with the limits for a Class B digital device, pursuant to Part 15 of the FCC Rules. These limits are designed to provide reasonable protection against harmful interference in a residential installation. This equipment generates, uses, and can radiate radio frequency energy and, if not installed and used in accordance with the instructions, may cause harmful interference to radio communications. However, there is no guarantee that interference will not occur in a particular installation. If this equipment does cause harmful interference to radio or television reception, which can be determined by turning the equipment off and on, the user is encouraged to try to correct the interference by one or more of the following measures :

- Reorient or relocate the receiving antenna.
- Increase the separation between the equipment and receiver.
- Connect the equipment into an outlet on a circuit different from that to which the receiver is connected.

— Consult the dealer or an experienced radio/TV technician for help.

You are cautioned that any changes or modifications not expressly approved in this manual could void the user's authority to operate the equipment.

Notes on the Grant:

To comply with Part 15 of the FCC rules, this product must be used with a Fujifilm-specified ferrite-core AV cable, USB cable, and DC supply cord.

For customers in Canada

CAUTION

This Class B digital apparatus complies with Canadian ICES-003.

Please read the Safety Notes (→ P.81) and make sure you understand them before using the camera.

Contents

Warning	2
Preface	6
Camera Features and Accessories	7
Nomenclature	8
1 Getting Ready	
PREFACE	11
Selecting the Language	11
Attaching the Strap	11
LOADING THE BATTERIES	12
LOADING THE SmartMedia™	13
REMOVING THE SmartMedia™	14
SWITCHING ON AND OFF	15
SETTING THE DATE AND TIME	16
USING THE OPTIONAL AC POWER ADAPTER	18
2 Basic Photography	
[STILL IMAGE MODE]	
TAKING PICTURES (AUTO MODE)	19
■ Viewfinder Lamp Display	21
Number of Available Shots	22
FRAMING GUIDELINE FUNCTION	23
■ MACRO (CLOSE-UP) PHOTOGRAPHY	24
DIGITAL ZOOM	25
4 VIEWING YOUR IMAGES (PLAYBACK)	26
PLAYBACK ZOOM	27
MULTI-FRAME PLAYBACK	28
ERASING SINGLE FRAME	29
3 Advanced Features Photography	
ADVANCED FEATURES PHOTOGRAPHY	31
■ Photography mode specifications	31
[STILL IMAGE MODE]	
SELECTING AUTO OR MANUAL	32
[PHOTOGRAPHY MENU]	
PHOTOGRAPHY MENU OPERATION	33
FLASH	34
AUTO Auto Flash Mode	34
Red-Eye Reduction	35
Forced Flash	35
Suppressed Flash	36
Slow Synchro	36
SELF-TIMER PHOTOGRAPHY	37
EV (EXPOSURE COMPENSATION)	39
WHITE BALANCE	40
[MOVIE MODE]	
MOVIE	41

4 Advanced Features Playback	
PLAYING BACK MOVIES	44
■ Playing back movies	45
[PLAYBACK MENU]	
ERASING SINGLE • ALL FRAMES/FORMATTING	46
DPOF	48
DPOF DATE SETTING	49
DPOF SET FRAME	50
5 Settings	
IN SETTINGS	52
■ List of settings	52
■ SET-UP menu options	52
USING THE OPTION MENU	53
Using SET-UP	53
SETTING THE FILE SIZE AND QUALITY (COMPRESSION RATIO)	54
LCD MONITOR BRIGHTNESS	55
[SET-UP]	
POWER SAVE	56

6 PC Connection	
IN PC CONNECTION	57
CONNECTING AT DSC MODE	58
CONNECTING AT PC-CAMERA MODE	60
DISCONNECTING FROM THE PC	62
System Expansion Options	
Accessories Guide	65
Notes on Using Your Camera Correctly	67
Notes on the Power Supply	68
Applicable Batteries	68
Notes on the Batteries	68
Notes on Using the AC Power Adapter	69
Notes on the SmartMedia™	70
Warning Displays	72
Troubleshooting	75
Specifications	78
Explanation of Terms	80
Safety Notes	81
EC Declaration of Conformity	84

Preface

■ Test Shots Prior to Photography

For particularly important photographs (such as weddings and overseas trips), always take a test photograph and view the image to make sure that the camera is functioning normally.

● Fuji Photo Film Co., Ltd. cannot accept liability for any incidental losses (such as the costs of photography or the loss of income from photography) incurred as a result of faults with this product.

■ Notes on Copyright

Images recorded using your digital camera system cannot be used in ways that infringe copyright laws without the consent of the owner, unless intended only for personal use. Note that some restrictions apply to the photographing of stage performances, entertainments and exhibits, even when intended purely for personal use. Users are also asked to note that the transfer of memory cards containing images or data protected under copyright laws is only permissible within the restrictions imposed by those copyright laws.

■ Liquid Crystal

If the LCD monitor or display panel is damaged, take particular care with the liquid crystal in the monitor or panel. If any of the following situations arise, take the urgent action indicated.

- If liquid crystal comes in contact with your skin
Wipe the area with a cloth and then wash thoroughly with running water and soap.
- If liquid crystal gets into your eye
Flush the affected eye with clean water for at least 15 minutes and then seek medical assistance.
- If liquid crystal is swallowed

6 Flush your mouth thoroughly with water. Drink large

quantities of water and induce vomiting. Then seek medical assistance.

■ Notes on Electrical Interference

If the camera is to be used in hospitals or aircrafts, please note that this camera may cause interference to other equipment in the hospital or aircraft. For details, please check with the applicable regulations.

■ Handling Your Digital Camera

This camera contains precision electronic components. To ensure that images are recorded correctly, do not subject the camera to impact or shock while an image is being recorded.

■ Trademark Information

- IBM PC/AT is a registered trademark of International Business Machines Corp. of the U.S.A.
- iMac and Macintosh are registered trademarks of Apple Computer, Inc.
- Windows is a registered trademark of the Microsoft Corporation of the U.S. registered in the U.S.A. and other countries. Windows is an abbreviated term referring to the Microsoft Windows Operating System.
- SmartMedia is a trademark of Toshiba Corporation.
- Other company or product names are trademarks or registered trademarks of the respective companies. Trademark information.





Camera Features and Accessories

Features

- Superb image quality provided by the high-resolution Fujinon lens and a CCD with 1.25 million effective pixels
- Maximum recording resolution of 1280 x 960 pixels (approx. 1.23 megapixels)
- Compact and lightweight body
- Wide range of photography applications (includes macro function)
- Automatic scene recognition, auto white balance and AE functions built in
- Automatic high-precision flash built in with extensive flash control functionality
- 2x digital zoom photography and up to 4x zoom playback functions
- Easy operation using the Mode switch and 4-way "AV ◀▶" button
- Shoots movies (320 x 240 pixels without sound)
- USB connection for quick and easy image file downloading (using the enclosed Interface Set)
- Built-in PC Camera function
- Runs on 2 ordinary AA batteries
- Conforms to the new standard for digital camera file system*

- * Design rule for Camera File system.
- * Linking your camera to a PC is even easier using optional accessories such as the Floppy Disk Adapter FD-A2B, the Image Memory Card Reader SM-R2 and the PC Card Adapter PC-AD3B.

Accessories

- LR16 AA-size alkaline batteries (2) 
- 8 MB, 3.3V SmartMedia (1) 
Supplied with:
 - Anti-static case (1)
 - Index labels (1)
- Hand strap (1) 
- Interface Set (1) 
 - CD-ROM (1)
 - Special USB cable with Noise Suppression core (1)
 - Software Quick Start Guide (1)
- Owner's Manual (this manual) (1)

Nomenclature

* Refer to the pages in parentheses for information on using the camera features.

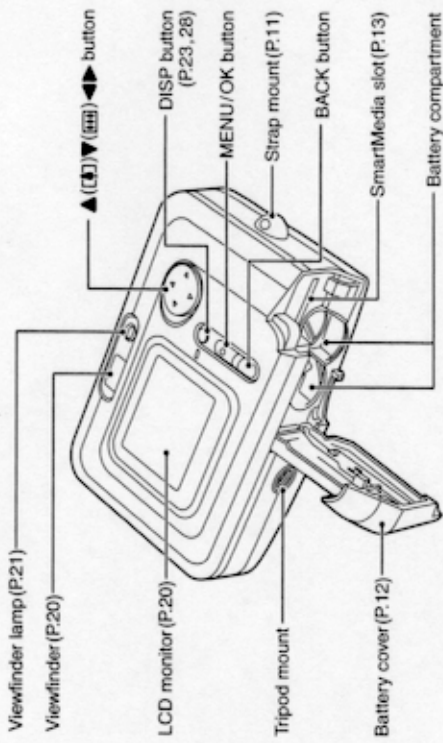
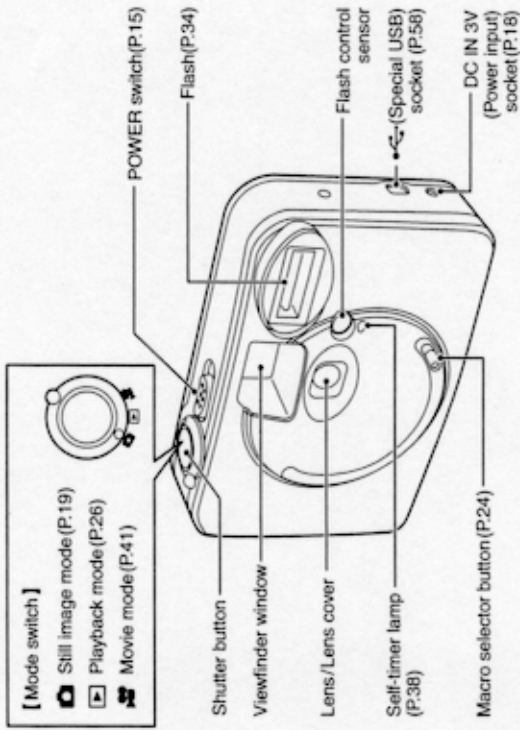

Nomenclature

Example of LCD Monitor Text Display : Still image

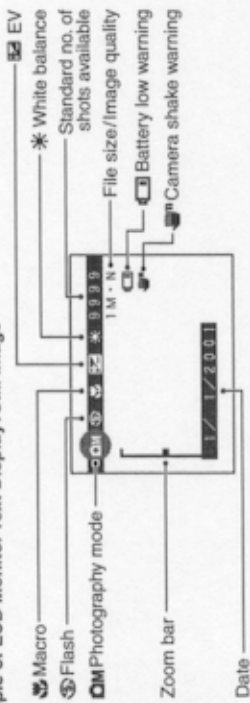

Example of LCD Monitor Text Display : Playback

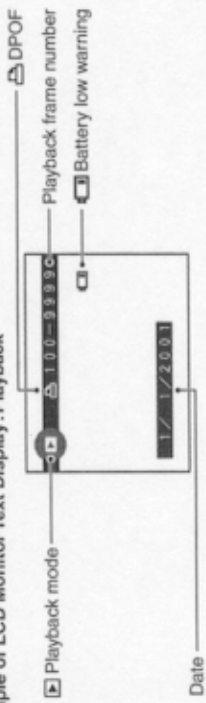

1 Getting Ready

PREFACE

Selecting the Language



You can use the "SET-UP" screen on this camera to select ENGLISH or FRENCH as the LANGUAGE used for screen display (→P.52). The screens in this manual are shown in ENGLISH.

Attaching the Strap

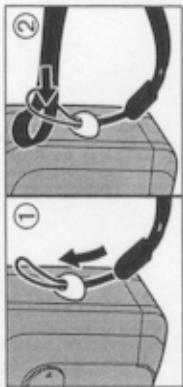

① Pass the loop of this cord on the end of the strap through the strap mount.
 ② Then pass the other end of the strap through the loop of the thin cord and pull the strap tight.

LOADING THE BATTERIES

Compatible batteries

Use AA-size alkaline batteries (2) or AA-size nickel-metal hydride (Ni-MH) batteries (2).

- Do not use different types of batteries or old and new batteries together.
- You will need the optional charger (→ P. 65) to recharge Ni-MH batteries.
- Do not use lithium, manganese or nickel-cadmium (Ni-Cd) batteries as the heat generated by these battery types can cause camera malfunctions.

◆ Notes on Handling Batteries ◆

- The capacities of alkaline batteries vary between brands and the life of the batteries (the time for which they provide power) may be shorter than the alkaline batteries provided with the camera. Note also that due to the nature of alkaline batteries, the time for which they can be used is shorter in cold locations (at temperatures of +10°C or below). Consequently, Ni-MH batteries are recommended.
- Soiling (fingerprints, etc) on the terminals of batteries can greatly reduce the time for which the batteries provide power.

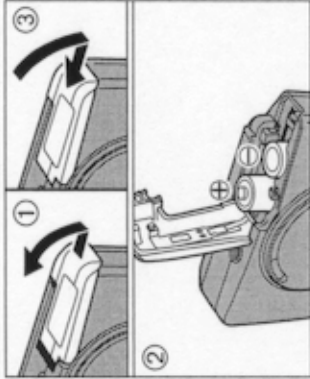

- Slide the battery cover out and lift it open.
 - Insert the batteries correctly as indicated by the polarity icons.
 - Close the battery cover.
- Do not apply excessive force to the battery cover.
- Take care not to drop the batteries when you open or close the battery cover.

LOADING THE SmartMedia™

SmartMedia™ (sold separately)

■ Only use 3.3V SmartMedia

- MG-4S (4MB), MG-16SW (16MB, ID)
- MG-8S (8MB), MG-32SW (32MB, ID)
- MG-16S (16MB), MG-64SW (64MB, ID)
- MG-32S (32MB), MG-128SW (128MB, ID)

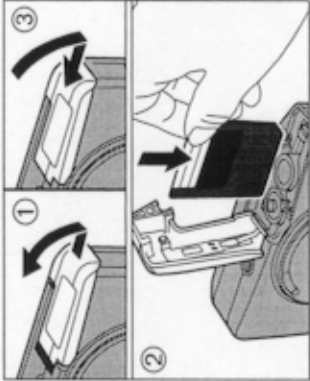

- Check that the camera is switched off. Then hold the camera so that the battery cover faces upwards and slide the cover out to open it.
 - Push the SmartMedia firmly into the SmartMedia slot as far as it will go.
 - Close the battery cover.
- If you open the battery cover while the camera is still switched on, the camera is automatically switched off to protect the SmartMedia.
- The SmartMedia will not slide fully into the slot if it is inserted facing the wrong way. Be careful not to apply undue force to the SmartMedia.

- Image files cannot be recorded or erased if a write-protect sticker is affixed to the SmartMedia.
- Operation of this camera is only guaranteed when it is used with FUJIFILM SmartMedia.
- Some 3.3V SmartMedia are labelled as "3V" or "ID" cards.
- See P. 70 - 71 for more information on SmartMedia.

REMOVING THE SmartMedia™

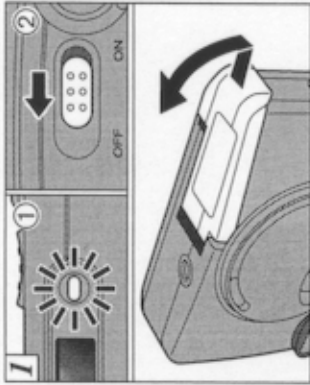

- 1 Check that the indicator in the viewfinder is green and then switch the camera off.
- 2 Always ensure that the battery cover is facing upwards when you open it.

Never open the battery cover while the camera is still switched on as this could corrupt the image files on the SmartMedia or damage the SmartMedia itself.

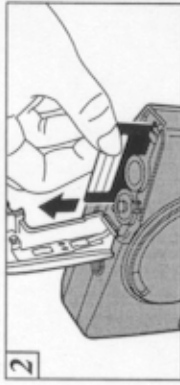

Grip the SmartMedia and pull it out, taking care that the batteries do not fall out of the camera.

- To protect the SmartMedia, always store it in the special anti-static case.

◆ Printing Images and Downloading Images to a PC ◆

- See P.48, 64 for information on printing images.
- See P.57 - 64 for information on downloading images to a PC.

SWITCHING ON AND OFF

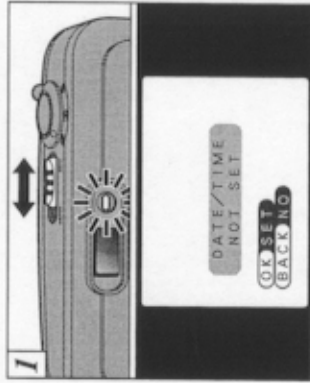

To switch the camera on and off, slide the power switch sideways. When you switch the camera on, the viewfinder lamp lights (green). If the date has been cleared, a confirmation message appears.

DATE/TIME NOT SET
OK SET
BACK

DATE/TIME setting screen appears (→P.17).

- The camera remains in Still image, Movie or playback mode.
- If you do not set the date and time, this confirmation screen will appear each time you switch the camera on.
- Take care not to touch the lens when the camera is switched on.



Switch the camera on and check the battery charge indicator.

- 1 Battery has ample charge. (No indicator displayed.)
- 2 Battery charge low. Replace or recharge the battery as it will run out shortly.
- 3 The battery is exhausted. The display will shortly go blank and the camera will stop working. Replace or recharge the battery.

- If the battery charge is depleted, you may not be able to switch the LCD monitor on.

◆ Power Save Function ◆

If the camera is not used for 2 minutes, this function automatically switches it off. When this function is enabled, the LCD monitor switches off to conserve battery power if the camera is not used in any way for 30 seconds (See P.56 for details).

SETTING THE DATE AND TIME

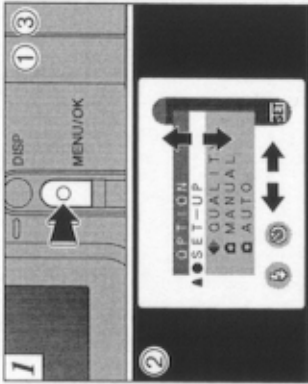

- 1 Press the "MENU/OK" button to display the menu screen.
- 2 Use "←", "→", "▲" or "▼" to select "SET-UP" from the "OPTION" menu.
- 3 Press the "MENU/OK" button.

If the date was cleared and you selected "QSD", proceed from step 3 (→P.17).

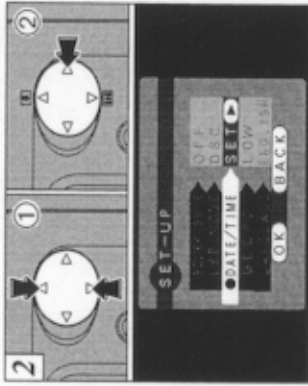

- 1 The "SET-UP" screen appears. Use "▲" or "▼" to select "DATE/TIME".
- 2 Press "→".
- 3 See P.52 for more information on the "OPTION" menu.
- 4 If at least 10 minutes have passed since the AC power adapter was connected or the battery inserted and date and time set, then those settings will be maintained for roughly 12 hours even when the camera has no power supply (when the AC power adapter is disconnected and the battery is removed).

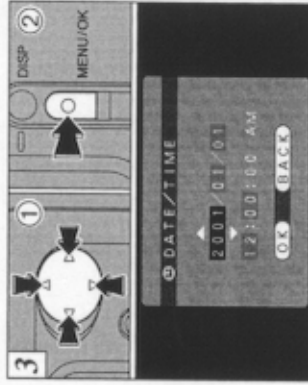

- 1 Use "←" or "→" to select the desired item and then use "▲" and "▼" to correct the setting.
- 2 When you have finished setting the date and time, press the "MENU/OK" button to confirm the setting.
- 3 If you hold down "▲" or "▼", the numbers change continuously.
- 4 When the time displayed passes "12:00:00", the AM/PM setting automatically switches.
- 5 You cannot set the seconds. To set the time precisely, press the "MENU/OK" button when the time signal reaches zero.

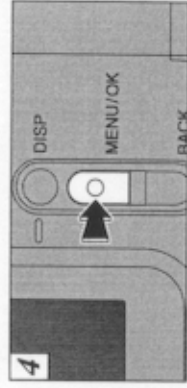

The "SET-UP" screen reappears. Press the "MENU/OK" button to complete the settings.

If the date was cleared and you selected "QSD", the camera switches to photography or playback mode without returning to the "SET-UP" screen.

USING THE OPTIONAL AC POWER ADAPTER

AC power adapter (optional)

Always use a FUJIFILM AC Power Adapter AC-3V.

Use the AC power adapter in situations when a loss of power will cause problems, such as during file downloading (via the USB connection). Using the AC power adapter also allows you to take pictures and play back images without worrying about depleting the batteries.



- See P.67 for notes on using the AC power adapter.
- Only connect or disconnect the AC power adapter when the camera is switched off.

Connecting or disconnecting the AC power adapter while the camera is switched on temporarily interrupts the power supply to the camera, so that images or movies being shot at the time are not recorded. Failing to switch the camera off first can also result in damage to the SmartMedia or malfunctions during PC connection.

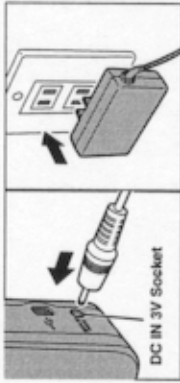

Check that the camera is switched off. Plug the AC power adapter connector into the "DC IN 3V" socket and then plug the AC power adapter into the power outlet.

Connecting the AC power adapter does not allow you to charge the NiMH batteries. Use the optional charger (P.63) to charge the NiMH batteries.

2 Basic Photography

STILL IMAGE MODE TAKING PICTURES (AUTO MODE)

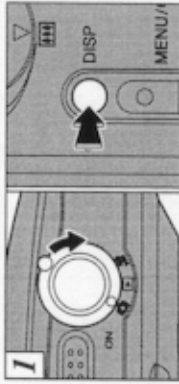

- Set the Mode switch to "M".
- In viewfinder photography (excluding Macro mode), press the "DISP" button several times to switch the LCD monitor off.

● **Photography range:** Approx. 80 cm (2.6 ft.) to infinity

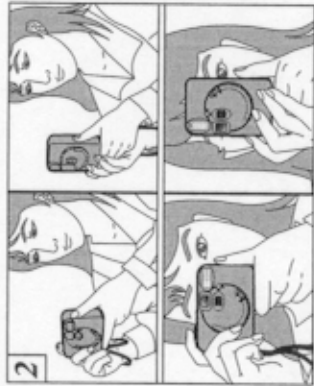

Loop the strap over your wrist, brace your elbows firmly against your body and hold the camera with both hands.

- For close-up shots, use the Macro setting (P.24).
- To minimize power consumption, you should use the viewfinder (switch the LCD monitor off) to take pictures.
- The image will be blurred if the camera moves when you take the picture (camera shake). When you are shooting in low-light conditions, use the flash (P.34) or a tripod to prevent blurred images due to camera shake.

If "CARD ERROR" or "WHITE ERROR" is displayed, first wipe the contact surface on the SmartMedia (gold-colored area) thoroughly with a soft, dry cloth and then reload the SmartMedia. In some cases, you may have to format the SmartMedia (P.46).

STILL IMAGE MODE TAKING PICTURES (AUTO MODE)



Be careful to ensure that the lens, flash and flash control sensor are not obscured by your hands or the camera strap.



Use the LCD monitor or viewfinder to locate your subject in the frame.

- ④ To frame your shot precisely, you should take the picture using the LCD monitor.
- ⑤ In some conditions it may be difficult to see your subject clearly on the LCD monitor, such as in sunny weather outdoors or when you are shooting dimly lit scenes. In such situations, use the viewfinder to take the shot.

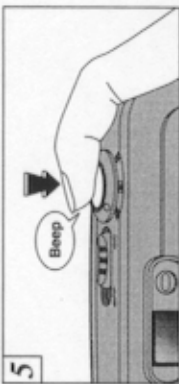

When you press the shutter button, the camera emits a short beep and takes the picture. And the data is then recorded.

- ⑥ The viewfinder lamp flashes orange while the flash is charging. If the LCD monitor is switched on, the screen may go dark for a moment. This is normal and does not indicate a fault.
- ⑦ Since the amount of image data recorded is not fixed and varies depending on the subject (level of image detail, etc.), the number of available shots may not decrease after the image is recorded, or may decrease by 2.
- ⑧ See P.72 – 74 for information on the warning displays.

The viewfinder lamp glows orange while the image is being recorded and no pictures can be taken. Also, do not switch the camera off or open the battery cover during image recording. Doing so will result in corrupted or erased image files.

Viewfinder Lamp Display

Color	Status	Meaning
Green	Lit	Ready to shoot
Orange	Lit	Image being recorded onto the SmartMedia.
	Flashing	Flash charging
Red	Flashing	● SmartMedia warning No SmartMedia loaded. SmartMedia not formatted. Incorrect format, write-protect sticker used, SmartMedia full, SmartMedia error.
		* When the LCD monitor is switched on, details of the warning are displayed on the monitor (→P.72).

STILL IMAGE MODE TAKING PICTURES (AUTO MODE)

Number of Available Shots

The number of available shots appears on the LCD monitor.

- See P.54 for information on changing the File Size and Quality settings.
- The factory default settings at shipment are 1M (File Size) and N (Quality: NORMAL).



Standard number of shots per SmartMedia

The number of shots may increase or decrease slightly depending on the type of subject. Note also that the larger the SmartMedia capacity, the greater the discrepancy between the standard number of shots and the actual number of shots.

File Size Quality	1280 X 960		640 X 480	
	FINE Approx.620KB	NORMAL Approx.320KB	BASIC Approx.160KB	NORMAL Approx.125KB
4MB (MG-4S)	6	12	23	30
8MB (MG-8S)	12	25	46	61
16MB (MG-16S/SW)	25	49	89	122
32MB (MG-32S/SW)	50	99	180	247
64MB (MG-64S/SW)	101	198	361	497
128MB (MG-128S/SW)	204	398	725	997

* The number of available shots are shown for formatted SmartMedia.

FRAMING GUIDELINE FUNCTION

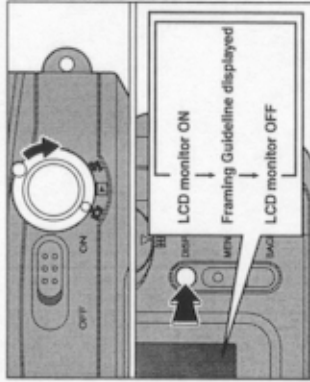

You can select this option when the Mode switch is set to "CA". The mode shown on the LCD monitor switches each time you press the "DISP" button. Press the "DISP" button to display the framing guideline.

- The framing guideline is not recorded on the image.
- The lines in the scene frame roughly divide the recorded pixels into three equal parts horizontally and vertically. When the image is printed, the resulting print may be shifted slightly from the scene frame.

Scene

Use this frame when you want to position your main subject in the center of the frame or when you want to align your shot with the horizon. This feature provides a clear guide to the subject size and the overall balance of the shot so that you get exactly the shot you want.

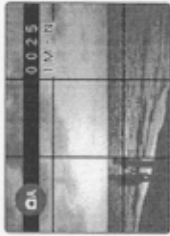

MACRO (CLOSE-UP) PHOTOGRAPHY

Selecting Macro mode allows you to take close-up shots. If the flash is set to "AUTO" or "Red-eye Reduction mode", it is automatically set to "Suppressed Flash mode".

- **Effective Photography Range:**
Approx. 7 cm – 13 cm (2.8 in – 5.1 in).
- Using the camera width (about 10 cm or 4 in.) as a guide, ensure that the distance to the subject is between 7 cm and 13 cm (2.8 in to 5.1 in.). The camera will not focus on subjects outside this focal range.
- To use the flash, display the menu and select "Forced flash" or "Slow-synchro" (P.35, 36). However, note that you may not get the correct exposure.
- When shooting in dark conditions, use a tripod to prevent camera shake.

If you use the viewfinder to take a picture in Macro mode, the field visible through the viewfinder does not match the field actually photographed because the viewfinder and lens are in different positions. Accordingly, you should use the LCD monitor to take pictures in Macro mode.

DIGITAL ZOOM

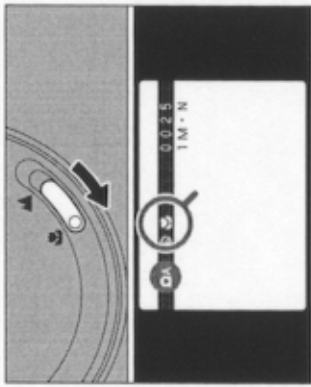

- To switch to Macro mode, slide the Macro selector switch towards the Macro icon until it stops.
- "M": The "M" icon appears on the LCD monitor and you can take close-up shots.
- "▲": Macro mode is cancelled and the camera is ready for normal shooting (P.19).
- The LCD monitor automatically switches on.
- You cannot switch the LCD monitor off.
- When you cancel Macro mode, the LCD monitor remains switched on.

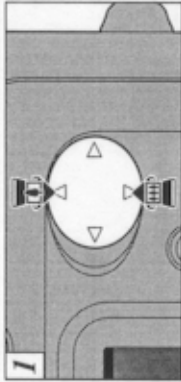

You can use the digital zoom function for all Resolution (File Size) settings "FINE". Note that the digital zoom only functions when you use the LCD monitor to take shots.

To zoom in on your subject, press "▲" (TELE). To zoom out, press "▼" (WIDE).



- A "zoom bar" appears on the screen.
- Digital zoom focal lengths (35 mm camera equivalent)
Equivalent to approx. 36 mm – 72 mm
Max. zoom scale: 2x

VIEWING YOUR IMAGES (PLAYBACK)



- 1 Set the Mode switch to "P".
- 2 You can use "▶" and "◀" to move forward and backward respectively through your images.

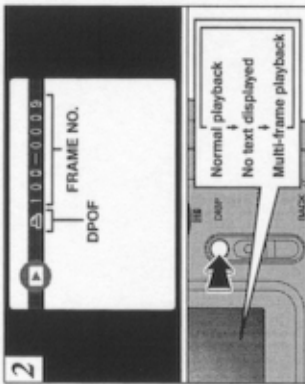

If you have specified DPOF settings, the "P" icon is displayed. The LCD monitor display changes each time you press the "DISP" button.

- When you set the Mode switch to "P", the last image shot is displayed.
- See pages 53 and 55 for more information on adjusting the brightness of the LCD monitor.

◆ Images That Can be Viewed on the FinePix A101 ◆

You can use this camera to view (excluding some uncompressed data) images recorded on a FinePix A101 or images recorded onto a 3.3V SmartMedia using a FUJIFILM FinePix series, MX series or DX series digital camera.

PLAYBACK ZOOM

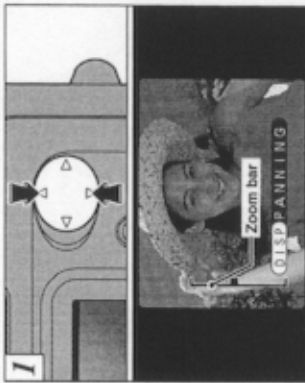

Pressing "▲" or "▼" during single-frame playback zooms in (enlarges) or out on a still image. When you use this function, a zoom bar is displayed.

• Zoom scales:

- LM 1280 x 960 pixel images: Max 4x
- VEA 640 x 480 pixel images: Max 2x

- Pressing "◀" or "▶" during zooming cancels zooming and moves to the next image.

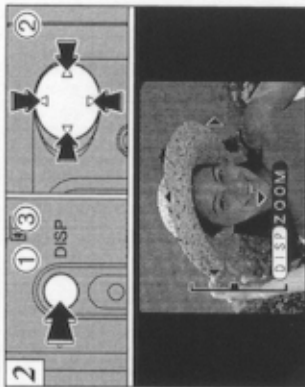

After you have zoomed in on your image,

- 1 Press the "DISP" button.
- 2 Use "▲", "▼", "◀" and "▶" to zoom in on different parts of the image.
- 3 Press the "DISP" button again to revert to zoomed display.
- Press the "BACK" button to return to normal unscanned display.

This is useful for such things as checking the focus after you take a shot.