



NLS-MT65

Portable Data Collector

User Guide

Disclaimer

© 2015 Fujian Newland Auto-ID Tech. Co., Ltd. All rights reserved.

Please read through the manual carefully before using the product and operate it according to the manual. It is advised that you should keep this manual for future reference.

Do not disassemble the device or remove the seal label from the device, doing so will void the product warranty provided by Fujian Newland Auto-ID Tech. Co., Ltd.

All pictures in this manual are for reference only and actual product may differ. Regarding to the product modification and update, Fujian Newland Auto-ID Tech. Co., Ltd. reserves the right to make changes to any software or hardware to improve reliability, function, or design at any time without notice. The information contained herein is subject to change without prior notice.

The products depicted in this manual may include software copyrighted by Fujian Newland Auto-ID Tech. Co., Ltd or third party. The user, corporation or individual, shall not duplicate, in whole or in part, distribute, modify, decompile, disassemble, decode, reverse engineer, rent, transfer or sublicense such software without prior written consent from the copyright holders.

This manual is copyrighted. No part of this publication may be reproduced, distributed or used in any form without written permission from Newland.

Fujian Newland Auto-ID Tech. Co., Ltd. reserves the right to make final interpretation of the statement above.

Fujian Newland Auto-ID Tech. Co., Ltd.

3F, Building A, No.1, Rujiang West Rd., Mawei, Fuzhou, Fujian, China 350015

<http://www.nlscan.com>

Revision History

Version	Description	Date
V1.0.0	Initial release.	August 24, 2015

Table of Contents

Revision History	- 3 -
Chapter 1 About This Guide	1
Introduction.....	1
Documentation Set.....	1
Chapter Descriptions.....	2
More Information	2
Service Information	2
Chapter 2 Getting Started	3
Introduction.....	3
Unpacking	3
Accessories (Optional)	3
Getting Started	4
The MT65.....	4
Cradle	6
Installing the Battery	7
Removing the Battery	7
Charging the Battery	8
Charging LED	9
Keypad.....	10
Communicating with PC.....	11
Installing the MicroSD Card/Micro SIM Card.....	12
Chapter 3 Basics	13
Switching On/ Rebooting/ Switching Off the MT65	13
Locking/Unlocking the MT65	14
Home Screen	14
Status Icons.....	15
Installing App.....	16
Uninstalling App.....	16

Date & Time.....	17
Display.....	18
Ringtones	18
Restoring Factory Settings	19
Language & Input Method	20
Shortcuts to Apps	20
Widgets	20
Chapter 4 Scanning Barcodes	21
Scanning 1D Barcode	21
Scanning 2D Barcode	22
Programming Scanner.....	23
Chapter 5 Phone & Messages	27
Making Calls.....	27
Contacts	27
SMS and MMS Messages.....	28
Chapter 6 Mobile Network	29
Introduction.....	29
Chapter 7 Others	30
Camera.....	30
Chapter 8 App Development Guide	31
Development Environment	31
Use of Non-standard Interfaces.....	31
Chapter 9 Maintenance & Troubleshooting.....	32
Introduction.....	32
Important Safety & Handling Information.....	32
Disassembly and Retrofit	32
External Power Supply.....	32
Abnormal Situation.....	32

Drop Damage.....	32
LCD Screen	32
Stacking Heavy Objects.....	32
Mounting Location.....	33
Wireless Functionalities	33
Use & Maintenance.....	33
Battery Safety Guidelines.....	33
Troubleshooting.....	34

Chapter 1 About This Guide

Introduction

This guide provides instructions for programming and operating the NLS-MT65 portable data collector (hereinafter referred to as “**the MT65**” or “**the terminal**”).

Documentation Set

The documentation set for the MT65 includes:

- ✧ ***NLS-MT65 Portable Data Collector Quick Start:*** Describes how to get the NLS-MT65 up and running.
- ✧ ***NLS-MT65 Portable Data Collector User Guide:*** Describes how to program and use the NLS-MT65.

Chapter Descriptions

- ◇ *Chapter 1 About This Guide* Provides general description of this manual.
- ◇ *Chapter 2 Getting Started* Provides information on getting the MT65 up and running for the first time.
- ◇ *Chapter 3 Basics* Describes how to program the MT65 for the use of its basic features.
- ◇ *Chapter 4 Scanning Barcodes* Provides the instructions as to how to scan 1D/2D barcodes.
- ◇ *Chapter 5 Phone & Messages* Explains how to use phone and messages functionalities.
- ◇ *Chapter 6 Mobile Network* Explains how to use Mobile Network functionality.
- ◇ *Chapter 7 Others* Explains how to use Camera.
- ◇ *Chapter 8 App Development Guide* Describes the app development environment and the use of non-standard interfaces.
- ◇ *Chapter 9 Maintenance & Troubleshooting* Provides troubleshooting solutions for issues that might occur when using the MT65.

More Information

For more product and support information, please visit our web site: <http://www.nlscan.com> .

Service Information

Newland China	
Phone	+86-400-608-0591
Email	marketing@nlscan.com
Newland Europe	
Phone	+31(0)-345-870-033
Email	Info@newland-id.com
Newland Taiwan	
Phone	+886-2-7731-5388
Email	Info@newland-id.com.tw
Newland North America	
Phone	+1-510-490-3888
Email	Info@newlandna.com

Chapter 2 Getting Started

Introduction

This chapter lists the parts and accessories for the MT65 and explains how to install, remove and charge the battery, and power on the MT65 for the first time.

Unpacking

Carefully remove all protective material from the pack and verify that the following items are present:

- ✧ 1 x NLS-MT65 portable data collector
- ✧ 1 x USB cable
- ✧ 1 x AC adapter for the MT65
- ✧ 1 x Li-Polymer battery
- ✧ 1 x Hand strap
- ✧ 1 x Quick Start manual

Accessories (Optional)

- ✧ Cradle for the MT65
- ✧ AC adapter for the cradle
- ✧ USB cable

Getting Started

The MT65

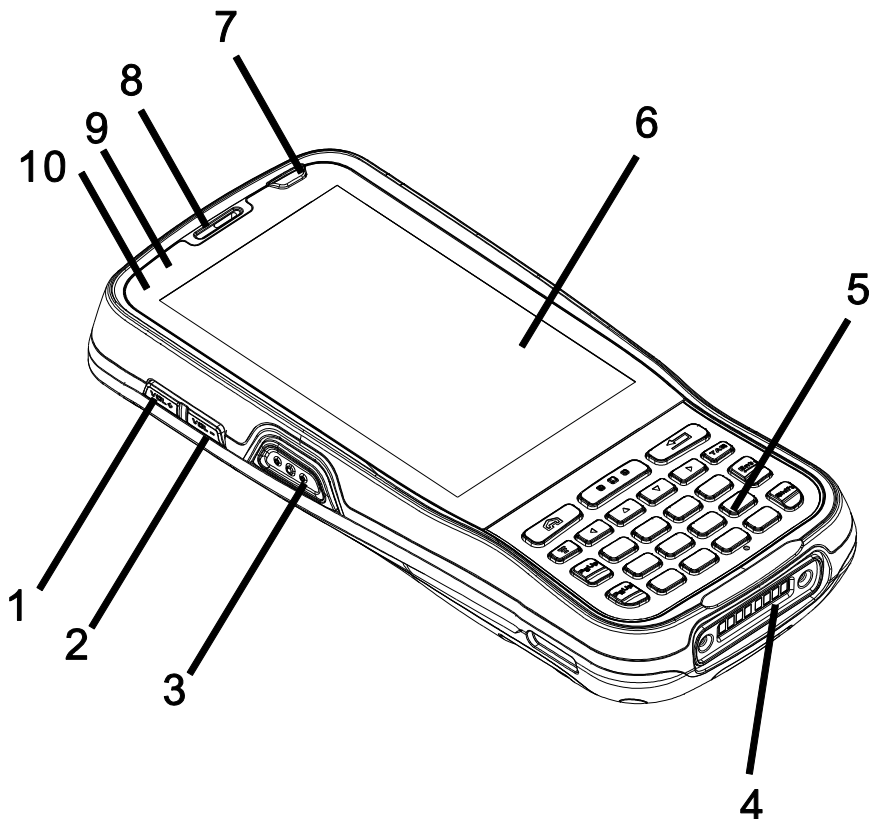

1	Volume+	2	Volume-
3	Left Scan Key	4	Cradle Connector
5	Keypad	6	Capacitive Touch Screen
7	Power Key	8	Earpiece
9	Blue LED	10	Red LED

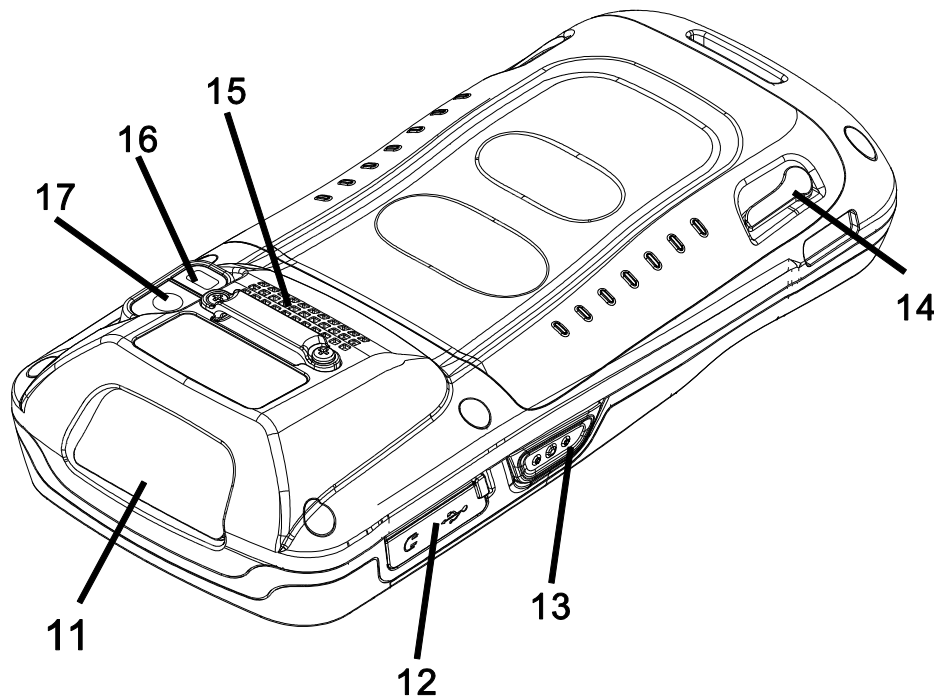

11 Scan Window

12 Protective Cover for USB Port/Headset Connector

13 Right Scan Key

14 Battery Cover Latch

15 Speaker

16 Flashlight

17 Camera

Cradle

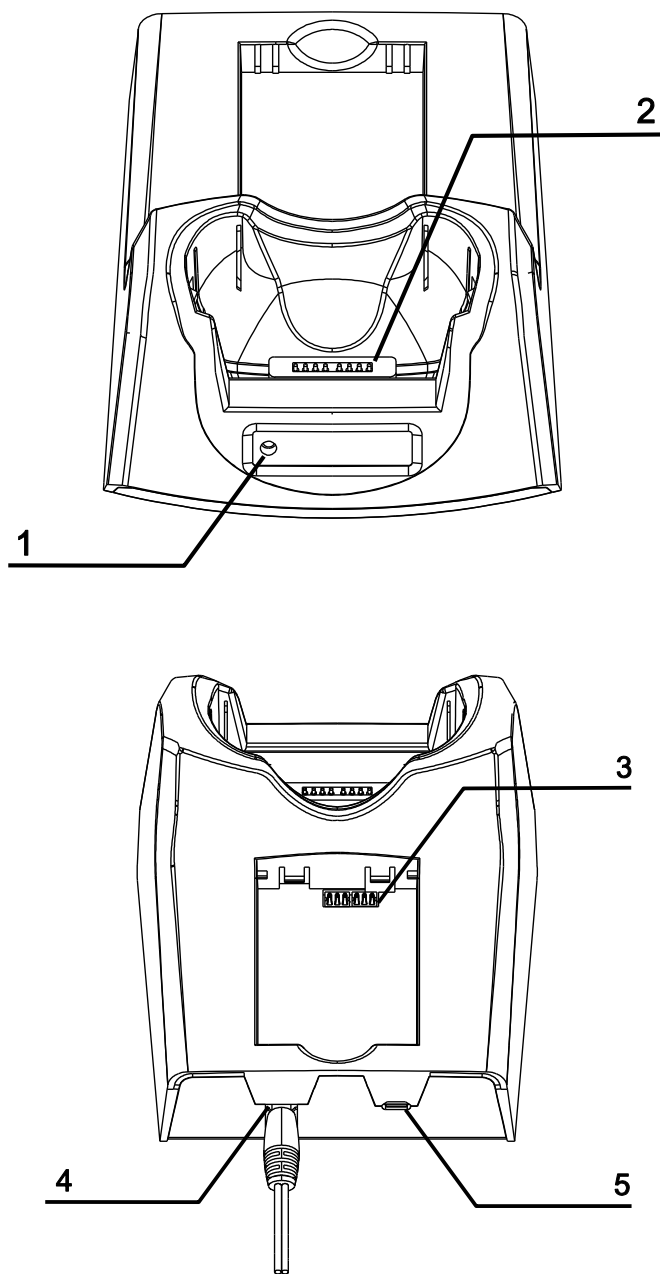

1 Charging LED

2 MT65 Connector

3 Battery Compartment

4 Power Jack

5 Micro USB Port

Installing the Battery

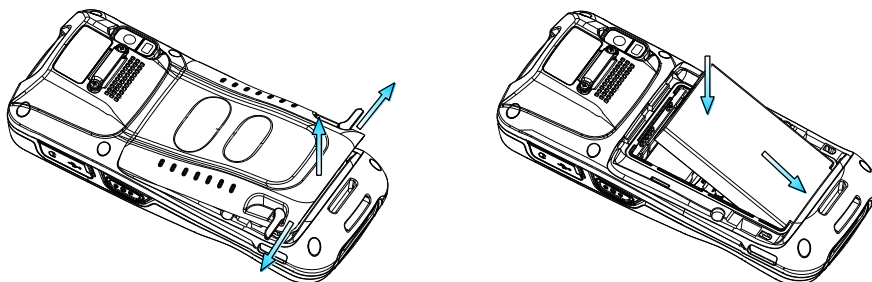

Step 1: Move the battery cover latch to the open position as shown in the figure above and then remove the cover.

Step 2: Place the battery as indicated in the battery compartment.

Removing the Battery

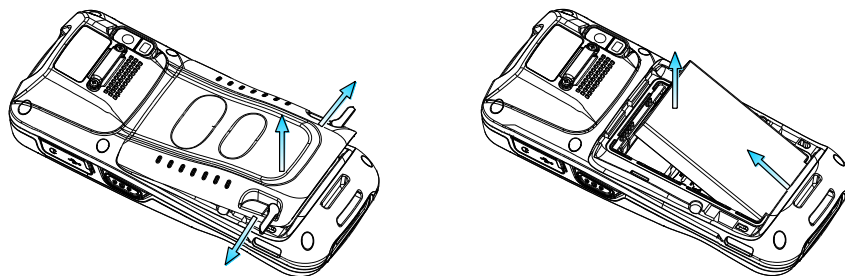

Step 1: Turn off the terminal. Remove the hand strap. Move the battery cover latch to the open position and remove the cover.

Step 2: Remove the battery.

Charging the Battery

There are two methods to charge the battery:

- ✧ Charge with AC adapter: Connect the MT65 to a power outlet using the included AC adapter. It takes 4.5-5 hours to fully charge the terminal (The terminal is shut down or in sleep mode).



Note: Low battery may result in malfunction of the MT65. Before your first use, charge the battery for at least 8 hours.

- ✧ Charge with cradle: Insert the MT65 in the charging slot or place the battery in the battery compartment on the cradle. Connect the cradle to a power outlet using the included AC adapter (for the cradle).

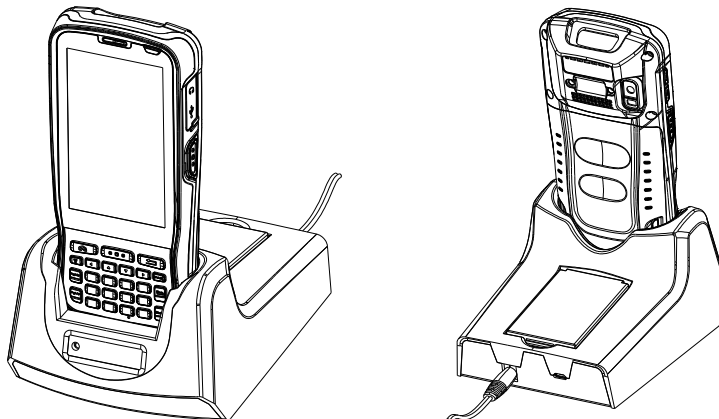

Note: When the battery is dead or juice too low to power on the MT65, charge the terminal for 15 minutes before using it.

Charging LED

✧ Charge with AC adapter:

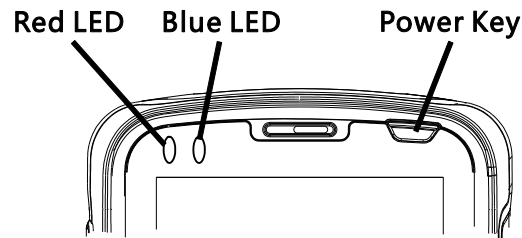

MT60's LEDs for indicating charging/battery statuses	
Blue LED on	Fully charged
Red LED on	Charging in progress
Red LED flashes constantly	Low-battery alert

Note: When the battery is dead or juice too low to power on the MT65, charge the terminal for 15 minutes before using it.

✧ Charge with cradle:

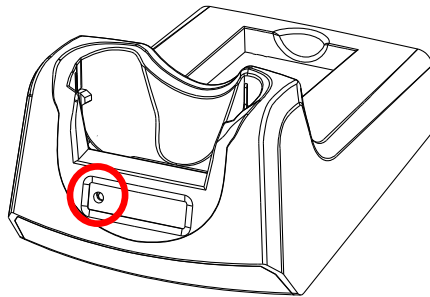

Indications of Charging LED on Cradle	
Green LED on	Fully charged
Red LED on	Charging in progress
LED off	Battery not found

Note: The cradle's Charging LED only indicates the charge statuses of the battery. When charging the MT65 with the cradle, the user is notified of charge statuses of the terminal by the LEDs on the terminal.

Keypad

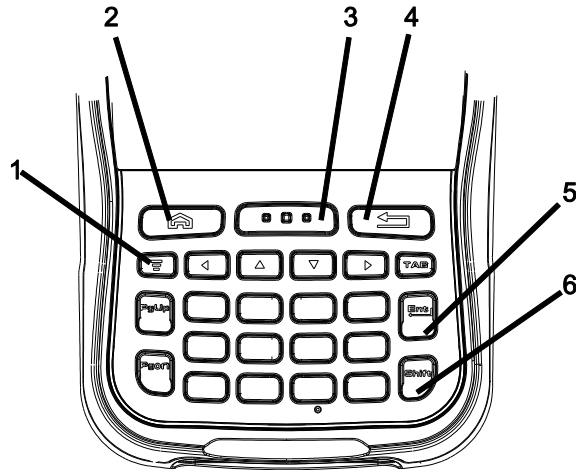

1	Menu Key	2	Home Key
3	Scan Key	4	Return Key
5	Enter Key	6	Number-Function Switch

The MT65 has 30 keys including function, numeric, navigation and scan keys.

Home Key: Press it to go to the first Main Screen.

Press and hold the key to display the app(s) most recently used. Tap an app to open it.

Return Key: Press it to go back to the previous screen.

Menu Key: Press it to display the menu related to an on-screen item.

Number-Function Switch: Press it to toggle between numeric (white) and function (orange) keys.

Communicating with PC

Step 1: Connect the Micro USB port on the MT65 to your computer with the included USB cable.

Step 2: Switch the MT65 on. On the Home screen, swipe from top to bottom with one finger in one smooth motion to reveal the notification bar as shown below.

Step 3: Tap “Connected as a media device”.

Step 4: Select “Media device (MTP)”. Navigate to the “My Computer” section of your computer and look for the newly added drive. Double-click it and you will be connected to the MT65. Then you may handle the files on the terminal through your computer.

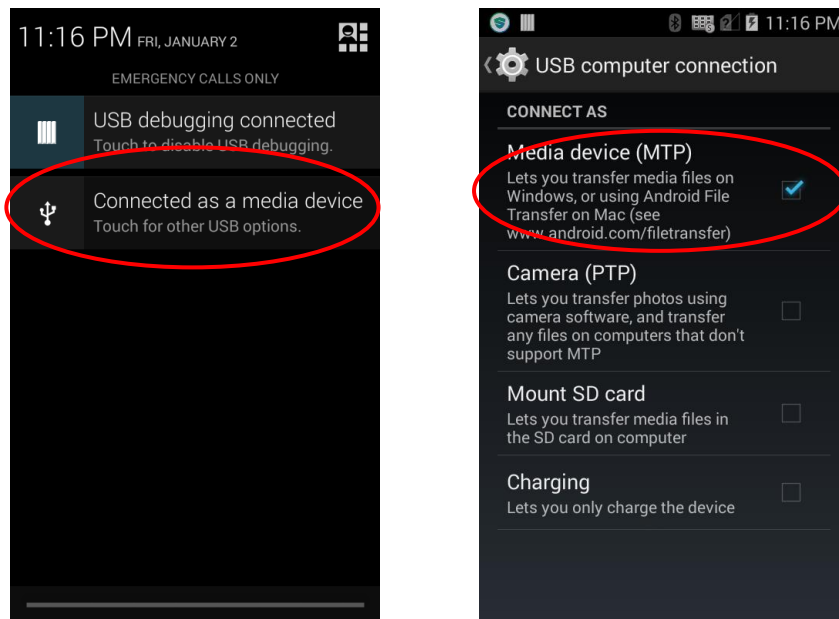

Installing the MicroSD Card/Micro SIM Card

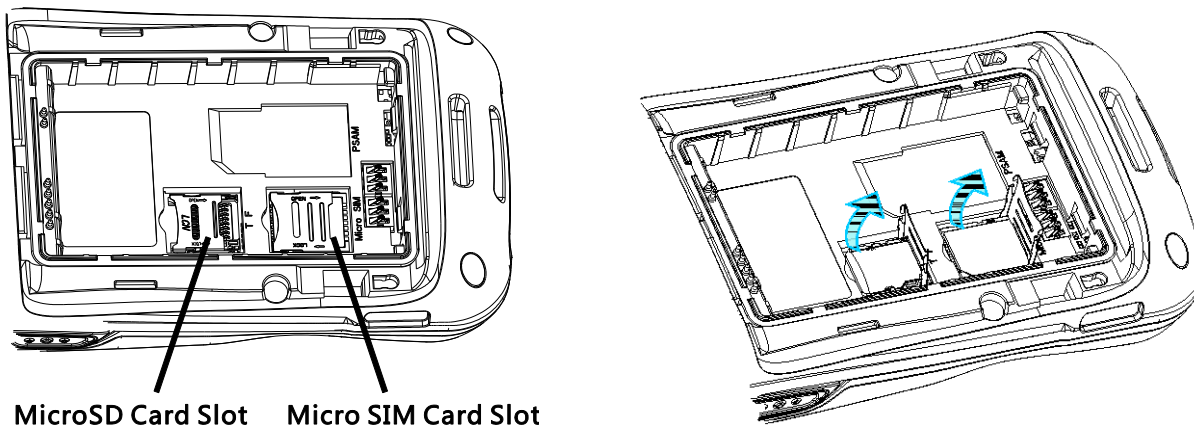

Step 1: Remove the hand strap, battery cover and battery. Lift up the slot cover.

Step 2: Insert the MicroSD card/ Micro SIM card into the holder, with its metal contacts facing down.

Step 3: Close the slot cover.

Chapter 3 Basics

Switching On/ Rebooting/ Switching Off the MT65

After installing the SIM card and battery and having the MT65 fully charged, you may switch the terminal on.

Switch the MT65 on: Press and hold the Power Key  for a while. Note that the initialization is going to take some time before the MT65 displays the Home screen.

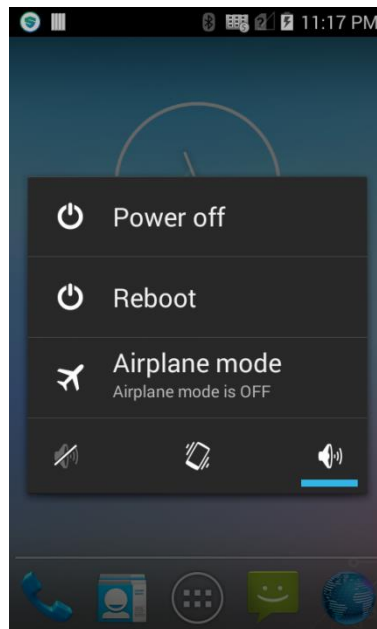

Reboot the MT65: Press and hold the Power Key  until the window below pops up, and tap “Reboot” then “OK”.

Switch the MT65 off: Press and hold the Power Key  until the window below pops up, and tap “Power off” then “OK”.



Locking/Unlocking the MT65

Lock the MT65: Press the Power Key . If no operation is performed on the MT65 for a preset period of time, the MT65 locks automatically. You can change how long it takes the screen to lock.

Unlock the MT65: Press the Power Key , then drag  on the screen rightwards.

Home Screen

The MT65 has 5 home screens.

View another home screen: Swipe left or right.

Go to the Home screen: Press the Home Key.

Open an app: Tap it.

View all apps/Open apps list: Tap .

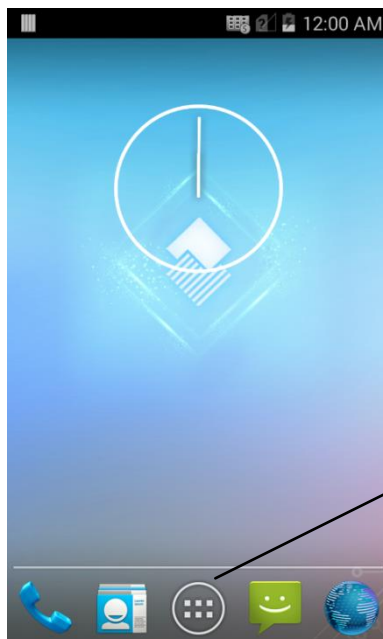











Add an app icon to the Home screen: Tap  on the Home screen. Tap and hold your desired app until it appears on the Home screen and then drag it into a blank area.

Delete an app icon on the Home screen: Tap and hold your desired app on the Home screen until "X Remove" appears, then drag the app into it. Note that this operation only removes the icon from the Home screen. To remove the app from the MT65, see the **Uninstalling App** section.

Status Icons

The icons in the status bar at the top of the screen give information about the MT65.

Status Icon	Description	Status Icon	Description
	Vibrate ON		2G signal strength
	Mute mode		Airplane mode
	USB connected		USB debugging
	Missed calls		Battery charging in progress
	New messages		Battery fully charged

Installing App

Use one of the following methods to install a new app on the MT65:

1. Download an APK file from online app store and install it.
2. Download software package onto a MicroSD card or PC and copy it to your terminal. Then install it with File Manager.
3. Connect the MT65 to PC with the supplied USB cable. Install a new app using the mobile assistant (such as Baidu Mobile Assistant) installed on the PC.

Uninstalling App

Follow the procedure below to remove an app from the MT65:



Tap  on the Home screen to view all apps. Tap and hold your desired app until a trash bin appears at the top left corner of the screen, then drag it into the trash bin.

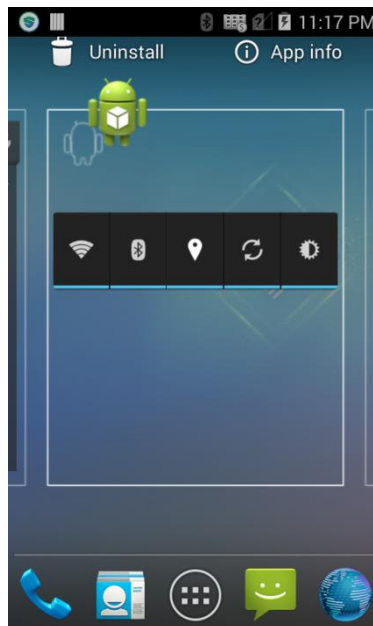

Date & Time

You can change the date and time on the MT65.



Set the date and time: Tap the app icon and then “Date & time”, and set the date and time on the screen shown below as per your needs.

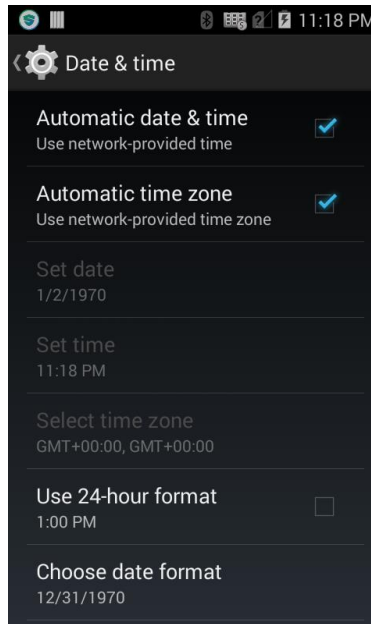

Display



Tap the app icon  and then “Display”, and set the brightness, wallpaper, sleep timer, font size or other item on the screen shown below as per your needs.

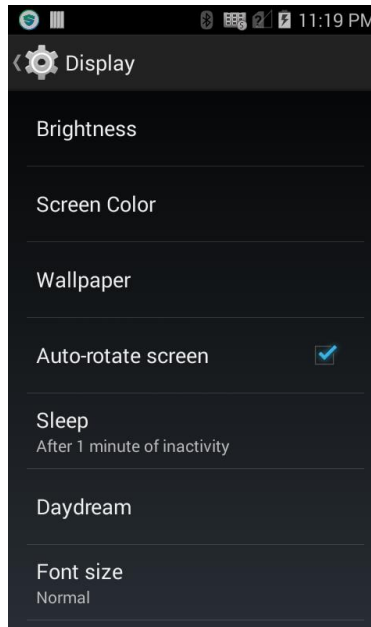

Ringtones



Tap the app icon  and then “Sound”, and set the ringtones and other notification sounds as per your needs.

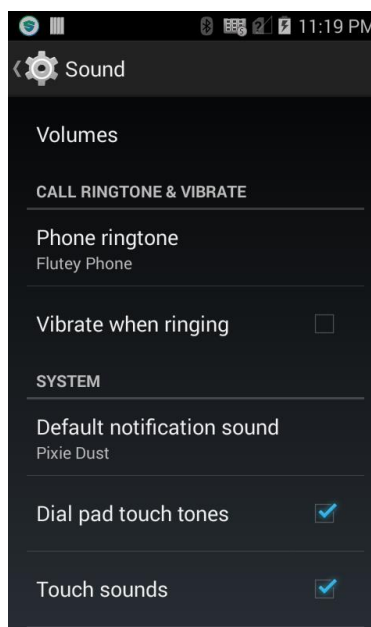

Restoring Factory Settings

Tap the app icon  -> "Backup & reset" -> "Factory data reset" -> "Reset phone" -> "Erase everything".

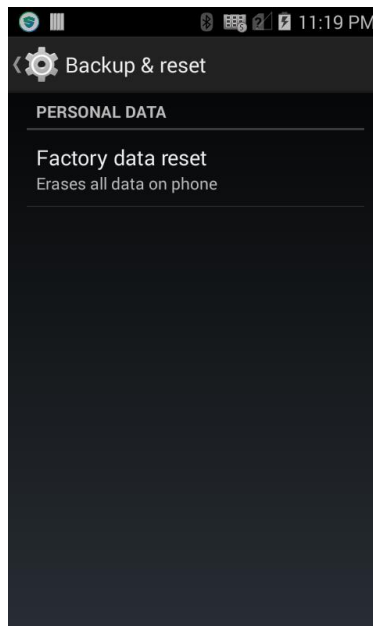

To restore the terminal to factory settings and delete all the data on the internal storage, such as music, photos, select "Erase internal storage" before tapping "Reset phone".

Language & Input Method

Change the language: Tap the app icon  -> “Language & input” -> “Language” -> your desired language.

Change the input method: Tap the app icon  -> “Language & input” -> “Default” -> your desired input method.

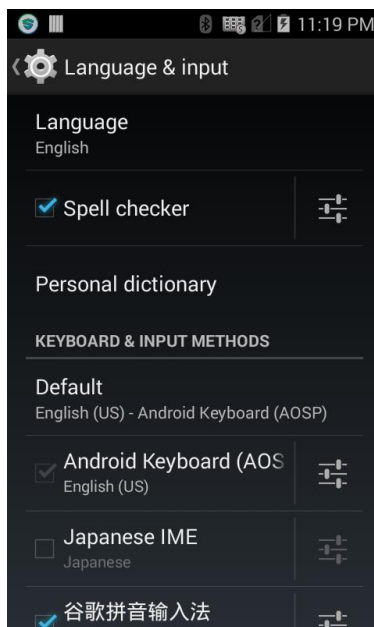

Shortcuts to Apps

Create a shortcut to an app on your Home screen: Tap  on the Home screen. Tap and hold your desired app and then drag it into the home screen.

Widgets

View all widgets: Tap  on the Home screen, then swipe left or tap “WIDGETS”.

Open a widget: Tap it.

Add a widget icon to the Home screen: Tap  on the Home screen then “WIDGETS” . Tap and hold your desired widget and then drag it into the home screen.

Chapter 4 Scanning Barcodes

Scanning 1D Barcode

Adjust the scan angle or the distance between the MT65 and the target barcode to ensure the length of laser beam is roughly 8mm greater than that of the barcode, as shown below.

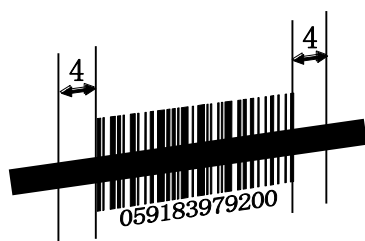

Correct	Wrong
	
	
	

Scanning 2D Barcode

Adjust the scan angle and the distance between the MT65 and the target barcode to make them fall into the following ranges:

- 1) Point the MT65's focus lamp at the center of the barcode.
- 2) Move the MT65 until you find the appropriate scan distance.
- 3) Optimum scan angles:
Pitch (α) < 45° (0° preferably)
Skew (γ) < 45° (5° - 20° preferably)
Roll (β) = 0° - 360°

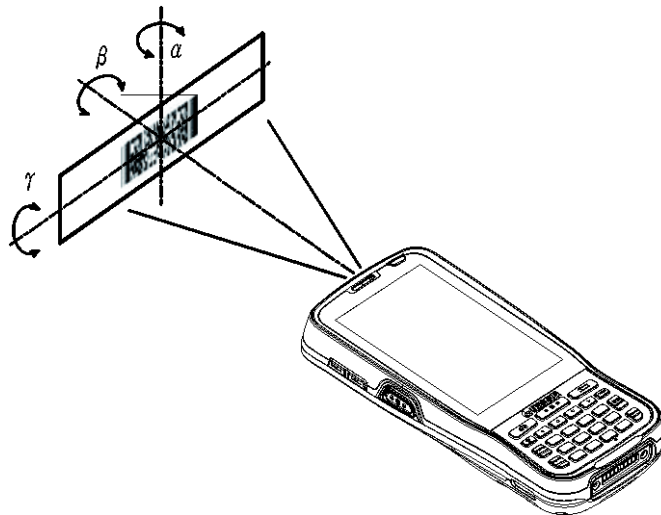

Programming Scanner



Tap the app icon **Scanner** to start scanner configuration.

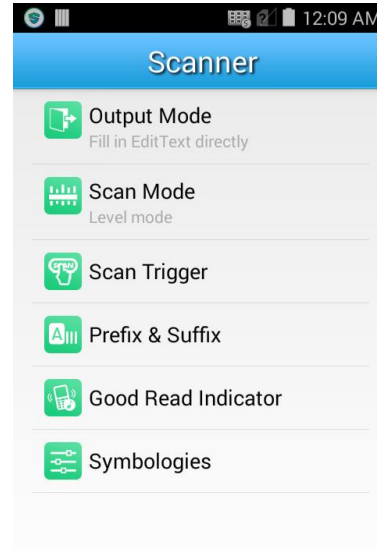
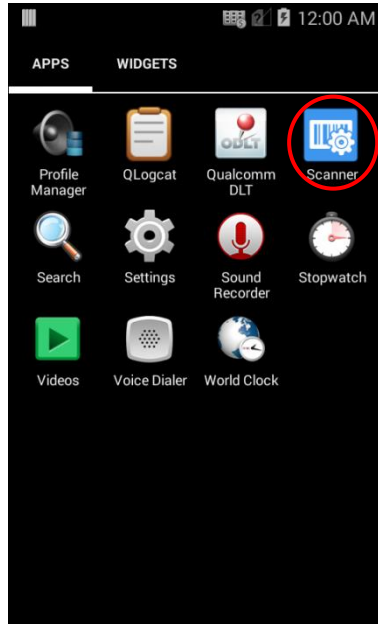

◇ Output Mode

1. **Simulate keystroke:** Output scanned data to keyboard buffer to simulate keyboard input.
2. **Output via API:** Application acquires scanned data by receiving system broadcasts. For more information, see **Barcode Scanner SDK Handbook**.
3. **Fill in EditText directly:** Output scanned data at the current cursor position in EditText.

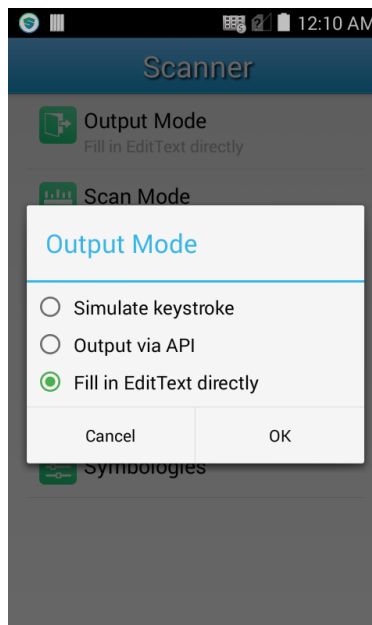

✧ **Scan Mode**

1. **Level mode:** Press the Scan key to start a decode session which continues until the key is released.
2. **Pulse mode:** Press the Scan key to start a decode session which continues until the decode session timeout expires.

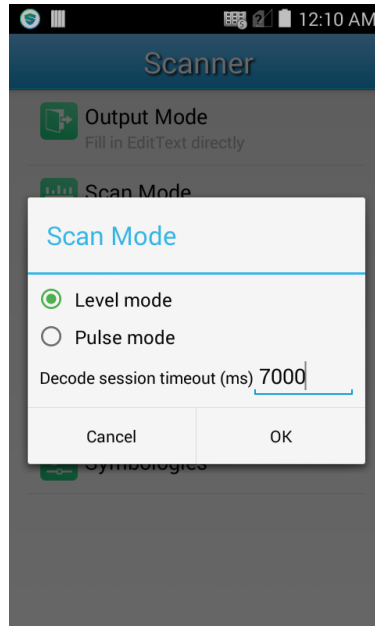

✧ **Scan Trigger**

Set the key to be used as scan trigger.

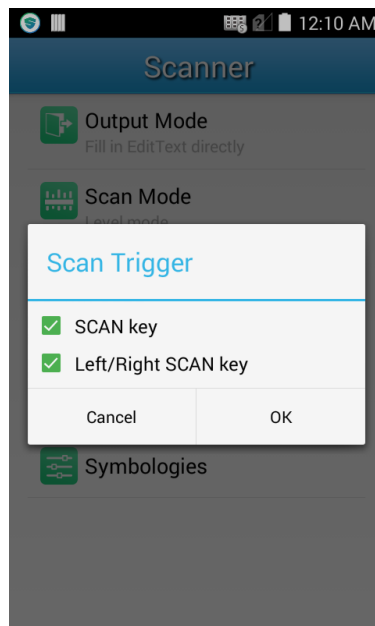

✧ **Prefix & Suffix**

To set the prefix/suffix, enter the hexadecimal value of a desired prefix/suffix and then tap “OK”.

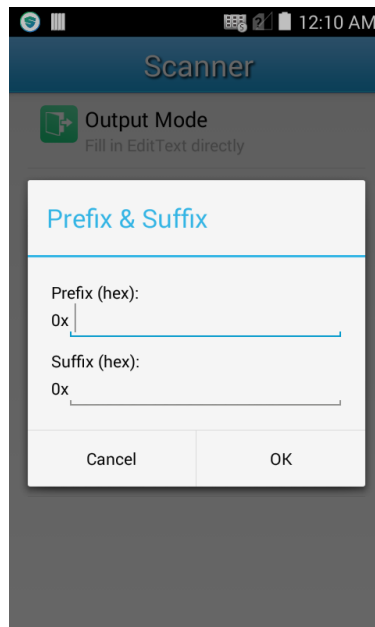

✧ **Good Read Indicator**

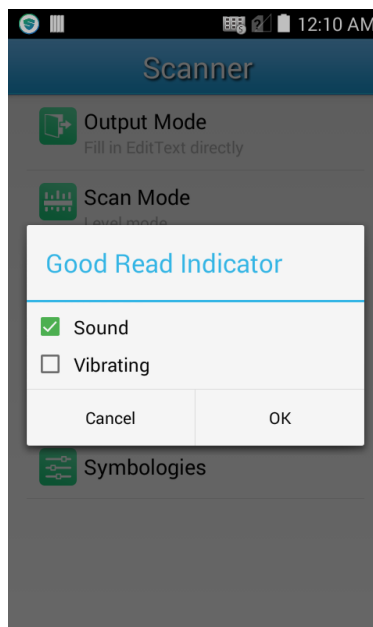

✧ **Symbologies**

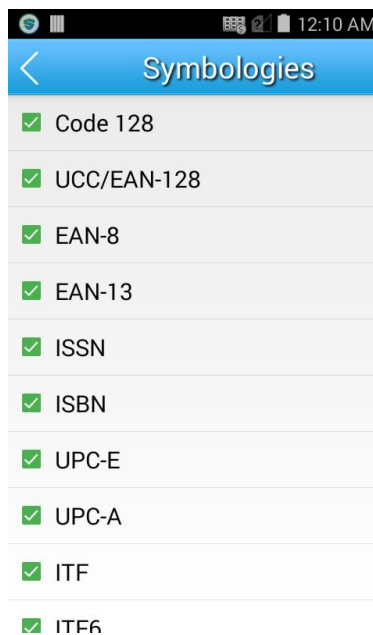

Enable or disable the barcode symbologies.

1D	Laser ($\geq 4\text{mil}$)	EAN-13, EAN-8, UPC-A, UPC-E, ISSN, ISBN, Codabar, Code 11, Code 128, Code 32 Pharmaceutica, Code39, Code 93, ITF-6, ITF-14, Interleaved 2 of 5, Matrix 2 of 5, Straight 2 of 5 IATA, Straight 2 of 5 Industrial, GS1 Databar, GS1-128, MSI-Plessey, Plessey, Telepen, Australian Post, British Post, Canadian Post, China Post, InfoMail, Intelligent Mail Bar Code, Japanese Post, KIX Post, Korea Post, Planet Code, Postal-4i, Postnet.
	CCD ($\geq 4\text{mil}$) (optional)	EAN-13, EAN-8, UPC-A, UPC-E, ISSN, ISBN, Codabar, Code 128, Code 93, ITF-6, ITF-14, Interleaved 2 of 5, Industrial 2 of 5, Standard 2 of 5, Matrix 2 of 5, GS1 Databar, Code 39, Code 11, MSI-Plessey, Plessey.
2D	CMOS ($\geq 5\text{mil}$) (optional)	UPC, EAN, GS1 DataBar, Code 39, Code 128, Code 93, Code 11, Interleaved 2 of 5, Industrial 2 of 5, Matrix 2 of 5, MSI/Plessey, Plessey, PDF417, QR Code, Data Matrix, Chinese Sensible Code, Grid Matrix, Aztec, Maxicode, UCC Composite.





Chapter 5 Phone & Messages



Making Calls



Make a call: Tap the app icon  on the home screen then , enter a phone number using the physical or on-screen keypad, then tap  on the screen.

To end the call, tap  on the screen.

Contacts



Add a new contact: Tap the app icon  on the Home screen then , fill in the information of a new contact, and then tap “√ DONE”.



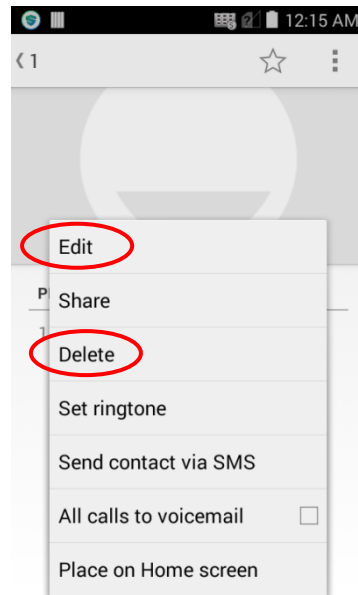
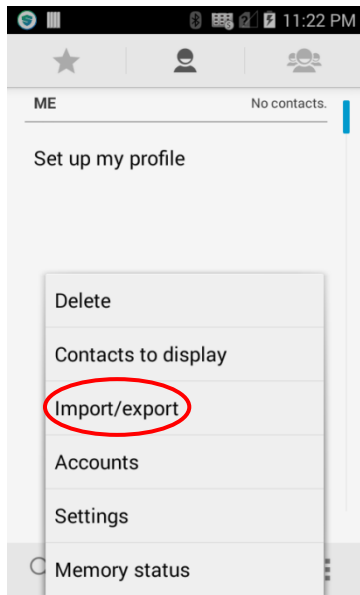

Import/export contacts: Tap the app icon  on the Home screen, press the Menu key  on the MT65, choose “Import/export” from the menu that appears, then follow the instructions on the screen to complete the operation.

Edit/delete contact: Tap the app icon  on the Home screen, choose a contact, press the Menu key  on the MT65, select “Edit”/“Delete” from the menu that appears, then follow the instructions on the screen to complete the operation.



SMS and MMS Messages

Send an SMS message: Tap the app icon  on the Home screen then , enter the recipient(s) and text, and tap .

Send an MMS message: Tap the app icon  on the Home screen then , enter the recipient(s) and text, press the Menu key  on the MT65 and select "Add subject" from the menu that appears, then enter the subject. To add a picture or an audio/video clip, tap  and select your desired multimedia file. Tap .

Chapter 6 Mobile Network

Introduction

The MT65 can also use GPRS/EDGE network to connect to the Internet. To establish GPRS/EDGE connection, you must have a Micro SIM card installed in your MT65.

The MT65 supports GPRS, EDGE .

Chapter 7 Others

Camera

Launch the Camera app on your terminal.



: Tap it to reveal the parameters such as flashlight mode, exposure and white balance and set those parameters as per your needs.



: Tap it and select the Camera/ Panorama/ Video Recorder mode.



: Tap it to take a normal or panoramic photo/ start or stop a video recording.



: Tap the thumbnail image in the upper right corner of the screen to view the photo or video saved.

You can also download a camera app from the Internet or develop an app for the camera feature.

Chapter 8 App Development Guide

Development Environment

The MT65 runs on Android 4.4 operating system and it is recommended to use Android SDK 4.0 to 4.4 and Eclipse 3.7.2 or higher when developing apps for the MT65.

Use of Non-standard Interfaces

See *Barcode Scanner SDK Handbook*.

Chapter 9 Maintenance & Troubleshooting

Introduction

This chapter includes important safety and handling information and provides troubleshooting solutions for issues that might occur when using the terminal.

Important Safety & Handling Information

Disassembly and Retrofit

Do not disassemble or retrofit the terminal by yourself. Unauthorized disassembly or retrofit will void the warranty.

External Power Supply

Use only the included AC adapter. Otherwise there is a risk of damage to the terminal.

Abnormal Situation

Keep the terminal away from fire or heat sources. If there is unusual odor, overheating or smoke during charging, immediately cut off the power and disconnect the AC adapter, and contact your dealer or Newland customer service center. Continued use in this case may result in fire or electric shock.

Drop Damage

If the terminal is damaged due to a drop from high place, immediately cut off the power and contact your dealer or Newland customer service center.

LCD Screen

Do not press against or strike the LCD screen. Otherwise it may damage the screen. When handling a cracked or shattered screen, do not touch the liquid that has leaked from it to avoid skin burn or infection.

Stacking Heavy Objects

Do not place heavy objects on the terminal as those objects may fall and cause injury.

Mounting Location

Do not place the terminal on unstable or uneven surfaces as it may fall and cause injury. Do not expose the terminal to humidity or dust as this may cause fire or electric shock. Do not expose the terminal to direct sunlight for extended periods.

Wireless Functionalities

Do not use the terminal's wireless functionalities where wireless device use is prohibited or where it may cause interference or danger, such as in aircrafts, petrol stations.

Use & Maintenance

- ✧ If the terminal cannot be switched on after experiencing a sudden or unexpected power loss or other abnormalities, remove and then reinstall its battery to reset the terminal.
- ✧ Do not throw, drop or strike the terminal. Doing so may damage the LCD display, interrupt running programs, cause data loss in memory and result in malfunction.
- ✧ Clean the scan window regularly. Do not touch it with hands. Scratched or smudged window may degrade reading performance.
- ✧ Do not tap the touch screen with sharp objects. Doing so may damage the screen or cause internal short circuits.
- ✧ Use only a dry soft cloth to clean the terminal. Cleaning it with wet cloth or benzene/ thinner/ other volatile chemicals may deform and shorten the service life of the keypad and shell of the terminal.
- ✧ Do not place the terminal facedown on any surface, or there might be misoperations.
- ✧ Sudden temperature drops may cause condensation on the shell which could cause malfunction. Care should be taken to avoid condensation. If condensation occurs, dry the terminal before use.
- ✧ Adapter shall be installed near the equipment and shall be easily accessible. The plug considered as disconnect device of adapter.

Battery Safety Guidelines

- ✧ **Do not dispose of batteries in a fire as they may explode.**
- ✧ The battery can be charged and discharged over 500 times. If the battery life is unreasonably short, please replace the battery with a new one.
- ✧ Use only the included battery and AC adapter.
- ✧ Do not continue to charge a battery that is fully charged. Overcharging will shorten battery lifespan. If a fully charged battery is not used, it will discharge slowly, which does not affect its normal use.
- ✧ Do not use damaged or dysfunctional AC adapters or batteries.

- ✧ Properly dispose of and recycle batteries. Do not dispose of them as household garbage.

Troubleshooting

Problem		Possible Cause & Solution
Type	Description	
Keypad	Unresponsive keypad or incorrect response to any key entry.	This problem may be caused by unreliable cable connection between keypad and mainboard or keypad malfunction. Please contact Newland after-sales service.
Battery	Charging LED is OFF when charging.	Ensure the AC adapter is plugged in properly.
	Noticeably short battery life.	<ol style="list-style-type: none"> 1. Check the battery level. If the battery is almost depleted, recharge it. 2. Replace the battery if it is dysfunctional.
	Fully charged battery is depleted after the terminal is switched on.	If the battery is dysfunctional, replace it with a new one.
USB	USB communication failure	<ol style="list-style-type: none"> 1. Ensure that the USB cable connections are secure. 2. Ensure that there is no contaminant inside the Micro USB port. 3. If the problem still remains, please contact the after-sales service center.
LCD Screen	No display	<ol style="list-style-type: none"> 1. Ensure the terminal is switched on. 2. If the terminal is in sleep state, press the Power key to wake it up. 3. Check the battery level. If the battery is depleted, recharge it. 4. Ensure that the battery is properly installed. 5. Replace the battery if it is dysfunctional. 6. If the problem still remains, please contact the after-sales service center.
System	Cannot switch on	<ol style="list-style-type: none"> 1. Check the battery level. If the battery is depleted, recharge it. 2. Switch the terminal on after using the included AC adapter to connect it to a power outlet. If the problem disappears, then continue to charge the terminal. If the problem remains after charging the terminal for a while, replace the battery with a new one.
	System halted	<ol style="list-style-type: none"> 1. The problem may be caused by bugs of downloaded apps. Ensure that only reliable apps are used. 2. The problem may be caused by a sudden or unexpected power loss. Remove and then reinstall its battery to reset the terminal.



Headquarters

Fujian Newland Auto-ID Tech. Co., Ltd.

3F, Building A, No.1, Rujiang West Rd., Mawei, Fuzhou,

Fujian, China 350015

TEL: +86 - (0) 591-83979222

FAX: +86 - (0) 591-83979208

E-mail: marketing@nlscan.com

WEB: www.nlscan.com

Newland Europe BV

Rolweg 25, 4104 AV Culemborg, The Netherlands

TEL: +31 (0) 345 87 00 33

FAX: +31 (0) 345 87 00 39

Email: sales@newland-id.com

WEB: www.newland-id.com

Tech Support: tech-support@newland-id.com

Newland North America Inc.

Address: 46559 Fremont Blvd., Fremont, CA 94538, USA

TEL: 510 490 3888

Fax: 510 490 3887

Email: info@newlandna.com

WEB: www.newlandna.com

Newland Taiwan Inc.

7F-6, No. 268, Liancheng Rd., Jhonghe Dist. 235, New

Taipei City, Taiwan

TEL: +886 2 7731 5388

FAX: +886 2 7731 5389

Email: sales.tw@newland-id.com

WEB: www.newland-id.com.tw

FCC Warning:

This equipment has been tested and found to comply with the limits for a Class B digital device, pursuant to part 15 of the FCC Rules. These limits are designed to provide reasonable protection against harmful interference in a residential installation. This equipment generates, uses and can radiate radio frequency energy and, if not installed and used in accordance with the instructions, may cause harmful interference to radio communications. However, there is no guarantee that interference will not occur in a particular installation. If this equipment does cause harmful interference to radio or television reception, which can be determined by turning the equipment off and on, the user is encouraged to try to correct the interference by one or more of the following measures:

- Reorient or relocate the receiving antenna.
- Increase the separation between the equipment and receiver.
- Connect the equipment into an outlet on a circuit different from that to which the receiver is connected.
- Consult the dealer or an experienced radio/TV technician for help.

Caution: Any changes or modifications to this device not explicitly approved by manufacturer could void your authority to operate this equipment.

This device complies with part 15 of the FCC Rules. Operation is subject to the following two conditions: (1) This device may not cause harmful interference, and (2) this device must accept any interference received, including interference that may cause undesired operation.

FCC RF Exposure Information and Statement The SAR limit of USA (FCC) is 1.6 W/kg averaged over one gram of tissue. Device types: Tablet POS (FCC ID: SL9NLS-MT65) has also been tested against this SAR limit. The highest SAR value reported under this standard during product certification for use at the ear is 0.340W/kg and when properly worn on the body is 0.361W/kg. This device was tested for typical body-worn operations with the back of the handset kept 00cm from the body. To maintain compliance with FCC RF exposure requirements, use accessories that maintain a 00cm separation distance between the user's body and the back of the handset. The use of belt clips, holsters and similar accessories should not contain metallic components in its assembly. The use of accessories that do not satisfy these requirements may not comply with FCC RF exposure requirements, and should be avoided.

CE Warning:

1. Use carefully with earphones; excessive sound pressure from earphones and headphones can cause hearing loss.



2. Caution: Risk of explosion if battery is replaced by an incorrect type. Dispose of used batteries according to the instructions.
3. The product shall only be connected to a USB interface of version USB2.0
4. Adapter shall be installed near the equipment and shall be easily accessible.
5. The plug considered as disconnect device of adapter
6. The device complies with RF specifications when the device used at 0cm from your body
7. Extreme temperature: -20~40 centigrade degree.
8. Hereby, Fujian Newland Auto-ID Tech Co.,Ltd. declares that this Portable data collector is in compliance with essential requirements and other relevant provisions of Directive 1999/5/EC.