

Please see "Users Manual 2.pdf" for FCC manual statements.



Copyright

## Copyright & Trademark Information

Fujitsu Computer Systems Corporation has made every effort to ensure the accuracy and completeness of this document. However, as ongoing development efforts are continually improving the capabilities of our products, we cannot guarantee the accuracy of the contents of this document. We disclaim liability for errors, omissions, or future changes.

Fujitsu, the Fujitsu logo, and LifeBook are registered trademarks of Fujitsu Limited.

Microsoft, MS-DOS, and Windows are either registered trademarks or trademarks of Microsoft Corporation in the United States and/or other countries.

Atheros and Super AG are registered trademarks of Atheros Communications, Inc.

The Bluetooth trademark is owned by Bluetooth SIG, Inc., USA.

Adobe, Acrobat, and Acrobat Reader are either registered trademarks or trademarks of Adobe Systems Incorporated in the United States and/or other countries.

Realtek is a trademark of Realtek Semiconductor Corporation.

All other trademarks mentioned herein are the property of their respective owners.

© Copyright 2005 Fujitsu Computer Systems Corporation. All rights reserved. No part of this publication may be copied, reproduced, or translated, without prior written consent of Fujitsu Computer Systems Corporation. No part of this publication may be stored or transmitted in any electronic form without the written consent of Fujitsu Computer Systems Corporation.

B6FH-6861-01EN-00

### WARNING



Handling the cord on this product or cords associated with accessories sold with this product, will expose you to lead, a chemical known to the State of California to cause birth defects or other reproductive harm.

**Wash hands after handling.**



### DECLARATION OF CONFORMITY

according to FCC Part 15

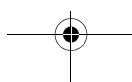
Responsible Party Name: Fujitsu Computer Systems Corporation

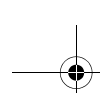
Address: 1250 E. Arques Avenue, MS 122  
Sunnyvale, CA 94085

Telephone: (408) 746-6000

Declares that product: Model Configuration:  
LifeBook P1510D Notebook  
Complies with Part 15 of the FCC Rules.

This device complies with Part 15 of the FCC rules. Operations are subject to the following two conditions:  
(1) This device must not be allowed to cause harmful interference, (2) This device must accept any interference received, including interference that may cause undesired operation.





### IMPORTANT SAFETY INSTRUCTIONS

This unit requires an AC adapter to operate. Use only UL Listed Class 2 Adapters with an output rating of 16 VDC, with a current of 2.5 A.

AC adapter output polarity:



When using your notebook equipment, basic safety precautions should always be followed to reduce the risk of fire, electric shock and injury to persons, including the following:

- Do not use this product near water for example, near a bathtub, washbowl, kitchen sink or laundry tub, in a wet basement or near a swimming pool.
- Avoid using the modem during an electrical storm. There may be a remote risk of electric shock from lightning.
- Do not use the modem to report a gas leak in the vicinity of the leak.
- Use only the power cord and batteries indicated in this manual. Do not dispose of batteries in a fire. They may explode. Check with local codes for possible special disposal instructions.
- To reduce the risk of fire, use only No. 26 AWG or larger UL Listed or CSA Certified Telecommunication Line Cord.

SAVE THESE INSTRUCTIONS

### For Authorized Repair Technicians Only



Danger of explosion if Lithium (clock) battery is incorrectly replaced. Replace only with the same or equivalent type recommended by the manufacturer. Dispose of used batteries according to the manufacturer's instruction.

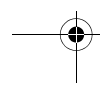
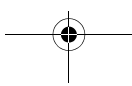


For continued protection against risk of fire, replace only with the same type and rating fuse.

### System Disposal



LAMP(S) INSIDE THIS PRODUCT CONTAIN MERCURY AND MUST BE RECYCLED OR DISPOSED OF ACCORDING TO LOCAL, STATE, OR FEDERAL LAWS.





# Fujitsu LifeBook® P Series Notebook Table of Contents

## 1

### PREFACE

#### Preface

|                                       |   |
|---------------------------------------|---|
| About This Guide . . . . .            | 3 |
| Fujitsu Contact Information . . . . . | 3 |
| Warranty . . . . .                    | 3 |

## 2

### GETTING TO KNOW YOUR LIFEBOOK

#### Overview

|                                |   |
|--------------------------------|---|
| Unpacking . . . . .            | 7 |
| Optional Accessories . . . . . | 7 |

#### Locating the Controls/Connectors

|  |    |
|--|----|
| Front and Display Components . . . . . | 9  |
| Left-Side Panel Components . . . . .   | 10 |
| Right-Side Panel Components . . . . .  | 11 |
| Rear Panel Components . . . . .        | 12 |
| Bottom Components . . . . .            | 13 |

#### Status Indicators

|   |    |
|---|----|
| Power Indicator . . . . .                       | 14 |
| AC Adapter/Battery Charging Indicator . . . . . | 14 |
| Battery Level Indicator . . . . .               | 14 |
| Hard Drive Access Indicator . . . . .           | 14 |
| NumLk Indicator . . . . .                       | 15 |
| CapsLock Indicator . . . . .                    | 15 |
| ScrLk Indicator . . . . .                       | 15 |

#### Display Panel

|  |    |
|--|----|
| Opening the Display Panel . . . . .          | 16 |
| Using the System as a Tablet . . . . .       | 16 |
| Adjusting Display Panel Brightness . . . . . | 17 |

#### Keyboard

|                              |    |
|------------------------------|----|
| Using the Keyboard . . . . . | 18 |
| Numeric Keypad . . . . .     | 18 |
| Windows Keys . . . . .       | 18 |
| Cursor Keys . . . . .        | 18 |
| Function Keys . . . . .      | 19 |

#### LifeBook Application Panel

|                                     |    |
|-------------------------------------|----|
| Changing Button Functions . . . . . | 21 |
|-------------------------------------|----|

#### Quick Point/Touch Screen

|  |    |
|--|----|
| Clicking . . . . .                       | 22 |
| Double-Clicking . . . . .                | 22 |
| Dragging . . . . .                       | 22 |
| Quick Point Control Adjustment . . . . . | 23 |
| Touch Screen . . . . .                   | 23 |

#### Volume Control

|                                  |    |
|----------------------------------|----|
| Controlling the Volume . . . . . | 25 |
|----------------------------------|----|

## 3

### USING YOUR LIFEBOOK

#### Power Sources

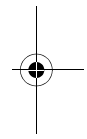
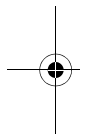
|   |    |
|---|----|
| Connecting the Power Adapters . . . . . | 29 |
|---|----|

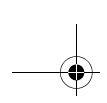
#### Starting Your LifeBook

|  |    |
|--|----|
| Power On . . . . .                           | 30 |
| Boot Sequence . . . . .                      | 30 |
| BIOS Setup Utility . . . . .                 | 30 |
| Booting the System . . . . .                 | 31 |
| Registering Your LifeBook notebook . . . . . | 31 |
| Installing Click Me! . . . . .               | 31 |

#### Power Management

|                                 |    |
|---------------------------------|----|
| Suspend/Resume Button . . . . . | 32 |
| Standby Mode . . . . .          | 32 |
| Hibernate Mode . . . . .        | 33 |
| Display Timeout . . . . .       | 33 |





|                                    |    |
|------------------------------------|----|
| Hard Disk Timeout . . . . .        | 33 |
| Windows Power Management . . . . . | 33 |
| Restarting the System . . . . .    | 33 |
| Power Off . . . . .                | 34 |

## 4

### USER-INSTALLABLE FEATURES

#### Lithium ion Battery

|                                  |    |
|----------------------------------|----|
| Recharging the Battery . . . . . | 37 |
| Replacing the Battery . . . . .  | 38 |

#### Memory Upgrade Module

|   |    |
|---|----|
| Installing Memory Upgrade Modules . . . . . | 39 |
| Removing a Memory Upgrade Module . . . . .  | 39 |
| Checking the Memory Capacity . . . . .      | 40 |

#### Secure Digital Media

|                               |    |
|-------------------------------|----|
| Inserting SD Cards . . . . .  | 41 |
| Removing An SD Card . . . . . | 41 |

#### Compact Flash Cards

|   |    |
|---|----|
| Inserting Compact Flash Cards . . . . . | 42 |
| Removing Compact Flash Cards . . . . .  | 43 |

#### Port Replicator

|                                      |    |
|--------------------------------------|----|
| Port Replicator Components . . . . . | 44 |
| Attaching Port Replicator . . . . .  | 44 |
| Detaching Port Replicator . . . . .  | 44 |

#### Device Ports

|                                      |    |
|--------------------------------------|----|
| Modem (RJ-11) Jack . . . . .         | 46 |
| Internal LAN (RJ-45) jack . . . . .  | 46 |
| Docking Port . . . . .               | 46 |
| Universal Serial Bus Ports . . . . . | 46 |
| Microphone Jack . . . . .            | 46 |
| Headphone Jack . . . . .             | 46 |
| External Video Port . . . . .        | 47 |

## 5

### TROUBLESHOOTING

#### Troubleshooting

|                                   |    |
|-----------------------------------|----|
| Identifying the Problem . . . . . | 51 |
| Specific Problems . . . . .       | 51 |

|                                       |    |
|---------------------------------------|----|
| Troubleshooting Table . . . . .       | 52 |
| Power On Self Test Messages . . . . . | 58 |
| Modem Result Codes . . . . .          | 59 |

#### Restoring Your Pre-installed Software

|  |    |
|--|----|
| Restoring the Factory Image . . . . .              | 60 |
| Automatically Downloading Driver Updates . . . . . | 61 |

## 6

### CARING FOR YOUR LIFEBOOK

#### Care and Maintenance

|  |    |
|--|----|
| LifeBook P Series notebook . . . . .         | 65 |
| Keyboard . . . . .                           | 66 |
| Batteries . . . . .                          | 66 |
| Floppy Disk Drive and Floppy Disks . . . . . | 66 |
| Optional Optical Drive and Discs . . . . .   | 67 |
| CF Cards . . . . .                           | 67 |

## 7

### SYSTEM SPECIFICATIONS

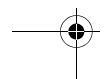
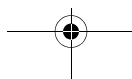
#### Specifications

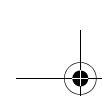
|  |    |
|--|----|
| Configuration Label . . . . .            | 71 |
| Physical Specifications . . . . .        | 71 |
| Processing Specifications . . . . .      | 71 |
| Memory/Storage Specifications . . . . .  | 71 |
| Display Specifications . . . . .         | 71 |
| Interface Specifications . . . . .       | 71 |
| Power Specifications . . . . .           | 72 |
| Environmental Specifications . . . . .   | 72 |
| Agency Approval Specifications . . . . . | 72 |
| Additional Specifications . . . . .      | 72 |
| Regulatory Information . . . . .         | 73 |

## 8

### GLOSSARY

|                    |    |
|--------------------|----|
| Glossary . . . . . | 77 |
|--------------------|----|





**Table of Contents**

**APPENDIX A: INTEGRATED WIRELESS LAN USER'S GUIDE**

**Before Using the Wireless LAN**

Wireless LAN Modes Using this Device . . . . .86  
 Wireless Network Considerations . . . . .87  
 Deactivating the WLAN Device . . . . .87  
 Activating the WLAN Device . . . . .88

**Configuration of the WLAN Device**

Flow of Operations . . . . .89  
 Configuration Using Atheros Client Utility . . . . .89  
 Connection to the network . . . . .90

**Troubleshooting the WLAN**

Troubleshooting Table . . . . .93

**Wireless LAN Glossary**

Glossary . . . . .94

**IP address information**

About IP Addresses . . . . .96

**WLAN Specifications**

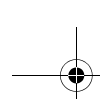
Specifications . . . . .97

**APPENDIX B: USING THE FINGERPRINT SWIPE SENSOR**

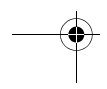
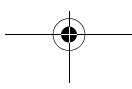
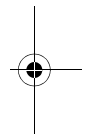
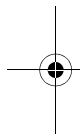
**Fingerprint Sensor Device**

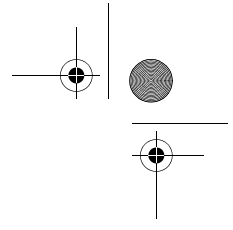
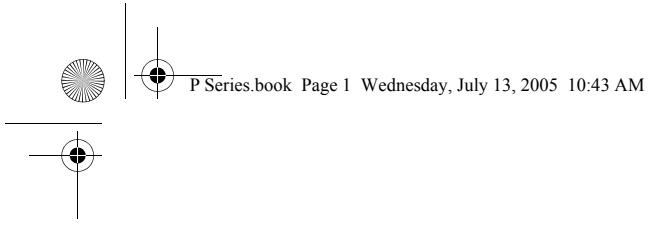
Introducing the Fingerprint Sensor Device . . . . .101  
 Getting Started . . . . .101  
 Installing OmniPass . . . . .101  
 User Enrollment . . . . .102  
 Using OmniPass . . . . .103  
 Configuring OmniPass . . . . .105  
 OmniPass Control Center . . . . .106  
 Troubleshooting . . . . .107



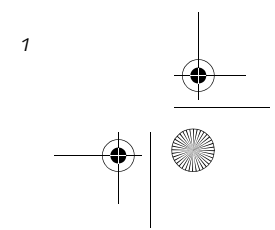
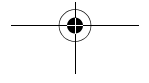
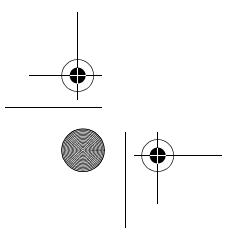
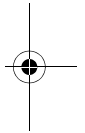
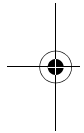


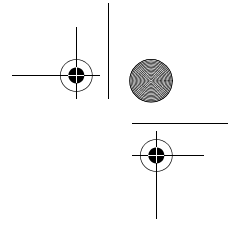
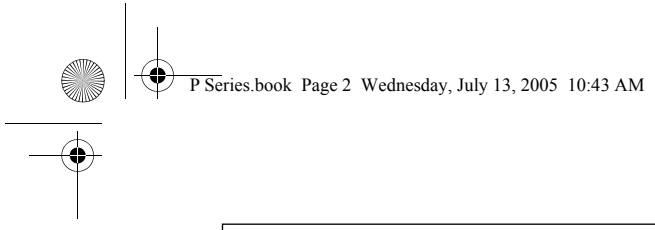
*LifeBook P Series*



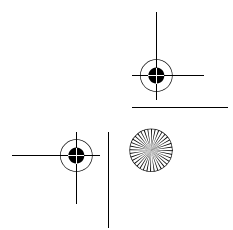
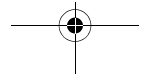
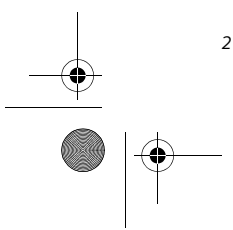
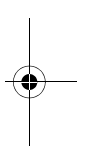
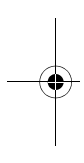


# 1 Preface

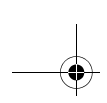




*LifeBook P Series Notebook*







## Preface

### ABOUT THIS GUIDE

The LifeBook® P Series notebook from Fujitsu Computer Systems Corporation is a small yet powerful convertible computer. It can be used either as a standard notebook using keyboard input, or in tablet configuration using pen input. It is powered by an Intel® Pentium® M microprocessor, has a built-in color display with a passive digitizer, and brings the computing power of desktop personal computers (PCs) to a versatile portable environment.

This manual explains how to operate your LifeBook P Series notebook's hardware and built-in system software. Your notebook comes with the Windows® XP operating system pre-installed.

Your LifeBook P Series notebook is a completely self-contained unit with an active-matrix (TFT) color LCD display. The notebook has a powerful interface that enables it to support a variety of optional features.

### Conventions Used in the Guide

Keyboard keys appear in brackets.  
Example: [Fn], [F1], [Esc], [Enter] and [Ctrl].

Pages with additional information about a specific topic are cross-referenced within the text.  
Example: (See page xx.)

On screen buttons or menu items appear in bold.  
Example: Click **OK** to restart your notebook.

DOS commands you enter appear in Courier type.  
Example: Shutdown the computer?



The information icon highlights information that will enhance your understanding of the subject material.



The caution icon highlights information that is important to the safe operation of your computer, or to the integrity of your files. Please read all caution information carefully.



The warning icon warns you about possible hazards that can occur to you, your system, or your files. Please read all warning information carefully.

### FUJITSU CONTACT INFORMATION

#### Service and Support

You can contact Fujitsu Computer Systems Service and Support the following ways:

- Toll free: 1-800-8Fujitsu (1-800-838-5487)
- Fax: 1-408-764-2724
- E-mail: 8fujitsu@us.fujitsu.com
- Web site:  
<http://www.computers.us.fujitsu.com/support>

Before you place the call, you should have the following information ready so that the customer support representative can provide you with the fastest possible solution:

- Product name
- Product configuration number
- Product serial number
- Purchase date
- Conditions under which the problem occurred
- Any error messages that have occurred
- Type of device connected, if any

#### Fujitsu Online

You can go directly to the online Fujitsu Product catalog for your notebook. Go to Start -> Fujitsu Weblinks -> LifeBook Accessories.

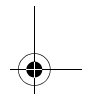
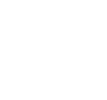
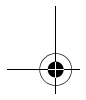
You can also reach Fujitsu Service and Support online by going to Start -> Fujitsu Weblinks -> Fujitsu Service and Support.

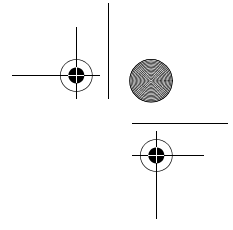
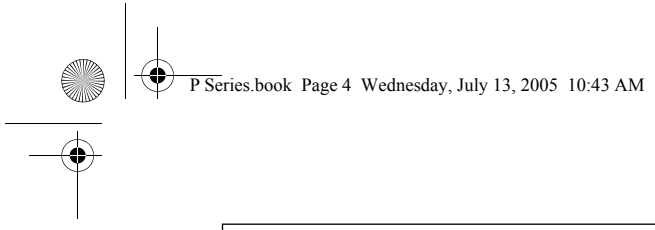


You must have an active internet connection to use the online URL links.

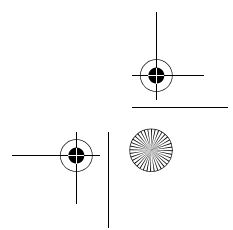
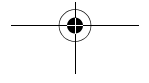
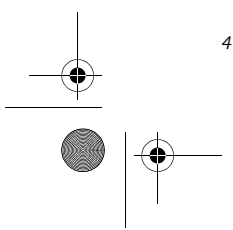
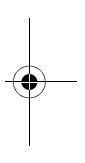
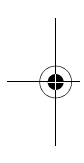
### WARRANTY

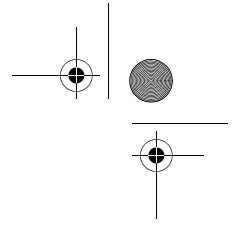
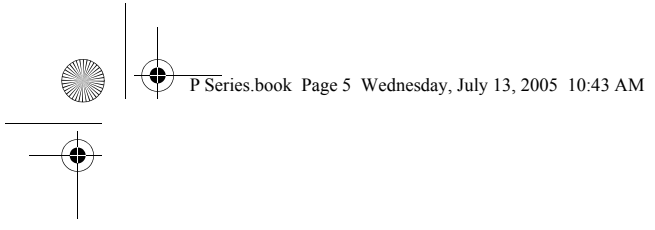
Your LifeBook P Series notebook is backed by an International Limited Warranty and includes toll-free technical support. Check the service kit that came with your notebook for warranty terms and conditions.





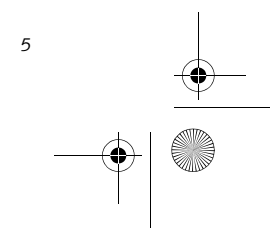
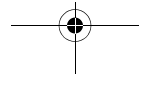
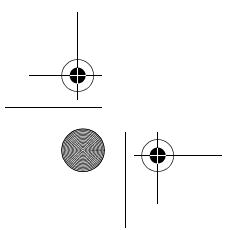
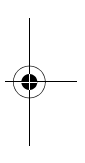
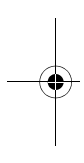
*LifeBook P Series Notebook*

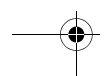
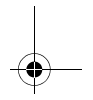
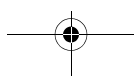
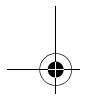
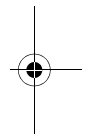
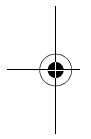
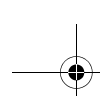




# 2

## Getting to Know Your LifeBook





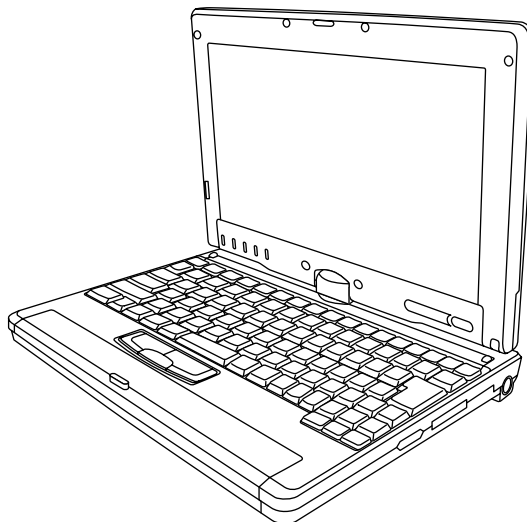
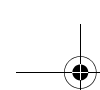


Figure 2-1. Fujitsu LifeBook P Series notebook

## Overview

This section describes the components of your Fujitsu LifeBook P Series notebook. We strongly recommend that you read it before using your notebook, even if you are already familiar with mobile computers.

### UNPACKING

When you receive your LifeBook P Series notebook, unpack it carefully, and compare the parts you have received with the items listed below.

For a pre-configured model you should have:

- LifeBook P Series notebook (Figure 2-1)
- AC adapter with AC power cord (Figure 2-2)
- Phone/Modem (RJ-11) telephone cable
- Pen
- Pen tether
- Driver and Application Restore (DAR) CD
- Recovery CD
- Third-party Application CD
- Getting Started Guide
- User's Guide (this document)
- International Limited Warranty Booklet
- Certificate of Authenticity
- Lithium ion battery (pre-installed)

You may also have one or more of the following devices in the box, depending upon the configuration of your system:

- Port Replicator (Figure 2-3)
- External USB Floppy Disk Drive
- Additional battery(s)
- Application CD(s) for third-party software

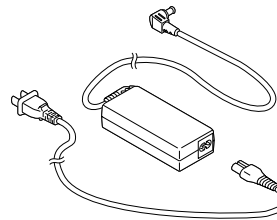


Figure 2-2. AC Adapter

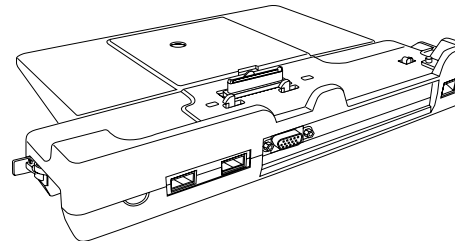
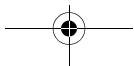


Figure 2-3. Optional Port Replicator

### OPTIONAL ACCESSORIES

A variety of optional accessories is available for use with your LifeBook P Series notebook. For the latest list of accessories available, be sure to frequently check the Fujitsu Web site at: [www.shopfujitsu.com](http://www.shopfujitsu.com). Refer to the instructions provided with these accessories for details on their use.



## Locating the Controls and Connectors

Connectors and peripheral interfaces on the LifeBook P Series notebook and the optional port replicator allow you to connect a variety of devices. Specific locations are illustrated in Figures 2-4 through 2-8. The table below

provides a short description of each icon on the LifeBook P Series notebook. Each of the icons is either molded into or printed on the notebook chassis.














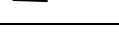
| Connection                 | LifeBook Icon   | Purpose  |
|----------------------------|---|--|
| DC in connector            |  | Connect an external power source such as the AC adapter or auto/airline adapter.   |
| Secure Digital (SD) Slot   |  | The Secure Digital (SD) card slot allows you to install a flash memory card for data storage. Flash memory cards allow you to transfer data to and from a variety of different digital devices.              |
| USB Ports                  |  | Connect Universal Serial Bus 2.0 or 1.1 compliant devices to the notebook.   |
| Microphone Jack            |  | Connect an external microphone. The internal microphone is disabled when you plug in an external microphone.   |
| Fingerprint Sensor         |  | Use the fingerprint sensor to log onto the system using your fingerprint as the "password".  |
| Headphone Jack             |  | Connect stereo headphones or powered external speakers. The internal speaker is disabled when you plug in external headphones or powered speakers.   |
| Modem                      |  | Connect a telephone line to the internal modem using a standard RJ-11 telephone plug.  |
| Port Replicator            |  | Connect the notebook port replicator or other approved docking device. Refer to documentation accompanying the dock for more information.  |
| Security lock slot         |  | The security slot allows you to secure the notebook using notebook locking devices.  |
| Suspend/Resume button      |  | The Suspend/Resume button allows you to suspend notebook activity without powering off, resume from suspend mode, and power on the system when it has been shut down from Windows.                           |
| Local Area Network (LAN)   |  | The LAN (RJ-45) jack is used to connect the internal 10/100 Base-T/Tx Ethernet to a Local Area Network (LAN) in your office or home, or broadband devices such as a cable modem, DSL, or satellite Internet. |
| Battery Release Latch      |  | The battery release latch allows you to remove the battery from your system for storage or replacement.  |
| Wireless LAN On-Off Switch |  | The wireless LAN switch allows you to turn power to the optional wireless LAN device on and off.   |
| Display Rotation           |  | This icon indicates the direction in which the display should be rotated when converting to tablet mode.   |

Table 2-1. System icons

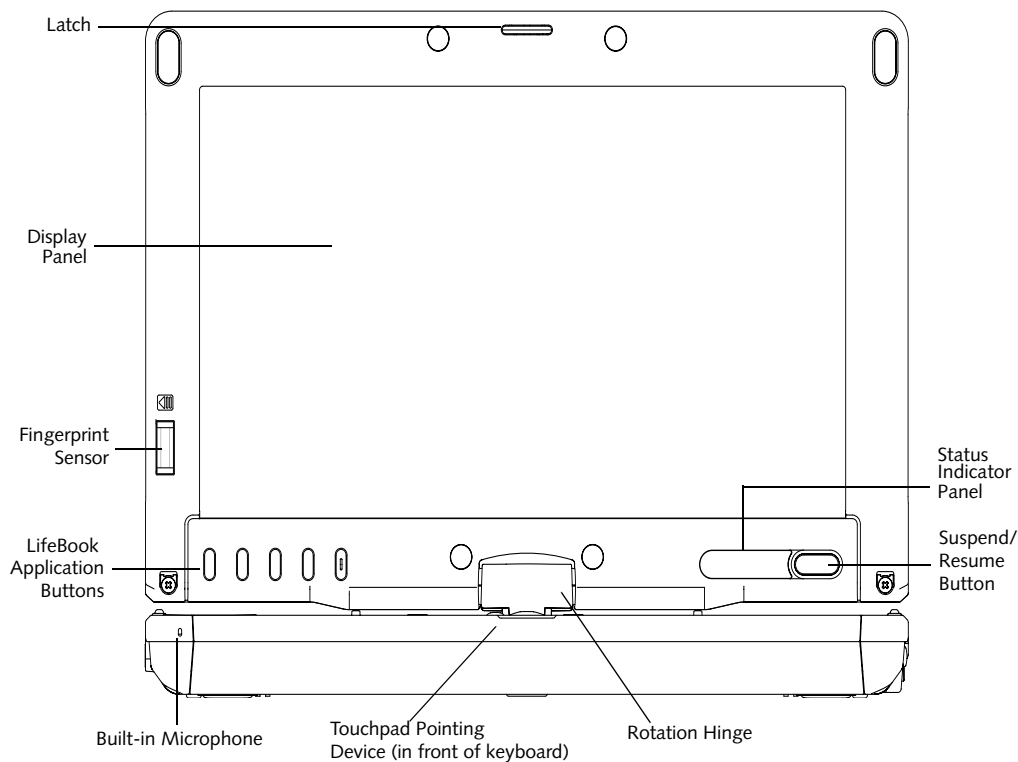


Figure 2-4. LifeBook P Series notebook with display open

#### FRONT AND DISPLAY COMPONENTS

The following is a brief description of the front and display features of the LifeBook P Series notebook. (Figure 2-4)

##### Display Panel Latch

The display panel latch holds the display panel in position.

##### Display Panel

The display panel is a color LCD panel with back lighting for the display of text and graphics and touch screen functionality.

##### Built-in Microphone

The built-in microphone allows you to input mono audio.

##### LifeBook Application Buttons

The LifeBook P Series notebook Application Buttons provide application launch capabilities. See "LifeBook Application Panel" on page 20.

##### Suspend/Resume Button

The Suspend/Resume button allows you to suspend notebook activity without powering off, resume your notebook from standby mode, and power on your system when it has been shut down from the Windows operating system. See "Power On" on page 30.

##### Keyboard

A full-function keyboard with dedicated Windows keys. See "Keyboard" on page 18.

##### Touchpad Pointing Device

The Touchpad pointing device consists of two mouse-like buttons and one scroll button. See "Quick Point Pointing Device/Touch Screen" on page 22.

##### Rotation Hinge

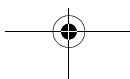
The rotation hinge allows you to transform your computer from a notebook configuration into a tablet configuration. See "Using the System as a Tablet" on page 16.

##### Fingerprint Sensor

The optional fingerprint recognition sensor allows you to start your system by swiping your finger over the sensor. See "Fingerprint Sensor Device" on page 101.

##### Status Indicator Panel

The Status Indicator Panel displays symbols that correspond to specific components of your LifeBook P Series notebook. See "Status Indicators" on page 14.



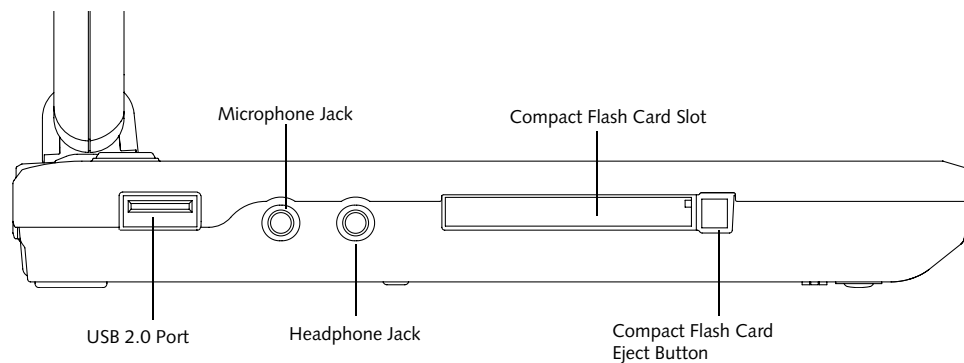
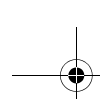


Figure 2-5. LifeBook P Series notebook left-side panel

#### LEFT-SIDE PANEL COMPONENTS

Following is a brief description of your notebook's left-side components. (Figure 2-5)

##### USB 2.0 Port

The USB 2.0 port allow you to connect Universal Serial Bus devices. See "Universal Serial Bus Ports" on page 46.

##### Compact Flash Card Slot

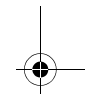
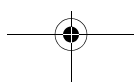
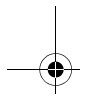
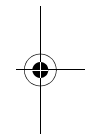
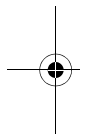
The Compact Flash (CF) Card Slot allows you to insert a CF Card. The CF Card Eject Button is used when ejecting a CF Card from the slot. See "Inserting Compact Flash Cards" on page 42.

##### Microphone Jack

The microphone jack allows you to connect an external mono microphone. See "Microphone Jack" on page 46.

##### Headphone Jack

The headphone jack allows you to connect stereo headphones or powered external speakers. See "Headphone Jack" on page 46.





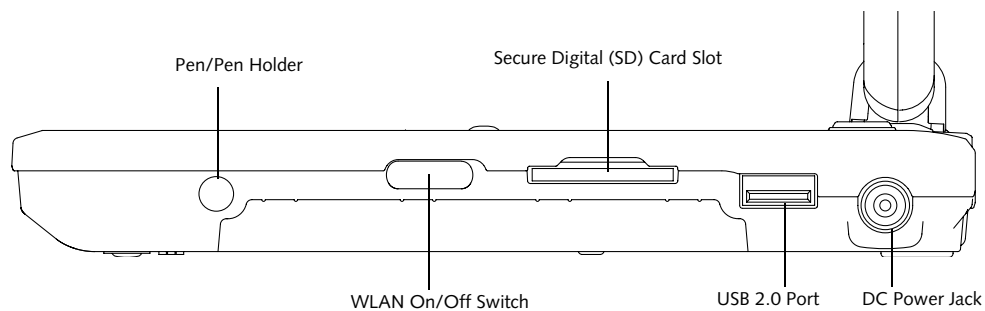


Figure 2-6. LifeBook P Series notebook right-side panel

#### RIGHT-SIDE PANEL COMPONENTS

Following is a brief description of your notebook's right-side components.

##### Pen/Pen Holder

The pen is used as the interface with the digitizer display.

##### WLAN On/Off Switch

The wireless LAN On/Off Switch is used to power off the wireless antenna when not in use.

##### SD Card

The Secure Digital (SD) card slot allows you to insert a flash memory card for data storage. Flash memory cards allow you to transfer data to and from a variety of different digital devices.

##### USB 2.0 Port

The USB 2.0 port allow you to connect Universal Serial Bus devices. See "Universal Serial Bus Ports" on page 46.

##### DC Power Jack

The DC power jack allows you to plug in the AC adapter or the optional Auto/Airline adapter to power your notebook and charge the internal Lithium ion Battery.



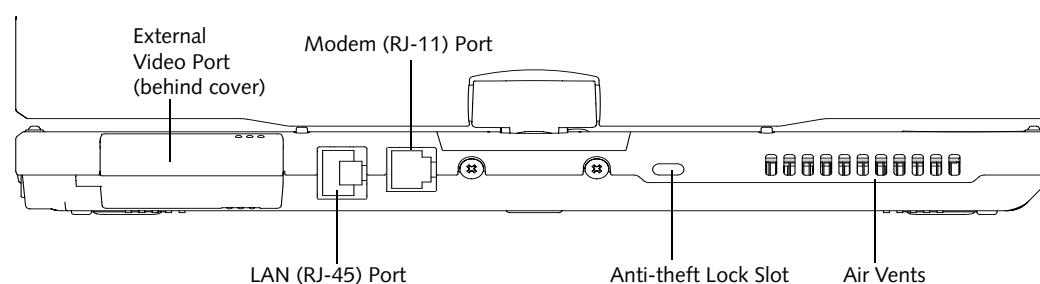


Figure 2-7. LifeBook P Series notebook rear panel

## REAR PANEL COMPONENTS

### Modem (RJ-11) Telephone Port

The Modem (RJ-11) telephone port is for attaching a telephone line to the internal multinational 56K modem.



The internal multinational modem is not intended for use with Digital PBX systems. Do not connect the internal modem to a Digital PBX as it may cause serious damage to the internal modem or your entire LifeBook P Series notebook. Consult your PBX manufacturer's documentation for details. Some hotels have Digital PBX systems. Be sure to find out BEFORE you connect your modem.



The internal modem is designed to the ITU-T V.90 standard. Its maximum speed of 53000 bps is the highest allowed by FCC, and its actual connection rate depends on the line conditions. The maximum speed is 33600 bps at upload.

### Anti-theft Lock Slot

The anti-theft lock slot allows you to attach an optional physical lock-down device.

### LAN (RJ-45) Port

The internal LAN (RJ-45) port is used for an internal 10/100Base-Tx Ethernet. See "Internal LAN (RJ-45) jack" on page 46.

### External Video Port

The external video port allows you to connect an external CRT monitor or LCD projector. Note that when the optional Port Replicator is attached to the system, you must use the external video port on the Port Replicator rather than the port on the system. See "External Video Port" on page 47.

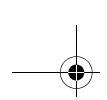
### Air Vents

The air vents allow proper air circulation to ensure that the notebook does not overheat.



To protect your notebook from damage and to optimize system performance, be sure to **keep all air all vents unobstructed, clean, and clear of debris**. This may require periodic cleaning, depending upon the environment in which the system is used.

Do not operate the notebook in areas where the air vents can be obstructed, such as in tight enclosures or on soft surfaces like a bed or cushion.



**Getting to Know Your Tablet PC**

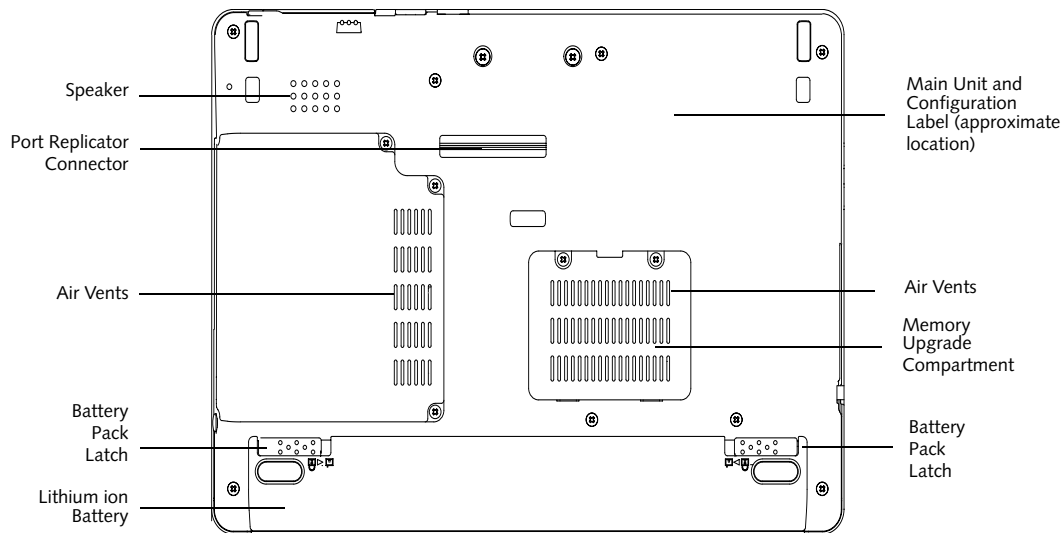


Figure 2-8. LifeBook P Series notebook bottom panel

**BOTTOM COMPONENTS**

Following is a brief description of your notebook's bottom panel components. (Figure 2-8)

**Lithium ion Battery Compartment**

The battery compartment contains the internal Lithium ion battery. The battery should be removed when the computer is stored over a long period of time or for swapping a discharged battery with a charged Lithium ion battery. See "Lithium ion Battery" on page 37.

**Port Replicator Connector**

This connector allows you to connect the optional port replicator.

**Speaker**

The speaker allows you to listen to sound from your system.

**Main Unit and Configuration Label**

The configuration label shows the model number and other information about your LifeBook P Series notebook. In addition, the configuration portion of the label has the serial number and manufacturer information that you will need to give your support representative. It identifies the exact version of various components of your notebook.

**Memory Upgrade Compartment**

Your notebook comes with high speed DDR2 Synchronous Dynamic RAM (SDRAM). The memory upgrade

compartment allows you to expand the system memory capacity of your notebook, hence improving overall performance. See "Memory Upgrade Module" on page 39.

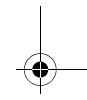
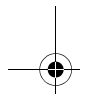
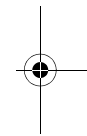
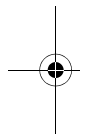
**Air Vents**

The air vents allow proper air circulation to ensure that the notebook does not overheat.

To protect your notebook from damage and to optimize system performance, be sure to **keep all air all vents unobstructed, clean, and clear of debris**. This may require periodic cleaning, depending upon the environment in which the system is used.



Do not operate the notebook in areas where the air vents can be obstructed, such as in tight enclosures or on soft surfaces like a bed or cushion.



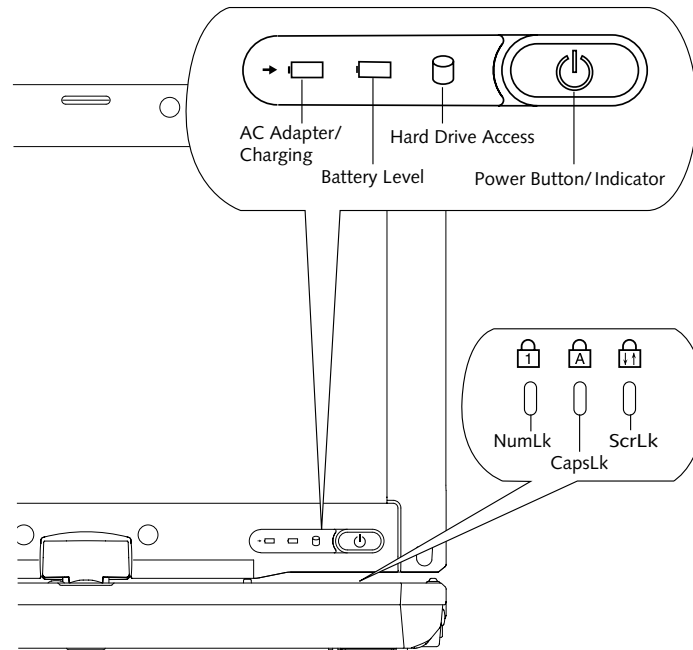


Figure 2-9. Status Indicators

## Status Indicators

The status indicators display symbols that correspond to specific components of your notebook. (Figure 2-9) The symbols show how each of those components is operating. Note that keyboard-related indicators (CapsLk, NumLk, ScrLk) are located above the keyboard.



### POWER INDICATOR

The Power indicator symbol located on the power button shows whether your system is operational. When it is lit blue, it means that there is power to your notebook and that it is ready for use.



### AC ADAPTER/BATTERY CHARGING INDICATOR

The AC Adapter/Battery Charging indicator shows that your notebook is operating from the AC adapter or an auto/airline adapter. This icon has two different states that can tell you the battery charge status.

- **Green:** This means that a power adapter is currently in use and the battery is not charging.
- **Amber:** This means that a power adapter is currently in use and the battery is charging.



### BATTERY LEVEL INDICATOR

The Battery Level indicators shows whether the Lithium ion battery is installed and charging, and how much charge is available within the batteries.

- **Green:** The battery is installed and fully charged.
- **Amber:** The battery is installed and is approximately half charged.
- **Red:** The battery charge is low and it should be charged with an adapter or replaced with a charged battery.



Batteries subjected to shocks, vibration or extreme temperatures can be permanently damaged.

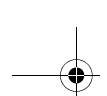


If there is no battery activity and the power adapters are not connected, the Battery Level indicators will also be off.



### HARD DRIVE ACCESS INDICATOR

The Hard Drive Access indicator lights green when your internal hard drive is being accessed.



**NUMLK INDICATOR**

The NumLk indicator shows that the integral keyboard is set in ten-key numeric keypad mode.



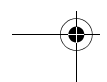
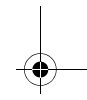
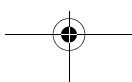
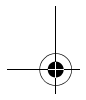
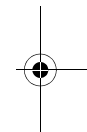
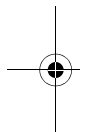
**CAPSLCK INDICATOR**

The CapsLock indicator shows that your keyboard is set to type in all capital letters.



**SCRCLK INDICATOR**

The ScrLk indicator shows that your scroll lock is active.



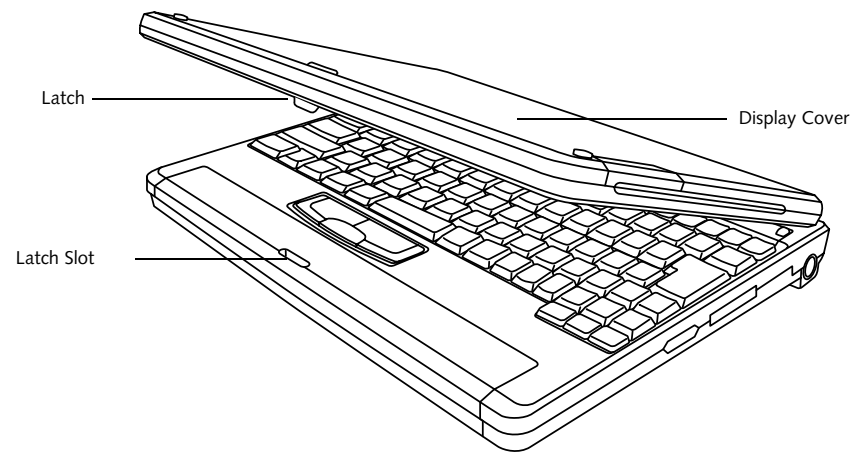


Figure 2-10. Opening the display

## Display Panel

The convertible design of your LifeBook P Series notebook allows you to open the display fully, rotate it 180 degrees, and lay it face up on the keyboard. This allows you to use the system as a tablet, much as you would a pad of paper.

### OPENING THE DISPLAY PANEL

Lift the display cover backwards, being careful not to touch the screen, until it is at a comfortable viewing angle. (Figure 2-10)

### USING THE SYSTEM AS A TABLET

If you would like to use the system as a tablet, perform the following steps.



**Rotate the system display only in the direction indicated in the procedure.** Turning the display in the incorrect direction could damage the hinge.



In the following step, be sure to position the display perpendicular to the keyboard, otherwise the keyboard or display cover could get scratched.

1. Lift the display until it is perpendicular to the keyboard. (Figure 2-12).
2. When the display is perpendicular to the keyboard, rotate it clockwise (when viewed from the top). Be very careful to rotate it in the direction indicated. (Figure 2-13). Turn the display 180 degrees so that it is facing backwards. (Figure 2-14)
3. Holding the top edge of the display panel, pull it forward until it is lying nearly atop the keyboard.

4. Push the latch towards the display (See "A" in Figure 2-11). The latch will click twice and the top latch disappears, and the bottom latch appears (See "B" in Figure 2-11). Lay the display flush against the system so that the latch rests in the slot in the battery pack. You can now use the system as a tablet. (Figure 2-15)

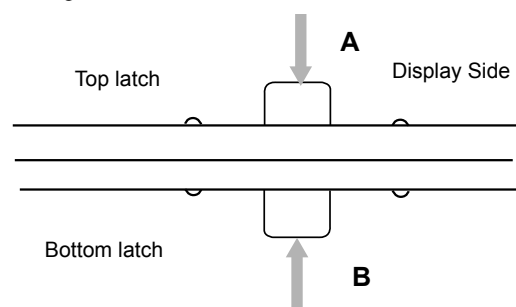


Figure 2-11. Using the Display Latch

5. To return the system to notebook configuration, repeat step 3 and 2. Be sure to turn the display in the opposite direction when performing step 2.

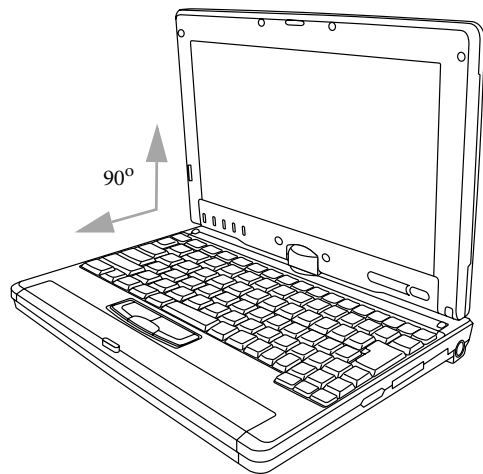


Figure 2-12. Fully open display

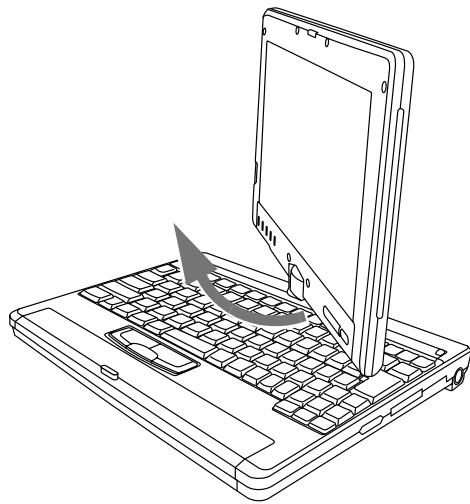


Figure 2-13. Rotating the display

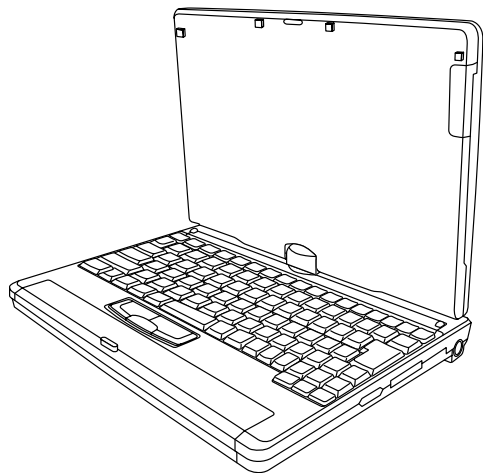


Figure 2-14. Display rotated completely

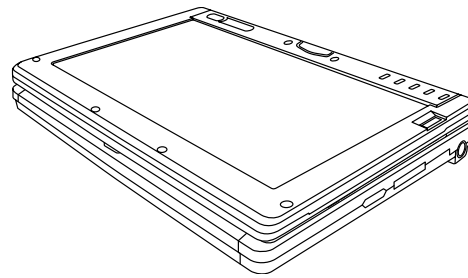


Figure 2-15. System in tablet configuration

### ADJUSTING DISPLAY PANEL BRIGHTNESS

Once you have turned on your notebook, you may want to adjust the brightness level of the screen to a more comfortable viewing level. There are three ways to adjust the brightness, keyboard, power management utility, and Fujitsu menu.

#### Using Keyboard to Adjust Brightness

Adjusting the brightness using the keyboard changes the system setting (i.e., the settings you make via the function keys automatically changes the brightness settings in the system's Brightness Control settings).

- [Fn+F6]: Pressing repeatedly will lower the brightness of your display.
- [Fn+F7]: Pressing repeatedly will increase the brightness of the display.

#### Using Power Management to Adjust Brightness

To adjust brightness with the power management utility, click Start -> Control Panel -> Brightness Control. Set the screen brightness slider for battery and AC power scenarios.

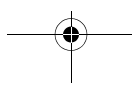
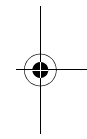
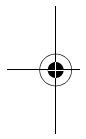
#### Using the Fujitsu Menu to Adjust Brightness

To adjust brightness using the Fujitsu menu, click on the Fujitsu Menu icon in the system tray in the lower right corner of the screen. From the menu that appears, select Brightness Control. The Brightness Control window will open. Set the screen brightness slider for battery and AC power scenarios.

If using AC power, your brightness setting is set to its highest level by default. If using battery power your brightness settings is set to approximately mid-level by default.



The higher the brightness level, the more power the LifeBook P Series notebook will consume and the faster your batteries will discharge. For maximum battery life, make sure that the brightness is set as low as possible.



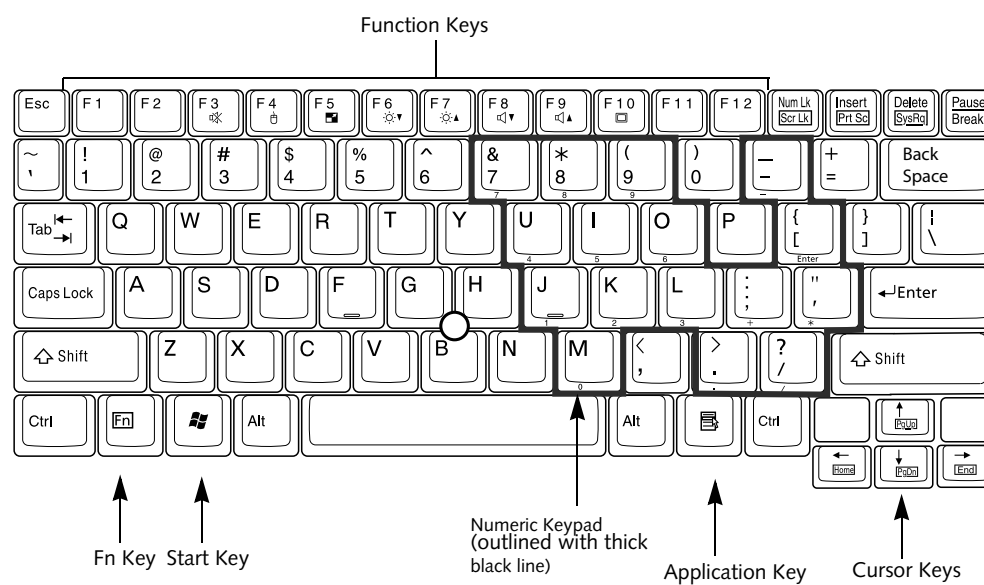


Figure 2-16. Keyboard

## Keyboard

### USING THE KEYBOARD

Your LifeBook P Series notebook has an integral 82-key keyboard. The keys perform all the standard functions of a 101-key keyboard, including the Windows keys and other special function keys. This section describes the following keys. (Figure 2-16)

- Numeric keypad:** Your notebook allows certain keys to serve dual purposes, both as standard characters and as numeric and mathematical keys. The ability to toggle between the standard character and numerical keys is controlled through the [NumLk] key.
- Cursor keys:** Your keyboard contains four arrow keys for moving the cursor or insertion point to the right, left, up, or down within windows, applications and documents.
- Function keys:** The keys labeled [F1] through [F12], are used in conjunction with the [Fn] key to produce special actions that vary depending on what program is running.
- Windows keys:** These keys work with your Windows operating system and function the same as the onscreen Start menu button, or the right button on your pointing device.

### NUMERIC KEYPAD

Certain keys on the keyboard perform dual functions as both standard character keys and numeric keypad keys. NumLk can be activated by pressing the [NumLk] key. Turning off the NumLk feature is done the same way. Once this feature is activated you can enter numerals 0 through 9, perform addition (+), subtraction (-), multiplication (\*), or division (/), and enter decimal points (.) using the keys designated as ten-key function keys. The keys in the numeric keypad are marked on the front edge of the key to indicate their secondary functions. (Figure 2-16)

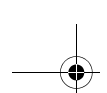
### WINDOWS KEYS

Your LifeBook P Series notebook has two Windows keys: a Start key and an Application key. The Start key displays the Start menu. This button functions the same as your onscreen Start menu button. The Application key functions the same as your right mouse button and displays shortcut menus for the selected item. (Please refer to your Windows documentation for additional information regarding the Windows keys.) (Figure 2-16)

### CURSOR KEYS

The cursor keys are the four arrow keys on the keyboard which allow you to move the cursor up, down, left, and right in applications. In programs such as Windows Explorer, it moves the "focus" (selects the next item up, down, left, or right). (Figure 2-16)





## FUNCTION KEYS

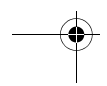
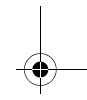
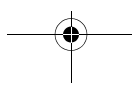
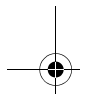
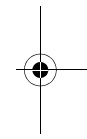
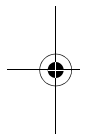
Your notebook has 12 function keys, F1 through F12. The functions assigned to these keys differ for each application. You should refer to your software documentation to find out how these keys are used.

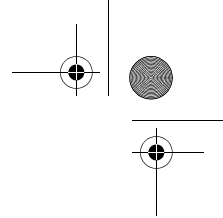
(Figure 2-16)

### [Fn] Key

The [Fn] key provides extended functions for the notebook and is always used in conjunction with another key.

- [Fn+F3]: Pressing [F3] while holding [Fn] will toggle the Audio Mute on and off.
- [Fn+F4]: Pressing [F4] while holding [Fn] will toggle the built-in pointing device on and off. Note that the [Fn+F4] combination only works if Manual Setting is selected in the BIOS. (See “Entering the BIOS Setup Utility” on page 30)
- [Fn +F5]: Pressing [F5] while holding [Fn] allows you to toggle between video compensation and no compensation. (Video compensation controls spacing on the display. When it is enabled, displays with less than 1024 x 768 or 800 x 600 pixel resolution will still cover the entire screen.)
- [Fn+F6]: Pressing [F6] repeatedly while holding [Fn] will lower the brightness of your display. Note that adjusting the brightness using the keyboard changes the system setting.
- [Fn+F7]: Pressing [F7] repeatedly while holding [Fn] will increase the brightness of the display.
- [Fn+F8]: Pressing [F8] repeatedly while holding [Fn] will decrease the volume of your notebook.
- [Fn+F9]: Pressing [F9] repeatedly while holding [Fn] will increase the volume of your notebook.
- [Fn+F10]: Pressing [F10] while holding [Fn] allows you to change your selection of where to send your display video. Each time you press the combination of keys you will step to the next choice. The choices, in order, are: built-in display panel only, both built-in display panel, and external monitor or external monitor only.





LifeBook P Series Notebook - Section Two

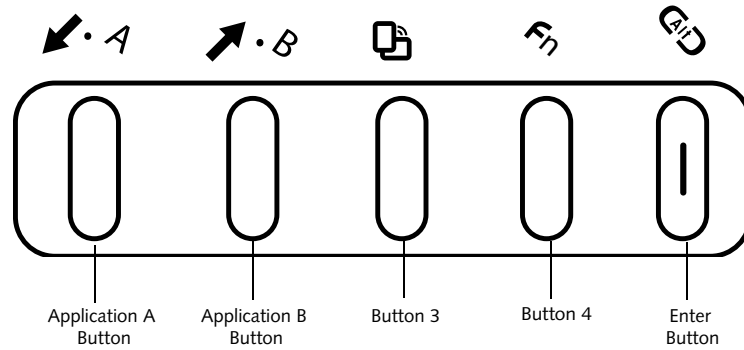


Figure 2-17. LifeBook P Series notebook application buttons

## LifeBook Application Panel

A unique feature of your LifeBook P Series notebook is the application panel buttons. These buttons allow you to launch specific applications with the touch of a button.

The five application buttons are located on the bottom left-hand side of the display when it is configured to be used as a notebook. (Figure 2-17)

All five of the buttons have primary functions. Four of the buttons have secondary functions when used as application buttons. The secondary functions are activated by pressing the Function (Fn) button while pressing the application button. See Table 2-2 for specific functions. The secondary functions of the Application A and B buttons can be changed to launch any application. See “Changing Button Functions” on page 21.

| Button Icon | Primary Function             | Secondary Function (Fn + Button)                  |
|-------------|------------------------------|---|
| ↓           | Page Down                    | User-defined Application A (Default = Calculator) |
| ↑           | Page Up                      | User-Defined Application B (Default = WordPad)    |
|             | Screen Rotation              | VGA-Out   |
| Fn          | Secondary Function Selection | Fujitsu Menu Utility                              |
| Alt/Del     | Ctrl+Alt+Del Button          | None  |

Table 2-2. Application Button Functions

### Page Down / Application A Button

When you press the **Page Down** button when the system is running, each press of the button will scroll the screen down one frame. This allows you to navigate quickly through large documents.

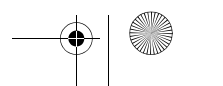
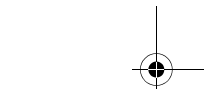
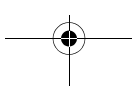
When you press the **Fn** button while you press then release the **Page Down/Application A** button, you will automatically start whichever program is assigned to the button. The default application for this button is Calculator.

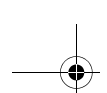
See “Changing Button Functions” on page 21 to select a different application for this button.

### Page Up / Application B Button

When you press the **Page Up** button when the system is running, each press of the button will scroll the screen up one frame. This allows you to navigate quickly through large documents.

When you press the **Fn** button while you press then release the **Page Up/Application A** button, you will





automatically start whichever program is assigned to the button. The default application for this button is WordPad.

See “Changing Button Functions” on page 21. to select a different application for this button.

#### Screen Rotation / VGA-Out Button

The screen rotation feature would normally be used only when the system is configured as a tablet. When you would like to use the tablet as an eBook, for example, you would use the portrait orientation; when accessing spreadsheets or using the system as a notebook, you would more typically use landscape orientation.

When the system is changed to tablet configuration, the orientation automatically changes to portrait mode by default.



The screen orientation default can be changed by going to the Control Panel and double-clicking on the Fujitsu Display Control icon and selecting the desired defaults from the Display Orientation section. After changing the defaults, click [OK].

When you press the **Screen Rotation / VGA-Out** button, the system screen orientation changes from portrait (vertical) to landscape (horizontal) or from landscape to portrait.

#### Function / Fujitsu Menu Utility Button

The **Function** button works in conjunction with the other application buttons to provide additional functionality for the buttons. Refer to specific details above.

Pressing the **Fn** button twice in succession causes the Fujitsu Menu Utility to appear on your screen, allowing you to modify certain system settings.

#### Ctl+Alt+Del Button

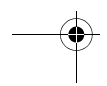
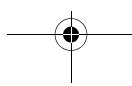
Pressing and holding the **Ctl-Alt-Del** button for up to 750 milliseconds launches the Logon screen or the Windows Task Manager (if the system hasn't yet been configured).

#### CHANGING BUTTON FUNCTIONS

The Application A and B buttons can be changed to launch a program or perform an action you select. By default, the Application A button launches the Calculator, and the Application B button launches WordPad.

To launch different applications or cause the Application A or B buttons to perform a specific action:

1. Double-click on the Tablet Button Settings icon in the Control Panel.
2. Select the button you would like to change from the list.
3. Click [Change] and open the drop down list in the Action: field.
4. Select the action you would like the button to perform. If you want to launch a program, click on Launch an Application then browse to the location of the program.
5. Click [OK], then click [OK] again. The buttons will now perform the actions you have assigned to them.



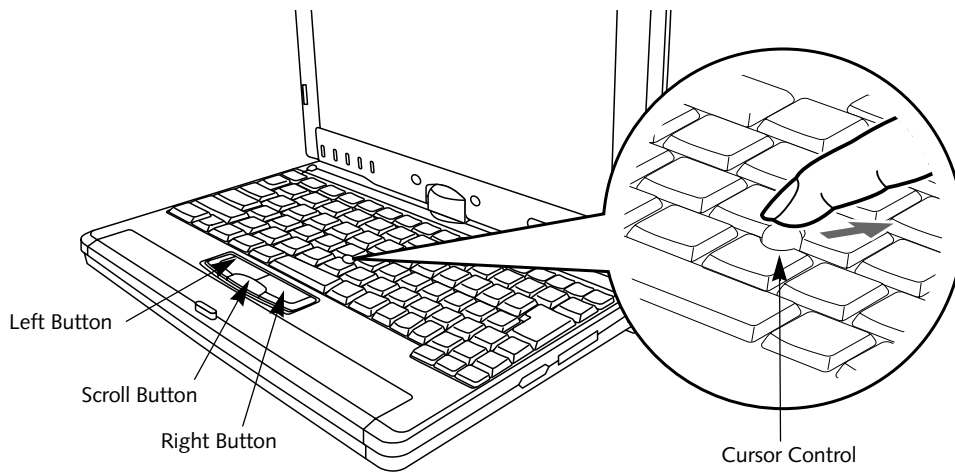


Figure 2-18. Touchpad pointing device

## Quick Point Pointing Device/Touch Screen

The Quick Point is built into your LifeBook notebook. It is used to control the movement of the cursor to select items on your display panel. The Quick Point is composed of a cursor control at the center of the keyboard and three buttons on the palm rest of your notebook. The cursor control works the same way a mouse ball does, and moves the cursor around the display. It only requires light pressure with the tip of your finger, and the more pressure you use, the faster the cursor will move. The left button functions the same as a left mouse button while the right button has the same function as a right mouse button. When used with the cursor control, the middle button allows you to scroll up and down a screen. The actual functionality of the buttons may vary depending on the application that is being used. (Figure 2-19)

### CLICKING

Clicking means pushing and releasing a button. To left-click, move the cursor to the item you wish to select, press the left button once, and then immediately release it. To right-click, move the cursor to the item you wish to select, press the bottom button once, and then immediately release it. (Figure 2-19)

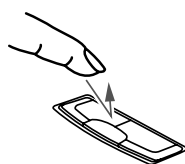


Figure 2-19 Clicking

### DOUBLE-CLICKING

Double-clicking means pushing and releasing the left button twice in rapid succession. This procedure does not function with the right button. To double-click, move the cursor to the item you wish to select, press and release the left button twice. (Figure 2-20)

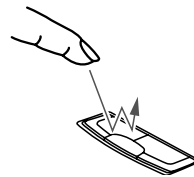


Figure 2-20 Double-clicking



- If the interval between clicks is too long, the double-click will not be executed.
- Parameters for the Quick Point can be adjusted from the Mouse dialog box located in the Windows Control Panel.

### DRAGGING

Dragging means pressing and holding the left button, while moving the cursor. To drag, move the cursor to the item you wish to move. Press and hold the left button while moving the item to its new location and then release it. (Figure 2-21)

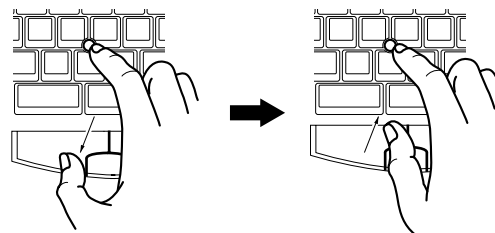


Figure 2-21 Dragging





### QUICK POINT CONTROL ADJUSTMENT

The Windows Control Panel allows you to customize your Quick Point with selections made from within the Mouse Properties dialog box. There are three aspects of Quick Point operation, which you can adjust:

- **Buttons:** This tab lets you set up the buttons for right or left handed operation, in addition to setting up the time interval allowed between clicks in double-clicking.
- **Pointers:** This tab lets you set up the scheme for the cursor depending on its functionality.
- **Pointer Options:** This tab lets you set up a relation between the speed of your finger motion and the speed of the cursor. It also allows you to enable a Pointer Trail for the cursor arrow.

### TOUCH SCREEN

The integrated Touch Screen allows you to use either the included stylus or your fingertip, as a pointing device.



**Do not use excessive force** when tapping or writing on the screen with the stylus or your finger. Use of excessive force could result in damage to the LCD and/or Touch Screen.

You can use the stylus to click, double-click, drag items and icons, or to draw like a pen or pencil in applications that support this behavior, such as drawing or painting programs. See the documentation that came with your application for details. (Figure 2-22)

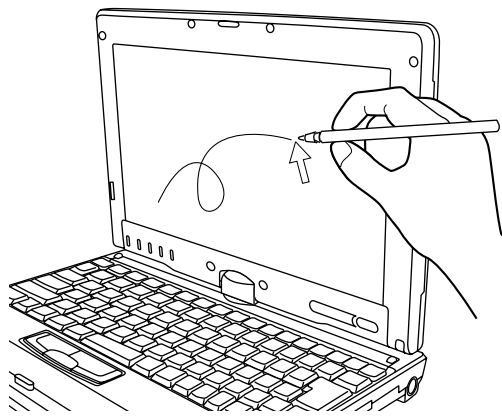


Figure 2-22 Using the Stylus with the Touch Screen



To avoid potential scratching and damage, never use anything but the included stylus or your finger with the Touch Screen.



To purchase additional or replacement styluses, visit Fujitsu's accessories web site at: [www.shopfujitsu.com](http://www.shopfujitsu.com).

### Clicking

To left-click, touch the object you wish to select and then lift the stylus tip immediately. You also have the option to perform the left-click operation by tapping lightly with your finger on the Touch Screen once. (Figure 2-23)

### Right-Clicking

To right-click, go to Start -> Control Panel -> Touch Panel. From the Right Button Simulation tab you can specify a right button tool by using the selected button prior to the desired right mouse click.

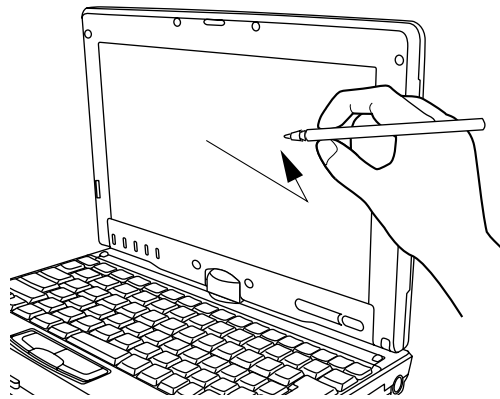


Figure 2-23 Clicking the Touch Screen

### Double-Clicking

To double-click, touch the item twice, and then immediately remove the stylus tip. You also have the option to perform the double-click operation by tapping lightly with your finger on the Touch Screen twice. (Figure 2-24)

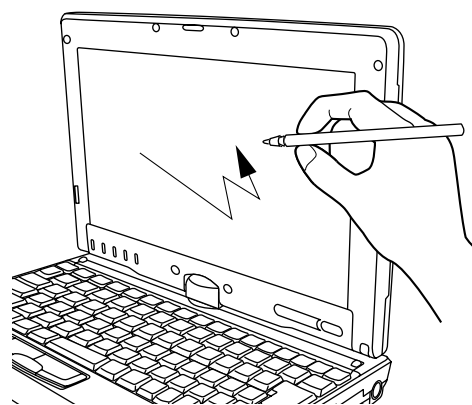
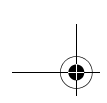


Figure 2-24 Double-clicking the Touch Screen



### Dragging

Dragging means moving an item with the stylus by touching the screen, moving and then lifting the stylus. To drag, touch the Touch Screen with your stylus on the item you wish to move. While continuing to touch the screen with the stylus, drag the item to its new location by moving the stylus across the screen, and then lifting the stylus to release it. Dragging can also be done using your fingertip. (Figure 2-25)

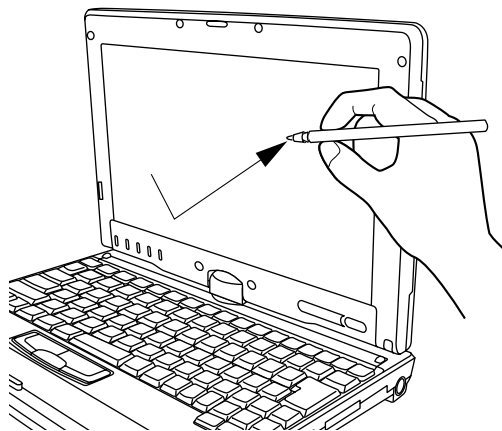


Figure 2-25 Dragging on the Touch Screen

### Calibrating the Touch Screen

In order to ensure accurate tracking between the stylus and cursor, you must run the Touch Screen Calibration Utility before you use the Touch Screen for the first time, or after you change the display resolution and/or orientation.

To run the calibration utility:

1. Go to Start -> Control Panel -> Touch Panel and select the Calibration tab.
2. Press the [Calibrate Now] button.
3. Adjust the display of your notebook to a comfortable angle and find the red (+) symbol in the upper-left corner of the display.



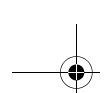
**Do not use excessive force** when tapping on the screen during calibration. Use of excessive force could result in damage to the LCD and/or touch panel.



When using the stylus to calibrate the screen, be sure to avoid touching the screen with your fingers; doing so could result in faulty calibration.

4. Using the stylus, firmly touch the screen directly on the (+) symbol. Lift the stylus from the screen and the target will move to a different location on the screen.
5. Repeat step 4 until you have selected a total of nine symbols. This is the minimum number of points necessary to calibrate your touch screen.
6. Once you have selected the nine symbols, press the [Update] button.
7. Touch the stylus to various points on the screen to verify that the screen is correctly calibrated. If you are not satisfied with the screen's calibration, press the [Calibrate Now] button to begin again.





## Volume Control

Your Fujitsu LifeBook notebook has multiple volume controls which interact with each other.



Any software that contains audio files will also contain a volume control of its own. If you install an external audio device that has an independent volume control, the hardware volume control and the software volume control will interact with each other. It should be noted that if you set your software volume to Off, you will override the external volume control setting.

### CONTROLLING THE VOLUME

The volume can be controlled in several different ways:

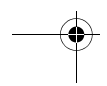
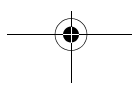
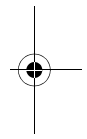
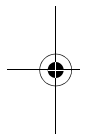
- Volume can be set from within the Volume Control on the Taskbar.
- Volume can be controlled with the [F8] and [F9] functions keys. Pressing [F8] repeatedly while holding [Fn] will decrease the volume of your notebook. Pressing [F9] repeatedly while holding [Fn] will increase the volume of your notebook.

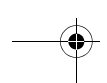
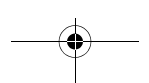
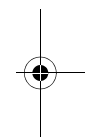
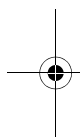
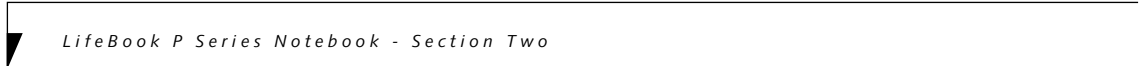
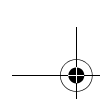


There are twenty-six levels through which the function keys cycle.

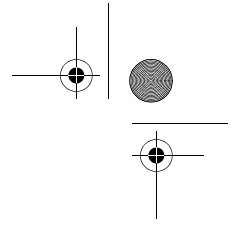
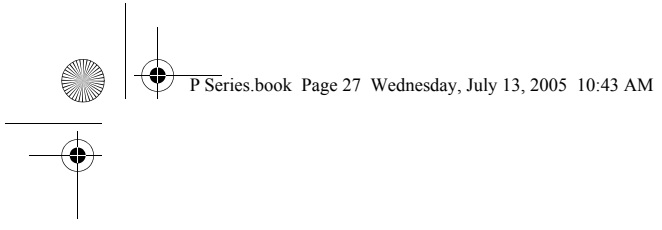
- Volume can be controlled by many volume controls that are set within individual applications.
- Certain external audio devices you might connect to your system may have hardware volume controls.
- Each source discussed above puts an upper limit on the volume level that must then be followed by the other sources.

We recommend that you experiment with the various volume controls to discover the optimal sound level.

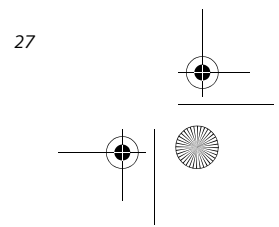
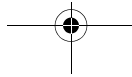
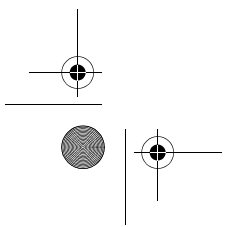
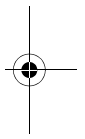
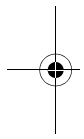


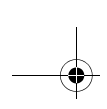




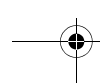
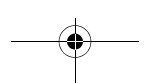
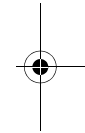
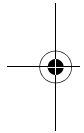


# 3 Using Your LifeBook





*LifeBook P Series Notebook - Section Three*





## Getting Started

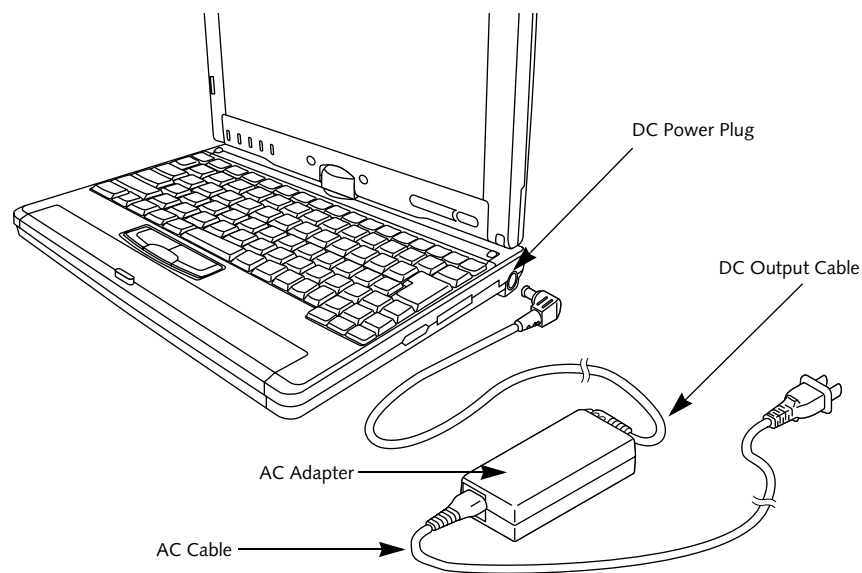


Figure 3-1. Connecting the AC Adapter

## Power Sources

Your LifeBook P Series notebook has three possible power sources: a primary Lithium ion battery, an AC adapter or an optional Auto/Airline adapter.

### CONNECTING THE POWER ADAPTERS

The AC adapter or optional Auto/Airline adapter provides power for operating your notebook and charging the battery.

#### Connecting the AC Adapter

1. Plug the DC output cable into the DC power jack of your notebook.
2. Plug the AC adapter into an AC electrical outlet.  
(Figure 3-1)

#### Connecting the Optional Auto/Airline Adapter

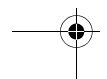
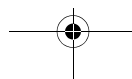
1. Plug the DC output cable into the DC power jack on your notebook.
  2. Plug the Auto/Airline adapter into the cigarette lighter of an automobile with the ignition key in the On or Accessories position.
- OR
3. Plug the Auto/Airline adapter into the DC power jack on an airplane seat.

#### Switching from AC Adapter Power or the Auto/Airline Adapter to Battery Power

1. Be sure that you have a charged battery installed.
2. Remove the AC adapter or the Auto/Airline adapter.



The Lithium ion battery is not charged upon purchase. Initially, you will need to connect either the AC adapter or the Auto/Airline adapter to use your notebook.



## Starting Your LifeBook

### POWER ON

The Suspend/Resume button is used to turn on your LifeBook P Series notebook from its off state. Once you have connected your AC adapter or charged the internal Lithium ion battery, you can power on your notebook. (See figure 2-4 on page 9 for location).



When you turn on your notebook, be sure you have a power source. This means that a battery is installed and charged, or that a power adapter is connected and has power.

Press the Suspend/Resume button to start your system. When you are done working you can either leave your notebook in Standby mode, See "Standby Mode" on page 32., or you can turn it off. See "Power Off" on page 34..



When the system display is closed, the Suspend/Resume button is disabled. This feature prevents the system from being accidentally powered up when not in use.

When you Power On your notebook, it will perform a Power On Self Test (POST) to check the internal parts and configuration for correct functionality. If a fault is found, your notebook will emit an audio warning and/or an error message will be displayed. See "Power On Self Test Messages" on page 58. Depending on the nature of the problem, you may be able to continue by starting the operating system or by entering the BIOS setup utility and revising the settings.

After satisfactory completion of the Power On Self Test (POST), your notebook will load your operating system.



Never turn off your notebook during the Power On Self Test (POST) or it will cause an error message to be displayed when you turn your notebook on the next time. See "Power On Self Test Messages" on page 58.

### BOOT SEQUENCE

The procedure for starting-up your notebook is termed the Bootup sequence and involves your notebook's BIOS. When your notebook is first turned on, the main system memory is empty, and it needs to find instructions to start up your notebook. This information is in the BIOS program. Each time you power up or restart your notebook, it goes through a boot sequence which

displays a Fujitsu logo until your operating system is loaded. During booting, your notebook is performing a standard boot sequence including a Power On Self Test (POST). When the boot sequence is completed without a failure and without a request for the BIOS Setup Utility, the system displays the operating system's opening screen.

The boot sequence is executed when:

- You turn on the power to your notebook.
- You restart your notebook from the Windows Shut Down dialog box.
- The software initiates a system restart (e.g., when you install a new application).

### BIOS SETUP UTILITY

The BIOS Setup Utility is a program that sets up the operating environment for your notebook. Your BIOS is set at the factory for normal operating conditions, therefore there is no need to set or change the BIOS' environment to operate your notebook.

The BIOS Setup Utility configures:

- Device control feature parameters, such as changing I/O addresses and boot devices.
- System Data Security feature parameters, such as passwords.

### Entering the BIOS Setup Utility

To enter the BIOS Setup Utility do the following:

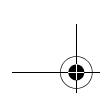
1. Turn on or restart your notebook.
2. Press the [F2] key once the Fujitsu logo appears on the screen. This will open the main menu of the BIOS Setup Utility with the current settings displayed.
3. Press the [RIGHT ARROW] or [LEFT ARROW] key to scroll through the other setup menus to review or alter the current settings.

### BIOS Guide

A guide to your notebook's BIOS is available online. Please visit our service and support Web site at <http://www.computers.us.fujitsu.com/support>. Once there, select LifeBook BIOS Guides from the pull-down menu for your notebook series. If you are unsure of your notebook's BIOS number, refer to your packing slip.



If your data security settings require it, you may be asked for a password before the BIOS main menu will appear.



## Getting Started

### BOOTING THE SYSTEM

We strongly recommend that you not attach any external devices until you have gone through the initial power on sequence.

When you turn on your LifeBook notebook for the first time, it will display a Fujitsu logo on the screen. If you do nothing the system will load the operating system, and then the Windows Welcome will begin.

#### Registering Windows with Microsoft

In order to ensure that you receive the most benefits from the Windows operating system, it should be registered the first time you use it.

After you receive the Windows Welcome screen, you will be prompted to enter registration information in the following order.

First of all, you will need to read and accept the End User License Agreements (EULAs). After accepting the EULAs, you will be asked if you want to enable the Automatic Updates feature. Acceptance of this feature is recommended because it allows your system to be updated automatically whenever an important change becomes available for your notebook.



- If you reject the terms of the license agreement you will be asked to review the license agreement for information on returning Windows or to shut down your LifeBook notebook.
- You cannot use your LifeBook notebook until you have accepted the License Agreement. If you stop the process your notebook will return to the beginning of the Windows Welcome Process, even if you shut your notebook down and start it up again.

Several additional windows will appear, prompting you to enter a name and description for your computer, an Administrator password, and a domain name. Read the instructions on the screens carefully and fill in the information as directed.

You will then be automatically connected to the Internet, if you have an appropriate connection available. If an automatic connection is not possible, you will be asked about how you dial out from where you will be using your LifeBook notebook. If you are not connected to a phone line and plan to register at a later time, you may click the **Skip** button.

Once you are connected to the Internet, you will be asked if you wish to continue with the registration. If you select **Yes** you will then enter your name and address, and email address if desired. Click **Next** to complete registration.

### REGISTERING YOUR LIFEBOOK NOTEBOOK

#### How do I register my LifeBook notebook?

You can register your LifeBook by going to our Web site:

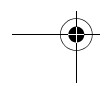
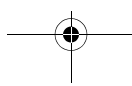
<http://www.computers.us.fujitsu.com/support>

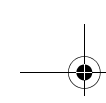
You will need to be set up with an Internet Service Provider (ISP) to register online.



#### INSTALLING CLICK ME!

The first time you boot up your system, you will see an icon called Click Me! in the Start menu. When you click the Click Me! icon, your system will automatically build the icon tray in the bottom right of the screen. These icons provide links to utilities that you will frequently access.





## Power Management

Your LifeBook P Series notebook has many options and features for conserving battery power. Some of these features are automatic and need no user intervention, such as those for the internal modem. However, others depend on the parameters you set to best suit your operating conditions, such as those for the display brightness. Internal power management for your notebook may be controlled from settings made in your operating system, pre-bundled power management application, or from settings made in BIOS setup utility.

Besides the options available for conserving battery power, there are also some things that you can do to prevent your notebook battery from running down as quickly. For example, you can create an appropriate power saving profile, put your notebook into Standby mode when it is not performing an operation, and you can limit the use of high power devices. As with all mobile, battery powered computers, there is a trade-off between performance and power savings.

| Power Mode                         | System Activity   | Events causing system to enter mode state  |
|------------------------------------|---|--|
| Fully On Mode                      | System is running. CPU, system bus, and all other interfaces operate at full speed.   | <ul style="list-style-type: none"> <li>▪ From Standby mode: System operation resumed (Suspend/Resume button pressed, resume on modem ring, resume on time).</li> <li>▪ From Hibernation mode: Suspend/Resume button pressed.</li> <li>▪ From Off mode: Suspend/Resume button pressed.</li> </ul> |
| Standby Mode (Suspend-to-RAM)      | Resume system logic remains powered and RAM remains powered to maintain active data. All other devices are turned off.      | <ul style="list-style-type: none"> <li>▪ Standby timeout occurs.</li> <li>▪ Suspend request issued by software or by pressing the Suspend/Resume button.</li> <li>▪ Low battery.</li> </ul>  |
| Hibernation Mode (Suspend-to-Disk) | Windows saves desktop state (including open files and documents) to hard disk. CPU stops. All other devices are turned off. | <ul style="list-style-type: none"> <li>▪ Suspend timeout occurs.</li> <li>▪ Clicking Start -&gt; Shut Down -&gt; Hibernate (It may be necessary to Enable Hibernate Support from Windows Power Options.)</li> <li>▪ Low battery condition</li> </ul>   |
| Power Off                          | System is fully powered off except for logic components required for Suspend/Resume button and real-time clock operation.   | <ul style="list-style-type: none"> <li>▪ System shutdown.</li> <li>▪ Low battery condition</li> </ul>  |

Table 3-1. System Power States

### SUSPEND/RESUME BUTTON

When your notebook is active, the Suspend/Resume button can be used to manually put your notebook into Standby mode. Push the Suspend/Resume button when your notebook is active, but not actively accessing anything, and immediately release the button. You will hear two short beeps and your system will enter Standby mode. (See figure 2-6 on page 11 for location).

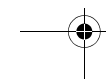
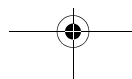
If your notebook is suspended, pushing the Suspend/Resume button will return your notebook to active operation. You can tell whether or not your system is in Standby mode by looking at the Power indicator. See “” on page 14. If the indicator is visible and not flashing, your notebook is fully operational. If the indicator is both visible and flashing, your notebook is in Standby mode. If the indicator is not visible at all, the power is off or your notebook is in Hibernate mode (See *Hibernate Mode*)

### STANDBY MODE

Standby mode in Windows saves the contents of your notebook's system memory during periods of inactivity by maintaining power to critical parts. This mode will turn off the CPU, the display, the hard drive, and all of the other internal components except those necessary to maintain system memory and allow for restarting. Your notebook can be put in Standby mode by:

- Pressing the Suspend/Resume button when your system is turned on.
- Selecting Standby from the Windows Shut Down menu.
- Timing out from lack of activity.
- Allowing the battery to reach the Dead Battery Warning condition.
- Closing the system cover.

Your notebook's system memory typically stores the file(s) on which you are working, open application(s) information, and any other data required to support the operation(s) in progress. When you resume operation





## Getting Started

from Standby mode, your notebook will return to the point where it left off. To resume operation, you must use the Suspend/Resume button to resume operation, and there must be an adequate power source available, or your notebook will not resume.



If you are running your notebook on battery power, be aware that the battery continues to discharge while your notebook is in Standby mode, though not as fast as when fully operational.

### HIBERNATE MODE

The Hibernate mode saves the contents of your notebook's system memory to the hard drive as a part of the Suspend/Resume mode. Your notebook is pre-configured to perform this function. The Hibernate mode can also be configured through the system BIOS to run in other ways depending on what you need to accomplish. See "BIOS Setup Utility" on page 30.

- Standby or Hibernate modes should not be used with certain PC Cards. Check your PC Card documentation for more information.
- Disabling the Suspend/Resume button prevents it from being used to put your notebook in Standby or Hibernate mode. The resume function of the button cannot be disabled.
- If your notebook is actively accessing information when you enter Standby or Hibernate mode, changes to open files are not lost. The files are left open and memory is kept active during Standby mode or the memory is transferred to the hard drive during Hibernate mode.
- When PC Cards or external devices are in use, Save-to-Disk mode cannot return to the exact state prior to suspension, because all peripheral devices will be re-initialized when the system restarts.
- The main advantage of using Hibernate mode is that power is not required to maintain your data. This is very important if you will be leaving your notebook in a suspended state for a prolonged period of time. The drawback of using Hibernate mode is that it lengthens the power down and power up sequences and resets peripheral devices.



### Using Hibernate Mode

Hibernate default setting is enabled for Windows XP.

To enable or disable the Hibernation feature follow these easy steps:

1. From the **Start** menu, select **Control Panel -> Power Options**.
2. Select the **Hibernate** tab and then select the box to enable or disable this feature.

To use Hibernate mode with your system:

1. From the **Start** menu, select **Control Panel -> Power Options**.
2. Select the **Power Schemes** tab and in the **System hibernates boxes**, select the amount of time you want to elapse until the system goes into hibernation (when plugged in and when running on battery power).

### DISPLAY TIMEOUT

The Video Timeout is one of the power management parameters. This feature saves power by turning off the display if there is no keyboard or pointer activity for the user selected timeout period. Any keyboard or pointer activity will cause the display to restart automatically. This feature is independent of the Suspend/Resume button and can be enabled and disabled in Windows Power Management.

### HARD DISK TIMEOUT

The Hard Disk Timeout is another one of the power management parameters. This feature saves power by turning off the hard drive if there is no hard drive activity for the user selected timeout period. Any attempt to access the hard drive will cause it to restart automatically. This feature is independent of the Suspend/Resume button and can be enabled and disabled in Windows.

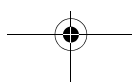
### WINDOWS POWER MANAGEMENT

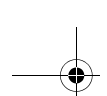
The Power Options icon located in the Windows Control Panel allows you to configure some of the power management settings. For example, you can use the Power Options to set the timeout values for turning off the display and hard disks whether you are running the notebook on battery power or one of the adapters.

### RESTARTING THE SYSTEM

If your system is on and you need to restart it, be sure that you use the following procedure.

1. Click the **Start** button, and then click **Turn Off Computer**.
2. Select the **Restart** button from within the Turn Off Computer window.





Turning off your notebook without exiting Windows or turning on your notebook within 10 seconds of the notebook being shut off may cause an error when you start the next time.

### POWER OFF

Before turning off the power by choosing Turn Off Computer from the Windows Start menu, check that the Hard Drive access indicator is off. (See Figure 2-9 on page 14) If you turn off the power while accessing a disk there is a risk of data loss. To ensure that your notebook shuts down without error, use the Windows shut down procedure.

Using the correct procedure to shut down from Windows allows your notebook to complete its operations and turn off power in the proper sequence to avoid errors. The proper sequence is:

1. Click the **Start** button, and then click **Turn Off Computer**.
2. Select the **Turn Off** option from within the window.

If you are going to store your notebook for a month or more, see the Care and Maintenance section.

