

FUJITSU LIFEBOOK U939X

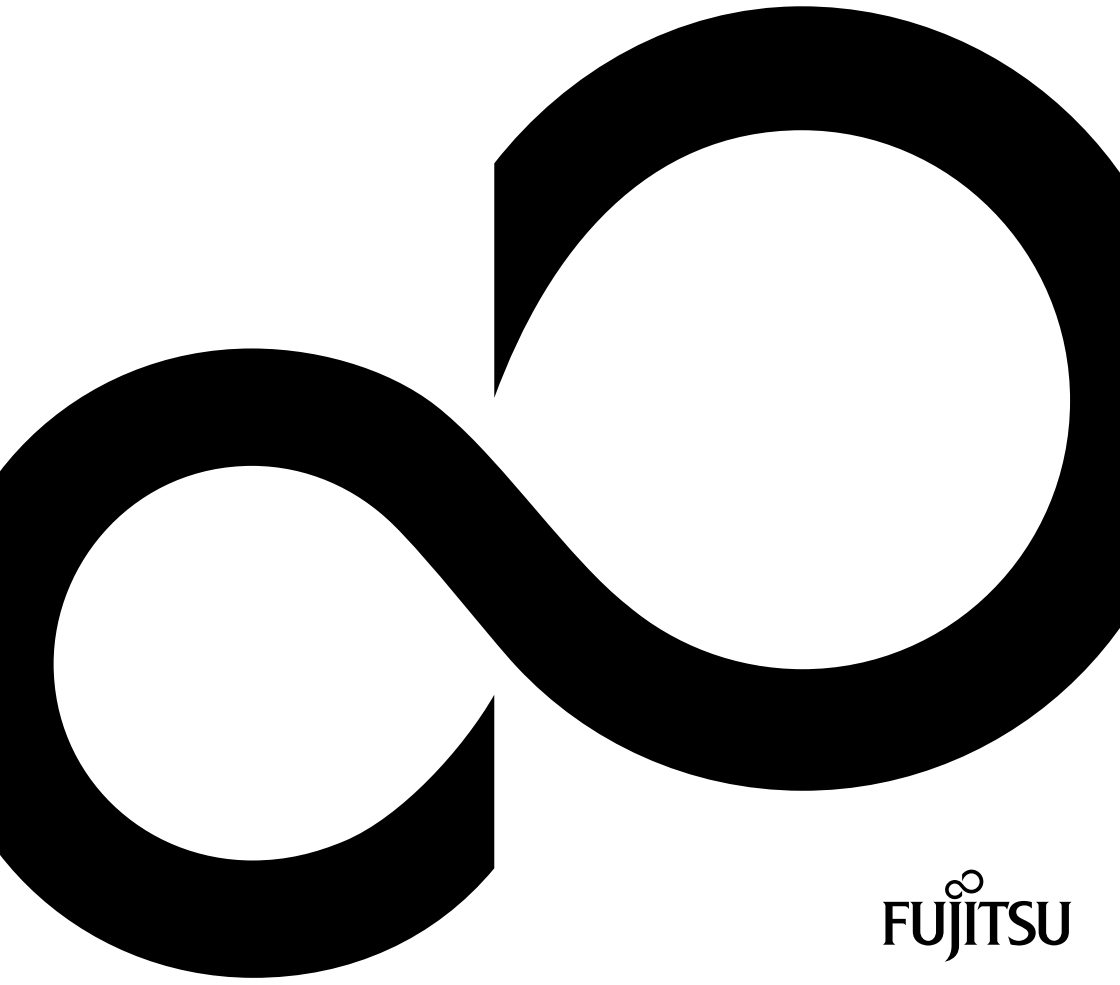



Contact address in North America

FUJITSU AMERICA INC.

1250 East Arques Avenue, Sunnyvale,

CA 94085-3470, U.S.A.

Telephone: 800 831 3183 or 408 746 6000

["http://solutions.us.fujitsu.com"](http://solutions.us.fujitsu.com)

["http://solutions.us.fujitsu.com/contact"](http://solutions.us.fujitsu.com/contact)

Have a question? Email us at: ["AskFujitsu@us.fujitsu.com"](mailto:AskFujitsu@us.fujitsu.com)

Copyright

© 2019 Fujitsu America, Inc. All rights reserved

FPC65-7892-02

FUJITSU LIFEBOOK U939X

Operating Manual

Declarations of conformity	7
Fujitsu Contact Information	8
Ports and controls	10
Important notes	12
First-time setup of your device	16
Working with the notebook	19
Security functions	42
Connecting external devices	48
Removing and installing components during servicing	54
Settings in BIOS Setup Utility	55
Troubleshooting and tips	58
Technical data	65
Manufacturer's notes	68
Appendix	75
Index	86

Copyright and Trademark Information

Fujitsu America, Incorporated has made every effort to ensure the accuracy and completeness of this document; however, as ongoing development efforts are continually improving the capabilities of our products, we cannot guarantee the accuracy of the contents of this document. We disclaim liability for errors, omissions, or future changes.

Fujitsu, the Fujitsu logo and LIFEBOOK are registered trademarks of Fujitsu Limited or its subsidiaries in the United States and other countries.

Intel and Intel Core are trademarks or registered trademarks of Intel Corporation or its subsidiaries in the United States and other countries.

Microsoft and Windows are either registered trademarks or trademarks of Microsoft Corporation in the United States and/or other countries.

Bluetooth is a trademark of Bluetooth SIG, Inc., USA.



The terms HDMI and HDMI High-Definition Multimedia Interface and the HDMI Logo are either a registered trademarks or trademarks of HDMI Licensing, LLC in the United States and/or other countries.

USB Type-C is a trademark or registered trademark of the USB Implementers Forum in the USA and other countries.

USB Type-C is a trademark or registered trademark of the USB Implementers Forum in Canada and other countries.

All other trademarks specified here are the property of their respective owners.

Contents

Declarations of conformity	7
Fujitsu Contact Information	8
Notational conventions	9
Ports and controls	10
Important notes	12
Safety instructions	12
Additional safety notes for devices with wireless components	13
Energy saving	13
Energy saving under Windows	13
Traveling with your notebook	13
Before you travel	14
Transporting the notebook	15
Cleaning the notebook	15
First-time setup of your device	16
Unpacking and checking the device	16
Choose a location	17
Connecting the AC adapter	17
Switching on the device for the first time	18
Installing Bonus Apps	18
Working with the notebook	19
Opening notebook and Status indicators	19
Switching the notebook on	21
Switching the notebook off	21
Keyboard	22
Hot keys and function keys	24
F-Lock setting	26
Key combinations	27
Virtual number keys	28
Country and keyboard settings	28
Touchpad and touchpad buttons	29
Moving the pointer	29
Selecting an item	29
Executing commands	29
Dragging items	30
Touchscreen/LCD screen without touch function (device-dependent)	30
Using fingers	31
Webcam	32
Rechargeable battery	32
Charging, caring for and maintaining the battery	32
Switching the battery on and off	33
Using the energy saving functions	34
Memory cards	35
Supported formats	35
Inserting the memory card	35
Removing the memory card	35
Speaker and microphones	36
Wireless LAN/Bluetooth wireless components	36

Switching the wireless components on and off	36
Configuring WLAN access	36
Further information on WLAN and Bluetooth	37
Ethernet and LAN	37
Your USB Type-C dock (optional)	38
Ports on the dock	38
Setting up the dock	39
Connect the AC adapter to the dock	39
Connect the notebook to the dock	40
Switching on the notebook via the dock	41
Switching off the notebook via the dock	41
Disconnecting the notebook from the dock	41
Security functions	42
Configuring the fingerprint sensor	42
Setting up the palm vein sensor	43
Using the Security Lock	43
Configuring password protection in BIOS Setup Utility	44
Protecting BIOS Setup Utility (supervisor password and user password)	44
Password protection for booting the operating system	45
Password protection for the hard disk	46
Trusted Platform Module - TPM (device dependent)	46
Enabling TPM	46
Disabling TPM	46
Smart Card reader	47
Inserting the Smart Card	47
Connecting external devices	48
HDMI port	48
Connecting an external monitor to the dock	49
Connecting USB devices	50
USB port with charging function (USB Type-C)	51
USB port with charging function (Anytime USB charge)	52
How to remove USB devices correctly	52
Headset port	53
Removing and installing components during servicing	54
Settings in BIOS Setup Utility	55
Starting the BIOS Setup Utility	55
BIOS Setup Utility operation	56
Exiting BIOS Setup Utility	57
Exit Saving Changes - save changes and exit BIOS Setup Utility	57
Exit Discarding Changes - Reject changes and exit BIOS Setup Utility	57
Load Setup Defaults – load default values	57
Discard Changes - Discard Changes without exiting BIOS Setup Utility	57
Save Changes - save changes without exiting the BIOS Setup Utility	57
Save changes and power off	57
Troubleshooting and tips	58
Help if problems occur	58
Reset by switching the battery off	59
If you need to restore your system	59
The notebook's date or time is incorrect	59

When certain characters are entered on the keyboard, only numerals are written	59
The notebook's LCD screen remains blank	59
The LCD screen of the notebook is difficult to read	59
The external monitor remains blank	60
The external monitor is blank or the image is unstable	60
The notebook does not start after switching it on	61
The notebook stops working	61
The printer does not print	61
The wireless connection to a network does not work	62
Smart Card reader is not recognized	62
Smart Card PIN forgotten	62
Smart Card lost	62
Error messages on the screen	63
Technical data	65
LIFEBOOK	65
Rechargeable battery	65
Power adapter	66
WLAN specifications	66
Manufacturer's notes	68
Disposal and recycling	68
Recycling your battery	68
DOC (Industry CANADA) Notices	68
UL Notice	69
ENERGY STAR Compliance	70
FCC and IC Regulatory Information	71
Regulatory Notes and Statements	71
Canadian Notice / Avis pour le Canada	74
Canadian Notice	74
Avis pour le Canada	74
Appendix	75
Before Using the Optional Wireless LAN	75
Wireless LAN Devices Covered by this Document	75
Characteristics of the WLAN Device	75
Wireless LAN Modes Using this Device	76
Deactivating/Disconnecting the WLAN Device	78
Configuring the Wireless LAN	78
Configuring the WLAN Using Windows	78
Connection to the network	78
Troubleshooting the WLAN	78
Using the Bluetooth Device	81
Image Backup and Recovery Procedures	81
Windows 10 Procedures	81
Creating a recovery drive	82
Recovery options in Windows 10	82
Downloading driver updates	85
Index	86

Declarations of conformity



DECLARATION OF CONFORMITY according to FCC Part 15

Responsible Party Name: Fujitsu America, Inc.
Address: 1250 E. Arques Avenue
Sunnyvale, CA 94085
Telephone: (408) 746-6000
Declares that product: Base Model Configuration: FUJITSU LIFEBOOK U939X
Complies with Part 15 of the FCC Rules.

This device complies with Part 15 of the FCC rules. Operations are subject to the following two conditions: (1) This device may not cause harmful interference. (2) This device must accept any interference received, including interference that may cause undesired operation.

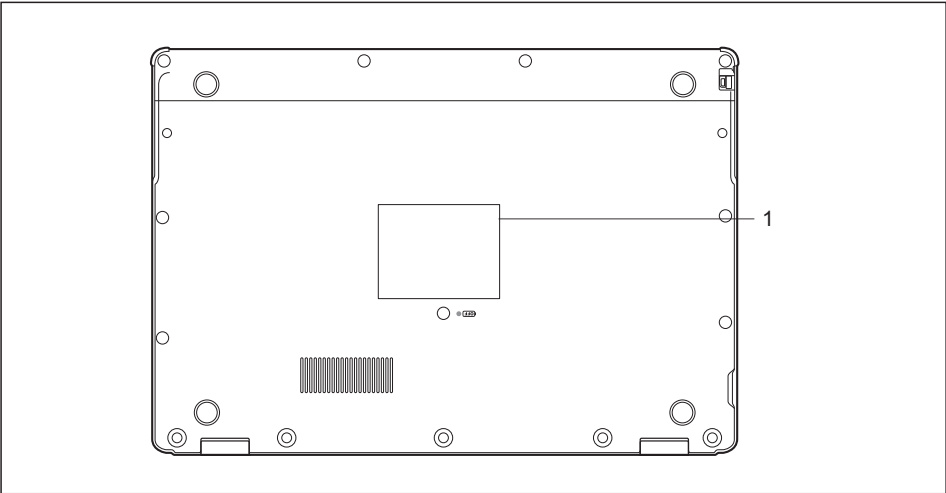

1 = Declaration of conformity

Fujitsu Contact Information

Service and Support

You can contact Fujitsu Service and Support in the following ways:

- Toll free phone: 1-800-8Fujitsu (1-800-838-5487)
- Website: "<http://solutions.us.fujitsu.com/www/content/support/contact/index.php>"



Before you place the call, have the following information ready so that the customer support representative can provide you with the fastest possible solution:

- Product name
- Product configuration number
- Product serial number
- Purchase date
- Conditions under which the problem occurred
- Any error messages that have occurred
- Type of device connected, if any

Fujitsu Shopping Online

Please go to "<http://www.shopfujitsu.com/store/>".





Maintaining Latest Configuration

To ensure that you always have the most current driver updates related to your system, you should occasionally access the Fujitsu Software Download Manager (FSDM) utility. The FSDM utility is available from the Fujitsu Support site. FSDM will allow you to view a list of the most current drivers, utilities and applications to determine whether you have the latest versions. If you have a Windows 10 operating system, you will need to go to the Support Site to download the FSDM Utility: "<http://support.fujitsupc.com/CS/Portal/support.do?srch=DOWNLOADS>".

Limited Warranty

Your LIFEBOOK notebook is backed by a Fujitsu International Limited Warranty. Check the Limited Warranty Terms and Conditions Booklet that came with your notebook.

Notational conventions

	Pay particular attention to text marked with this symbol. Failure to observe this warning will endanger your life, will damage the device or lead to loss of data. The warranty will be invalidated if the device becomes defective through failure to observe these warnings.
	Indicates important information which is required to use the device properly.
	indicates an activity that must be performed
	indicates a result
This style	indicates data entered using the keyboard in a program dialogue or at the command line, e.g. your password (N ame123) or a command used to start a program (s tart.exe)
This style	indicates information that is displayed on the screen by a program, e.g.: Installation is complete.
<i>This style</i>	indicates <ul style="list-style-type: none"> terms and texts used in a software interface, e.g.: Click on <i>Save</i>. names of programs or files, e.g. <i>Windows</i> or <i>setup.exe</i>.
"This style"	indicates <ul style="list-style-type: none"> Cross-references to another section, e.g. "Safety information" cross-references to an external source, e.g. a web address: For more information, go to "http://solutions.us.fujitsu.com/" names of CDs, DVDs and titles or designations of other materials, e.g.: "CD/DVD Drivers & Utilities"
Key	indicates a key on the keyboard, e.g: F10
This style	indicates terms and text that are emphasized or highlighted, e.g.: Do not switch off the device

Ports and controls

This chapter presents the individual hardware components of your device. It gives an overview of the indicators and connections of the device. Please familiarize yourself with these components before you start to work with the device.

Front

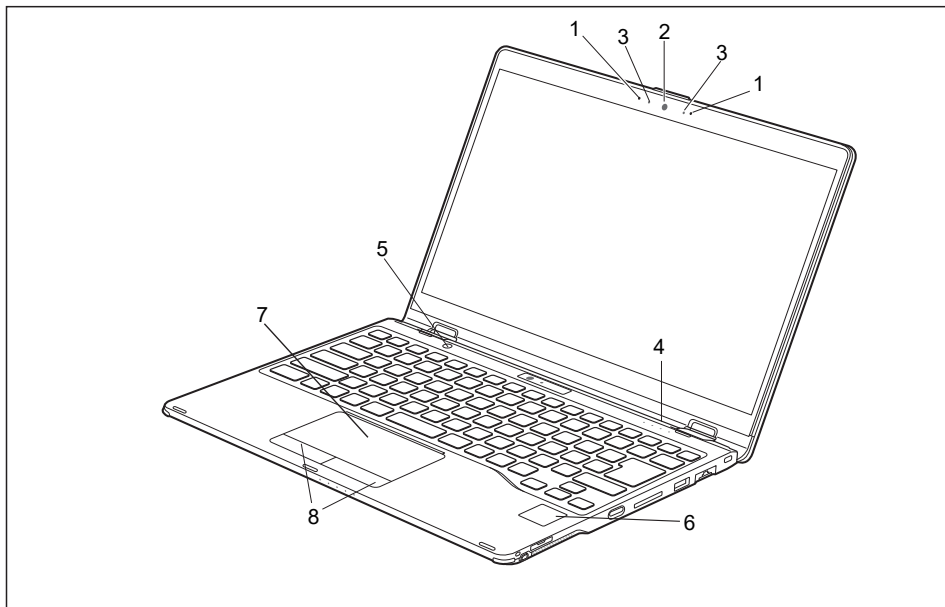

- 1 = Microphone
- 2 = Webcam
- 3 = Webcam LED
- 4 = Status indicators
- 5 = ON/OFF button

- 6 = Fingerprint sensor (optional) or palm vein sensor (optional)
- 7 = Touchpad
- 8 = Touchpad buttons

Left-hand side

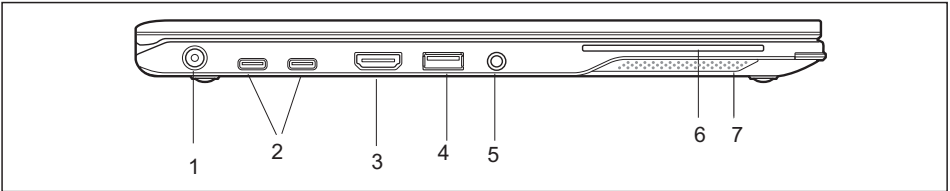

- | | |
|--------------------------------------|--|
| 1 = DC input connector (DC IN) | 4 = USB port 3.1 Gen 1 with charging function (USB Type-A, Anytime USB charge) |
| 2 = Intel® Thunderbolt™ (USB Type-C) | 5 = Headset port |
| 3 = HDMI port | 6 = Smart Card reader |
| Right-hand side | 7 = Speaker |

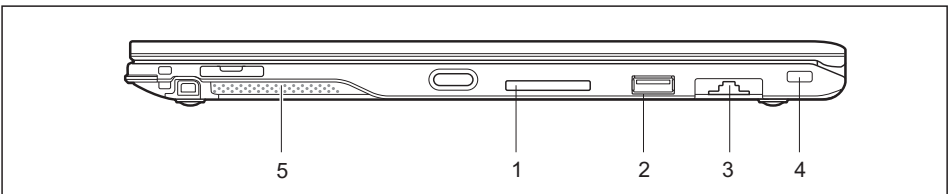

- | | |
|-------------------------------------|------------------------------|
| 1 = Slot for memory cards | 3 = LAN connector (pull-out) |
| 2 = USB port 3.1 Gen 1 (USB Type-A) | 4 = Security Lock device |
| | 5 = Speaker |

Bottom

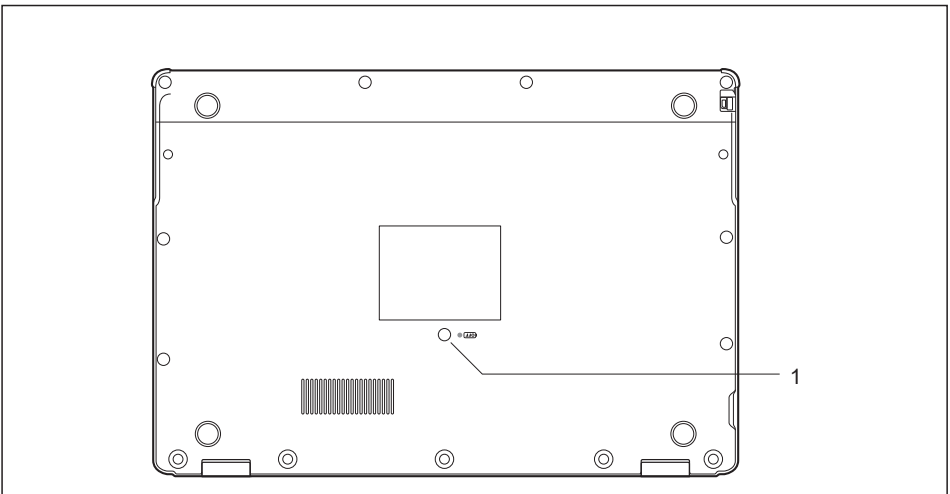

- 1 = ON/OFF button for rechargeable battery (recessed)

Important notes



This chapter contains essential safety information which must be followed when working with your notebook. Other notes also provide useful information which will help you with your notebook.

Safety instructions



Please observe the following safety information.

Please pay special attention to the sections in the manual marked with the symbol on the left.

When connecting and disconnecting cables, observe the relevant notes in this operating manual.

Read the information on the ambient conditions in the ["Technical data", Page 65](#) chapter and the ["First-time setup of your device", Page 16](#) chapter before preparing your notebook for use and switching it on for the first time.

When cleaning the device, please observe the relevant notes in the section ["Cleaning the notebook", Page 15](#).

Please refer to the notes in the chapter ["Removing and installing components during servicing", Page 54](#).

When handling this device, you will come into contact with lead, a chemical which in California is held to be a possible cause of birth defects and other damage to fertility.

Wash your hands after using the device.

Do not place the device on uneven or unstable surfaces.

Do not place any objects on the device.

Do not apply any pressure to the device.

Do not use the corners of the display to move it.

Turn the display carefully. In doing so, do not use excessive force.

Lift and carry the device by holding it at the bottom and not just at the display.

Prevent harsh impacts, vibrations and shaking of the device and the display.

On devices with touchscreen: Use very little pressure to carefully tap and write on the display.

Keep the ventilation slots free.

Switch off the device before you put it inside a bag or backpack.

In emergencies (e.g. damage to the device or power cable, entry of liquids or foreign objects), immediately switch off the device and disconnect the AC plug. Short circuit, smoke and/or fire may occur as a result. Please contact your sales outlet or our Hotline/Service Desk.

This notebook complies with the relevant safety regulations for data processing equipment. If you have any questions about setting up your notebook in the intended environment, please contact your sales outlet or our Hotline/Service Desk.

Additional safety notes for devices with wireless components

If a wireless component (Wireless LAN, Bluetooth) is incorporated in your notebook, you must be sure to observe the following safety notes when using your notebook:

- Switch off the wireless components when you are in an aircraft or driving in a car.
- Switch off the wireless components when you are in a hospital, an operating room or near a medical electronics system. The transmitted radio waves can impair the operation of medical devices.
- Switch off the wireless components, when you let the device get near flammable gases or into hazardous environments (e.g. gas station, paintshops), as the transmitted radio waves can cause an explosion or a fire.



For further information on how to switch the wireless components on and off, refer to chapter ["Switching the wireless components on and off", Page 36.](#)

Energy saving

Switch the notebook off when it is not in use. Switch off any connected external devices when they are not in use. If you use the energy saving functions, the notebook uses less power. You will then be able to work for longer before having to recharge the battery.



The energy efficiency is increased and environmental pollution is reduced. You save money and help protect the environment.

Energy saving under Windows

- ▶ Make use of the available energy saving functions as described in chapter ["Using the energy saving functions", Page 34.](#)

Traveling with your notebook

Please observe the points listed below when traveling with your notebook.

Before you travel

- ▶ Back up important data stored on your hard disk.
- ▶ Switch off the wireless component for data security reasons. With data traffic via a wireless connection, it is also possible for unauthorized third parties to receive data.



Information on activating data encryption is provided in the documentation for your wireless component.

- ▶ If you wish to use your notebook during a flight, check with the flight attendants if its use is safe.

When traveling in other countries

- ▶ If you are traveling abroad, check that the AC adapter can be operated with the local AC voltage. If this is not the case, obtain the appropriate AC adapter for your notebook. Do not use any other converter!
- ▶ Check whether the local AC voltage and the AC cable are compatible. If this is not the case, buy an AC cable that suits the local conditions.
- ▶ Enquire with the corresponding government office of the country you will be traveling to, whether you may use your notebook with its integrated wireless component there.
- ▶ Take the necessary travel adapters with you when traveling abroad. Check the following table to see which travel adapters you will need, or ask your travel organizer.

Power connection	Travel destination
 	United States, Canada, Mexico, parts of Latin America, Japan, Korea, Philippines, Taiwan
	Russia and the Commonwealth of Independent States (CIS), much of Europe, parts of Latin America, the Middle East, parts of Africa, Hong Kong, India, much of south-east Asia
	United Kingdom, Ireland, Malaya, Singapore, parts of Africa
	China, Australia, New Zealand

Transporting the notebook



Protect the notebook from severe shocks and extreme temperatures (e.g. direct sunlight in a car).

- ▶ Switch the notebook off.
- ▶ Unplug the AC plug of the AC adapter and all external devices from the power outlets.
- ▶ Disconnect the AC adapter cable and the data cables for all external devices.
- ▶ Close the LCD screen.
- ▶ To protect against damaging jolts and bumps, use a notebook carrying case to transport your notebook.

Cleaning the notebook



Do not clean any interior parts yourself; leave this job to a service technician.

Only use cleaning products designed for computers. Normal household cleaners and polishes can damage the markings on the keyboard and the device, the paintwork or the notebook itself.

Ensure that no liquid enters the notebook.

The LCD screen very sensitive to scratches. Only clean the display surface with a very soft, slightly damp cloth.

- ▶ Switch the notebook off.
- ▶ To prevent the device being switched on unintentionally, remove the AC plug of the AC adapter from the power outlet.
- ↳ The casing surfaces may be cleaned with a dry cloth. If particularly dirty, use a cloth which has been moistened in mild domestic detergent and then carefully wrung out.
Use disinfectant wipes to clean the keyboard and the touchpad, if present.
Ensure that no liquid enters the device!

First-time setup of your device



Please read the chapter ["Important notes", Page 12](#).

If your device is equipped with a Windows operating system, the necessary hardware drivers and supplied software are already pre-installed.

Before switching it on for the first time, connect the device to the AC voltage using the AC adapter, see ["Connecting the AC adapter", Page 17](#). The AC adapter must remain connected during the whole of the installation process.

A system test is performed when your device is first switched on. Various messages can appear. The display may remain dark for a short time or may flicker.

Please follow the instructions on the screen.

NEVER switch off your device during the first-time setup process.

The battery must be charged if you want to operate your device using the battery.

When used on the move, the built-in battery provides the device with the necessary power. You can increase the operating time by using the available energy-saving functions.

For instructions on how to connect external devices (e.g. mouse, printer) to your device, please refer to the operating manual for your device.

Unpacking and checking the device



If you find that damage has occurred during transport, please notify your local sales outlet immediately!

- ▶ Unpack all the individual parts.
- ▶ Check your device for any visible damage which may have occurred during transportation.



You may need to reuse the packaging in the future, for example if you need to ship your device.

Choose a location



Choose a suitable location for the device before setting it up. In doing so, please follow these instructions:

- Never place the device or the AC adapter on a heat-sensitive surface. The surface could be damaged as a result.
- Never place the device on a soft surface (e.g. carpeting, upholstered furniture, bed). This can block the air vents and cause overheating and damage.
- The underside of the device heats up during normal operation. Prolonged contact with the skin can become unpleasant or even result in burns.
- Place the device on a stable, flat, non-slippery surface. Please note that the rubber feet of the device may mark certain types of delicate surfaces.
- Keep other objects at least 100 mm / 3.97 inches away from the device and its AC adapter to ensure adequate ventilation.
- Never cover the ventilation openings of the device.
- Do not expose the device to extreme environmental conditions. Protect the device against dust, humidity and heat.

Connecting the AC adapter



Observe the safety notes in section ["Important notes", Page 12](#).

The supplied AC cable conforms to the requirements of the country in which you purchased your device. Make sure that the AC cable is approved for use in the country in which you intend to use it.

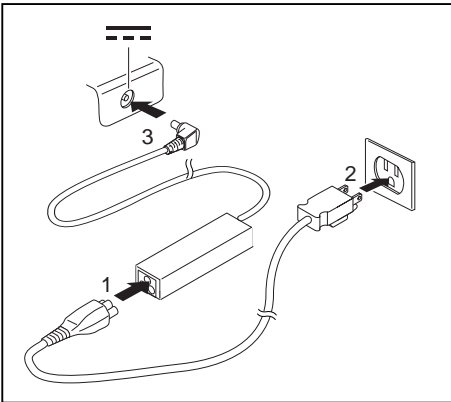

- ▶ Connect the AC cable (1) to the AC adapter.
- ▶ Plug the AC cable (2) into a power outlet.
- ▶ Connect the AC adapter cable (3) to the DC jack socket (DC IN) of the device.

Switching on the device for the first time

To make it easier to use your device for the first time, the operating system is pre-installed on the hard disk.

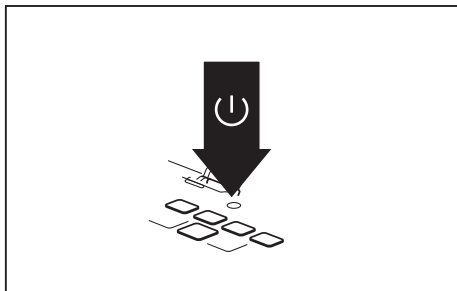

- ▶ Switch your device on.

- ▶ During the installation process, follow the on-screen instructions.



You can find information and help on the Windows operating system functions on the Internet at ["http://windows.microsoft.com"](http://windows.microsoft.com).

Installing Bonus Apps

The *Fujitsu Bonus Apps* utility can be launched via the *Start* menu.

- ▶ In the *Start* menu, click on *Fujitsu Extras*.
- ▶ Double-click on the *Application* folder.
- ▶ Double-click on the *Fujitsu BonusApps* shortcut.
- ▶ In the *User Account Control* dialog, confirm with *Yes* to launch the *Fujitsu Bonus Apps* utility
- ▶ Select the applications you wish to install by selecting the checkbox adjacent to your selection.

or

- ▶ Click *Select All* if you would like to install all available applications.
- ↳ Applications that are already installed appear in grey, those that are available for installation appear in blue.
- ▶ To confirm your selection, click *Install*.



Note that in some cases (depending upon which application was selected for installation) after installation completes, the system will prompt you to reboot.

There are also cases in which if multiple applications are selected to install but one of them needs a reboot, the system will reboot and continue installing the rest of the selected applications.

Working with the notebook

This chapter describes the basics for operating your notebook. Please refer to ["Connecting external devices", Page 48](#) for instructions on how to connect external devices such as a mouse and a printer to the notebook.



Please refer to the notes in the chapter ["Important notes", Page 12](#).

Opening the notebook

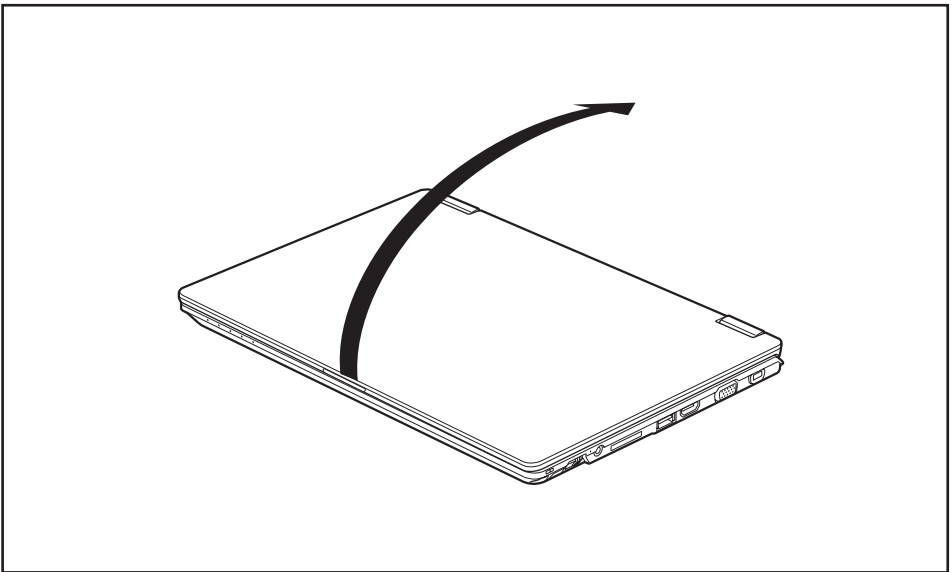

- ▶ Open the LCD screen.



CAUTION:

Do not pick up or hold the computer by the LCD screen. This can damage the LCD screen due to excessive flex. Always lift or carry your computer by holding the keyboard base with both hands.

Switching the notebook on normally

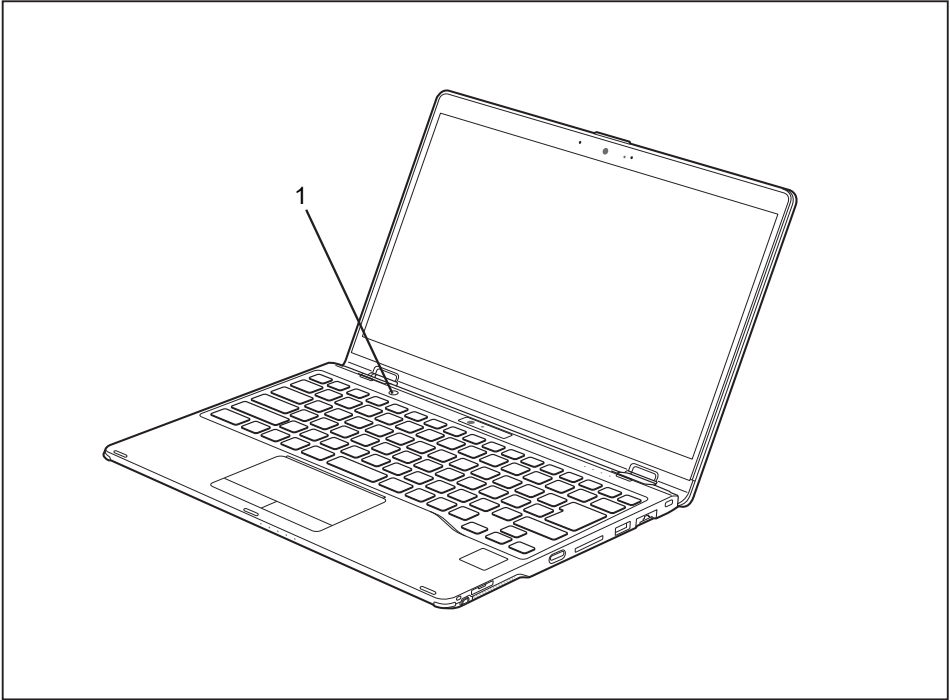

- ▶ Press the ON/OFF switch (1) to turn on the computer. Press Windows Button + 'X' key - Power Options - Additional Power settings to choose what the power buttons do.

The power-on indicator next to the ON/OFF switch (1) is lit as long as the system is switched on.

Programming the ON/OFF switch

You can program the ON/OFF switch:



Operating system	Menu
Windows® 10 Pro, Home and S	<i>Windows 10 Start - Control Panel - (Browse Control Panel -) Power Options - Choose what the power buttons do</i>



If you have assigned a password, you must enter this when requested to do so, in order to start the operating system. Detailed information can be found in the chapter ["Security functions", Page 62.](#)

Different ways to use your notebook

The different working modes allow you to use your device in a number of different usage scenarios.

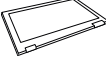
		Laptop Mode	Stand Mode	Tent Mode	Tablet Mode
					
Windows 10 Pro/Home	OS Mode	Desktop	Tablet		
	Auto rotation	OFF	ON		
	Keyboard / Touchpad	ON	OFF		

From notebook to Tablet PC

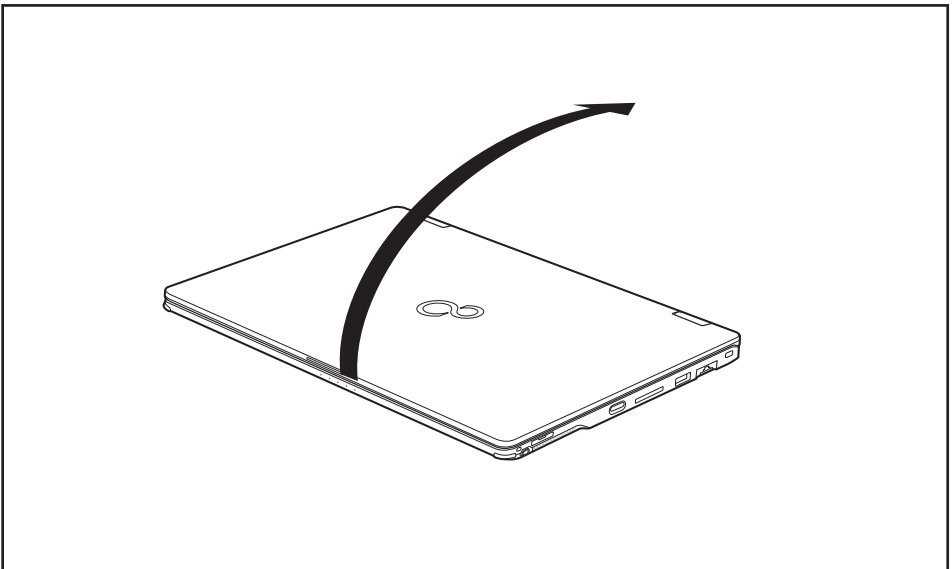

- Raise the LCD screen into a vertical position.



You can fold back the LCD screen infinitely variable in an angle between 0 and 360 degrees. There is a "Rotation lock" panel on Windows Action Center (* Right-down on LCD screen)

- ▶ Fold the screen down completely until the back of the screen is positioned against the bottom of the device.

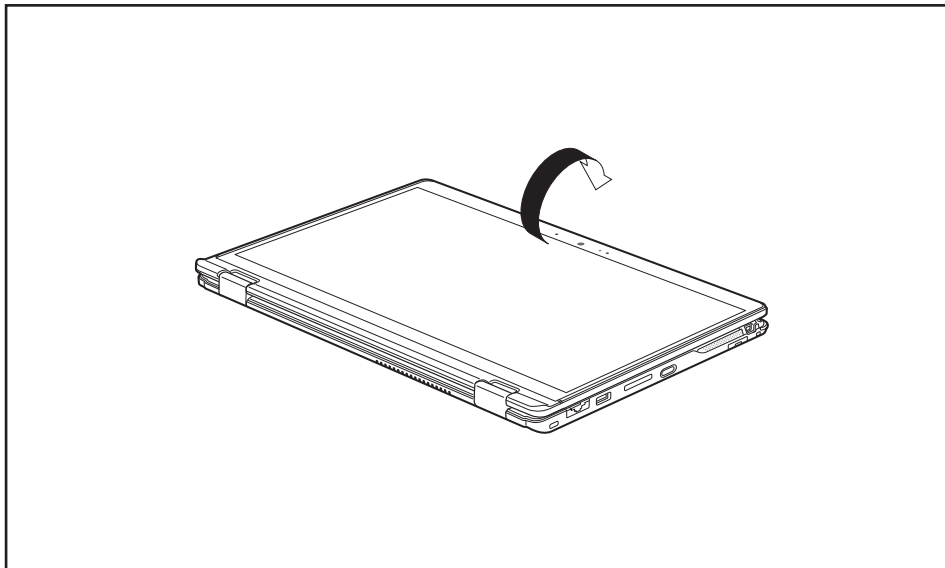

The screen is now in the tablet position. The keyboard, the touchpad and the touchpad buttons are switched off in this position.

Select display orientation (portrait or landscape format)

You can choose to use either portrait or landscape for the display, or whether the screen orientation should automatically adjust to the orientation of the tablet PC.



You can change these settings under *Control Panel - Hardware and Sound - Windows Mobility Center / Rotate screen*.



In the settings there are profiles saved for operation with different screen orientations. These profiles have preset standard configurations that can be modified as desired.

These settings do not just affect the screen settings on the Tablet PC, but also on external monitors that are connected.

From Tablet PC to notebook

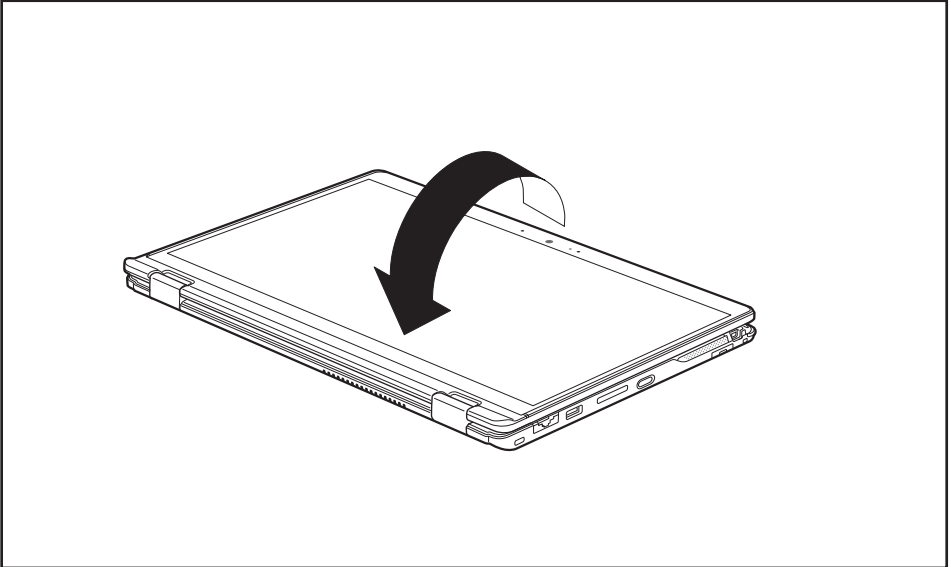

- ▶ Raise the LCD screen into a vertical position.
- ▶ Fold the monitor down until the desired position is reached.

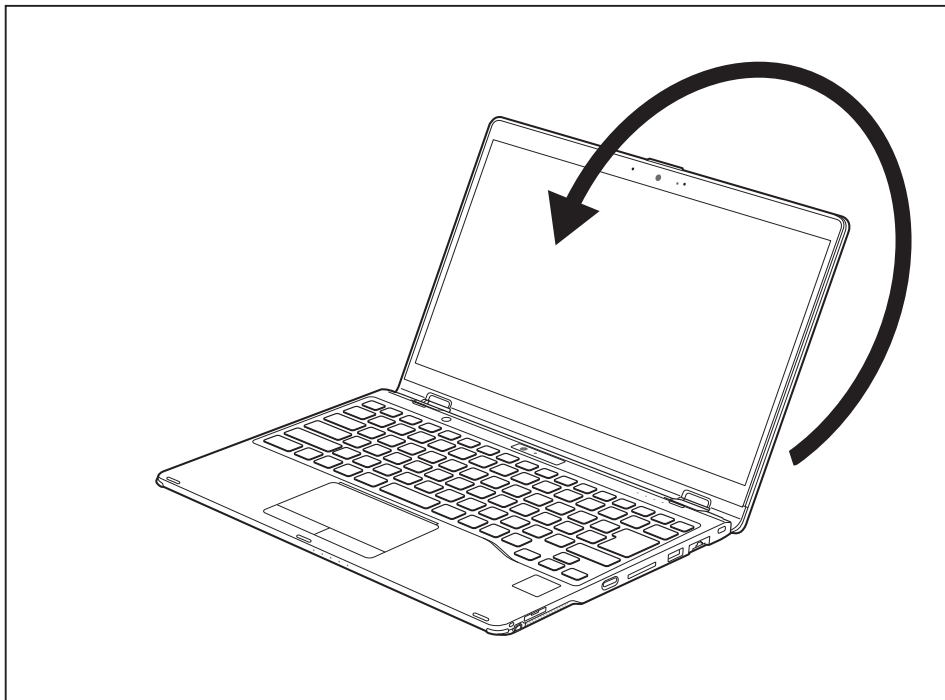

Switching off the notebook

- ▶ Close all applications and then shut down your operating system (please refer to the "Operating system manual").

Closing the notebook

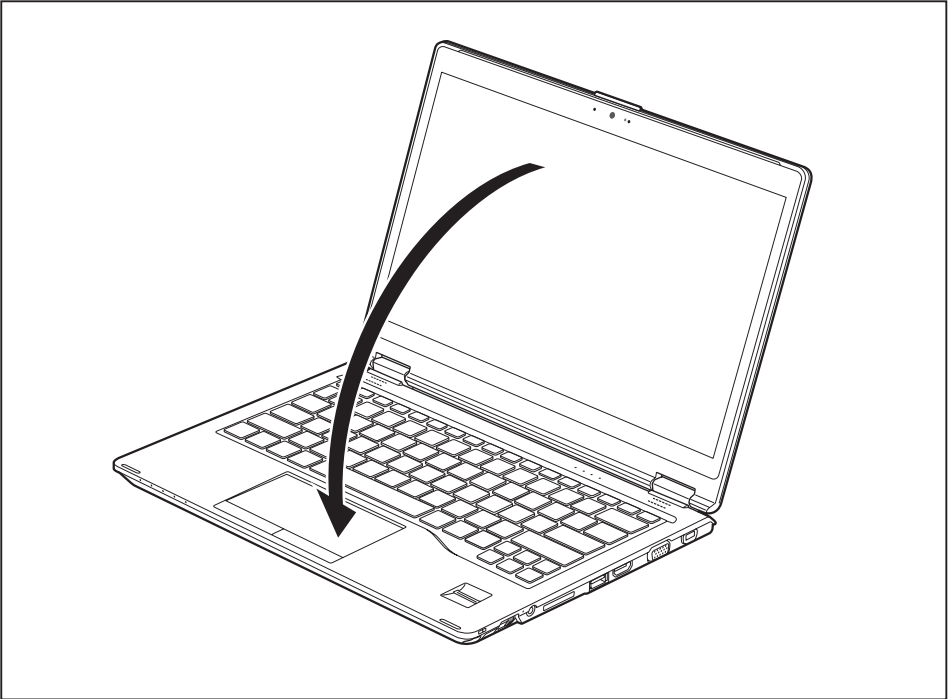

- Fold the LCD screen onto the lower section of the notebook.

Handwriting recognition

For detailed information on handwriting recognition, see the documentation for your operating system.

At present, handwriting recognition on Windows supports the following languages:

English, German, French, Italian, Japanese, Korean, Chinese (traditional and simplified), Dutch, Portuguese, Spanish, Brazilian, Norwegian (Bokmål and Nynorsk), Swedish, Finnish, Danish, Polish, Rumanian, Serbian (Cyrillic and Latin script), Catalan, Russian, Czech and Croatian.







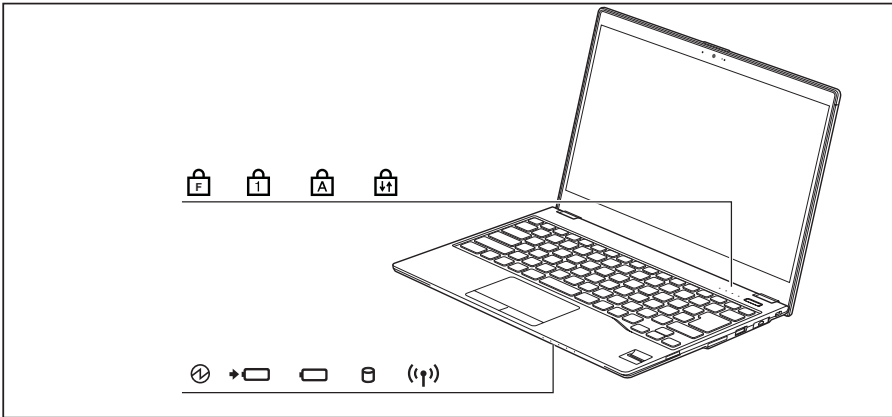

On Windows you can set the required language under *Control Panel – Time, Language and Region – Language*.





Status indicators

The status indicators provide information about the status of the power supply, the hard disks and the keyboard functions.

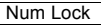

Display	Description
	<p>Power-on indicator/Standby</p> <ul style="list-style-type: none"> The indicator is illuminated: The notebook is switched on. The indicator flashes: The notebook is in standby mode. Indicator is off: The notebook is switched off.
	<p>Battery charging indicator/AC connection</p> <p>The battery charging level is shown by the rechargeable battery indicator.</p> <ul style="list-style-type: none"> The indicator lights up white: The rechargeable battery is charged or no rechargeable battery is inserted. The indicator light is orange: The AC adapter is connected and the battery is being charged. The indicator is flashing orange: The AC adapter is connected but the battery cannot be charged as the battery is too hot or too cold for charging. The charging process is continued as soon as the rechargeable battery has reached a permissible temperature again. The indicator is flashing red: A fault has occurred. The indicator is not lit up: The AC adapter is not connected.
	<p>Battery indicator</p> <ul style="list-style-type: none"> The indicator lights up white: The rechargeable battery is charged to between 51% and 100% of its maximum capacity. The indicator light is orange: The rechargeable battery is charged to between 13% and 50% of its maximum capacity. The indicator lights up red: The rechargeable battery is charged to between 0% and 12% of its maximum capacity. The indicator is flashing red: A fault has occurred.
	<p>Drive indicator</p> <p>The indicator is illuminated: The hard disk drive is being accessed.</p>
	<p>Wireless indicator</p> <ul style="list-style-type: none"> The indicator is illuminated: The wireless components are switched on. Indicator is off: The wireless components are switched off.
	<p>F Lock indicator</p> <p>The indicator is illuminated: The key combination  +  has been pressed. Instead of the special functions printed on the function keys, the Fn functions can be executed by pressing the keys directly (see chapter "Hot keys", Page 24).</p>
	<p>Num Lock indicator</p> <p>The indicator is illuminated: The  key has been pressed. The virtual number keys have been switched on. You can output the characters indicated on the upper right of the keys.</p>

Display	Description
	Caps Lock indicator The indicator is illuminated: The Caps Lock key has been pressed. All the characters you type will appear in upper case. In the case of overlay keys, the character printed on the upper left of the key will appear when that key is pressed.
	Scroll Lock indicator The indicator is illuminated: The key combination Fn + Scr Lk has been pressed. The effect that this key has varies between applications.

Switching the notebook on

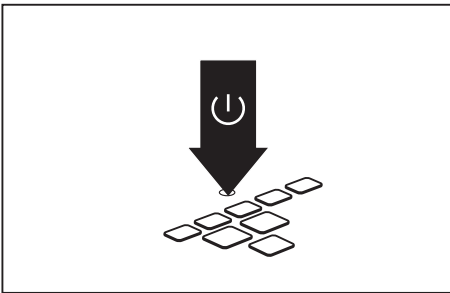

↳ The power-on indicator of the notebook is lit.

- ▶ Open the LCD screen.
- ▶ Press the ON/OFF button for about one second to switch on the notebook.

Switching the notebook off



Back up your data and close all applications before you switch off your device. Otherwise data might be lost.

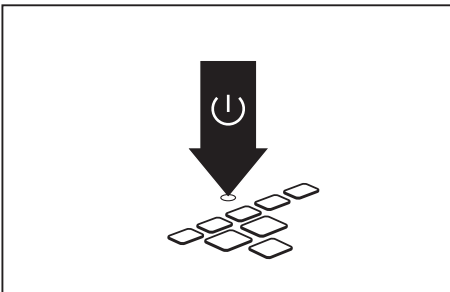

- ▶ Shut down the operating system correctly.
- ▶ If the notebook is not switched off automatically, press the ON/OFF button for approx. five seconds.
- ▶ Close the LCD screen.

Keyboard



The keyboard of your notebook is subject to continuous wear through normal use. The key markings are especially prone to wear. The key markings are liable to wear away over the life of the notebook.

The keyboard has been designed to provide all the functions of an enhanced keyboard. Some enhanced keyboard functions are mapped with key combinations.

The following description of the keys applies to the Windows operating system. Additional functions supported by the keys are described in the relevant manuals supplied with your application programs.







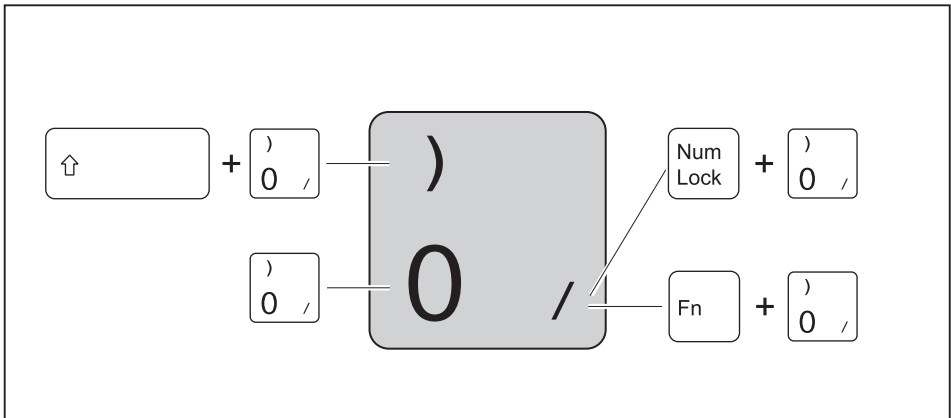

The following illustration shows how to access the different characters on keys with overlaid functions. The example applies when the Caps Lock key has not been activated.





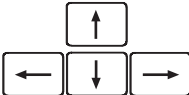
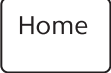

The illustration may differ from your device variant.



Key	Description
	Backspace The Backspace key deletes the character to the left of the cursor.
	Tab key The Tab moves the cursor to the next tab stop.
	Enter key (return) The Enter key terminates a command line. The command you have entered is executed when you press this key.

Key	Description
	<p>Caps Lock The [Caps Lock] key activates uppercase mode. The corresponding icon appears in the Windows notification area. In Caps Lock mode, all of the characters you type appear in upper case. In the case of overlay keys, the character printed on the upper left of the key will appear when that key is pressed. To cancel the Caps Lock function, simply press the Caps Lock key again.</p>
	<p>Shift key The [shift] causes uppercase characters to appear. In the case of overlay keys, the character printed on the upper left of the key will appear when that key is pressed.</p>
	<p>Fn key The [Fn] key enables the special functions indicated on overlay keys.</p>
	<p>Windows key The Windows key switches between the start screen and the last used application.</p>
	<p>Alt key When pressing the [Alt] key, special functions are activated when it is pressed in combination with other keys.</p>
	<p>Context Menu key The [Context Menu] key opens the menu for the active application.</p>
	<p>Ctrl key When pressing the [Ctrl] key, special functions are activated when it is pressed in combination with other keys.</p>
	<p>Cursor keys The cursor keys move the cursor in the direction of the arrow, i.e. up, down, left, or right.</p>
	<p>Home key The [Home] key moves the cursor to the beginning of the line, document page, cell, or screen, depending on where it is displayed.</p>
	<p>End key The [End] key moves the cursor to the end of the line, document page, cell, or screen, depending on where it is displayed.</p>

Key	Description
	<p>Insert key With the  key, you change between two input modes:</p> <ol style="list-style-type: none"> 1. Typeover mode: when typing, you overwrite the character at the current cursor position. 2. Insert mode: when typing, another character is inserted at the current cursor position. All characters to the right of the cursor are moved one position further.
	<p>Delete key With the  key, the character to the right of the cursor is deleted.</p>

Hot keys and function keys

The upper key row on the keyboard is labeled with hot key and function key icons:

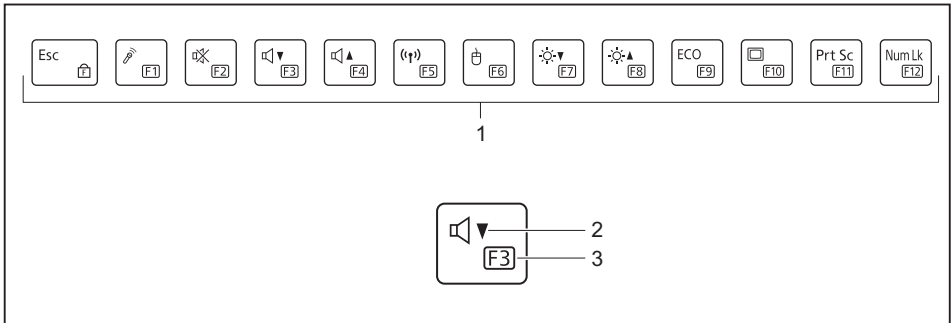

1 = Upper key row

3 = Function key



2 = Hot key









Hot keys

The symbols on the top of the keys represent hot keys.

The hot keys are used to turn on/off and control notebook functions (such as speakers, microphone, volume, and brightness). Hot keys are comfort functions.

The hot keys can be activated as the primary key function when Windows starts (see Chapter ["F-Lock setting", Page 26](#)).

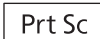
Hot key	Description
	<p>Switching the microphone on/off This hot key switches the microphone off or on.</p>
	<p>Switch the speakers on and off This hot key switches your notebook's speakers off and on.</p>

Hot key	Description
	Decrease the volume This hot key reduces the volume of the internal speakers.
	Increase volume This hot key increases the volume of the internal speakers.
	Switch the wireless components on / off This hot key switches the wireless components off or on.
	Switch the touchpad and touchpad buttons on/off This hot key combination switches the touchpad and the touchpad keys on or off.
	Decrease the brightness of the screen This hot key reduces screen brightness.
	Increase screen brightness This hot key increases screen brightness.
ECO	Energy saving functions Use this hot key to activate the energy saving functions (see chapter "Using the energy saving functions" , Page 34).
	Switch between display outputs Use this hot key to select which screen(s) is/are used for display if an external monitor is connected. Screen output is possible: <ul style="list-style-type: none"> • only on the LCD screen of the notebook • on the LCD screen of the notebook and the external monitor at the same time • only on the external monitor This setting is useful if you would like a high resolution and a high refresh rate on an external monitor.
	Create screenshot With this hot key, a screenshot of the current screen image is created and stored in the clipboard.
	Switch virtual number keys on/off This hot key switches the virtual number pad off or on. The characters marked at the top right of the keys are displayed.

Function keys

The symbols below the keys represent function keys.

They are numbered from **F1** to **F12**.

The function keys are used to activate functions of the operating system or applications directly.

Regardless of the F-Lock setting, the function keys are the primary key function:

- until Windows is loaded (after a system reboot).
The F-Lock setting, which was last active before the system reboots, then reappears (see chapter ["F-Lock setting", Page 26](#)).
- with BIOS access during the POST phase: When during boot-up **Fn** + **F2** or **Fn** + **F12** are pressed, the BIOS menu is not called up. Here the **F2** or **F12** key must be pressed without an additional key.

F-Lock setting

With the **F Lock** key you can set either the hotkeys or the function keys as the primary function for the upper key row.

F Lock is disabled by default in the delivery state.

- ▶ By pressing **Fn** + **Esc** F-Lock is switched on and off.
- ↳ When F-Lock is switched on, it is activated like the **Caps Lock key**.

When changing the F-Lock setting, the primary and secondary key functions change as follows:

Status	Hot key	Function key
F-Lock is switched off (F-Lock symbol not illuminated)	The hot keys become the primary function: ▶ They are used by simply pressing the hot key.	The function keys become the secondary function: ▶ They are used by pressing Fn + Function key.
F-Lock is switched on (F-Lock symbol illuminated)	The hot keys become the secondary function: ▶ They are used by pressing Fn + hot key.	The function keys become the primary function: ▶ They can used by simply pressing the Function Key.













Key combinations

The key combinations described below apply when using Microsoft Windows operating systems. Some of the following key combinations do not function in other operating systems or with certain device drivers.

Other key combinations are described in the relevant manuals supplied with your application programs.

Key combinations are entered as follows:







- ▶ Press the first key in the key combination and keep it pressed.
- ▶ While holding the first key down, press the other key or keys in the combination.

Combination	Description
 + 	Switching F-Lock on/off This key combination is used to switch the F-Lock function on and off (see chapter "F-Lock setting" , Page 26).
 + 	Switch between open applications This key combination is used to switch between open applications.
 +  + 	Open Windows Security or Task Manager This key combination opens the Windows "Security" window or Task Manager.
 + 	Back tab This key combination moves the cursor back to the previous tab stop.
 + 	Switch the scroll lock on / off This key combination activates special functions, which differ from application to application.
 + 	Control keyboard backlight This key combination switches between the keyboard backlight settings (low, high, and off - configuration-dependent).



Key combinations using the Windows keys are detailed in the manual for your operating system.

In addition, the following unlabeled key combinations are supported:

-  +  = Pause
-  +  = Break
-  +  = SysRq

Virtual number keys

Virtual number keys are provided so that the keys of a numeric keypad can be used for certain applications. The virtual number keys are recognizable on the keyboard by the numbers and symbols printed in the lower right corner of each key. If you have switched on the virtual number keys, you can output the characters shown on the lower right of the keys.



The key assignment shown below may be different from the keyboard layout of your device variant.

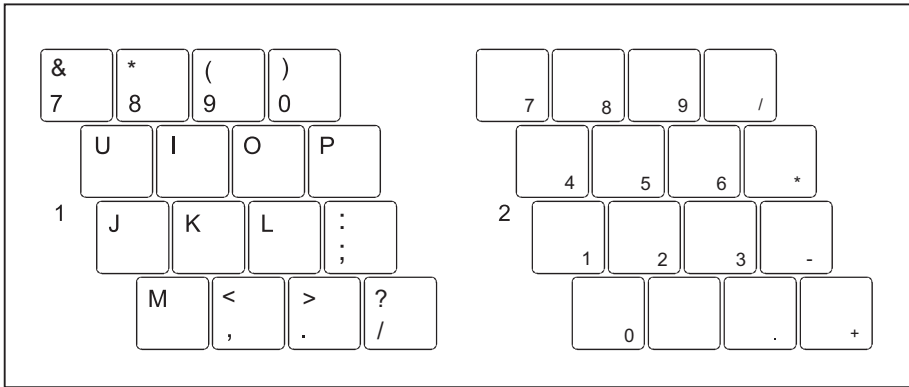

1 = Valid characters when the **Num Lk** key is not activated

2 = Valid characters when the **Num Lk** key is activated

Further information about the status indicators can be found in chapter ["Status indicators", Page 19](#).

Country and keyboard settings

- ▶ Make the country and keyboard settings as described in the documentation for your operating system.

Touchpad and touchpad buttons



Keep the touchpad clean. Protect it from dirt, liquids and grease.

Do not use the touchpad if your fingers are dirty.

Do not rest heavy objects (e.g. books) on the touchpad or the touchpad buttons.

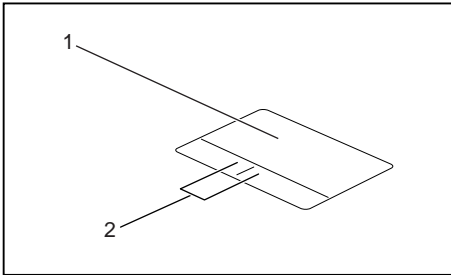

1 = Touchpad

2 = Touchpad buttons

The touchpad enables you to move the mouse pointer on the monitor.

The touchpad buttons allow you to select and execute commands. They correspond to the buttons on a conventional mouse.



You can also deactivate the touchpad by pressing key **F6**, so that you cannot move the pointer on the monitor unintentionally (see chapter ["Hot keys", Page 24](#)).

Moving the pointer

- ▶ Move your finger on the touchpad.
- ↳ The pointer will move.

Selecting an item

- ▶ Move the pointer to the item you wish to select.
- ▶ Tap the touchpad once or press the left button once.
- ↳ The item is selected.

Executing commands

- ▶ Move the pointer to the field you wish to select.
- ▶ Tap the touchpad twice or press the left button twice.
- ↳ The command is executed.

Dragging items

- ▶ Select the desired item.
- ▶ Press and hold the left button and drag the item to the desired position with the finger on the touchpad.
- ↳ The item will be moved.

Touchscreen/LCD screen without touch function (device-dependent)

High-quality LCD screens (TFT) are installed in Fujitsu notebooks. For technical reasons, these screens are manufactured for a specific resolution. An optimal, clear picture can only be ensured in the resolution intended for the particular screen. A resolution which differs from the specification can result in an unclear picture.

The resolution of the monitor of your notebook is optimally set at the factory.

Current production technology cannot guarantee an absolutely fault-free screen display. A few isolated constantly lit or unlit pixels may be present.

Background lighting

LCD screens are operated with background lighting. The luminosity of the background lighting can decrease during the period of use of the notebook. However, you can set the brightness of your monitor individually.

Synchronizing the display on the LCD screen and an external monitor

For more information, please refer to the chapter ["Hot keys", Page 24](#) under "Display output, switch between".



Do not lift or hold the device by the LCD screen. This can damage LCD screen due to overstressing. Always lift/carry device by holding the keyboard base with both hands.

Using fingers

You can execute commands and start applications by using finger tip on the touchscreen of your device.

Action	Description
Tap	<ul style="list-style-type: none"> ▶ Tap on a symbol, menu, a button or folder to select this option or to activate it.
Tap, hold, release	<ul style="list-style-type: none"> ▶ Tap and hold an icon and release it again. The selected action is performed.
Dragging	<ul style="list-style-type: none"> ▶ Touch and hold a symbol and drag it to another place. <p>For instance, you can drag apps or widgets onto the start-up screen in this way.</p>
Double tap	<ul style="list-style-type: none"> ▶ To increase the size of a view, quickly tap twice on a web page, map or another screen. <p>If you double-tap on a picture in a browser, it will be enlarged, another double-tap makes it smaller again.</p>
Zoom in/Zoom out	<ul style="list-style-type: none"> ▶ With some apps, you can enlarge the display size by moving two fingers apart on the touchscreen, and reduce it by moving your fingers together.
Input fields	<p>With some apps, data must be entered, for instance an Internet address or your name or password.</p> <ul style="list-style-type: none"> ▶ Tap on an input field. <p>An on-screen keyboard opens, with which you can enter your data.</p>

Webcam



Your device includes a webcam with integrated microphone.

Depending on the software used, you can use your webcam to take pictures, record video clips or take part in web chats.

The webcam has its own status indicator. The indicator lights up when the webcam is active.

- The picture quality depends on the lighting conditions and the software being used.
- You can only operate the webcam with a particular application (e.g. an Internet telephony program or a video conferencing program which supports a webcam).
- When using the webcam, the notebook base must not wobble.
- The webcam automatically adjusts itself to the current light level. For this reason the LCD display may flicker while the light level is adjusted.



Further information on use of the webcam and additional settings for your webcam can be found in the help function of the program using the webcam.

Rechargeable battery

During use as a portable, the notebook runs on its built-in battery. You can increase the service life of the battery by caring for the battery properly. The average battery service life is around 500 charge/discharge cycles.

You can extend the battery service life by taking advantage of the available energy saving functions.

Charging, caring for and maintaining the battery

The notebook battery can only be charged if the ambient temperature is between 5°C / 41°F and a maximum of 35°C / 95°F.

You can charge the battery by connecting the notebook to the AC adapter (see ["Connecting the AC adapter", Page 17](#)).

Be aware that the battery will not charge when the battery charge level is between 90% and 100%. If the battery charge level is less than 90% and the AC adapter is connected, the battery charges up to 100%.

When the battery charge level is low, a message from the operating system is displayed. If you do not connect the AC adapter within five minutes of the message described above, your notebook will automatically switch off.

Monitoring the battery state of charge

Windows also has a "Battery charge meter" in the taskbar for monitoring the battery capacity. When you place the mouse pointer on the battery symbol, the system displays the state of charge of the battery.

Switching the battery on and off

Switching the battery off



To switch the battery on, you will need the AC adapter.

- ▶ Disconnect the device from the AC adapter of the notebook and, if relevant, also from the dock.
 - ▶ Press a pen or a piece of wire (e.g. a paper clip) firmly into the opening of the ON/OFF button for the battery to switch the system off.
- ↳ The device is deactivated.

Switching the battery on

- ▶ Connect the device to the AC adapter of the notebook or to the dock.
- ▶ Switch the device on again.

Using the energy saving functions

The notebook uses less power when the available energy-saving functions are used. You will then be able to work longer when using the battery before having to recharge it.



The energy efficiency is increased and environmental pollution is reduced. By choosing the best power options, you can make significant savings and at the same time help protect the environment.

When you fold down and close the LCD screen, depending on the setting in Windows, the notebook automatically enters a power saving mode.

- ▶ Set the energy saving functions in your Control Panel.



If you need further information about an option, you can get help with most settings by pressing **F1** to open the Microsoft Help.

When the notebook is in energy saving mode, the following must be remembered:



During energy saving mode, open data is held in main memory or in a swap file on the hard disk.

Never switch the notebook off while it is in an energy saving mode. If the built-in battery is nearly flat, close all open files and do not go into energy saving mode.

If you do not intend to use your notebook for a long period of time:

- ▶ Exit energy saving mode if necessary by moving the mouse, making an entry at the keyboard or by switching on the notebook.
- ▶ Close all opened programs and completely shut down the notebook.

Memory cards

Your notebook is equipped with an integrated memory card reader.



Follow the manufacturer's instructions when handling the memory cards.

Supported formats

Your notebook supports the following format:

- Secure Digital (SD™ Card)

Inserting the memory card

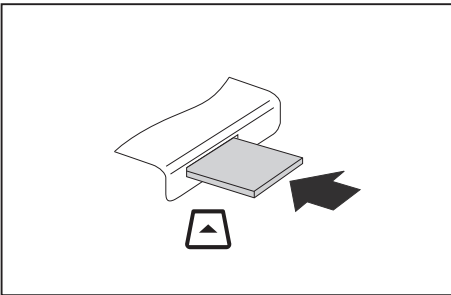

- ▶ Gently push the memory card into the slot until you feel it click into place. The label area must be facing upward. Do not apply excessive force, as otherwise the delicate contact surfaces could be damaged.
- ↳ Depending on the particular type used, the memory card may protrude slightly from the slot.

Removing the memory card



To avoid any loss of data, always follow the correct procedure for removing the card (see the documentation for your operating system).

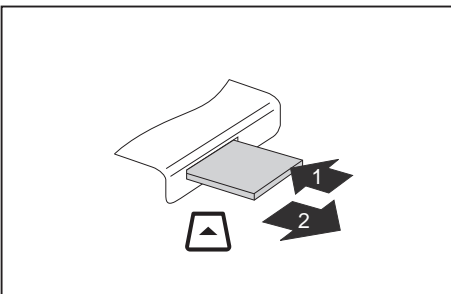

- ▶ Press on the memory card (1).
- ↳ The memory card is released and can now be removed.
- ▶ Pull the memory card out of the slot (2).

Speaker and microphones

You can find information about the exact position of speakers and microphones in chapter ["Ports and controls", Page 10](#).

Please refer to chapter ["Hot keys", Page 24](#) for information on setting the volume and also enabling/disabling the speakers using key combinations.



When you connect headphones or external speakers, the built-in speakers are disabled.

You can find information on connecting headphones and a microphone in chapter ["Connecting external devices", Page 48](#).

Wireless LAN/Bluetooth wireless components



The installation of wireless components not approved by Fujitsu will invalidate the certifications issued for this device.



This computer uses an Intel® Wireless-AC 9560 module. According to Intel®, this module supports 256-bit AES-GCMP encryption. Full support depends on general industry availability of WPA3-Enterprise enabled operating system and related support.

Switching the wireless components on and off

▶ Press the  key to change the wireless mode.

↳ The wireless indicator will illuminate when one or more wireless components are switched on.



If you switch off the wireless components, the wireless LAN antenna and the Bluetooth module will also be switched off.

You can activate and deactivate the installed wireless components individually using the wireless settings.

Pay attention to the additional safety notes for devices with wireless components provided in the ["Important notes", Page 12](#) section.

Details on using a wireless LAN can be found in the online help system included in the wireless LAN software.

You can find more information on how to use Bluetooth in the information received with your Bluetooth device.

Configuring WLAN access

- Requirement: A WLAN is available and you have the necessary access data on hand.



Information on configuring WLAN access can be found in the documentation for your operating system.

Further information on WLAN and Bluetooth

For further information about WLAN or Bluetooth, please refer to the appendix of this Operating Manual.

For WLAN specifications, see chapter ["WLAN specifications", Page 66](#).

Ethernet and LAN

The internal network module of your notebook supports Ethernet LAN. You can use it to establish a connection to a local network (LAN = Local Area Network).

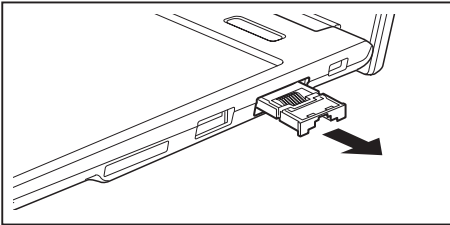

- ▶ Pull the LAN adapter out of the LAN port on the notebook in the direction of the arrow.

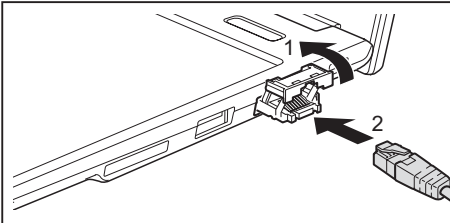

- ▶ Push the LAN adapter upwards in the direction of the arrow (1).
- ▶ Plug the network cable into the LAN adapter (2).
- ▶ Connect the network cable to your network port.



Your network administrator can help you to configure and use the LAN connections.

The network cable is not included in the delivery scope. This type of cable can be obtained from a specialist dealer.

Use a shielded network cable (CAT 5e).

Your USB Type-C dock (optional)

Your dock is a device that helps you to quickly connect your notebook to your peripheral devices, such as a monitor, printer, etc.

The features offered by the dock include standard ports for monitor, audio and other USB devices, such as mouse and keyboard.

You need only connect the notebook to the dock in order to work with your peripheral devices.

Ports on the dock

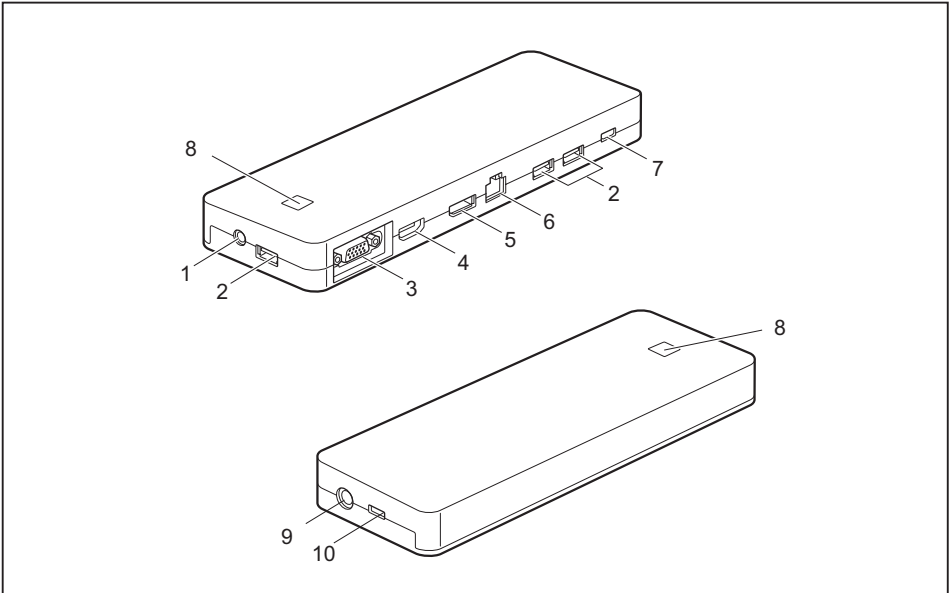

- 1 = Combined headphones/microphone port
- 2 = USB port 3.1 Gen 1 (USB Type-A)
- 3 = VGA monitor port
- 4 = HDMI
- 5 = Display Port
- 6 = LAN port
- 7 = USB 3.1 Gen 1 port for data connection only (USB Type-C)

- 8 = ON/OFF button with power-on indicator
- 9 = DC input connector (DC IN)
- 10 = USB 3.1 Gen 1 port for data connection and power supply for the notebook (USB Type-C)

Setting up the dock



Choose a suitable location for the dock before setting it up. In doing so, please follow these instructions:

- Never place the dock on a soft surface (e.g. carpeting, upholstered furniture, bed). This can block the air vents of the notebook and cause overheating and damage.
- Place the dock on a stable, flat, non-slippery surface. Please note that the rubber feet of the dock may mark certain types of delicate surfaces.
- Never place the dock or the AC adapter on a heat-sensitive surface.
- Do not expose the dock to extreme environmental conditions.
Protect the dock against dust, humidity and heat.

Connect the AC adapter to the dock

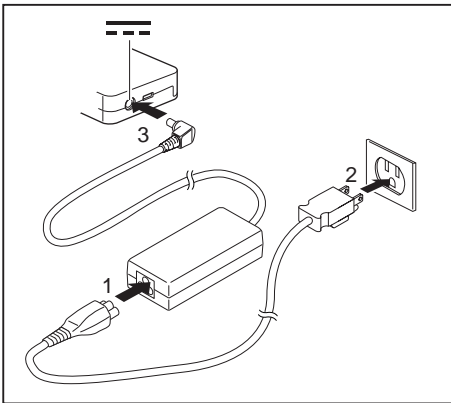

- ▶ Connect the AC cable to the AC adapter (1).
- ▶ Plug the AC cable into the power outlet (2).
- ▶ Connect the AC adapter cable to the DC jack (DC IN) of the dock (3).



When the notebook is connected to a dock, the operating system creates a hardware profile for the "Docked" mode. In this profile, for example, the monitor which was last used for output is saved as a setting. This profile will be loaded as soon as the notebook is connected to a dock of the same type.

Connect the notebook to the dock

- ▶ Disconnect the AC adapter cable from the DC jack (DC IN) of the notebook.

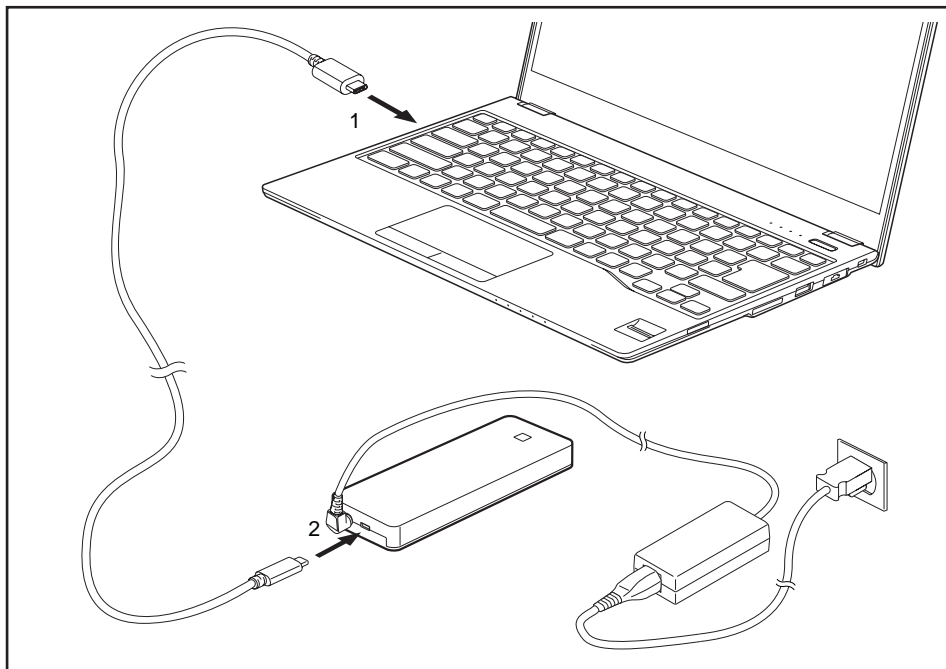

- ▶ Connect one end of the USB cable (USB Type-C) to the USB 3.1 Gen 1 port with charging function (USB Type-C) on the notebook (1).
- ▶ Connect the other end of the USB cable (USB Type-C) to the USB 3.1 Gen 1 port for data connection and power supply (USB Type-C) on the dock (2).

Switching on the notebook via the dock

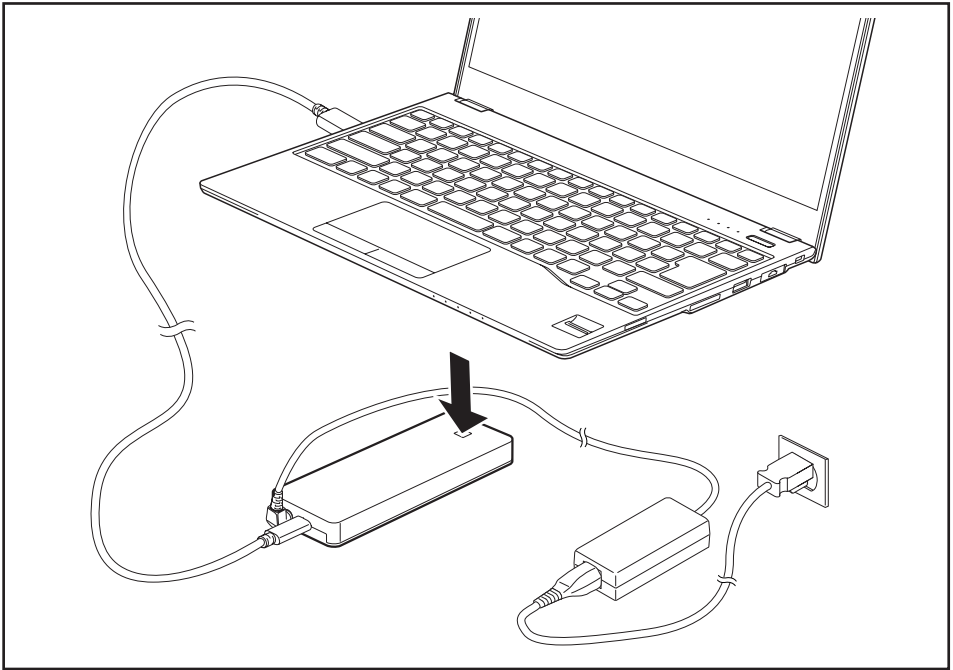

- ▶ Press the ON/OFF button on the dock to switch on the notebook.

Switching off the notebook via the dock

- ▶ Close all applications and then shut down your operating system (please refer to the manual for the operating system).



If the notebook cannot be shut down properly, press the ON/OFF button on the notebook for approx. four seconds. The notebook will switch off. Any data not saved may be lost.

Disconnecting the notebook from the dock

- ▶ Disconnect the supplied USB cable (USB Type-C) from the USB 3.1 Gen 1 port (USB Type-C) on the notebook.

Security functions

Your notebook has a variety of security functions that you can use to protect your system and your personal data from unauthorized access.

This chapter explains how to use these functions, and what the benefits are.



Please remember that in some cases, for example, forgetting your password, you may be locked out of the system and unable to access your data. Therefore, please note the following information:

- Make regular backups to external optical disks such as external hard drives, CDs, DVDs or Blu-ray Discs.
- Some security functions need you to choose passwords. Make a note of the passwords and keep them in a safe place.

If you forget your passwords you will need to contact our Service Desk. Deletion or resetting of passwords are not covered by your warranty and a charge will be made for assistance.

Configuring the fingerprint sensor



Whether your device has a fingerprint sensor or not depends on the device configuration which you ordered.

Once purchased, your configuration cannot be changed to include the fingerprint sensor. Also, only the fingerprint sensor or palm vein sensor can be installed when configured, not both.

The fingerprint sensor can record the image of a fingerprint. With additional fingerprint software, this image can be processed and used instead of a password.

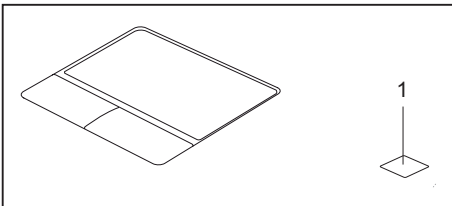

- ▶ Install the fingerprint software *Work Place Protect* to be able to use the fingerprint sensor (1).



Work Place Protect can be found under Fujitsu Bonus Apps. The shortcut can be found under *Start - Fujitsu Extras - Application*. Double click on the shortcut. A window with a list of apps is displayed. Select *Work Place Protect* and install the app. The software is also available on the Fujitsu Support Site.

Setting up the palm vein sensor

i

Whether your device has a palm vein sensor or not depends on the device configuration which you ordered,

Once purchased, your configuration cannot be changed to include the palm vein sensor. Also, only the fingerprint sensor or palm vein sensor can be installed when configured, not both.

The palm vein sensor can record the image of the veins on the palm of your hand. This image is evaluated with additional software and can be used in place of a password.

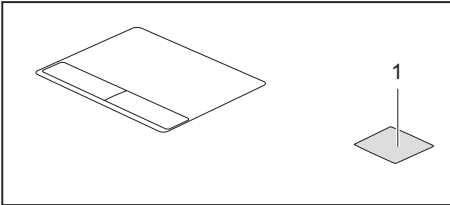

- ▶ Install the software *Work Place Protect* to use the palm vein sensor (1).

i

Work Place Protect can be found under Fujitsu Bonus Apps. The shortcut can be found under *Start - Fujitsu Extras - Application*. Double click on the shortcut. A window with a list of apps is displayed. Select *Work Place Protect* and install the app. The software is also available on the Fujitsu Support Site.

Using the Security Lock

Your device comes with a Security Lock mechanism for the Kensington Lock Cable. You can use the Kensington Lock Cable, a sturdy steel cable, to help protect your notebook from theft. The Kensington Lock Cable is available as an accessory.

i

Fujitsu recommends the use of a combination lock.

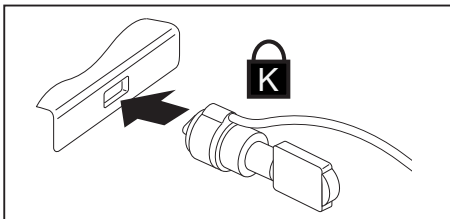

- ▶ Fit the Kensington Lock Cable to the mechanism on your notebook.

Configuring password protection in BIOS Setup Utility



Before using the various options for password protection in the *BIOS Setup Utility*, please proceed as follows to increase data security:

Make a note of the passwords and keep them in a safe place. If you forget your supervisor password you will not be able to access your notebook. Passwords are not covered by your warranty and a charge will be made for assistance.



Your password can be up to eight characters long and can contain letters and numbers. No distinction is made between uppercase and lowercase.

Protecting BIOS Setup Utility (supervisor password and user password)



If you have opened these operating instructions on the screen, we recommend that you print them out. You cannot call up the instructions on the screen while you are setting up the password.

The supervisor password and the user password both prevent unauthorized use of the *BIOS Setup Utility*. The supervisor password allows you to access all of the functions of the *BIOS Setup Utility*, while the user password will only give you access to some of the functions. You can only set up a user password if a supervisor password has already been assigned.



Calling and using the *BIOS Setup Utility* is described in the chapter "[Settings in BIOS Setup Utility](#)", Page 55.

Assigning the supervisor and user passwords

- ▶ Start the *BIOS Setup Utility* and go to the *Security* menu.
- ▶ Select the *Set Supervisor Password* field and press the Enter key.
 - ↳ With *Enter new Password*: you are asked to enter a password.
- ▶ Enter the password and press the Enter key.
 - ↳ *Confirm new Password* requires you to confirm the password.
- ▶ Enter the password again and press the Enter key.
 - ↳ *Changes have been saved* is displayed as a confirmation that the new password has been saved.
- ▶ To set the user password, select *Set User Password* and proceed exactly as when configuring the supervisor password.
 - ↳ If you do not want to change any other settings, you can exit *BIOS Setup Utility*.
 - ▶ In the *Exit* menu, select the option *Save Changes & Exit*.
 - ▶ Select *Yes* and press the Enter key.
 - ↳ The notebook is then rebooted and the new password comes into effect. It will now be necessary to first enter your supervisor or user password in order to open the *BIOS Setup Utility*. Please note that the user password only provides access to a few of the BIOS settings.

Changing the supervisor password or user password

You can only change the supervisor password when you have logged into the *BIOS Setup Utility* with the supervisor password.

- ▶ Start the *BIOS Setup Utility* and go to the *Security* menu.
- ▶ When changing the password, proceed exactly as when assigning a password.

Removing passwords

To remove a password (without setting a new password) perform the following steps:

- ▶ Start the *BIOS Setup Utility* and go to the *Security* menu.
- ▶ Highlight the *Set Supervisor Password* or *Set User Password* field and press the Enter key.
- ↳ You will be requested to enter the current password by the *Enter Current Password* prompt. *Enter New Password* will appear and you will be requested to enter a new password.
- ▶ Press the Enter key twice at this request.
- ▶ In the *Exit* menu, select the option *Save Changes & Exit*.
- ▶ Select *Yes* and press the Enter key.
- ↳ The notebook will now reboot with the password removed.
With the supervisor password, you simultaneously deactivate the user password.

Password protection for booting the operating system

i

With the supervisor password you have set in the *BIOS Setup Utility* (see section ["Assigning the supervisor and user passwords", Page 44](#)), you can also prevent booting of the operating system.

Activating system protection

- ▶ Start the *BIOS Setup Utility* and go to the *Security* menu.
- ▶ Select the *Password on Boot* option and press the Enter key.
- ▶ Select the option you require (*Disabled*, *First Boot* or *Every Boot*) and press the enter key
- ▶ Select the *Save Changes & Exit* option under *Exit*.
- ↳ The notebook will reboot. You will be prompted to enter your password (the supervisor password).

Deactivating system protection

- ▶ Start the *BIOS Setup Utility* and go to the *Security* menu.
- ▶ Select the *Password on Boot* option and press the Enter key.
- ▶ Select the *Disabled* option and press the Enter key.
- ↳ If you do not want to change any other settings, you can exit *BIOS Setup Utility*.
- ▶ Select the *Save Changes & Exit* option under *Exit*.
- ↳ The notebook will reboot. The system is no longer password-protected.

Password protection for the hard disk

If a supervisor password was set, an additional password for the hard disk can be set in the *Hard Disk Security* menu.

The hard disk is protected by this password. Data on this hard disk can then only be read in another system if the correct password is entered.

Trusted Platform Module - TPM (device dependent)

To use the TPM, you must enable the TPM in the *BIOS Setup* **before the software is installed**. The condition for this is that you have assigned at least the supervisor password (see ["Security functions", Page 42](#)).

For how to call up and operate the *BIOS Setup Utility*, see Section ["Settings in BIOS Setup Utility", Page 55](#).

Enabling TPM

- Requirement: You have assigned a supervisor password (see ["Security functions", Page 42](#)).
- ▶ Call BIOS Setup and select the *Security* menu.
- ▶ Mark the *TPM (Security Chip) Setting* field and press the Enter key.
- ▶ Select the "*Security Chip*" "*Enabled*" entry to enable the TPM
- ↳ Once you have enabled the TPM by rebooting, the *Clear Security Chip* menu item appears. If the TPM was already in use, you can use *Clear Security Chip* to clear the holder in the TPM. With *Enabled*, all secret keys (e.g. SRK - Storage Root Keys, AIK - Attestation Identity Keys etc.) generated by applications are deleted.

Take note that you can then no longer access the data you have encrypted on the holder-based keys!
- ▶ Select the *Exit Saving Changes* option in the Exit menu.
- ▶ Press the Enter key and select *Yes*.
- ↳ The notebook restarts and the TPM is switched on after the reboot.

Disabling TPM

- Requirement: You have assigned a supervisor password (see ["Security functions", Page 42](#)).
- ▶ Call BIOS Setup and select the *Security* menu.
- ▶ Mark the *TPM (Security Chip) Setting* field and press the Enter key.
- ▶ Select the "*Security Chip*" "*Disabled*" entry to deactivate the TPM.
- ▶ From the *Exit* menu, choose the option *Exit Saving Changes*.
- ▶ Press the Enter key and select *Yes*.
- ↳ The notebook will now reboot with TPM deactivated.

Smart Card reader

Smart Cards are not supplied as standard equipment. You can use all Smart Cards that comply with the ISO standard 7816-1, -2 or -3. These Smart Cards are available from various manufacturers.

With the appropriate software you can use your Smart Card as an alternative to password protection, but also as a digital signature, for encrypting your e-mails or for home banking.

We recommend that you always use two Smart Cards. Always keep one of the Smart Cards in a safe place if you are carrying the other Smart Card with you.

Inserting the Smart Card



Do not use force when inserting and removing the Smart Card.

Make sure that foreign objects do not fall into the Smart Card reader.

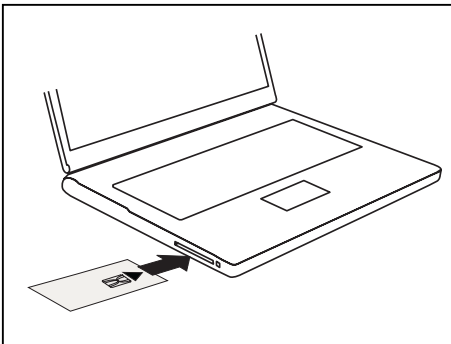

- ▶ Slide the Smart Card into the Smart Card reader with the chip facing upwards (or downwards depending on the device) and to the front.

Connecting external devices



Under all circumstances, please observe the safety notes provided in the ["Important notes", Page 12](#) chapter before connecting or disconnecting any devices to or from your notebook.

Always read the documentation supplied with the device you wish to connect.

Never connect or disconnect cables during a thunderstorm.

Never pull at a cable when disconnecting it. Always grasp the plug.



With some devices such as USB devices, it is not necessary to switch off the notebook and the device before connecting/disconnecting. For more information about whether or not devices need to be switched off, please refer to the documentation supplied with the external device.

Some of the external devices require special drivers (see the operating system and external device documentation).

HDMI port

The HDMI port on your notebook or the optional dock can be used to connect an external amplifier, LCD TV or a plasma TV with an HDMI connection.

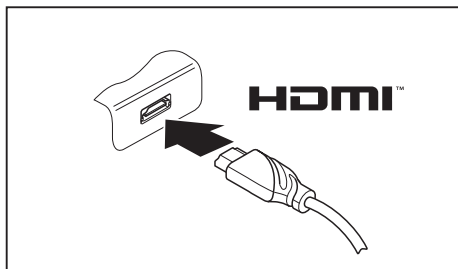

- ▶ Connect the data cable to the external device.
- ▶ Connect the data cable to the HDMI port on the notebook or on the optional dock.

Connecting an external monitor to the dock

An analog monitor is connected to the analog external monitor port (VGA) and a digital monitor to the Display Port on the optional dock. The display output is limited to a maximum of two monitors at the same time (see ["Hot keys", Page 24](#), the section on "Toggling the display output").

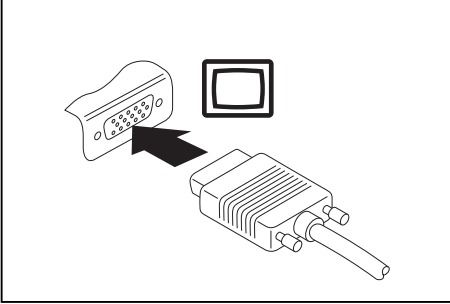

Analog external monitor port (VGA) (on the optional dock)

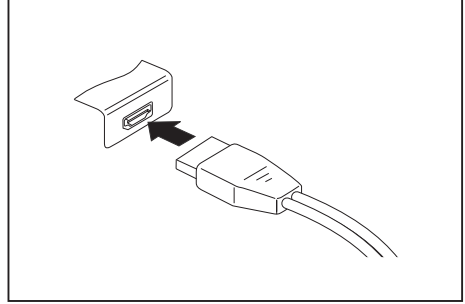

Digital Display Port (on the optional dock)

- ▶ Switch off the notebook and the external monitor.
- ▶ Plug the data cable of the external monitor into the monitor port.
- ▶ First switch on the external monitor and then the notebook.



You can also switch back and forth between the external monitor and the LCD screen of the notebook, see chapter ["Hot keys", Page 24](#).

You can display the same picture on the external monitor and the notebook LCD screen simultaneously.

Connecting USB devices

On the USB ports you can connect external devices that also have a USB port (e.g. a DVD drive, a printer, a scanner or a modem).



USB devices are hot-pluggable. This means you can connect and disconnect the cables of USB devices while the operating system is running.

USB 1.x has a maximum data transfer rate of 12 Mbps.

USB 2.0 has a data transfer rate of up to 480 Mbps.

USB 3.0 has a data transfer rate of up to 5 Gbps.

USB 3.1 generation 1 has a data transfer rate of up to 5 Gbps.

USB 3.1 generation 2 has a data transfer rate of up to 10 Gbps.

Additional information can be found in the documentation for the USB devices.

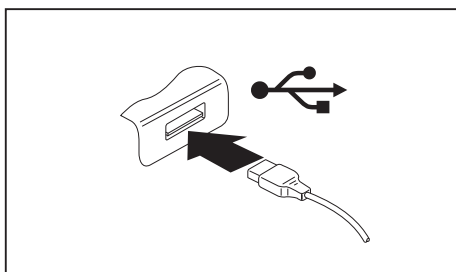

- ▶ Connect the data cable to the external device.
- ▶ Connect the data cable to a USB port of the notebook.



Device drivers

USB devices will be automatically recognized and installed by your operating system.

USB port with charging function (USB Type-C)

This USB port allows you to operate and charge the notebook using the optional dock (see ["Connect the notebook to the dock", Page 40](#)).

You can also charge a connected USB device or operate devices without an additional power supply.

This is also possible with the notebook switched off, if the *USB Type-C Power Delivery on System-Off* function is activated in the *Advanced - Miscellaneous Configurations* menu of the *BIOS Setup Utility*. Calling up and using the *BIOS Setup Utility* is described in section ["Settings in BIOS Setup Utility", Page 55](#).



USB devices are hot-pluggable. This means you can connect and disconnect the cables of USB devices while the operating system is running.

Additional information can be found in the documentation for the USB devices.

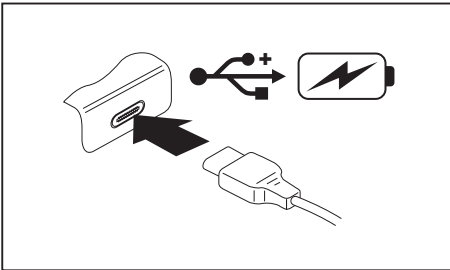

- ▶ Connect the data cable to the external device.
- ▶ Connect the data cable to a USB port (USB Type-C) on the notebook.

USB port with charging function (Anytime USB charge)

You can use this USB port to charge or supply power to a USB device (e.g. to charge a PDA or a mobile phone or to connect a USB lamp).

This is possible even when the notebook is switched off; in the *BIOS-Setup-Utility* in the *Advanced* menu the function *Anytime USB Charge* must be activated. If the setting *AC* is selected thereby, the device will only be charged when the AC adapter is connected.

Calling and using the *BIOS-Setup-Utility* is described in the section ["Settings in BIOS Setup Utility", Page 55.](#)



It is recommended that the notebook be operated with the AC adapter connected whenever the USB port with charging function is in use, as this function will drain the battery more quickly if an external USB device is being charged.

The AC adapter must already be connected when the notebook is switched off, as otherwise the USB charging function will be disabled and the connected USB devices will not be charged.



Some USB devices (e.g. mobile telephony) require a driver in order to utilize the USB charging function. In this case the USB charging function will not work when the notebook is switched off, as no drivers are active when the notebook is switched off.

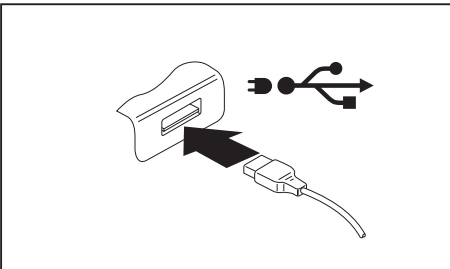

- ▶ Connect the data cable to the external device.
- ▶ Connect the data cable to a USB port (Anytime USB charge) of the notebook.

How to remove USB devices correctly



Always correctly remove the device according to the rules described below, to ensure that none of your data is lost.

- ▶ With the left mouse button, click on the symbol in the taskbar for safe removal of hardware.
- ▶ Select the device you wish to shut down and remove.
- ▶ Press the "Enter" key.
- ↳ Wait for the dialog box which tells you that it is now safe to remove the device.

Headset port

You can connect a headset, headphones or external loudspeakers to your notebook via the headset port.

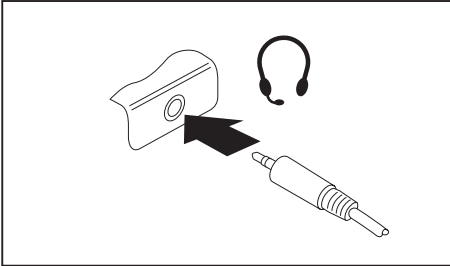

- ▶ Connect the audio cable to the external device.
- ▶ Connect the audio cable to the headset port on the notebook.
- ↳ The internal speakers are disabled.



If you buy a cable from a specialized dealer, please note the following information:

The headset port on your notebook is a "3.5 mm jack".

If you want to connect a headset, headphones or speaker, you will need a "3.5 mm jack plug".

Removing and installing components during servicing



Only qualified technicians should repair your notebook. Unauthorized opening or incorrect repair may greatly endanger the user (electric shock, fire risk) and will invalidate your warranty.

Settings in BIOS Setup Utility

The *BIOS Setup Utility* allows you to set the system functions and the hardware configuration for the notebook.

When it is delivered, the notebook is set to factory default settings. You can change these settings in *BIOS Setup Utility*. Any changes you make take effect as soon as you save and exit the *BIOS Setup Utility*.

The *BIOS Setup Utility* program contains the following menus:

<i>Info</i>	Displays information relating to the BIOS, processor and notebook
<i>System</i>	Set calendar, clock, configure SATA drive
<i>Advanced</i>	Configuration of various hardware components, such as mouse, keyboard, processor
<i>Security</i>	Password settings and security functions
<i>Boot</i>	Configuration of the start-up sequence
<i>Exit</i>	Exits the <i>BIOS Setup Utility</i>

Starting the BIOS Setup Utility

- ▶ Reboot the device (switch off/on or reboot the operating system).
- ↳ Depending on the setting for *Fast Boot* in the *BIOS-Setup-Utility*, the following notification may appear on the screen during start-up:
<F2> BIOS Setup <F12> Boot Menu
- ▶ Press the **F2** key.
- ▶ If a password has been assigned, enter the password and press the Enter key.



If you have forgotten the password, contact your system administrator or contact our customer service center.

The *BIOS Setup Utility* starts.

BIOS Setup Utility operation



Press the **F1** key to display help about operation of the *BIOS Setup Utility*. The description of the individual settings is shown in the right-hand window of the *BIOS Setup Utility*.

With the **F9** key you can load the default settings of the *BIOS Setup Utility*.

- ▶ Use the cursor keys **←** or **→** to select the menu you wish to access to make changes.
- ↳ The menu is displayed on the screen.
- ▶ Select the option you want to change with the cursor keys **↑** or **↓**.
- ▶ Press the "Enter" key.
- ▶ Press the **ESC** key to exit the selected menu.
- ▶ For future reference, make a note of the changes you have made (for example, in this manual).

Exiting BIOS Setup Utility

You need to select the desired option in the *Exit* menu and activate it by pressing the Enter key:

Exit Saving Changes - save changes and exit BIOS Setup Utility

- ▶ To save the current menu settings and exit the *BIOS Setup Utility*, select *Exit Saving Changes* and *Yes*.
- ↳ The notebook is rebooted and the new settings come into effect.

Exit Discarding Changes - Reject changes and exit BIOS Setup Utility

- ▶ To discard the changes, select *Exit Discarding Changes* and *Yes*.
- ↳ The settings in place when *BIOS Setup Utility* was called remain effective. *BIOS Setup Utility* is terminated and the notebook is rebooted.

Load Setup Defaults – load default values

- ▶ To copy the standard entries for all menus of the *BIOS Setup Utility*, choose *Load Setup Defaults* and *Yes*.

Discard Changes - Discard Changes without exiting BIOS Setup Utility

- ▶ To discard the changes you have made, select *Discard Changes* and *Yes*.
- ↳ The settings in place when *BIOS Setup Utility* was called remain effective. You can now make additional settings in the *BIOS Setup Utility*.
- ▶ If you want to exit the *BIOS Setup Utility* with these settings, select *Exit Saving Changes* and *Yes*.

Save Changes - save changes without exiting the BIOS Setup Utility

- ▶ To save the changes, select *Save Changes* and *Yes*.
- ↳ The changes are saved. You can now make additional settings in the BIOS Setup Utility.
- ▶ If you want to exit BIOS Setup Utility with these settings, choose *Exit Saving Changes* and *Yes*.

Save changes and power off

- ▶ To save the changes and switch off your device, select *Save Changes and Power Off* and *Yes*.
- ↳ The changes are saved. Your device is shut down.

Troubleshooting and tips

If a fault occurs, try to correct it as described. If you fail to correct the problem, proceed as follows:

- ▶ Make a note of the steps and the circumstances that led to the fault. Also make a note of any error messages displayed.
- ▶ Switch the notebook off.
- ▶ Please contact the Hotline/Service Desk.



You can contact Fujitsu Service and Support in the following ways:

- Toll free phone: 1-800-8Fujitsu (1-800-838-5487)
- Website: ["http://solutions.us.fujitsu.com/www/content/support/contact/index.php"](http://solutions.us.fujitsu.com/www/content/support/contact/index.php)

Before you place the call, have the following information ready so that the customer support representative can provide you with the fastest possible solution:

- The model name and serial number of the notebook. The serial number is located on a sticker on the underside of the notebook.
- Notes with the messages that appeared on the screen and information on acoustic signals.
- Any changes you have made to the hardware or software since receiving the notebook.
- Any changes you have made to the *BIOS Setup* settings after receiving the notebook.
- Your system configuration and all peripheral devices connected to your system.
- Your sales contract.



Our notebooks have been designed primarily with mobile applications in mind.

This means that considerable effort has been made to optimize components and equipment in terms of weight, space and energy requirements. Depending on the particular configuration you have purchased, it is possible that functionality may be slightly reduced compared to a desktop PC if you are running processor-intensive gaming software, e.g. games with intensive 3D graphics. Updating your hardware with drivers which have not been approved by Fujitsu may result in performance losses, data losses or malfunction of the equipment. A list of approved drivers and current BIOS versions can be downloaded from: ["http://solutions.us.fujitsu.com"](http://solutions.us.fujitsu.com)

Help if problems occur

Should you encounter a problem with your computer that you cannot resolve yourself:

- ▶ Note the ID number of your device. The ID number is found on the type rating plate on the back or underside of the casing.
- ▶ For further clarification of the problem, contact the Fujitsu Service Desk. When you do this, please have ready the ID number and serial number of your system.

Reset by switching the battery off

If the device no longer responds and does not react to the ON/OFF button, use the ON/OFF button for the battery on the underside of the device to switch off the device.

- ▶ Switch the battery off and on again (see chapter ["Switching the battery on and off", Page 33](#))

If you need to restore your system

In the event you need to restore your system, please refer to the appendix of this Operating Manual.

The notebook's date or time is incorrect

Cause	Troubleshooting
Time and date are incorrect.	▶ With the <i>BIOS-Setup-Utility</i> , you can set the date and time in the <i>Main</i> menu.
Date and time are still set incorrectly after switching on the notebook.	▶ Please contact your sales outlet or our hotline/service desk.

When certain characters are entered on the keyboard, only numerals are written

Cause	Troubleshooting
The virtual number keys of your device are activated, see "Virtual number keys", Page 28	▶ Press the <input type="checkbox"/> Num <input type="checkbox"/> button.

The notebook's LCD screen remains blank

Cause	Troubleshooting
Screen is switched off.	▶ Press a key or touch the touchpad.
External monitor or television set connected.	▶ Press the key for changing over the screen output, see "Hot keys", Page 24 .

The LCD screen of the notebook is difficult to read

Cause	Troubleshooting
Reflected glare	<ul style="list-style-type: none"> ▶ Turn the notebook or alter the tilt of the LCD screen. ▶ Increase the brightness of the screen.

The external monitor remains blank

Cause	Troubleshooting
Monitor is switched off.	▶ Switch the external monitor on.
Power saving has been activated (monitor is blank).	▶ Press any key to continue.
Brightness is set to dark.	▶ Adjust the brightness of the monitor.
Screen output is set to the notebook's LCD screen	▶ Press the key for changing over the screen output, see " Hot keys ", Page 24 .
The external monitor's AC cable or data cable is not connected properly.	<ul style="list-style-type: none"> ▶ Switch off the external monitor and the notebook. ▶ Check whether the AC cable is plugged properly into the external monitor and into the power outlet. ▶ Check whether the data cable is properly connected to the notebook and the external monitor (if it is plugged in with a connector). ▶ Switch on the external monitor and the notebook.

The external monitor is blank or the image is unstable

Cause	Troubleshooting
The wrong external monitor has been selected or the wrong screen resolution has been set for the application program.	<ul style="list-style-type: none"> ▶ Terminate the application program under Windows by pressing <code>[Alt] + [F4]</code>. If the error persists after terminating the program, use the key for switching the screen output (see "Hot keys", Page 24), in order to switch to the LCD screen of the notebook. Change the following setting: ▶ Set the screen resolution: Set the screen resolution as described in the documentation for your operating system. ▶ Select monitor: Select monitor 1 or 2 as described in the documentation for your operating system.

The notebook does not start after switching it on

Cause	Troubleshooting
The battery is dead.	<ul style="list-style-type: none"> ▶ Charge the battery. <p>or</p> <ul style="list-style-type: none"> ▶ Connect the AC adapter to the notebook.
The AC adapter is not connected properly.	<ul style="list-style-type: none"> ▶ Check whether the AC adapter is properly connected to the notebook. ▶ Switch the notebook on.

The notebook stops working

Cause	Troubleshooting
The notebook is in energy saving mode.	<ul style="list-style-type: none"> ▶ End energy saving mode.
An application program has caused the malfunction.	<ul style="list-style-type: none"> ▶ Close the application program or restart the notebook (by restarting the operating system or switching the device off and back on again).
The battery is dead.	<ul style="list-style-type: none"> ▶ Charge the battery. <p>or</p> <ul style="list-style-type: none"> ▶ Connect the AC adapter to the notebook.

The printer does not print

Cause	Troubleshooting
The printer is not switched on.	<ul style="list-style-type: none"> ▶ Make sure that the printer is switched on and ready for operation (refer to the documentation supplied with the printer).
The printer is not connected correctly.	<ul style="list-style-type: none"> ▶ Check that the data cable connecting the notebook to the printer is properly connected.
The printer driver is faulty or not correctly installed, or it is the wrong printer driver.	<ul style="list-style-type: none"> ▶ Check whether the correct printer driver is loaded (refer to the printer documentation).

The wireless connection to a network does not work

Cause	Troubleshooting
The wireless component is switched off.	<ul style="list-style-type: none"> ▶ Switch the wireless component on (see "Switching the wireless components on and off", Page 36).
The wireless component is switched on. Despite this, the wireless connection to a network does not work.	<ul style="list-style-type: none"> ▶ Check whether the wireless connection is enabled by the software. ▶ Further information on using the wireless component can be found in the help files.

Smart Card reader is not recognized

Cause	Troubleshooting
Smart Card inserted incorrectly.	<ul style="list-style-type: none"> ▶ Make sure you have inserted your Smart Card into the Smart Card reader with the chip facing upwards / downwards (device-dependent). ▶ Check whether the Smart Card you are using is supported. Your Smart Card must comply with the ISO standard 7816-1, -2, -3 and -4.

Smart Card PIN forgotten

Cause	Troubleshooting
PIN forgotten	<ul style="list-style-type: none"> ▶ If you are working in a network, contact your system administrator, who can unlock your system with a Supervisor PIN.

Smart Card lost

Cause	Troubleshooting
Smart Card lost.	<ul style="list-style-type: none"> ▶ If you are working in a network, contact your system administrator, who can boot your notebook with a Supervisor Smart Card.

Error messages on the screen

This section describes the error messages generated by the BIOS Setup. Error messages displayed by the operating system or programs are described in the documentation for these programs.



If the error message appears repeatedly despite troubleshooting measures, contact the place of purchase or our customer service center.

Error message/cause	Troubleshooting
<p><i>CMOS Battery Bad</i></p> <p>If the error message occurs repeatedly, the back-up battery in the notebook is dead.</p>	<ul style="list-style-type: none"> ▶ Contact your sales outlet or our customer service center.
<p><i>System CMOS checksum bad - Default configuration used</i></p> <p>The system configuration information is incorrect.</p>	<ul style="list-style-type: none"> ▶ Switch the notebook off. ▶ Switch the notebook on. ▶ Press the function key [F2] to access the <i>BIOS Setup</i>. ▶ In the <i>BIOS Setup</i>, select the <i>Exit</i> menu. ▶ Select the entry <i>Load Setup Defaults</i>. ▶ Select <i>OK</i> and press the Enter key.
<p><i>Extended memory failed at offset: xxxx Failing Bits: zzzz zzzz</i></p> <p>When testing the extended memory, an error has resulted at the address xxxx.</p>	<ul style="list-style-type: none"> ▶ Check whether the additional memory module has been inserted correctly.
<p><i>Failure Fixed Disk n</i></p> <p>The settings of the hard disk drive are incorrect.</p>	<ul style="list-style-type: none"> ▶ Start the <i>BIOS Setup (Primary Master submenu)</i> and select the correct settings.
<p><i>Keyboard controller error</i></p>	<ul style="list-style-type: none"> ▶ Switch off the notebook with the ON/OFF button. ▶ Wait 3 - 5 seconds and switch on the notebook again.
<p><i>Keyboard error</i></p>	<p>If you use an external keyboard:</p> <ul style="list-style-type: none"> ▶ Check the connection and reboot the notebook.
<p><i>nn Stuck key</i></p>	<ul style="list-style-type: none"> ▶ Make sure that no key is pressed.
<p><i>Operating system not found</i></p>	<ul style="list-style-type: none"> ▶ Check in the <i>BIOS Setup</i> whether your hard disk has been set correctly. ▶ Make sure that the operating system is installed on the corresponding drive.
<p><i>Press <F1> to resume, <F2> to SETUP</i></p> <p>This error message appears if an error occurs during the self-test before starting the operating system.</p>	<ul style="list-style-type: none"> ▶ Press the [F1] function key to start the operating system. ▶ Press the function key [F2] to access the <i>BIOS Setup</i>.

Error message/cause	Troubleshooting
<i>Previous boot incomplete - Default configuration used</i> Default values have been set for certain settings because of an error which occurred in the previous system boot. Check the settings in the BIOS Setup.	▶ Press the <input type="text" value="F1"/> function key when prompted to do so.
<i>Real time clock error</i>	▶ Contact your sales outlet or our customer service center.
<i>nnnnK Shadow RAM failed at offset: xxxx Failing Bits: zzzz</i>	▶ Contact your sales outlet or our customer service center.
<i>System battery is dead - Replace and run SETUP</i>	▶ Contact your sales outlet or our customer service center.
<i>System cache error - Cache disabled</i>	▶ Contact your sales outlet or our customer service center.
<i>System timer error</i>	▶ Contact your sales outlet or our customer service center.

Technical data

LIFEBOOK

Ambient conditions	
Operating temperature	41°F – 95°F / 5°C – 35°C
Dimensions	
Width x Depth x Height	12.17 ins. x 8.46 ins. x 0.67 in. (excl. rubber feet)
Weight	Device with 2 cell rechargeable battery without touch function: approximately 1.76 lbs. / 799 g Device with 4 cell rechargeable battery without touch function: approximately 2.03 lbs. / 920 g Device with 4 cell rechargeable battery with touchscreen: approximately 2.09 lbs. / 950 g
Main memory	
Slots	Maximum 16 GB LPDDR3 SO-DIMM onboard 8 GB or 16 GB modules



The data sheet for the device provides further technical data. You can download the datasheet for your device from the internet at "www.fujitsu.com/us".

Rechargeable battery

	2 cell rechargeable battery 25 Wh	4 cell rechargeable battery 50 Wh
Rated voltage	7.2 V	14.4 V
Rated capacity	3490 mAh	3490 mAh

Power adapter

Electrical data	
Primary	65 W
Rated voltage	100 V to 240 V (automatic)
Rated frequency	50 Hz to 60 Hz (automatic)
Secondary	
Rated voltage	19 V
Max. rated current	3.42 A

An additional AC adapter or AC cable can be ordered at any time.

WLAN specifications

Type of network	Intel® Dual Band Wireless-AC 9560 11a/b/g/n/11ac), Wi-Fi based*
Transfer rate	(Automatic switching) IEEE802.11 a and g: 54 Mbps max. data rate; IEEE802.11n: 300 Mbps max. data rate, IEEE802.11ac: 867 Mbps max. data rate
Active frequency	<ul style="list-style-type: none"> • 802.11n: 2.4 GHz or 5 GHz • 802.11b/g: 2400~2473 MHz • 802.11a: 4900~5850 MHz • 802.11a: 2.4 GHz / 5 GHz
Typical operating distances**	<ul style="list-style-type: none"> • 802.11a: 40 ft. (12 m) @ 54 Mbps; 300 ft. (91 m) @ 6 Mbps • 802.11ac: 40 ft. (12 m) @ 54 Mbps; 300 ft.(91 m) @ 6 Mbps • 802.11b: 100 ft. (30 m) @ 11 Mbps; 300 ft. (91 m) @ 1 Mbps • 802.11g: 100 ft. (30 m) @ 54 Mbps; 300 ft. (91 m) @ 1 Mbps • 802.11n: Estimated double the operating distance of 802.11g and 802.11a in their respective frequencies
Number of channels	<ul style="list-style-type: none"> • 802.11a: 8 independent channels • 802.11b/g: 11 channels, 3 non-overlapping channels • 802.11n: Channel bonding takes two of the non-overlapping 20MHz channels and combines it into one 40MHz channel. It is actually 12 non-overlapping channels with channel bonding and 24 without. Also it is 1 non-overlapping channel in 2.4GHz when channel bonding is used. • 802.11ac: 5 independent channels

<p>Maximum recommended number of computers to be connected over wireless LAN (during ad hoc connection)</p>	<p>10 units or less ****</p>
<p>* "Wi-Fi based" indicates that the interconnectivity test of the organization which guarantees the interconnectivity of wireless LANs (Wi-Fi Alliance) was passed.</p> <p>** The operating distances given above increase or decrease depending on factors such as the number of walls, reflecting material or interference by external RF sources.</p> <p>*** Network key encryption (WEP) occurs with the number of bits given above, after deduction of the fixed length of 24 bits the user may however also set 40 or 104 bits.</p> <p>**** Depending on the particular practical application, the number of computers which can be networked is reduced if necessary.</p>	

Manufacturer's notes

Disposal and recycling

You can find information on this subject on your notebook or on our website ("http://solutions.us.fujitsu.com/www/content/products/trade-in_program/").

Recycling your battery

Over time, the batteries that run your mobile computer will begin to hold a charge for a shorter amount of time; this is a natural occurrence for all batteries. When this occurs, you may want to replace the battery with a brand new one*. If you replace it, it is important that you dispose of the old battery properly because batteries contain materials that could cause environmental damage if disposed of improperly.

Fujitsu is very concerned with environmental protection, and has enlisted the services of the Rechargeable Battery Recycling Corporation (RBRC)**, a nonprofit public service organization dedicated to protecting our environment by recycling old batteries at no cost to you.

RBRC has drop-off points at many convenient locations throughout the United States and Canada. To find the location nearest you, go to "www.RBRC.org" or call 1-800-822-8837.

If there are no convenient RBRC locations near you, you can also go to the EIA Consumer Education Initiative website "<http://EIAE.org/>" and search for a convenient disposal location.



Remember – protecting the environment is a cooperative effort, and you should make every effort to protect it for current and future generations.

* To order a new battery for your Fujitsu mobile computer, go to the Fujitsu shopping site at "www.shopfujitsu.com" in the US or "www.fujitsu.ca/products/notebooks" in Canada.

** RBRC is an independent third party to which Fujitsu provides funding for battery recycling; RBRC is in no way affiliated with Fujitsu.

DOC (Industry CANADA) Notices

Radios and Television

This Class B digital apparatus meets all requirements of Canadian Interference-Causing Equipment Regulations.

CET appareil numérique de la class B respecte toutes les exigence du Règlement sur le matériel brouilleur du Canada.

UL Notice

IMPORTANT SAFETY INSTRUCTIONS

This unit requires an AC adapter to operate. Only use UL Listed I.T.E. adapters with an output rating of 19 VDC, with a minimum current of 3.42A (65W). The correct output rating is indicated on the AC adapter label. Refer to the illustration below for the correct AC adapter output polarity:



CAUTION:

When using your notebook equipment, basic safety precautions should always be followed to reduce the risk of fire, electric shock and injury to persons, including the following:

- Do not use this product near water for example, near a bathtub, washbowl, kitchen sink or laundry tub, in a wet basement or near a swimming pool.
- Use only the power cord and batteries indicated in this manual.
- Do not dispose of batteries in a fire. They may explode.
- Check with local codes for possible special disposal instructions.

SAVE THESE INSTRUCTIONS.

For Authorized Repair Technicians Only



CAUTION:

For continued protection against risk of fire, replace only with the same type and rating fuse.



WARNING:

Danger of explosion if Lithium (CMOS) battery is incorrectly replaced. Replace only with the same or equivalent type recommended by the manufacturer.

Dispose of used batteries according to the manufacturer's instruction.

ENERGY STAR Compliance



Your Fujitsu system is an ENERGY STAR qualified mobile PC. By choosing a computer with the latest energy-saving technology, you're helping to preserve our environment for future generations. ENERGY STAR is a joint program of the U.S. Environmental Protection Agency, U.S. Department of Energy, Natural Resources Canada, and other governments around the world helping us save money while protecting the environment through energy efficient products and practices. With energy costs and global warming top-of-mind for consumers, Fujitsu is committed to offering solutions that help consumers conserve energy and improve the quality of our environment.

Sleep mode:

You will notice that your computer is initially set so that the display turns off after 10 minutes of user inactivity, and the computer goes into Sleep mode after 20 minutes of user inactivity, when the AC adapter is connected. On battery, the display turns off after 5 minutes and the computer goes into Sleep mode after 10 minutes. When going into Sleep mode, the computer also reduces the speed of any active Ethernet network links. To "wake" the computer from Sleep mode, press the Suspend/Resume Button.

Energy saving benefits:

Fujitsu ENERGY STAR qualified mobile PCs use about half as much electricity as standard equipment – saving half in utility costs. But more than that, ENERGY STAR also makes a difference for the environment. Did you know that the average house can be responsible for twice the greenhouse gas emissions as the average car? That's because every time you flip on a light switch, run your dishwasher, or turn on your PC, you use energy, which means more greenhouse gas emissions from power plants. So the more energy we can save through energy efficiency, the more we help to reduce greenhouse gases and the risks of global warming.

To learn more about the important ENERGY STAR program, visit: ["www.energystar.gov"](http://www.energystar.gov).

To read about how Fujitsu is supporting Sustainable Management along with several other environmental activities, visit the Fujitsu Corporate Citizenship page at: ["http://www.computers.us.fujitsu.com/www/content/aboutus/environmental/environment.php"](http://www.computers.us.fujitsu.com/www/content/aboutus/environmental/environment.php).

FCC and IC Regulatory Information



Please note the following regulatory information related to the wireless LAN device.

Regulatory Notes and Statements

Wireless LAN, Health and Authorization for use

Radio frequency electromagnetic energy is emitted from Wireless LAN devices. The energy levels of these emissions, however, are far much less than the electromagnetic energy emissions from wireless devices such as mobile phones. Wireless LAN devices are safe for use by consumers because they operate within the guidelines found in radio frequency safety standards and recommendations. The use of Wireless LAN devices may be restricted in some situations or environments, such as:

- On board an airplane, or
- In an explosive environment, or
- In situations where the interference risk to other devices or services is perceived or identified as harmful.

In cases in which the policy regarding use of Wireless LAN devices in specific environments is not clear (e.g., airports, hospitals, chemical/oil/gas industrial plants, private buildings), obtain authorization to use these devices prior to operating the equipment.

Regulatory Information/Disclaimers

Installation and use of this Wireless LAN device must be in strict accordance with the instructions included in the user documentation provided with the product. Any changes or modifications made to this device that are not expressly approved by the manufacturer may void the user's authority to operate the equipment. The manufacturer is not responsible for any radio or television interference caused by unauthorized modification of this device, or the substitution or attachment of connecting cables and equipment other than those specified by the manufacturer. It is the responsibility of the user to correct any interference caused by such unauthorized modification, substitution or attachment. The manufacturer and its authorized resellers or distributors will assume no liability for any damage or violation of government regulations arising from failure to comply with these guidelines.

This device must not be co-located or operated in conjunction with any other antenna or transmitter.

For IEEE 802.11a Wireless LAN: For operation within 5.15~5.25 GHz frequency range, it is restricted to indoor environments, and the antenna of this device must be integral.

Federal Communications Commission statement and Industry Canada statement:

This device complies with Part 15 of FCC Rules and Industry Canada license exempt RSS standard(s).

Operation is subject to the following two conditions: (1) This device may not cause interference, and, (2) This device must accept any interference, including interference that may cause undesired operation of this device.

Déclaration d'Industrie Canada

Cet appareil est conforme à la Section 15 des Règles de la FC C et à la (aux) norme(s) RSS concernant les appareils exempt s de licence par Industrie Canada. Son fonctionnement est soumis aux deux condition s suivantes : (1) cet appareil ne doit pas causer d'interférence nuisible; (2) cet appareil doit accepter toutes les interférences reçues, y compris celles pouvant causer un mauvais fonctionnement de l'appareil.

FCC Interference Statement

This equipment has been tested and found to comply with the limits for a Class B digital device, pursuant to Part 15 of the FCC Rules. These limits are designed to provide reasonable protection against harmful interference in a residential installation. This equipment generates, uses, and can radiate radio frequency energy. If not installed and used in accordance with the instructions, it may cause harmful interference to radio communications. However, there is no guarantee that interference will not occur in a particular installation.

If this equipment does cause harmful interference to radio or television reception, which can be determined by turning the equipment off and on, the user is encouraged to try and correct the interference by one or more of the following measures:

1. Reorient or relocate the receiving antenna.
2. Increase the distance between the equipment and the receiver.
3. Connect the equipment to an outlet on a circuit different from the one the receiver is connected to.
4. Consult the dealer or an experienced radio/TV technician for help.

FCC Radio Frequency Exposure statement

The available scientific evidence does not show that any health problems are associated with using low power wireless devices. There is no proof, however, that these low power wireless devices are absolutely safe. Low power wireless devices emit low levels of radio frequency energy (RF) in the microwave range while being used. Whereas high levels of RF can produce health effects (by heating tissue), exposure to low-level RF that does not produce heating effects causes no known adverse health effects. Many studies of low-level RF exposure have not found any biological effects. Some studies have suggested that some biological effects might occur, but such findings have not been confirmed by additional research.

The wireless LAN radio device has been tested and found to comply with FCC radiation exposure limits set forth for an uncontrolled equipment and meets the FCC radio frequency (RF) Exposure Guidelines in Supplement C to OET65.

The exposure standard for wireless devices employs a unit of measurement known as the Specific Absorption Rate, or SAR. The SAR limit set by the FCC is 1.6 W/kg, and 1.6 W/kg by Industry Canada.

This device is compliant with SAR for general population /uncontrolled exposure limits in ANSI/IEEE C95.1-1992 and Canada RSS 102, and had been tested in accordance with the measurement methods and procedures specified in OET Bulletin 65 Supplement C, and Canada RSS 102. This device has been tested, and meets the FCC, IC RF exposure guidelines when tested with the device operating conditions.

Déclaration de la FCC/d'Industrie Canada sur l'exposition aux radiofréquences

La norme régissant l'exposition des appareils sans fil aux radiofréquences emploie une unité de mesure dénommée Taux d'absorption spécifique, ou TAS. La FCC et Industrie Canada ont défini la même limite de TAS : 1,6 W/kg. Cet appareil est conforme au TAS pour les limites d'exposition générales de la population/non contrôlées définies par les règles C95.1-1992 de l'ANSI/IEEE et RSS 102 d'Industrie Canada ; il a été testé en conformité avec les méthodes et procédures de mesure spécifiées dans le supplément C du bulletin 65 de l'OET (Office d'ingénierie et de technologie) et la règle RSS 102 d'Industrie Canada. Cet appareil a été testé selon les directives de la FCC et d'IC concernant l'exposition aux radiofréquences et s'est révélé conforme à ces dernières lorsqu'il a été testé en contact direct avec le corps.

Export restrictions

This product or software contains encryption code which may not be exported or transferred from the US or Canada without an approved US Department of Commerce export license. This device complies with Part 15 of FCC Rules., as well as ICES 003 B / NMB 003 B. Operation is subject to the following two conditions: (1) this device may not cause harmful interference, and (2) this device must accept any interference received, including interference that may cause undesirable operation. Modifications not expressly authorized by Fujitsu America, Inc. may invalidate the user's right to operate this equipment.

Restrictions concernant l'exportation

Ce produit ou logiciel contient du code de chiffrement qui ne peut être exporté ou transféré du Canada ou des États-Unis sans un permis d'exportation du département du commerce des États-Unis. Ce matériel est conforme à la Partie 15 des règlements de la FCC, ainsi qu'à la norme ICES 003 B/NMB 003 B. Son fonctionnement est soumis aux deux conditions suivantes : (1) cet appareil ne doit pas causer d'interférence nuisible; (2) cet appareil doit accepter toutes les interférences reçues, y compris celles pouvant causer un mauvais fonctionnement de l'appareil. Toute modification n'ayant pas été expressément approuvée par la société Fujitsu America Incorporated peut annuler le droit de l'utilisateur de se servir du matériel.

Canadian Notice / Avis pour le Canada

Canadian Notice

The device for the 5150 - 5250 MHz band is only for indoor usage to reduce the potential for harmful interference to co-channel mobile satellite systems.

The maximum antenna gain of 6 dBi permitted (for devices in the 5250 - 5350 MHz, 5470 - 5725 MHz and 5725 - 5825 MHz bands) to comply with the e.i.r.p. limit as stated in RSS-247.

In addition, users are cautioned to take note that high power radars are allocated as primary users (meaning they have priority) of 5250 - 5350 MHz and 5650 - 5850 MHz and these radars could cause interference and/or damage to LE-LAN devices.

Avis pour le Canada

Le matériel destiné à un usage sur la bande 5 150 - 5 250 MHz doit être utilisé uniquement à l'intérieur afin de réduire les risques de brouillage nuisible causé aux systèmes mobiles par satellite fonctionnant sur un même canal.

Un gain d'antenne de 6 dBi est autorisé (pour le matériel utilisant les bandes 5 250 - 5 350 MHz, 5 470 - 5 725 MHz et 5 725 - 5 825 MHz), conformément à la limite p.i.r.e. maximale permise afférent aux périphériques RSS-247.

En outre, les utilisateurs doivent prendre garde au fait que les radars de grande puissance sont considérés comme des utilisateurs principaux (ce qui signifie qu'ils sont prioritaires) des bandes 5 250 - 5 350 MHz et 5 650 - 5 850 MHz et qu'ils pourraient causer des interférences et/ou des dommages aux appareils de réseau exempts de licence.



AVERTISSEMENT – Le notebook Fujitsu communiquera par radiofréquences (RF) lorsqu'elle est utilisée en mode station d'accueil dans le socle. L'appareil émet de l'énergie radiofréquence d'une intensité inférieure aux limites d'exposition humaine aux radiofréquences établies par la FCC aux États-Unis et par ISDE au Canada. Toutefois, en mode station d'accueil, le notebook ne doit pas toucher le corps. Les contacts avec le corps pendant le fonctionnement normal de l'appareil doivent être minimisés et une distance de plus de 20 cm doit être maintenue entre le corps et le notebook. L'utilisation d'autres accessoires peut conduire à un usage non conforme aux limites d'exposition aux radiofréquences de la FCC. Des détails au sujet des configurations autorisées sont fournis sur le site Web de la FCC. Entrez alors le numéro d'identification FCC qui apparaît sur cet appareil.

Appendix

Before Using the Optional Wireless LAN

This manual describes the procedures required to properly set up and configure the optional integrated Wireless LAN Mini-PCI device (referred to as "WLAN device" in the rest of the manual). Before using the WLAN device, read this manual carefully to ensure its correct operation. Keep this manual in a safe place for future reference.

Wireless LAN Devices Covered by this Document

This document is applicable to systems containing the following device:

- Intel Dual Band Wireless AC 9560 + BT v5.0

Characteristics of the WLAN Device

This device is compliant with SAR for general population /uncontrolled exposure limits. This device has been tested, and meets the FCC, IC RF exposure guidelines when tested with the device operating conditions.

Wireless LAN Modes Using this Device

Ad Hoc Mode

"Ad Hoc Mode" refers to a wireless network architecture where wireless network connectivity between multiple computers is established without a central wireless network device, typically known as Access Point(s). Connectivity is accomplished using only client devices in a peer-to-peer fashion. That is why Ad Hoc networks are also known as peer-to-peer networks. Ad Hoc networks are an easy and inexpensive method for establishing network connectivity between multiple computers. Ad Hoc mode requires that the SSID, network authentication, and encryption key settings are identically configured on all computers in the Ad Hoc network.

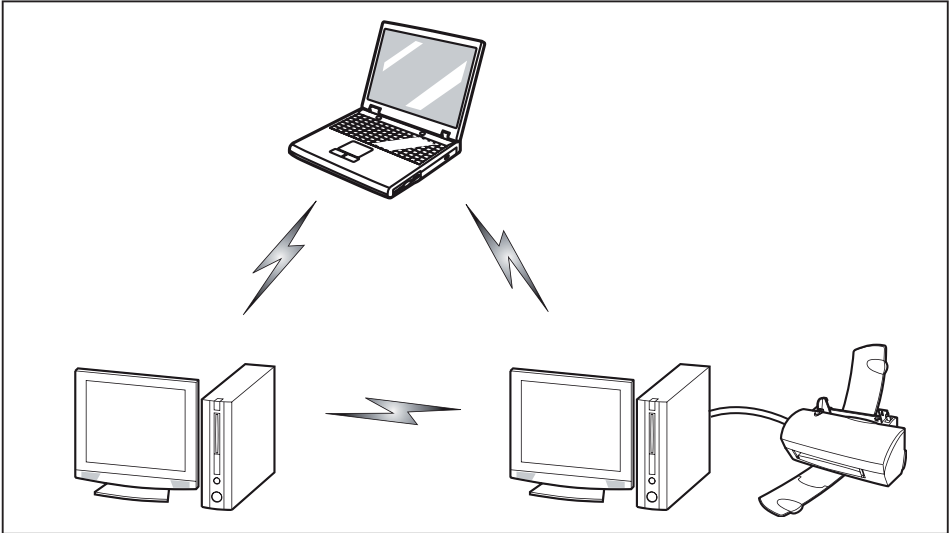

Access Point (Infrastructure) Mode

Infrastructure mode refers to a wireless network architecture in which devices communicate with wireless or wired network devices by communicating through an Access Point. In infrastructure mode, wireless devices can communicate with each other or with a wired network. Corporate wireless networks operate in infrastructure mode because they require access to the WLAN in order to access services, devices, and computers (e.g., file servers, printers, databases).

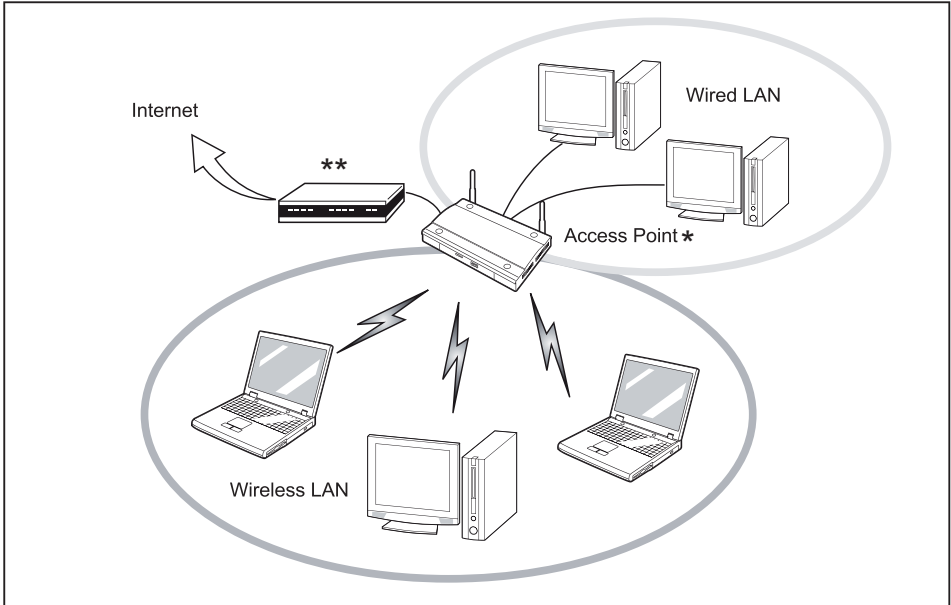

* = An optional hub for a wired LAN may be required depending upon the type of access point used.

** = ADSL modem, cable modem, or similar

How to Handle This Device

The WLAN device is an optional device that may come pre-installed in your mobile computer. Under normal circumstances, it should not be necessary for you to remove or re-install it. The Operating System that your mobile computer comes with has been pre-configured to support the WLAN device.

- The WLAN device operates in the 2.4 GHz ISM band and the 5 GHz lower, middle, and upper UNII bands.
- Microwave ovens may interfere with the operation of WLAN devices since they operate in the same 2.4 GHz frequency range as IEEE802.11b/g/n devices. Interference by microwaves does not occur with IEEE802.11a radio which operates in the 5 GHz RF band.
- Wireless devices that transmit in the 2.4 GHz range may interfere with operation of WLAN devices in IEEE802.11b/g/n modes. Symptoms of interference include reduced throughput, intermittent disconnects, and many frame errors. It is HIGHLY recommended that these interfering devices be powered off to ensure proper operation of the WLAN device.

Deactivating/Disconnecting the WLAN Device

Disconnecting the WLAN device may be desired in certain circumstances (to extend battery life) or where certain environments require it (i.e. hospitals, clinics, airplanes, etc.). The WLAN device can be disconnected in Windows using the WLAN icon in the system tray (Note that disconnecting via the icon in the system tray does not turn off the radio; it continues to transmit and receive even though it's not connected.)

- ▶ Press the key with the wireless icon (key F5) to start the *WirelessSelector*.
- ↳ The wireless component indicator will go off when the wireless components are switched off.

Configuring the Wireless LAN

The optional WLAN device can be configured to establish wireless network connectivity using the software that is built into Windows. Support for most industry standard security solutions is contained in this software.

Pre-defined parameters will be required for this procedure. Please consult with your network administrator for these parameters:

Configuring the WLAN Using Windows

The WLAN device can be configured to establish a wireless network connection using the software integrated in Windows. The software supports the current industry-standard security solutions.

Pre-defined parameters are required for this procedure. Consult your network administrator for these parameters.

Connection to the network

After you have configured your computer, you can connect to an active network by performing the following steps:

1. Click on the *WLAN* icon in the system tray.
2. Select *Connect to a network*.
3. Select a network from the list that appears, and click the *Connect* button.

Troubleshooting the WLAN

Causes and countermeasures for troubles you may encounter while using your wireless LAN are described in the following table.

Problem	Possible Cause	Possible Solution
Unavailable network connection	Incorrect network name (SSID) or network key	<p>Ad hoc connection: verify that the network names (SSID's) and network keys (WEP) of all computers to be connected have been configured correctly. SSID's and WEP key values must be identical on each machine.</p> <p>Access Point (Infrastructure) connection: set the network name (SSID) and network key to the same values as those of the access point.</p> <p>Set the Network Authentication value identically to that of the Access Point. Please consult your network administrator for this value, if necessary.</p>
	Weak received signal strength and/or link quality	<p>Ad hoc connection: Retry connection after shortening the distance to the destination computer or removing any obstacles for better sight.</p> <p>Access Point (Infrastructure) connection: Retry connection after shortening the distance to the access point or removing any obstacles for better sight.</p>

Problem	Possible Cause	Possible Solution
Unavailable network connection (continued)	The WLAN device was deactivated or is disabled	Check if the wireless switch is turned On. Go to <i>Start > Control Panel</i> , and doubleclick on <i>Windows Mobility Center</i> . If the wireless network is off, click the <i>Turn wireless on</i> button.
	The computer to be connected is turned off	Check if the computer to be connected is turned ON.
	Incorrectly configured network settings	Recheck the configuration of your network settings.
	RF interference from Access Points or other wireless networks	The use of identical or overlapping RF channels can cause interference with the operation of the WLAN device. Change the channel of your Access Point to a channel that does not overlap with the interfering device.
	Wireless network authentication has failed	Re-check your Network Authentication, Encryption, and Security settings. Incorrectly configured security settings such as an incorrectly typed WEP key, a mis-configured LEAP username, or an incorrectly chosen authentication method will cause the LAN device to associate but not authenticate to the wireless network.
	Incorrect IP address configuration	This only applies to networks using static IP addresses. Please contact your network administrator for the correct settings.

Using the Bluetooth Device

Bluetooth is integrated into the Wireless LAN module. The Bluetooth capabilities are Bluetooth Basic, EDR and Bluetooth Low Energy (BT v5.0) operational modes.

What is Bluetooth?

Bluetooth technology is designed as a short-range wireless link between mobile devices, such as laptop computers, phones, printers, and cameras. Bluetooth technology is used to create Personal Area Networks (PANs) between devices in short-range of each other.



Proceed as follows to individually enable or disable Bluetooth devices:

1. In the Start menu search field, search for "Bluetooth."
2. Select the Bluetooth settings option (dependent on the operating system).
3. In the Bluetooth settings window, make the desired settings.

Where to Find Information About Bluetooth

For additional information about Bluetooth Technology, visit the Bluetooth Web site at: ["www.bluetooth.com"](http://www.bluetooth.com).

FCC Radiation Exposure Statement

This system complies with the FCC limit values for radio frequency radiation in an uncontrolled environment. The Bluetooth antenna is located at the top edge of the LCD screen and is exempt from the criteria for minimum distance because of its low power consumption.

The transmitter used in this system must not be operated together with other antennas or transmitters.

Canadian Notice

To prevent radio interference to licensed services, this system is designed for use in indoor spaces / in buildings and not directly at window openings, to allow a maximum shielding.

Warranty

Users are not authorized to modify this product. Any modifications invalidate the warranty.

This equipment may not be modified, altered, or changed in any way without signed written permission from Fujitsu. Unauthorized modification will void the equipment authorization from the FCC and Industry Canada and the warranty.

Image Backup and Recovery Procedures

Windows 10 Procedures

It is very important that you create your Recovery Drive before beginning to use your system.

It is also important that you create a backup of the content of *C:\Drivers* on your system to writable media or an external drive. System-specific software drivers are also available for download through the Fujitsu support site.

Note: Most of the information below comes from the Microsoft® page ["http://windows.microsoft.com/en-us/windows-10/windows-10-recovery-options"](http://windows.microsoft.com/en-us/windows-10/windows-10-recovery-options). Please refer to it for more details.

Creating a recovery drive

A recovery drive can help you troubleshoot and fix problems with your PC, even if it won't start. To create one, all you need is a USB flash drive. Windows will inform you of the size of the USB flash drive needed to hold the required data.

1. From the taskbar, search for *Create a recovery drive* and then select it. You may be asked to enter an administrator password or confirm your selection.
2. When the tool opens, make sure *Backup system files to the recovery drive* is selected and then select *Next*.
3. Connect a USB drive to your PC, select it, and then select *Next - Create*. A large number of files need to be copied to the recovery drive, so this could take some time.
4. When it's done, select *Finish*.

Note:

If you chose not to back up the system files when you created your recovery drive on Windows 10, you won't be able to use it to reinstall Windows.

Recovery options in Windows 10

If your PC isn't running as quickly or reliably as it used to, try one of these recovery options. The following table can help you decide which one to use.

Problem	Try this
Your PC isn't working well and you recently installed an app, driver, or update.	Restore from a system restore point
Your PC isn't working well and it's been a while since you installed anything new.	Reset your PC
Your PC won't start and you've created a recovery drive.	Use a recovery drive to reinstall Windows
Your PC won't start and you haven't created a recovery drive.	Use installation media to reinstall Windows

Restore from a system restore point

This option takes your PC back to an earlier point in time, called a system restore point. Restore points are generated when you install a new app, driver, or Windows update, and when you create a restore point manually. Restoring won't affect your personal files, but it will remove apps, drivers, and updates installed after the restore point was made.

1. Right-click on the start key and select *File Explorer*.
2. Press the keys **[Alt]** and **[Up arrow]**.
3. Select *Control Panel*.
4. Search *Control Panel* for *Recovery*.
5. Select *Recovery - Open System Restore - Next*.
6. Choose the restore point related to the problematic app, driver, or update, and then select *Next - Finish*.

Note: If you don't see any restore points, it could be because the system protection isn't turned on. To check, go to the *Control Panel*, search for *Recovery*, and then select *Recovery - Configure System Restore - Configure* and make sure that *Turn On System Protection* is selected.

Reset your PC

Resetting lets you choose whether to keep your files or remove them, and then reinstalls Windows.

1. Select *Settings - Update & security - Reset this PC - Get started*
2. Choose an option:

Option	What it does
Keep my files	This reinstalls Windows 10, but keeps your personal files and any apps that came with your PC. It removes: <ul style="list-style-type: none"> • Changes you made to settings • Apps and drivers you installed
Remove everything	This reinstalls Windows 10 and any apps that came with your PC. It removes: <ul style="list-style-type: none"> • Personal files • Changes you made to settings • Apps and drivers you installed <p>If you're planning to donate, recycle, or sell your PC, use this option and choose to fully clean the drive. This might take an hour or two, but it makes it harder for other people to recover files you've removed.</p>

Use a recovery drive to reinstall Windows

Note: This process utilizes the USB Recovery Drive that you created in the previous section "Create a Recovery Drive".

1. Connect the recovery drive and turn on your PC.
2. On the *Choose an option* screen, select *Troubleshoot - Reset this PC*, and then choose the reset option that's best for you.

If that doesn't fix the problem, try *Troubleshoot - Recover* from a drive. This will remove your personal files, apps and drivers you installed, and changes you made to settings. If you repartitioned the drive Windows is installed on, note that this will restore the drive's default partitions.

Use installation media to reinstall Windows

If you have installation media, like a Recovery DVD that you purchased from Fujitsu, you can use it to reinstall Windows. You will need to install additional drivers and applications after reinstalling Windows.

To reinstall Windows, follow the steps below:

1. Power on your system. When the Fujitsu logo appears on the screen, press the **F12** key.
2. Insert the bootable disc in your DVD drive.
3. Highlight the CD/DVD option from the Boot Menu and press **Enter**.

4. Follow the on-screen instructions to restore the image.
 - Select the language.
 - At the Windows Setup dialog window, enter your OS, language and other preferences and click *Next* to continue.
 - Click *Install now* to proceed with reinstalling Windows.
 - At License terms, check on *I accept the license terms* and click *Next*.
 - At *Which type of installation do you want*, click on *Custom: Install Windows only (advanced)*.
 - Delete all partitions on the drive and click *Next*. Installation of Windows will start. This will take some time so please wait until the installation is finished and the system restarts.
5. When the system restarts, perform all set-up steps to arrive at the Desktop.
6. Connect to the Internet.
7. Use the *Backup of the contents of the C:\Drivers* folder to install needed drivers and applications to your system. If it is not available, download the software from the Fujitsu Support Site, as described below in the "Auto Installation support for the software downloaded from support website" section below.

Auto Installation support for the software downloaded from support website

1. Download FSDM (Fujitsu Software Download Manager) from the support site and download all the drivers applicable to the model and OS using FSDM if they are not downloaded yet.
2. When the software packages are downloaded from the web, it is important to download the Auto Installer Software package and the model/language-specific Readme file if you prefer to auto install the software.
3. It is important to have the extracted Auto Installer software package folder and Readme file in the same location as the other software folders. Otherwise auto-installation of the software will not be supported.
4. Inside the Auto Installer software package, launch *FjAutoinstall.exe* as administrator.
5. Click *Yes* on the *User Account Control* dialog box. This will take some time to process the software packages. A message will be displayed during this time stating *Please wait while the content is being processed*.
6. If the EULA is displayed for Fujitsu Software Auto Installer, accept the EULA, otherwise continue.
7. The Fujitsu Software Auto Installer user interface will be launched providing the ability to auto install the software downloaded from the support site.
8. It is recommended that you install all the software in the listed order. You can *Select All*, to install the software in the order listed.
9. Click the *Install* button to start the installation.
10. After installing all the selected drivers, the Installation Results window is displayed. Click *OK*.
11. *You must restart the system for the settings to take effect. Do you wish to reboot now?* message appears. Select *Yes*.
12. The system will now reboot.

Downloading driver updates

To ensure that you always have the most current driver updates related to your system, you should occasionally access the Fujitsu Software Download Manager (FSDM) utility. The FSDM utility is available from the Fujitsu Support site. FSDM will allow you to view and download the most current drivers, utilities and applications to determine whether you have the latest versions. To download the FSDM utility, go to the support site: ["http://support.fujitsupc.com/CS/Portal/support.do?srch=DOWNLOADS"](http://support.fujitsupc.com/CS/Portal/support.do?srch=DOWNLOADS).

Index

- A**
- AC adapter
 - connecting 17
 - Set up 17
- Alt+Tab 27
- Anti-theft protection 43
- Audio connections 53

- B**
- Back tab 27
- Backspace 22
- Backspace key 22
- Battery 32
 - battery charge 34
 - Caring for and maintaining 32
 - charge level 32
 - Charging 32
 - see Rechargeable battery 32
 - Service life 32
- battery charge meter 32
- Battery indicator 20
- Battery status indicator
 - see battery indicator 20
- Battery symbol
 - see battery indicator 20
- BIOS Setup Utility
 - , protecting with password 44
 - calling 55
 - exiting 57
 - operation 56
 - Settings 55
- Blank LCD screen 59
- Bluetooth
 - Switch off module 36
 - Switch on module 36
 - switching module off 78
 - switching module on 78
- Bluetooth, Safety notes 13
- Bonus Apps 18

- C**
- Caps Lock
 - indicator 21
- Caps Lock key 23
- Choose a location 17
- Cleaning 15
- Cleaning the touchpad 15
- Components
 - Installing/Removing 54
- Configuration, BIOS Setup Utility 55

- Configuring hardware 55
- Configuring system 55
- Connecting audio devices 53
- Connecting headphones 53
- Connections
 - Dock 38
- Crystal View screen
 - cleaning 15
- Ctrl+Alt+Del 27
- Cursor control 23
- Cursor keys 23

- D**
- Date not correct 59
- Decrease
 - screen brightness 25
 - volume 25
- Decrease brightness
 - of LCD screen 25
- DOC (INDUSTRY CANADA) NOTICES 68
- Dock
 - connections 38
- Drive
 - indicator 20

- E**
- Ending
 - energy saving mode 61
- Energy
 - Energy consumption 34
 - Energy saving 13
 - Energy saving functions 34
- Energy saving functions 25
- Enter 22
- Enter key 22
- Error messages on the screen 63
- Errors
 - Screen messages 63
- Ethernet LAN 37

- F**
- F Lock
 - indicator 20
- Fault
 - Elimination 58
- Fingerprint sensor 42
 - configuring 42
- First-time setup 16
- Fn key 23

Fn+F10 25
 Fn+Scroll Lock 27

G
 Getting started 16

H
 HDMI port 48
 Hot keys 24

I
 Important notes 12
 In case of service 54
 Incorrect time 59
 Increase
 screen brightness 25
 Indicator
 Caps Lock 21
 drive 20
 F Lock 20
 Num Lock 20
 Scroll Lock 21
 Information,
 safety 12
 Instructions
 Cleaning 15

K
 Kensington Lock Cable 43
 Key combinations 27
 Keyboard 22
 cleaning 15
 Keys 22

L
 LCD screen
 cleaning 15
 difficult to read 59
 Notes 30
 reflected glare 59
 Remains blank 59
 Line feed 22

M
 Making ready to use 17
 Mechanical security 43
 Memory card
 handling 35
 inserting 35
 removing 35

Microphone 36
 Mobile operation 13
 Monitor
 connecting 49
 no image 60
 remains blank 60
 unstable image 60
 Monitor port
 see VGA socket 49

N
 Notebook
 before traveling 14
 cleaning 15
 does not start 61
 not working 61
 operating 19
 switching off 21
 transporting 13
 Notes 12
 disposal / recycling 68
 Energy saving 13
 LCD screen 30
 Transport 13
 Num Lock
 indicator 20
 Num lock display 28
 Numeric keypad 22
 see "virtual number keys" 28

O
 Operating system
 activating system protection 45
 cancel system protection 45
 Protecting with password 45
 Operation, notebook 19

P
 Packaging 16
 Palm vein sensor 43
 set-up 43
 Password
 changing 45
 entering 44
 removing 45
 Password protection 44
 Power saving 13
 Power-on indicator 20
 Printer does not print 61
 Problem solving 58

R

- Rechargeable battery
 - see battery 32
- Return 22

S

- Safety information 12
- Scroll Lock
 - indicator 21
- Security functions 42
 - Smart Card 47
 - SystemLock 47
- Service life, battery 32
- Set up
 - Device 17
- Setup
 - see BIOS Setup Utility 55
- Shift 23
- Shift key 23
- Shift+Tab 27
- Slot
 - Memory cards 35
- Speaker 36
- Standby indicator 20
- Status indicators 19
- Subwoofer 36
- Supervisor password
 - change 45
 - entering 44
 - removing 45
- Switch
 - microphone off 24
 - microphone on 24
- Switch between display outputs 25
- Switching
 - speakers off 24
 - speakers on 24
 - wireless components off 25
 - wireless components on 25
- Switching on
 - the notebook 21
- Switching on for the first time 18
- System settings, BIOS Setup Utility 55

T

- Tab key 22
- Technical data 65
 - AC adapter 66
 - notebook 65
- The wireless connection to a network
 - does not work 62

- Time not correct 59
- Tips 58
- Touchpad 25, 29
 - buttons 29
 - dragging items 30
 - executing commands 29
 - moving the pointer 29
 - selecting an item 29
 - switch off 25
- Touchpad keys 25
- TPM 46
- Transport 13
 - Damage during transportation 16
- Traveling, notebook 14
- Troubleshooting 58
- Trusted Platform Module 46

U

- USB charging function 52
- USB port with charging function (USB Type-C) 51
- USB ports 50
- User password
 - change 45
 - entering 44
 - removing 45
- Using the security lock 43

V

- VGA socket 49
- Virtual Number Keys 28
- Volume
 - increase 25
- Volume control 36

W

- Webcam 32
- Windows key 23
- Wireless components
 - Safety notes 13
- Wireless LAN
 - Safety notes 13
 - Switch off module 36
 - Switch on module 36
 - switching module off 78
 - switching module on 78
- Wrong date/time 59