

User's Guide

Learn how to use your
Fujitsu STYLISTIC[®]
Q572 Tablet PC

STYLISTIC

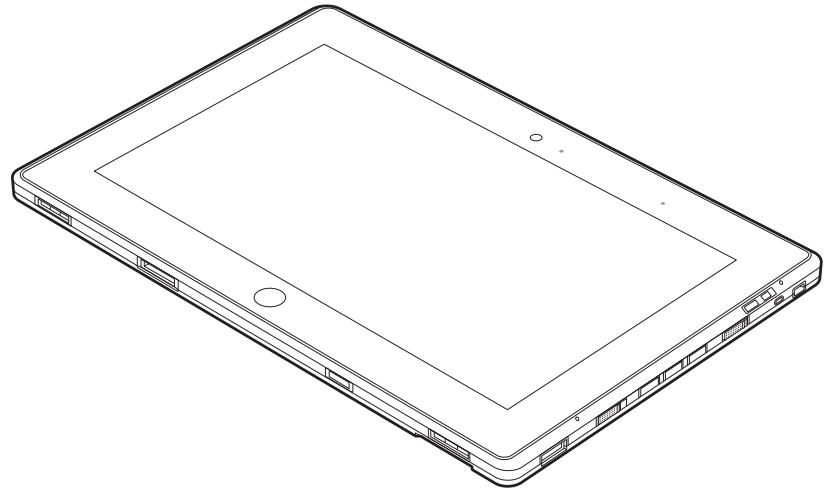

FUJITSU



Copyright and Trademark Information

Fujitsu America, Inc. has made every effort to ensure the accuracy and completeness of this document. Because ongoing development efforts are made to continually improve the capabilities of our products, however, the data contained herein represents Fujitsu design objectives and is provided for comparative purposes; actual results may vary based on a variety of factors. This product data does not constitute a warranty. Specifications are subject to change without knowledge.

Fujitsu and the Fujitsu logo are registered trademarks of Fujitsu Limited; STYLISTIC is a registered trademark of Fujitsu America, Incorporated.

Microsoft and Windows are registered trademarks or trademarks of Microsoft Corporation in the United States and/or other countries.

The SD Logo is registered with the U.S. Patent and Trademark Office and with other trademark offices around the world by SD-3C, LLC.

AMD and Radeon are trademarks or registered trademarks of Advanced Micro Devices, Inc.

OmniPass is a trademark of Softex, Inc.

Skype is a trademark of Skype Limited.

Broadcom is a registered trademark of Broadcom Corporation. smartcard

Norton Internet Security is a trademark of Symantec Corporation in the United States and other countries.

AirPrime is a trademark of Sierra Wireless Inc.

Gobi3000 is a trademark of Qualcomm Inc.

Adobe and Adobe Reader are registered trademarks or trademarks of Adobe Systems Incorporated in the United States and/or other countries.

Ralink is a registered trademark of Ralink Technology Corporation.

Bluetooth and the Bluetooth logo are registered trademarks of Bluetooth SIG, Inc.

Realtek is a trademark of Realtek Semiconductor Corp.

Wi-Fi is a trademark of the Wireless Ethernet Compatibility Alliance (WECA).

All other products are trademarks or registered trademarks of their respective companies. All other trademarks mentioned herein are the property of their respective owners.

Copyright 2012 Fujitsu America, Incorporated. All rights reserved. No part of this publication may be copied, reproduced, or translated, without the prior written consent of Fujitsu America, Incorporated. No part of this publication may be stored or transmitted in any electronic form without the prior consent of Fujitsu America, Incorporated.

B5FK-0131-01ENZO-00

USER GUIDE FOR WIRELESS BROADBAND CONNECTION



IF YOU HAVE THE OPTIONAL WIRELESS WAN (WWAN) DEVICE INSTALLED IN YOUR TABLET PC, THE WWAN USER'S GUIDE IS LOCATED AT:

http://solutions.us.fujitsu.com/www/content/support/mobile/support_notices

PLEASE CLICK "3G MINI-CARD GOBI3000 REGULATORY AND SAFETY INFORMATION" TO OPEN THE FULL USER GUIDE CONTAINING WARNINGS AND PRECAUTIONS ASSOCIATED WITH RF SAFETY WHEN USING THE WWAN DEVICE.



DECLARATION OF CONFORMITY

according to FCC Part 15

Responsible Party Name: Fujitsu America, Inc.
Address: 1250 E. Arques Avenue
Sunnyvale, CA 94085
Telephone: (408) 746-6000
Declares that product: Base Model Configuration: STYLISTIC Q572 Tablet PC

Complies with Part 15 of the FCC Rules.

This device complies with Part 15 of the FCC rules. Operations are subject to the following two conditions:
(1) This device may not cause harmful interference, (2) This device must accept any interference received, including interference that may cause undesired operation.

IMPORTANT SAFETY INSTRUCTIONS

This unit requires an AC adapter to operate. Use only UL Listed I.T.E. Class II Adapters with an output rating of 19 VDC, with a current of 3.16A (60 W).

AC adapter output polarity:



When using your tablet PC, basic safety precautions should always be followed to reduce the risk of fire, electric shock and injury to persons, including the following:



- **CAUTION: HOT SURFACE:** THE BOTTOM OF THIS COMPUTER CAN BECOME HOT WHEN USED FOR LONG PERIODS OF TIME. WHEN USING THIS DEVICE, TAKE CAUTION TO LIMIT LONG TERM OR CONTINUOUS USE WHILE RESTING IT ON EXPOSED SKIN, SUCH AS THE LAP.
- **CAUTION: RISK OF EXPLOSION IF BATTERY IS REPLACED BY AN INCORRECT TYPE.** DISPOSE OF USED BATTERIES ACCORDING TO THE INSTRUCTIONS CONTAINED HEREIN.
- Do not use this product near water for example, near a bathtub, washbowl, kitchen sink or laundry tub, in a wet basement or near a swimming pool.
- Use only the power cord and batteries indicated in this manual. Do not dispose of batteries in a fire. They may explode. Check with local codes for possible special disposal instructions.

SAVE THESE INSTRUCTIONS

For Authorized Repair Technicians Only



DANGER OF EXPLOSION IF LITHIUM (CLOCK) BATTERY IS INCORRECTLY REPLACED. REPLACE ONLY WITH THE SAME OR EQUIVALENT TYPE RECOMMENDED BY THE MANUFACTURER. DISPOSE OF USED BATTERIES ACCORDING TO THE MANUFACTURER'S INSTRUCTION.



FOR CONTINUED PROTECTION AGAINST RISK OF FIRE, REPLACE ONLY WITH THE SAME TYPE AND RATING FUSE.

Recycling your battery

Over time, the batteries that run your mobile computer will begin to hold a charge for a shorter amount of time; this is a natural occurrence for all batteries. When this occurs, you may want to replace the battery with a fresh one*. If you replace it, it is important that you dispose of the old battery properly because batteries contain materials that could cause environmental damage if disposed of improperly.



Fujitsu is very concerned with environmental protection, and has enlisted the services of the Rechargeable Battery Recycling Corporation (RBRC)**, a non-profit public service organization dedicated to protecting our environment by recycling old batteries at no cost to you.

RBRC has drop-off points at tens of thousands of locations throughout the United States and Canada. To find the location nearest you, go to www.RBRC.org or call 1-800-822-8837.

If there are no convenient RBRC locations near you, you can also go to the EIA Consumer Education Initiative website (<http://EIAE.org/>) and search for a convenient disposal location.

Remember – protecting the environment is a cooperative effort, and you should make every effort to protect it for current and future generations.

- * To order a new battery for your Fujitsu mobile computer, go to the Fujitsu shopping site at www.shopfujitsu.com in the US or www.fujitsu.ca/products/notebooks in Canada.
- ** RBRC is an independent third party to which Fujitsu provides funding for battery recycling; RBRC is in no way affiliated with Fujitsu.



Contents

About This Guide	11
Conventions Used in the Guide	11
Fujitsu Contact Information	12
Chapter 1 Getting to Know Your Tablet PC	
Overview	14
Locating the Connectors and Controls	15
Front Features	15
Back Features	17
Left Side Features	19
Right Side	20
Status Indicator Panel	22
Display Panel	24
Active Digitizer/Touchscreen	26
Active Digitizer Display	26
Using the Capacitive Touchscreen	30
Accessing the OnScreen TouchPad	31
Caring for the Pen	32
Changing the Pen Battery	33
Replacing the Pen Tip	33

Tablet PC Buttons	35
--------------------------------	-----------

Chapter 2 Getting Started with Your Tablet PC

Power Sources	37
----------------------------	-----------

Connecting the Power Adapters	37
-------------------------------------	----

Starting Your STYLISTIC Tablet PC	39
--	-----------

Power On	39
----------------	----

Boot Sequence	40
---------------------	----

Hard Disk Drive Passwords	40
---------------------------------	----

BIOS Setup Utility	41
--------------------------	----

Booting the System	42
--------------------------	----

Starting Windows the First Time	42
---------------------------------------	----

Power Management	44
-------------------------------	-----------

Power/Suspend/Resume Switch	44
-----------------------------------	----

Sleep Mode	44
------------------	----

Hibernation (Save-to-Disk) Feature	45
--	----

Windows Power Management	45
--------------------------------	----

Restarting the System	46
-----------------------------	----

Powering Off	46
--------------------	----

Chapter 3 User-Installable Features

Lithium Polymer Battery	47
--------------------------------------	-----------

Recharging the Batteries	48
--------------------------------	----

Replacing the Battery	49
-----------------------------	----

Secure Digital Cards	52
-----------------------------------	-----------

Installing SD Cards	52
---------------------------	----

Removing an SD Card	53
---------------------------	----

Chapter 4 Troubleshooting Your Tablet PC

Troubleshooting	54
Identifying the Problem	54
Specific Problems	56
Power On Self Test Messages	62
Restoring Your System Image and Software	63
Saving and Recovering Your Factory and System Images	63
Backing Up a System Image	65
Recovery and Utility tools	69
Recovering your Factory Image using Recovery and Utility	71
Downloading Driver Updates	72

Chapter 5 Care and Maintenance

Caring for your Tablet PC	73
Cleaning your Tablet PC	74
Storing your Tablet PC	76
Traveling with your Tablet PC	76
Batteries	77
Media Care	78
Secure Digital Cards	79

Chapter 6 System Specifications

Specifications	80
Microprocessor	80
Chipset	80
Memory	80
Video	81
Audio	81
Mass Storage Device Options	81
Communications	82
Security Features	82

Device Ports.....	82
Power.....	83
Dimensions and Weight.....	83
Environmental Requirements.....	83
Popular Accessories.....	84
Included Software.....	84
Learning About Your Software.....	84
Regulatory Information	86

Appendix A: WLAN User's Guide

Before Using the Optional Wireless LAN.....	91
Wireless LAN Device Covered by this Document.....	91
Characteristics of the WLAN Device.....	91
Wireless LAN Modes Using this Device.....	92
Deactivating/Disconnecting the WLAN Device.....	94
Deactivation Using the Wireless On/Off Switch.....	95
Disconnection Using the Icon in the Taskbar.....	95
Activating the WLAN Device.....	95
Configuration of the WLAN Device.....	96
Configuring the WLAN Using Windows.....	96
Connection to the network.....	96
Troubleshooting the WLAN.....	97
Troubleshooting.....	97
WLAN Specifications	99
Specifications.....	99
Using the Bluetooth Device	100
What is Bluetooth.....	100
Where to Find Information About Bluetooth.....	100

Appendix B: Fingerprint Sensor Device

Introducing the Fingerprint Sensor Device	102
Getting Started	103
Installing OmniPass	103
User Enrollment	106
Using OmniPass	108
Configuring OmniPass	113
OmniPass Control Center	115
Troubleshooting	117
Index	119



Preface

About This Guide

The STYLISTIC® Q572 Tablet PC is a high-performance pen-based computer that has been designed to support Microsoft® Windows® 7 and Windows 8 Professional editions.

This manual explains how to operate your Tablet PC hardware and built-in system software.

The STYLISTIC Q572 Tablet PC is a completely self-contained unit with a 10.1" WXGA LED backlit IPS display with 160 degree vertical and horizontal viewing angles. It has a powerful interface that enables it to support a variety of optional features.

Conventions Used in the Guide

Pages with additional information about a specific topic are cross-referenced within the text.

On screen buttons or menu items appear in bold. Example: Click **OK** to restart your Tablet PC.



THE INFORMATION ICON HIGHLIGHTS INFORMATION THAT WILL ENHANCE YOUR UNDERSTANDING OF THE SUBJECT MATERIAL.



THE CAUTION ICON HIGHLIGHTS INFORMATION THAT IS IMPORTANT TO THE SAFE OPERATION OF YOUR COMPUTER, OR TO THE INTEGRITY OF YOUR FILES. PLEASE READ ALL CAUTION INFORMATION CAREFULLY.



THE WARNING ICON HIGHLIGHTS INFORMATION THAT CAN BE HAZARDOUS TO EITHER YOU, YOUR TABLET PC, OR YOUR FILES. PLEASE READ ALL WARNING INFORMATION CAREFULLY.

Fujitsu Contact Information

Service and Support

You can contact Fujitsu Service and Support in the following ways:

- Toll free: 1-800-8FUJITSU (1-800-838-5487)
- Website:
U.S.A. - us.fujitsu.com/solutions
Canada - www.fujitsu.ca

Before you place the call, you should have the following information ready so that the customer support representative can provide you with the fastest possible solution:

- Product name
- Product configuration number
- Product serial number
- Purchase date
- Conditions under which the problem occurred
- Any error messages that have occurred
- Type of device connected, if any

Fujitsu Shopping Online

You can go directly to the online by going to the website at: www.shopfujitsu.com.

Maintaining Latest Configuration

To ensure that you always have the most current driver updates related to your system, you should occasionally access the Fujitsu Software Download Manager (FSDM) utility. The FSDM utility is available to allow you to download the latest drivers, utilities, and applications from the Fujitsu Support site. If you have a Windows 7 operating system, you will need to go to the Support Site (<http://support.fujitsupc.com/CS/Portal/support.do?srch=DOWNLOADS>).

Limited Warranty

Your Tablet PC is backed by a Fujitsu International Limited Warranty. Check the service kit that came with your tablet for the Limited Warranty period and terms and conditions.

Chapter 1

Getting to Know Your Tablet PC

Overview

The STYLISTIC[®] Q572 Tablet PC is a high-performance pen-based computer that has been designed to support Microsoft[®] Windows[®] 7 and Windows[®] 8 Professional editions.

This chapter provides an overview of the STYLISTIC Q572 Tablet PC and its many features.

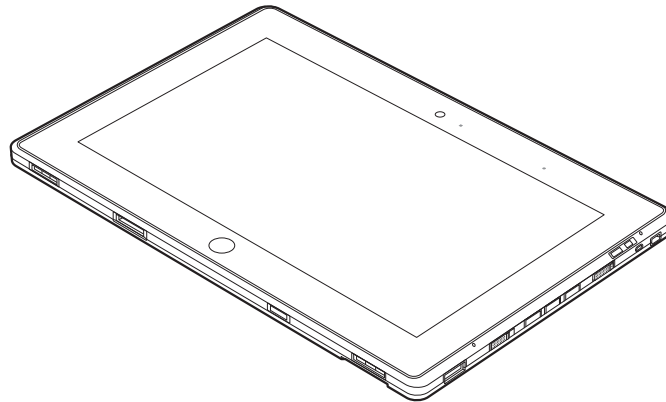

Figure 1. STYLISTIC Q572 Tablet PC

Locating the Connectors and Controls

Features and controls that you use to operate your Tablet PC are outlined below and illustrated in Figures 2 and 3. Details on using these features and controls are provided later in this manual.

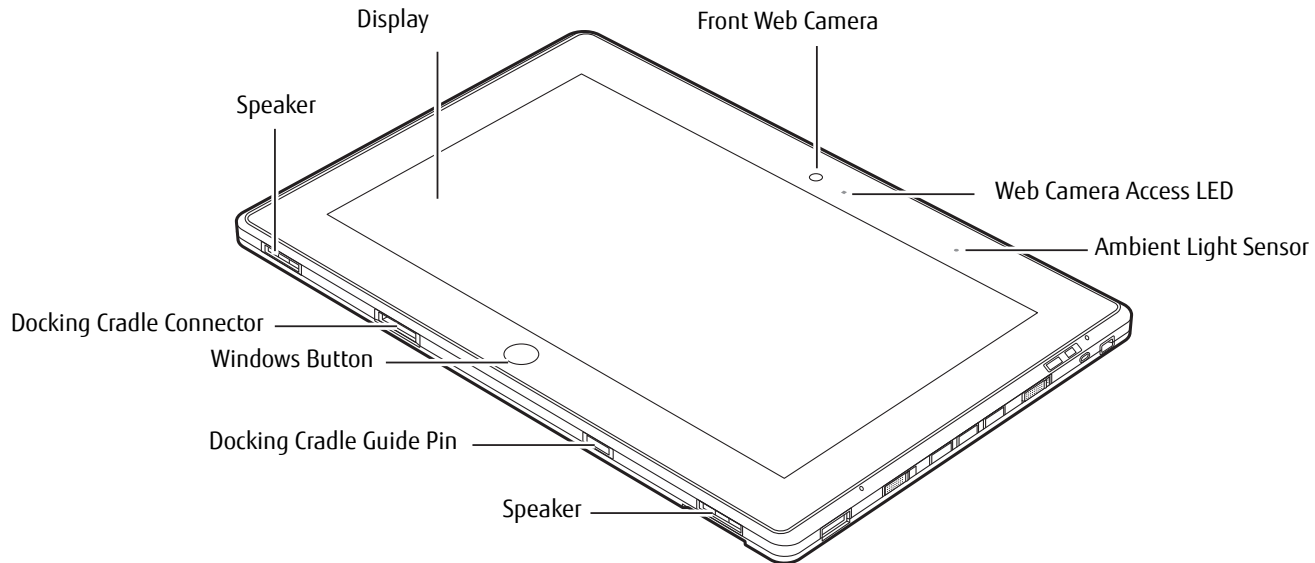

Figure 2. STYLISTIC Q572 Tablet PC Features (Bottom, Right View)

Front Features

Front Web Camera

The front-facing HD (1280 x 720 pixel) web camera allows you to take pictures of yourself to send over the internet.

Web Cam Access LED

The web cam access LED indicates when the web camera is in use.

Ambient Light Sensor

The ambient light sensor automatically recognizes lighting conditions and adjusts the display to provide optimum battery life.

Display

The 10.1" Wide XGA display offers 160 degree vertical and horizontal viewing angles.

Speakers

The speakers allow you to hear sound from the system.

Docking Cradle Guide Pin

The docking cradle guide pin provides an alignment point when docking your system in the cradle.

Windows Button

Pressing the Windows button gives you quick access to the Start menu.

Docking Cradle Connector

Allows you to connect the optional STYLISTIC Docking Cradle.

Display

The 10.1" HD display offers 160 degree vertical and horizontal viewing angles.

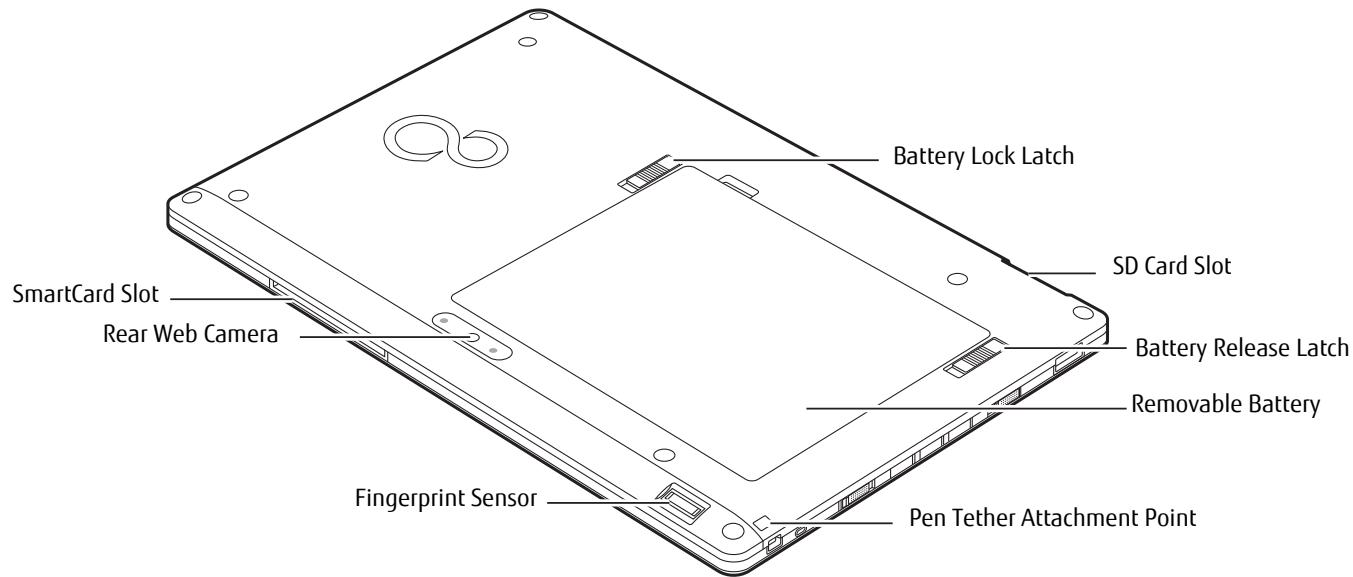

Figure 3. STYLISTIC Q572 Tablet PC Features (Back View)

Back Features

Battery Lock Latch

The battery lock latch is used with the battery release latch to allow removal of the battery.

SD Card Slot

The Secure Digital (SD) card slot allows you to insert a flash memory card for data storage. Flash memory cards allow you to transfer data to and from a variety of different digital devices. See "Secure Digital Cards" on page 52.

Battery Release Latch

The battery release latch is used with the battery lock latch to allow removal of the battery.

Removable Lithium Polymer Battery

Can be removed and replaced with a charged battery. See "Lithium Polymer Battery" on page 47.

Pen Tether Attachment Point

The pen tether attachment point is used to connect your pen -- or stylus -- to the system to prevent its loss.

Fingerprint Sensor

The fingerprint sensor allows you to start your system by swiping your finger over the sensor. See "Introducing the Fingerprint Sensor Device" on page 102.

Rear Web Camera

The 5.0 megapixel auto-focus rear web camera allows you to take pictures of objects in front of you for sharing over the internet.

Smart Card Slot

The dedicated Smart Card slot allows you to insert a Smart Card on which you can store such data as medical information or electronic "cash".

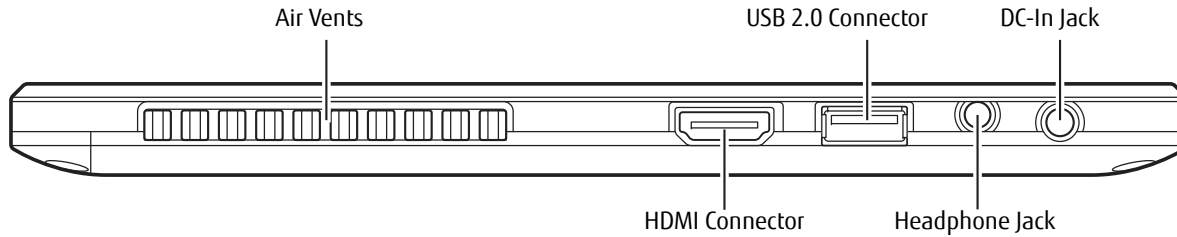

Figure 4. STYLISTIC Q572 Tablet PC Features Left Side

Left Side Features

Air Flow Vents

The air flow vents assist in proper cooling of the system.



TO PROTECT YOUR TABLET FROM DAMAGE AND TO OPTIMIZE SYSTEM PERFORMANCE, BE SURE TO **KEEP ALL AIR VENTS UNOBSTRUCTED, CLEAN, AND CLEAR OF DEBRIS**. THIS MAY REQUIRE PERIODIC CLEANING, DEPENDING UPON THE ENVIRONMENT IN WHICH THE SYSTEM IS USED.

DO NOT OPERATE THE TABLET IN AREAS WHERE THE AIR VENTS CAN BE OBSTRUCTED, SUCH AS IN TIGHT ENCLOSURES OR ON SOFT SURFACES LIKE A BED OR CUSHION.

USB 2.0 port

Allows you to connect Universal Serial Bus-compliant devices (compliant with USB Standard Revision 2.0) to the Tablet PC. Four additional USB ports are located on the optional STYLISTIC Docking Cradle.

DC input connector

Allows you to connect the AC adapter or auto adapter.

Line Out/Headphone Jack

Allows you to connect a set of stereo headphones.

HDMI Connector

The HDMI connector is used to connect compatible digital devices with your computer (such as a high-definition television or AV receiver).

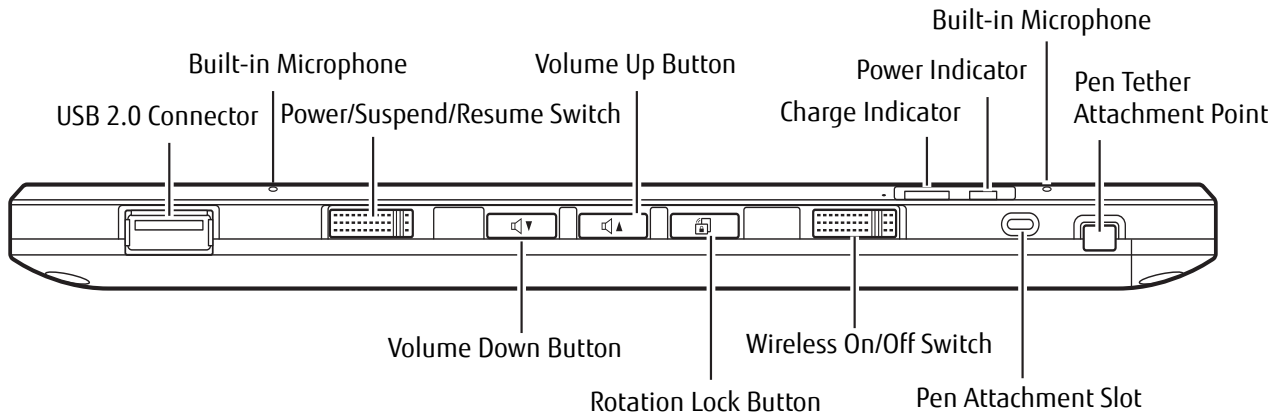

Figure 5. STYLISTIC Q572 Tablet PC Features Right Side

Right Side

USB 2.0 port

Allows you to connect Universal Serial Bus-compliant devices (compliant with USB Standard Revision 2.0) to the Tablet PC. Four additional USB ports are located on the optional STYLISTIC Docking Cradle.

Built-in Microphones

The built-in microphones allow you to input analog audio.

Power/Suspend/Resume Switch

Allows you to turn on, off, sleep, resume, hibernate or wake the Tablet PC in order to optimize battery life. See "Starting Your STYLISTIC Tablet PC" on page 39.

Volume Up / Volume Down Buttons

The Volume Up and Volume Down buttons allow you to control the volume of the tablet.

Charge and Power Indicators

Indicate the operational status of the Tablet PC power and battery charge level. See "Status Indicator Panel" on page 22.

Pen Tether Attachment Point

The pen tether attachment point is used to connect your pen -- or stylus -- to the system to prevent its loss.

Pen Attachment Slot

The pen attachment slot allows you to attach an optional pen holder to secure your pen.

Wireless On/Off switch

The wireless on/off switch is used to turn the optional WLAN, WWAN, and Bluetooth devices on and off. Switching the device off when not in use will help to extend battery life.

Rotation Lock Button

The rotation lock button is used to Pause or Resume the auto rotation feature. If the auto rotation feature is resumed, the display rotates automatically when the system is rotated. When the auto rotation feature is paused, the display doesn't rotate automatically when the tablet is rotated.

Status Indicator Panel

Icons appear under each of the system status LEDs in the status display indicating the status of system power and battery charge status. The location of icons in the Status display is shown in Figure 6.

Table 1 explains how the LEDs associated with the individual icons are displayed, and describes what the variations of that display indicate. (If an icon is not displayed, it indicates that the related system function is off or inactive.)

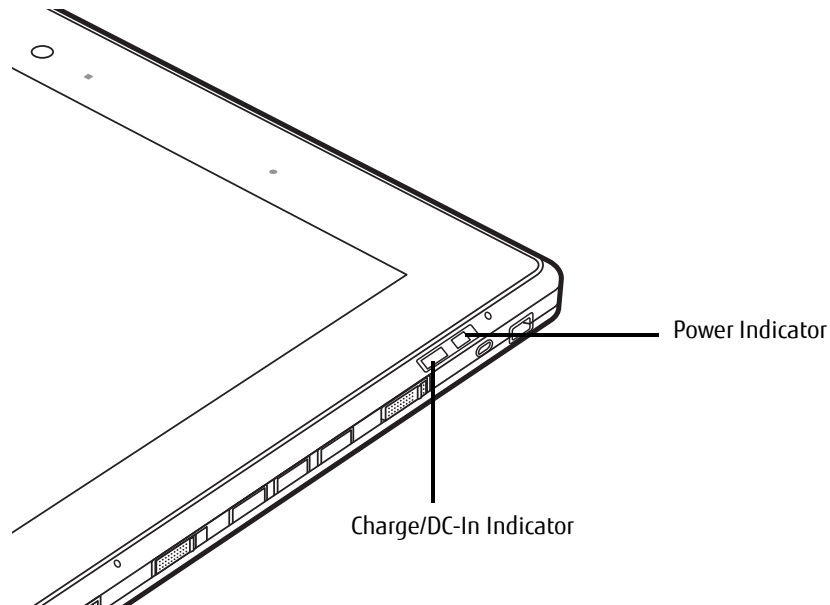



Figure 6. Status Display Icons

Table 1. Status Display Conditions

In the following table, a “blinking” LED flashes at the rate of once per second; an LED that is “blinking, slow” flashes at the rate of one second on, five seconds off.

Icon	Mode/State	LED State	Remarks
 Power	<ul style="list-style-type: none"> • On State • Idle Mode 	Blue, continuous	The system is powered on and ready for use.
	<ul style="list-style-type: none"> • Sleep 	Blue, blinking	The system has suspended and saved active settings to RAM.
	<ul style="list-style-type: none"> • Off State • Hibernate 	Off	The system has suspended and saved settings and data to the hard disk drive.
 Charge/DC In	<ul style="list-style-type: none"> • On State 	Green	AC adapter and battery are available and charged battery level is 50-100%.
	<ul style="list-style-type: none"> • Idle Mode 	Orange	AC adapter and battery are available and charged battery level is less than 50%.
	<ul style="list-style-type: none"> • Sleep 	Green, blinking	Tablet PC is in Suspend mode, AC adapter and battery are available and charged battery level is 50-100%.
	<ul style="list-style-type: none"> • Hibernate 	Orange, blinking	Tablet PC is in Suspend mode, AC adapter and battery are available and charged battery level is less than 50%.
	<ul style="list-style-type: none"> • Off State 	Off	The AC Adapter is not available.

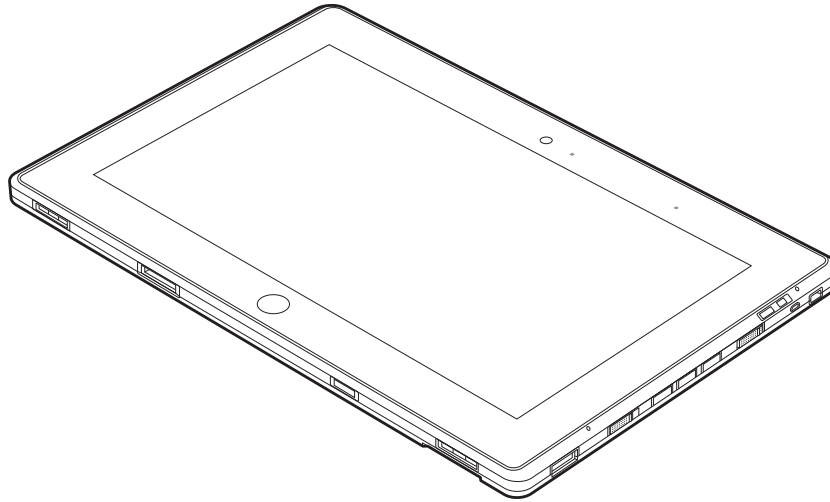

Figure 7. Tablet PC Display Panel

Display Panel

Your STYLISTIC Q572 Tablet PC contains an LCD display panel that is backlit for easier viewing in bright environments. The slate design of your Tablet PC allows you to easily hold the unit and rotate it 90°, 180°, or 270° in either direction. This display is used as a tablet, much as you would a pad of paper.

Adjusting Display Panel Brightness

To adjust brightness with the power management utility:

Click Start -> **Control Panel**. In **View by:**, select one of the icon views. Select **Display**, then click **Adjust brightness** in the left pane. Under **Select a power plan**, select the plan settings you want to use. Drag **Screen brightness:** bar (at the bottom of the window) to the left or right, depending on your preference.

Holding the Tablet PC

The STYLISTIC Q572 can be held in any of four orientations, depending upon how you would like to use it. There are primary and secondary landscape orientations and primary and secondary portrait orientations. (The orientation nomenclatures reflect those used in the button utility). When you rotate the system using the Rotation button, the order in which it rotates is illustrated below.

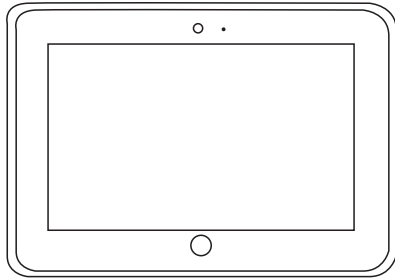

Primary Landscape Orientation

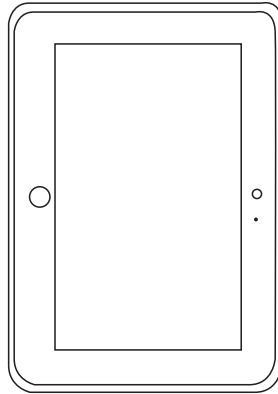

Secondary Portrait Orientation

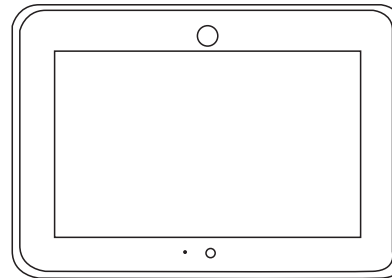

Secondary Landscape Orientation

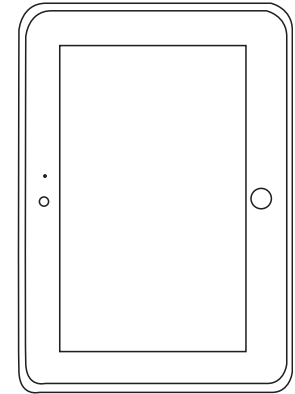

Primary Portrait Orientation

Active Digitizer/Touchscreen

Active Digitizer Display

The integrated active digitizer allows you to use the included stylus (also called a “pen”) as a pointing device. **(For detailed information about caring for your stylus, go to “Caring for the Pen” on page 32.)**

You can use the stylus to click, double-click, drag items and icons, write text, or to draw like a pen or pencil in applications that support this behavior, such as drawing or painting programs. See the documentation that came with your application for details.

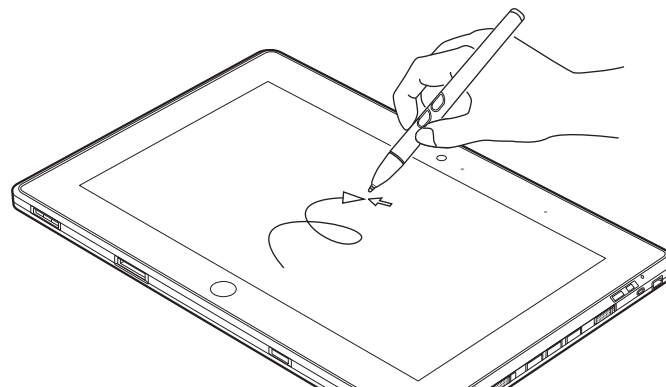

Figure 8. Using the Active Digitizer Display



- **DO NOT USE EXCESSIVE FORCE** WHEN TAPPING OR WRITING ON THE SCREEN WITH THE STYLUS. EXCESSIVE FORCE COULD RESULT IN DAMAGE TO THE LED AND/OR ACTIVE DIGITIZER.
- TO PURCHASE ADDITIONAL OR REPLACEMENT STYLUSES, VISIT THE FUJITSU ACCESSORIES WEBSITE AT: WWW.SHOPFUJITSU.COM.

Clicking on Active Digitizer Display

To left-click, touch the object you wish to select and then lift the stylus tip immediately.

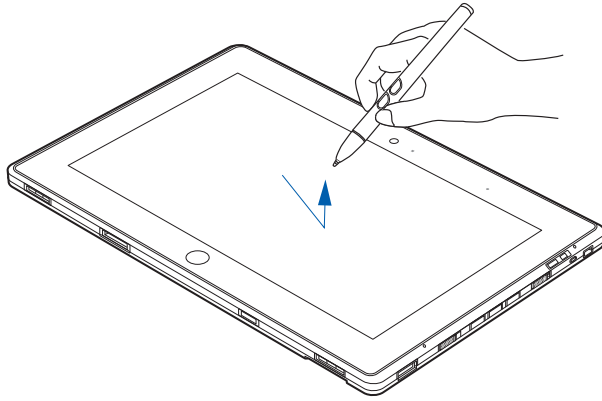

Figure 9. Clicking on the Active Digitizer Display

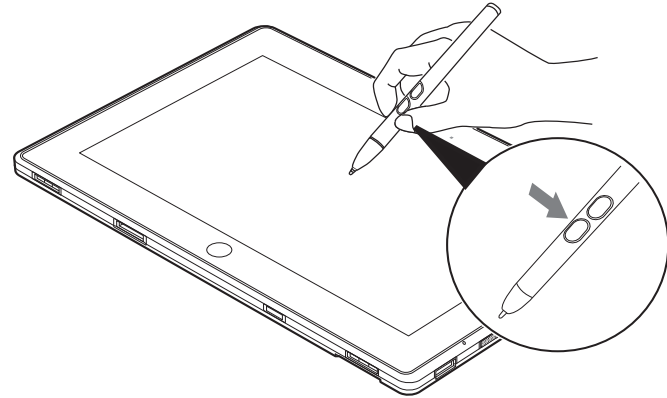

Figure 10. Right-clicking Active Digitizer

Right-Clicking on Active Digitizer

Right-click can be accomplished by holding the front toggle button down while tapping on the screen. To change the settings for the right-click feature, go to Start -> Control Panel -> Pen and Touch. In the Pen Options tab, select "Press and Hold" then click the [Settings] button.

Double-Clicking

To double-click, touch the item twice, and then immediately remove the stylus tip.

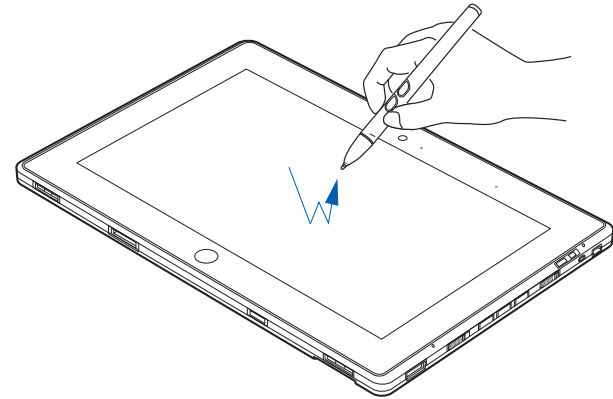

Figure 11. Double-clicking the Display

Dragging

Dragging means moving an item with the stylus by touching the screen, moving and then lifting the stylus. To drag, touch the Active Digitizer Display with your stylus on the item you wish to move. While continuing to touch the screen with the stylus, drag the item to its new location by moving the stylus across the screen, and then lifting the stylus to release it.

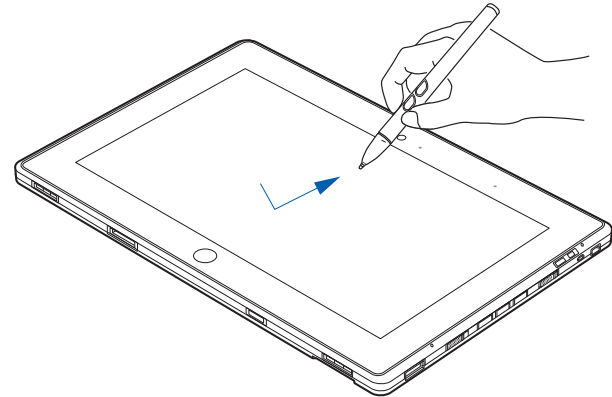

Figure 12. Dragging on the Display

Calibrating the Display

In order to ensure accurate tracking between the stylus and cursor, you must run the Calibration Utility before you use the system for the first time, or after you change the display resolution.

To run the calibration utility:

- 1 Go to Start -> Control Panel.
- 2 Double-click the Tablet PC Settings icon and select the Display tab
- 3 Click the [Calibrate] button, then select whether you want to calibrate pen input or touch input.
- 4 Adjust the display of your Tablet PC to a comfortable angle and find the (+) symbol in the upper-left corner of the display.



DO NOT USE EXCESSIVE FORCE WHEN TAPPING ON THE SCREEN DURING CALIBRATION. USE OF EXCESSIVE FORCE COULD RESULT IN DAMAGE TO THE LED AND/OR TOUCH PANEL.

- 5 Using the stylus or your finger (depending upon which type of input you are calibrating), firmly touch the screen directly on the (+) symbol. Lift the stylus from the screen and the target will move to a different location on the screen.
- 6 Repeat step 5 until you have selected all of the (+) symbols.
- 7 Once you have selected all the symbols, press the [OK] button.
- 8 Touch the stylus to various points on the screen to verify that the screen is correctly calibrated. If you are not satisfied with the screen's calibration, press the [Calibrate]) button to begin again.

Using the Capacitive Touchscreen

Certain configurations of this Tablet PC have an optional dual digitizer that allows you to use either the stylus or your finger(s) as a pointing device. This type of display also allows you to use “gestures” to perform such actions as scroll, zoom, and rotate.



- GESTURE SUPPORT IS DETERMINED BY THE APPLICATION IN USE.
- THE STYLUS TAKES PRECEDENCE OVER FINGER TOUCH. IF THE STYLUS IS WITHIN ACTIVE RANGE OF THE SCREEN, FINGER TOUCH WILL BE DISABLED.
- WHEN ONE FINGER IS USED ON THE TOUCHSCREEN, IT BEHAVES IN THE SAME MANNER AS A STYLUS.

Right-clicking the touchscreen

To perform a right-click action using two fingers, press the first finger at the location you want to perform a right-click, then quickly tap and release the second finger on the screen.

Gesture Mode

To initiate gesture mode, two fingers must touch the screen within 200 ms of each other. If the second finger touches the screen after 200 ms has elapsed, the second finger is ignored. If more than two fingers touch the screen in that time, Advanced Gesture Mode is activated instead. When Gesture Mode is activated, no cursor movement is sent to the system.

When both fingers are removed, Gesture mode ends. When a third finger is added, gesture mode ends and Advanced gesture mode is activated. Note that if a gesture can't be recognized, no action is taken. In that case, remove both fingers from the screen and try again.

Scrolling Gesture

To scroll through long documents or on a web page, place both fingers on the screen (one finger quickly followed by the second). If at least one finger has moved at least 3 mm, a scroll is considered. If both fingers are moving in the same direction and parallel (given a tolerance of 5 mm), Scroll Mode is activated. If one finger is stationary, it is not considered a scroll. If either finger is lifted, Scroll Mode is canceled.

Zoom Gesture

The zoom gesture is especially helpful when viewing pictures. To zoom in, place two fingers on the item you want to enlarge (one finger quickly followed by the second), then spread them away from each other.

If at least one finger has moved at least 10 mm, a zoom event is considered. If the distance between the fingers has changed by at least 10 mm, and both fingers have stayed on approximately the same line, Zoom Mode is entered. If either finger strays more than 10 mm from the "zoom line" created when the fingers first made contact, the zoom is canceled.

To zoom out, place two fingers on the item you want to reduce (one finger quickly followed by the second), then move them towards each other.

Rotate Gesture

To change the orientation of an object on the screen, place two fingers on the image you want to rotate (one finger quickly followed by the second), then move them in opposite directions (as if you were turning a knob). The direction the item turns is dependant upon the direction you move your fingers.

If at least one finger moves at least 12 mm, a rotate is considered. If one finger is stationary (moving less than 5 mm in any direction), and the other is moving, a rotate is considered. If the fingers begin moving in the same direction, the rotation is canceled. If the distance between the fingers changes by more than 10 mm, the rotation is canceled.

Accessing the OnScreen TouchPad

Your tablet has a handy on-screen touchpad that offers a variety of helpful functions. Features of the OnScreen TouchPad include:

- **Virtual Mouse Emulator:** The Virtual Mouse Emulator works in much the same manner as a hardware mouse. With the virtual mouse, you can scroll, drag, and click, as well as perform [Ctl]+[Click] and [Shift]+[Click] actions.
- **Application Launch/Key Macro:** This window provides access to five pages, each of which can contain up to twenty buttons. Each button can be programmed to open an application, a folder, document, or key (such as [Esc], [Alt+X] and [Page Up]).
- **Digital Keyboard:** This window provides a soft keyboard for use in mathematical procedures. It works in much the same way as the Windows standard calculator.

To access the OnScreen TouchPad, go to the Start Menu > All Programs > Fujitsu OnScreen TouchPad. To learn more about the utility, click on Usage and Help.

Caring for the Pen

- ONLY USE THE PEN PROVIDED WITH YOUR TABLET PC. DO NOT USE SUBSTITUTE PEN TIPS THAT WERE NOT SPECIALLY DESIGNED FOR YOUR TABLET PC. REPLACE THE STYLUS TIP IF IT IS WORN. THE WARRANTY DOES NOT COVER A SCRATCHED SCREEN.
- WHILE WRITING, DO NOT TO SCRATCH THE SURFACE OF THE DISPLAY (E.G., WITH A WRISTWATCH OR BRACELET).

THE PEN OF YOUR TABLET PC IS AN ELECTRONIC INSTRUMENT WHICH CAN BE DAMAGED IF USED INCORRECTLY. HANDLE THE PEN WITH CARE. THE FOLLOWING LIST CONTAINS GUIDELINES FOR PROPER PEN HANDLING:



- DO NOT GESTURE WITH THE PEN OR USE IT AS A POINTER.
- NEVER USE THE PEN ON ANY OTHER SURFACE THAN THE SCREEN OF YOUR TABLET PC.
- DO NOT TRY TO TURN THE THUMB GRIP ON THE PEN.
- NEVER STORE THE PEN WITH THE TIP BEARING THE WEIGHT OF THE PEN. IF THE PEN IS STORED WITH THE TIP POINTING DOWN, THIS MAY HAVE AN ADVERSE EFFECT ON THE PEN MECHANISM (PARTICULARLY UNDER HIGH TEMPERATURES). IN THIS CASE THE PEN TIP MAY REACT AS THOUGH IT IS CONSTANTLY BEING PRESSED DOWN.
- THE PEN CAN BE INFLUENCED BY ELECTROMAGNETIC FIELDS (CURSOR QUIVERS OR JUMPS). THERE MAY BE A FEW AREAS ON THE SCREEN WHERE THE CURSOR QUIVERS SLIGHTLY IN SPITE OF PRESSING THE PEN DOWN FIRMLY.

Changing the Pen Settings

There are a few changes you can make to your pen settings in order to make it more suitable to your needs (such as changing the pressure sensitivity). To do so, go to Start > Control Panel and select one of the icon views from the "View by:" dropdown. Click on the Pen and Touch icon to open the window from which you can change a variety of pen settings.

Changing the Pen Battery



- **DO NOT REMOVE THE TIP OF THE PEN TO REPLACE THE BATTERY; REMOVE ONLY THE CAP ON THE TOP OF THE PEN.**
- THERE IS A RISK OF EXPLOSION IF THE BATTERY IS REPLACED BY AN INCORRECT TYPE. DISPOSE OF USED BATTERIES IN ACCORDANCE WITH LOCAL INSTRUCTIONS.

The pen contains a AAAA-battery. Before proceeding, be sure to have a new battery available.

- 1 Remove the rear Pen Cap (Figure 13).
- 2 Remove the battery from the pen barrel.
- 3 Insert the new battery into the pen barrel in the same orientation as the one that was removed.
- 4 Close the rear Pen Cap.

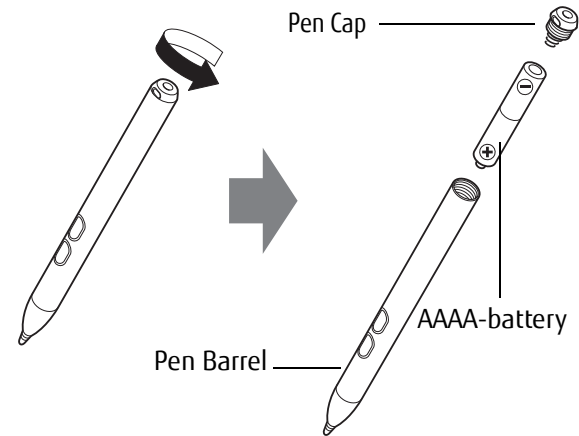

Figure 13. Replacing the Battery

Replacing the Pen Tip

With use, the pen tip may become worn or may pick up foreign particles that can scratch the screen. A damaged or worn tip may not move freely, causing unpredictable results when using the pen. If a problem like this should occur, you should replace the pen tip.

- 1 Using the pen tip removal tool that was included with your system, pinch the pen tip and pull it from the barrel.
- 2 Using one of the new tips that were supplied with your pen, insert the pointed end of the tip into the barrel and push it in firmly until it is in place

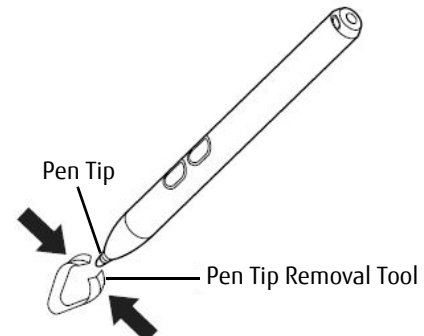

Figure 14. Replacing the Pen Tip

Installing a Pen Tether

To prevent dropping or losing your pen, you should attach it to your system using the pen tether that is included with the system.

To attach the pen tether to your Tablet PC, perform the following steps:

- 1** Attach the end of the pen tether with the smaller loop to your pen. To do so, push the end of the tether under the slot on the top of the pen, then thread the opposite end of the tether through the loop.
- 2** Attach the end of the pen tether with the larger loop to the attachment point on the right side of your tablet. To do so, insert the end of the pen tether through the attachment point, then feed the pen through the large loop in the tether.

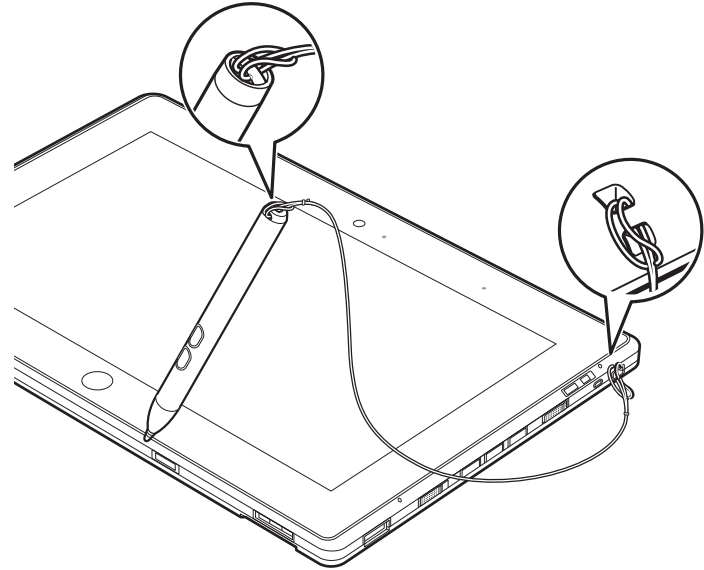

Figure 15. Installing a Pen Tether

Tablet PC Buttons

The three Tablet buttons are located on the right-hand side of a horizontally-oriented system. The Windows button is located at the bottom center of the display.

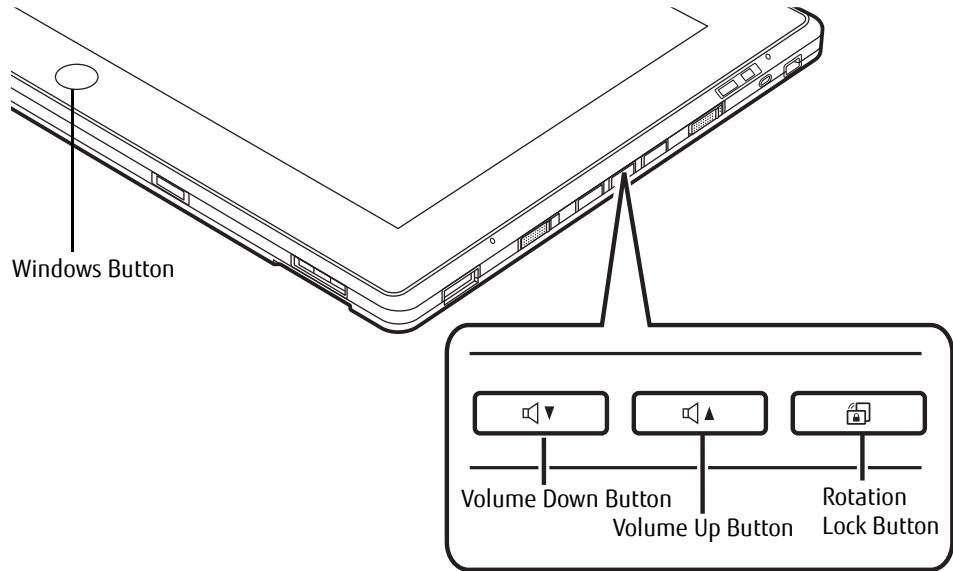

Figure 16. Application buttons

Button Name	Primary Function (Press)	Press at Splash Screen*	In BIOS Setup Utility	Description
Volume Down Button	Volume Down	Opens BIOS setup	Acts as Down key while in BIOS Setup	Pressing the Volume Down button decreases the volume. While the system is starting up, it opens the BIOS Setup utility, and while the BIOS is open, it can be used to move the cursor down.
Volume Up Button	Volume Up	None	Acts as Up key while in BIOS Setup	Pressing the Volume Up button increases the volume. When the BIOS is open, it can be used to move the cursor up.

Button Name	Primary Function (Press)	Press at Splash Screen*	In BIOS Setup Utility	Description
Rotation Lock Button	Enables/disable Auto Rotation feature	Opens the Boot menu	None	Pressing and holding the button enables and disables the Auto Rotate function. It also opens the Boot menu if pressed while the system is starting up.
Windows Button	Open Start menu/Ctl+Alt+Del	None	None	In post-logon, the Windows button can be used to perform two functions. When pressed alone, it opens up the Start menu. When pressed at the same time as the power button, it acts the same as if pressing [Ctl] + [Alt] + [Del].

* "Press at Splash Screen" refers to the action that occurs when you press the button when the Fujitsu logo appears when you first start up the system.



Chapter 2

Getting Started with Your Tablet PC

Power Sources

Your Fujitsu STYLISTIC Tablet PC has three possible power sources: a primary Lithium Polymer battery, an AC adapter or an optional Auto/Airline adapter.

Connecting the Power Adapters

The AC adapter or optional Auto/Airline adapter provides power for operating your Tablet PC and charging the batteries.

Connecting the AC Adapter

- 1 Plug the DC output cable into the DC power jack of your STYLISTIC Tablet PC.
- 2 Plug the AC adapter into an AC electrical outlet.

Connecting the Optional Auto/Airline Adapter

- 1 Plug the DC output cable into the DC power jack on your Tablet PC.
- 2 Plug the Auto/Airline adapter into the cigarette lighter of an automobile, or,
- 3 Plug the Auto/Airline adapter into the DC power jack on an airplane seat.

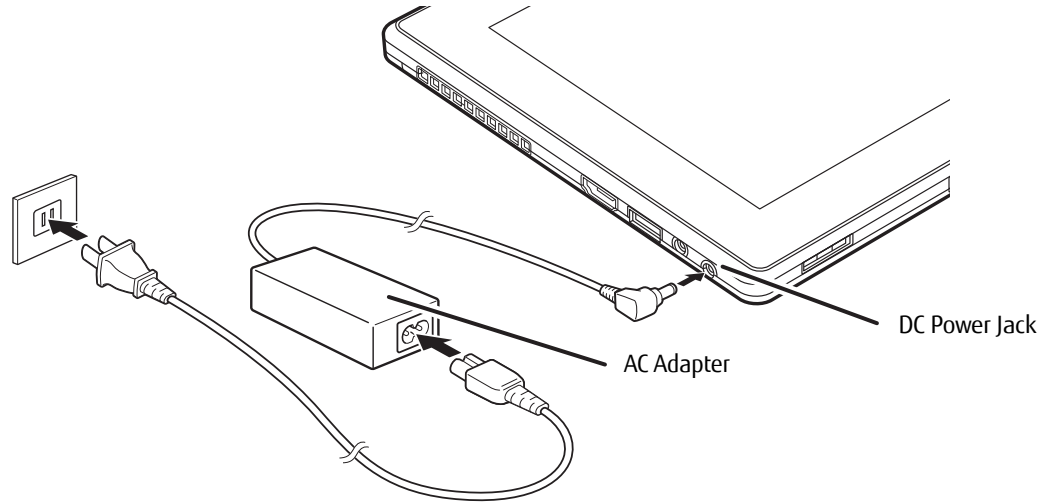

Figure 17. Connecting the AC Adapter

Switching from AC Adapter Power or the Auto/Airline Adapter to Battery Power

- 1** Be sure that you have at least one charged battery installed.
- 2** Remove the AC adapter or the Auto/Airline adapter.



THE LITHIUM POLYMER BATTERY IS NOT CHARGED UPON PURCHASE. INITIALLY, YOU WILL NEED TO CONNECT EITHER THE AC ADAPTER OR THE AUTO/AIRLINE ADAPTER TO USE YOUR TABLET PC.

Starting Your STYLISTIC Tablet PC

Power On

Power/Suspend/Resume Switch

The Power/Suspend/Resume switch is used to turn on your STYLISTIC Tablet PC from its off state. Once you have connected your AC adapter or charged the internal Lithium Polymer battery, you can power on your Tablet PC.



WHEN YOU TURN ON YOUR STYLISTIC TABLET PC BE SURE YOU HAVE A POWER SOURCE. THIS MEANS THAT AT LEAST ONE BATTERY IS INSTALLED AND CHARGED, OR THAT THE AC OR AUTO/AIRLINE ADAPTER IS CONNECTED AND HAS POWER.

To turn on your STYLISTIC Tablet PC from its off state, slide the Power/Suspend/Resume switch, located on the bottom edge of the right side (when the system is held horizontally). When you are done working you can either leave your Tablet PC in Suspend mode or you can turn it off. See "Sleep Mode" on page 44 and "Powering Off" on page 46.

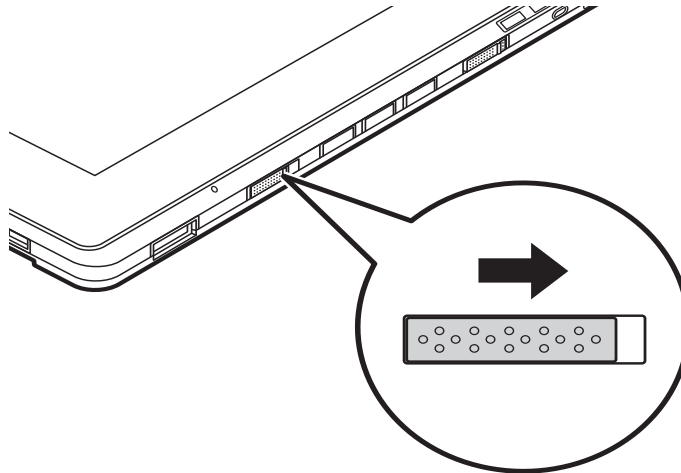

Figure 18. Power/Suspend/Resume Switch

When you power on your STYLISTIC, it will perform a Power On Self Test (POST) to check the internal parts and configuration for correct functionality. If a fault is found, your STYLISTIC Tablet PC will emit an audio warning and/or an error message will be displayed. See “Power On Self Test Messages” on page 62. Depending on the nature of the problem, you may be able to continue by starting the operating system or by entering the BIOS setup utility and revising the settings.

After satisfactory completion of the POST, your Tablet PC will load your operating system.



NEVER TURN OFF YOUR STYLISTIC TABLET PC DURING THE POWER ON SELF TEST (POST) OR IT WILL CAUSE AN ERROR MESSAGE TO BE DISPLAYED WHEN YOU TURN YOUR STYLISTIC TABLET PC ON THE NEXT TIME. See “Power On Self Test Messages” on page 62.

Boot Sequence

The procedure for starting-up your Tablet PC is termed the Bootup sequence and involves your Tablet PC’s BIOS. When your STYLISTIC Tablet PC is first turned on, the main system memory is empty, and it needs to find instructions to start up your Tablet PC. This information is in the BIOS program. Each time you power up or restart your Tablet PC, it goes through a boot sequence which displays a Fujitsu logo until your operating system is loaded. During booting, your Tablet PC is performing a standard boot sequence including a Power On Self Test (POST). When the boot sequence is completed without a failure and without a request for the BIOS Setup Utility, the system displays the operating system’s opening screen.

The boot sequence is executed when:

- You turn on the power to your STYLISTIC Tablet PC.
- You restart your Tablet PC from the Windows Shut Down dialog box.
- The software initiates a system restart. Example: When you install a new application.

Hard Disk Drive Passwords

To provide additional security for your data, you can assign passwords to your hard disk drive(s). This feature is managed in the system BIOS Setup Utility. See *BIOS Setup Utility* below for information about accessing the utility.



REMEMBER YOUR PASSWORDS. IF YOU SET AND FORGET YOUR USER AND MASTER HARD DISK PASSWORDS, FUJITSU WILL NOT BE ABLE TO RESET IT. YOU MAY LOSE DATA AND HAVE TO REPLACE YOUR SYSTEM BOARD OR HARD DISK DRIVE.

BIOS Setup Utility

The BIOS Setup Utility is a program that sets up the operating environment for your STYLISTIC Tablet PC. Your BIOS is set at the factory for normal operating conditions, therefore there is no need to set or change the BIOS' environment to operate your Tablet PC.

The BIOS Setup Utility configures:

- Device control feature parameters, such as changing I/O addresses and boot devices.
- System Data Security feature parameters, such as passwords.

Entering the BIOS Setup Utility

To enter the setup utility, do the following:

- 1 Turn on or restart your STYLISTIC Tablet PC.
- 2 To enter the BIOS Setup Utility, either press the Rotation button (or press the [F2] key if you have an external keyboard) when the Fujitsu logo appears on the screen. This will open the main menu of the BIOS Setup Utility with the current settings displayed.
- 3 Press the [RIGHT ARROW] or [LEFT ARROW] key to scroll through the other setup menus to review or alter the current settings.

BIOS Guide

A guide to your Tablet PC's BIOS is available online. Please visit our service and support website at <http://www.computers.us.fujitsu.com/support>, then select User's Guides under Online Support. Select your Product, Series, and Model, then click [Go]. Under the Manuals tab, select the BIOS Guide.

Booting the System

We strongly recommend that you not attach any external devices until you have gone through the initial power on sequence.

When you turn on your Tablet PC for the first time, it will display a Fujitsu logo on the screen. If you do nothing the system will load the operating system, and then the Windows Welcome will begin.

Starting Windows the First Time

After you boot up the system the first time and follow the instructions on the screen, you will eventually come to the Sign-In screen which prompts you for your user name. After sign-in, it takes less than a minute for the computer to boot to Windows and during that time a progress bar and interactive messages are displayed on the screen.

During the course of the first start up, you will need to read and accept the End User License Agreements (EULAs) for Microsoft and Fujitsu.



YOU CANNOT USE YOUR NOTEBOOK UNTIL YOU HAVE ACCEPTED THE LICENSE AGREEMENT. IF YOU STOP THE PROCESS YOUR NOTEBOOK WILL RETURN TO THE BEGINNING OF THE WINDOWS WELCOME PROCESS, EVEN IF YOU SHUT YOUR NOTEBOOK DOWN AND START IT UP AGAIN.

Following first boot, you will arrive at the Modern start screen. Some useful shortcuts for your reference: Press the Windows + D key to go to traditional Windows desktop. Press Windows + M key to load the traditional Windows desktop and minimize all applications.



Installing Bonus Apps

After you have started your system the first time, you will see a Bonus Apps icon on your desktop. Click on the icon to see which additional applications are available for you to install. Alternatively, you can access Bonus Apps by opening the Charms panel from Modern Start screen and searching for "Bonus Apps". Applications that are already installed appear in grey; those that are available for installation appear in blue.

Select the applications you wish to install by selecting the checkbox adjacent to your selection, or click [Select All] if you would like to install all available applications. Once you have made your selections, click [Install].

Note that in some cases (depending upon which application was selected for installation) after installation completes, the system will prompt you to reboot. There are also cases in which if multiple applications are selected to install but one of them needs a reboot, the system will reboot and continue installing the rest of the selected applications.

Registering your LIFEBOOK with Fujitsu

You can register your notebook by going to our website at: <http://www.us.fujitsu.com/computers>. You will need to be set up with an Internet Service Provider (ISP) to register online.

Power Management

Your Fujitsu STYLISTIC Tablet PC has many options and features for conserving battery power. Some of these features are automatic and need no user intervention. However, others depend on the parameters you set to best suit your operating conditions, such as those for the display brightness. Internal power management for your Tablet PC may be controlled from settings made in your operating system, pre-bundled power management application, or from settings made in BIOS setup utility.

Besides the options available for conserving battery power, there are also some things that you can do to prevent your battery from running down as quickly. For example, you can create an appropriate power saving profile, put your Tablet PC into Sleep mode when it is not performing an operation, and you can limit the use of high power devices. As with all mobile, battery powered computers, there is a trade-off between performance and power savings.

Power/Suspend/Resume Switch

When your Tablet PC is active, the Power/Suspend/Resume switch can be used to manually put the Tablet PC into Sleep mode. Push the Power/Suspend/Resume switch when the Tablet PC is active, but not actively accessing anything, and immediately release the button.

If your Tablet PC is suspended, pushing the Power/Suspend/Resume switch returns it to active operation. You can tell whether the system is Suspended by looking at the Power indicator. If the indicator is visible and not flashing, your Tablet PC is fully operational. If the indicator is visible *and* flashing, the Tablet PC is in Sleep mode. If the indicator is not visible, the power is off or your Tablet PC is in Hibernation mode.

Sleep Mode

Sleep mode in Windows saves the contents of your system memory during periods of inactivity by maintaining power to critical parts. This mode turns off the CPU, display, hard drive, and all other internal components except those necessary to maintain system memory and for restarting.

Your Tablet PC can be put in sleep mode by:

- Pressing the Power/Suspend/Resume switch when your system is turned on.
- Selecting "Sleep" after clicking [Start] then clicking the small arrow at the bottom right of the window.
- Timing out from lack of activity.
- Allowing the battery to reach the Dead Battery Warning condition.

Your Tablet PC's system memory typically stores the file on which you are working, open application information, and any other data required to support operations in progress. When you resume operation from Sleep mode, your Tablet PC will return to the point where it left off. You must use the Power/Suspend/Resume switch to resume operation, and there must be an adequate power source available, or your Tablet PC will not resume.



- IF RUNNING YOUR TABLET PC ON BATTERY POWER, BE AWARE THAT THE BATTERY CONTINUES TO DISCHARGE WHILE YOUR TABLET PC IS IN SLEEP MODE, THOUGH NOT AS QUICKLY AS WHEN FULLY OPERATIONAL.
- DISABLING THE POWER/SUSPEND/RESUME SWITCH PREVENTS IT FROM BEING USED TO PUT THE TABLET PC INTO SLEEP OR HIBERNATION MODE. THE BUTTON RESUME FUNCTION CANNOT BE DISABLED.
- IF YOUR TABLET PC IS ACTIVELY ACCESSING INFORMATION WHEN YOU ENTER THE SLEEP OR HIBERNATION MODE, CHANGES TO OPEN FILES ARE NOT LOST. THE FILES ARE LEFT OPEN AND MEMORY IS KEPT ACTIVE DURING SLEEP MODE OR THE MEMORY IS TRANSFERRED TO THE INTERNAL HARD DRIVE DURING HIBERNATION MODE.
- THE MAIN ADVANTAGE OF USING HIBERNATION IS THAT POWER IS NOT REQUIRED TO MAINTAIN YOUR DATA. THIS IS PARTICULARLY IMPORTANT IF YOU WILL BE LEAVING YOUR TABLET PC IN A SUSPENDED STATE FOR A PROLONGED PERIOD OF TIME. THE DRAWBACK OF USING HIBERNATION MODE IS THAT IT LENGTHENS THE POWER DOWN AND POWER UP SEQUENCES AND RESETS PERIPHERAL DEVICES.

Hibernation (Save-to-Disk) Feature

The Hibernation feature saves the contents of your notebook's system memory to the hard drive as a part of the Power/Suspend/Resume mode. You can enable or disable this feature.

Enable or Disable the Hibernation Feature

The default settings are not enabled. To enable or disable the Hibernation feature, follow these steps:

- 1 From the Modern Start screen, press [Windows]+[X]. Select **Control Panel** from the menu, then select **Power Options**.
- 2 Select **Choose what the power button does** or **Choose what closing the lid does**, then make your selection (Do Nothing, Sleep, Hibernate, or Shut Down).

Windows Power Management

The Power Options icon in the Control Panel allows you to configure some of the power management settings. For example, you can use Power Options to set the timeout values for turning off the display and hard disks whether you are running the notebook on battery or one of the adapters.

Restarting the System

If your system is on and you need to restart it, be sure that you use the following procedure.

- 1 From the Modern Start screen, open Charms (**[Windows]+C**) or mouse over [-] in the bottom right corner of the screen). Click **[Settings]**->**[Power]**.
- 2 Select **Restart** from the list.



TURNING OFF YOUR LIFEBOOK NOTEBOOK WITHOUT EXITING WINDOWS OR TURNING ON YOUR NOTEBOOK WITHIN 10 SECONDS OF THE NOTEBOOK BEING SHUT OFF MAY CAUSE AN ERROR WHEN YOU START THE NEXT TIME.

Powering Off

Before turning off the power, check that the hard drive/optical drive access indicator is off. If you turn off the power while accessing a disk there is a risk of data loss. To ensure that your notebook shuts down without error, use the Windows shutdown procedure.



BE SURE TO CLOSE ALL FILES AND EXIT ALL APPLICATIONS PRIOR TO TURNING OFF THE POWER. IF FILES ARE OPEN WHEN YOU TURN THE POWER OFF, YOU WILL LOSE ANY CHANGES THAT HAVE NOT BEEN SAVED, AND MAY CAUSE DISK ERRORS.

Using the correct procedure to shut down from Windows allows your notebook to complete its operations and turn off power in the proper sequence to avoid errors. The proper sequence is:

From the Modern Start screen, open Charms (**[Windows]+C**) or mouse over [-] in the bottom right corner of the screen), click **[Settings]**->**[Power]**. Select **Shut down** from the list.

Chapter 3

User-Installable Features

Lithium Polymer Battery

Your STYLISTIC Tablet PC has a Lithium Polymer battery that provides power for operating your Tablet PC when no external power source is available. The battery is durable and long lasting, but should not be exposed to extreme temperatures, high voltages, chemicals or other hazards.

The Lithium Polymer battery operating time may become shorter if it is used under the following conditions:

- When used at temperatures that exceed a low of 5°C or a high of 35°C (41° to 95° F). Extreme temperatures not only reduce charging efficiency, but can also cause battery deterioration. The Charging icon on the Status Indicator panel will flash when you try to charge a battery that is outside its operating temperature range.
- When using a high current device such as an external optical drive or the hard drive, using the AC adapter will conserve your battery life.



DO NOT LEAVE A FAULTY BATTERY IN YOUR TABLET PC. IT MAY DAMAGE YOUR AC ADAPTER, OPTIONAL AUTO/AIRLINE ADAPTER, OR YOUR TABLET PC ITSELF. IT MAY ALSO PREVENT OPERATION OF YOUR TABLET PC BY DRAINING ALL AVAILABLE CURRENT INTO THE BAD BATTERY.



- ACTUAL BATTERY LIFE WILL VARY BASED ON SCREEN BRIGHTNESS, APPLICATIONS, FEATURES, POWER MANAGEMENT SETTINGS, BATTERY CONDITION AND OTHER CUSTOMER PREFERENCES. HARD DRIVE USAGE MAY ALSO HAVE A SIGNIFICANT IMPACT ON BATTERY LIFE. THE BATTERY CHARGING CAPACITY IS REDUCED AS THE BATTERY AGES. IF YOUR BATTERY IS RUNNING LOW QUICKLY, YOU SHOULD REPLACE IT WITH A NEW ONE.
- UNDER FEDERAL, STATE, OR LOCAL LAW IT MAY BE ILLEGAL TO DISPOSE OF BATTERIES BY PUTTING THEM IN THE TRASH. PLEASE TAKE CARE OF OUR ENVIRONMENT AND DISPOSE OF BATTERIES PROPERLY. CHECK WITH YOUR LOCAL GOVERNMENT AUTHORITY FOR DETAILS REGARDING RECYCLING OR DISPOSING OF OLD BATTERIES. IF YOU CANNOT FIND THIS INFORMATION ELSEWHERE, CONTACT YOUR SUPPORT REPRESENTATIVE AT 1-800-8FUJITSU (1-800-838-5487)

Recharging the Batteries

If you want to know the condition of the primary Lithium Polymer battery, check the Battery Level indicator located on the Status Indicator panel. The indicator changes as the battery level changes.

The Lithium Polymer battery is recharged internally using the AC adapter or Auto/Airline adapter. To recharge the battery make sure the battery that needs to be charged is installed in your STYLISTIC Tablet PC and connect the AC or Auto/Airline adapter.



MAKE SURE THAT THE PERCENTAGE CHARGE IS INDICATED BY THE BATTERY CHARGING INDICATOR ON THE STATUS INDICATOR PANEL.

There is no memory effect on the Lithium Polymer battery therefore you do not need to discharge the battery completely before recharging. The charge times will be significantly longer if your Tablet PC is in use while the battery is charging. If you want to charge the battery more quickly, put your Tablet PC into Sleep mode, or turn it off while the adapter is charging the battery. *(See Power Management on page 44 for more information on Sleep mode and shutdown procedure)*



USING HEAVY CURRENT DEVICES OR FREQUENT EXTERNAL OPTICAL DRIVE ACCESSES MAY PREVENT CHARGING COMPLETELY.

Low Battery State

When the battery is running low, a low battery notification message will appear. If you do not respond to the low battery message, the batteries will continue to discharge until they are too low to operate. When this happens, your Tablet PC will go into Sleep mode. There is no guarantee that your data will be saved once the Tablet PC reaches this point.



- ONCE THE LOW BATTERY NOTIFICATION MESSAGE APPEARS, YOU NEED TO SAVE ALL YOUR ACTIVE DATA AND PUT YOUR TABLET PC INTO SLEEP MODE UNTIL YOU CAN PROVIDE A NEW POWER SOURCE. YOU SHOULD PROVIDE A CHARGED BATTERY, AN AC POWER ADAPTER, OR AUTO/AIRLINE ADAPTER AS SOON AS POSSIBLE.
- WHEN YOU ARE IN SLEEP MODE THERE MUST ALWAYS BE AT LEAST ONE POWER SOURCE ACTIVE. IF YOU REMOVE ALL POWER SOURCES WHILE YOUR STYLISTIC TABLET PC IS IN SLEEP MODE, ANY DATA THAT HAS NOT BEEN SAVED TO THE HARD DRIVE WILL BE LOST.

Dead Battery Suspend mode shows on the Status indicator just like the normal Sleep mode. Once your Tablet PC goes into Dead Battery Suspend mode you will be unable to resume operation until you provide a source of power either from an adapter, or a charged battery. Once you have provided power, you will need to press the Power/Suspend/Resume switch to resume operation.

In the Dead Battery Suspend mode, your data can be maintained for some time, but if a power source is not provided promptly, the Power indicator will stop flashing and go out, meaning that you have lost the data that was not stored. Once you provide power, you can continue to use your Tablet PC while an adapter is charging the battery.

Shorted Batteries

The Status Indicator panel indicator associated with the Battery Level indicator displays the operating level available in that battery. If this display shows a flashing red LED, it means the battery is damaged and must be replaced so it does not damage other parts of your STYLISTIC Tablet PC.

Replacing the Battery

With the purchase of an additional battery, you can have a fully charged spare to swap with one that is not charged. There are two ways to swap batteries, cold-swapping and hot-swapping:

Cold-swapping Batteries

To cold-swap batteries in your battery bay, follow these easy steps:

- 1 Have a charged battery ready to install.
- 2 Perform one of the following two steps:
 - Click the Fujitsu Battery Swap Utility icon on the desktop. Follow the instructions that appear to put the system into Hibernate mode. Using this procedure saves your data and the system powers down. It is then safe to swap the batteries.
 - Save your data, then power down the system. It is then safe to swap the batteries.
- 3 Note that the battery latch on the left is spring loaded, while the latch on the right is not. Unlock the battery by first pushing the right latch backwards, then pushing and holding the left latch (Figure 19). While holding the left latch, lift the battery out at the lift point (Figure 20).
- 4 To install a battery, first verify that the right latch is pushed back. While pushing the left latch back and holding it, insert a new battery into the bay. Lock the battery in place by sliding the right latch forward.
- 5 Plug in the AC adapter and turn the power on.

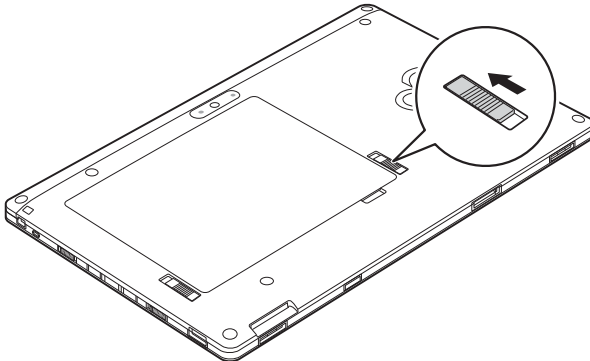

Figure 19. Unlocking the Battery

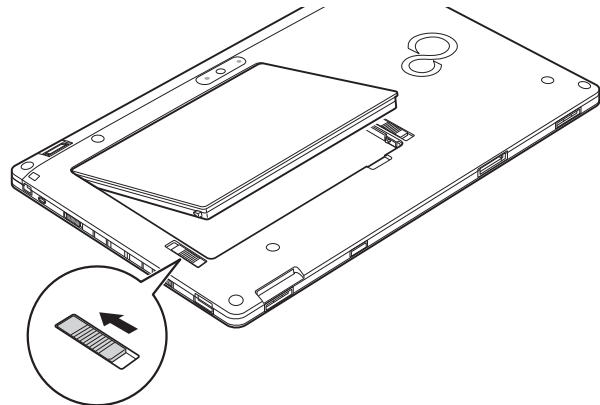

Figure 20. Removing the Battery

Hot-swapping Batteries

To hot-swap batteries in your battery bay follow these easy steps:



BE SURE TO PLUG IN AN AC ADAPTER PRIOR TO REMOVING THE BATTERY. THERE IS NO BRIDGE BATTERY PRESENT TO SUPPORT THE SYSTEM WHILE THE BATTERY IS BEING REPLACED. IF YOU DO NOT USE AN AC ADAPTER YOU WILL LOSE ANY UNSAVED FILES.

- 1 Plug an AC Adapter into the system and connect it to a power outlet.
- 2 Follow steps 3 through 5 in "Cold Swapping Batteries".



IF THE LITHIUM POLYMER BATTERY CONNECTOR IS NOT FULLY SEATED, YOU MAY NOT BE ABLE TO USE YOUR TABLET PC OR CHARGE YOUR BATTERY.

Secure Digital Cards

Your STYLISTIC Tablet PC supports Secure Digital (SD) cards, on which you can store and transfer data to and from a variety of digital devices. These cards use flash memory architecture, which means they don't need a power source to retain data. Note that SD and SDHC Cards are supported, but SDXC Cards are not.

SD Cards allow portable storage among a variety of devices, such as cell phones, GPS systems, digital cameras, and PDAs. SD Cards transfer data quickly, with low battery consumption.

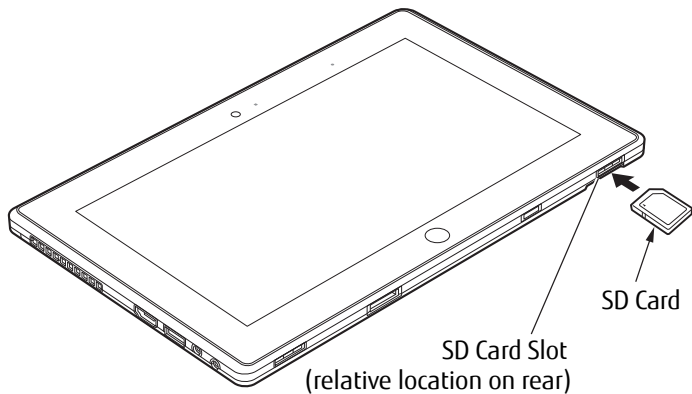

Figure 21. SD Card Slot - Front Access

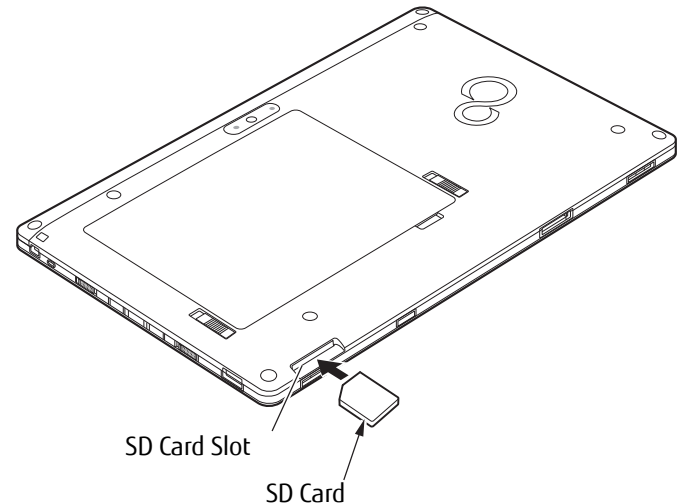

Figure 22. SD Card Slot - Rear Access

Installing SD Cards

When holding the Tablet PC in horizontal position with the front facing you and the web camera on the left, the SD Card slot is located at the top left edge of the system, in the rear (Figures 21 and 22). To install an SD Card, follow these steps:



INSTALLING OR REMOVING AN SD CARD DURING YOUR STYLISTIC TABLET PC'S SHUTDOWN OR BOOTUP PROCESS MAY DAMAGE THE CARD AND/OR YOUR STYLISTIC TABLET PC.

DO NOT INSERT A CARD INTO A SLOT IF THERE IS WATER OR ANY OTHER SUBSTANCE ON THE CARD AS YOU MAY PERMANENTLY DAMAGE THE CARD, YOUR STYLISTIC TABLET PC, OR BOTH.

- 1 See your specific card manual for instructions on the installation of your card. Some cards may require that your Tablet PC is off while installing them.
- 2 Make sure there is no card currently in the slot. If there is, see Removing an SD Card.
- 3 With the product label facing in the same direction as the display screen, insert your card into the slot.
- 4 Push the card firmly into the slot until it is seated in the connector.

Removing an SD Card

To remove an SD Card, follow these easy steps:



SEE YOUR CARD MANUAL FOR SPECIFIC INSTRUCTIONS ON THE REMOVAL OF YOUR CARD. SOME CARDS MAY REQUIRE YOUR STYLISTIC TABLET PC TO BE IN SLEEP MODE OR OFF WHILE REMOVING THEM.

- 1 Select Safely Remove Hardware from the System Tray. Highlight the card in the list, then click [Stop].
- 2 Push the SD Card in until it unlatches. It will then eject from the slot for removal.

Chapter 4

Troubleshooting Your Tablet PC

Troubleshooting

There may be occasions when you encounter simple setup or operating problems that you can solve on the spot, or problems with peripheral devices that can be solved by replacing the device. The information in this section helps you isolate and resolve some of these straightforward issues and identify failures that require service.

Identifying the Problem

If you encounter a problem, go through the following procedure before pursuing complex troubleshooting:

- 1 Turn off your STYLISTIC Tablet PC.
- 2 Make sure the AC adapter is plugged into your Tablet PC and to an active AC power source.
- 3 Make sure that any cards installed are seated properly. If it appears that there is a problem with a card, remove the card from the slot, thus eliminating it as a possible cause of failure.
- 4 Make sure that any devices connected to the external connectors are plugged in properly. You can also disconnect such devices, thus eliminating them as possible causes of failure.
- 5 Turn on your Tablet PC. Make sure it has been off at least 10 seconds before you turn it back on.
- 6 Go through the boot sequence.
- 7 If the problem has not been resolved, refer to the Troubleshooting Table that follows for more detailed troubleshooting information.



IF YOU KEEP NOTES ABOUT WHAT YOU HAVE TRIED, YOUR SUPPORT REPRESENTATIVE MAY BE ABLE TO HELP YOU MORE QUICKLY BY GIVING ADDITIONAL SUGGESTIONS OVER THE PHONE.

- 8** If you have tried the solutions suggested in the Troubleshooting Table without success, contact your support representative:

Toll free: 1-800-8Fujitsu (1-800-838-5487)

Web site: <http://www.computers.us.fujitsu.com/support>

Before you place the call, you should have the following information ready so that the customer support representative can provide you with the fastest possible solution:

- Product name
- Product configuration number
- Product serial number
- Purchase date
- Conditions under which the problem occurred
- Any error messages that have occurred
- Type of device connected, if any

See the Configuration Label on the bottom of your Tablet PC for configuration and serial numbers.

Specific Problems

Using the Troubleshooting Table

When you have problems with your Tablet PC, try to find the symptoms under the Problem column of the troubleshooting table for the feature giving you difficulty. You will find a description of common causes for that symptom under the column Possible Cause and what, if anything, you can do to correct the condition under Possible Solutions. All possible causes or solutions may not apply to your Tablet PC.

Troubleshooting Table

Audio Problems	page 57	Power Failures	page 58
Hard Drive Problems	page 57	Shutdown and Startup Problems . .	page 60
Keyboard or Mouse Problems . . .	page 57	Video Problems	page 61
Pen Input Problems	page 57	Miscellaneous Problems	page 62
USB Device Problems	page 58		

Problem	Possible Cause	Possible Solutions
Audio Problems		
There is no sound coming from the built-in speaker.	The volume is turned too low.	Adjust the volume control on your Tablet PC and operating system. Click the Volume icon in the system tray on the bottom right of the screen. (It looks like a speaker). If the Mute box has a red circle on it, click on it to deselect it.
	Headphones are plugged into your Tablet PC.	Plugging in headphones disables the built-in speaker. Remove the headphones.
Hard Drive Problems		
You cannot access your hard drive.	The wrong drive designator was used by an application when a bootable disc was used to start the Tablet PC.	Verify drive designator used by application is in use by the operating system. When the operating system is booted from a CD, drive designations are automatically adjusted.
	Security is set so your operating system cannot be started without a password.	Verify your password and security settings.
Keyboard or Mouse Problems		
You have installed an optional external keyboard or mouse, and it does not seem to work.	Your external device is not properly installed.	Re-install your device. See "Device Ports" on page 82.
	Your operating system is not set up with correct software driver for that device.	Check your device and operating system documentation and activate the proper driver.
You have connected an external keyboard or a mouse and it seems to be locking up the system.	Your operating system is not setup with correct driver.	Check your device and operating system documentation and activate the proper driver.
	Your system has crashed.	Try to restart your Tablet PC.
Pen Input Problems		
Cursor isn't tracking the pen.	Display needs to be calibrated	See "Calibrating the Display" on page 29. for more information.

Problem	Possible Cause	Possible Solutions
Tablet is not responding to the pen	System may have crashed.	If the Tablet PC does not respond to the pen, connect an external keyboard to the system to see if it responds to keyboard commands. If the system doesn't respond to a keyboard, the application or system may have crashed, and it may be necessary to reboot the system. If the system responds to a keyboard but not to a pen, contact your local help desk or reseller, or call Fujitsu Service and Support at 1-800-8Fujitsu (1-800-838-5487) for further assistance.
Memory Problems		
Your System screen in the Control Panel does not show the correct amount of installed memory.	You have a memory failure.	Check for Power On Self Test (POST) messages. See "Power On Self Test Messages" on page 62.
USB Device Problems		
Your system doesn't recognize a USB device you installed, or the device doesn't work properly.	The device is not properly installed.	Remove and re-install the device.
	The device may have been installed while an application was running, so your system is not aware of its installation.	Close the application and restart your Tablet PC.
	Your device may not have the correct software driver active.	See your software documentation and activate the correct driver.
Power Failures		
You turn on your Tablet PC and nothing seems to happen.	The installed battery is completely discharged or there is no power adapter installed.	Check the Status Indicator Panel to determine the presence and condition of the battery. See "Status Indicator Panel" on page 22. Install a charged battery or a Power adapter.
	The battery is installed but is faulty or very low.	When the battery reaches a critically low level, the system is forced into Sleep mode to avoid a total system power failure. To correct this problem, either connect an external power supply (such as the AC adapter), or install a charged battery in the Tablet PC.

Problem	Possible Cause	Possible Solutions
You turn on your Tablet PC and nothing seems to happen. (continued)	System is at a critical thermal limit.	To avoid damage to heat-sensitive components, the system enters sleep mode when it gets too hot. System operation cannot be resumed until the Tablet PC cools off to a tolerable temperature. Move the Tablet PC to a cooler location.
	AC power adapter is not plugged in properly.	Verify that your adapter is connected correctly. See "Power Sources" on page 37.
	The power adapter has no power from the AC or airline outlet.	Move the AC cord to a different outlet, or check for a line switch or tripped circuit breaker. If you are using an auto/airline adapter in a car be sure the ignition switch is in the On or Accessories position.
	The power adapter is faulty.	Try a different power adapter.
Your STYLISTIC Tablet PC turns off all by itself.	The power management parameters are set for auto timeouts which are too short for your operating needs.	Move the mouse to restore operation. If that fails, push Power/Suspend/Resume switch. Check your power management settings, or close your applications and go to Power Options located in the Control Panel to adjust timeouts to better suit your needs.
	Your power adapter has failed or lost its power source.	Make sure the adapter is plugged in and the outlet has power.
	You ignored a low battery alarm until the battery entered Dead Battery Suspend mode.	Install a power adapter, then push the Power/Suspend/Resume switch. See "Power Sources" on page 37.
	You have a battery failure.	Verify the condition of the battery using the Status Indicator panel. If the battery is shorted, replace or remove it. See "Status Indicator Panel" on page 22.
Your Tablet PC will not work on battery alone.	The installed battery is dead.	Replace the battery with a charged one or use an adapter.
	No battery is installed.	Install a charged battery.
	Battery is improperly installed.	Verify that the battery is properly connected by re-installing it.
	Your installed battery is faulty.	Verify the condition of the battery using the Status Indicator panel and replace or remove any batteries that are shorted. See "Status Indicator Panel" on page 22.

Problem	Possible Cause	Possible Solutions
The battery seems to discharge too quickly.	The power savings features may be disabled.	Check the Power Options menu settings and adjust according to your operating needs.
	The brightness is turned all the way up.	Turn down the brightness adjustment. The higher the brightness the more power your display uses.
	You're running an application that uses a lot of power due to frequent drive access, or use of wireless devices.	Use a power adapter for this application when at all possible.
	The battery is very old.	Replace the battery.
	The battery was exposed to high temperatures.	Replace the battery.
	The battery is too hot or too cold.	Restore the Tablet PC to normal operating temperature. Charging icon on the Status Indicator panel will flash when battery is outside of operating range.
Shutdown and Startup Problems		
The Suspend/Resume switch does not work.	Suspend/Resume switch is disabled.	To enable the button, go to Control Panel -> Power Options and click on the Advanced tab. In the Power buttons area, select the "Change what the power button does" option.
	There may be application software conflict	Close all applications and try the button again.
The system powers up and displays power on information, but fails to load the operating system.	You have a secured system requiring a password to load your operating system.	Make sure you have the right password. Enter the setup utility and verify the Security settings and modify them as accordingly. See "BIOS Setup Utility" on page 41.
	The boot sequence settings of the setup utility are not compatible with your configuration.	Set the operating source by pressing the [F12] key while the Fujitsu logo is on screen or use the [F2] key and enter the setup utility and adjust the source settings from the Boot menu. See "BIOS Setup Utility" on page 41.
	Hard drive was not detected.	Use BIOS setup utility to auto detect the internal hard drive.

Problem	Possible Cause	Possible Solutions
An error message is displayed on the screen during the boot sequence.	Power On Self Test (POST) has detected a problem.	See the Power On Self Test (POST) messages to determine the meaning and severity of the problem. Not all messages are errors; some are simply status indicators. See "Power On Self Test Messages" on page 62.
Your Tablet PC appears to change setup parameters when you start it.	BIOS setup changes were not saved when made and you exited the setup utility.	Make sure you select Save Changes And Exit when exiting the BIOS setup utility.
Video Problems		
The display is blank when you turn on your Tablet PC.	Power management timeouts are set for short intervals and you didn't see the display go on and off again.	Move the mouse to restore operation. If that fails, push the Power/Suspend/Resume switch. (The display may be shut off by Sleep mode, Auto Suspend or Video Timeout)
The Tablet PC turned on with a series of beeps and the display is blank.	Power On Self Test detected a failure which does not allow the display to operate.	Contact your support representative.
The display goes blank by itself after you have been using it.	Power management timeouts are set for short intervals and you failed to notice the display come on and go off again.	Push the Power/Suspend/Resume switch. (The display may be shut off by Sleep Mode, Auto Suspend or Video Timeout)
	The Tablet PC has gone into Sleep or Hibernate mode because you have not used it for a period of time.	Push Power/Suspend/Resume switch. Check power management settings, or close applications and go to the Power Savings menu of the setup utility to adjust timeout values to suit your needs. See "BIOS Setup Utility" on page 41.
The display has bright or dark spots.	If the spots are very tiny and few in number, this is normal for a large LCD display.	This is normal; do nothing.
	If the spots are numerous or large enough to interfere with your operation needs.	Display is faulty; contact your support representative.

Problem	Possible Cause	Possible Solutions
Miscellaneous Problems		
Error message displayed on the screen during operation of an application.	Application software often has its own set of error message displays.	See your application manual and help displays screens for more information. Not all messages are errors some may simply be status.

Power On Self Test Messages

The following is a list of error-and-status messages that the Phoenix BIOS and/or your operating system can generate and an explanation of each message. Error messages are marked with an *. If an error message is displayed that is not in this list, write it down and check the operating system documentation on screen and in the manual. If you can find no reference to the message, contact a support representative.

***Invalid NVRAM Data**

Problem with NVRAM access. In the unlikely case that you see this message you may have a display problem. You can continue operating but should contact your support representative for more information.

***Operating system not found**

Operating system cannot be located on either drive A: or drive C: Enter the setup utility and see if both the fixed disk, and drive A: are properly identified and that the boot sequence is set correctly. Unless you have changed your installation greatly, the operating system should be on drive C:. If the setup utility is correctly set, your hard drive may be corrupted.

***Real time clock error - Check date and time settings**

Real-time clock fails BIOS test. May require board repair. Contact your support representative.

Restoring Your System Image and Software

It is very important that you create DVD copies of your Factory Image and Bootable Disc before beginning to use your system. To do so, follow the instructions in the “Saving Your Factory Image” and “Creating Backup Images of Factory Image and Discs” sections of this chapter.

Saving and Recovering Your Factory and System Images

Along with instructions on saving your Factory Image, this document outlines several other important procedures, such as making a system image, restoring your Factory Image and system images, managing your images, and restoring the partitions on a hard drive.



- IN ORDER TO MAKE COPIES OF FACTORY AND SYSTEM IMAGES AND BURN BOOTABLE DISCS **YOU MUST HAVE AN INTERNAL OR EXTERNALLY CONNECTED WRITABLE DVD DRIVE.**
- IT IS EXTREMELY IMPORTANT THAT YOU COPY YOUR FACTORY IMAGE TO REMOVABLE MEDIA (E.G., DVD DISCS). FAILURE TO DO SO COULD RESULT IN AN INABILITY TO RESTORE THE IMAGE AT A FUTURE DATE.
- WE RECOMMEND THAT YOU USE DVD-R OR DVD+R DISCS FOR YOUR BACKUP, BUT SUPPORTED MEDIA* FOR IMAGE BACKUPS INCLUDE:
FOR FACTORY IMAGE, APPLICATION DATA, AND BOOTABLE DISC: DVD-R/+R.
FOR USER-CREATED BACKUP IMAGE: DVD-R/+R, DVD-RW/+RW, DVD-DL.

* DEPENDING UPON YOUR OPTICAL DRIVE AND MEDIA FORMAT USED, SOME MEDIA TYPES MAY BE INCOMPATIBLE FOR CREATING IMAGE BACKUPS.



DUE TO CERTAIN LICENSING REQUIREMENTS, SOME THIRD-PARTY APPLICATIONS WILL NEED TO BE INSTALLED SEPARATELY.

Saving your Factory Image

When you purchased your new system, a copy of the pre-installed Factory Image was loaded into a hidden partition on your hard disk drive. Having a copy of the original Factory Image available to you means that in the event of system failure, you will be able to restore it to its original state.

To make a copy of the Factory Image to DVD discs, you will need four or five blank discs (DVD-R or DVD+R discs are recommended) to create the copy. After creating the copy, be sure to label the discs and keep them in a safe place to ensure they do not get damaged.

Creating Backup Images of Factory Image and Bootable Disc

Using the [Manage/Change] button, you can create backup images of the Factory Image and/or Bootable Disc.



ALL USER-CREATED DATA WILL BE DELETED FROM YOUR SYSTEM WHEN THE FACTORY IMAGE IS RESTORED.

- 1 Launch **System Backup and Restore** from the desktop icon and click [Yes] on the **User Account Control** dialog.
- 2 Click [Next] on the **Backup Your Data** screen.
- 3 Select the [Manage/Create] tab, then click [Make Recovery Disc set] to burn your factory image to DVD.
- 4 On "Step 1: Please select a media type for Recovery Disc" screen select **Media Type** from the drop down box, then click [Next]. (Note: This screen shows the number of discs required for backup.)
- 5 On "Step 2: Confirm your Recovery Disc" both the Bootable Disc and Recovery disks are selected by default under "List of Recovery Discs". When the backup is created for the first time, these options should stay selected. Click [Next].
- 6 Click [OK] on the "Attention about media" confirmation screen.



DURING THE FOLLOWING PROCESS, YOU SHOULD CONNECT AN AC ADAPTER SINCE THE PROCESS MAY TAKE A LONG TIME.

- 7 Click [Start] on "Step 3: Making Recovery Disc" .
- 8 The process will prompt you to insert your discs.
- 9 Once the process completes successfully, click [Finish] on "Step 4: Making Recovery Disc process has been completed" screen.

Recovering Your Factory Image.

In the event you need to restore your original Factory Image, perform the following steps.



ALL USER-CREATED DATA WILL BE DELETED FROM YOUR SYSTEM WHEN THE FACTORY IMAGE IS RESTORED.

In order to recover your Factory Image, perform the steps outlined in "Running Recovery and Utility from hard disk".

Backing Up a System Image

Optional Step: Launch the Fujitsu Bonus Apps utility from your desktop, and select the components you wish to install. (Alternatively, you can access Bonus Apps by opening Charms panel from Modern Start screen and searching for "Fujitsu BonusApps".)

User-Configured System Backups: On your desktop, there is a **[System Backup and Restore]** icon that allows you to make backups of your current system image either to another location on your hard drive or on removable media. A system image is the configuration of your C: drive at a particular point of time. You may want to make system image backups occasionally in order to have points to which you can return without having to go all the way back to the Factory Image.



By default, system images are saved in the D: drive in the System Backup and Restore folder. You can also elect to save the image to an external hard drive.

- 1 Launch **System Backup and Restore** from the desktop icon and click [Yes] on **User Account Control** dialog
- 2 Click [Next] on **Backup Your Data** screen
- 3 Select the [Backup] tab on **System Backup and Restore** screen.
- 4 Click the [Backup User System] button.

- 5 On the “Step 1: Select a backup destination” screen select your destination drive. By default the Destination is set to D: drive. You can also select the [Other drive] option to back up to an external drive. Select whether you would like the system to [Shutdown] or [Restart] after the process is completed.
- 6 On the “Step 2: Name your backup images” screen that appears, you can enter up to 300 characters of information about the backup file. This information will help you to identify the image at a later date.
- 7 On “Step 3: Backup the entire C: drive image” verify your backup settings and click [Next].
- 8 Click [OK] on “Step 4: Please confirm the following before starting your backup” to restart you computer and begin backup.
- 9 After backup completes and the system restarts, “Step 5: Backup Completed. Confirm the results” screen should appear on your desktop confirming that backup image has been created successfully. Click [Close] to close System Backup and Restore dialog.
- 10 Click [OK] to quit the System Backup and Restore utility.

Managing Your Backup Images

With the System Backup and Restore tool you can also make copies of backup images, archive them on DVD, or delete them from your hard drive.

- 1 Launch **System Backup and Restore** from the desktop icon and click [Yes] on **User Account Control** dialog.
- 2 Click [Next] on the **Backup Your Data** screen.
- 3 Select the [Create/Manage] tab and click on [Manage User System Backup].
- 4 In the next window there are three options allowing you to [Copy], [Delete], or [Add Comment] to your images. Click the action button you would like to perform:

Selecting [Copy] option (Note that you must have an external disk drive connected for the [Copy] button to work, otherwise an attempt to copy will result in an error.)

- a. On “Step 1: Select a backup file that you wish to copy”, select the location of a backup file. A list of backup files will appear. Select the file you wish to copy from the list and click [Next].

- b. On "Step 2: Select a drive to copy a backup file", select the destination drive and click [Next].
- c. On "Step 3: Start to copy the following information" confirm the information and click [Start].
- d. "Step 4: Processing backup data copying" screen displays the progress bar.
- e. Click [Finish] on "Step 5: Copy completed. Confirm the results" screen.

Selecting "Delete" option

- a. On "Step 1: Please select your target data" screen select location of a backup file. A list of backup files will appear. Select the file(s) you wish to delete and click [Next].
- b. Click [Start] on "Step 2: Delete backup data" screen.
- c. Click [OK] to the confirmation message.
- d. Click [Finish] on "Step 4: Delete process has been completed" screen.

Selecting "Add Comment" option

- a. On the "Step 1: Select target data" screen select location of a backup file. A list of backup files will appear. Select the file you wish to add comments to and click [Next].
- b. On the "Step 2: Add comment" screen, type in a maximum of 300 characters in "Comment" text area and click [Add].
- c. Click [Finish] on the "Step 3: Adding comment has been completed" screen.

Restoring your backup images

- 1 Launch **System Backup and Restore** from the desktop icon and click [Yes] on the **User Account Control** dialog
- 2 Click [Next] on the **Backup Your Data** screen
- 3 Select the Restore tab and click on "Restore User System Backup"
- 4 On "Step 1: Please confirm the following before starting restore process", confirm information and click [OK]. The system will restart to begin restoring your backup.

- 5 After the system restarts, the “Explanation about Restore User System Backup” screen is shown. Once you read the EULA, select [Agree] choice and click [Next].
- 6 Select an image to restore from the Backup data list and click [Next]
- 7 Click [Start] on “Confirm before restoration” screen
- 8 Once restoration finishes, click [Close] in “Finished restoration” screen, the computer will restart to Windows.

Using the Recovery and Utility Tools

The Recovery and Utility tools consist of a variety of tools that will help you recover your Factory Image, recover system images, and delete the data from your hard disk.

Methods for accessing the utilities

Recovery and Utility Tools are preinstalled in a hidden partition by the factory, or they can be accessed by using the bootable disc. Please note that you can delete Recovery and Utility tools from your hard disk drive if you modify the partitions. In this case you will not be able to use the hidden partition for booting to Recovery and Utility Tools, but you will still be able to boot from the Bootable Disc.

Determining whether Recovery and Utility is pre-loaded

- 1 Turn on or reboot your system. When the Fujitsu logo appears, press [F12] key.
- 2 From the Boot Menu that appears, check whether the <Recovery and Utility> option is present. If it is not present, it means that the utility must be used from the disc. Proceed to “Running Recovery and Utility from the Bootable Disc” if <Recovery and Utility> is unavailable.

Running Recovery and Utility from hard disk

- 1 Turn on or reboot your system. When the Fujitsu logo appears, press the [F12] key.
- 2 Cursor down to <Recovery and Utility> and press the [Enter] key.
- 3 Choose your Language (English or French).
- 4 Three tool options appear: Diagnostics, Recovery and Utility (Please see Recovery and Utility tools section below for instructions on how to use these tools).

Running Recovery and Utility from the Bootable disc

To verify/change the boot-up priority (rather than booting-up from the hard drive or an external floppy disk drive), perform the following steps:

- 1 Power on your system. When the Fujitsu logo appears on the screen. press the [F12] key.
- 2 Highlight the **CD/DVD** option from the Boot menu, then press [Enter].
- 3 Insert the bootable disc into the drive tray.
- 4 Click [OK].
- 5 Select CD/DVD boot mode: UEFI Mode) and press [Enter]. While the files are being loaded from the disc, the Fujitsu logo screen will appear followed by a progress bar screen at the bottom of the screen.

Recovery and Utility tools

Diagnostics tool: The Diagnostics tool is designed for use by IT professionals. It is not likely you will need to use this tool. If you should need to use this tool, perform the following steps:

- 1 Press the "Diagnostics Tool" button to start the Diagnostics tool. A progress bar appears while the Diagnostics tool is starting up.
- 2 Read the note, then click [OK].
- 3 Choose one or more of the following options for diagnostics on the "Fujitsu Hardware Diagnostics Tool window": CPU, Memory, Display, Hard Disk, CD/DVD/BD, Floppy Disk, Keyboard, and Mouse. Click the [Option] button to specify how many times the tool should run diagnostics on each selected component. Press [Execute] to start the Diagnostics tool.
- 4 After the execution is completed, the selected components are circled in red to indicated that they have been diagnosed and the result dialog window is opened.
- 5 Click [End] to close the Diagnostics tool, then click [Yes] to confirm the end of diagnostics session.

Recovery tool: The Recovery tool contains three options. **User System Backups:** Recovering C: Drive from D: Drive or external storage device), **Restore C: Drive:** Restore factory image (only C: drive), and **Restore Full Hard Drive:**

Restore factory image (full hard drive). You can use these tools to restore the Factory Image from the hidden partition, restore backup image(s) created by you or images stored on DVD discs, and perform a full hard drive recovery. Please refer to instructions above for details on how to create Factory Image Recovery DVDs, user backup DVDs and system image backup.

To recover from D: drive or external storage device:

- 1 Click [User System Backups]
- 2 The progress bar screen is followed by EULA screen. Click [Agree] to accept the EULA.
- 3 On "Select an image to restore" screen select the image to restore from the list of images and click [Next].
- 4 Click [Start] on the "Confirm before restoration" screen to begin the restoration process.
- 5 Once restoration finishes, click [Close] in the "Finished restoration" screen; the computer will restart to Windows.

To restore from the Factory Image (hidden partition):

- 1 Click [Restore C: drive].
- 2 The progress bar screen is followed by "Restore Factory Image (only C: drive) screen confirming that the Factory Image will be restored to the C: drive and D: drive data will remain. Click [Next].
- 3 Read the instruction screen and select [Agree], then [Next].
- 4 Click [OK] to the warning message to restore factory image to the C: drive.
- 5 When the progress bar screen, wait for the process to complete.
- 6 Click [Finish] when the process completes; the computer will restart to Windows.

To restore full hard drive:

Follow the steps in section "**Recovering your Factory Image using Recovery and Utility (for new hard drive or non-bootable hard drive)**"

Utility tool: The Utility tool contains two options: Hard Disk Data Delete and Partition Creation.

- The **Hard Disk Data Delete** utility is used to delete all data on the hard disk and prevent the data from being reused. **NOTE: Do not use the Hard Disk Data Delete utility unless you are absolutely certain that you want to erase your entire hard disk, including all partitions.**

To delete hard disk data:

- a. Click the [Hard Disk Data Delete] button
 - b. The progress bar appears, followed by the EULA screen.
 - c. Agree to the EULA and click [Next].
 - d. Choose the hard disk from which the data should be deleted in the list of hard disks and click [Next].
- The **Partition Creation** utility is used to change the C: and D: drive partition sizes. To run this utility:
 - a. Click the [Partition Creation] button.
 - b. A progress bar screen appears, followed by the EULA screen. Agree to the EULA.
 - c. On the **Recovery Tool - Partition Creation** screen move the slider to set disk size, then click [OK].
 - d. Click YES in the Partition Creation confirmation dialog.

Recovering your Factory Image using Recovery and Utility (for new hard drive or non-bootable hard drive)

If you have installed a new hard drive or your hard drive is not bootable, perform the following steps.

- 1 Power on your system. When the Fujitsu logo appears on the screen, press the [Enter] key.
- 2 Highlight the **CD/DVD** option from the Boot Menu and press [Enter].
- 3 Insert the bootable disc in your DVD drive, then click [OK].
- 4 Select CD/DVD boot mode: UEFI Mode and press [Enter]. While the files are being loaded from the disc, Fujitsu logo screen will appear followed by a progress bar screen at the bottom of the screen.
- 5 Choose your language ([English or French]).
- 6 Three tool options appear: Diagnostics, Recovery and Utility. Select [Recovery].

- 7 Select [Restore full hard drive].
- 8 Click [Next] to confirm full hard drive restoration. (All data on HDD will be deleted).
- 9 Agree to EULA by selecting [Agree] option and clicking [Next].
- 10 Click [Next] on the Recovery Disk Check screen to verify that the bootable disk has been inserted into the optical drive.
- 11 The Checking for Recovery Disk screen appears followed by the prompt to insert the first disk. Click [OK] to continue. Repeat this step for all disks. After all recovery disks have been checked and the check has been completed, click [Next]
- 12 Reinsert the first recovery disk and click [Next]
- 13 Click [OK] when you receive the final warning informing you that all data on drives C: and D: will be lost. This starts the recovery process.
- 14 Follow the prompts to insert the next recovery disks and click [OK].
- 15 After the copying of the factory image to the HDD completes and the factory image is restored, follow the prompt to insert bootable disk.
- 16 After the restore process is complete, click [Finish] to restart the system. The computer will restart automatically and then go through the first boot process.

Downloading Driver Updates

The Fujitsu Software Download Manager (FSDM) utility is available to allow you to download the latest drivers, utilities, and applications from the Fujitsu Support site. If you have a Windows 8 or Windows 7 operating system, you will need to go to the Support Site (<http://support.fujitsupc.com/CS/Portal/support.do?srch=DOWNLOADS>).

Chapter 5

Care and Maintenance

Caring for your Tablet PC

If you use your STYLISTIC Tablet PC carefully, you will increase its life and reliability. This section provides some tips for looking after the Tablet PC and its devices.

THE SYSTEM CONTAINS COMPONENTS THAT CAN BE SEVERELY DAMAGED BY ELECTROSTATIC DISCHARGE (ESD). TO MINIMIZE RISK TO THE COMPONENTS, OBSERVE THE FOLLOWING PRECAUTIONS:



- IF YOU DROP YOUR TABLET PC OR DAMAGE THE HOUSING IN ANY WAY, IMMEDIATELY TURN OFF POWER AND DISCONNECT THE POWER PLUG. FAILURE TO DO SO COULD RESULT IN A SHORT CIRCUIT, SMOKE, AND/OR FIRE. CONTACT FUJITSU SERVICE AND SUPPORT BY PHONE AT 1-800-8FUJITSU (1-800-838-5487), BY EMAIL AT 8FUJITSU@US.FUJITSU.COM, OR THROUGH THE WEBSITE AT [HTTP://WWW.COMPUTERS.US.FUJITSU.COM/SUPPORT](http://www.computers.us.fujitsu.com/support) TO LEARN HOW TO GET THE SYSTEM REPAIRED.
- BEFORE DOCKING OR UNDOCKING YOUR TABLET PC (WHEN USING A DOCKING CRADLE), IT IS GOOD PRACTICE TO TOUCH A GROUNDED METAL OBJECT TO DISCHARGE STATIC ELECTRICITY IN YOUR BODY.
- ELECTRICAL EQUIPMENT MAY BE HAZARDOUS IF MISUSED. OPERATIONS OF THIS PRODUCT OR SIMILAR PRODUCTS, MUST ALWAYS BE SUPERVISED BY AN ADULT. DO NOT ALLOW CHILDREN ACCESS TO THE INTERIOR OF ANY ELECTRICAL PRODUCTS AND DO NOT PERMIT THEM TO HANDLE ANY CABLES.

- Your STYLISTIC is a durable but sensitive electronic device. Treat it with respect and care.
- Make a habit of transporting it in a suitable carrying case.
- Do not attempt to service the computer yourself. Always follow installation instructions closely.
- Keep it away from food and beverages.

- If you accidentally spill liquid on your STYLISTIC Tablet PC:
 - 1 Turn it off.
 - 2 Position it so that the liquid can run out and let it dry out for 24 hours, or longer if needed.
 - 3 If your Tablet PC will not boot after it has dried out, call your support representative.
- Do not use your Tablet PC in a wet environment (near a bathtub, swimming pool).
- Always use the AC adapter and batteries that are approved for your Tablet PC.
- Avoid exposure to sand, dust and other environmental hazards.
- Do not expose your Tablet PC to direct sunlight for long periods of time as temperatures above 140° F (60° C) may damage your Tablet PC.
- Do not put heavy or sharp objects on the computer.

Cleaning your Tablet PC

General instructions

Always shut down the computer, unplug the power adapter, and remove the battery when cleaning or disinfecting the computer exterior, keyboard or LCD display.

Cleaning guidelines using recommended off-the-shelf cleaners

Computer exterior, computer keyboard

To clean the exterior and keyboard, use one of the following off-the-shelf products only:

- Office Depot® #154-616 Notebook Cleaning Kit
- Meridrew Enterprises Klear_Screen® Wipes
- 3M CL563 Cleaner Wipes

Note: After cleaning with one of these products, gently polish with a dry, soft, lint-free cloth until the solution is no longer visible.

LCD display, fingerprint sensor*

To clean the LCD display or fingerprint sensor, use one of the following off-the-shelf products only:

- Office Depot® #154-616 Notebook Cleaning Kit
- Meridrew Enterprises Klear_Screen® Wipes

* Applies to Tablet PC, convertible PC with LCD shield, and standard notebook LCD displays.

Note: Wipe the LCD surface gently, allowing it to dry before turning on the computer.

Disinfecting guidelines using recommended off-the-shelf disinfectants

To disinfect the Tablet PC, use one of the following off-the-shelf products only:

- Veridien® ViraGuard Hospital Disinfectant
- Veridien® ViraGuard Disinfectant Wipes

1 Disinfect the surface with a soft cloth which has been lightly dampened with the solution. Allow the surface to dry before turning on the computer.

OR

2 Wipe the surface with a soft cloth wipe and a 50% ethanol solution or use another ethanol-based germicide which has been registered as a hospital disinfectant by the EPA .



- USE OF INCORRECT CLEANERS CAN RESULT IN OPTICAL IMPAIRMENT OF THE LCD AND/OR DAMAGE TO THE COMPUTER. ALWAYS REFER TO THE CLEANER MANUFACTURER'S GUIDELINES AND MATERIAL SAFETY DATA SHEETS FOR PROPER HANDLING AND USE OF THE PRODUCTS.
- NEVER USE AMMONIA, ACIDIC, OR ALKALINE CLEANERS OR ORGANIC CHEMICALS SUCH AS PAINT THINNER, ACETONE, PROPYL OR ISOPROPYL ALCOHOL, OR KEROSENE. IT MAY DAMAGE SURFACE FINISHES AND THE COATING OF THE LCD SCREEN.
- NEVER USE COMPRESSED AIR FOR CLEANING YOUR COMPUTER.

Storing your Tablet PC

- If storing your Tablet PC for a month or longer, turn it off, fully charge the battery, then remove and store all Lithium Polymer batteries.
- Store your Fujitsu STYLISTIC in a cool, dry location. Temperatures should remain between 13°F (-25°C) and 140°F (60°C).
- Store your tablet and batteries separately. If you store your system with a battery installed, the battery will discharge, and battery life will be reduced. In addition, a faulty battery might damage your system.







- ALWAYS POWER OFF THE COMPUTER BEFORE TRANSPORTING AND/OR PACKAGING IT. AFTER SHUTTING DOWN THE SYSTEM, WAIT UNTIL THE STATUS LED PANEL INDICATES POWER OFF CONDITION (I.E., NO LIGHTS ARE ILLUMINATED).
- IT IS POSSIBLE THAT THE UNIT MAY NOT AUTOMATICALLY GO TO POWER OFF OR HIBERNATE MODE WHEN YOU CLOSE THE LID. THIS SITUATION MAY OCCUR DUE TO PRE-OS BOOT PASSWORD SECURITY SETTINGS OR SOME OTHER APPLICATION RUNNING ON THE COMPUTER.
- ATTEMPTING TO TRANSPORT THE COMPUTER WHILE POWER IS ON MAY DAMAGE THE TABLET PC DUE TO SHOCK OR OVERHEATING.

Traveling with your Tablet PC

- Do not transport your Tablet PC while it is turned on.
- You should carry your Tablet PC with you while traveling, rather than checking it in as baggage.
- Never put your Tablet PC through a metal detector; have it hand-inspected by security personnel. You can however, put your Tablet PC through a properly tuned X-ray machine. To avoid problems, place it close to the entrance of the machine and remove it as soon as possible or have it hand-inspected by security personnel. Security officials may require you to turn your system on, so make sure you have a charged battery on hand.

- Take the necessary plug adapters if you're traveling overseas. Check the following diagram to determine which plug adapter you'll need or ask your travel agent.

Outlet Type	Location	Outlet Type	Location
 	United States, Canada, parts of Latin America, Mexico, Japan, Korea, the Philippines, Taiwan		United Kingdom, Ireland, Malaysia, Singapore, parts of Africa
	Russia and the Commonwealth of Independent States (CIS), most of Europe, parts of Latin America, the Middle East, parts of Africa, Hong Kong, India, most of South Asia		China, Australia, New Zealand

Batteries

Caring for your Battery

- Always handle batteries carefully.
- Do not short-circuit the battery terminals (that is, do not touch both terminals with a metal object). Do not carry loose batteries in a pocket or purse where they may mix with coins, keys, or other metal objects. Doing so may cause an explosion or fire.
- Do not drop, puncture, disassemble, mutilate or incinerate the battery.
- Recharge batteries only as described in this manual and only in ventilated areas.
- Do not leave batteries in hot locations for more than a day or two. Intense heat can shorten the life of your battery.
- Do not leave a battery in storage for longer than 6 months without recharging it.

Increasing Battery Life

- Power your Tablet PC through the AC or optional auto/airline adapter whenever possible.
- If your tablet runs on battery power all day, connect it to an AC adapter overnight to recharge it.

- Keep brightness to the lowest level comfortable.
- Set the power management for maximum battery life.
- Put your Tablet PC in Sleep mode when it is turned on and you are not actually using it.
- Limit your media drive access.
- Disable the Media Player auto insert notification function.

Media Care

Caring for your Media (when optional external optical drive is installed)

Media discs are precision devices and will function reliably if given reasonable care.

- Always store your media disc in its case when it is not in use.
- Always handle discs by the edges and avoid touching the surface.
- Avoid storing any media discs in extreme temperatures.
- Do not bend or scratch media discs or set heavy objects on them.
- Do not spill liquids or get dust on media discs.
- Never write on the label surface with a ballpoint pen or pencil. Always use a felt pen.
- If a disc is dirty, use only a DVD/CD cleaner or wipe it with a clean, soft, lint free cloth starting from the inner edge and wiping to the outer edge.
- If a disc is subjected to a sudden change in temperature, condensation may form on the surface. Wipe moisture off with a soft, lint free cloth and let it dry at room temperature. DO NOT use a hair dryer or heater to dry media discs.

Caring for an Optional Optical Drive

An optional optical drive is durable but you must treat it with care. Please pay attention to the following points:

- The drive rotates the compact disc at a very high speed. Do not carry it around or subject it to shock or vibration with the power on.
- Avoid using or storing the drive where it will be exposed to extreme temperatures.
- Avoid using or storing the drive where it is damp or dusty.
- Avoid using or storing the drive near magnets or devices that generate strong magnetic fields.

- Avoid using or storing the drive where it will be subjected to shock or vibration.
- Do not disassemble or dismantle the optical drive.
- Use of a commercially available lens cleaner is recommended for maintenance of your drive.

Secure Digital Cards

Caring for your Cards

Secure Digital Cards are durable, but you must treat them with care. The documentation supplied with your card will provide specific information, but you should pay attention to the following points:

- To keep out dust and dirt, store cards in their protective sleeves when they are not installed.
- Avoid prolonged exposure to direct sunlight or excessive heat.
- Keep the cards dry.
- Do not flex or bend the cards, and do not place heavy objects on top of them.
- Do not force cards into the slot.
- Avoid dropping cards, or subjecting them to excessive vibration.

Chapter 6

System Specifications

Specifications

This section provides the hardware and environmental specifications for your Fujitsu STYLISTIC Tablet PC. Specifications of particular configurations will vary.

Microprocessor

AMD Z60 APU (with AMD Radeon™ HD 6250 Graphics)

Chipset

- AMD A68M FCH

Memory

System Memory

- DDR3-1066 MHz SDRAM memory module
- Fixed 4GB of total memory depending upon configuration

Cache Memory

1MB L2 cache on-die

Video

Video Color and Resolution

Anti-glare 10.1" HD LED backlit IPS display

- Internal: 1366 x 768 pixel resolution, 16M colors
- HDMI: 1920 x 1080 pixel resolution, 16M colors
- Simultaneous: 1366 x 768, 16M colors
- 160° vertical and horizontal viewing angles

Digitizer

N-trig® DuoSense® technology. Dual Digitizer, consisting of active digitizer and capacitive touch panel (uses active stylus input and up to 10 finger touch input).

Video RAM

AMD Radeon™ HD 6250 graphics

Win8/Win7 (32bit): max 1908MB (HyperMemory) when the main memory is 4GB

Win8/Win7 (64bit): max 1964MB (HyperMemory) when the main memory is 4GB

Audio

- Realtek codec ALC269
- **Headphones:** Stereo headphone jack, 3.5 mm, 1 V_{rms} or less, minimum impedance 32 Ohms
- Two built-in stereo speakers
- Two built-in dual analog microphones

Mass Storage Device Options

Hard Drive Options

- FDE Solid State Drive, S-ATA/300 (3.0Gbps), 64 GB, with TRIM command support
- FDE Solid State Drive, S-ATA/300 (3.0Gbps), 128 GB, with TRIM command support
- Solid State Drive, S-ATA/300 (3.0Gbps), 256 GB, with TRIM command support

Communications

- **WLAN:** Ralink RT3572 802.11a/b/g/n Wireless LAN USB Device
- **Bluetooth:** Broadcom BCM20702 Bluetooth USB device for wireless personal area network communication
- **WWAN:** Optional integrated 3G Wireless Wide Area Network, Gobi3000 (Sierra Wireless AirPrime™ MC8355)

Security Features

Trusted Platform Module

The STYLISTIC Q572 Tablet PC may have an optional Trusted Platform Module (TPM) installed for added system security.

Fingerprint Recognition Sensor

Swipe sensor for biometric security.

SmartCard Slot

Integrated SmartCard slot (requires third-party application)

Device Ports

On the STYLISTIC Tablet PC:

- SD Card slot
- Two USB 2.0 (Universal Serial Bus) connectors for input/output devices
- One DC In connector
- One HDMI connector
- Docking port (40-pin, to dock with optional STYLISTIC Docking Cradle)
- One stereo headphone jack
- 5.0 megapixel auto-focus rear-facing web camera, HD (1240 x 720 pixel) front-facing web camera

On the Optional STYLISTIC Docking Cradle

- Three USB 2.0 connectors for input/output devices
- One Ethernet LAN connector

- One DC-in connector
- One docking connector (40-pin, to dock with Tablet PC)

Power

Battery

Lithium Polymer Battery, 2 cells, 7.2V, 36Wh, 5000 mAh

AC Adapter

Autosensing 100-240V AC, supplying 19V DC, 3.16A, 60W to the Tablet PC; includes an AC cable

Power Management

Conforms to ACPI (Advanced Configuration and Power Interface).

Dimensions and Weight

Overall Dimensions

Approximately 10.76" (w) x 6.93" (d) x 0.54" (h) (273.5 x 176 x 13.6 mm)

Weight

Approximately 1.65 lb. (748g)

Environmental Requirements

Temperature

Operating: 41° to 95° F (5° to 35° C). Non-operating: 5° to 140° F (-15° to 60° C)

Humidity

Operating: 20% to 85%, relative, non-condensing. Non-operating: 8% to 85%, relative, non-condensing

Altitude

Operating: 10,000 feet (3,048 m) maximum

Popular Accessories

For ordering or additional information on Fujitsu accessories please visit our Web site at www.shopfujitsu.com or call 1-800-FUJITSU.

Included Software

Depending on your pre-installed operating system, your Tablet PC comes with software for playing audio and video files of various formats. In addition there is virus protection software and Power Management software. The following list indicates the software included with your system.

- Adobe® Reader
- Norton Studio
- Skype
- OmniPass® Fingerprint application

Learning About Your Software

Tutorials

All operating systems and most application software have tutorials built into them upon installation. We highly recommend that you step through the tutorial before you use an application.

Manuals

Included with your Tablet PC you will find manuals for your installed operating system and other pre-installed software. Any manuals that are not included, are available online through the help system of the software. We recommend that you review these manuals for general information on the use of these applications.

Adobe Reader

The Adobe Reader allows you to view, navigate, and print PDF files from across all of the major computing platforms.

Norton Studio

Easily manage your Norton™ protection for your PCs and other devices right from your Windows® 8 tile interface desktop. Designed and optimized for Windows 8 tile interface, Norton Studio lets you view, control, fix, update, and renew all your Norton protection products from a single screen.

OmniPass® Fingerprint application

The fingerprint sensor uses Softex OmniPass which provides password management capabilities to Microsoft Windows operating systems. OmniPass lets you use a "master password" for all Windows, applications, and on-line passwords, and presents a convenient user interface through which you can securely manage passwords, users, and multiple identities for each user.

Skype

Skype allows users to communicate with peers by voice, video, and instant messaging over the Internet. Skype can be used to place phone calls on traditional telephone networks. Calls to other users within Skype are free, while calls to landlines and cell phones are charged via a user account system. Skype is also a popular tool for file transfer and teleconferencing.

Operating System

The following operating system configuration is installed on your system:

Microsoft Windows 8 Professional Edition

Regulatory Information

Notice

Changes or modifications not expressly approved by Fujitsu could void this user's authority to operate the equipment.

FCC NOTICES

Notice to Users of Radios and Television

This equipment has been tested and found to comply with the limit for class B digital devices, pursuant to parts 15 of the FCC Rules.

These limits are designed to provide reasonable protection against harmful interference in a residential installation. This equipment generates, uses, and can radiate radio frequency energy and, if not installed and used in accordance with the instructions, may cause harmful interference to radio communications. However, there is no guarantee that interference will not occur in a particular installation. If this equipment does cause harmful interference to radio or television reception, which can be determined by turning the equipment off and on, the user is encouraged to try to correct the interference by one or more of the following measures:

- Reorient or relocate the receiving antenna.
- Increase the separation between the equipment and receiver.
- Connect the equipment into an outlet that is on a different circuit than the receiver.
- Consult the dealer or an experienced radio/TV technician for help.

Shielded interconnect cables must be employed with this equipment to ensure compliance with the pertinent RF emission limits governing this device.

DOC (INDUSTRY CANADA) NOTICES

Notice to Users of Radios and Television

This Class B digital apparatus meets all requirements of Canadian Interference-Causing Equipment Regulations.

CET appareil numérique de la class B respecte toutes les exigence du Règlement sur le matériel brouilleur du Canada.



Appendix A: WLAN User's Guide



FCC Regulatory Information

Please note the following regulatory information related to the optional wireless LAN device.

Regulatory Notes and Statements

Wireless LAN, Health and Authorization for use

Radio frequency electromagnetic energy is emitted from Wireless LAN devices. The energy levels of these emissions, however, are far much less than the electromagnetic energy emissions from wireless devices such as mobile phones. Wireless LAN devices are safe for use by consumers because they operate within the guidelines found in radio frequency safety standards and recommendations. The use of Wireless LAN devices may be restricted in some situations or environments, such as:

- On board an airplane, or
- In an explosive environment, or
- In situations where the interference risk to other devices or services is perceived or identified as harmful.

In cases in which the policy regarding use of Wireless LAN devices in specific environments is not clear (e.g., airports, hospitals, chemical/oil/gas industrial plants, private buildings), obtain authorization to use these devices prior to operating the equipment.



THE PRODUCT ID LABEL IS LOCATED IN THE BATTERY COMPARTMENT. THE LABEL CAN BE SEEN BY REMOVING THE BATTERY AS PER INSTRUCTIONS ON PAGE 50.

L'ÉTIQUETTE D'IDENTIFICATION DU PRODUIT EST SITUÉE DANS LE COMPARTIMENT DE LA BATTERIE. POUR VOIR L'ÉTIQUETTE, RETIREZ LA BATTERIE CONFORMÉMENT AUX INSTRUCTIONS DE LA PAGE 50.

Regulatory Information/Disclaimers

Installation and use of this Wireless LAN device must be in strict accordance with the instructions included in the user documentation provided with the product. Any changes or modifications made to this device that are not expressly approved by the manufacturer may void the user's authority to operate the equipment. The manufacturer is not responsible for any radio or television interference caused by unauthorized modification of this device, or the substitution or attachment of connecting cables and equipment other than those specified by the manufacturer. It is the responsibility of the user to correct any interference caused by such unauthorized modification, substitution or attachment. The manufacturer and its authorized resellers or distributors will assume no liability for any damage or violation of government regulations arising from failure to comply with these guidelines.

This device must not be co-located or operated in conjunction with any other antenna or transmitter.

For IEEE 802.11a Wireless LAN: For operation within 5.15~5.25 GHz frequency range, it is restricted to indoor environments, and the antenna of this device must be integral.

Federal Communications Commission and Industry Canada statement:

This device complies with Part 15 of FCC Rules and Industry Canada license-exempt RSS standard(s).

Operation is subject to the following two conditions: (1) This device may not cause interference, and, (2) This device must accept any interference, including interference that may cause undesired operation of this device.

Déclaration d'Industrie Canada

Cet appareil est conforme à la Section 15 des Règles de la FCC et à la (aux) norme(s) RSS concernant les appareils exempts de licence par Industrie Canada. Son fonctionnement est soumis aux deux conditions suivantes : (1) cet appareil ne doit pas causer d'interférence nuisible; (2) cet appareil doit accepter toutes les interférences reçues, y compris celles pouvant causer un mauvais fonctionnement de l'appareil.

FCC Interference Statement

This equipment has been tested and found to comply with the limits for a Class B digital device, pursuant to Part 15 of the FCC Rules. These limits are designed to provide reasonable protection against harmful interference in a residential installation. This equipment generates, uses, and can radiate radio frequency energy. If not installed and used in accordance with the instructions, it may cause harmful interference to radio communications. However, there is no guarantee that interference will not occur in a particular installation.

If this equipment does cause harmful interference to radio or television reception, which can be determined by turning the equipment off and on, the user is encouraged to try and correct the interference by one or more of the following measures:

- 1** Reorient or relocate the receiving antenna.
- 2** Increase the distance between the equipment and the receiver.

- 3 Connect the equipment to an outlet on a circuit different from the one the receiver is connected to.
- 4 Consult the dealer or an experienced radio/TV technician for help.

FCC/IC Radio Frequency Exposure statement

The available scientific evidence does not show that any health problems are associated with using low power wireless devices. There is no proof, however, that these low power wireless devices are absolutely safe. Low power wireless devices emit low levels of radio frequency energy (RF) in the microwave range while being used. Whereas high levels of RF can produce health effects (by heating tissue), exposure to low-level RF that does not produce heating effects causes no known adverse health effects. Many studies of low-level RF exposure have not found any biological effects. Some studies have suggested that some biological effects might occur, but such findings have not been confirmed by additional research.

The wireless LAN radio device has been tested and found to comply with FCC radiation exposure limits set forth for an uncontrolled equipment and meets the FCC radio frequency (RF) Exposure Guidelines in Supplement C to OET65.

The exposure standard for wireless devices employs a unit of measurement known as the Specific Absorption Rate, or SAR. The SAR limit set by the FCC is 1.6W/kg, and 1.6W/kg by Industry Canada.

This device is compliance with SAR for general population /uncontrolled exposure limits in ANSI/IEEE C95.1-1992 and Canada RSS 102, and had been tested in accordance with the measurement methods and procedures specified in OET Bulletin 65 Supplement C, and Canada RSS 102. This device has been tested, and meets the FCC, IC RF exposure guidelines when tested with the device directly contacted to the body.

Déclaration de la FCC/d'Industrie Canada sur l'exposition aux radiofréquences

La norme régissant l'exposition des appareils sans fil aux radiofréquences emploie une unité de mesure dénommée Taux d'absorption spécifique, ou TAS. La FCC et Industrie Canada ont défini la même limite de TAS : 1,6 W/kg.

Cet appareil est conforme au TAS pour les limites d'exposition générales de la population/non contrôlées définies par les règles C95.1-1992 de l'ANSI/IEEE et RSS 102 d'Industrie Canada ; il a été testé en conformité avec les méthodes et procédures de mesure spécifiées dans le supplément C du bulletin 65 de l'OET (Office d'ingénierie et de technologie) et la règle RSS 102 d'Industrie Canada. Cet appareil a été testé selon les directives de la FCC et d'IC concernant l'exposition aux radiofréquences et s'est révélé conforme à ces dernières lorsqu'il a été testé en contact direct avec le corps.

Export restrictions

This product or software contains encryption code which may not be exported or transferred from the US or Canada without an approved US Department of Commerce export license. This device complies with Part 15 of FCC Rules., as well as ICES 003 B / NMB 003 B. Operation is subject to the following two conditions: (1) this device may not cause harmful interference, and (2) this device must accept any interference received, including interference that may cause undesirable operation. Modifications not expressly authorized by Fujitsu America, Inc. may invalidate the user's right to operate this equipment.

Canadian Notice

The device for the 5150 - 5250 MHz band is only for indoor usage to reduce the potential for harmful interference to co-channel mobile satellite systems.

The maximum antenna gain of 6 dBi permitted (for devices in the 5250 - 5350 MHz, 5470 - 5725 MHz and 5725 - 5825 MHz bands) to comply with the e.i.r.p. limit as stated in A9.2 of RSS210.

In addition, users are cautioned to take note that high power radars are allocated as primary users (meaning they have priority) of 5250 - 5350 MHz and 5650 - 5850 MHz and these radars could cause interference and/or damage to LE-LAN devices.

Avis pour le Canada

Le matériel destiné à un usage sur la bande 5 150 - 5 250 MHz doit être utilisé uniquement à l'intérieur afin de réduire les risques de brouillage nuisible causé aux systèmes mobiles par satellite fonctionnant sur un même canal.

Un gain d'antenne de 6 dBi est autorisé (pour le matériel utilisant les bandes 5 250 - 5 350 MHz, 5 470 - 5 725 MHz et 5 725 - 5 825 MHz), conformément à la limite p.i.r.e. maximale permise selon l'annexe A9.2 afférent aux périphériques RSS210.

En outre, les utilisateurs doivent prendre garde au fait que les radars de grande puissance sont considérés comme des utilisateurs principaux (ce qui signifie qu'ils sont prioritaires) des bandes 5 250 - 5 350 MHz et 5 650 - 5 850 MHz et qu'ils pourraient causer des interférences et/ou des dommages aux appareils de réseau exempts de licence.

Before Using the Optional Wireless LAN

This manual describes the procedures required to properly set up and configure the optional integrated Wireless LAN USB device (referred to as "WLAN device" in the rest of the manual). Before using the WLAN device, read this manual carefully to ensure its correct operation. Keep this manual in a safe place for future reference.

Wireless LAN Device Covered by this Document

This document is applicable to systems containing the following device:

- Integrated Ralink RT3572 802.11a/b/g/n Wireless LAN USB Device

Characteristics of the WLAN Device

- The WLAN device is a USB module attached to the main board of the mobile computer.
- The WLAN device operates in license-free RF bands, eliminating the need to procure an FCC operating license. The WLAN operates in the 2.4GHz Industrial, Scientific, and Medical (ISM) RF band and the lower, middle, and upper bands of the 5GHz Unlicensed National Information Infrastructure (UNII) bands.
- The WLAN devices are capable of four operating modes, IEEE802.11a, IEEE802.11b, IEEE802.11g, and IEEE802.11n
- The WLAN devices are Wi-Fi certified and operate (as applicable) at a the maximum data rate of 150 Mbps (theoretical) in IEEE802.11n mode; 54 Mbps in IEEE802.11a or IEEE802.11g mode; and 11 Mbps in IEEE802.11b mode.
- The WLAN devices support the following encryption methods - WEP, TKIP, CKIP, and AES encryption.
- The Wireless LAN devices are compliant with the following standards: WPA, WPA2, CCX1.0, CCX2.0, CCX3.0, CCX4.0, and CCX5.0.

Wireless LAN Modes Using this Device

Ad Hoc Mode

"Ad Hoc Mode" refers to a wireless network architecture where wireless network connectivity between multiple computers is established without a central wireless network device, typically known as Access Point(s). Connectivity is accomplished using only client devices in a peer-to-peer fashion. That is why Ad Hoc networks are also known as peer-to-peer networks. Ad Hoc networks are an easy and inexpensive method for establishing network connectivity between multiple computers. Ad Hoc mode requires that the SSID, network authentication, and encryption key settings are identically configured on all computers in the Ad Hoc network.

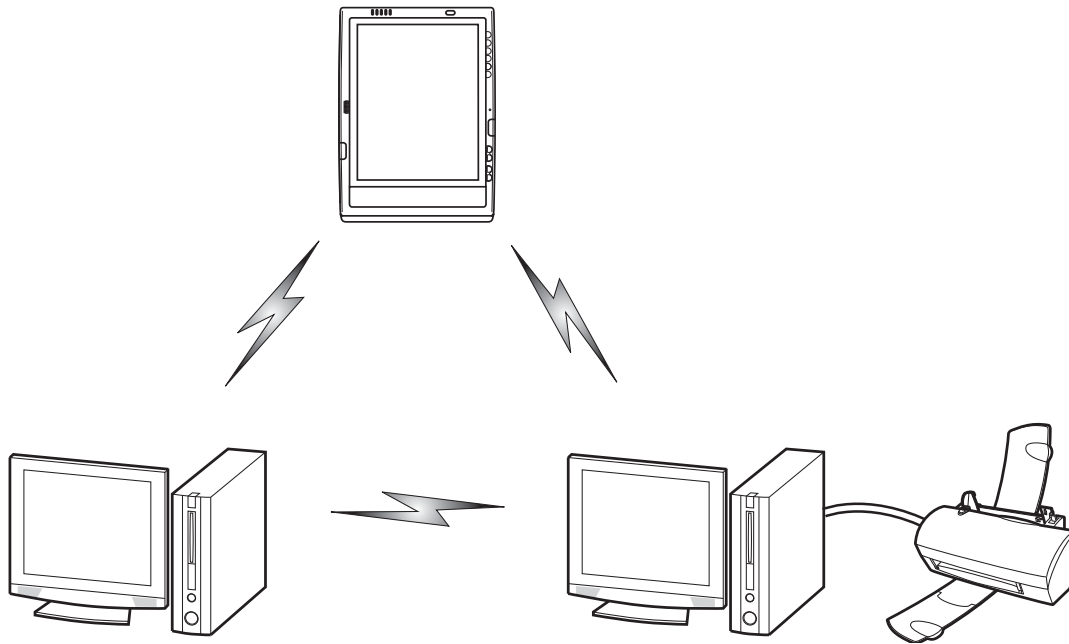

Figure 23. Ad Hoc Mode Network

Access Point (Infrastructure) Mode

Infrastructure mode refers to a wireless network architecture in which devices communicate with wireless or wired network devices by communicating through an Access Point. In infrastructure mode, wireless devices can communicate with each other or with a wired network. Corporate wireless networks operate in infrastructure mode because they require access to the WLAN in order to access services, devices, and computers (e.g., file servers, printers, databases).

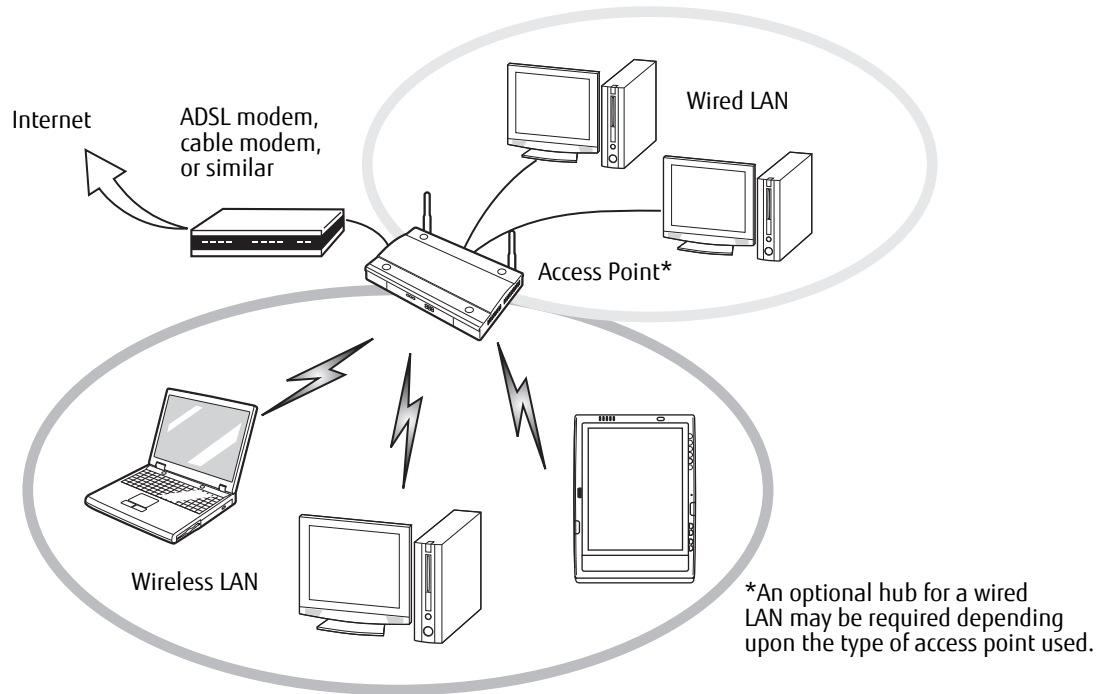

Figure 24. Access Point (Infrastructure) Mode Network

How to Handle This Device

The WLAN device is an optional device that may come pre-installed in your mobile computer. Under normal circumstances, it should not be necessary for you to remove or re-install it. The operating system that your mobile computer comes with has been pre-configured to support the WLAN device.

- The Wireless LAN devices support IEEE802.11a, IEEE802.11b, IEEE802.11g, and IEEE802.11n.
- The WLAN devices operate in the 2.4 GHz ISM band and the 5 GHz lower, middle, and upper UNII bands.
- Microwave ovens may interfere with the operation of WLAN devices since they operate in the same 2.4 GHz frequency range as IEEE802.11b/g/n devices. Interference by microwaves does not occur with IEEE802.11a radio which operates in the 5 GHz RF band.
- Wireless devices that transmit in the 2.4 GHz range may interfere with operation of WLAN devices in IEEE802.11b/g/n modes. Symptoms of interference include reduced throughput, intermittent disconnects, and many frame errors. It is HIGHLY recommended that these interfering devices be powered off to ensure proper operation of the WLAN device.

Deactivating/Disconnecting the WLAN Device

Disconnecting the WLAN device may be desired in certain circumstances (to extend battery life) or where certain environments require it (i.e. hospitals, clinics, airplanes, etc.). The WLAN device can be deactivated by using the Wireless On/Off Switch, and it can be disconnected in Windows using the WLAN icon in the system tray (Note that disconnecting via the icon in the system tray does not turn off the radio; it continues to transmit and receive even though it's not connected.).

Deactivation Using the Wireless On/Off Switch

The WLAN device can be deactivated quickly and efficiently by toggling the Wireless On/Off Switch to the Off position. The switch has no effect on non-Wireless LAN models.

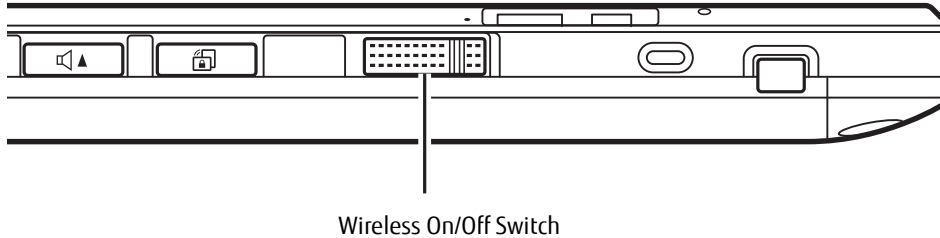

Figure 25. Wireless LAN/Bluetooth On/Off Switch Location

Disconnection Using the Icon in the Taskbar

Note that disconnecting via the icon in the system tray does not turn off the radio; it continues to transmit and receive even though it's not connected.

- 1 Right-click the WLAN icon in the taskbar at the bottom right of your screen.
- 2 Choose Disconnect from a network.

Activating the WLAN Device

Activation of the WLAN device can be accomplished using the same methods as the deactivation process

- Using the Wireless On/Off Switch
- In Windows, by right-clicking the WLAN icon then clicking "Connect to a network"

Configuration of the WLAN Device

The optional WLAN device can be configured to establish wireless network connectivity using the software that is built into Windows. Support for most industry standard security solutions is contained in this software. Pre-defined parameters will be required for this procedure. Please consult with your network administrator for these parameters:

Configuring the WLAN Using Windows

- 1 From Modern Start screen press [Windows]+[X], then select Control Panel from the menu.
- 2 If the Control Panel is not in Classic View, select Classic View from the left panel. Double-click the Network and Sharing Center icon. Select "Setup a new connection or network".
- 3 Depending upon what type of connection you would like to make, make a selection. For an infrastructure network, select "Manually connect to a wireless network".
- 4 Enter the required information. You may need to consult with your network administrator for some information.
- 5 In the event you require assistance, go to the Network and Sharing Center window (Control Panel -> Network and Sharing Center), and type in relevant keywords in the Search box.

Connecting to a Network

After you have configured your computer, you can connect to an active network by performing the following steps:

- 1 Click on the WLAN icon in the system tray.
- 2 Select "Connect to a network".
- 3 Select a network from the list that appears, and click the [Connect] button.

Connection to the network

After you have configured your computer, you can connect to an active network by clicking on the Wireless Network icon in the system tray.

Troubleshooting the WLAN

Troubleshooting

Causes and countermeasures for troubles you may encounter while using your wireless LAN are described in the following table. If you are unfamiliar with the steps required, consult your System Administrator or go to [Start] -> Help and Support -> Networking and the Web

Problem	Possible Cause	Possible Solution
Unavailable network connection	Incorrect network name (SSID) or network key	<p>Ad hoc connection: verify that the network names (SSID's) and network keys (WEP) of all computers to be connected have been configured correctly. SSID's and WEP key values must be identical on each machine.</p> <p>Access Point (Infrastructure) connection: set network name (SSID) and network key to the same values as those of the access point.</p> <p>Set the Network Authentication value identically to that of the Access Point. Please consult your network administrator for this value, if necessary.</p>
	Weak received signal strength and/or link quality	<p>Ad hoc connection: Retry connection after shortening the distance to the destination computer or removing any obstacles for better sight.</p> <p>Access Point (Infrastructure) connection: Retry connection after shortening the distance to the access point or removing any obstacles for better transmission.</p>
	The WLAN device has been deactivated or disabled	Check if the wireless switch is turned On. Go to Start -> Control Panel, and double-click on Windows Mobility Center. If the wireless network is off, click the [Turn wireless on] button.
	The computer to be connected is turned off	Check if the computer to be connected is turned ON.

Problem	Possible Cause	Possible Solution
Unavailable network connection (continued)	RF interference from Access Points or other wireless networks	The use of identical or overlapping RF channels can cause interference with the operation of the WLAN device. Change the channel of your Access Point to a channel that does not overlap with the interfering device.
	Wireless network authentication has failed	Re-check your Network Authentication, Encryption, and Security settings. Incorrectly configured security settings such as an incorrectly typed WEP key, a misconfigured LEAP username, or an incorrectly chosen authentication method will cause the LAN device to associate but not authenticate to the wireless network.
	Incorrectly configured network settings	Recheck the configuration of your network settings.
	Incorrect IP address configuration	This only applies to networks using static IP addresses. Please contact your network administrator for the correct settings.

WLAN Specifications

Specifications

Item	Specification
Type of network	The integrated Ralink RT3572 802.11a/b/g/n Wireless LAN USB Device conforms to IEEE 802.11a, 802.11b/g, and 802.11n, Wi-Fi based*.
Transfer rate	(Automatic switching) 150 Mbps maximum data rate
Active frequency	<ul style="list-style-type: none">• 802.11n: 2.4 GHz or 5 GHz• 802.11b/g: 2400~2473 MHz• 802.11a: 4900 ~ 5850 MHz
Typical operating distances**	<ul style="list-style-type: none">• 802.11a: 40 ft. (12 m) @ 54 Mbps; 300 ft. (91 m) @ 6 Mbps• 802.11b: 100 ft. (30 m) @ 11 Mbps; 300 ft. (91 m) @ 1 Mbps• 802.11g: 100 ft. (30 m) @ 54 Mbps; 300 ft. (91 m) @ 1 Mbps• 802.11n: Estimated double the operating distance of 802.11g and 802.11a in their respective frequencies.
Number of channels	<ul style="list-style-type: none">• 802.11a: 8 independent channels• 802.11b/g: 11 channels, 3 non-overlapping channels• 802.11n: 2.4 GHz - 3 non-overlapping channels when Channel Bonding is not used; 2 non-overlapping channels when Channel Bonding is used. 5 GHz - 12 non-overlapping UNII channels with or without Channel Bonding
Security	Encryption Types - WEP, TKIP, AES***, WPA 1.0 compliant
Maximum recommended number of computers to be connected over wireless LAN (during ad hoc connection)	10 units or less ****

* "Wi-Fi based" indicates that the interconnectivity test of the organization which guarantees the interconnectivity of wireless LAN (Wi-Fi Alliance) has been passed.

** The communication ranges shown above will increase or decrease depending on factors such as number of walls, reflective material, or interference from external RF sources.

*** Encryption with network key (WEP) is performed using the above number of bits, however, users can set 40 bits/ 104 bits after subtracting the fixed length of 24 bits.

**** Depending on practical environments, the allowable number of computers to be connected may be decreased.

Using the Bluetooth Device

The Bluetooth 4.0+HS module allows you to communicate quickly and wirelessly with other devices within a short distance.

What is Bluetooth

Bluetooth technology is designed as a short-range wireless link between mobile devices, such as laptop computers, phones, printers, and cameras. Bluetooth technology is used to create Personal Area Networks (PANs) between devices in short-range of each other.



TO ENABLE OR DISABLE EITHER THE WIRELESS LAN OR BLUETOOTH DEVICES INDIVIDUALLY, PERFORM THE FOLLOWING STEPS:

- > TURN ON THE WLAN/BLUETOOTH SWITCH.
- > GO TO THE MODERN START SCREEN -> CHARMS -> SETTINGS -> CHANGE PC SETTINGS -> WIRELESS.
- > UNDER WIRELESS->WIRELESS DEVICES, CLICK ON "BLUETOOTH" SWITCH TO TURN IT ON.

Where to Find Information About Bluetooth

For additional information about Bluetooth Technology, visit the Bluetooth Web site at: www.bluetooth.com.

FCC Radiation Exposure Statement

This equipment complies with FCC radiation exposure limits set forth for an uncontrolled environment. The Bluetooth antenna is located on the front edge of the right palm rest and is exempt from minimum distance criteria due to its low power.

The transmitters in this device must not be co-located or operated in conjunction with any other antenna or transmitter.

Canadian Notice

To prevent radio interference to the licensed service, this device is intended to be operated indoors and away from windows to provide maximum shielding. Equipment (or its transmit antenna) that is installed outdoors is subject to licensing.

Warranty

Users are not authorized to modify this product. Any modifications invalidate the warranty.

This equipment may not be modified, altered, or changed in any way without signed written permission from Fujitsu. Unauthorized modification will void the equipment authorization from the FCC and Industry Canada and the warranty.

Appendix B: Fingerprint Sensor Device

Introducing the Fingerprint Sensor Device

Your system has a fingerprint sensor device on the rear of the tablet in the top right corner.

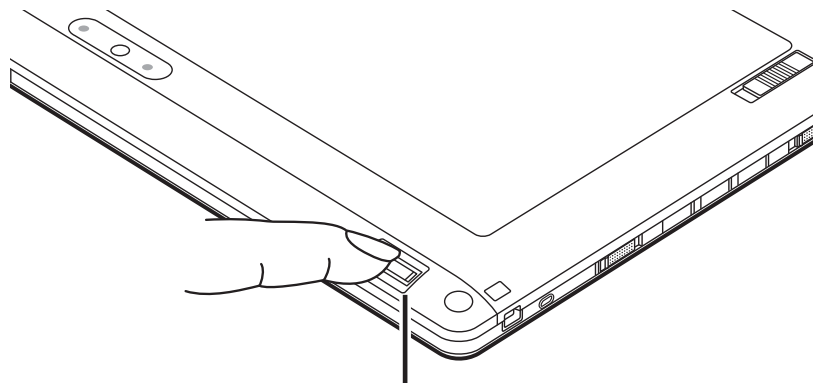

Fingerprint Sensor Device

Figure 26. Fingerprint sensor

With a fingerprint sensor, you can avoid having to enter a username and password every time you want to:

- Log onto Windows
- Resume from sleep mode
- Cancel a password-protected screen saver
- Log into home pages that require a username and password

After you have “enrolled” - or registered - your fingerprint, you can simply swipe your fingertip over the sensor for the system recognize you.

The fingerprint sensor uses Softex OmniPass which provides password management capabilities to Microsoft Windows operating systems. OmniPass enables you to use a "master password" for all Windows, applications, and on-line passwords.

OmniPass requires users to authenticate themselves using the fingerprint sensor before granting access to the Windows desktop. This device results in a secure authentication system for restricting access to your computer, applications, web sites, and other password-protected resources.

OmniPass presents a convenient graphical user interface, through which you can securely manage passwords, users, and multiple identities for each user.

Getting Started

This section guides you through the preparation of your system for the OmniPass fingerprint recognition application. You will be led through the OmniPass installation process. You will also be led through the procedure of enrolling your first user into OmniPass.

Installing OmniPass

If OmniPass has already been installed on your system, skip this section and go directly to “User Enrollment” on page 106. You can determine whether OmniPass has already been installed by checking to see if the following are present:

- The gold key-shaped OmniPass icon in the system tray at the bottom right of the screen.
- The Softex program group in the **Programs** group of the **Start** menu

System Requirements

The OmniPass application requires space on your hard drive; it also requires specific Operating Systems (OS's). The minimum requirements are as follows:

- Windows XP Professional operating system or later
- At least 35 MB available hard disk space

Installing the OmniPass Application

If OmniPass is already installed on your system, go to “User Enrollment” on page 106. Otherwise continue with this section on software installation.



- INSTALLATION OF THE APPLICATION REQUIRES THAT YOU HAVE AN EXTERNAL OPTICAL DRIVE ATTACHED TO YOUR SYSTEM.
- FOR INSTALLATION, OMNIPASS REQUIRES THAT THE USER INSTALLING OMNIPASS HAVE ADMINISTRATIVE PRIVILEGES TO THE SYSTEM. IF YOUR CURRENT USER DOES NOT HAVE ADMINISTRATIVE PRIVILEGES, LOG OUT AND THEN LOG IN WITH AN ADMINISTRATOR USER BEFORE PROCEEDING WITH OMNIPASS INSTALLATION.

To install OmniPass on your system you must:

- 1 Insert the installation media for the OmniPass application into the appropriate drive. If you are installing from CD-ROM or DVD-ROM, you must find and launch the OmniPass installation program (setup.exe) from the media.
- 2 Follow the directions provided in the OmniPass installation program. Specify a location to which you would like OmniPass installed. It is recommended that you NOT install OmniPass in the root directory (e.g. C:\).
- 3 Once OmniPass has completed installation you will be prompted to restart your system. Once your system has rebooted you will be able to use OmniPass. If you choose not to restart immediately after installation, OmniPass will not be available for use until the next reboot.
- 4 The installation program automatically places an icon (Softex OmniPass) in the Windows Control Panel as well as a golden key shaped icon in the taskbar.

Verifying Information about OmniPass

After you have completed installing OmniPass and restarted your system, you may wish to check the version of OmniPass on your system.

To check the version information of OmniPass:

- 1 From the Windows Desktop, double-click the key-shaped OmniPass icon in the taskbar (usually located in the lower right corner of the screen),
or,

Click the **Start** button, select **Settings**, and click **Control Panel**. Double-click **Softex OmniPass** in the Control Panel, and the OmniPass Control Center will appear. If it does not appear, then the program is not properly installed,

or,

Click the **Start** button, select **Programs**, and from the submenu select the **Softex** program group, from that submenu click **OmniPass Control Center**.

- 2 Select the **About** tab at the top of the OmniPass Control Center. The About tab window appears with version information about OmniPass.



FOR UNINSTALLATION, OMNIPASS REQUIRES THAT THE USER UNINSTALLING OMNIPASS HAVE ADMINISTRATIVE PRIVILEGES TO THE SYSTEM. IF YOUR CURRENT USER DOES NOT HAVE ADMINISTRATIVE PRIVILEGES, LOG OUT AND THEN LOG IN WITH AN ADMINISTRATOR USER BEFORE PROCEEDING WITH OMNIPASS UNINSTALLATION.

Uninstalling OmniPass

To remove the OmniPass application from your system:

- 1 Click **Start** on the Windows taskbar. Select **Settings**, and then **Control Panel**.
- 2 Double-click **Add/Remove Programs**.
- 3 Select **OmniPass**, and then click **Change/Remove**.
- 4 Follow the directions to uninstall the OmniPass application.
- 5 Once OmniPass has finished uninstalling, reboot your system when prompted.

User Enrollment

Before you can use any OmniPass features you must first enroll a user into OmniPass.

Master Password Concept

Computer resources are often protected with passwords. Whether you are logging into your computer, accessing your email, e-banking, paying bills online, or accessing network resources, you often have to supply credentials to gain access. This can result in dozens of sets of credentials that you have to remember.

During user enrollment a "master password" is created for the enrolled user. This master password "replaces" all other passwords for sites you register with OmniPass.

Example: A user, John, installs OmniPass on his system (his home computer) and enrolls an OmniPass user with username "John_01" and password "freq14". He then goes to his webmail site to log onto his account. He inputs his webmail credentials as usual (username "John_02" and password "STYLISTIC"), but instead of clicking [Submit], he directs OmniPass to **Remember Password**. Now whenever he returns to that site, OmniPass will prompt him to supply access credentials.

John enters his OmniPass user credentials ("John_01" and "freq14") in the OmniPass authentication prompt, and he is allowed into his webmail account. He can do this with as many web sites or password protected resources he likes, and he will gain access to all those sites with his OmniPass user credentials ("John_01" and "freq14"). This is assuming he is accessing those sites with the system onto which he enrolled his OmniPass user. OmniPass does not actually change the credentials of the password protected resource. If John goes to another computer without he OmniPass account to access his webmail, he would need to enter his original webmail credentials ("John_02" and "STYLISTIC") to gain access. If he attempts his OmniPass user credentials on a system other than a system he's enrolled on, he will not gain access.



THE ENROLLMENT PROCEDURE ASSUMES YOU HAVE NO HARDWARE AUTHENTICATION DEVICES OR ALTERNATE STORAGE LOCATIONS THAT YOU WISH TO INTEGRATE WITH OMNIPASS. IF YOU DESIRE SUCH FUNCTIONALITY, CONSULT THE APPROPRIATE SECTIONS OF THIS DOCUMENT.

Basic Enrollment

The Enrollment Wizard will guide you through the process of enrolling a user. Unless you specified otherwise, after OmniPass installation the Enrollment Wizard will launch on Windows login. If you do not see the Enrollment Wizard, you can bring it up by clicking **Start** on the Windows taskbar; select **Programs**; select **Softex**; click **OmniPass Enrollment Wizard**.

- 1 Click **Enroll** to proceed to username and password verification. By default, the OmniPass Enrollment Wizard enters the credentials of the currently logged in Windows user.
- 2 Enter the password you use to log in to Windows. This will become the “master password” for this OmniPass user. In most cases, the **Domain:** value will be your Windows computer name. In a corporate environment, or when accessing corporate resources, the **Domain:** may not be your Windows computer name. Click [Next] to continue.
- 3 In this step OmniPass captures your fingerprint. Refer to “Enrolling a Fingerprint” on page 107 for additional information.
- 4 Next, choose how OmniPass notifies you of various events. We recommend you keep **Taskbar Tips** on **Beginner mode taskbar tips** and **Audio Tips** on at least **Prompt with system beeps only** until you get accustomed to how OmniPass operates. Click [Next] to proceed with user enrollment. You will then see a Congratulations screen indicating your completion of user enrollment.
- 5 Click [Done] to exit the OmniPass Enrollment Wizard. You will be asked if you’d like to log in to OmniPass with your newly enrolled user; click [Yes].

Enrolling a Fingerprint

Enrolling a fingerprint will increase the security of your system and streamline the authentication procedure.

You enroll fingerprints in the OmniPass Control Center. With an OmniPass user logged in, double-click the system tray OmniPass icon. Select the **User Settings** tab and click **Enrollment** under the **User Settings** area. Click **Enroll Authentication Device** and authenticate at the authentication prompt to start device enrollment.

- 1 During initial user enrollment, you will be prompted to select the finger you wish to enroll. Fingers that have already been enrolled will be marked by a green check. The finger you select to enroll at this time will be marked by a red arrow. OmniPass will allow you re-enroll a finger. If you choose a finger that has already been enrolled and continue enrollment, OmniPass will enroll the fingerprint, overwriting the old fingerprint. Select a finger to enroll and click [Next].
- 2 It is now time for OmniPass to capture your selected fingerprint. It may take a several capture attempts before OmniPass acquires your fingerprint. Should OmniPass fail to acquire your fingerprint, or if the capture screen times out, click [Back] to restart the fingerprint enrollment process.

Your system has a “swipe” fingerprint sensor. A swipe sensor is small and resembles a skinny elongated rectangle. To capture a fingerprint, gently swipe or pull your fingertip over the sensor (starting at the second knuckle) **towards yourself**. Swiping too fast or too slow will result in a failed capture. The **Choose Finger** screen has a [Practice] button; click it to practice capturing your fingerprint. When you are comfortable with how your fingerprint is captured, proceed to enroll a finger.

- 3 Once OmniPass has successfully acquired the fingerprint, the **Verify Fingerprint** screen will automatically appear. To verify your enrolled fingerprint, place your fingertip on the sensor and hold it there as if you were having a fingerprint captured. Successful fingerprint verification will show a green fingerprint in the capture window and the text **Verification Successful** under the capture window.

Using OmniPass

You are now ready to begin using OmniPass. Used regularly, OmniPass will streamline your authentications.

Password Replacement

You will often use the password replacement function. When you go to a restricted access website (e.g., your bank, your web-based email, online auction or payment sites), you are always prompted to enter your login credentials. OmniPass can detect these prompts and you can teach OmniPass your login credentials. The next time you go to that website, you can authenticate with your fingerprint to gain access.

OmniPass Authentication Toolbar

After installing OmniPass and restarting, you will notice a dialog you have not seen before at Windows Logon. This is the OmniPass Authentication Toolbar, and it is displayed whenever the OmniPass authentication system is invoked. The OmniPass authentication system may be invoked frequently: during Windows Logon, during OmniPass Logon, when unlocking your workstation, when resuming from sleep or hibernate, when unlocking a password-enabled screensaver, during password replacement for remembered site or application logins, and more. When you see this toolbar, OmniPass is prompting you to authenticate.

The **Logon Authentication** window indicates what OmniPass-restricted function you are attempting. The icons in the lower left (fingerprint and key) show what authentication methods are available to you. Selected authentication methods are highlighted while unselected methods are not. When you click the icon for an unselected authentication method, the authentication prompt associated with that method is displayed.

When prompted to authenticate, you must supply the appropriate credentials: an enrolled finger for the fingerprint capture window or your master password for the master password prompt (the key icon).

Remembering a Password

OmniPass can remember any application, GUI, or password protected resource with a password prompt.

Using the following procedure, you can store a set of credentials into OmniPass. These credentials will then be linked to your “master password” or fingerprint.

Go to a site that requires a login (username and password), but *do not log in yet*. At the site login prompt, enter your username and password in the prompted fields, but *do not enter the site* (do not hit [Enter], [Submit], [OK], or Login). Right-click the OmniPass system tray icon and select **Remember Password** from the submenu. The Windows arrow cursor will change to a golden key OmniPass cursor. Click the OmniPass cursor in the login prompt area, but don't click [Login] or [Submit].

Associating a Friendly Name

After clicking the OmniPass key cursor near the login prompt, OmniPass will prompt you to enter a “friendly name” for this site. You should enter something that reminds you of the website, the company, or the service you are logging into. In its secure database, OmniPass associates this friendly name with this website.

Additional Settings for Remembering a Site

When OmniPass prompts you to enter a “friendly name” you also have the opportunity to set how OmniPass authenticates you to this site. There are three effective settings for how OmniPass handles a remembered site.

The default setting is **Automatically click the “OK” or “Submit” button for this password protected site once the user is authenticated**. With this setting, each time you navigate to this site OmniPass will prompt you for your master password or fingerprint authentication device. Once you have authenticated with OmniPass, you will automatically be logged into the site.

Less secure is the option to **Automatically enter this password protected site when it is activated. Do not prompt for authentication**. Check the upper box to get this setting, and each time you navigate to this site OmniPass will log you into the site without prompting you to authenticate.



THIS SETTING IS MORE CONVENIENT IN THAT WHENEVER YOU GO TO A SITE REMEMBERED WITH THIS SETTING, YOU WILL BYPASS ANY AUTHENTICATION PROCEDURE AND GAIN INSTANT ACCESS TO THE SITE. BUT SHOULD YOU LEAVE YOUR SYSTEM UNATTENDED WITH YOUR OMNIPASS USER LOGGED IN, ANYONE USING YOUR SYSTEM CAN BROWSE TO YOUR PASSWORD PROTECTED SITES AND GAIN AUTOMATIC ACCESS.

If you uncheck both boxes in **Settings for this Password Site**, OmniPass will prompt you for your master password or fingerprint authentication device. Once you have authenticated with OmniPass your credentials will be filled in to the site login prompt, but you will have to click the website [OK], [Submit], or [Login] button to gain access to the site.

Click **Finish** to complete the remember password procedure. The site location, the credentials to access the site, and the OmniPass authentication settings for the site are now stored in the OmniPass secure database. The OmniPass authentication settings (**Settings for this Password Site**) can always be changed in **Vault Management**.

Logging in to a Remembered Site

Whether or not OmniPass prompts you to authenticate when you return to a remembered site is determined by **Settings for this Password Site** and can be changed in **Vault Management**.

The following cases are applicable to using OmniPass to login to: Windows, remembered web sites, and all other password protected resources.

With Master Password

Once you return to a site you have remembered with OmniPass, you may be presented with a master password prompt. Enter your master password and you will be allowed into the site.

Logging into Windows with a Fingerprint Device

When logging into Windows with a fingerprint device, the fingerprint capture window will now appear next to the Windows Login screen. Place your enrolled fingertip on the sensor to authenticate. You will be simultaneously logged into Windows and OmniPass. The capture window will also appear if you have used **Ctrl-Alt-Del** to lock a system, and the fingerprint device can be used to log back in as stated above.



IF A MACHINE IS LOCKED AND OMNIPASS DETECTS A DIFFERENT USER LOGGING BACK IN WITH A FINGERPRINT, THE FIRST USER WILL BE LOGGED OUT AND THE SECOND USER LOGGED IN.

Password Management

OmniPass provides an interface that lets you manage your passwords. To access this GUI, double-click the OmniPass key in the system tray. Click **Vault Management**; you will be prompted to authenticate. Once you gain access to **Vault Management**, click **Manage Passwords** under **Vault Settings**. You will see the **Manage Passwords** interface, with a list of friendly names.

You can view the credentials stored for any remembered website by highlighting the desired resource under **Password Protected Dialog** and clicking **Unmask Values**. Should a password be reset, or an account expire, you can remove stored credentials from OmniPass. Highlight the desired resource under **Password Protected Dialog** and click **Delete Page**. You will be prompted to confirm the password deletion.

The two check boxes in **Manage Passwords** govern whether OmniPass prompts you to authenticate or directly logs you into the remembered site.

OmniPass will overwrite an old set of credentials for a website if you attempt to use **Remember Password** on an already remembered site.

The exception to the above rule is when resetting the Windows password. If your password is reset in Windows, the next time you login to Windows, OmniPass will detect the password change and prompt you to "Update" or "Reconfirm" the password with OmniPass. Enter your new Windows password in the prompt and click **OK**. Your OmniPass "master password" will still be your Windows password.

OmniPass User Identities

Identities allow OmniPass users to have multiple accounts to the same site (e.g., *bob@biblomail.com* and *boballen@biblomail.com*). If OmniPass did not provide you identities, you would be limited to remembering one account per site.

To create and manage identities, double-click the OmniPass key in the system tray. Click **Vault Management**; OmniPass will prompt you to authenticate. Once you gain access to **Vault Management**, click **Manage Identities** under **Vault Settings**. You can only manage the identities of the currently logged in OmniPass user

To add a new identity, click **New Identity** or double-click **Click here to add a new identity**. Name the new identity and click [OK], then click [Apply]. You can now switch to the new identity and start remembering passwords.

To delete an identity, highlight the identity you want to delete and click [Delete Identity], then [Apply].



WHEN YOU DELETE AN IDENTITY, ALL OF ITS ASSOCIATED REMEMBERED SITES AND PASSWORD PROTECTED DIALOGS ARE LOST.

To set the default identity, highlight the identity you want as default and click [Set as Default]; click [Apply] to ensure the settings are saved. If you log in to OmniPass with a fingerprint device, you will automatically be logged in to the default identity for that OmniPass user. You can choose the identity with which you are logging in if you login using "master password".

Choosing User Identity during Login

To choose your identity during login, type your username in the **User Name:** field. Press [Tab] and see that the **Domain:** field self-populates. Click the **Password:** field to bring the cursor to it, and you will see the pull-down menu in the **Identity:** field. Select the identity to login as, then click **OK**.

Switch User Identity

To switch identities at any time, right-click the OmniPass system tray icon and click **Switch User Identity** from the submenu. The **Switch Identity** dialog will appear. Select the desired identity and then click **OK**.

Identities and Password Management

On the **Manage Passwords** interface of the **Vault Management** tab of the OmniPass Control Center, there is a pull-down selection box labeled, **Identity**. This field lets you choose which identity you are managing passwords for. When you select an identity here, only those password protected dialogs that are associated with that identity are shown. You can perform all the functions explained in "Password Management" on page 111.

Configuring OmniPass

This section gives an overview of both the Export/Import function and the OmniPass Control Center.

Exporting and Importing Users



YOU CANNOT IMPORT A USER INTO OMNIPASS IF THERE ALREADY IS A USER WITH THE SAME NAME ENROLLED IN OMNIPASS.

Using OmniPass Control Center, you can export and import users in and out of OmniPass. The export process backs up all remembered sites, credentials, and enrolled fingerprints for an OmniPass user. All OmniPass data for a user is backed up to a single encrypted database file. During the import process, the Windows login of the exported user is required. If the proper credentials cannot be supplied, the user profile will not be imported.



- YOU SHOULD PERIODICALLY EXPORT YOUR USER PROFILE AND STORE IT IN A SAFE PLACE. IF ANYTHING HAPPENS TO YOUR SYSTEM, YOU CAN IMPORT YOUR OMNIPASS PROFILE TO A NEW SYSTEM AND HAVE ALL YOUR REMEMBERED SETTINGS AND FINGERPRINTS INSTANTLY.
- YOU DON'T FORGET THE WINDOWS LOGIN CREDENTIALS WHEN EXPORTING. WHEN YOU EXAMINE THE IMPORTATION, YOU ARE PROMPTED FOR AUTHENTICATION. THE CREDENTIALS THAT WILL ALLOW A USER PROFILE TO BE IMPORTED ARE THE WINDOWS LOGIN CREDENTIALS OF THE EXPORTED USER. THEY ARE THE CREDENTIALS THAT HAD TO BE SUBMITTED WHEN THE USER PROFILE WAS EXPORTED. YOU WILL NEED USER NAME, PASSWORD, AND DOMAIN.

Exporting an OmniPass User Profile

To export a user, open the OmniPass Control Center, and click **Import/Export User** under **Manage Users**.

Click **Exports an OmniPass user profile**. OmniPass will prompt you to authenticate. Upon successfully authentication, you must name the OmniPass user profile and decide where to save it. An .opi file is generated, and you should store a copy of it in a safe place.

This .opi file contains all your user specific OmniPass data, and it is both encrypted and password protected. This user profile does NOT contain any of your encrypted data files.

Importing an OmniPass User Profile

To import an OmniPass user open the OmniPass Control Center, and click **Import/Export User** under **Manage Users**. Click **Imports** a new user into OmniPass and then select **OmniPass Import/Export File (*.opi)** and click **Next**. OmniPass will then prompt you to browse for the file you had previously exported (.opi file). When you select the .opi file for importation, OmniPass will prompt you for authentication. The credentials that will allow a user profile to be imported are the Windows login credentials of the exported user. They are the credentials that had to be submitted when the user profile was exported. You will need User Name, Password, and Domain. If you don't remember the value for Domain, in a PC or SOHO environment Domain should be your computer name.

OmniPass will notify you if the user was successfully imported.

Things to Know Regarding Import/Export

- Assume you export a local Windows User profile from OmniPass. You want to import that profile to another machine that has OmniPass. Before you can import the profile, a Windows user with the same login credentials must be created on the machine importing the profile.

Example: I have a Windows user with the username "Tom" and the password "Sunshine" on my system. I have enrolled Tom into OmniPass and remembered passwords. I want to take all my passwords to new system. I export Tom's OmniPass user profile. I go to my new system and using the Control Panel I create a user with the username "Tom" and the password "Sunshine". I can now successfully import the OmniPass user data to the new system.

- If you export an OmniPass-only user, you can import that user to any computer running OmniPass, provided that a user with that name is not already enrolled in OmniPass.
- If you attempt to import a user profile who has the same name as a user already enrolled in OmniPass, the OmniPass import function will fail.

OmniPass Control Center

This section serves to explain functions within OmniPass Control Center that weren't explained earlier.

You can access the OmniPass Control Center any of three ways:

- Double-click the golden OmniPass key shaped icon in the Windows taskbar (typically in the lower-right corner of the desktop)
- Click the **Start** button; select the **Programs** group; select the **Softex** program group; and click the **OmniPass Control Center** selection.
- Open the Windows **Control Panel** (accessible via **Start** button --> **Settings** --> **Control Panel**) and double-click the **Softex OmniPass** icon.

User Management

The User Management tab has two major interfaces: **Add/Remove User** and **Import/Export User**. Import/Export User functionality is documented in "Exporting and Importing Users" on page 113. Add/Remove User functionality is straightforward.

If you click **Adds a new user to OmniPass** you will start the OmniPass Enrollment Wizard. The Enrollment Wizard is documented in “User Enrollment” on page 106.

If you click **Removes a user from OmniPass**, OmniPass will prompt you to authenticate. Authenticate with the credentials (or enrolled fingerprint) of the user you wish to remove. OmniPass will prompt you to confirm user removal. Click **OK** to complete user removal.



REMOVING A USER WILL AUTOMATICALLY DESTROY ALL OMNIPASS DATA ASSOCIATED WITH THAT USER. ALL IDENTITIES AND CREDENTIALS ASSOCIATED WITH THE USER WILL BE LOST.

IF YOU'RE SURE YOU WANT TO REMOVE THE USER, WE RECOMMEND YOU EXPORT THE USER PROFILE.

User Settings

User Settings tab has three interfaces: **Audio Settings**, **Taskbar Tips**, and **Enrollment**. User settings allow you to customize OmniPass to suit your preferences. Under **User Settings (Audio Settings and Taskbar Tips)** you can set how OmniPass notifies you of OmniPass events (e.g., successful login, access denied, etc.). Details of each setting under the **Audio Settings** and **Taskbar Tips** interfaces are self-explanatory.

The **Enrollment** interface allows you to enroll fingerprints. For the procedure to enroll and authentication device refer to *Chapter 2.3*. To enroll additional fingerprints, click **Enroll Authentication Device**, and authenticate with OmniPass. Select the fingerprint recognition device in the **Select Authentication Device** screen (it should already be marked by a green check if you have a finger enrolled) and click **Next**.

System Settings

The OmniPass **Startup Options** interface can be found in the System Settings tab. With these options you can specify how your OmniPass Logon is tied to your Windows Logon.

The first option, **Automatically log on to OmniPass as the current user**, will do just as it says; during Windows login, you will be logged on to OmniPass using your Windows login credentials. If the user logging into Windows was never enrolled into OmniPass, upon login no one will be logged on to OmniPass. This setting is appropriate for an office setting or any setting where users must enter a username and password to log into a computer. This is the default setting.

With the second option, **Manually log on to OmniPass at startup**, OmniPass will prompt you to login once you have logged on to Windows.

With the third option, **Do not log on to OmniPass at startup**, OmniPass will not prompt for a user to be logged on. You can manually log on to OmniPass by right-clicking the OmniPass taskbar icon and clicking **Log in User** from the right-click menu.

Troubleshooting

You cannot use OmniPass to create Windows users. You must first create the Windows user, and you will need administrative privileges to do that. Once the Windows user is created, you can add that user to OmniPass using the same username and password

Cannot add Windows users to OmniPass

If you experience difficulties adding a Windows user to OmniPass, you may need to adjust your local security settings. You can do this by going to **Start, Control Panel, Administrative Tools, and Local Security Settings**. Expand **Local Policies**, expand **Security Options**, and double-click **Network Access: Sharing and Security Model for Local Accounts**. The correct setting should be *Classic - Local Users Authenticate as Themselves*.

Cannot add a User with a Blank Password to OmniPass

If you experience difficulties adding a user with a blank password to OmniPass, you may need to adjust your local security settings. First attempt the procedure explained in the *Cannot add Windows user to OmniPass* section. If the difficulties persist, then try the following procedure.

Click **Start, Control Panel, Administrative Tools, and Local Security Settings**. Expand **Local Policies**, expand **Security Options**, and double-click **Accounts: Limit local account use of blank passwords to console login only**. This setting should be set to Disabled.

Dialog appears after OmniPass authentication during Windows Logon

After installing OmniPass on your system, you can choose to logon to Windows using OmniPass. You authenticate with OmniPass (via master password, or an enrolled security device) and OmniPass logs you into Windows. You may, during this OmniPass authentication, see a **Login Error** dialog box.

This dialog box occurs when OmniPass was unable to log you into Windows with the credentials supplied (username and password). This could happen for any of the following reasons:

- Your Windows password has changed
- Your Windows account has been disabled

If you are having difficulties due to the first reason, you will need to update OmniPass with your changed Windows account password. Click **Update Password** and you will be prompted with a dialog to reconfirm your password.

Enter the new password to your Windows user account and click **OK**. If the error persists, then it is unlikely the problem is due to your Windows user account password changing.

Index

A

About This Guide 11

AC

- adapter 37

- plug adapters 77

Active Digitizer 26

application buttons 35

Auto/Airline Adapter 37, 38

B

Battery 47

- care 77

- cold-swapping 50

- conserving power 44

- dead 59

- faulty 59

- hot-swapping 51

- increasing life 77

- Lithium Polymer battery 47

- low 49

- problems 59, 60

- recharging 48

- replacing 49

- shorted 49

- Standby mode 49

battery release latch 17, 18

BIOS 41

Bluetooth 100

Boot Sequence 40

Booting the System 42

Built-in Speakers 57

C

Cameras 15, 18, 20

Capacitive Touchscreen 30

Clicking 26

Contact Information 12

conventions used in the guide 11

D

DC input connector 19

DC Output Cable 37

DC Power Jack 37

Display Panel 24, 61

E

Error Messages 62

F

Fingerprint Sensor Device 102

- enrolling a fingerprint 107

- getting started 103

- installing OmniPass 103

- logging into a remembered site 110

- OmniPass authentication toolbar 109

- password replacement 108

- remembering a password 109

- uninstalling OmniPass 105

- user enrollment 106
- using OmniPass 108
- Front Web Camera 15, 20
- Fujitsu Contact Information 12

G

- Gestures 30

H

- Hard Disk Drive 57
- Hard Disk Drive Passwords 40
- HDMI Port 19
- headphone 19
- Hibernation Feature 45

L

- Lithium Polymer Battery 18

P

- Pen

- Caring for the Pen 32
- Changing the Pen Battery 33
- Changing the Pen Settings 32
- Installing a Pen Tether 34
- Replacing the Pen Tip 33

- Pen Tether Attachment Point 17, 21

- Power

- AC adapter 37
- Auto/Airline adapter 37
- failure 58, 59
- management 44
- off 46
- on 39
- problems 60
- sources 37

- power icon 23
- Power Management 44
- Power On Self Test 40, 62
- Power/Suspend/Resume Switch 44
- Pre-Installed Software 84

R

- Rear Web Camera 18
- Registration 43
- Regulatory Information 86
- removable battery pack 18
- Restarting 46
- Restoring Your Pre-installed Software 63

S

- SD Card

- installing 52
- removing 53

- Sleep Mode 44

- Specifications 80

- Audio 81
- Chipset 80
- Digitizer 81
- Dimensions and Weight 83
- Environmental Requirements 83
- Keyboard 82
- mass storage device options 81
- Memory 80
- Microprocessor 80
- Power 83
- Video 81

- status display 22

T

Touch Screen

- calibrating 29
- clicking 27
- dragging 28

Troubleshooting 54

- Audio Problems 57
- battery 59
- display 61
- hard drive 57
- mouse 57
- power 58
- USB 58

U

Universal Serial Bus 19, 20

Using the Optional Capacitive Touchscreen 30

W

Warranty 13

Windows Power Management 45

Wireless LAN

- Before Using the Wireless LAN 91
- configuring 91
- connection to the network 96
- deactivating/disconnecting 94
- modes 92
- Specifications 99
- Troubleshooting 96