

Fujitsu LifeBook®
A3120 Notebook

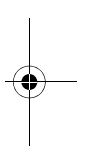

User's Guide

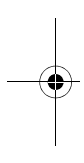

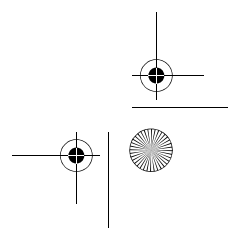
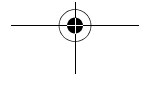
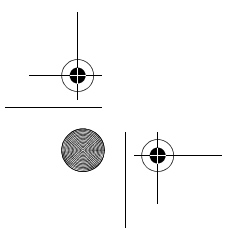
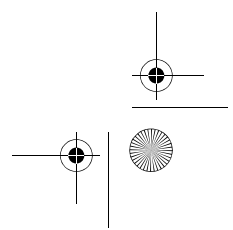
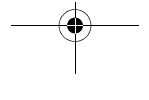
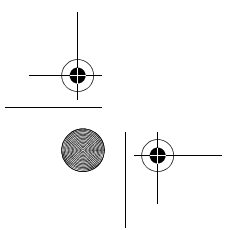
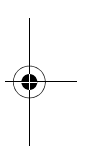
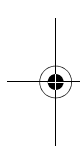
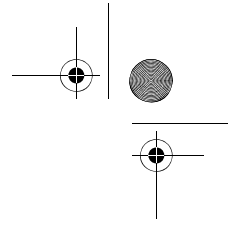
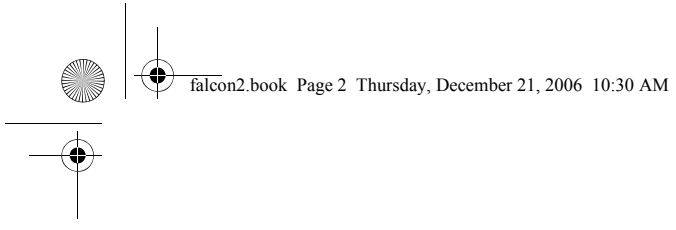

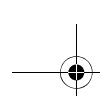

Copyright

Copyright and Trademark Information

Fujitsu Computer Systems Corporation has made every effort to ensure the accuracy and completeness of this document; however, as ongoing development efforts are continually improving the capabilities of our products, we cannot guarantee the accuracy of the contents of this document. We disclaim liability for errors, omissions, or future changes.

Fujitsu, the Fujitsu logo, and LifeBook are registered trademarks of Fujitsu Limited.

Microsoft, Windows and Windows Vista are either registered trademarks or trademarks of Microsoft Corporation in the United States and/or other countries.

The ExpressCard word mark and logo are owned by the Personal Computer Memory Card International Association (PCMCIA) and any use of such marks by Fujitsu Computer Systems Corporation is under license.

PCMCIA is a trademark of the Personal Computer Memory Card International Association.

AMD and Turion are trademarks of Advanced Micro Devices, Inc.

Realtek is a trademark of Realtek Semiconductor Corporation.

Google and Picasa are trademarks or registered trademarks of Google Incorporated.

Bluetooth is a trademark of Bluetooth SIG, Inc., USA.

Adobe, Acrobat, and Acrobat Reader are either registered trademarks or trademarks of Adobe Systems Incorporated in the United States and/or other countries.

OmniPass is a trademark of Softex, Inc.

PowerDVD is a trademark of CyberLink Corp.

Norton Internet Security is a trademark of Symantec Corporation in the United States and other countries.

The DVD player found in some models of the LifeBook notebook incorporates copyright protection technology that is protected by method claims of certain U.S. patents and other intellectual property rights owned by Macrovision Corporation and other rights users. Use of this copyright protection technology must be authorized by Macrovision Corporation, and is intended for home and other limited viewing uses only unless authorized by Macrovision Corporation. Reverse engineering or disassembly is prohibited.

All other trademarks mentioned herein are the property of their respective owners.

Warning



Handling the cord on this product will expose you to lead, a chemical known to the State of California to cause birth defects or other reproductive harm.

Wash hands after handling.

© Copyright 2006 Fujitsu Computer Systems Corporation. All rights reserved. No part of this publication may be copied, reproduced, or translated, without prior written consent of Fujitsu. No part of this publication may be stored or transmitted in any electronic form without the written consent of Fujitsu.

B5FJ-2441-01EN-00



DECLARATION OF CONFORMITY

according to FCC Part 15

Responsible Party Name:	Fujitsu Computer Systems Corporation
Address:	1250 E. Arques Avenue, M/S 122 Sunnyvale, CA 94085
Telephone:	(408) 746-6000
Declares that product:	Base Model Configuration: LifeBook A3120 notebook

Complies with Part 15 of the FCC Rules.

This device complies with Part 15 of the FCC rules. Operations are subject to the following two conditions:

(1) This device may not cause harmful interference, (2) This device must accept any interference received, including interference that may cause undesired operation.



LifeBook A3000 Series Notebook

IMPORTANT SAFETY INSTRUCTIONS

This unit requires an AC adapter to operate. Use only UL Listed Class 2 Adapters with an output rating of 19 VDC, with a current of 4.22A.

AC adapter output polarity:



When using your notebook equipment, basic safety precautions should always be followed to reduce the risk of fire, electric shock and injury to persons, including the following:

- Do not use this product near water for example, near a bathtub, washbowl, kitchen sink or laundry tub, in a wet basement or near a swimming pool.
- Avoid using the modem during an electrical storm. There may be a remote risk of electric shock from lightning.
- Do not use the modem to report a gas leak in the vicinity of the leak.
- Use only the power cord and batteries indicated in this manual. Do not dispose of batteries in a fire. They may explode. Check with local codes for possible special disposal instructions.
- To reduce the risk of fire, use only No. 26 AWG or larger UL Listed or CSA Certified Telecommunication Line Cord.
- For TV tuner use: To protect from overvoltages and transients on the Cable Distribution System, make sure that the outer shield of the coaxial cable is connected to earth (grounded) at the building premise as close to the point of cable entrance as practicable, as required per NEC Article 820.93, ANSI/NFPA 70: 2005. If you have questions about your CATV installation, contact your service provider.

SAVE THESE INSTRUCTIONS

For Authorized Repair Technicians Only



Danger of explosion if Lithium (clock) battery is incorrectly replaced. Replace only with the same or equivalent type recommended by the manufacturer. Dispose of used batteries according to the manufacturer's instruction.



For continued protection against risk of fire, replace only with the same type and rating fuse.

System Disposal



LAMP(S) INSIDE THIS PRODUCT CONTAIN MERCURY AND MUST BE RECYCLED OR DISPOSED OF ACCORDING TO LOCAL, STATE, OR FEDERAL LAWS.

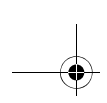

Fujitsu LifeBook® A3120 Notebook Table of Contents

1

PREFACE

Preface

About This Guide	1
Fujitsu Contact Information	1
Limited Warranty	1

2

GETTING TO KNOW YOUR LIFEBOOK NOTEBOOK

Overview

Unpacking	5
---------------------	---

Locating the Controls and Connectors

Top Components	6
Left-Side Panel Components	7
Right-Side Panel Components	8
Back Panel Components	9
Bottom Components	10

Status Indicator Panel

Power Indicator	11
Battery Charging Indicator	11
Battery Level Indicator	11
HDD/ODD Access Indicator	12
NumLk Indicator	12
CapsLock Indicator	12
ScrLk Indicator	12

Keyboard

Using the Keyboard	13
Numeric Keypad	13
Windows Keys	13
Cursor Keys	13
Function Keys	13

Touchpad Pointing Device

Clicking	15
Double-Clicking	15
Dragging	16
Scrolling	16
Touchpad Control Adjustment	16
Optional Point and Write Pad	16

Volume Control

Controlling the Volume	18
----------------------------------	----

LifeBook Application Panel

Configuring the Application Panel	19
---	----

3

GETTING STARTED

Power Sources

Connecting the Power Adapters	23
---	----

Display Panel

Opening the Display Panel	24
Adjusting Display Panel Brightness	24
Closing the Display Panel	24

Starting Your LifeBook Notebook

Power On	25
Boot Sequence	25
Hard Disk Drive Passwords	25
BIOS Setup Utility	25
Booting the System	26
Starting Vista for the first time	26
Registering Windows with Microsoft	26
Registering Your LifeBook notebook	26
Installing Click Me!	26

Power Management

Power/Suspend/Resume Button	27
Standby Mode	27
Hibernation (Save-to-Disk) Feature	27
Restarting the System	28
Power Off	28

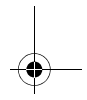
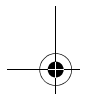
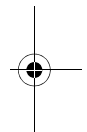
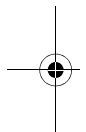

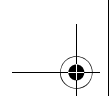

4

USER-INSTALLABLE FEATURES

Lithium ion Battery

Recharging the Batteries	31
Replacing the Battery	32

Optical Disk Drive

Media Player Software	33
Loading Media on Your Drive	33
Removing Media	34
Emergency Media Tray Release	34
Using the Media Player Software	34
Using Media Player on Battery Power	34

Memory Stick/SD/xD Card Slot

Inserting Memory Stick/SD/xD Cards	36
Removing A Memory Stick/SD/XD Card	37

PC Cards/ExpressCards™

inserting PC Cards	38
Removing PC Cards	38
inserting ExpressCards	39
Removing ExpressCards	39

Memory Upgrade Module

Installing Memory Upgrade Modules	40
Removing a Memory Upgrade Module	40
Checking the Memory Capacity	41

Device Ports

Modem (RJ-11) Telephone Jack	42
Internal LAN (RJ-45) Jack	42
Universal Serial Bus Ports	42
IEEE 1394 Port	43
Headphone/Line-Out Jack	43
Microphone/Line-In Jack	43
S-Video Out Port	43
External Video Port	43

5

TROUBLESHOOTING

Troubleshooting

Identifying the Problem	47
Specific Problems	47
Troubleshooting Table	48
Power On Self Test Messages	55
Emergency Media Player Drive Tray Release	56
Modem Result Codes	56
Restoring Your Pre-installed Software	57
Restoring the Factory Image	57
Using the Shock Sensor Utility	58
Automatically Downloading Driver Updates	59

6

CARING FOR YOUR LIFEBOOK

Care and Maintenance

Batteries	64
Floppy Disks and Drives	64
Media Care	65
PC Cards/ExpressCards	65

7

SYSTEM SPECIFICATIONS

Specifications

Configuration Label	69
Microprocessor	69
Chipset	69
Memory	69
Video	69
Audio	69
Mass Storage Device Options	69
Features	69
Device Ports	70
Keyboard	70
Power	70
Dimensions and Weight	70
Environmental Requirements	70
Popular Accessories	70
Pre-Installed Software	71
Learning About Your Software	71

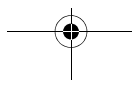

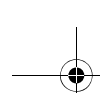

Table of Contents

8

GLOSSARY/REGULATORY

Glossary	75
Regulatory Information	80

APPENDIX A: INTEGRATED WIRELESS LAN USER'S GUIDE

Before Using the Wireless LAN

Wireless LAN Modes Using this Device	86
Wireless Network Considerations	87
Deactivating the WLAN Device	87
Activating the WLAN Device	87
Configuring the Wireless LAN	88
Connecting to a Network	88

Troubleshooting the WLAN

Troubleshooting Table	89
-----------------------------	----

Wireless LAN Glossary

Glossary	90
----------------	----

Specifications

Specifications	92
----------------------	----

Using the Bluetooth Device

What is Bluetooth	93
Where to Find Information about Bluetooth ...	93

APPENDIX B: USING THE FINGERPRINT SENSOR

Fingerprint Sensor Device

Introducing the Fingerprint Sensor Device	97
Getting Started	97
Installing OmniPass	97
User Enrollment	98
Using OmniPass	99
Configuring OmniPass	101
OmniPass Control Center	102
Troubleshooting	103

Index

Index	105
-------------	-----

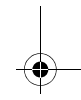
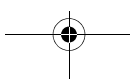
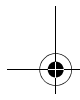
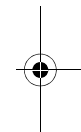
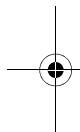

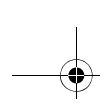

LifeBook A3000 Series Notebook

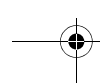
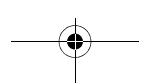
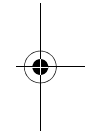
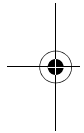

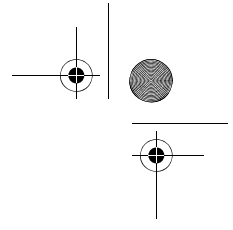
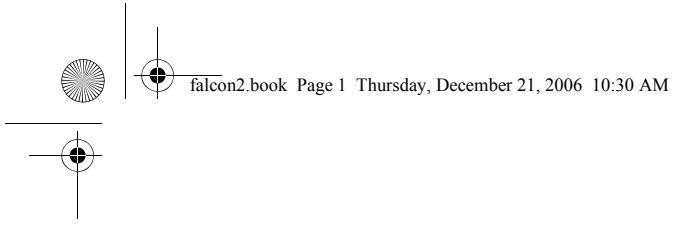

1 Preface

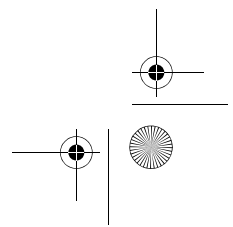
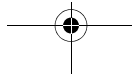
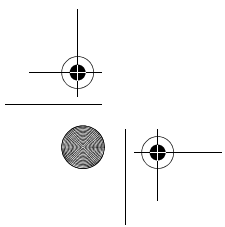
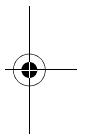
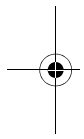

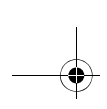

LifeBook A3000 Series Notebook

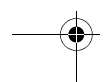
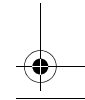
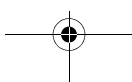
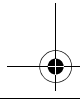
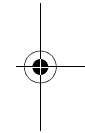
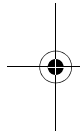



Preface

ABOUT THIS GUIDE

The LifeBook A3120 notebook from Fujitsu is a powerful computer, powered by an AMD Turion™ 64 X2 Mobile Technology microprocessor and an integrated ATI Radeon® Xpress graphics controller with support for up to 256 MB of shared graphics memory. The notebook has a built-in 15.4" TFT wide XGA Crystal View color display. This system brings the computing power of a desktop personal computer to a portable environment.

Your computer comes with Microsoft Windows Vista™ Home Premium or Microsoft Windows Vista™ Business Edition pre-installed.

This manual explains how to operate your LifeBook notebook's hardware and built-in system software.

Conventions Used in the Guide

Keyboard keys appear in brackets.

Example: [Fn], [F1], [Esc], [Enter] and [Ctrl].

Pages with additional information about a specific topic are cross-referenced within the text.

For example: (See page xx.)

On screen buttons or menu items appear in bold

Example: Click **OK** to restart your LifeBook notebook.



The **information** icon highlights information that will enhance your understanding of the subject material.



The **caution** icon highlights information that is important to the safe operation of your computer, or to the integrity of your files. Please read all caution information carefully.



The **warning** icon highlights information that can be hazardous to either you, your LifeBook notebook, or your files. Please read all warning information carefully.

FUJITSU CONTACT INFORMATION

Service and Support

You can contact Fujitsu Service and Support in the following ways:

- Toll free: 1-800-8Fujitsu (1-800-838-5487)
- E-mail: 8fujitsu@us.fujitsu.com
- Website:
<http://www.computers.us.fujitsu.com/support>

Before you place the call, you should have the following information ready so that the customer support representative can provide you with the fastest possible solution:

- Product name
- Product configuration number
- Product serial number
- Purchase date
- Conditions under which the problem occurred
- Any error messages that have occurred
- Type of device connected, if any

Fujitsu Online

You can go directly to the online Fujitsu Product catalog for your LifeBook notebook by going to:

www.shopfujitsu.com.



You must have an active internet connection to use the online URL links.

LIMITED WARRANTY

Your LifeBook notebook is backed by a Fujitsu International Limited Warranty. Check the service kit that came with your notebook for the Limited Warranty period and terms and conditions.

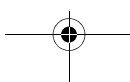

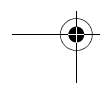
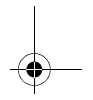
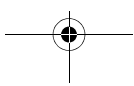
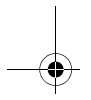
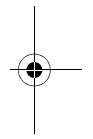
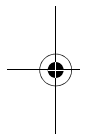
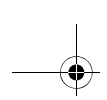

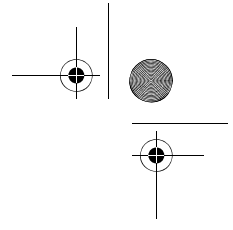
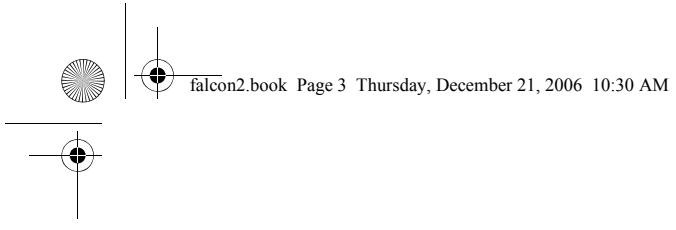

2

Getting to Know Your LifeBook Notebook

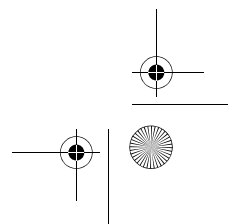
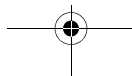
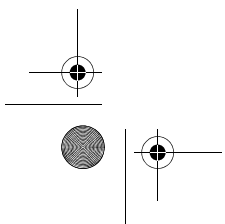
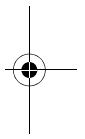
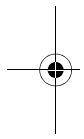

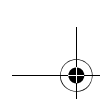

LifeBook A3000 Series Notebook - Section Two

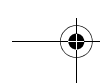
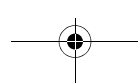
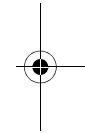
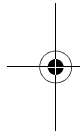

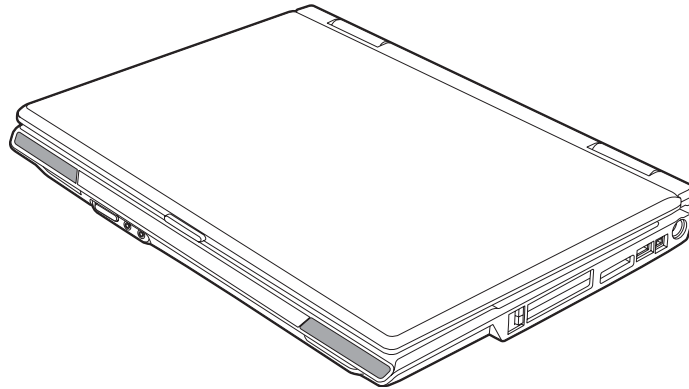

Figure 2-1. Fujitsu LifeBook A3120 notebook

Overview

This section describes the components of your Fujitsu LifeBook A3120 notebook. We strongly recommend that you read it before using your notebook – even if you are already familiar with notebook computers.

UNPACKING

When you receive your LifeBook notebook, unpack it carefully and compare the parts you have received with the items listed below.

For a pre-configured model you should have:

- LifeBook A3120 notebook (*Figure 2-1*)
- AC adapter with AC power cord (*Figure 2-2*)
- Lithium ion Battery, pre-installed
- Driver and Application Restore (DAR) disc
- Phone/Modem (RJ-11) telephone cable
- Getting Started Guide
- User's Guide (this document)
- International Limited Warranty Brochure
- Microsoft®-associated product materials

Depending on your system configuration, the following optional item may be included with your system:

- Additional battery
- ExpressCard TV Tuner
- Remote control package (for Windows Vista™ Home Premium models)
- External USB floppy disk drive
- Point and Write Pad stylus

Depending on your configuration, you may receive the following application CDs:

- Cyberlink Application CDs

Once you have checked and confirmed that your LifeBook system is complete, read through the following pages to learn about all of your notebook's components.

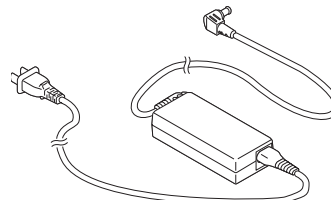
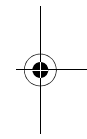
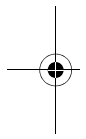

Figure 2-2 AC Adapter





LifeBook A3000 Series Notebook - Section Two

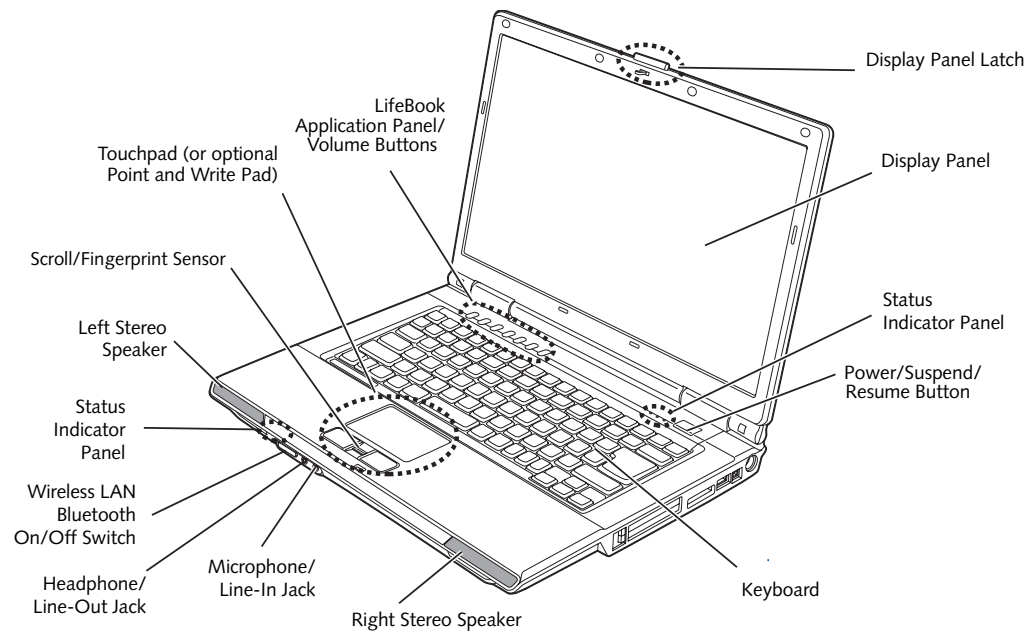

Figure 2-3. LifeBook notebook with display open

Locating the Controls and Connectors

TOP COMPONENTS

The following is a brief description of your LifeBook notebook's top components.

Display Panel

The display panel is a color LCD panel with back lighting for the display of text and graphics.

Status Indicator Panel

The Status Indicator Panel displays symbols that correspond with a specific component of your LifeBook notebook. Note that the Status Indicator Panel is divided into two different locations. (See *Status Indicator Panel on page 11 for more information*)

Power/Suspend/Resume Button

The Power/Suspend/Resume button allows you to suspend notebook activity without powering off, resume your LifeBook notebook from suspend mode, and power on your notebook when it has been shut down from Windows. (See *Power/Suspend/Resume Button on page 27 for more information*)

Keyboard

A full-size keyboard with dedicated Windows keys. (See *Keyboard on page 13 for more information*)

Stereo Speakers

The built-in dual speakers allow for stereo sound.

Microphone/Line-In Jack

The microphone/line-in jack allows you to connect an external stereo microphone. (See *Microphone/Line-In Jack on page 43 for more information*)

Headphone/Line-Out Jack

The headphone/line-out jack allows you to connect headphones. (See *Optical Digital Audio Connector on page 46 for more information*)

Wireless LAN/Bluetooth On/Off Switch

The wireless LAN/Bluetooth on/off switch is used to turn on and off the WLAN and Bluetooth devices. Switching the device off when not in use will help to extend battery life. (Note that either or both devices can be turned on and off using this switch). (See *Activating the WLAN Device on page 87 for more information*)

Touchpad Pointing Device

The touchpad pointing device is a mouse-like cursor control with three buttons: right and left mouse-like buttons and a scroll /fingerprint sensor. Note that certain models have an optional Point and Write Pad rather than the standard touchpad that uses stylus input as well as finger input. (See *Touchpad Pointing Device on page 15 for more information*). The scroll button may be used as a fingerprint sensor device. (See *Fingerprint Sensor Device on page 97 for more information*).

LifeBook Application Panel/Volume Buttons

The LifeBook Application Panel/Volume Buttons provides one-touch application launch and volume up/down capabilities. (See *LifeBook Application Panel on page 19 for more information*)

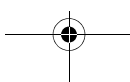

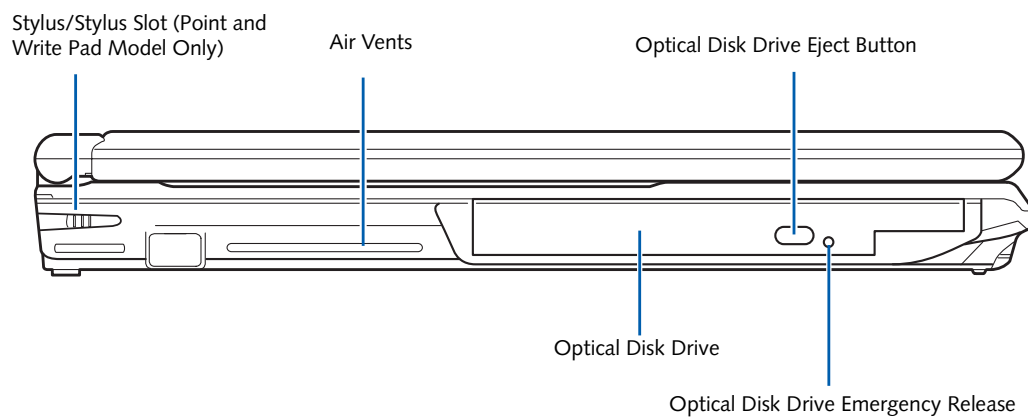
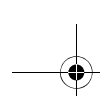

Figure 2-4. LifeBook notebook left-side panel

LEFT-SIDE PANEL COMPONENTS

The following is a brief description of your LifeBook notebook's left-side components.

Stylus/Stylus Slot

The stylus and stylus slot are found only on LifeBook models which have the optional Point and Write Pad rather than the standard touchpad. (See *Touchpad Pointing Device* on page 15 for more information)

Air Vents

The air vents are used to cool the system to prevent overheating.



To protect your notebook from damage and to optimize system performance, be sure to **keep all air all vents unobstructed, clean, and clear of debris**. This may require periodic cleaning, depending upon the environment in which the system is used.

Do not operate the notebook in areas where the air vents can be obstructed, such as in tight enclosures or on soft surfaces like a bed or cushion.

Optical Disk Drive

The optical disk drive allows you to burn and play back media discs. (See *Optical Disk Drive* on page 33 for more information)



"Media" and "media disc" in this document refer to any of the media that can be used by this drive, including -- among others -- DVD, DVD-R, DVD+R, Dual-layer DVD, DVD-RW, DVD+RW, CD-ROM, CD-R, or CD-RW formats.

Optical Disk Drive Emergency Release

The Optical Drive Emergency Release allows you to open the media player tray without powering on your LifeBook notebook. (See *Emergency Media Tray Release* on page 34 for more information)

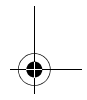
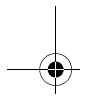
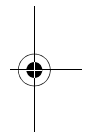
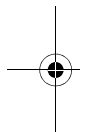

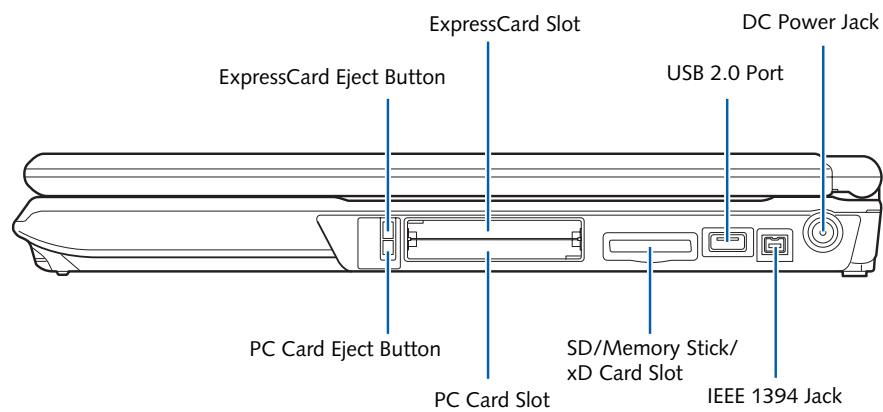

Figure 2-5. LifeBook notebook right-side panel

RIGHT-SIDE PANEL COMPONENTS

The following is a brief description of your LifeBook notebook's right-side components.

ExpressCard Eject Button

The ExpressCard eject button is used for removing an ExpressCard from the slot.

ExpressCard Slot

The ExpressCard slot allows you to insert an ExpressCard. (See *PC Cards/ExpressCards™* on page 38 for more information)

USB 2.0 Ports

The USB 2.0 ports allow you to connect Universal Serial Bus devices. USB 2.0 transfers data at up to 480 Mbps and is backward compatible with USB 1.1 devices, which transfer data at up to 12 Mbps. There is a total of five USB 2.0 ports on your system: one on the right side and four in the back. (See *Universal Serial Bus Ports* on page 42 for more information)

DC Power Jack

The DC power jack allows you to plug in the AC adapter to power your LifeBook notebook and charge the internal Lithium ion battery.

IEEE 1394 (4-pin) Jack

The 4-pin 1394 jack is used to connect between your notebook and an IEEE 1394 peripheral such as a digital video camera. (See *IEEE 1394 Port* on page 43 for more information)

SD/Memory Stick/xD Picture Card Slot

The Secure Digital/Memory Stick/xD Picture card slot allows you to insert a memory card for data storage. This architecture allows you to transfer data from a variety of different digital devices. (See *Inserting Memory Stick/SD/xD Cards* on page 36 for more information)

PC Card Slot

The PC Card Slots allow you to insert a Type I or Type II PC Card. (See *PC Cards/ExpressCards™* on page 38 for more information)

PC Card Eject Button

The PC Card eject button is used for removing a PC Card from the slot.

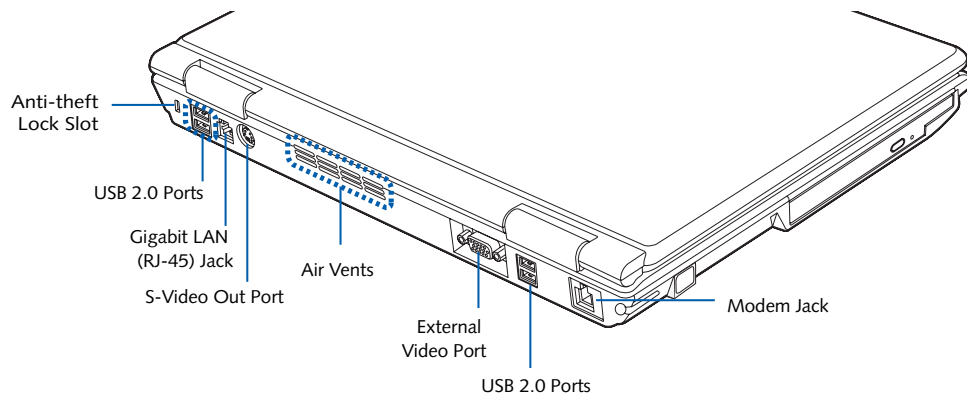

Figure 2-6. LifeBook notebook back panel

BACK PANEL COMPONENTS

Following is a brief description of your LifeBook notebook's back panel components.

Anti-theft Lock Slot

The anti-theft lock slot allows you to attach an optional physical lock down device.

USB 2.0 Ports

The USB 2.0 ports allow you to connect Universal Serial Bus devices. USB 2.0 transfers data at up to 480Mbps and is backward-compatible with USB 1.1 devices, which transfer data at up to 12Mbps. There is a total of five USB 2.0 ports on your system: one on the right side and four in the back. (See *Universal Serial Bus Ports* on page 42 for more information)

Gigabit LAN (RJ-45) Jack

The internal LAN (RJ-45) jack is used for an internal Gigabit (10Base-T/100Base-Tx/1000Base-T) Ethernet LAN connection. (See *Internal LAN (RJ-45) Jack* on page 42 for more information)

S-Video Out Port

The S-Video output is used to transmit a high resolution video signal to a compatible TV or VCR. (See *S-Video Out Port* on page 43 for more information)

Air Vents

The air vents are used to cool the system to prevent overheating.



To protect your notebook from damage and to optimize performance, be sure to **keep all air all vents unobstructed, clean, and clear of debris**. They may require periodic cleaning, depending upon the environment in which the system is used.

Do not operate the notebook in areas where the air vents can be obstructed, such as in tight enclosures or on soft surfaces like a bed or cushion.

External Video Port

The external video port allows you to connect an external monitor or LCD projector. (See *External Video Port* on page 43 for more information)

Modem (RJ-11) Telephone Jack

The Modem (RJ-11) telephone jack is for attaching a telephone line to the internal multinational 56K modem. (See *Modem (RJ-11) Telephone Jack* on page 42 for more information)



The internal modem is not intended for use with Digital PBX systems. Do not connect the internal modem to a Digital PBX as it may cause serious damage to the internal modem or your entire notebook. Consult your PBX manufacturer's documentation for details. Some hotels have Digital PBX systems. Be sure to find out BEFORE you connect your modem.



The internal multinational modem is designed to the ITU-T V.90/v.92 standard. Its maximum speed of 53000bps is the highest allowed by FCC, and its actual connection rate depends on the line conditions. The maximum speed is 33600 bps at upload, in accordance with FCC regulations.

For additional information about the modem, refer to the Fujitsu website at: <http://www.computers.us.fujitsu.com>

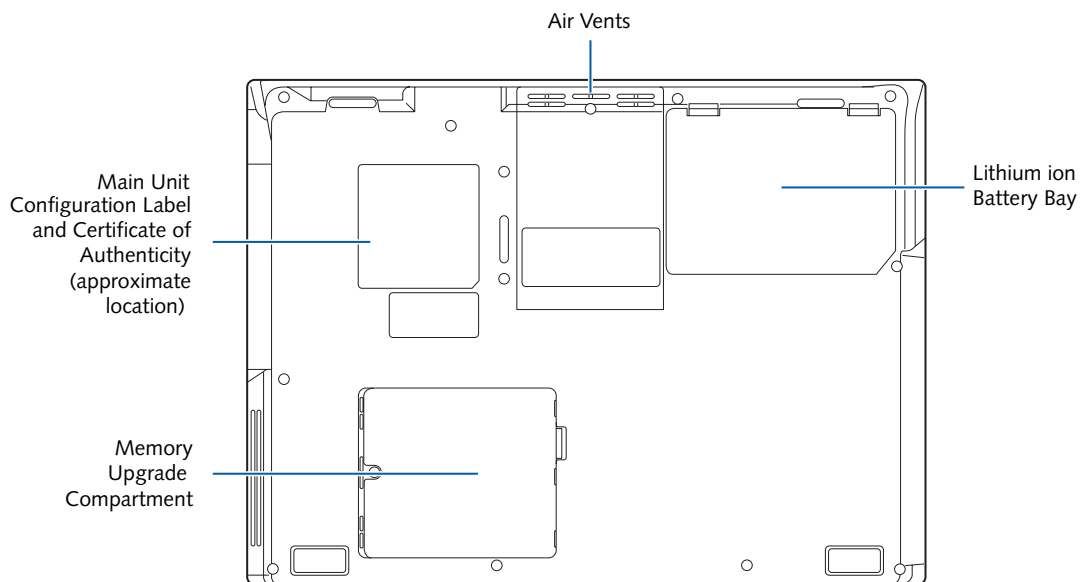
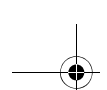

Figure 2-7. LifeBook notebook bottom panel

BOTTOM COMPONENTS

The following is a brief description of your LifeBook notebook's bottom panel components.

Main Unit and Configuration Label

The configuration label shows the model number and other information about your notebook. In addition, the configuration portion of the label has the serial number and manufacturer information that you will need to give your support representative. It identifies the exact version of various components of your notebook.

Air Vents

The air vents are used to cool the system to prevent overheating.

Lithium ion Battery Bay

The battery bay contains the internal Lithium ion battery. It can be opened for the removal of the battery when stored over a long period of time or for swapping a discharged battery with a charged Lithium ion battery. (See *Lithium ion Battery* on page 31 for more information)

Memory Upgrade Compartment

Your notebook comes with high speed Double Data Rate Synchronous Dynamic RAM (DDR SDRAM). The memory upgrade compartment allows you to expand the system memory capacity of your notebook, thus improving overall performance. (See *Memory Upgrade Module* on page 40 for more information).



To protect your notebook from damage and to optimize system performance, be sure to **keep all air all vents unobstructed, clean, and clear of debris**. This may require periodic cleaning, depending upon the environment in which the system is used.

Do not operate the notebook in areas where the air vents can be obstructed, such as in tight enclosures or on soft surfaces like a bed or cushion.



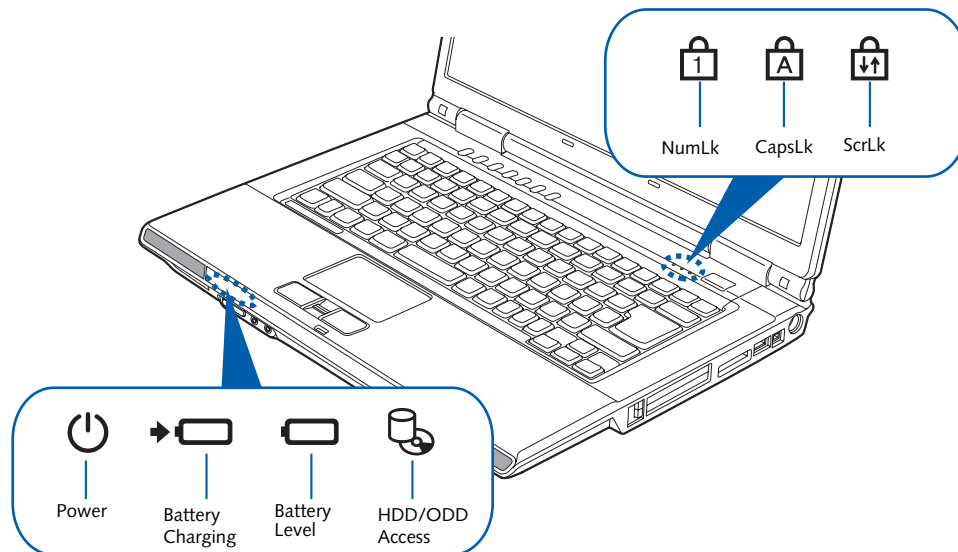

Figure 2-8. Status Indicator Panel

Status Indicator Panel

The Status Indicator displays symbols that correspond with a specific component of your Fujitsu LifeBook notebook. These symbols tell you how each of those components are operating. (Figure 2-8)

POWER INDICATOR

The Power indicator symbol states whether your system is operational. It has several different states, each of which tells you the mode your notebook is in.

- **Steady On:** This means that there is power to your LifeBook notebook and that it is ready for use.
- **Flashing:** This means that your notebook is in Standby mode.
- **Steady Off:** This means that your system is either in Save-to-Disk mode, or that your notebook has been turned off.

If you are charging your battery, the Power indicator will remain on even if your notebook is shut off. The Power indicator will also remain on if you have either adapter connected and are shut down from Windows.

BATTERY CHARGING INDICATOR

When the AC adapter is connected to your system, this indicator shows the status of the battery charging, as follows:

- **Green, solid:** The battery is either fully charged or the AC adapter is connected and there is no battery pack installed.
- **Orange, solid:** The battery pack is charging.

- **Orange, blinking:** Charging is suspended due to excessively high or low battery temperature.
- **Off:** No AC adapter is connected.

BATTERY LEVEL INDICATOR

The Battery Level indicator displays the charge level of the battery pack, as follows:

- **Green, solid:** Battery is between 51% and 100% charged.
- **Orange, solid:** Battery is between 13% and 50% charged.
- **Red, solid:** Battery is between 0% and 12% charged.
- **Orange, blinking:** Blinks during battery status measurement (Four seconds after the battery is installed).
- **Red, blinking:** There is a problem with the battery.
- **Off:** There is no battery installed.



- If the battery pack is installed while the power is turned off, the battery level indicator will display the charge level for five seconds after it blinks orange.
- If the AC adapter is not connected or the battery pack is not fully charged when the computer is switched to standby mode, the indicator will blink. The LED blinks at the rate of one second on/five seconds off.



- Batteries subjected to shocks, vibration or extreme temperatures can be permanently damaged.
- A shorted battery is damaged and must be replaced.



HDD/ODD ACCESS INDICATOR

The Hard Disk Drive/Optical Disk Drive Access indicator tells you that the drive is being accessed. If the Auto Insert Notification function is active, the indicator will flash periodically when your system is checking the optical drive. If the Auto Insert Notification function is not active, the indicator will only flash when you access the drive. The default setting is the Auto Insert Notification function active.



The Auto Insert Notification function will periodically check for a disc installed in the drive, causing the HDD/ODD Access indicator to flash. The Auto Insert Notification function allows your system to start an optical disc automatically as soon as it is inserted in the drive and the tray is closed. It will begin playing an audio DVD/CD or will start an application if the DVD/CD has an auto-run file



NUMLK INDICATOR

The NumLk indicator states that the integral keyboard is set in ten-key numeric keypad mode.



CAPSLCK INDICATOR

The CapsLock indicator states that your keyboard is set to type in all capital letters.



SCRCLK INDICATOR

The ScrLk indicator states that your scroll lock is active.

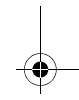
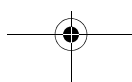
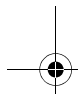
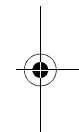
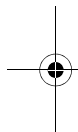

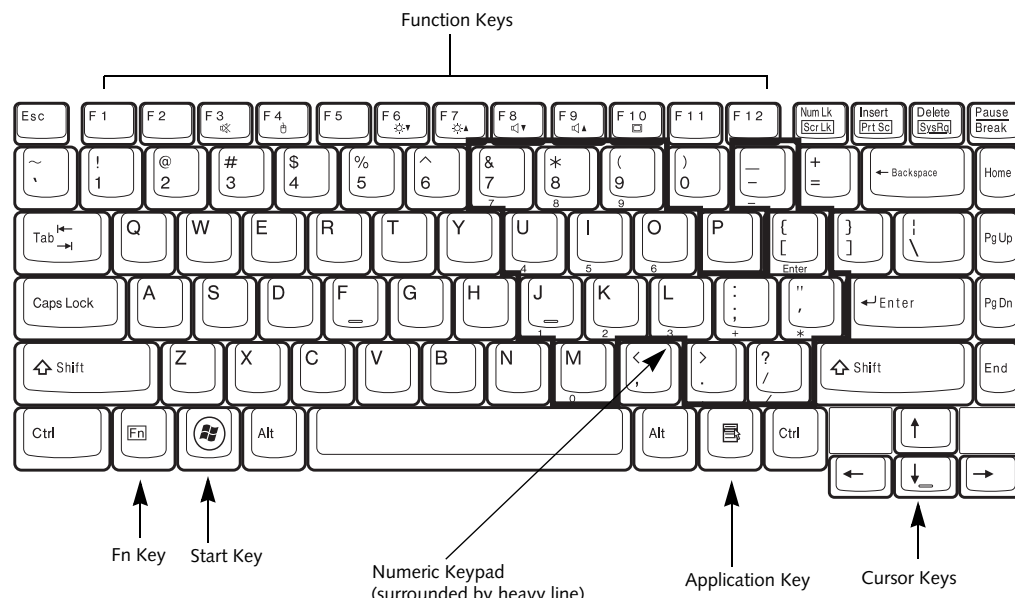

Figure 2-9 Keyboard

Keyboard

USING THE KEYBOARD

Your LifeBook notebook has an integral 86-key keyboard. The keys perform all the standard functions of a 101-key keyboard, including the Windows keys and other special function keys. This section describes the following keys.

- Numeric keypad
- Cursor keys
- Function keys
- Windows keys

NUMERIC KEYPAD

Certain keys on the keyboard perform dual functions as both standard character keys and numeric keypad keys. NumLk can be activated by pressing the [NumLk] keys. Turning off the NumLk feature is done the same way. Once this feature is activated you can enter numerals 0 through 9, perform addition (+), subtraction (-), multiplication (*), or division (/), and enter decimal points (.) using the keys designated as ten-key function keys. The keys in the numeric keypad are marked on the front edge of the key to indicate their secondary functions.

WINDOWS KEYS

Your LifeBook notebook has two Windows keys, consisting of one Start key and one Application key. The Start key displays the Start menu. This button functions the same as your on-screen Start menu button. The

Application key functions the same as your right mouse button and displays shortcut menus for the selected item. (Refer to your Windows documentation for additional information regarding the Windows keys.)

CURSOR KEYS

The cursor keys are the four arrow keys on the keyboard which allow you to move the cursor up, down, left and right in applications. In programs such as Windows Explorer, it moves the "focus" (selects the next item up, down, left, or right).

FUNCTION KEYS

Your LifeBook notebook has 12 function keys, F1 through F12. The functions assigned to these keys differ for each application. You should refer to your software documentation to find out how these keys are used.

The [Fn] key provides extended functions for the LifeBook notebook and is always used in conjunction with another key.

- [Fn+F3]: Pressing [F3] while holding [Fn] will toggle the Audio Mute on and off.
- [Fn+F4]: Pressing [F4] while holding down [Fn] allows you to toggle between an internal mouse (touchpad) and an external mouse (USB-type).
- [Fn+F5]: Pressing [F5] while holding [Fn] allows you to toggle between video compensation and no compensation. (Video compensation controls spacing on the display. When it is enabled, displays with less than 1280 x 800 or 800 x 600 pixel resolution will still cover the entire screen.)

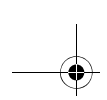

LifeBook A3000 Series Notebook - Section Two

- [Fn+F6]: Pressing [F6] repeatedly while holding [Fn] will lower the brightness of your display.
- [Fn+F7]: Pressing [F7] repeatedly while holding [Fn] will increase the brightness of the display.
- [Fn+F8]: Pressing [F8] repeatedly while holding [Fn] will decrease the volume of your LifeBook notebook.
- [Fn+F9]: Pressing [F9] repeatedly while holding [Fn] will increase the volume of your LifeBook notebook.
- [Fn+F10]: Pressing [F10] while holding [Fn] allows you to change your selection of where to send your display video. Each time you press the combination of keys you will step to the next choice. The choices, in order, are: built-in display panel only, both built-in display panel and external monitor or external monitor only.

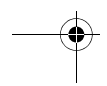
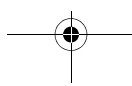
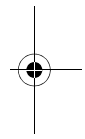
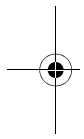

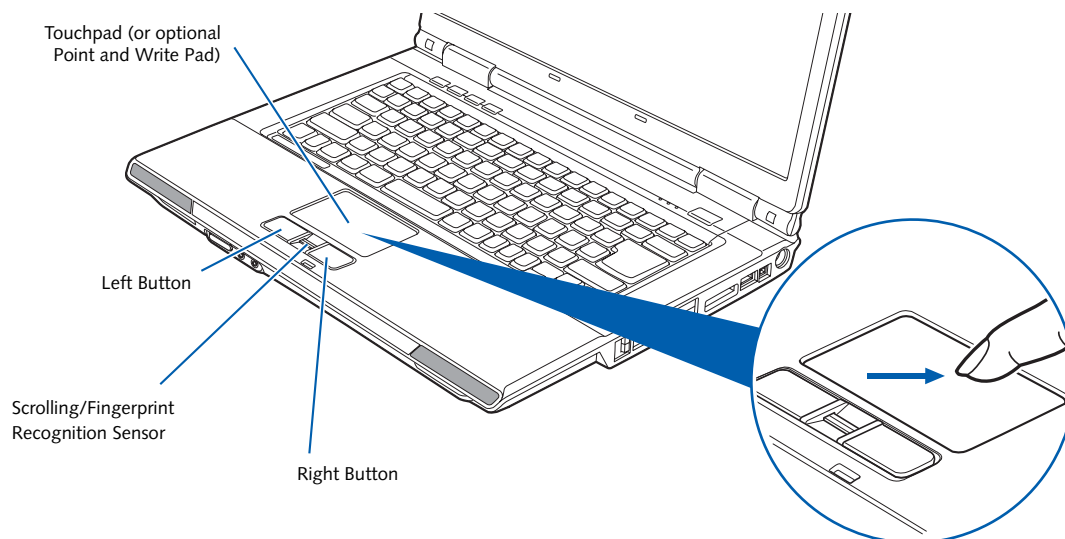

Figure 2-10. Touchpad pointing device

Touchpad Pointing Device

The Touchpad pointing device comes built into your LifeBook notebook. It is used to control the movement of the pointer to select items on your display panel. The Touchpad is composed of a cursor control, a left and right button, and a scrolling /fingerprint sensor.



Note that certain configurations of this system have an optional Point and Write Pad instead of a touchpad pointing device. (See *Optional Point and Write Pad* on page 16 for more information).

The cursor control works the same way a mouse does, and moves the cursor around the display. It only requires light pressure with the tip of your finger.

The scrolling sensor allows you to navigate quickly through pages. Note that the scrolling sensor is also used as a Fingerprint Recognition Sensor. (See *Fingerprint Sensor Device* on page 99 for more information)

The left and right buttons function the same as mouse buttons. The functionality of the buttons may vary depending on the application being used. (Figure 2-10)



An external mouse can be connected to a USB port on your LifeBook notebook and used simultaneously with the Touchpad. However, if you boot the system with an external mouse connected the Touchpad will be disabled or enabled depending on the specifications in your BIOS settings. (See *BIOS Setup Utility* on page 25 for more information)

CLICKING

Clicking means pushing and releasing a button. To left-click, move the cursor to the item you wish to select, press the left button once, and then immediately release it. To right-click, move the mouse cursor to the item you wish to select, press the right button once, and then immediately release it. You also have the option to perform the clicking operation by tapping lightly on the Touchpad once. (Figure 2-11)

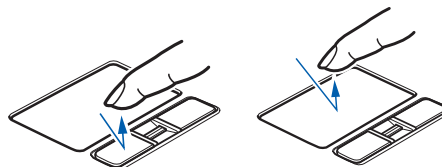

Figure 2-11 Clicking methods

DOUBLE-CLICKING

Double-clicking means pushing and releasing the left button twice in rapid succession. This procedure does not function with the right button. To double-click, move the cursor to the item you wish to select, press the left button twice, then immediately release it. You also have the option to perform the double-click operation by tapping lightly on the Touchpad twice. (Figure 2-12)

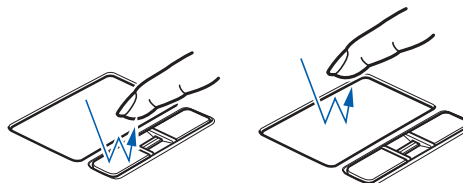

Figure 2-12 Double-clicking methods





- If the interval between clicks is too long, the double-click will not be executed.
- Parameters for the Touchpad can be adjusted from the Mouse Properties dialog box located in the Windows Control Panel.

DRAGGING

Dragging means pressing and holding the left button, while moving the cursor. To drag, move the cursor to the item you wish to move. Press and hold the left button while moving the item to its new location and then release it. Dragging can also be done using the Touchpad. First, tap the Touchpad twice over the item you wish to move making sure to leave your finger on the pad after the final tap. Next, move the object to its new location by moving your finger across the Touchpad, and then release your finger. (Figure 2-13)

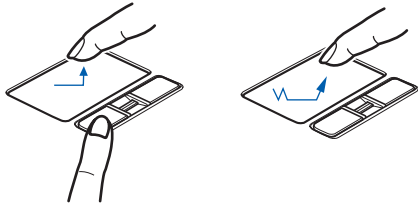

Figure 2-13 Dragging methods

SCROLLING

Using the scrolling sensor allows you to navigate through a document quickly without using the window's scroll bars. This is particularly useful when you are navigating through online pages. To use the scrolling sensor, move your finger forward or backward across the button to scroll up or down a page. When you have reached the desired section of the page, raise your finger. (Figure)

Note that you can also scroll by sliding your finger up and down the right side of the touchpad. This feature is disabled by default, but you can enable it by going to Start -> Control Panel -> Mouse.

The scrolling sensor is also used as a fingerprint sensor. To use the fingerprint sensor device, refer to the appendix of this document. (See *Fingerprint Sensor Device on page 99 for more information*)

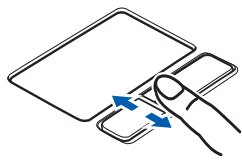

Figure 2-14 Scrolling

TOUCHPAD CONTROL ADJUSTMENT

The Windows Control Panel allows you to customize your Touchpad with selections made from within the Mouse Properties dialog box.

OPTIONAL POINT AND WRITE PAD

Certain configurations of this LifeBook notebook have an optional Point and Write Pad in the location of the touchpad pointing device. The Point and Write Pad is compatible with the latest Microsoft Windows Vista operating system. For example, use MS Journal for notetaking with the pad, and use MS Paint for drawing pictures.

The Point and Write Pad enriches the user's experience by enabling powerful note-taking, handwriting recognition, and fast navigation options under the Vista environment that allow the user to quickly and intuitively get results faster and more efficiently. (Figure 2-15)

The Point and Write Pad stylus is used on the pad just as if it were a pen writing on paper.

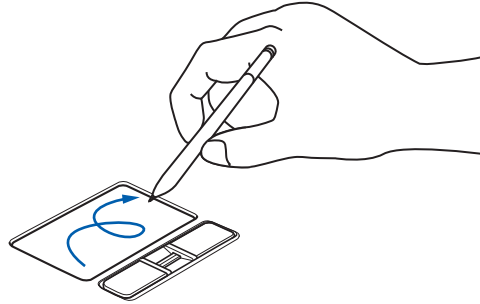
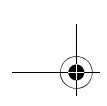

Figure 2-15 Writing on the Point and Write Pad

Using the Optional Point and Write Pad

1. Remove the stylus from the stylus slot on the rear left side of the system. (See *Left-Side Panel Components on page 7 for more information*).
2. You can use the Point and Write Pad for clicking, double-clicking, scrolling, and dragging, just as you would with a touch pad. To use the Point and Write Pad for these functions, follow the instructions above for the touchpad, substituting the stylus for your finger.



Getting to Know Your LifeBook



- The stylus should not be used to tap on the display; it has no effect on the display, and could cause damage to the screen if so used.
- When using the stylus on the pad, you cannot use your finger to control the touchpad. If you want to use your finger on the touchpad, keep the stylus away from the pad, or it might interfere with the operation.
- Right-click function is not supported by the stylus. Use the right button for right-click functions.
- Use the stylus gently on the pad so as not to damage the stylus or pad. Little pressure is required for the stylus to work effectively.
- Be careful not to leave the stylus on the keyboard or palm rest when closing the display.
- To change the double-tap speed, go to Control Panel -> Other Options -> Flatpoint Digitizer.

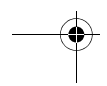
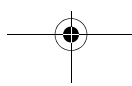
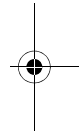
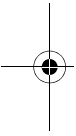

Volume Control

Your Fujitsu LifeBook notebook has multiple volume controls which interact with each other.



Software that contains audio files will also contain a volume control of its own. If you install an external audio device that has an independent volume control, the hardware volume control and the software volume control will interact with each other. It should be noted that if you set your software volume to Off, you will override the external volume control setting.

CONTROLLING THE VOLUME

The volume can be controlled in several different ways:

- Volume can be set using the volume buttons to the right of the application buttons above the left of the keyboard. The buttons are labeled “- Vol” and “Vol +”. (Figure 2-16)

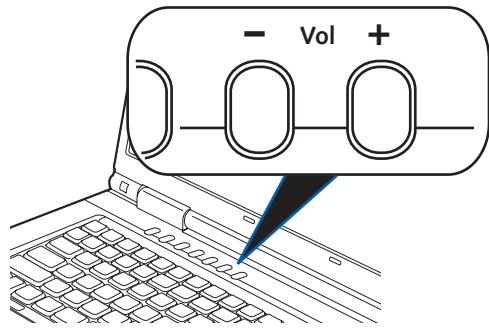

Figure 2-16 Volume buttons

- Volume can be set from within the Volume Control on the Taskbar.
- Volume can be controlled with the F8 and F9 functions keys. Pressing [F8] repeatedly while holding [Fn] will decrease the volume of your notebook. Pressing [F9] repeatedly while holding [Fn] will increase the volume of your notebook.
- Volume can be controlled by many volume controls that are set within individual applications.
- Certain external audio devices you might connect to your system may have hardware volume controls.

Each source discussed above puts an upper limit on the volume level that must then be followed by the other sources.

We recommend that you experiment with the various volume controls to discover the optimal sound level.

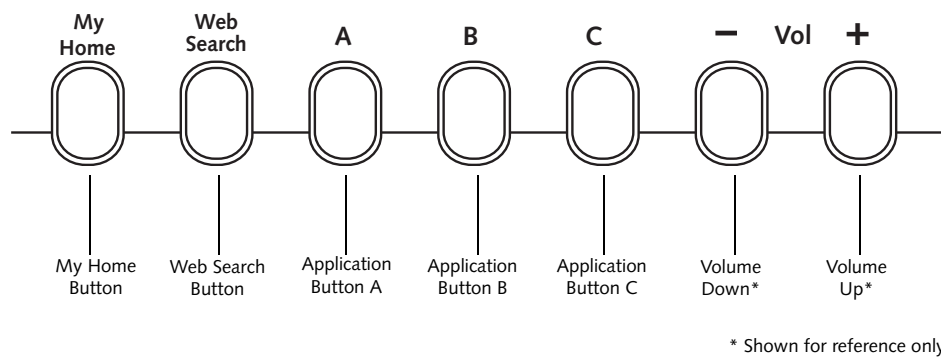

Figure 2-17. LifeBook Application Panel

LifeBook Application Panel

A unique feature of your notebook is the LifeBook Application Panel. The Application Panel makes your LifeBook notebook more than just another computer. This panel allows you to launch selected applications with the touch of a button.

Your LifeBook notebook is pre-installed with software utilities that let you operate and configure your LifeBook Application Panel. These utilities are found under [Start] -> All Programs -> Application Panel.

The panel consists of five buttons, labeled “My Home”, “Web Search”, “A”, “B”, and “C”. Pressing any of the application buttons will launch a user-defined application. The defaults are as follows:

Button Label	Default Application
My Home	Default Browser
Web Search	www.google.com
A	Notepad
B	Calculator
C	Unassigned

CONFIGURING THE APPLICATION PANEL

When you start your system, the LifeBook Application Panel is automatically activated. As an application launcher, the LifeBook Application Panel is very flexible, giving you a variety of options. To set up the panel to best suit your needs, the Application Panel Setup utility will quickly and easily help you make the most of this valuable feature.

By default, pressing the “My Home” button will open the Fujitsu Computer Systems Corporation home page.

Pressing the “Web Search” button will open the Google search page.

Pressing the “A” or “B” buttons will open Notepad and Calculator, respectively. (Note that the “C” button is initially unassigned).

Any of these button defaults can be changed using the following procedure.

To configure your LifeBook Application Panel with the Application Panel Setup utility:

1. Click on [Start] -> All Programs.
2. Select **LifeBook Application Panel** from the drop-down menu, then click on **Setup of LifeBook Application Panel**. The **Button Setting** window will open.

The Button Setting window has tabs that correspond to the buttons on the application panel. When you receive your notebook, these buttons are pre-configured to launch specific programs, as noted above.

In order to reconfigure a button to launch a different program, follow these steps:

1. On the Button Setting window, click the tab of the button you want to configure.
2. Ensure that the “Enable this button” check box is selected, then click the [Application registration...] button.
3. You can either select an application from the Start menu, or select an application directly by clicking the “Select from Start Menu” or “Select directly” button, respectively.
4. Once you’ve selected an application, click [Next].
5. In the next window, you can select to play a sound when the application starts.
6. Click [Finish] to complete the procedure. After this point, whenever you click the appropriate application button, the application to which you assigned it will start.



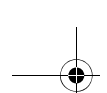

LifeBook A3000 Series Notebook - Section Two

At the bottom of each application setup page are two selectable options. The first will enable/disable the button when your LifeBook notebook is in Standby mode, and the second will enable/disable the button when your LifeBook notebook is powered off. You can enable/disable either or both of these functions simply by clicking on the option.

When you have finished with Button Setting window, click on **OK**, and the new settings will take effect. You can reconfigure your LifeBook Application Panel as often as you like.



If you choose to use the buttons when the notebook is in standby or turned off, they will function even if hit accidentally, and will turn on your notebook even if you are not using the notebook. This could deplete your battery, and you will need to recharge it before using the notebook.

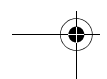
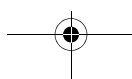
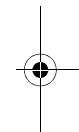
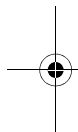

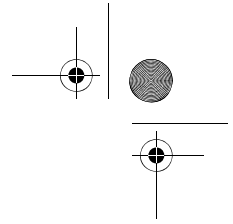
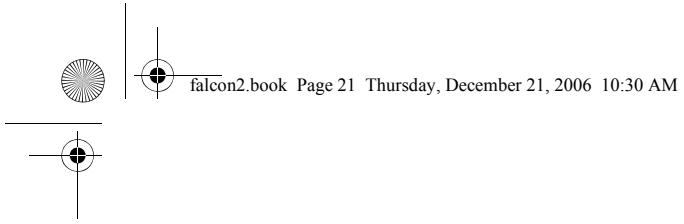

3 Getting Started

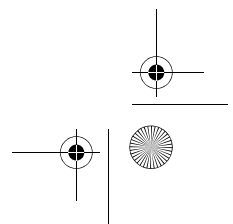
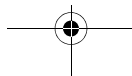
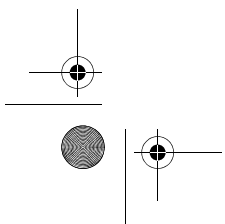
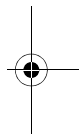
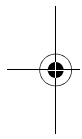

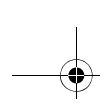

LifeBook A3000 Series Notebook - Section Three

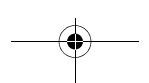
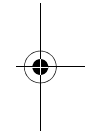
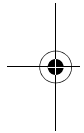

Getting Started

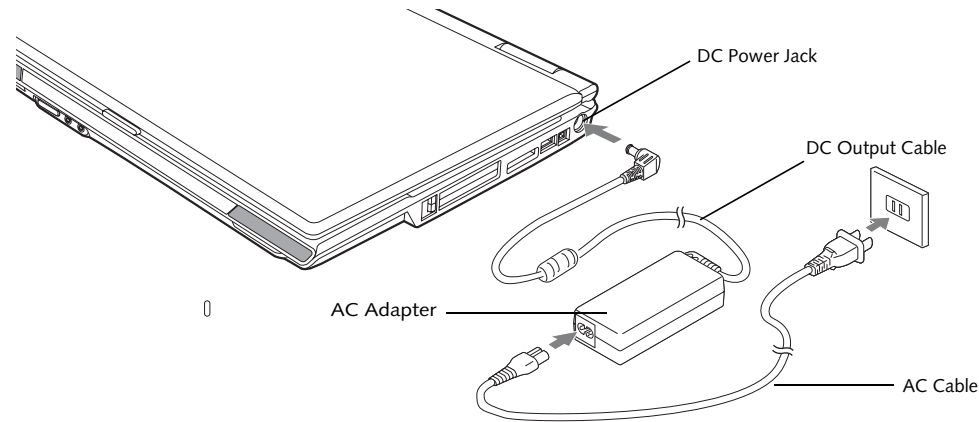

Figure 3-1 Connecting the AC Adapter

Power Sources

Your Fujitsu LifeBook notebook has three possible power sources: a primary Lithium ion battery, an AC adapter or an optional Auto/Airline adapter.

CONNECTING THE POWER ADAPTERS

The AC adapter or optional Auto/Airline adapter provides power for operating your notebook and charging the batteries.

Connecting the AC Adapter

1. Plug the DC output cable into the DC power jack of your LifeBook notebook.
2. Plug the AC adapter into an AC electrical outlet. (Figure 3-1)

Connecting the Optional Auto/Airline Adapter

1. Plug the DC output cable into the DC power jack on your notebook.

2. Plug the Auto/Airline adapter into the cigarette lighter of an automobile with the ignition key in the On or Accessories position.

OR

3. Plug the Auto/Airline adapter into the DC power jack on an airplane seat.

Switching from AC Adapter Power or the Auto/Airline Adapter to Battery Power

1. Be sure that you have at least one charged battery installed.
2. Remove the AC adapter or the Auto/Airline adapter.



The Lithium ion battery is not charged upon purchase. Initially, you will need to connect either the AC adapter or the Auto/Airline adapter to use your notebook.

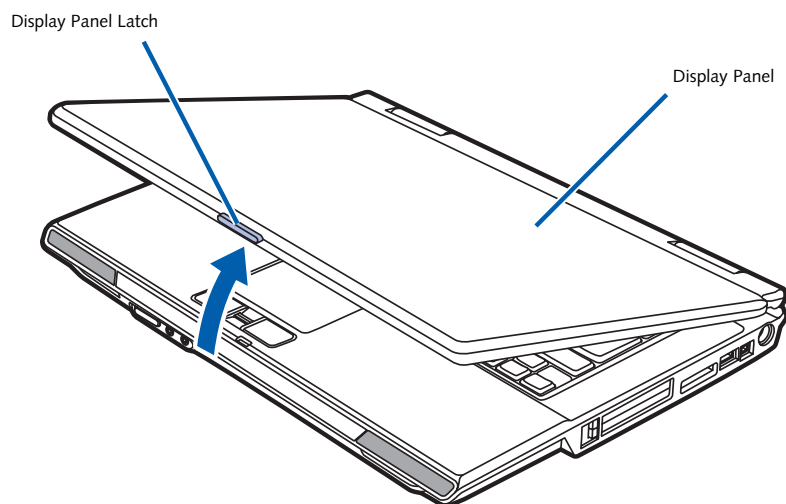

Figure 3-2 Opening the Display Panel

Display Panel

Your Fujitsu LifeBook notebook contains a display panel that is backlit for easier viewing in bright environments and maintains top resolution through the use of active-matrix technology.

OPENING THE DISPLAY PANEL

1. Press the Display Panel latch to release the locking mechanism, allowing you to raise the display.
2. Lift the display backwards, being careful not to touch the screen, until it is at a comfortable viewing angle. (Figure 3-2)

ADJUSTING DISPLAY PANEL BRIGHTNESS

Once you have turned on your LifeBook notebook, you may want to adjust the brightness level of the screen to a more comfortable viewing level. To adjust the brightness, use the keyboard function keys, as noted below.

Using the Keyboard

Adjusting the brightness using the keyboard changes the setting only temporarily.

- [Fn+F6]: Pressing repeatedly will lower the brightness of your display.
- [Fn+F7]: Pressing repeatedly will increase the brightness of the display.



- When using AC power your brightness setting is set to its highest level by default. When using battery power your brightness setting is set to approximately mid-level by default.
- The higher the brightness level, the more power the notebook will consume and the faster your batteries will discharge. For maximum battery life, make sure that the brightness is set as low as possible.

CLOSING THE DISPLAY PANEL

1. Holding the edge of your display panel, pull it forward until it is flush with the body of your LifeBook notebook.
2. Push down until you hear a click. This will engage the locking mechanism and prevent your display panel from opening unexpectedly.



Starting Your LifeBook Notebook

POWER ON

Power/Suspend/Resume Button

The Power/Suspend/Resume button is used to turn on your LifeBook notebook from its off state. Once you have connected your AC adapter or charged the internal Lithium ion battery, you can power on your LifeBook notebook. (See figure 2-3 on page 6 for location)



When you turn on your LifeBook notebook be sure you have a power source. This means that at least one battery is installed and charged, or that the AC or Auto/Airline adapter is connected and has power.

To turn on your LifeBook notebook from its off state, press the Power/Suspend/Resume button, located above the keyboard to the right. When you are done working you can either leave your LifeBook notebook in Standby mode, (See *Standby Mode* on page 27 for more information), or you can turn it off (See *Power Off* on page 28 for more information).



Do not carry your LifeBook notebook around with the power on or subject it to shocks or vibration, as you risk damaging your hard disk drive.

When you power on your LifeBook, it will perform a Power On Self Test (POST) to check the internal parts and configuration for correct functionality. If a fault is found, your LifeBook notebook will emit an audio warning and/or an error message will be displayed. (See *Power On Self Test Messages* on page 55 for more information) Depending on the nature of the problem, you may be able to continue by starting the operating system or by entering the BIOS setup utility and revising the settings.

After satisfactory completion of the Power On Self Test (POST), your notebook will load your operating system.



Never turn off your LifeBook notebook during the Power On Self Test (POST) or it will cause an error message to be displayed when you turn your LifeBook notebook on the next time. (See *Power On Self Test Messages* on page 55 for more information)

BOOT SEQUENCE

The procedure for starting up your notebook is called the Bootup sequence and involves your notebook's BIOS. When your LifeBook notebook is first turned on, the main system memory is empty, and it needs to find instructions to start up your notebook. This information is in the BIOS program. Each time you power up or restart your notebook, it goes through a boot sequence which displays a Fujitsu logo until your operating system is loaded. During booting, your notebook is performing a standard boot sequence including a Power On Self Test (POST). If the sequence is completed without a failure and without a request for the BIOS Setup Utility, the system displays the operating system's opening screen.

The boot sequence is executed when:

- You turn on the power to your LifeBook notebook.
- You restart your notebook from the Windows Shut Down dialog box.
- The software initiates a system restart. Example: When you install a new application.

HARD DISK DRIVE PASSWORDS

To provide additional data security, you can assign passwords to your hard disk drive. This feature is managed in the system BIOS Setup Utility. See *BIOS Setup Utility* below for information about accessing the utility.



Remember your passwords. If you set and forget your User and Master hard disk passwords, Fujitsu Computer Systems will not be able to reset it. You may lose data and have to replace your system board or hard disk drive.

BIOS SETUP UTILITY

The BIOS Setup Utility is a program that sets up the operating environment for your LifeBook notebook. Your BIOS is set at the factory for normal operating conditions, therefore there is no need to set or change the BIOS' environment to operate your notebook.

The BIOS Setup Utility configures:

- Device control feature parameters, such as changing I/O addresses and boot devices.
- System Data Security feature parameters, such as passwords.

Entering the BIOS Setup Utility

To enter the BIOS Setup Utility do the following:

1. Turn on or restart your LifeBook notebook.
2. Press the [F2] key when the Fujitsu logo appears on the screen. This will open the main menu of the BIOS Setup Utility with current settings displayed.
3. Press the [RIGHT ARROW] or [LEFT ARROW] key to scroll through the other setup menus to review or alter the current settings.

BIOS Guide

A guide to your notebook's BIOS is available online. Please visit our service and support website at: <http://www.us.fujitsu.com/computers>. Once there, select Support, then select Notebooks under User's Guides. Select LifeBook BIOS Guides from the pull-down menu for your LifeBook series. If you're unsure of the notebook's BIOS number, refer to your packing slip.



If your data security settings require it, you may be asked for a password before the BIOS main menu will appear.

BOOTING THE SYSTEM

We strongly recommend that you not attach any external devices and do not put a DVD/CD in your drive until you have gone through the initial power on sequence.

When you turn on your LifeBook notebook for the first time, it will display a Fujitsu logo on the screen. If you do nothing the system will load the operating system, and then the Windows Welcome will begin.



The first time you initialize your system, the screen will be blank for approximately two minutes. This is normal. After initialization, a "Set Up Windows" dialog box will appear.

Important: During the setup procedure, do not disconnect the power supply, press any buttons, or use any peripheral devices such as a mouse, keyboard, or remote control.

STARTING VISTA FOR THE FIRST TIME

In order to ensure that you receive the most benefits from the Windows operating system, it should be registered the first time you use it.

1. First of all, you will need to read and accept the End User License Agreements (EULAs).



- If you reject the terms of the license agreement you will be asked to review the license agreement for information on returning Windows or to shut down your LifeBook notebook.
- You cannot use your notebook until you have accepted the License Agreement. If you stop the process your notebook will return to the beginning of the Windows Welcome Process, even if you shut your notebook down and start it up again.

2. You will be prompted to enter your User Name and Password and you will be given a chance to select an icon for your account.

3. The next screen asks for a Computer Name and allows you to choose a desktop background.
4. You will next see a "Help protect Windows automatically" screen in which the default choice is "Use recommended settings". The other two choices are "Install important updates only" and "Ask me later". Select from the three choices.
5. On the next screen set your time and date settings.
6. You will next see the "Select your computer's current location" screen. Make your selection from Home, Work (Default), and Public location.
7. The "Thank you" screen follows and an offer for free Norton is extended. Following are several screens while Windows checks the system performance.
8. Windows will then boot up for the first time.

REGISTERING WINDOWS WITH MICROSOFT

1. After Windows has booted up for the first time, the Control Panel Welcome Center will appear. If the Register Windows Online icon is not seen in the window, click on "Show all 14 items".
2. Click on Register Windows Online and follow the instructions that appear to register your copy of Windows.

REGISTERING YOUR LIFEBOOK NOTEBOOK

How do I register my LifeBook notebook?

You can register your LifeBook by going to our website:

<http://www.us.fujitsu.com/computers>

You will need to be set up with an Internet Service Provider (ISP) to register online.



INSTALLING CLICK ME!

The first time you boot up your system, you will see a "Primary Settings for the PC" window. This window explains the installations which will be performed by the Click Me! utility. If you click [Execute], Click Me! will begin installing. If after clicking the button you receive a "User Account Control" window, you will be asked for your permission to continue. Click [Yes] to continue. If you cancel the operation, the Click Me! icon will appear on your desktop for later installation.

Power Management

Your Fujitsu LifeBook notebook has many options and features for conserving battery power. Some of these features are automatic and need no user intervention, such as those for the internal modem. However, others depend on the parameters you set to best suit your operating conditions, such as those for the display brightness. Internal power management for your notebook may be controlled from settings made in your operating system, pre-bundled power management application, or from settings made in BIOS setup utility.

Besides the options available for conserving battery power, there are also some things that you can do to prevent your battery from running down as quickly. For example, you can create an appropriate power saving profile, put your notebook into Standby mode when it is not performing an operation, and you can limit the use of high power devices. As with all mobile, battery powered computers, there is a trade-off between performance and power savings.

POWER/SUSPEND/RESUME BUTTON

When your notebook is active, the Power/Suspend/Resume button can be used to manually put the notebook into Standby mode. Push the Power/Suspend/Resume button when the notebook is active, but not actively accessing anything, and immediately release the button. The system will enter Standby mode.

If your notebook is suspended, pushing the Power/Suspend/Resume button returns your notebook to active operation. You can tell whether the system is in standby by looking at the Power indicator. (See *Figure 2-3 on page 6*) If the indicator is visible and not flashing, your notebook is fully operational. If the indicator is visible and flashing, your notebook is in Standby mode. If the indicator is not visible, the power is off or your notebook is in Hibernation mode. (See *Hibernation Feature*)

STANDBY MODE

Standby mode in Windows saves the contents of your system memory during periods of inactivity by maintaining power to critical parts. This mode will turn off the CPU, display, hard drive, and all the other internal components except those necessary to maintain system memory and allow for restarting. Your notebook can be put in Standby mode by:

- Pressing the Power/Suspend/Resume button when your system is turned on.
- Selecting Sleep from the Windows Shut Down menu.
- Timing out from lack of activity.
- Allowing the battery to reach the Dead Battery Warning condition.

Your notebook's system memory typically stores the file on which you are working, open application information, and any other data required to support operations in progress. When you resume operation from Standby mode, your notebook will return to the point where it left off. You must use the Power/Suspend/Resume button to resume operation, and there must be an adequate power source available, or your notebook will not resume.

- If you are running your notebook on battery power, be aware that the battery continues to discharge while your notebook is in Standby mode, though not as fast as when fully operational.
- Disabling the Power/Suspend/Resume button prevents it from being used to put the notebook into Standby or Hibernation (Save-to-Disk) mode. The button resume function cannot be disabled.
- The Standby or Hibernation (Save-to-Disk) mode should not be used with certain PC Cards. Check your PC Card documentation for more information. When PC Cards or external devices are in use, Hibernation (Save-to-Disk) mode cannot return to the exact state prior to suspension, because all of the peripheral devices will be re-initialized when the system restarts.
- If your notebook is actively accessing information when you enter the Standby or Hibernation (Save-to-Disk) mode, changes to open files are not lost. The files are left open and memory is kept active during Standby mode or the memory is transferred to the internal hard drive during Hibernation mode.

The main advantage of using Hibernation (Save-to-Disk) is that power is not required to maintain your data. This is particularly important if you will be leaving your notebook in a suspended state for a prolonged period of time. The drawback of using Hibernation mode is that it lengthens the power down and power up sequences and resets peripheral devices.



HIBERNATION (SAVE-TO-DISK) FEATURE

The Hibernation feature saves your system's memory contents to the hard drive as a part of the Standby/Resume mode. You can enable or disable this feature.

Enable or Disable the Hibernation Feature

The default settings are not enabled. To enable or disable the Hibernation feature follow these easy steps:

1. From the **Start** menu, select **Control Panel**.

3. Select "Choose what the power button does" or "Choose what closing the lid does", then make your selections (Do Nothing, Sleep, Hibernate, or Shut Down).

RESTARTING THE SYSTEM

If your system is on and you need to restart it, be sure that you use the following procedure.

1. Click the **Start** button, and then move the mouse over the right arrow.
2. Select the desired action from the list.



Turning off your notebook without exiting Windows, or turning it on within 10 seconds of being shut off may cause an error when you start the next time.

POWER OFF

Before turning off the power, check that the hard drive, optical drive, PC Card, and floppy disk indicators are all Off. (See Figure 2-3 on page 6). If you power-off while accessing a disk or PC Card there is a risk of data loss. To ensure that the notebook shuts down without error, use the Windows shutdown procedure.



Be sure to close all files, exit all applications, and shut down your operating system prior to turning off the power. If files are open when you turn the power off, you will lose any changes that have not been saved, and may cause disk errors.

Using the correct procedure to shut down from Windows allows your notebook to complete its operations and turn off power in the proper sequence to avoid errors. The proper sequence is:

1. Click the **Start** button, and then click the arrow at the bottom right.
2. From the dropdown menu, select **Shut Down** (or **Sleep** or **Hibernate**).

If you are going to store your notebook for a month or more see Care and Maintenance Section.

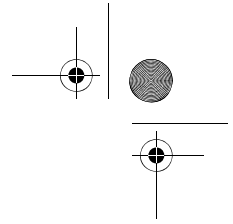
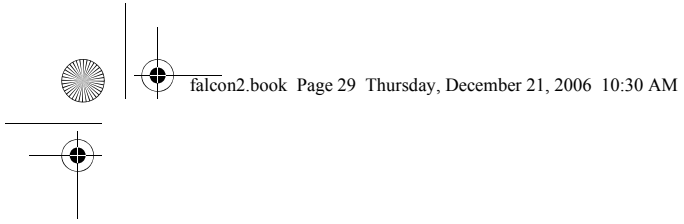

4

User-Installable Features

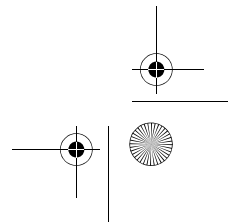
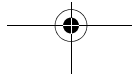
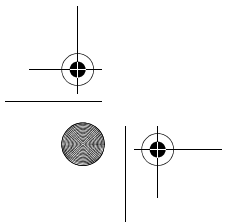
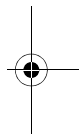
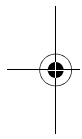

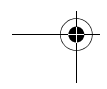
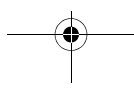
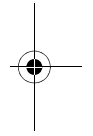
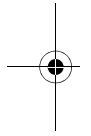
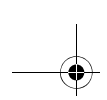

Lithium ion Battery

Your LifeBook notebook has a Lithium ion battery that provides power for operating your notebook when no external power source is available. The battery is durable and long lasting, but should not be exposed to extreme temperatures, high voltages, chemicals or other hazards.

The Lithium ion battery operating time may become shorter if it is used under the following conditions:

- When used at temperatures that exceeds a low of 5°C or a high of 35°C. Extreme temperatures not only reduce charging efficiency, but can also cause battery deterioration. The Charging icon on the Status Indicator panel will flash when you try to charge a battery that is outside its operating temperature range. (See *Battery Charging Indicator on page 11 for more information*)
- When using a high current device such as a modem, Multi-Format DVD Writer, DVD-ROM drive, DVD/CD-RW combo drive, or the hard drive, using the AC adapter will conserve your battery life.



Do not leave a faulty battery in your LifeBook notebook. It may damage your AC adapter, optional Auto/Airline adapter, another battery or your notebook itself. It may also prevent operation of your notebook by draining all available current into the bad battery.



- Actual battery life will vary based on screen brightness, applications, features, power management settings, battery condition and other customer preferences. CD-ROM drive, Multi-Format DVD Writer, DVD/CD-RW drive combo, or hard drive usage may also have a significant impact on battery life. The battery charging capacity is reduced as the battery ages. If your battery is running low quickly, you should replace it with a new one.
- Under federal, state, or local law it may be illegal to dispose of batteries by putting them in the trash. Please take care of our environment and dispose of batteries properly. Check with your local government authority for details regarding recycling or disposing of old batteries. If you cannot find this information elsewhere, contact your support representative at 1-800-8FUJITSU (1-800-838-5487)

RECHARGING THE BATTERIES

If you want to know the condition of the primary Lithium ion battery, check the Battery Level indicator located on the Status Indicator panel. The indicator changes as the battery level changes.

The Lithium ion battery is recharged internally using the AC adapter or Auto/Airline adapter. To recharge the battery make sure the battery that needs to be charged is installed in your LifeBook notebook and connect the AC or Auto/Airline adapter.



Make sure that the Battery Charging indicator and the percentage charge is shown inside the Battery Level icon on the Status Indicator Panel.

There is no memory effect on the Lithium ion battery therefore you do not need to discharge the battery completely before recharging. The charge times will be significantly longer if your notebook is in use while the battery is charging. If you want to charge the battery more quickly, put your notebook into Standby mode, or turn it off while the adapter is charging the battery. (See *Power Management on page 27 for more information on Standby mode and shutdown procedure*)



Using heavy current devices such as Modem or frequent DVD/CD-RW/CD-ROM accesses may prevent charging completely.

Low Battery State

When the battery is running low, a low battery notification message will appear. If you do not respond to the low battery message, the batteries will continue to discharge until they are too low to operate. When this happens, your notebook will go into Standby mode. There is no guarantee that your data will be saved once the notebook reaches this point.



- Once the low battery notification message appears, you need to save all your active data and put your LifeBook notebook into Standby mode until you can provide a new power source. You should provide a charged battery, an AC power adapter, or Auto/Airline adapter as soon as possible.
- When you are in Standby mode there must always be at least one power source active. If you remove all power sources while your LifeBook notebook is in Standby mode, any data that has not been saved to the hard drive will be lost.

Dead Battery Suspend mode shows on the Status indicator just like the normal Standby mode. Once your notebook goes into Dead Battery Suspend mode you will be unable to resume operation until you provide a source of power either from an adapter, or a charged battery. Once you have provided power, you will need to press the Power/Suspend/Resume button to resume operation.

In the Dead Battery Suspend mode, your data can be maintained for some time, but if a power source is not provided promptly, the Power indicator will stop flashing and go out, meaning that you have lost the data that was not stored. Once you provide power, you can continue to use your notebook while an adapter is charging the battery.

Shorted Batteries

The Status Indicator panel uses a Battery Level indicator to display the operating level available in that battery. (See figure 2-8 on page 11) If this display is red and blinking, it means the battery is damaged and must be replaced so it does not damage other parts of your LifeBook notebook.

REPLACING THE BATTERY

With the purchase of an additional battery, you can have a fully charged spare to swap with one that is not charged. There are two ways to swap batteries, cold-swapping and hot-swapping:

Cold-swapping Batteries

To cold-swap batteries in your battery bay follow these easy steps: (Figure 4-1)

1. Have a charged battery ready to install.
2. Shut down your notebook and disconnect the AC adapter.
3. Unlock the battery by pushing the two release latches toward the battery pack (Figure 4-1).
4. While pressing the release latches, lift the battery out of the bay.
5. Insert a new battery into the bay, and press it down so that the latches click into place.
6. Plug in the AC adapter and turn the power on.

Hot-swapping Batteries

To hot-swap batteries in your battery bay follow these easy steps: (Figure 4-1)



Be sure to plug in an AC Adapter prior to removing the battery. There is no bridge battery present to support the system while the battery is being replaced. If you do not use an AC Adapter you will lose any unsaved files.

1. Plug an AC Adapter into the system and connect it to a power outlet.

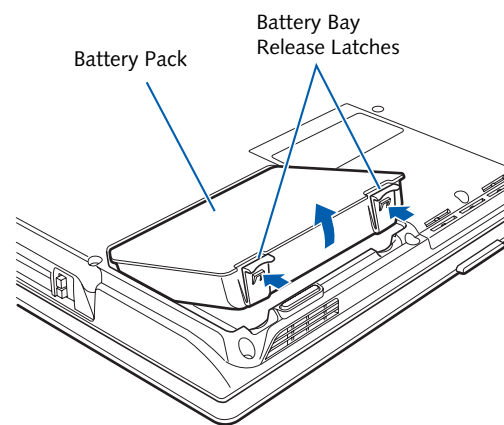

Figure 4-1. Removing a Battery

2. Follow steps 3 through 5 in "Cold Swapping Batteries".



If the Lithium ion battery connector is not fully seated, you may not be able to use your notebook or charge your battery.

User Installable Features

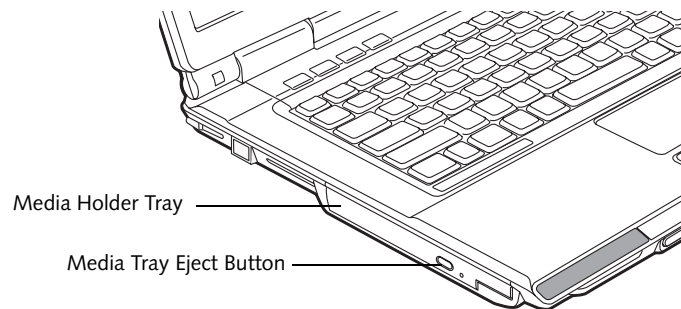

Figure 4-2. Optical Drive

Optical Disk Drive

A variety of media is available to use with your Dual-Layer Multi-Format DVD Writer, also known as an “optical disk drive”.

DVD-R and DVD-RW discs hold up to 4.7 GB of data (DVD-R discs used with the Dual-Layer Multi-Format DVD writer hold up to 8.5 GB of data.). A DVD-R disc can only be written to once; DVD-RW discs can be written to over and over. DVD-R and DVD-RW discs can be played on most standard DVD players. CD-R and CD-RW discs hold up to 640 MB of data. A CD-R disc can only be written to once; CD-RW discs can be written to over and over.

The Dual-Layer Multi-Format DVD Writer allows you to access movies, software, and audio DVD/CDs as well as to read and write to CD-R, CD-RW, DVD-R, DVD+R, DVD-RW, DVD+RW, and DVD RAM discs.



Install your media player software before first using the optical drive. Refer to the applicable readme file or tutorial associated with the software.

MEDIA PLAYER SOFTWARE

The optical disk drive and media player software let you play DVDs and CDs on your notebook. The media player includes controls which allow you to take full advantage of the DVD movie features, as well as standard features like fast forward, fast reverse, pause, etc. With this drive you can also burn onto recordable discs.



- Do not operate your optical drive unless your LifeBook notebook is sitting on a flat surface. Using a drive when the system is not level may damage the drive or prevent proper operation.
- Prolonged use of the optical drive, such as watching a DVD movie, will substantially reduce your battery life if no other power source is attached.

LOADING MEDIA ON YOUR DRIVE

To load a disc into your optical drive:

1. Push and release the eject button on the front of the optical drive to open the holder tray. The tray will come out of the LifeBook notebook a short distance.
2. Gently pull the tray out until a media disc can easily be placed in the tray.

- There may be a protective sheet in the tray from when it was shipped; please make sure it is removed before operating the drive.
- You should periodically check the Fujitsu website at <http://www.us.fujitsu.com/computers> for current updated drivers.
- All LifeBook DVD players are set to play DVD titles with region code number 1 which is specified for the North American market. The region number is a regional restriction code defined by the DVD Forum acting on Hollywood requirements. Different region codes are recorded on video DVD titles for publication in different areas of the world. If the regional code of the DVD player does not match the regional codes on the titles, then playback is impossible.
- You can change the region code on the DVD player using the Properties menu of the DVD software. Note, however, that **you can only change the region code up to four times**. After the fourth change, the last region code entered becomes permanent, and cannot be changed.



3. Place the media into the tray, label side up, with the hole in the center of the disc. Snap the disc onto the raised circle in the center of the tray.
4. Gently push the holder tray back in until you hear a click. (Figure 4-3)



If you have disabled the Auto Insert Notification Function, you will have to start the drive from your desktop, since your LifeBook notebook will not automatically recognize that media has been loaded.

USING THE MEDIA PLAYER SOFTWARE



Depending upon its configuration, your system may not have the media player software pre-installed. If it is not installed, reference the documentation that accompanies the media application.

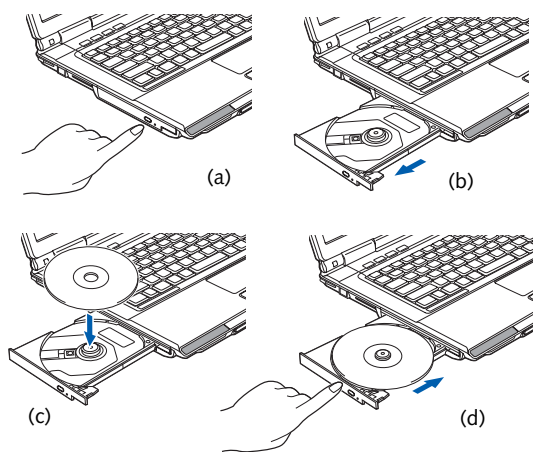

Figure 4-3. Loading/Ejecting Media

REMOVING MEDIA

1. Push and release the eject button on the front of the optical drive. This will stop the drive and the holder tray will come out of the LifeBook notebook a short distance.
2. Gently pull the tray out until the disc can easily be removed from the tray.
3. Carefully remove the media disc from the holder tray.
4. Gently push the holder tray back in until you hear a click.

EMERGENCY MEDIA TRAY RELEASE

If for some reason the eject button fails, you can open the media tray with a paper clip inserted into the eject hole in the far right side of the front of the tray. Straighten one side of a paper clip and push it gently into the hole. The tray will pop out a short distance. (Figure 4-4)

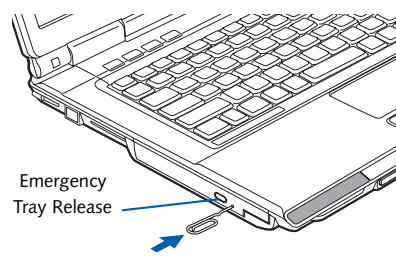

Figure 4-4. Emergency Removal of a CD/DVD

Starting a DVD Movie

1. Insert the DVD movie into the optical drive of your notebook. If the CD AutoRun feature activates, skip Step 2.
2. The first time you insert a movie into the DVD/CD-RW tray, you will be prompted to select what you want the system to do when discs are inserted (e.g., start automatically or wait for a prompt). Until you make a selection, you will receive the same prompt whenever you insert a disc.

Opening the Media Player Control Panel

With most DVD-ROMs, you have the option of altering how the movie should play and what you wish to view. You can do this by using the media player control panel and the mouse.

1. Click on the [Now Playing] button to open a drop-down menu for options.
2. Make the desired selections from the wide variety of options available.

Using the Media Player Control Panel

The media player software allows you to watch the movie much like a VCR player. You can pause, rewind, fast-forward and stop the movie at any point.

1. To Pause the movie, click the on-screen **||** button.
2. To Rewind the movie, click the **◀** button to rewind to a specific portion of the movie, or the **◀◀** button to return to the opening screen.
3. To Fast-forward the movie, click the **▶▶** button to forward to a specific portion of the movie, or the **▶** button to jump to the ending credits.
4. To Stop the movie, click the **■** button.

Exiting the Media Player

1. Click the **X** located in the upper right corner of the title bar. This will open a media player dialog box.
2. Click Yes to stop and exit the movie, or No to close the media player dialog box and return to the movie.

USING MEDIA PLAYER ON BATTERY POWER

Since optical drives consume a lot of power, your overall battery life will be significantly shorter when operating the optical drive continuously (such as watching a DVD movie) than during standard operation. Many movies run-times are longer than your LifeBook notebook can support on a single charged battery. If you are watching a

User Installable Features

DVD movie on battery power you may need to swap in an additional, charged battery or attach AC power during the movie to view it in its entirety.



- Prolonged use of the optical drive, such as watching a DVD movie, will greatly reduce your notebook's battery life.
- Many movie run-times are longer than your system can support on a single battery. If you are watching a DVD movie on battery power you may need to swap in an additional charged battery or attach AC power during the movie to view it in its entirety.
- An additional fully-charged battery is highly recommended if you will be watching DVD movies on battery power. If you do not have an additional battery, you may purchase one either online at: www.shopfujitsu.com or by calling 1-800-FUJITSU (1-800-385-4878).

To Watch a Movie on Battery Power:

1. Have an additional full-charged battery or your AC adapter ready for use.
2. Start watching your DVD movie.
3. When the low battery warning occurs, immediately stop the movie and exit the media player.



If you do not stop the media player quickly and the LifeBook notebook attempts to auto-suspend (critical battery low state) the LifeBook notebook will shut down improperly. If this occurs, you will need to perform a hard reset and follow the instruction, if any, presented to you before the system will reboot.

4. Power down your LifeBook notebook and replace the discharged battery with an additional fully-charged battery. If you do not have an additional battery, you may attach AC power as soon as you see the low battery warning.
5. Resume your LifeBook notebook by pressing the Suspend button again. This is not required if you attached AC power without entering standby mode.
6. Restart your media player, locate and skip to the chapter of the movie you were last watching.
7. Continue watching your DVD movie.



Some shorter DVD movies may not require you to swap batteries or attach AC power to complete them. However, it is best to be prepared since actual battery life while operating the optical drive cannot be guaranteed.

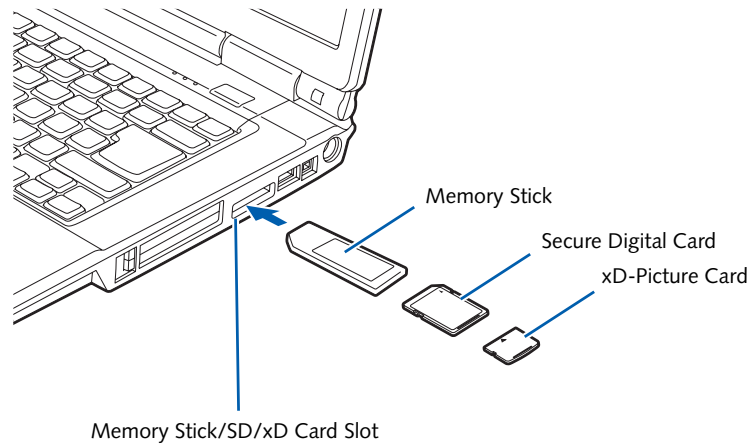

Figure 4-5. inserting an SD Card

Memory Stick/Secure Digital/xD Card Slot

Your LifeBook notebook supports the following memory cards, on which you can store and transfer data to and from a variety of digital devices. These cards use flash memory architecture, which means they don't need a power source to retain data.

- SD Memory Card
- Mini SD Card
- Memory Stick Media
- Memory Stick Select Media
- Memory Stick Duo Media
- Memory Stick PRO Media
- xD-Picture Cards™



- Some of the media in the above list may have more features than others.
- An adapter is required for Memory Stick Duo and Mini SD Cards.
- Copyright Protection Technology cannot be used.
- MultiMedia Cards (MMC), Secure MMC, and SD High Capacity (SDHC) Cards are not supported.

Memory Stick is a flash memory technology developed by Sony Electronics. Memory Stick allows you to record, transfer and share digital content, such as digital pictures, movies, music, voice, and computer data and applications.

Secure Digital (SD) Cards are very similar to Memory Sticks, but they are shorter. Like the Memory Stick, SD Cards allow portable storage among a variety of devices,

such as cell phones, GPS systems, digital cameras, and PDAs. SD Cards transfer data quickly, with low battery consumption. Like the memory stick, it uses flash memory architecture.

xD-Picture Cards work the same as Memory Sticks and SD Cards, but they are much smaller than either one. xD-Picture Cards are primarily used to store and transfer images with devices such as cell phones.

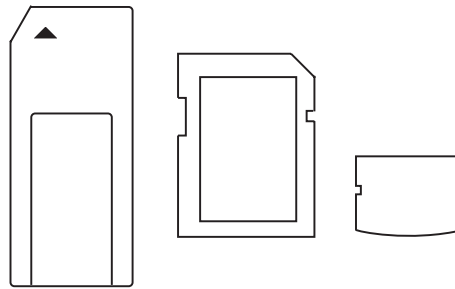

Figure 4-6. Memory Stick, Secure Digital, and xD-Picture Cards

INSERTING MEMORY STICK/SD/XD CARDS

Memory Sticks, SD Cards, and xD-Picture Cards are inserted in the Memory Stick/SD/xD-Picture Card slot (Figure 4-5). To insert a Memory Stick, SD Card or xD-Picture Card, follow these steps:



- Inserting or removing a Memory Stick, SD Card, or xD-Picture Card during your notebook's shutdown or bootup process may damage the card and/or your notebook.
- Do not insert a card into a slot if there is water or any other substance on the card as you may permanently damage the card, your LifeBook notebook, or both.

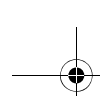

Secure Digital Card

1. See your Memory Stick, SD Card, or xD-Picture Card manual for instructions on the insertion of your card. Some cards may require that your notebook is off while inserting them.
2. Make sure there is no card currently in the slot. If there is, see Removing a Memory Stick/SD/xD-Picture Card.
3. Insert your card into the slot with the product label facing up.
4. Push the card firmly into the slot until it is seated in the connector.

REMOVING A MEMORY STICK/SD/XD CARD

To remove a Memory Stick, SD Card, or xD-Picture Card, follow these easy steps:



- See your card manual for specific instructions on the removal of your card. Some cards may require your LifeBook notebook to be in Standby Mode or Off while removing them.
- It is good practice to remove devices using the Unplug or Eject Hardware icon in the Notification Area at the bottom right of the display.

Push the Memory Stick, SD Card, or xD-Picture Card in until it unlatches. It will then eject from the slot for removal.

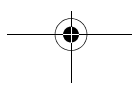
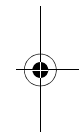
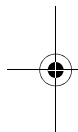

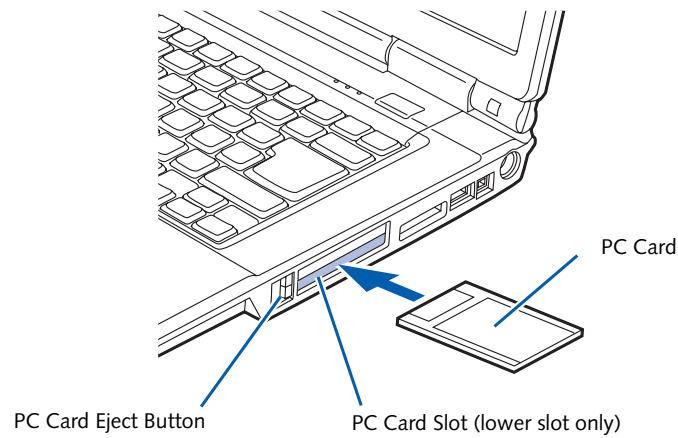

Figure 4-7. inserting/Removing PC Card

PC Cards/ExpressCards™

Your LifeBook notebook supports Type I and Type II PC Cards and ExpressCards™, which can perform a variety of functions depending on which type of card you insert. You can insert one or two cards at a time, depending on its type. PC Cards should be inserted in the bottom slot, and ExpressCards in the top slot.

Some available PC/ExpressCards:

- Local area network (LAN) cards (Type II)
- IDE solid-state disk cards (Type II)
- SCSI cards (Type II)

For further information, refer to the instructions supplied with your card(s).

INSERTING PC CARDS

PC Cards are inserted in the PC Card slot (the lower of the two slots). To insert a PC Card, follow these steps:



- Inserting or removing a PC Card during your LifeBook notebook's shutdown or bootup process may damage the card and/or your LifeBook notebook.
- Do not insert a PC Card into a slot if there is water or any substance on the card as you may permanently damage the card, your notebook, or both.



You may be required to log on as an Administrator or member of the Administrator's Group to complete this procedure. If the computer is connected to a network, network policy settings may also prevent you from completing this procedure.

1. See your PC Card manual for instructions on the insertion of your card. Some cards may require that your notebook is off while inserting them.
2. Make sure there is no PC Card currently in the slot. If there is, see Removing PC Cards.
3. If the eject button is extended, press it until it clicks.
4. Insert the card into the slot with the label facing up.
5. Push the card firmly into the slot until it is seated in the connector.

REMOVING PC CARDS

See your PC Card manual for specific instructions on removing your card. Some cards may require your notebook to be in Standby Mode or Off during removal.



- Windows has a shutdown procedure for PC Cards that must be followed before removing a card. (Review your operating system manual for the correct procedure.) It is good practice to remove devices using the Unplug or Eject Hardware icon in the Notification Area at the bottom right of the display.
- If the dialog box states that the device cannot be removed, you must save all of your open files, close any open applications and shut down your notebook.

1. Unlock the card from the slot by pressing the eject button associated with the slot in which the card is located. When pressed, the button will pop out.
2. Firmly press the button again until it is flush with the notebook. This will eject the card slightly out of the slot allowing you to remove the card.



If the PC Card has an external connector and cable, do not pull the cable when removing the card.

INSERTING EXPRESSCARDS

There are two different width ExpressCards: 34 mm and 54 mm. The connector inside the slot is located on the left-hand side of the slot. If you insert a 34 mm card, align it with the left side of the slot when inserting it.

ExpressCards are inserted in the ExpressCard slot (the top slot). (Figure 4-8).

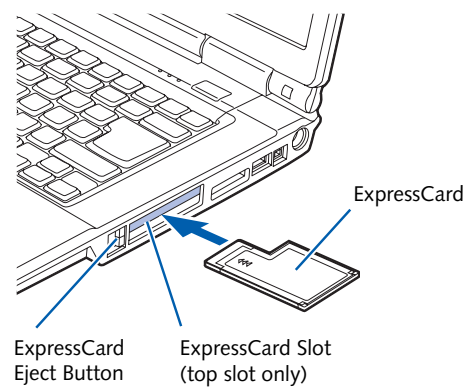

Figure 4-8. inserting/Removing ExpressCards



- Inserting or removing an ExpressCard during your notebook's shutdown or bootup process may damage the card and/or your notebook.
- Do not insert an ExpressCard into a slot if there is water or any other substance on the card as you may permanently damage the card, your notebook, or both.



You may be required to log on as Administrator or a member of the Administrator's Group to complete this procedure. If your computer is connected to a network, network policy settings may also prevent you from completing this procedure.

See your ExpressCard manual for instructions on the insertion of your card. Some cards may require that your notebook is off while inserting them.

To insert an ExpressCard, follow these steps:

1. Make sure there is no ExpressCard currently in the slot. If there is, see Removing ExpressCards.
2. If the eject button is extended, press it in until it clicks.
3. Insert your ExpressCard into the slot with the product label facing up. If you are inserting a 34 mm card, be sure to align it with the left side of the slot when inserting it.
4. Push the card firmly into the slot until it is seated in the connector.

REMOVING EXPRESSCARDS

See your ExpressCard manual for specific instructions on removing your card. Some cards may require your notebook to be in Standby Mode or Off during removal.



- Windows has a shutdown procedure for ExpressCards that must be followed before removing a card. (Review your operating system manual for the correct procedure.) It is good practice to remove devices using the Unplug or Eject Hardware icon in the Notification Area at the bottom right of the display.
- If the dialog box states that the device cannot be removed, you must save all of your open files, close any open applications and shut down your notebook.

To remove an ExpressCard, follow these steps:

1. Unlock the card from the slot by pressing the eject button associated with the slot in which the card is located. When pressed, the button will pop out.
2. Firmly press the button again until it is flush with the notebook. This will eject the card slightly out of the slot allowing you to remove the card.

Memory Upgrade Module

Your Fujitsu LifeBook notebook comes with high speed Double Data Rate Synchronous Dynamic RAM (DDR2-667 SDRAM) factory installed. The maximum memory capacity is 4 GB (2 GB x 2), but 3.25 GB is the maximum amount that is usable by the operating system. To increase your notebook's memory capacity, you may install an additional memory upgrade module. The memory upgrade must be a dual-in-line (DIMM) SDRAM module. To ensure 100% compatibility, purchase the SDRAM module only from the Fujitsu web store at www.shopfujitsu.com.

- Do not remove any screws from the memory upgrade module compartment except the ones specifically shown in the directions for installing and removing the memory upgrade module.
- The memory upgrade module can be severely damaged by electrostatic discharge (ESD). To minimize the risk, observe the following precautions:
 - Before handling a memory module, touch a grounded metal object to discharge static electricity built up in your body.
 - When installing or removing a memory module, hold it by the edge so as not to touch any contacts or chips. Be careful not to touch any internal computer terminals or components; the oil from your fingers could cause a short to the components.
 - Be sure to power down your system before adding or removing memory modules. Even if the system is in hibernate or standby states, data could be lost or the memory could be damaged if power is still available to the system.



INSTALLING MEMORY UPGRADE MODULES

1. Turn off power to your notebook, remove any power adapter (AC or auto/airline). Remove the battery.
2. Turn the notebook bottom side up, and remove the screw from the memory upgrade module compartment. (Figure 4-9)
3. Remove the cover.
4. Remove the memory upgrade module from the static guarded sleeve.
5. Align the memory upgrade module with the part side up. Align the connector edge of the memory upgrade module with the connector slot in the compartment.

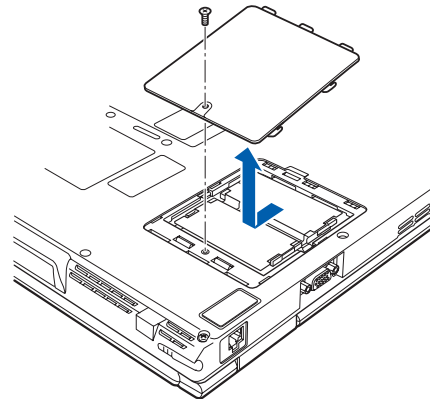

Figure 4-9. Opening the Memory Upgrade Compartment

6. Insert the memory upgrade module at a 45° angle. Press the connector edge of the module firmly down and into the connector until it lodges under the retaining clip. You will hear a click when it is properly in place. (Figure 4-10)

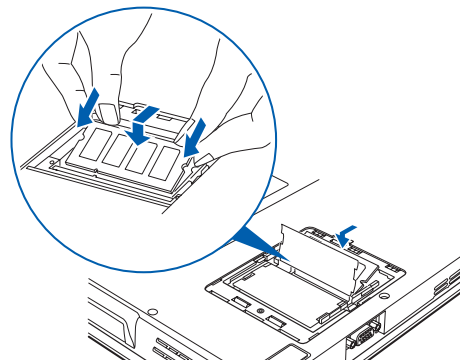

Figure 4-10. Installing a Second Memory Module

7. Replace the cover and reinstall the screw.



The memory upgrade module is not something you routinely remove from your notebook. Once it is installed, you can leave it in place unless you want to change system memory capacity.

REMOVING A MEMORY UPGRADE MODULE

1. Perform steps 1 through 4 of Installing a Memory Upgrade Module.
2. Pull the clips sideways away from each side of the memory upgrade module at the same time.
3. While holding the clips out, remove the module from the slot by lifting it up and pulling towards the side of your notebook. (Figure 4-11)

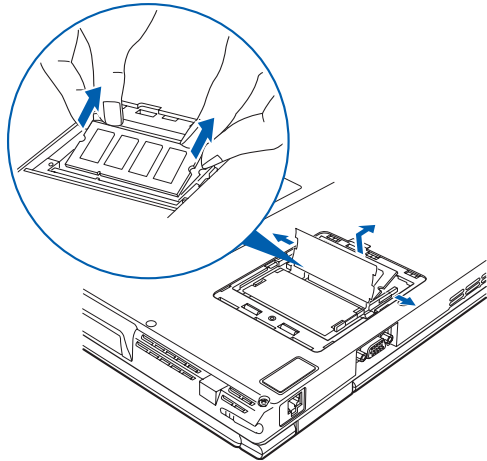

Figure 4-11. Removing a Memory Upgrade Module

4. Store the memory upgrade module in a static guarded sleeve.
5. Replace the cover and reinstall the screw.

CHECKING THE MEMORY CAPACITY

Once you have changed the system memory capacity by replacing the installed module with a larger one, be sure to check that your notebook has recognized the change.

Check the memory capacity by clicking [Start] -> Control Panel, then double-clicking the System icon. The amount of memory is displayed on the main System window.

There may be a variation between the actual memory size and what is displayed. This is due to the fact that your system uses a video graphics chip which dynamically allocates system memory to accelerate graphics performance. Up to 224 MB of memory is dynamically shared on an as-needed basis using Dynamic Video Memory Technology (DVMT).



If the total memory displayed is incorrect, check that your memory upgrade module is properly installed. (If the module is properly installed and the capacity is still not correctly recognized, see Troubleshooting on page 47.)

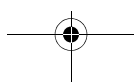
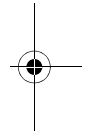
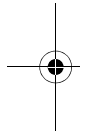

Device Ports

Your Fujitsu LifeBook notebook comes equipped with multiple ports to which you can connect external devices including: disk drives, keyboards, modems, printers, etc.

MODEM (RJ-11) TELEPHONE JACK

The modem (RJ-11) telephone jack is used for an internal modem. To connect the telephone cable follow these easy steps:

1. Align the connector with the port opening.
2. Push the connector into the port until it is seated.
3. Plug the other end of the telephone cable into a telephone outlet. (Figure 4-12)

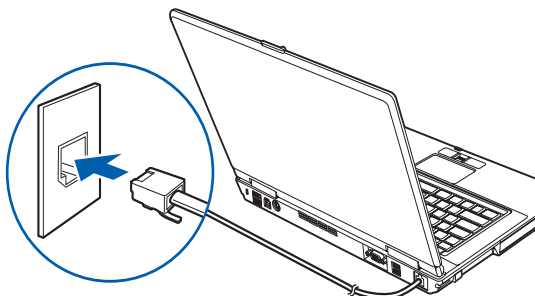

Figure 4-12. Connecting a Modem

The modem sound is deactivated by default, to activate modem sound follow these easy steps:

1. Right click on the Speaker icon in your system tray.
2. Select **Open Volume**.
3. Select **Option/Properties**.
4. Under "Show the following volume controls", click on **Phone** and click **OK**.
5. Uncheck the Mute box under Phone Balance.



The internal modem is not intended for use with Digital PBX systems. Do not connect the internal modem to a Digital PBX as it may cause serious damage to the internal modem or your entire LifeBook notebook. Consult your PBX manufacturer's documentation for details. Some hotels have Digital PBX systems. Be sure to find out **BEFORE** you connect your modem.



- The internal modem is designed to the ITU-T V.90 standard. Its maximum speed of 53000bps is the highest allowed by FCC, and its actual connection rate depends on the line conditions. The maximum speed is 33600bps at upload.
- The internal modem on all Fujitsu LifeBook notebooks from Fujitsu are certified for use in the United States and Canada. The modem may be certified in other countries.

INTERNAL LAN (RJ-45) JACK

The internal LAN (RJ-45) jack is used for a Gigabit (10Base-T/100Base-Tx/1000Base-T) Ethernet LAN connection. You may need to configure your notebook to work with your particular network. (Please refer to your network administrator for information on your network configuration.) To connect the LAN cable follow these easy steps:

1. Align the connector with the port opening.
2. Push the connector into the port until it is seated. (Figure 4-13)
3. Plug the other end of the cable into a LAN outlet.

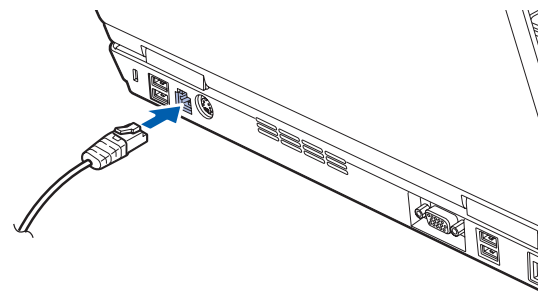

Figure 4-13. Connecting the LAN

UNIVERSAL SERIAL BUS PORTS

There are five USB 2.0 ports on this system (four on the back and one on the side). The Universal Serial Bus 2.0 ports (USB) allow you to connect USB devices such as external game pads, pointing devices, keyboards and/or speakers.

In order to connect a USB device follow these steps:

1. Align the connector with the port opening. (Figure 4-14)
2. Push the connector into the port until it is seated.



Due to the ongoing changes in USB technology and standards, not all USB devices and/or drivers are guaranteed to work.

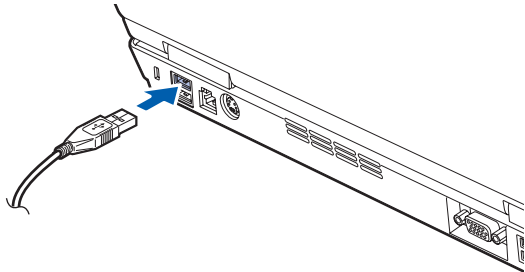

Figure 4-14. Connecting a USB Device

IEEE 1394 PORT

The 4-pin 1394 port allows you to connect digital devices that are compliant with IEEE 1394 standard. The IEEE 1394 standard is easy to use, connect, and disconnect. This port can allow up to 400 Mbps transfer rate. A third-party application may be required to operate your digital device with the 1394 port.



The 1394 port used in this system uses a four-pin configuration. If you intend to interface with devices which use a six-pin configuration, you will need to purchase an adapter.

In order to connect a 1394 device, follow these steps:

1. Align the connector with the port opening.
2. Push the connector into the port until it is seated. (Figure 4-15)

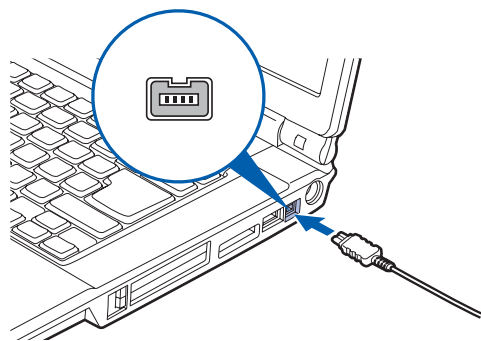

Figure 4-15. Connecting an IEEE 1394 Device

HEADPHONE/LINE-OUT JACK

The headphone/line-out jack allows you to connect headphones or powered external speakers to your notebook. Your headphones or speakers must be equipped with a 1/8" (3.5 mm) stereo mini-plug. In order to connect headphones or speakers follow these easy steps: (See figure 2-5 on page 8 for location)

1. Align the connector with the port opening.
2. Push the connector into the port until it is seated.

User Installable Features



If you plug headphones into the headphone jack, the built-in stereo speakers will be disabled.

MICROPHONE/LINE-IN JACK

The microphone/line-in jack allows you to connect an external mono microphone. Your microphone must be equipped with a 1/8" (3.5 mm) mono mini-plug in order to fit into the microphone jack of your notebook. In order to connect a microphone follow these easy steps: (See figure 2-4 on page 7 for location)

1. Align the connector with the port opening.
2. Push the connector into the port until it is seated.

S-VIDEO OUT PORT

The S-Video port allows you to connect and use directly any S-Video device, such as a VCR or television. The S-Video standard provides for a higher quality picture than NTSC or PAL. To connect an S-Video device, follow these steps: (Figure 4-16)

1. Align the connector with the port opening.
2. Push the connector into the port until it is seated.

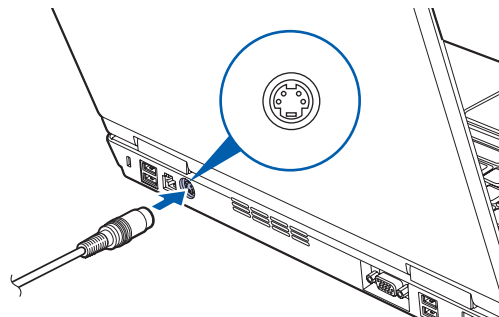

Figure 4-16 Connecting an S-Video device

EXTERNAL VIDEO PORT

The external video port allows you to connect an external monitor or LCD projector. In order to connect an external device follow these easy steps: (See figure 2-6 on page 9 for location)

1. Align the connector with the port opening.
2. Push the connector into the port until it is seated.
3. Tighten the two hold-down screws, located on each end of the connector.



Pressing the [Fn] + [F10] keys allows you to change your selection of where to send your display video. Each time you press the key combination, you will step to the next choice. The choices, in order, are: built-in display panel only, both built-in display panel and external monitor or external monitor only.

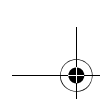

LifeBook A3000 Series Notebook - Section Four

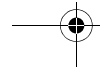
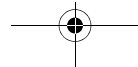
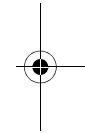
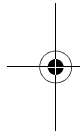

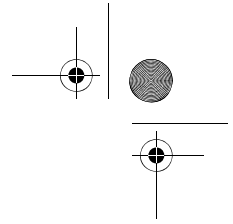
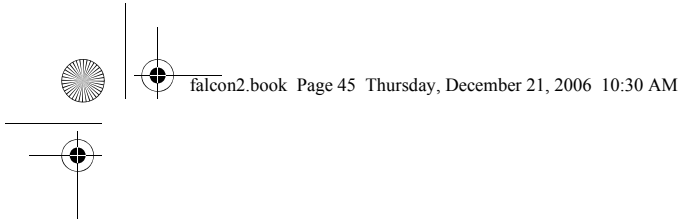

5

Troubleshooting

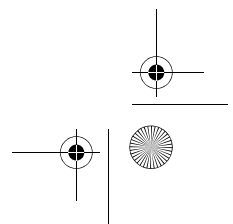
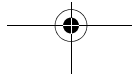
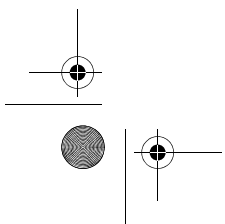
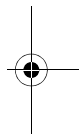
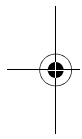

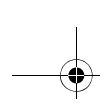

LifeBook A3000 Series Notebook - Section Five

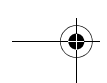
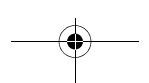
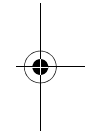
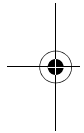

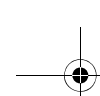

Troubleshooting

There may be occasions when you encounter simple setup or operating problems that you can solve on the spot, or problems with peripheral devices that can be solved by replacing the device. The information in this section helps you isolate and resolve some of these straightforward issues and identify failures that require service.

IDENTIFYING THE PROBLEM

If you encounter a problem, go through the following procedure before pursuing complex troubleshooting:

1. Turn off your LifeBook notebook.
2. Make sure the AC adapter is plugged into your notebook and to an active AC power source.
3. Make sure that any card inserted in the PC Card slot is seated properly. You can also remove the card from the slot, thus eliminating it as a possible cause of failure.
4. Make sure that any devices connected to the external connectors are plugged in properly. You can also disconnect such devices, thus eliminating them as possible causes of failure.
5. Turn on your notebook. Make sure it has been off at least 10 seconds before you turn it back on.
6. Go through the boot sequence.
7. If the problem has not been resolved, refer to the Troubleshooting Table, that follows, for more detailed troubleshooting information.



If you keep notes about what you have tried, your support representative may be able to help you more quickly by giving additional suggestions over the phone.

8. If you have tried the solutions suggested in the Troubleshooting Table without success, contact your support representative:

Toll free: 1-800-8Fujitsu (1-800-838-5487)

E-mail: 8fujitsu@us.fujitsu.com

Website: <http://www.us.fujitsu.com/computers>.

Before you place the call, you should have the following information ready so that the customer support representative can provide you with the fastest possible solution:

- Product name
- Product configuration number
- Product serial number
- Purchase date
- Conditions under which the problem occurred
- Any error messages that have occurred
- Type of device connected, if any

See the Configuration Label on the bottom of your notebook for configuration and serial numbers. (See *figure 2-7 on page 10 for location*)

SPECIFIC PROBLEMS

Using the Troubleshooting Table

When you have problems with your LifeBook notebook, try to find the symptoms under the Problem column of the troubleshooting table for the feature giving you difficulty. You will find a description of common causes for that symptom under the column Possible Cause and what, if anything, you can do to correct the condition under Possible Solutions. All possible causes or solutions may not apply to your notebook.

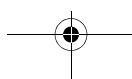
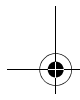
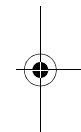
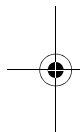

LifeBook A3000 Series Notebook - Section Five

TROUBLESHOOTING TABLE

Problem	Page	Problem	Page
Audio Problems	page 48	USB Device Problems	page 50
Optical Drive Problems	page 48	PC Card Problems	page 50
Floppy Disk Drive Problems	page 49	Power Failures	page 50
Hard Drive Problems	page 49	Shutdown and Startup Problems	page 52
Keyboard or Mouse Problems	page 49	Video Problems	page 53
Memory Problems	page 49	Miscellaneous Problems	page 54
Modem Problems	page 50		

Problem	Possible Cause	Possible Solutions
Audio Problems		
There is no sound coming from the built-in speakers.	The volume is turned too low.	Adjust the volume control on your notebook.
	The software volume control is set too low.	Adjust the sound volume control settings in your software, operating system and applications.
	Headphones are plugged into your notebook.	Plugging in headphones disables the built-in speakers, remove the headphones.
	BIOS audio settings are incorrect.	Set the BIOS setup utility to the default values within the Multimedia Device Configuration menu. (See <i>BIOS Setup Utility on page 25 for more information</i>)
	Software driver is not configured correctly.	Refer to your application and operating system documentation for help.
	The speakers have been muted using the Volume icon in the system tray.	Click on the Volume icon in the tool tray on the bottom right of the screen. (It looks like a speaker). If the Mute box is checked, click on it to uncheck it.
Optical Drive Problems		
LifeBook notebook fails to recognize optical discs.	Protective sheet is still in the optical drive tray.	Remove the protective sheet then replace the disc in the tray.
	The disc is not pushed down onto center circle of the drive.	Open optical drive tray and reinstall the disc properly.
	Optical drive tray is not latched shut.	Push on the front of the optical drive tray until it latches.
	Incorrect DVD Player or no DVD Player software is installed.	Install DVD Player software. (See <i>"Media Player Software" on page 33 for more information.</i>)
	Wrong drive designator was used for the disc in the application.	Verify the drive designator used by the application is the same as the one used by the operating system. When the operating system is booted from a DVD/CD, drive designations are automatically adjusted. Note that the drive designation can be changed with the Disk Management tool located at Administrative Tools -> Computer Management.
	Windows Auto Insert function is disabled.	Start the optical drive from the desktop or application software or re-enable the Windows Auto Insert function.
LifeBook notebook fails to recognize a disc.	The disc is dirty or defective.	Wipe the disc. If it still will not work try another disc in the drive.

**Troubleshooting**

Problem	Possible Cause	Possible Solutions
The Optical Drive Access indicator on the Status Indicator Panel blinks at regular intervals when no disc is in the tray or the optical drive is not installed.	The auto insertion function is active and is checking to see if a disc is ready to run.	This is normal. However, you may disable this feature.
Floppy Disk Drive Problems		
You cannot access the optional external floppy disk drive.	You tried to write to a write protected floppy disk.	Eject the floppy disk and set it to write enable.
	Floppy disk is not loaded correctly.	Eject floppy disk, check orientation and re-insert.
	The floppy disk drive may not be properly installed.	Remove and reinstall your floppy disk drive.
	Security is set to protect access to floppy disk data.	Verify your password and security settings.
Hard Drive Problems		
You cannot access your hard drive.	The wrong drive designator was used by an application when a bootable disc was used to start the notebook.	Verify drive designator used by application is in use by the operating system. When the operating system is booted from a disc, drive designations are automatically adjusted.
	Security is set in the BIOS so your operating system cannot be started without a password.	Verify your password and security settings.
Keyboard or Mouse Problems		
The built-in keyboard does not seem to work.	The notebook has gone into Standby mode.	Push the Power/Suspend/Resume button.
	Your application has locked out your keyboard.	Try to use your integrated pointing device to restart your system.
You have installed an external keyboard or mouse, and it does not seem to work.	Your external device is not properly installed.	Reinstall your device. (See <i>Device Ports on page 42 for more information</i>)
	Your operating system software is not set up with correct software driver for that device.	Check your device and operating system documentation and activate the proper driver.
You have connected an external keyboard or mouse and it seems to be locking up the system.	Your operating system software is not setup with correct software driver for that device.	Check your device and operating system documentation and activate the proper driver.
	Your system has crashed.	Try to restart your notebook.
Memory Problems		
Your Power On screen, or Main menu of the BIOS setup utility information, does not show the correct amount of installed memory.	Your memory upgrade module is not properly installed.	Remove and reinstall your memory upgrade module. (See <i>Memory Upgrade Module on page 40 for more information</i>)
	You have a memory failure.	Check for Power On Self Test (POST) messages. (See <i>Power On Self Test Messages on page 55 for more information</i>)

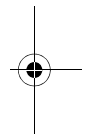
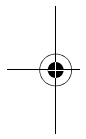

LifeBook A3000 Series Notebook - Section Five

Problem	Possible Cause	Possible Solutions
Modem Problems		
Messages about modem operation.	Modem operation messages are generated by whichever modem application is in use.	See your application software documentation for additional information.
USB Device Problems		
You have installed a USB device that your LifeBook notebook does not recognize, or the device does not seem to work properly.	The device is not properly installed.	Remove and reinstall the device. <i>(See Device Ports on page 42 for more information)</i>
	The device may have been installed while an application was running, so your notebook is not aware of its installation.	Close the application and restart your notebook.
	Your device may not have the correct software driver active.	See your software documentation and activate the correct driver.
	You may have the wrong I/O address selected for the device.	See your device documentation and software documentation to determine the required I/O address. Change the settings in the BIOS setup utility. <i>(See BIOS Setup Utility on page 25 for more information)</i>
	Your device and another device are assigned the same I/O address.	Check all I/O addresses located within the BIOS setup utility and any other installed hardware or software to make sure there are no duplications.
PC Card/ExpressCard Problems		
A card inserted in the card slot does not work or is locking up the system.	The card is not properly inserted.	Remove and re-insert the card. <i>(See PC Cards/ExpressCards™ on page 38 for more information)</i>
	The card may have been inserted while an application was running, so your notebook is not aware of its insertion.	Close the application and restart your notebook.
	Your software may not have the correct software driver active.	See your software documentation and activate the correct driver.
	You may have the wrong I/O address selected for your card device.	See your card documentation to determine the required I/O address. Change the settings in the BIOS. <i>(See BIOS Setup Utility on page 25 for more information)</i>
	Your card device and another device are assigned the same I/O address.	Check all I/O addresses located within the BIOS setup utility and any other installed hardware or software to make sure there are no duplications.
Power Failures		
You turn on your LifeBook notebook and nothing seems to happen.	The installed primary battery is completely discharged, there is no modular bay battery installed or there is no Power adapter (AC or Auto/Airline) installed.	Check the Status Indicator Panel to determine the presence and condition of the batteries. <i>(See Status Indicator Panel on page 11 for more information)</i> Install a charged battery or a Power adapter.

**Troubleshooting**

Problem	Possible Cause	Possible Solutions
You turn on your LifeBook notebook and nothing seems to happen. (continued)	The primary battery is installed but is faulty.	Use the Status Indicator panel to verify the presence and condition of the batteries. (See <i>Status Indicator Panel on page 11 for more information</i>) If a battery is indicating a short, remove that battery and operate from another power source or replace that battery.
	The battery or batteries are low.	Check the Status Indicator Panel to determine the presence and condition of the batteries. (See <i>Status Indicator Panel on page 11 for more information</i>) Use a power adapter to operate until a battery is charged or install a charged battery.
	The power adapter (AC or auto/airline) is not plugged in properly.	Verify that your adapter is connected correctly. (See <i>Power Sources on page 23 for more information</i>)
	The power adapter (AC or auto/airline) has no power from the AC outlet, airplane seat jack, or car cigarette lighter.	Move the AC cord to a different outlet, check for a line switch or tripped circuit breaker for the AC outlet. If you are using an auto/airline adapter in a car make sure the ignition switch is in the On or Accessories position.
	The power adapter (AC or auto/airline) is faulty.	Try a different power adapter or install a charged optional second battery.
Your LifeBook notebook turns off all by itself.	The power management parameters are set for auto timeouts which are too short for your operating needs.	Press any button on the keyboard, or move the mouse to restore operation. If that fails, push the Power/Suspend/Resume button. Check your power management settings, or close your applications and go to the Power Savings menu of the setup utility to adjust the timeout values to better suit your needs.
	You are operating on battery power only and have ignored a low battery alarm until the batteries are all at the dead battery state and your machine has gone into Dead Battery Suspend mode.	Install a power adapter and then push the Power/Suspend/Resume button. (See <i>Power Sources on page 23 for more information</i>)
	You have a battery failure.	Verify the condition of the batteries using the Status Indicator panel, and replace or remove any batteries that are shorted. (See <i>Status Indicator Panel on page 11 for more information</i>)
	Your power adapter has failed or lost its power source.	Make sure the adapter is plugged in and the outlet has power.
Your notebook will not work on battery alone.	The installed batteries are dead.	Replace the battery with a charged one or install a power adapter.
	No batteries are installed.	Install a charged battery.
	The batteries are improperly installed.	Verify that the batteries are properly connected by reinstalling them.
	Your installed batteries are faulty.	Verify the condition of the batteries using the Status Indicator panel and replace or remove any batteries that are shorted. (See <i>Status Indicator Panel on page 11 for more information</i>)

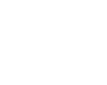
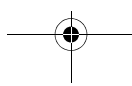
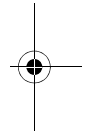
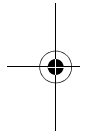

LifeBook A3000 Series Notebook - Section Five

Problem	Possible Cause	Possible Solutions
The batteries seem to discharge too quickly.	You are running an application that uses a lot of power due to frequent hard drive access or DVD/CD-ROM access, use of a modem or LAN PC card.	Use both the primary battery and an optional second battery and/or use a power adapter for this application when at all possible.
	The power savings features may be disabled.	Check the power management and/or setup utility settings in the Power Savings menu and adjust according to your operating needs.
	The brightness is turned all the way up.	Turn down the brightness adjustment. The higher the brightness the more power your display uses.
	The batteries are very old.	Replace the batteries.
	The batteries have been exposed to high temperatures.	Replace the batteries.
	The batteries are too hot or too cold.	Restore the notebook to normal operating temperature. Charging icon on the Status Indicator panel will flash when battery is outside of operating range.
Shutdown and Startup Problems		
The Power/Suspend/Resume button does not work.	Power/Suspend/Resume button is disabled from the Power -> Advanced submenu of the setup utility.	Enable the button from the setup utility.
	You did not hold the button in long enough.	Hold the button longer. This may need to be a few seconds if your application is preventing the CPU from checking for button pushes.
	There may be a conflict with the application software.	Close all applications and try the button again.
The system powers up and displays power on information, but fails to load the operating system.	The boot sequence settings of the setup utility are not compatible with your configuration.	Set the operating source by pressing the [ESC] key while the Fujitsu logo is on screen or use the [F2] key and enter the setup utility and adjust the source settings from the Boot menu. <i>(See BIOS Setup Utility on page 25 for more information)</i>
	You have a secured system requiring a password to load your operating system.	Make sure you have the right password. Enter the setup utility and verify the Security settings and modify them as accordingly. <i>(See BIOS Setup Utility on page 25 for more information)</i>
	Internal hard drive was not detected.	Use the BIOS setup utility or Primary Master submenu, located within the Main menu, to try to auto detect the internal hard drive.
An error message is displayed on the screen during the notebook (boot) sequence.	Power On Self Test (POST) has detected a problem.	See the Power On Self Test (POST) messages to determine the meaning and severity of the problem. Not all messages are errors; some are simply status indicators. <i>(See Power On Self Test Messages on page 55 for more information)</i>
Your notebook appears to change setup parameters when you start it.	BIOS setup changes were not saved when you made them and exited the setup utility returning it to earlier settings.	Make sure you select Save Changes And Exit when exiting the BIOS setup utility.

**Troubleshooting**

Problem	Possible Cause	Possible Solutions
Your notebook appears to change setup parameters when you start it. (continued)	The BIOS CMOS hold-up battery has failed.	Contact your support representative for repairs. This is not a user serviceable part but has a normal life of 3 to 5 years.
Video Problems		
The built-in display is blank when you turn on your LifeBook notebook.	Something is pushing on the Closed Cover switch.	Clear the Closed Cover switch. (See figure 2-3 on page 6 for location)
	The notebook is set for an external monitor only.	Pressing [F10] while holding down the [Fn] key allows you to change your selection of where to send your display video. Each time you press the keys you will step to the next choice. The choices, in order, are: built-in display panel only, both built-in display panel and external monitor or external monitor only.
	The display angle and brightness settings are not adequate for your lighting conditions.	Move the display and the brightness control until you have adequate visibility.
	The power management timeouts may be set for very short intervals and you failed to notice the display come on and go off again.	Press any button the keyboard, or move the mouse to restore operation. If that fails, push the Power/Suspend/Resume button. (The display may be shut off by Standby mode, Auto Suspend or Video Timeout)
The notebook turned on with a series of beeps and your display is blank.	Power On Self Test (POST) has detected a failure that does not allow the display to operate.	Contact your support representative.
The display goes blank by itself after you have been using it.	The notebook has gone into Video timeout, Standby mode, or Hibernate mode because you have not used it for a period of time.	Press any button on the keyboard, or move the mouse to restore operation. If that fails, push the Power/Suspend/Resume button. Check your power management settings, or close your applications and go to the Power Savings menu of the setup utility to adjust the timeout values to better suit your operation needs. (See BIOS Setup Utility on page 25 for more information)
	The power management timeouts may be set for very short intervals and you failed to notice the display come on and go off again.	Press any button on the keyboard, or move the mouse to restore operation. If that fails, push the Power/Suspend/Resume button. (The display may be shut off by Standby Mode, Auto Suspend or Video Timeout)
The display does not close.	A foreign object, such as a paper clip, is stuck between the display and the keyboard.	Remove all foreign objects from the keyboard.
The display has bright or dark spots.	If the spots are very tiny and few in number, this is normal for a large LCD display.	This is normal; do nothing.
	If the spots are numerous or large enough to interfere with your operation needs.	Display is faulty; contact your support representative.

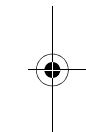
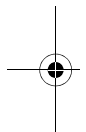

LifeBook A3000 Series Notebook - Section Five

Problem	Possible Cause	Possible Solutions
The application display uses only a portion of your screen and is surrounded by a dark frame.	You are running an application that does not support 1280 x 800 pixel resolution display and display compression is enabled.	Display compression gives a clearer but smaller display for applications that do not support 1280 x 800 pixel resolution. You can fill the screen but have less resolution by changing your display compression setting, (See the Video Features submenu, located within the Advanced menu of the BIOS. (See <i>BIOS Setup Utility on page 25 for more information</i>)
The Display is dark when on battery power.	The Power Management utility default is set on low brightness to conserve power.	Press [Fn] + [F7] to increase brightness or double-click on the battery gauge and adjust Power Control under battery settings.
You have connected an external monitor and it does not display any information.	Your BIOS setup is not set to enable your external monitor.	Toggle the video destination by pressing [Fn]+ [F10] together, or check your BIOS setup and enable your external monitor. (See the Video Features submenu, located within the Advanced Menu of the BIOS. (See <i>BIOS Setup Utility on page 25 for more information</i>)
	Your external monitor is not properly installed.	Reinstall your device. (See <i>External Video Port on page 43 for more information</i>)
	Your operating system software is not setup with the correct software driver for that device.	Check your device and operating system documentation and activate the proper driver.
You have connected an external monitor and it does not come on.	Your external monitor is not compatible with your LifeBook notebook.	See your monitor documentation and the External Monitor Support portions of the Specifications section. (See <i>Specifications on page 69 for more information</i>)
Miscellaneous Problems		
An error message is displayed on the screen during the operation of an application.	Application software often has its own set of error message displays.	See your application manual and help displays screens for more information. Not all messages are errors some may simply be status.

Troubleshooting

POWER ON SELF TEST MESSAGES

The following is an alphabetic list of error-and-status messages that Phoenix BIOS and/or your operating system can generate and an explanation of each message. Error messages are marked with an *. If an error message is displayed that is not in this list, write it down and check your operating system documentation both on screen and in the manual. If you can find no reference to the message and its meaning is not clear, contact your support representative for assistance.

nnnn Cache SRAM Passed

Where nnnn is the amount of system cache in kilobytes successfully tested by the Power On Self Test. (This can only appear if you have an SRAM PC Card installed.)

***Diskette drive A error or Diskette drive B error**

Drive A: or B: is present but fails the BIOS Power On Self Test diskette tests. Check to see that the drive is defined with the proper diskette type in the Setup Utility, (*See BIOS Setup Utility on page 25 for more information*) and that the diskette drive is installed correctly. If the disk drive is properly defined and installed, avoid using it and contact your support representative.

***Extended RAM Failed at offset: nnnn**

Extended memory not working or not configured properly. If you have an installed memory upgrade module, verify that the module is properly installed. If it is properly installed, you may want to check your Windows Setup to be sure it is not using unavailable memory until you can contact your support representative.

nnnn Extended RAM Passed

Where nnnn is the amount of memory in kilobytes successfully tested.

***Failing Bits: nnnn The hex number nnnn**

This is a map of the bits at the memory address (in System, Extended, or Shadow memory) which failed the memory test. Each 1 (one) in the map indicates a failed bit. This is a serious fault that may cause you to lose data if you continue. Contact your support representative.

***Fixed Disk x Failure or Fixed Disk Controller Failure (where x = 1-4)**

The fixed disk is not working or not configured properly. This may mean that the hard drive type identified in your setup utility does not agree with the type detected by the Power On Self Test. Run the setup utility to check for the hard drive type settings and correct them if necessary. If the settings are OK and the message appears when you restart the system, there may be a serious fault which might cause you to lose data if you continue. Contact your support representative.

***Incorrect Drive A type – run SETUP**

Type of floppy drive A: not correctly identified in Setup. This means that the floppy disk drive type identified in your setup utility does not agree with the type detected by the Power On Self Test. Run the setup utility to correct the inconsistency.

***Incorrect Drive B type – run SETUP**

Type of floppy drive B: not correctly identified in Setup. This means that the floppy disk drive type identified in your setup utility does not agree with the type detected by the Power On Self Test. Run the setup utility to correct the inconsistency.

***Invalid NVRAM media type**

Problem with NVRAM access. In the unlikely case that you see this message you may have some display problems. You can continue operating but should contact your support representative for more information.

***Keyboard controller error**

The keyboard controller test failed. You may have to replace your keyboard or keyboard controller but may be able to use an external keyboard until then. Contact your support representative.

***Keyboard error**

Keyboard not working. You may have to replace your keyboard or keyboard controller but may be able to use an external keyboard until then. Contact your support representative.

***Keyboard error nn**

BIOS discovered a stuck key and displays the scan code for the stuck key. You may have to replace your keyboard but may be able to use an external keyboard until then. Contact your support representative.

***Monitor type does not match CMOS – Run SETUP**

Monitor type not correctly identified in Setup. This error probably means your BIOS is corrupted, run the setup utility and set all settings to the default conditions. If you still get this error, contact your support representative.

***Operating system not found**

Operating system cannot be located on either drive A: or drive C: Enter the setup utility and see if both the fixed disk, and drive A: are properly identified and that the boot sequence is set correctly. Unless you have changed your installation greatly, the operating system should be on drive C:. If the setup utility is correctly set, your hard drive may be corrupted.

***Parity Check 1 nnnn**

Parity error found in the system bus. BIOS attempts to locate the address and display it on the screen. If it cannot locate the address, it displays ????. This is a potentially data destroying failure. Contact your support representative.

***Parity Check 2 nnnn**

Parity error found in the I/O bus. BIOS attempts to locate the address and display it on the screen. If it cannot locate the address, it displays ????. This is a potentially data-destroying failure. Contact your support representative.

***Press <F1> to resume, <F2> to SETUP**

Displayed after any recoverable error message. Press the [F1] key to continue the boot process or the [F2] key to enter Setup and change any settings.

***Previous boot incomplete – Default configuration used**

Previous Power On Self Test did not complete successfully. The Power On Self Test will load default values and offer to run Setup. If the previous failure was caused by incorrect values and they are not corrected, the next boot will likely fail also. If using the default settings does not allow you to complete a successful boot sequence, you should turn off the power and contact your support representative.

***Real time clock error**

Real-time clock fails BIOS test. May require board repair. Contact your support representative.

***Shadow RAM Failed at offset: nnnn**

Shadow RAM failed at offset nnnn of the 64k block at which the error was detected. You are risking data corruption if you continue. Contact your support representative.

nnnn Shadow RAM Passed

Where nnnn is the amount of shadow RAM in kilobytes successfully tested.

***System battery is dead – Replace and run SETUP**

The BIOS CMOS RAM memory hold up battery is dead. This is part of your BIOS and is a board mounted battery which requires a support representative to change. You can continue operating but you will have to use setup utility default values or reconfigure your setup utility every time you turn off your notebook. This battery has an expected life of 2 to 3 years.

System BIOS shadowed

System BIOS copied to shadow RAM.

***System CMOS checksum bad – run SETUP**

BIOS CMOS RAM has been corrupted or modified incorrectly, perhaps by an application program that changes data stored in BIOS memory. Run Setup and reconfigure the system.

***System RAM Failed at offset: nnnn**

System memory failed at offset nnnn of in the 64k block at which the error was detected. This means that there is a fault in your built-in memory. If you continue to operate, you risk corrupting your data. Contact your support representative for repairs.

nnnn System RAM Passed

Where nnnn is the amount of system memory in kilobytes successfully tested.

***System timer error**

The timer test failed. The main clock that operates the computer is faulty. Requires repair of system board. Contact your support representative for repairs.

UMB upper limit segment address: nnnn

Displays the address of the upper limit of Upper Memory Blocks, indicating released segments of the BIOS memory which may be reclaimed by a virtual memory manager.

Video BIOS shadowed

Video BIOS successfully copied to shadow RAM.

**EMERGENCY MEDIA PLAYER
DRIVE TRAY RELEASE**

If for some reason the eject button fails, you can open the DVD/CD-ROM tray with a paper clip or similar tool inserted into the eject hole in the far right side of the front of the tray. Straighten one side of a paper clip and push it gently into the hole. The tray will pop out a short distance.

MODEM RESULT CODES

The operating system and application software that is factory installed detects the modem characteristics and provides the necessary command strings to operate the modem. The internal modem operation is controlled by generic AT commands from the operating system and application software. The standard long form result codes may, in some cases, be displayed on your screen to keep you informed of the actions of your modem. The operating system and application software may suppress display of the result codes.

Examples of result codes are:

- OK
- NO CARRIER
- NO DIALTONE
- CONNECT 53000 (Connection complete at 53,000 bps.)
- ERROR
- FAX
- RING (This means an incoming call.)
- BUSY
- NO ANSWER

When using the internal modem with applications that are not factory installed refer to the application documentation.

Troubleshooting

RESTORING YOUR PRE-INSTALLED SOFTWARE

The Drivers and Applications Restore (DAR) disc contains sets of device drivers and Fujitsu utilities (in specific directories) that are unique to your computer configuration for use as documented below.



In order to install applications and/or drivers from the DAR disc, you will need to use an optical drive either in your system or attached externally.



If you have access to the internet, visit the Fujitsu website at: <http://www.us.fujitsu.com/computers> to check for the most current information, drivers and hints on how to perform recovery and system updates.

Reinstalling Individual Drivers and Applications

The DAR disc can be used to selectively reinstall drivers and/or applications that may have been uninstalled or corrupted.



There may be certain free third-party applications pre-installed on your system that are not on the DAR disc. The latest versions of the applications can be downloaded from the third-party's website.

To reinstall drivers and/or applications:

1. Boot up the system and insert the DAR disc after Windows has started. A Fujitsu Installer screen is displayed after the disc is inserted.
2. After reading the License Agreement, click [I agree].
3. A window will appear containing a list of applications, drivers, and utilities that you can install from the DAR disc.



The components listed are color-coded in terms of their install status. Blue indicates that the component can be installed. Green indicates that the component needs to be installed separately. Grey indicates a component that is already installed; grey items can be reinstalled, but prior to installation you will receive a reminder that the component is already installed.

4. In the list, check off all the components you want to install. If you want to install all components, click [Select All]. Clicking [Select All] will select all of the blue-coded components; you must select grey and green components separately.

5. Once you have selected the components you wish to install, click [Install Selected Subsystems]; the components will be installed.
6. After the components are installed, click [OK], then click [Yes] when asked if you want to reboot the system.

RESTORING THE FACTORY IMAGE

The Restore Disc that came with your system contains two utilities:

- The **Recovery** utility allows you to restore the original contents of the C: drive.
- The **Hard Disk Data Delete** utility on this disc is used to delete all data on your hard disk and prevent it from being reused. Do not use the Hard Disk Data Delete utility unless you are absolutely certain that you want to erase your entire hard disk, including all partitions.



- The use of this disc requires that you have a device capable of reading DVDs attached to your system. If you do not have a built-in DVD player, you will need to attach an external player. For more information on available external devices, visit our Web shopping site at: www.shopfujitsu.com

- This disc can only be used with the system with which it was purchased.

BOOT Priority Change

Before restoring an image, you must first verify that your system is set up to boot from the DVD drive. To verify/change the boot-up priority (rather than booting-up from the hard drive or an external floppy disk drive), perform the following steps:

1. Start your system and press the [F2] key when the Fujitsu logo appears. You will enter the BIOS Setup Utility.
2. Using the arrow keys, go to the Boot menu.
3. Arrow down to the Boot Device Priority submenu. Press [Enter].
4. If "Optical Media Drive" or "CD-ROM Drive" is not at the top of the list, arrow down to the drive in the list, and press the space bar (or the + key) to move it to the top of the list. (The system attempts to boot from the devices in the order in which they are listed.) Note that the BIOS for some systems will indicate "CD-ROM Drive", even when a DVD drive is connected.
5. If you have an *external* DVD drive connected, proceed to the next step; otherwise, proceed to step 7.

6. If you have an external DVD drive connected:
 - Select the Advanced menu in the BIOS window.
 - Scroll down to the USB Features submenu and press the Enter key to open it.
 - If Legacy USB Support is disabled, press the space bar to enable it.
 - Scroll down to SCSI SubClass Support and press the space bar to enable it.
7. Press [F10], then click on [Yes] to exit the BIOS Setup Utility and return to the boot process.

After you have changed the boot priority, you can restore a backup image when you are booting up.

Procedure

1. Turn on the power to your system.
2. Ensure that you have a device that can read DVDs either installed in your system or attached externally to it.
3. Insert the Restore Disc into the drive tray.
4. Reboot your system.



IMPORTANT: While the operating system is booting up during the restoration procedure, your screen will go blank for a short period of time. This is normal. **During the period while your screen is blank, do not press any buttons.** Please wait for the "Set Up Windows" screen to be displayed, then follow the instructions that appear.

5. After the system reboots, follow the instructions that appear to either restore your system image or erase all data from your hard disk.

USING THE SHOCK SENSOR UTILITY

The Shock Sensor Utility is a feature that helps to The Shock Sensor Utility is designed to decrease the risk of damage to the computer's hard disk drive (HDD) in the event of excessive impact or vibration. The Shock Sensor Utility also has the ability to improve the security of the computer by automatically locking the computer with a password when it is carried. Note that the HDD protection and computer locking features are mutually exclusive; both cannot be selected at the same time.



- Shock Sensor Utility does not completely protect the HDD and does not provide absolute security for the computer.
- The computer may stop temporarily while the HDD head is retracted. To restart the computer, keep the system horizontal.

1. Double-click the Shock Sensor Utility icon in the Notification Area at the bottom-right of the screen. The [Shock Sensor Utility] window appears.
2. Click the [Setting] button. The [Shock Sensor Utility Settings] window appears.

Action

Select the action you wish this utility to perform:

- **Protect HDD from impact.** HDD head is retracted when an impact to the computer is detected.
- **Lock computer when carried.** Lock the computer when it is being carried.
- **Nothing.** No action.

Sensitivity of impact/horizontal move/fall/carry detection

Adjust the sensitivity of the acceleration sensor based on system motion or impact.

Ignore periodic vibration.

If vibration is periodic, disregard it.

Ignore mouse click

When the mouse is clicked, sensitivity is temporarily lowered.

Ignore keyboard action

When the keyboard is used, sensitivity is temporarily lowered.

Confirm calibration when user logs on

Select [Confirm calibration when user logs on] if you want to recognize the current orientation as horizontal at logon.

Perform calibration automatically when user logs on.

Select [Perform calibration automatically when user logs on] if the system is normally used on a horizontal surface.

[Calibrate Now]

The calibration is executed. Please position the computer as horizontally as possible, then click the [Calibrate Now] button. The current horizontal position will be recognized as the true horizontal by performing the calibration.

3. Click the [OK] or [Cancel] button. The [Setup] window closes.

Using the Shock Sensor Monitor Window

Right-click the Shock Sensor Utility icon in the Notification Area at the bottom-right of the screen, and select [Monitor] from the menu. The Monitor window appears.

Note that the Monitor is designed for entertainment, and has no effect on system settings or orientation. To navigate the monitor, use the buttons described below.

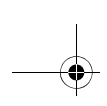

Troubleshooting

- **Advance.** Incline the display to the hinge side, or use [Up] key.
- **Back.** Incline the display to the mouse-button side, or use [Down] key.
- **Right.** Incline the display to the right side, or use [Right] key.
- **Left.** Incline the display to the left side, or use [Left] key.
- **Go up.** Use [A] key.
- **Go down.** Use [Z] key.
- **Close.** Use [Esc] key.

AUTOMATICALLY DOWNLOADING DRIVER UPDATES

Your system has a convenient tool called the Fujitsu Driver Update (FDU) utility. With FDU, you can choose to automatically or manually go to the Fujitsu site to check for new updates for your system.

The FDU icon should appear in the system tray at the bottom right of your screen (roll the cursor over the icons to find the correct one). If the FDU icon does not appear in the system tray, it can be started by going to [Start] -> All Programs, and clicking on Fujitsu Driver Update; this will create the icon automatically.

To invoke the FDU menu, right-click on the FDU icon. The menu contains the following items:

- **Check for updates now**
Allows for manual driver update search. The first time it is used, you are prompted to agree to a user agreement. After clicking on the icon, the FDU automatically connects with the Fujitsu site to check for updates and downloads them. While downloading, the icon has a red bar through it, indicating that it cannot be used while the download is in process. When the update is complete, a message appears informing you of the fact.
- **Enable Automatic Update Notifications**
Automatically searches for new updates on a regular basis (approximately every 3 days).
- **Show update history**
Brings up a screen that displays a history of updates that have been made via the FDU.
- **About Fujitsu Driver Update**
Displays the FDU version number and copyright information
- **Fujitsu Driver Update Readme**
Displays the FDU readme.

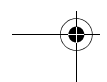
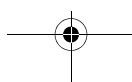
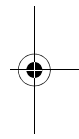
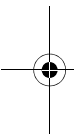

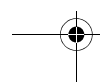
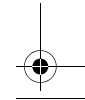
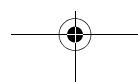
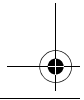
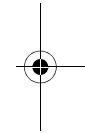
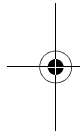
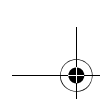

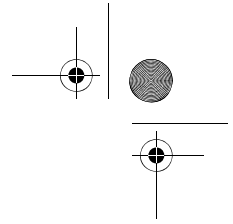
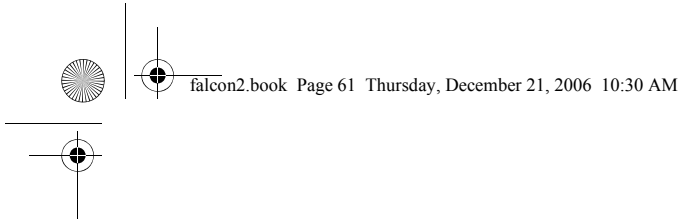

6 Care and Maintenance

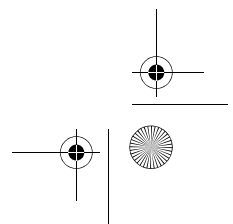
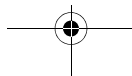
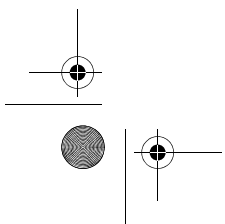
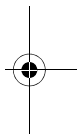
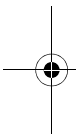

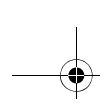

LifeBook A3000 Series Notebook - Section Six

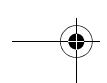
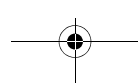
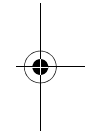
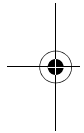

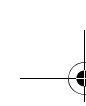

Care and Maintenance

If you use your Fujitsu LifeBook notebook carefully, you will increase its life and reliability. This section provides some tips for looking after the notebook and its devices.

- The system contains components that can be severely damaged by electrostatic discharge (ESD). To minimize risk to the components, observe the following precautions:
 - Be sure to power down your system before adding or removing system components. Even if the system is in hibernate or standby states, data could be lost or memory could be damaged if power is still available to the system.
 - When installing or removing a memory module, hold it by the edge so as not to touch any contacts or chips. Be careful not to touch any internal computer terminals or components; the oil from your fingers could cause a short to the components.
 - Electrical equipment may be hazardous if misused. Operations of this product or similar products, must always be supervised by an adult. Do not allow children access to the interior of any electrical products and do not permit them to handle any cables.



Caring for your LifeBook notebook

- Your LifeBook notebook is a durable but sensitive electronic device. Treat it with respect and care.
- Make a habit of transporting it in a suitable carrying case.
- Do not attempt to service the computer yourself. Always follow installation instructions closely.
- To protect your notebook from damage and to optimize system performance, be sure to **keep all air vents unobstructed, clean, and clear of debris**. This may require periodic cleaning, depending upon the environment in which the system is used.
- Do not operate the notebook in areas where the air vents can be obstructed, such as in tight enclosures or on soft surfaces like a bed or cushion.
- Keep it away from food and beverages.
- If you accidentally spill liquid on your LifeBook notebook:
 1. Turn it off.
 2. Position it so that the liquid can run out.
 3. Let it dry out for 24 hours, or longer if needed.

4. If your notebook will not boot after it has dried out, call your support representative.
- Do not use your Fujitsu LifeBook notebook in a wet environment (near a bathtub, swimming pool).
 - Always use the AC adapter and batteries that are approved for your notebook.
 - Avoid exposure to sand, dust and other environmental hazards.
 - Do not expose your notebook to direct sunlight for long periods of time as temperatures above 140° F (60° C) may damage your notebook.
 - Keep the covers closed on the connectors and slots when they are not in use.
 - Do not put heavy or sharp objects on the computer.
 - If you are carrying your LifeBook notebook in a briefcase, or any other carrying case, make sure that there are no objects in the case pressing on the lid.
 - Never position your notebook such that the optical drive is supporting the weight of the notebook.
 - Do not drop your notebook.
 - Do not touch the screen with any sharp objects.

Cleaning your LifeBook notebook

- Always disconnect the power plug. (Pull the plug, not the cord.)
- Clean your LifeBook notebook with a damp, lint-free cloth. Do not use abrasives or solvents.
- Use a soft cloth to remove dust from the screen. Never use glass cleaners.

Storing your LifeBook notebook

- If storing your notebook for a month or longer, turn your LifeBook notebook off, fully charge the battery, then remove and store all Lithium ion batteries.
- Store your notebook and batteries separately. If you store your LifeBook with a battery installed, the battery will discharge, and battery life will be reduced. In addition, a faulty battery might damage your LifeBook.
- Store your Fujitsu LifeBook in a cool, dry location. Temperatures should remain between 13°F (-25°C) and 140°F (60°C).

Caring for the optional Point and Write Pad

- The stylus should not be used to tap on the display; it has no effect on the display, and could cause damage to the screen if so used.
- Use the stylus gently on the pad so as not to damage the stylus or pad. Little pressure is required for the stylus to work effectively.







LifeBook A3000 Series Notebook - Section Six

- Be careful not to leave the stylus on the keyboard or palm rest when closing the display.

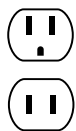
Traveling with your LifeBook notebook

- Do not transport your notebook while it is turned on.
- It is recommended that you carry your notebook with you while traveling, rather than checking it in as baggage.
- Always bring your System Recovery CD that came with your notebook when you travel. If you experience system software problems while traveling, you may need it to correct any problems.
- Never put your notebook through a metal detector. Have your notebook hand-inspected by security personnel. You can however, put your notebook through a properly tuned X-ray machine. To avoid problems, place your notebook close to the entrance of the machine and remove it as soon as possible or have your notebook hand-inspected by security personnel. Security officials may require you to turn your notebook On. Make sure you have a charged battery on hand.
- Take the necessary plug adapters if you're traveling overseas. Check the following diagram to determine which plug adapter you'll need or ask your travel agent.

Outlet Type	Location
	United States, Canada, parts of Latin America, Mexico, Japan, Korea, the Philippines, Taiwan
	Russia and the Commonwealth of Independent States (CIS), most of Europe, parts of Latin America, the Middle East, parts of Africa, Hong Kong, India, most of South Asia
	United Kingdom, Ireland, Malaysia, Singapore, parts of Africa
	China, Australia, New Zealand

BATTERIES

Caring for your Batteries

- Always handle batteries carefully.
- Do not short-circuit the battery terminals (that is, do not touch both terminals with a metal object). Do not carry loose batteries in a pocket or purse where they may

mix with coins, keys, or other metal objects. Doing so may cause an explosion or fire.

- Do not drop, puncture, disassemble, mutilate or incinerate the battery.
- Recharge batteries only as described in this manual and only in ventilated areas.
- Do not leave batteries in hot locations for more than a day or two. Intense heat can shorten battery life.
- Do not leave a battery in storage for longer than 6 months without recharging it.

Increasing Battery Life

- Power your LifeBook notebook through the AC or optional auto/airline adapter whenever possible.
- If your notebook is running on battery power all day, connect it to the AC adapter overnight to recharge the battery.
- Keep brightness to the lowest level comfortable.
- Set the power management for maximum battery life.
- Put your notebook in Standby mode when it is turned on and you are not actually using it.
- Limit your media drive access.
- Disable the Media Player auto insert notification function.
- Always use fully charged batteries.
- Eject PC Cards and ExpressCards when not in use.

FLOPPY DISKS AND DRIVES

Caring for your Floppy Disks

Note that the external floppy disk drive is an optional device.

- Avoid using the floppy disks in damp and dusty locations.
- Never store a floppy disk near a magnet or magnetic field.
- Do not use a pencil or an eraser on a disk or disk label.
- Avoid storing the floppy disks in extremely hot or cold locations, or in locations subject to severe temperature changes. Store at temperatures between 50° F (10°C) and 125° F (52°C).
- Do not touch the exposed part of the disk behind the metal shutter.
- Never use the floppy disk drive with any liquid, metal, or other foreign matter inside the floppy disk drive or disk.
- Never disassemble your floppy disk drive.

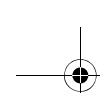

Care and Maintenance

MEDIA CARE

Caring for your Media (DVD/CD/CD-R)

Media discs are precision devices and will function reliably if given reasonable care.

- Always store your media disc in its case when it is not in use.
- Always handle discs by the edges and avoid touching the surface.
- Avoid storing any media discs in extreme temperatures.
- Do not bend media discs or set heavy objects on them.
- Do not spill liquids on media discs.
- Do not scratch media discs.
- Do not get dust on media discs.
- Never write on the label surface with a ballpoint pen or pencil. Always use a felt pen.
- If a media disc is subjected to a sudden change in temperature, cold to warm condensation may form on the surface. Wipe the moisture off with a clean, soft, lint free cloth and let it dry at room temperature. DO NOT use a hair dryer or heater to dry media discs.
- If a disc is dirty, use only a DVD/CD cleaner or wipe it with a clean, soft, lint free cloth starting from the inner edge and wiping to the outer edge.

Caring for your Optical Drive

Your optical drive is durable but you must treat it with care. Please pay attention to the following points:

- The drive rotates the compact disc at a very high speed. Do not carry it around or subject it to shock or vibration with the power on.
- Avoid using or storing the drive where it will be exposed to extreme temperatures.
- Avoid using or storing the drive where it is damp or dusty.
- Avoid using or storing the drive near magnets or devices that generate strong magnetic fields.
- Avoid using or storing the drive where it will be subjected to shock or vibration.
- Do not disassemble or dismantle the optical drive.
- Use of a commercially available lens cleaner is recommended for regular maintenance of your drive.

PC CARDS/EXPRESSCARDS

Caring for your Cards

PC Cards and ExpressCards are durable, but you must treat them with care. The documentation supplied with your card will provide specific information, but you should pay attention to the following points:

- To keep out dust and dirt, store cards in their protective sleeves when they are not installed in your LifeBook notebook.
- Avoid prolonged exposure to direct sunlight or excessive heat.
- Keep the cards dry.
- Do not flex or bend the cards, and do not place heavy objects on top of them.
- Do not force cards into the slot.
- Avoid dropping cards, or subjecting them to excessive vibration.

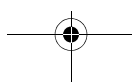
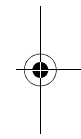
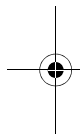

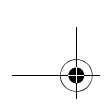

LifeBook A3000 Series Notebook - Section Six

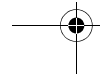
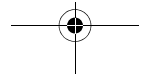
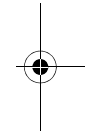
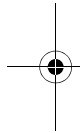

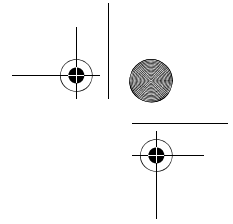
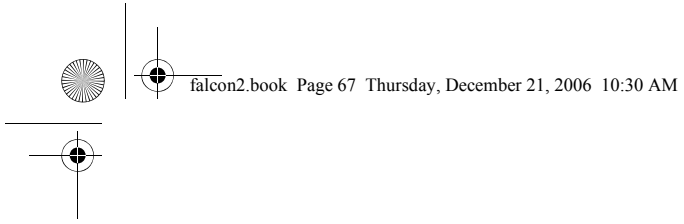

7 System Specifications

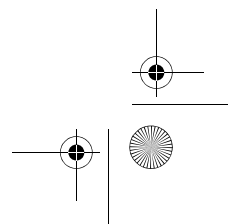
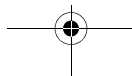
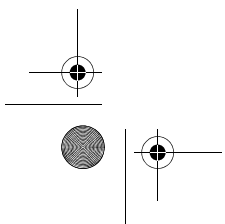
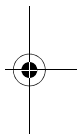
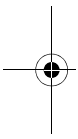

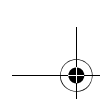

LifeBook A3000 Series Notebook - Section Seven

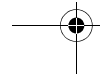
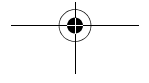
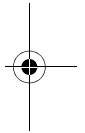
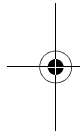



Specifications

Specifications

This section provides the hardware and environmental specifications for your Fujitsu LifeBook notebook. Specifications of particular configurations will vary.

CONFIGURATION LABEL

There is a configuration label located on the bottom of your LifeBook notebook. (See Figure 2-7 on page 10 for location). This label contains specific information regarding the options you've chosen for your notebook. Following is an example label and information on how to read your own configuration label.

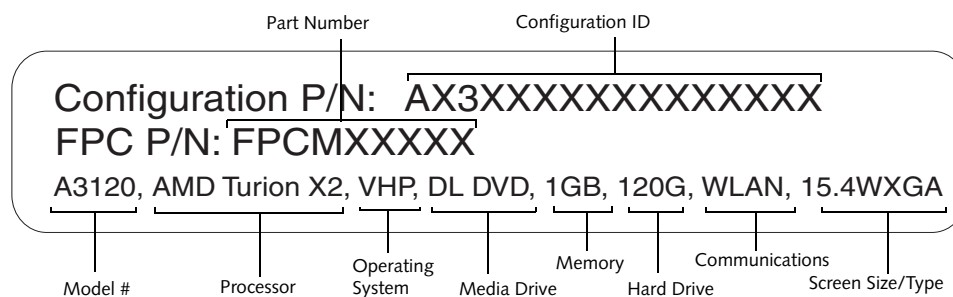

Figure 7-1 Configuration Label

MICROPROCESSOR

AMD Turion™ 64 X2 Mobile Technology microprocessor (To determine the processor speed, right-click My Computer, select Properties, then select the General tab.)

CHIPSET

ATI Radeon® Xpress 1150

MEMORY

System Memory

- DDR2 667 MHz SDRAM dual-channel memory module.
- Two DIMM slots; upgradeable to 4 GB of total memory (2 GB x 2). **Note:** If 4 GB are installed, only 3.25 GB are usable by the system due to operating system constraints.

Cache Memory

Depending upon the system processor, cache memory is either 2 MB or 4 MB cache on-die

VIDEO

Built-in color flat-panel TFT active matrix LCD display with simultaneous display capability

Video Color and Resolution

15.4" Crystal View WXGA:

- Internal: 1280 x 800 pixel resolution, 16M colors
- External: 1600 x 1200 pixel resolution, 16M colors
- Simultaneous Video: Max. 1280 x 800 pixel resolution, 16M colors

Video RAM

Up to 256 MB (selectable in the BIOS from 32 MB to 256 MB) of shared memory using Unified Memory Architecture (UMA). The amount of selectable Video RAM is dependent upon the amount of main memory installed, as noted in the following table.

Main Memory	256 MB	512 MB	768 MB	1 GB +
Default VRAM	32 MB	64 MB	64 MB	64 MB
Maximum VRAM	64 MB	128 MB	128 MB	256 MB

Table 7-1 Video RAM

AUDIO

- Realtek codec ALC262
- **Headphones:** Stereo headphone/line-out jack, 3.5 mm, 1 V_{rms} or less, minimum impedance 32 Ohms
- **Microphone:** Stereo microphone/line-in jack, 3.5 mm, 100 mV_{rms} or less, minimum impedance 1.5K Ohms
- Two built-in stereo speakers, 20 mm diameter

MASS STORAGE DEVICE OPTIONS

- **Hard Drive:** 120 GB, P-ATA, 4200 rpm, Ultra-DMA 100, 2.5", 9.5 mm, protected by smart Shock Sensor technology on main PCB
- **Dual-Layer Multi-Format DVD Writer:** modular 8x DVD-R (4x Dual-layer DVD-R), 6x DVD-RW, 8x DVD+R (4x Dual-layer DVD+R), 8x DVD+RW, 5x DVD-RAM, 8x DVD-ROM, 24x CD-R, 10xW/16xR CD-RW, 24x CD-ROM

FEATURES

Integrated Pointing Device

- Touchpad pointing device with fingerprint sensor that can also be used for scroll function.
- Optional Point and Write Pad with active stylus input

Communications

Modem: Internal V.90 standard 56K fax/modem (ITU V.90, 56K data, 14.4K fax)

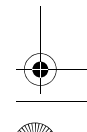
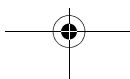
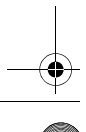
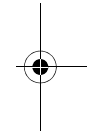
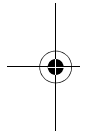

Gigabit LAN: Internal Marvell 88E8055 wired 10Base-T/100Base-Tx/1000Base-T) Ethernet LAN

Wireless LAN:

- Integrated Atheros SuperAG Wireless LAN (802.11a+b/g) with Antenna On/Off switch
- Bluetooth device for wireless personal area network communication (controlled by WLAN On/Off switch)

LifeBook Application Panel

The Application Launcher/Volume buttons on your LifeBook notebook default to the following applications:

Button Label	Default Application
My Home	Default Browser
Web Search	www.google.com
A	Notepad
B	Calculator
C	Unassigned
Volume -	Volume Down
Volume +	Volume Up

Table 7-2 Application Launcher Defaults

Theft Prevention Lock

Lock slot for use with security restraint systems.

DEVICE PORTS

On the LifeBook notebook:

- PC Card slot for one Type I or Type II card: PCMCIA Standard 2.1 with CardBus support
- ExpressCard slot for one ExpressCard
- SD/Memory Stick/xD Card slot
- One 15-pin D-SUB connector for VGA external monitor (see Display specifications)
- Five USB 2.0 (Universal Serial Bus) connectors for input/output devices
- One IEEE 1394 (4-pin type) jack
- One 7-pin video out jack
- One modular modem (RJ-11) connector
- One LAN (RJ-45) connector
- One stereo headphone/line-out jack
- One stereo microphone/line-in jack
- Wireless LAN antenna with pre-installed on/off switch
- Bluetooth module with antenna (shares WLAN switch for on/off)

KEYBOARD

Built-in keyboard with all functions of 101 key PS/2 compatible keyboards.

- Total number of keys: 84
- Function keys: F1 through F12
- Feature extension key: Fn
- Two Windows keys: one Start key, one application key
- Key pitch: 19 mm
- Key stroke: 2.7 mm
- Built-in Touchpad pointing device with left and right buttons and scroll sensor.
- Built-in Palm Rest
- Spill-resistant design

External Keyboard Support

USB-compatible

External Mouse Support

USB-compatible

POWER

Batteries

Main Lithium ion battery: 6-cell, rechargeable, 10.8 V, 4000 mAh, 43.2 Wh

AC Adapter

Autosensing 100-240V AC, supplying 19V DC, 4.22A, 80W to the LifeBook notebook, including an AC cable.

Power Management

Conforms to ACPI (Advanced Configuration and Power Interface).

DIMENSIONS AND WEIGHT

Overall Dimensions

Approximately 14.7"(w) x 10.43"(d) x 1.55"(h)
(360 mm x 265 mm x 39.3 mm)

Weight

Approximately 6.61 lbs. (3.0 kg) with battery installed

ENVIRONMENTAL REQUIREMENTS

Temperature

Operating: 41° to 95° F (5° to 35° C)
Non-operating: 5° to 140° F (-15° to 60° C)

Humidity

Operating: 20% to 85%, relative, non-condensing
Non-operating: 8% to 85%, relative, non-condensing

Altitude

Operating: 10,000 feet (3,048 m) maximum

POPULAR ACCESSORIES

For ordering or additional information on Fujitsu accessories, visit our website at: www.shopfujitsu.com or call 1-800-FUJITSU (1-800-385-4878).

Specifications

PRE-INSTALLED SOFTWARE

Depending on your pre-installed operating system, your Fujitsu LifeBook notebook comes with pre-installed software for playing audio and video files of various formats. In addition there is file transfer software, virus protection software and Power Management software. The following list indicates the pre-installed software associated with your system.

- Adobe Reader
- EverNote
- Fujitsu Driver Update utility
- Fujitsu HotKey
- Fujitsu Shock Sensor Utility
- Google Desktop
- Google Tool Bar
- Google Sideshow
- Google Picasa
- LifeBook Application Panel
- Microsoft Works 8.5 (on select models)
- OmniPass Fingerprint Recognition Utility
- Symantec Norton Internet Security (90-day free trial)

LEARNING ABOUT YOUR SOFTWARE

Tutorials

All operating systems and most application software have tutorials built into them. We recommend that you step through the tutorial before you use an application.

Manuals

Included with your notebook you will find manuals for your installed operating system and other pre-installed software. Any manuals that are not included are available online through the help system of the software. We recommend that you review these manuals for general information on the use of these applications.

Adobe Acrobat Reader

The Adobe Acrobat Reader allows you to view, navigate, and print PDF files from across all of the major computing platforms.

EverNote

EverNote allows you to easily capture, store and access a variety of documents, such as typed and handwritten memos, webpage excerpts, emails, phone messages, addresses, passwords, sketches, and documents.

Fujitsu Driver Update Utility

The Fujitsu Driver Update (FDU) utility is pre-installed on your system. With FDU, you can choose to automatically or manually go to the Fujitsu site to check for new updates for your system. *(See Automatically Downloading Driver Updates on page 59 for more information)*

Fujitsu HotKey

Fujitsu HotKey allows you to control the display brightness of your notebook in order to maximize battery life.

Fujitsu Shock Sensor Utility

The Shock Sensor Utility is designed to decrease the risk of damage to your hard disk drive (HDD) in the event of excessive impact or vibration. Shock Sensor promptly parks the hard disk drive read/write head when subjected to a fall or vibration, thus helping to protect data from being damaged. The Shock Sensor Utility can also improve computer security by automatically locking it with a password when it is carried.

Google Desktop

Google Desktop lets you to search the contents of your computer for emails, web history, and files. It also allows you to view news and photos from anywhere on your desktop.

Google Picasa

Google Picasa lets you to search for, locate, move and label all of the photos on your computer.

Google Sidebar

Google Sidebar is a vertical bar on your desktop which provides at-a-glance access to information such as weather, stock information, news, or email.

Google Toolbar

Google Toolbar lets you to search the Internet quickly, block pop-ups, and perform a variety of other tasks to make your Internet experience easier and more pleasant.

LifeBook Application Panel Software

Your LifeBook is pre-installed with software utilities that let you operate and configure your LifeBook Application Panel. The Application Panel utilities are found under Start -> Settings -> Control Panel -> Application Panel.

OmniPass Fingerprint Recognition Software

The fingerprint sensor uses Softex OmniPass which provides password management capabilities to Microsoft Windows operating systems. OmniPass lets you use a "master password" for all Windows, applications, and on-line passwords, and presents a convenient user interface through which you can securely manage passwords, users, and multiple identities for each user.

Norton Internet Security™ from Symantec

Your system is pre-installed with a free 90-day trial version of Symantec's Norton Internet Security™. Internet Security is designed to protect your notebook from computer viruses. It assists in protection of the data currently on your hard disk from contamination or destruction. The trial version is activated upon acceptance of software license agreement. After 90 days, you must purchase a subscription from Symantec to download the latest definitions. *(See online help or manual for more information on how and when to run this program)*

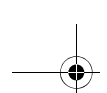

Operating System Options

Depending upon your system, one of the following operating system configurations will be installed:

Microsoft Windows Vista Home Premium Edition
With Microsoft Works 8.5 and Microsoft Office 60-day trial (home and Student Edition 2007)

Microsoft Windows Vista Business Edition
With Microsoft Works 8.5 and Microsoft Office Small Business Edition 2007

- **Microsoft Works 8.5**
Microsoft Works 8.5 is a software suite containing the basic tools to write letters and reports, track family and friends with address books, manage home finances, and create a home inventory.
- **Microsoft Office Home and Student Edition 2007**
(Optional with Microsoft Windows Vista Home Premium Edition) Microsoft Office Home and Student 2007 is easy-to-use software to make you more productive in a home and/or school environment. Microsoft Office Home and Student 2007 includes Microsoft Word, Excel, PowerPoint, and OneNote.
- **Office Microsoft Small Business Edition 2007**
(Optional with Microsoft Windows Vista Business Edition) Microsoft Office 2007 Small Business Edition is easy-to-use software to help you manage business opportunities more effectively, create marketing materials, manage e-mail, and share information. Microsoft SBE includes Microsoft Word, Excel, Outlook, PowerPoint, Publisher, and Business Contact Manager.



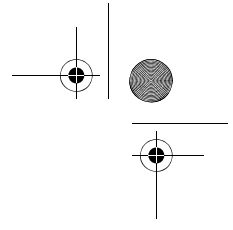
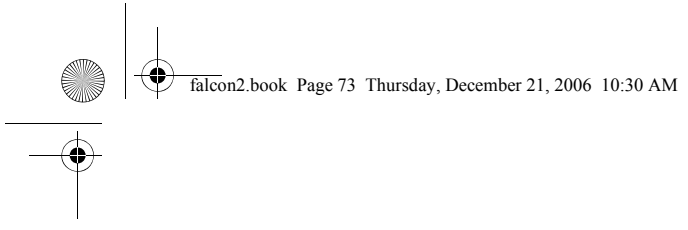

8 Glossary

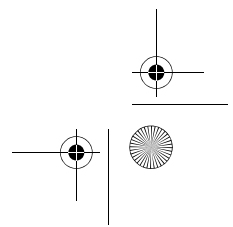
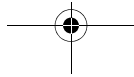
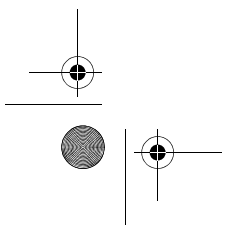
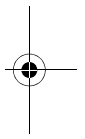
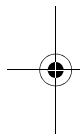

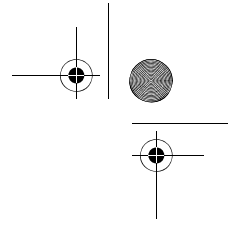
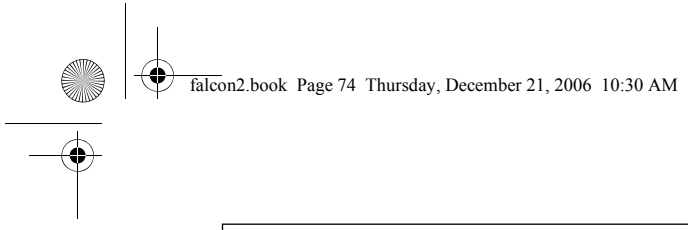

LifeBook A3000 Series Notebook - Section Eight

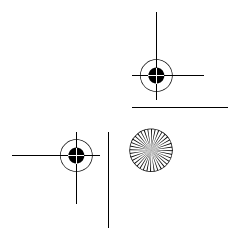
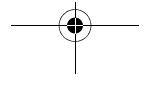
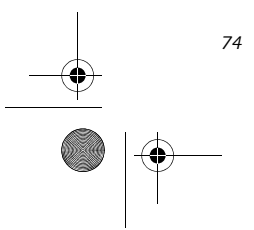
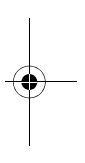
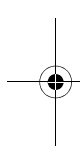

Glossary

AC Adapter

A device which converts the AC voltage from a wall outlet to the DC voltage needed to power your LifeBook notebook.

ACPI

Advanced Configuration and Power Interface

Active-Matrix Display

A type of technology for making flat-panel displays which has a transistor or similar device for every pixel on the screen.

AdHoc

A name of a wireless LAN configuration.

It is a type of communication using wireless cards only.

Another type of communication is called Infrastructure (using a wireless card and an access point).

ADSL

Asymmetric Digital Subscriber Line

Technology for transporting high bit-rate services over ordinary phone lines.

AGP

Accelerated Graphics Port

Graphics port specifically designed for graphics-intensive devices, such as video cards and 3D accelerators.

Auto/Airline Adapter

A device which converts the DC voltage from an automobile cigarette lighter or aircraft DC power outlet to the DC voltage needed to power your LifeBook notebook.

BIOS

Basic Input-Output System. A program and set of default parameters stored in ROM which tests and operates your LifeBook notebook when you turn it on until it loads your installed operating system from disk. Information from the BIOS is transferred to the installed operating system to provide it with information on the configuration and status of the hardware.

Bit

An abbreviation for binary digit. A single piece of information which is either a one (1) or a zero (0).

bps

An abbreviation for bits per second. Used to describe data transfer rates.

Boot

To start-up a computer and load its operating system from disk, ROM or other storage media into RAM.

Bus

An electrical circuit which passes data between the CPU and the sub-assemblies inside your LifeBook notebook.

Byte

8 bits of parallel binary information.

Cache Memory

A block of memory built into the micro-processor which is much faster to access than your system RAM and used in specially structured ways to make your overall data handling time faster.

CardBus

A faster, 32-bit version of the PC Card interface which offers performance similar to the 32-bit PCI architecture.

CD-ROM

Compact disk read only memory. This is a form of digital data storage which is read optically with a laser rather than a magnetic head. A typical CD-ROM can contain about 600MB of data and is not subject to heads crashing into the surface and destroying the data when there is a failure nor to wear from reading.

Channel

A radio frequency band used for communication between wireless cards and access points.

CMOS RAM

Complementary metal oxide semiconductor random access memory. This is a technology for manufacturing random access memory which requires very low levels of power to operate.

Command

An instruction which you give your operating system. Example: run a particular application or format a floppy disk.

Configuration

The combination of hardware and software that makes up your system and how it is allocated for use.

CRT

Cathode Ray Tube. A display device which uses a beam of electronic particles striking a luminescent screen. It produces a visual image by varying the position and intensity of the beam.

Data

The information a system stores and processes.

DC

Direct current. A voltage or current that does not fluctuate periodically with time.

Default Value

A pre programmed value to be used if you fail to set your own.

DHCP

Dynamic Host Configuration Protocol

A protocol used to automatically acquire parameters required for the communication, such as IP address.

The sender of IP address is called a DHCP server, and the receiver is called a DHCP client.

DIMM

Dual-in-line memory module.

Disk

A spinning platter of magnetic data storage media. If the platter is very stiff it is a hard drive, if it is highly flexible it is a floppy disk, if it is a floppy disk in a hard housing with a shutter it is commonly called a diskette.

Disk Drive

The hardware which spins the disk and has the heads and control circuitry for reading and writing the data on the disk.

Diskette

A floppy disk in a hard housing with a shutter.

DMA

Direct Memory Access. Special circuitry for memory to memory transfers of data which do not require CPU action.

DMI

Desktop Management Interface. A standard that provides PC management applications with a common method of locally or remotely querying and configuring PC computer systems, hardware and software components, and peripherals.

DNS

Domain Name System

A function to control the association between the IP address and the name assigned to the computer.

If you do not know the IP address but if you know the computer name, you can still communicate to that computer.

Driver

A computer program which converts application and operating system commands to external devices into the exact form required by a specific brand and model of device in order to produce the desired results from that particular equipment.

DVMT

Dynamic Video Memory Technology

A video memory architecture that increases the efficiency of the motherboard by using innovative memory utilization and direct AGP.

ECP

Extended Capability Port. A set of standards for high speed data communication and interconnection between electronic devices.

Encryption Key (Network Key)

Data encryption key used to encrypt message text and for computing message integrity checks. Data encryption protects data from unauthorized viewing.

This device uses the same encryption key to encode and decode the data, and the identical encryption key is required between the sender and receiver.

ESD

Electrostatic Discharge. The sudden discharge of electricity from a static charge which has built-up slowly. Example: the shock you get from a doorknob or the sparks you get from brushing hair on a dry day.

Extended Memory

All memory more than the 640KB recognized as system memory.

FCC

Federal Communication Commission.

Floppy Disk

A spinning platter of magnetic data storage media which is highly flexible.

GB

Gigabyte.

Hard drive

A spinning platter of magnetic data storage media where the platter is very stiff.

I/O

Input/Output. Data entering and leaving your notebook in electronic form.

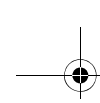

Glossary

I/O Port

The connector and associated control circuits for data entering and leaving your notebook in electronic form.

IDE

Intelligent Drive Electronics. A type of control interface for a hard drive which is inside the hard drive unit.

Infrastructure

A name of a wireless LAN configuration. This type of communication uses an access point.

Another type of communication is called AdHoc.

IP Address

An identifier for a computer or device on a TCP/IP network. Networks using the TCP/IP protocol route messages based on the IP address of the destination. The format of an IP address is a 32-bit numeric address written as four numbers separated by periods. Each number can be zero to 255. For example, 1.160.10.240 could be an IP address.

Within an isolated network, you can assign IP addresses at random as long as each one is unique. However, connecting a private network to the Internet requires using registered IP addresses (called Internet addresses) to avoid duplicates.

The four numbers in an IP address are used in different ways to identify a particular network and a host on that network. Three regional Internet registries -- ARIN, RIPE NCC and APNIC -- assign Internet addresses from the following three classes.

Class A - supports 16 million hosts on each of 126 networks

Class B - supports 65,000 hosts on each of 16,000 networks

Class C - supports 254 hosts on each of 2 million networks

The number of unassigned Internet addresses is running out, so a new classless scheme called CIDR is gradually replacing the system based on classes A, B, and C and is tied to adoption of IPv6. (credit: webopedia.com)

IR

An abbreviation for infrared.

IRQ

Interrupt Request. An acronym for the hardware signal to the CPU that an external event has occurred which needs to be processed.

KB

Kilobyte.

LAN

Local Area Network. An interconnection of computers and peripherals within a single limited geographic location which can pass programs and data amongst themselves.

LCD

Liquid Crystal Display. A type of display which makes images by controlling the orientation of crystals in a crystalline liquid.

Lithium ion Battery

A type of rechargeable battery which has a high power-time life for its size and is not subject to the memory effect as Nickel Cadmium batteries.

MAC Address

Media Access Control Address

A unique physical address of a network card. For Ethernet, the first three bytes are used as the vendor code, controlled and assigned by IEEE. The remaining three bytes are controlled by each vendor (preventing overlap), therefore, every Ethernet card is given a unique physical address in the world, being assigned with a different address from other cards. For Ethernet, frames are sent and received based on this address.

MB

Megabyte.

Megahertz

1,000,000 cycles per second.

Memory

A repository for data and applications which is readily accessible to your LifeBook notebook's CPU.

MHz

Megahertz.

Modem

A contraction for MOdulator-DEModulator. The equipment which connects a computer or other data terminal to a communication line.

Monaural

A system using one channel to process sound from all sources.

MTU

Maximum Transmission Unit

The maximum data size that can be transferred at a time through the Internet or other networks. You can set a smaller MTU size to obtain successful communication, if you have difficulty transferring data due to the fact that the maximum size is too large.

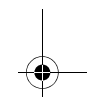
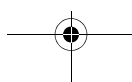
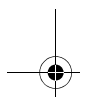
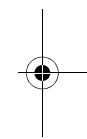
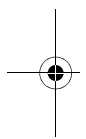

NTSC

National TV Standards Commission. The standard for TV broadcast and reception for the USA.

Operating System

A group of control programs that convert application commands, including driver programs, into the exact form required by a specific brand and model of micro-processor in order to produce the desired results from that particular equipment.

Partition

A block of space on a hard drive which is set aside and made to appear to the operating system as if it were a separate disk, and addressed by the operating system accordingly.

PCI

Peripheral Component Interconnect

Self-configuring PC local bus. Designed by Intel, PCI has gained wide acceptance as a standard bus design.

PCMCIA

PCMCIA is a trademark of the Personal Computer Memory Card International Association. The Personal Computer Memory Card International Association is an organization that sets standards for add-in cards for personal computers.

Peripheral Device

A piece of equipment which performs a specific function associated with but not integral to a computer. Examples: a printer, a modem, a CD-ROM.

Pitch (keyboard)

The distance between the centers of the letter keys of a keyboard.

Pixel

The smallest element of a display, a dot of color on your display screen. The more pixels per area the clearer your image will appear.

POST

Power On Self Test. A program which is part of the BIOS which checks the configuration and operating condition of your hardware whenever power is applied to your notebook. Status and error messages may be displayed before the operating system is loaded. If the self test detects failures that are so serious that operation can not continue, the operating system will not be loaded.

PPPoE

Point to Point Protocol over Ethernet.

A protocol for Ethernet, using a Point-to-Point Protocol (PPP), which is used for connection on the phone line.

Program

An integrated set of coded commands to your computers telling your hardware what to do and how and when to do it.

Protocol

Procedures and rules use to send and receive data between computers.

- Method of sending and receiving data

- Process used to handle communication errors

Conditions required for communication are organized in procedures for correct transfer of information.

RAM

Random Access Memory. A hardware component of your LifeBook notebook that holds binary information (both program and data) as long as it has the proper power applied to it.

RAM Module

A printed circuit card with memory and associated circuitry which allows the user to add additional memory to the computer without special tools.

Reset

The act of reloading the operating system. A reset erases all information stored in RAM.

Restart

See Reset.

Resume

To proceed after interruption. In your notebook this refers to returning to active operation after having been in one of the suspension states.

ROM

Read Only Memory. A form of memory in which information is stored by physically altering the material. Data stored in this way can not be changed by your notebook and does not require power to maintain it.

SDRAM

Synchronous Dynamic Random Access Memory.

Glossary

SRAM

Static random access memory. A specific technology of making RAM which does not require periodic data refreshing.

SSID

Service Set Identifier

Specifies which network you are joining. Some systems allow you to specify any SSID as an option so you can join any network.

Standby

To make inoperative for a period of time. Your LifeBook notebook uses various suspension states to reduce power consumption and prolong the charge of your battery.

Status Indicator

A display which reports the condition of some portion of your hardware. On your LifeBook notebook this is an LCD screen just above the keyboard.

Stereo (audio)

A system using two channels to process sound from two different sources.

SVGA

Super VGA.

S-Video

Super Video. A component video system for driving a TV or computer monitor.

System Clock

An oscillator of fixed precise frequency which synchronizes the operation of the system and is counted to provide time of day and date.

TCP/IP

Transmission Control Protocol/Internet Protocol.
A standard Internet protocol that is most widely used.

TFT

Thin Film Transistor – A technology for flat display panels which uses a thin film matrix of transistors to control each pixel of the display screen individually.

UL

Underwriters Laboratories – An independent organization that tests and certifies the electrical safety of devices.

USB

Universal Serial Bus.
Standard that allows you to simultaneously connect up to 127 USB devices such as game pads, pointing devices, printers, and keyboards to your computer.

VGA

Video Graphics Array. A video display standard originally introduced by IBM with the PS/2 series of personal computers.

VRAM

Video Random Access Memory. A memory dedicated to video display data and control.

WFM

Wired for Management is Intel's broad-based initiative to reduce the total cost of ownership (TCO) of business computing without sacrificing power and flexibility.

Wi-Fi Compatible

Wi-Fi (Wireless Fidelity) Identifies that the product has passed the interoperability test, supplied by the WECA (Wireless Ethernet Compatibility Alliance), which guarantees the interoperability of wireless IEEE 802.11 LAN products. For more information on the Wi-Fi standard, go to the WECA website at: www.wirelessethernet.com.

WLAN

Wireless Local Area Network. A wireless interconnection of computers and peripherals within a single limited geographic location which can pass programs and data amongst themselves.

Write Protect

Prevent alteration of the binary state of all bits in a storage media. Example: all information on a device such as a floppy diskette; a block of space in a storage media such as a partition of a hard drive; a file or directory of floppy diskette or hard drive.

XGA

Extended VGA.

Regulatory Information

NOTICE

Changes or modifications not expressly approved by Fujitsu could void this user's authority to operate the equipment.

FCC NOTICES

Notice to Users of Radios and Television

These limits are designed to provide reasonable protection against harmful interference in a residential installation. This equipment generates, uses, and can radiate radio frequency energy and, if not installed and used in accordance with the instructions, may cause harmful interference to radio communications. However, there is no guarantee that interference will not occur in a particular installation. If this equipment does cause harmful interference to radio or television reception, which can be determined by turning the equipment off and on, the user is encouraged to try to correct the interference by one or more of the following measures:

- Reorient or relocate the receiving antenna.
- Increase the separation between the equipment and receiver.
- Connect the equipment into an outlet that is on a different circuit than the receiver.
- Consult the dealer or an experienced radio/TV technician for help.

Shielded interconnect cables must be employed with this equipment to ensure compliance with the pertinent RF emission limits governing this device.

Notice to Users of the US Telephone Network

This equipment complies with Part 68 of the FCC rules, and the requirements adopted by ACTA. On the bottom of this equipment is a label that contains, among other information, the FCC registration number and ringer equivalence number (REN) for this equipment; or a product identifier in the format US:AAAEQ##TXXXX. If requested, this information or number must be provided to the telephone company.

This equipment is designed to be connected to the telephone network or premises wiring using a standard jack type USOC RJ11C. A plug and jack used to connect this equipment to the premises wiring and telephone network must comply with the applicable FCC Part 68 rules and requirements adopted by the ACTA. A compliant telephone cord and modular plug is provided with this product. It is designed to be connected to a compatible modular jack that is also compliant.

The ringer equivalent number (REN) of this equipment is 0.1B as shown on the label. The REN is used to determine the number of devices that may be connected to a telephone line. Excessive RENs on a telephone may result in the devices not ringing in response to an incoming call. In most but not all areas, the sum of RENs should not exceed five (5.0). To be certain of the number of devices that may be connected to a line, as determined by the total RENs, contact the local telephone company.

If this equipment causes harm to the telephone network, the telephone company will notify you in advance that temporary discontinuance of service may be required. But if advance notice isn't practical, the telephone company will notify the customer as soon as possible. Also, you will be advised of your right to file a complaint with the FCC if you believe it is necessary.

The telephone company may make changes in its facilities, equipment, operations or procedures that could affect the operation of the equipment. If this happens the telephone company will provide advance notice in order for you to make necessary modifications to maintain uninterrupted service.

If trouble is experienced with this equipment, for repair or warranty information, please refer to the manual or contact Fujitsu Computer Systems Corporation, Customer Service. If the equipment is causing harm to the telephone network, the telephone company may request that you disconnect the equipment until the problem is resolved.

The equipment cannot be used on public coin service provided by the telephone company. Connection to party line service is subject to state tariffs. (Contact the state public utility commission, public service commission or corporation commission for information).

If your home has specially wired alarm equipment connected to the telephone line, ensure the installation of this computer does not disable your alarm equipment. If you have any questions about what will disable alarm equipment, consult your telephone company or a qualified installer.

The Telephone Consumer Protection Act of 1991 makes it unlawful for any person to use a computer or other electronic device to send any message via a telephone fax machine unless such message clearly contains in a margin at the top or bottom of each transmitted page or on the first page of the transmission, the date and time it is sent and an identification of the business or other entity, or other individual sending the message and the telephone number of the sending machine or such business, other entity, or individual.

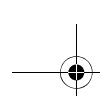

Regulatory Information

DOC (INDUSTRY CANADA) NOTICES

Notice to Users of Radios and Television

This Class B digital apparatus meets all requirements of Canadian Interference-Causing Equipment Regulations.

CET appareil numérique de la class B respecte toutes les exigences du Règlement sur le matériel brouilleur du Canada.

Notice to Users of the Canadian Telephone Network

NOTICE: This equipment meets the applicable Industry Canada Terminal Equipment Technical Specifications. This is confirmed by the registration number. The abbreviation, IC, before the registration number signifies that registration was performed based on a Declaration of Conformity indicating that Industry Canada technical specifications were met. It does not imply that Industry Canada approved the equipment.

Before connecting this equipment to a telephone line the user should ensure that it is permissible to connect this equipment to the local telecommunication facilities. The user should be aware that compliance with the certification standards does not prevent service degradation in some situations.

Repairs to telecommunication equipment should be made by a Canadian authorized maintenance facility. Any repairs or alterations not expressly approved by Fujitsu or any equipment failures may give the telecommunication company cause to request the user to disconnect the equipment from the telephone line.

NOTICE: The Ringer Equivalence Number (REN) for this terminal equipment is 0.1B. The REN assigned to each terminal equipment provides an indication of the maximum number of terminals allowed to be connected to a telephone interface. The termination on an interface may consist of any combination of devices subject only to the requirement that the sum of the Ringer Equivalence Numbers of all the devices does not exceed five.



For safety, users should ensure that the electrical ground of the power utility, the telephone lines and the metallic water pipes are connected together. Users should NOT attempt to make such connections themselves but should contact the appropriate electric inspection authority or electrician. This may be particularly important in rural areas.

Avis Aux Utilisateurs Du Réseau Téléphonique Canadien

AVIS: Le présent matériel est conforme aux spécifications techniques d'Industrie Canada applicables au matériel terminal. Cette conformité est confirmée par le numéro d'enregistrement. Le sigle IC, placé devant le numéro d'enregistrement, signifie que l'enregistrement s'est effectué conformément à une déclaration de conformité et indique que les spécifications techniques d'Industrie Canada ont été respectées. Il n'implique pas qu'Industrie Canada a approuvé le matériel.

Avant de connecter cet équipement à une ligne téléphonique, l'utilisateur doit vérifier s'il est permis de connecter cet équipement aux installations de télécommunications locales. L'utilisateur est averti que même la conformité aux normes de certification ne peut dans certains cas empêcher la dégradation du service.

Les réparations de l'équipement de télécommunications doivent être effectuées par un service de maintenance agréé au Canada. Toute réparation ou modification, qui n'est pas expressément approuvée par Fujitsu, ou toute défaillance de l'équipement peut entraîner la compagnie de télécommunications à exiger que l'utilisateur déconnecte l'équipement de la ligne téléphonique.

AVIS: L'indice d'équivalence de la sonnerie (IES) du présent matériel est de 0.1B. L'IES assigné à chaque dispositif terminal indique le nombre maximal de terminaux qui peuvent être raccordés à une interface téléphonique. La terminaison d'une interface peut consister en une combinaison quelconque de dispositifs, à la seule condition que la somme d'indices d'équivalence de la sonnerie de tous les dispositifs n'excède pas 5.



Pour assurer la sécurité, les utilisateurs doivent vérifier que la prise de terre du service d'électricité, les lignes téléphoniques et les conduites d'eau métalliques sont connectées ensemble. Les utilisateurs NE doivent PAS tenter d'établir ces connexions eux-mêmes, mais doivent contacter les services d'inspection d'installations électriques appropriés ou un électricien. Ceci peut être particulièrement important en régions rurales.

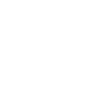

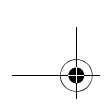

LifeBook A3000 Series Notebook - Section Eight

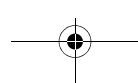
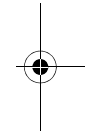
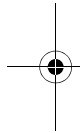

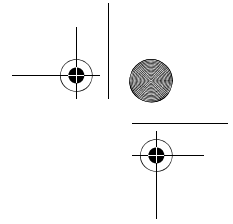
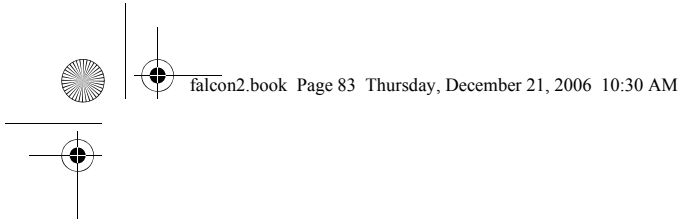

Appendix A

Integrated Wireless LAN User's Guide

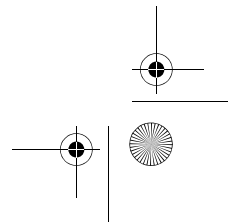
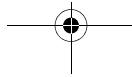
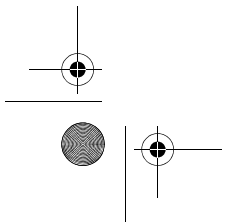
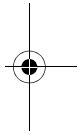
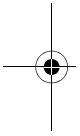

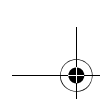

LifeBook A3000 Series Notebook - Appendix

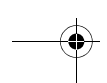
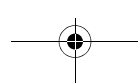
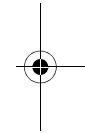
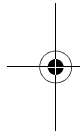

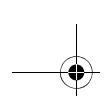

FC FCC REGULATORY INFORMATION

Please note the following regulatory information related to the wireless LAN device.

Regulatory Notes and Statements Wireless LAN, Health and Authorization for use

Radio frequency electromagnetic energy is emitted from Wireless LAN devices. The energy levels of these emissions, however, are far much less than the electromagnetic energy emissions from wireless devices such as mobile phones. Wireless LAN devices are safe for use by consumers because they operate within the guidelines found in radio frequency safety standards and recommendations. The use of Wireless LAN devices may be restricted in some situations or environments, such as:

- On board an airplane, or
- In an explosive environment, or
- In situations where the interference risk to other devices or services is perceived or identified as harmful.

In cases in which the policy regarding use of Wireless LAN devices in specific environments is not clear (e.g., airports, hospitals, chemical/oil/gas industrial plants, private buildings), obtain authorization to use these devices prior to operating the equipment.

Regulatory Information/Disclaimers

Installation and use of this Wireless LAN device must be in strict accordance with the instructions included in the user documentation provided with the product. Any changes or modifications made to this device that are not expressly approved by the manufacturer may void the user's authority to operate the equipment. The manufacturer is not responsible for any radio or television interference caused by unauthorized modification of this device, or the substitution or attachment of connecting cables and equipment other than those specified by the manufacturer. It is the responsibility of the user to correct any interference caused by such unauthorized modification, substitution or attachment. The manufacturer and its authorized resellers or distributors will assume no liability for any damage or violation of government regulations arising from failure to comply with these guidelines.

This device must not be co-located or operated in conjunction with any other antenna or transmitter.

For IEEE 802.11a Wireless LAN:

For operation within 5.15~5.25 GHz frequency range, it is restricted to indoor environments, and the antenna of this device must be integral.

Federal Communications Commission statement

This device complies with Part 15 of FCC Rules.

Operation is subject to the following two conditions: (1) This device may not cause interference, and, (2) This device must accept any interference, including interference that may cause undesired operation of this device.

FCC Interference Statement

This equipment has been tested and found to comply with the limits for a Class B digital device, pursuant to Part 15 of the FCC Rules. These limits are designed to provide reasonable protection against harmful interference in a residential installation. This equipment generates, uses, and can radiate radio frequency energy. If not installed and used in accordance with the instructions, it may cause harmful interference to radio communications. However, there is no guarantee that interference will not occur in a particular installation.

If this equipment does cause harmful interference to radio or television reception, which can be determined by turning the equipment off and on, the user is encouraged to try and correct the interference by one or more of the following measures:

1. Reorient or relocate the receiving antenna.
2. Increase the distance between the equipment and the receiver.
3. Connect the equipment to an outlet on a circuit different from the one the receiver is connected to.
4. Consult the dealer or an experienced radio/TV technician for help.

FCC Radio Frequency Exposure statement

This equipment complies with FCC radiation exposure limits set forth for an uncontrolled environment. This equipment should be installed and operated with a minimum distance of 20 centimeters between the Wireless LAN antenna (located on the top edge of the LCD screen) and your body. The Bluetooth antenna is located on the edge of the right palm rest and is exempt from minimum distance criteria due to its low power. The transmitters in this device must not be co-located or operated in conjunction with any other antenna or transmitter.

Export restrictions

This product or software contains encryption code which may not be exported or transferred from the US or Canada without an approved US Department of Commerce export license. This device complies with Part 15 of FCC Rules., as well as ICES 003 B / NMB 003 B. Operation is subject to the following two conditions: (1) this device may not cause harmful interference, and (2) this device must accept any interference received, including interference that may cause undesirable operation. Modifications not expressly authorized by Fujitsu Computer Systems Corporation may invalidate the user's right to operate this equipment.

Canadian Notice

The device for the 5150-5250 MHz band is only for indoor usage to reduce the potential for harmful interference to co-channel mobile satellite systems.

The maximum antenna gain of 6 dBi permitted (for devices in the 5250-5350 MHz and 5470-5725 MHz bands) to comply with the e.i.r.p. limit.

In addition, users are cautioned to take note that high power radars are allocated as primary users (meaning they have priority) of 5250-5350 MHz and 5650-5850 MHz and these radars could cause interference and/or damage to LE-LAN devices.

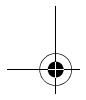
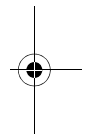
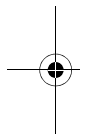

Before Using the Wireless LAN

This manual describes the procedures for properly setting up and configuring the optional integrated Wireless LAN Mini-PCI device (referred to as "WLAN device"). Before using the WLAN device, read this manual carefully to ensure its correct operation. Keep this manual in a safe place for future reference.

Wireless LAN Devices Covered by this Document

This document is applicable to systems containing an Atheros AR5006EXS (AR5BXB6) Mini-PCI wireless network card (802.11a+b/g).

Characteristics of the WLAN Device

- The WLAN device is a Mini-PCI card attached to the mainboard of the mobile computer.
- It is a dual-band radio that operates in two license-free RF bands, therefore eliminating the need to procure an FCC license to operate. It operates in the 2.4GHz Industrial, Scientific, and Medical (ISM) RF band and in the lower, middle, and upper bands of the 5GHz Unlicensed National Information Infrastructure (UNII) bands.
- The Atheros SuperAG WLAN is capable of three operating modes, IEEE802.11a, IEEE802.11b and IEEE802.11g, wireless LAN standards governed by the Institute of Electronics and Electrical Engineers.
- Encoding of data is modulated using Direct Sequence Spread Spectrum (DSSS) and Complementary Code Keying (CCK) when the WLAN device is operating in IEEE 802.11b mode and Orthogonal Frequency Division Multiplexing (OFDM) when operating in IEEE802.11a or IEEE802.11g mode.
- The WLAN device is Wi-Fi certified and operates at the maximum data transfer rate of 54 Mbps in IEEE802.11a or IEEE802.11g mode (108 Mbps maximum data rate with compatible access points) and 11 Mbps in IEEE802.11b mode.

- The WLAN device supports the following encryption methods - WEP, TKIP, and AES encryption.

WIRELESS LAN MODES USING THIS DEVICE

Ad Hoc Mode (See Figure A-1)

"Ad Hoc Mode" refers to a wireless network architecture where wireless network connectivity between multiple computers is established without a central wireless network device, typically known as Access Point(s). Connectivity is accomplished using only client devices in a peer-to-peer fashion. That is why Ad Hoc networks are also known as peer-to-peer networks. Ad Hoc networks are an easy and inexpensive method for establishing network connectivity between multiple computers.

Ad Hoc mode requires that the SSID (service set identifier), network authentication, and encryption key settings are identically configured on all computers in the Ad Hoc network.

Access Point (Infrastructure) Mode (See Figure A-2)

Infrastructure mode refers to a wireless network architecture in which devices communicate with wireless or wired network devices by communicating through an Access Point. In infrastructure mode, wireless devices can communicate with each other or with a wired network. Corporate wireless networks operate in infrastructure mode because they require access to the wired LAN in order to access computers, devices, and services such as file servers, printers, and databases.

How to Handle This Device

The WLAN device comes pre-installed in your mobile computer. Under normal circumstances, it should not be necessary for you to remove or reinstall it. The operating system that your mobile computer comes with has been pre-configured to support the WLAN device.

Figure A-1. Ad Hoc Mode Network

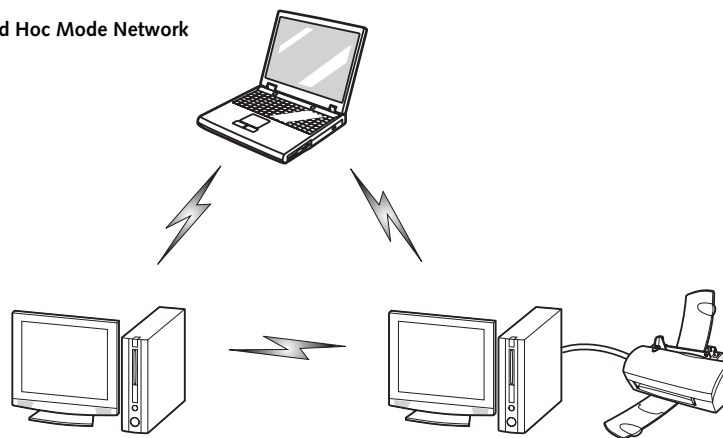

WIRELESS NETWORK CONSIDERATIONS

- The Atheros WLAN device supports IEEE802.11a/b/g and operates in the 2.4GHz ISM band and the 5 GHz UNII bands.
- Microwave ovens will interfere with the operation of WLAN device as microwave ovens operate in the same 2.4GHz frequency range that IEEE802.11b/g devices operate in. Interference by microwaves does not occur with IEEE802.11a radio which operates in the 5 GHz RF band.
- Wireless devices that transmit in the 2.4GHz frequency range may interfere with the operation of WLAN devices in IEEE802.11b/g modes. Symptoms of interference include reduced throughput, intermittent disconnects, and large amounts of frame errors. It is HIGHLY recommended that these interfering devices be powered off to ensure the proper operation of the WLAN device.

DEACTIVATING THE WLAN DEVICE

Deactivation of the WLAN device may be desired in certain circumstances (to extend battery life) or where certain environments require it (i.e. hospitals, clinics, airplanes, etc.). Fujitsu mobile computers employ two methods with which to deactivate the WLAN device:

- Using the Wireless On/Off Switch, or,
- In Windows, using the WLAN icon in the taskbar.

Deactivation using the Wireless On/Off Switch

The WLAN device can be deactivated quickly and efficiently by sliding the Wireless On/Off Switch to the Off position (to the left). (Figure A-3)

The wireless On/Off switch has no effect on non-Wireless LAN models.

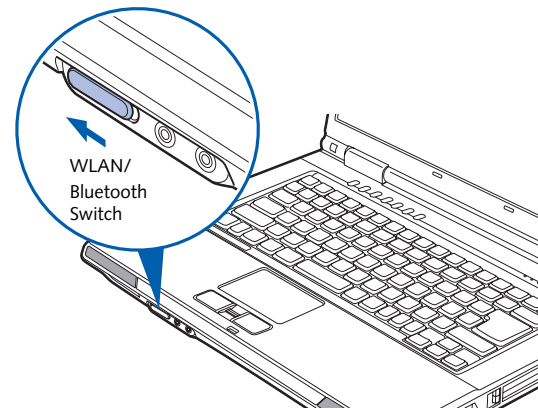

Figure A-3. Wireless LAN On/Off Switch Location

Deactivation using the icon in the taskbar

1. Right-click the WLAN icon in the taskbar at the bottom right of your screen.
2. Choose Disconnect from a network.

ACTIVATING THE WLAN DEVICE

Activation of the WLAN device can be accomplished using the same methods as the deactivation process

- Using the Wireless On/Off Switch
- In Windows, by right-clicking the WLAN icon then clicking "Connect to a network"

Figure A-2. Access Point (Infrastructure) Mode Network

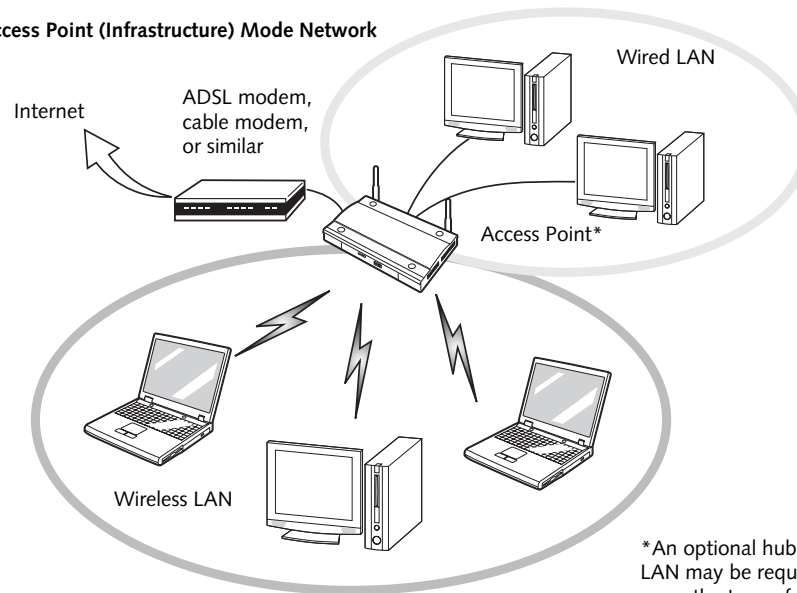

*An optional hub for a wired LAN may be required depending upon the type of access point used.

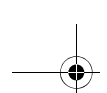

CONFIGURING THE WIRELESS LAN

The optional WLAN device can be configured to establish wireless network connectivity using the software that is built into Windows Vista. Support for most industry standard security solutions is contained in this software.

Pre-defined parameters will be required for this procedure. Please consult with your network administrator for these parameters:

1. Click the Start button, then select Control Panel.
2. If the Control Panel is not in Classic View, select Classic View from the left panel. Double-click the Network and Sharing Center icon.
3. Select "Manage wireless networks" from the left panel.
4. Click on the [Add] button.
5. Depending upon what type of connection you would like to make, make a selection. For an infrastructure network, select "Manually create a network profile. For ad hoc network, select "Create an ad hoc network".
6. Enter the required information. It may be necessary to consult with your network administrator for some of the information.
7. In the event you require assistance, go to the Network and Sharing Center window (Start -> Control Panel -> Network and Sharing Center), and type in relevant keywords in the Search box.

CONNECTING TO A NETWORK

After you have configured your computer, you can connect to an active network by performing the following steps:

1. Click on the WLAN icon in the system tray.
2. Select "connect to a network".
3. Select a network from the list that appears, and click the [Connect] button.



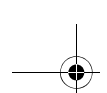

Troubleshooting the WLAN

TROUBLESHOOTING TABLE

Causes and countermeasures for troubles you may encounter while using your wireless LAN are described in the following table.

Problem	Possible Cause	Possible Solution
Unavailable network connection	Incorrect network name (SSID) or network key	<p>Ad hoc connection: verify that the network names (SSID's) and network keys (WEP) of all computers to be connected have been configured correctly. SSID's and WEP key values must be identical on each machine.</p> <p>Access Point (Infrastructure) connection: set the network name (SSID) and network key to the same values as those of the access point.</p> <p>Set the Network Authentication value identically to that of the Access Point. Please consult your network administrator for this value, if necessary.</p>
	Weak received signal strength and/or link quality	<p>Ad hoc connection: Retry connection after shortening the distance to the destination computer or removing any obstacles for better sight.</p> <p>Access Point (Infrastructure) connection: Retry connection after shortening the distance to the access point or removing any obstacles for better sight.</p>
	The WLAN device has been deactivated or disabled	Check if the wireless switch is turned ON. Also verify "Disable Radio" is not checked in "Network setting" window.
	The computer to be connected is turned off	Check if the computer to be connected is turned ON.
	RF interference from Access Points or other wireless networks	The use of identical or overlapping RF channels can cause interference with the operation of the WLAN device. Change the channel of your Access Point to a channel that does not overlap with the interfering device.
	Wireless network authentication has failed	Re-check your Network Authentication, Encryption, and Security settings. Incorrectly configured security settings such as an incorrectly typed WEP key, a misconfigured LEAP username, or an incorrectly chosen authentication method will cause the LAN device to associate but not authenticate to the wireless network.
	Incorrectly configured network settings	Recheck the configuration of your network settings.
	Incorrect IP address configuration	This only applies to networks using static IP addresses. Please contact your network administrator for the correct settings.

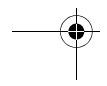
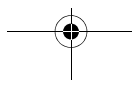
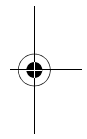
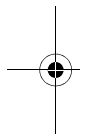

Wireless LAN Glossary

GLOSSARY

Ad Hoc Mode

Ad Hoc Mode refers to a wireless network architecture where wireless network connectivity between multiple computers is established without a central wireless network device, typically known as Access Points. Connectivity is accomplished using only client devices in a peer-to-peer fashion. For details, refer to "Ad hoc connection" on page 86.

Channel

Range of narrow-band frequencies used by the WLAN device to transmit data. IEEE802.11b/g - 11 channels, 22 MHz wide channels.

DHCP (Dynamic Host Configuration Protocol)

A protocol that provides a means to dynamically allocate IP addresses to computers on a local area network.

DNS (Domain Name System)

A data query service that provides a mechanism with which to translate host names into Internet addresses.

IEEE802.11a

Wireless LAN standard that supports a maximum data rate of 54 Mbps. 802.11a devices operate in the 5 GHz lower and middle UNII bands.

IEEE802.11b

Wireless LAN standard that supports a maximum data rate of 11 Mbps. 802.11b devices operate in the 2.4 GHz ISM band.

Access point

Wireless network device used to bridge wireless and wired network traffic.

IP address

The logical 32-bit host address defined by the Internet Protocol that uniquely identifies a computer on a network. The IP address is usually expressed in dotted decimal notation.

LAN (Local Area Network)

A LAN or Local Area Network is a computer network (or data communications network) which is confined to a limited geographical area.

MAC address (Media Access Control Address)

A MAC address (also called an Ethernet address or IEEE MAC address) is the 48-bit address (typically written as twelve hexadecimal digits, 0 through 9 and A through F, or as six hexadecimal numbers separated by periods or colons, e.g., 0080002012ef, 0:80:0:2:20:ef) which uniquely identifies a computer that has an Ethernet interface.

MTU (Maximum Transmission Unit)

The maximum size of data which can be transmitted at one time in networks including the Internet. In an environment whose maximum size of data is too large to correctly receive data, normal communications can be restored by setting the size of MTU to a smaller value.

Network key

Data that is used for encrypting data in data communication. The personal computer uses the same network key both for data encryption and decryption, therefore, it is necessary to set the same network key as the other side of communication.

Network name (SSID: Service Set Identifier)

When a wireless LAN network is configured, grouping is performed to avoid interference or data theft. This grouping is performed with "Network name (SSID)". In order to improve security, the network key is set allowing no communication unless "Network name (SSID)" coincides with the network key.

Open system authentication

Null authentication method specified in the 802.11 standard that performs no authentication checks on a wireless client before allowing it to associate.

PPPoE (Point to Point Protocol over Ethernet)

A method of allowing the authentication protocol adopted in telephone line connection (PPP) to be used over an Ethernet.

Protocol

A procedure or rule of delivering data among computers. Ordered data communication is allowed by making all conditions required for communication including the method of data transmission/reception and actions upon communication errors into procedures.



Shared key authentication

802.11 network authentication method in which the AP sends the client device a challenge text packet that the client must then encrypt with the correct WEP key and return to the AP. If the client has the wrong key or no key, authentication will fail and the client will not be allowed to associate with the AP. Shared key authentication is not considered secure, because a hacker who detects both the clear-text challenge and the same challenge encrypted with a WEP key can decipher the WEP key.

SSID (Service Set Identifier)

Service Set Identifier, a 32-character unique identifier attached to the header of packets sent over a WLAN that acts as a password when a mobile device tries to connect to the BSS. The SSID differentiates one WLAN from another, so all access points and all devices attempting to connect to a specific WLAN must use the same SSID. A device will not be permitted to join the BSS unless it can provide the unique SSID. Because the SSID is broadcast in plain text, it does not supply any security to the network.

Subnet mask

TCP/IP network is controlled by being divided into multiple smaller networks (subnets). IP address consists of the subnet address and the address of each computer. Subnet mask defines how many bits of IP address comprise the subnet address. The same value shall be set among computers communicating with each other.

TCP/IP (Transmission Control Protocol/Internet Protocol)

A standard protocol of the Internet.

Wi-Fi

Wi-Fi, or Wireless Fidelity, is a set of standards for wireless local area networks (WLAN) based on the IEEE 802.11 specifications. Certified products can use the official Wi-Fi logo, which indicates that the product is interoperable with any other product also showing that logo.

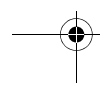
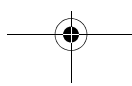
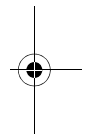
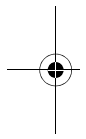

Specifications

Item	Specifications
Type of network	Atheros Super AG (802.11a+b/g) WLAN device conforms to IEEE 802.11a and 802.11b/g (Wi-Fi based)*
Transfer rate	(Automatic switching) IEEE 802.11a/g: 54 Mbps maximum data rate (108 Mbps maximum data rate with compatible access points) IEEE 802.11b: 11 Mbps maximum data rate
Active frequency	802.11b/g: 2400~2473 MHz 802.11a: 5050 ~ 5850 MHz
Number of channels	802.11a: 8 independent channels 802.11b/g: 11 channels, 3 non-overlapping channels
Typical operating distances**	802.11a: 40 ft. (12 m) @ 54 Mbps; 300 ft. (91 m) @ 6 Mbps 802.11b: 100 ft. (30 m) @ 11 Mbps; 300 ft. (91 m) @ 1 Mbps 802.11g: 100 ft. (30 m) @ 54 Mbps; 300 ft. (91 m) @ 1 Mbps
Security	Encryption Types - WEP, TKIP, AES*** WPA 1.0 compliant Encryption Key lengths Supported: 64 bits, 128 bits, and 152 bits (Atheros module using AES encryption only) 802.1x/EAP CCX 1.0 compliant
Maximum recommended number of computers to be connected over wireless LAN (during ad hoc connection)	10 units or less ****

* "Wi-Fi based" indicates that the interconnectivity test of the organization which guarantees the interconnectivity of wireless LAN (Wi-Fi Alliance) has been passed.

** The communication ranges shown above will increase or decrease depending on factors such as number of walls, reflective material, or interference from external RF sources.

*** Encryption with network key (WEP) is performed using the above number of bits, however, users can set 40 bits 104 bits after subtracting the fixed length of 24 bits.

**** Depending on practical environments, the allowable number of computers to be connected may be decreased.

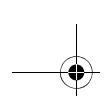

Using the Bluetooth Device

The Integrated Bluetooth module (EYTF3CSFT) is an optional device available for Fujitsu mobile computers.

WHAT IS BLUETOOTH

Bluetooth technology is designed as a short-range wireless link between mobile devices, such as laptop computers, phones, printers, and cameras. Bluetooth technology is used to create Personal Area Networks (PANs) between devices in short-range of each other.

The Wireless LAN/Bluetooth On/Off Switch will power off both the optional wireless LAN and Bluetooth devices at the same time. To enable or disable either one of the devices individually, perform the following steps:



1. Slide the Wireless LAN/Bluetooth on/off switch to On position.
 2. In the Control Panel, double-click the Fujitsu Radio Control icon.
 3. In the window that appears, click the button associated with Bluetooth and/or Wireless LAN Status to enable or disable the individual devices.
 4. Click [OK].
-

WHERE TO FIND INFORMATION ABOUT BLUETOOTH

The Bluetooth module contains a robust Help user's guide to assist you in learning about operation of the Bluetooth device.

To access the Help file, click [Start] -> All Programs, and click on Toshiba. Select Bluetooth, then select User's Guide.

For additional information about Bluetooth Technology, visit the Bluetooth Website at: www.bluetooth.com.

FCC Radiation Exposure Statement

This equipment complies with FCC radiation exposure limits set forth for an uncontrolled environment.

The transmitters in this device must not be co-located or operated in conjunction with any other antenna or transmitter.

Canadian Notice

To prevent radio interference to the licensed service, this device is intended to be operated indoors and away from windows to provide maximum shielding. Equipment (or its transmit antenna) that is installed outdoors is subject to licensing.

Warranty

Users are not authorized to modify this product. Any modifications invalidate the warranty.

This equipment may not be modified, altered, or changed in any way without signed written permission from Fujitsu. Unauthorized modification will void the equipment authorization from the FCC and Industry Canada and the warranty.





LifeBook A3000 Series Notebook - Appendix

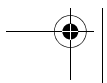
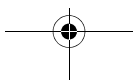
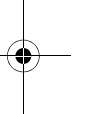
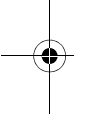

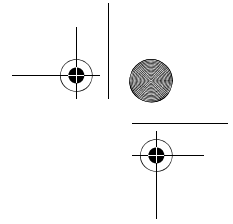
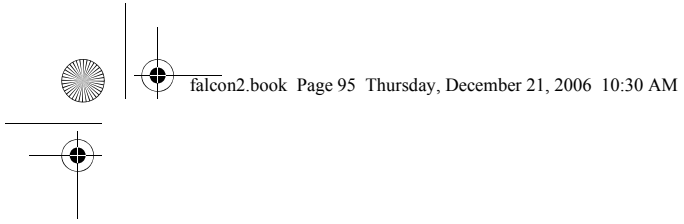

Appendix B

Using the Fingerprint Sensor

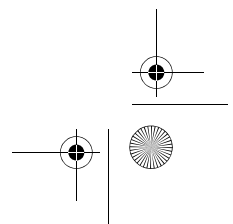
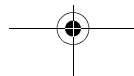
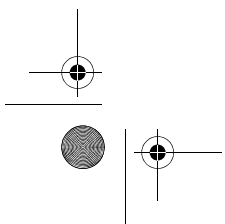
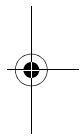
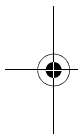

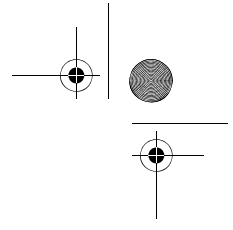
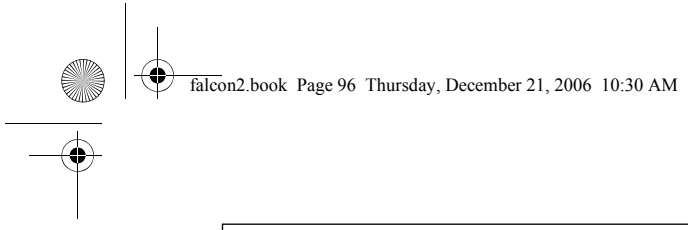

LifeBook A3000 Series Notebook

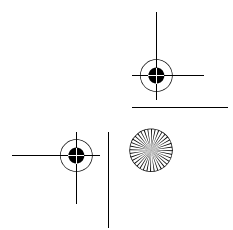
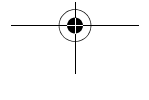
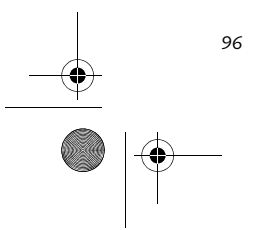
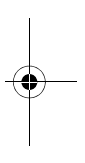
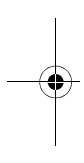

Fingerprint Sensor Device

INTRODUCING THE FINGERPRINT SENSOR DEVICE

Your system has a fingerprint sensor device below the Touchpad, between the left and right buttons. It also serves as a scrolling sensor. (Figure B-1)

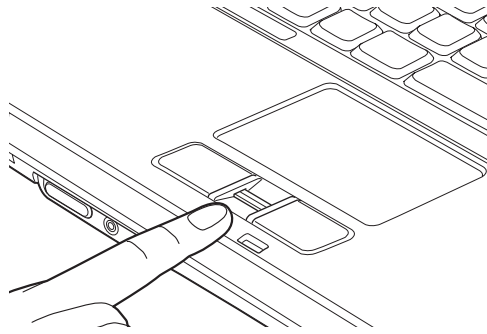

Figure B-1 Fingerprint sensor



The fingerprint sensor can be used for scrolling. Simply move your fingerprint over the sensor the same as you would use a scrolling sensor.

With a fingerprint sensor, you can avoid having to enter a username and password every time you want to:

- Log onto Windows
- Resume from standby mode
- Cancel a password-protected screen saver
- Log into websites that require a username and password

After you have “enrolled” - or registered - your fingerprint, you can simply swipe your fingertip over the sensor for the system recognize you.

The fingerprint sensor uses Softex OmniPass which provides password management capabilities to Microsoft Windows operating systems. OmniPass enables you to use a “master password” for all Windows, applications, and on-line passwords.

OmniPass requires users to authenticate themselves using the fingerprint sensor before granting access to the Windows desktop. This device results in a secure authentication system for restricting access to your computer, applications, websites, and other password-protected resources.

OmniPass presents a convenient graphical user interface, through which you can securely manage passwords, users, and multiple identities for each user.

GETTING STARTED

This section guides you through the preparation of your system for the OmniPass fingerprint recognition application. You will be led through the OmniPass installation process. You will also be led through the procedure of enrolling your first user into OmniPass.

INSTALLING OMNIPASS

If OmniPass has already been installed on your system, skip this section and go directly to “User Enrollment” on page 98. You can determine whether OmniPass has already been installed by checking to see if the following are present:

- The presence of the gold key-shaped OmniPass icon in the notification area at the bottom right of the screen.
- The presence of the Softex program group in the Programs group of the Start menu

System Requirements

The OmniPass application requires space on your hard drive; it also requires specific Operating Systems (OS's). The minimum requirements are as follows:

- Windows XP Home Edition or Windows XP Professional operating system
- At least 35 MB available hard disk space

Installing the OmniPass Application

If OmniPass is already installed on your system, go to “User Enrollment” on page 98. Otherwise continue with this section on software installation.



For installation, OmniPass requires that the user installing OmniPass have administrative privileges to the system. If your current user does not have administrative privileges, log out and then log in with an administrator user before proceeding with OmniPass installation.

To install OmniPass on your system you must:

1. Insert the installation media for the OmniPass application into the appropriate drive. If you are installing from CD-ROM or DVD-ROM, you must find and launch the OmniPass installation program (setup.exe) from the media.
2. Follow the directions provided in the OmniPass installation program. Specify a location to which you would like OmniPass installed. It is recommended that you NOT install OmniPass in the root directory (e.g. C:\).
3. Once OmniPass has completed installation you will be prompted to restart your system. Once your system has rebooted you will be able to use OmniPass. If you choose not to restart immediately after installation, OmniPass will not be available for use until the next reboot.

The installation program automatically places an icon (Softex OmniPass) in the Windows Control Panel as well as a golden key shaped icon in the taskbar.

Verifying Information about OmniPass

After you have completed installing OmniPass and restarted your system, you may wish to check the version of OmniPass on your system.

To check the version information of OmniPass:

1. From the Windows Desktop, double-click the key-shaped OmniPass icon in the taskbar (usually located in the lower right corner of the screen), or
Click the **Start** button, select **Settings**, and click **Control Panel** (if you are using Windows XP you will see the Control Panel directly in the Start menu; click it, then click **Switch to Classic View**). Double-click **Softex OmniPass** in the Control Panel, and the OmniPass Control Center will appear. If it does not appear, then the program is not properly installed, or
Click the **Start** button, select **Programs**, and from the submenu select the **Softex** program group, from that submenu click **OmniPass Control Center**.
2. Select the **About** tab at the top of the OmniPass Control Panel. The About tab window appears with version information about OmniPass.

Uninstalling OmniPass



For uninstallation, OmniPass requires that the user uninstalling OmniPass have administrative privileges to the system. If your current user does not have administrative privileges, log out and then log in with an administrator user before proceeding with OmniPass uninstallation.

To remove the OmniPass application from your system:

1. Click **Start** on the Windows taskbar. Select **Settings**, and then **Control Panel**.
2. Double-click **Add/Remove Programs**.
3. Select **OmniPass**, and then click **Change/Remove**.
4. Follow the directions to uninstall the OmniPass application.
5. Once OmniPass has finished uninstalling, reboot your system when prompted.

USER ENROLLMENT

Before you can use any OmniPass features you must first enroll a user into OmniPass.

Master Password Concept

Computer resources are often protected with passwords. Whether you are logging into your computer, accessing your email, e-banking, paying bills online, or accessing

network resources, you often have to supply credentials to gain access. This can result in dozens of sets of credentials that you have to remember.

During OmniPass user enrollment a "master password" is created for the enrolled user. This master password "replaces" all other passwords for sites you register with OmniPass.

Example: A user, John, installs OmniPass on his system (his home computer) and enrolls an OmniPass user with username "John_01" and password "freq14". He then goes to his webmail site to log onto his account. He inputs his webmail credentials as usual (username "John_02" and password "lifebook"), but instead of clicking [Submit], he directs OmniPass to **Remember Password**. Now whenever he returns to that site, OmniPass will prompt him to supply access credentials.

John enters his OmniPass user credentials ("John_01" and "freq14") in the OmniPass authentication prompt, and he is allowed into his webmail account. He can do this with as many websites or password protected resources he likes, and he will gain access to all those sites with his OmniPass user credentials ("John_01" and "freq14"). This is assuming he is accessing those sites with the system onto which he enrolled his OmniPass user. OmniPass does not actually change the credentials of the password protected resource. If John were to go to an Internet cafe to access his webmail, he would need to enter his original webmail credentials ("John_02" and "lifebook") to gain access. If he attempts his OmniPass user credentials on a system other than where he enrolled that OmniPass user, he will not gain access.



The enrollment procedure assumes you have no hardware authentication devices or alternate storage locations that you wish to integrate with OmniPass. If you desire such functionality, consult the appropriate sections of this document.

Basic Enrollment

The Enrollment Wizard will guide you through the process of enrolling a user. Unless you specified otherwise, after OmniPass installation the Enrollment Wizard will launch on Windows login. If you do not see the Enrollment Wizard, you can bring it up by clicking **Start** on the Windows taskbar; select **Programs**; select **Softex**; click **OmniPass Enrollment Wizard**.

1. Click **Enroll** to proceed to username and password verification. By default, the OmniPass Enrollment Wizard enters the credentials of the currently logged in Windows user.
2. Enter the password you use to log in to Windows. This will become the "master password" for this OmniPass user. In most cases, the **Domain:** value

Using the Fingerprint Sensor

- will be your Windows computer name. In a corporate environment, or when accessing corporate resources, the **Domain:** may not be your Windows computer name. Click [Next] to continue.
- In this step OmniPass captures your fingerprint. Refer to “Enrolling a Fingerprint” on page 99 for additional information.
 - Next, choose how OmniPass notifies you of various events. We recommend you keep **Taskbar Tips on Beginner mode taskbar tips** and **Audio Tips** on at least **Prompt with system beeps only** until you get accustomed to how OmniPass operates. Click [Next] to proceed with user enrollment. You will then see a Congratulations screen indicating your completion of user enrollment.
 - Click [Done] to exit the OmniPass Enrollment Wizard. You will be asked if you’d like to log in to OmniPass with your newly enrolled user; click [Yes].

Enrolling a Fingerprint

Enrolling a fingerprint will increase the security of your system and streamline the authentication procedure.

You enroll fingerprints in the OmniPass Control Center. With an OmniPass user logged in, double-click the notification area OmniPass icon. Select the **User Settings** tab and click **Enrollment** under the **User Settings** area. Click **Enroll Authentication Device** and authenticate at the authentication prompt to start device enrollment.

- During initial user enrollment, you will be prompted to select the finger you wish to enroll. Fingers that have already been enrolled will be marked by a green check. The finger you select to enroll at this time will be marked by a red arrow. OmniPass will allow you to re-enroll a finger. If you choose a finger that has already been enrolled and continue enrollment, OmniPass will enroll the fingerprint, overwriting the old fingerprint. Select a finger to enroll and click [Next].
- It is now time for OmniPass to capture your selected fingerprint. It may take a several capture attempts before OmniPass acquires your fingerprint. Should OmniPass fail to acquire your fingerprint, or if the capture screen times out, click [Back] to restart the fingerprint enrollment process.

Your system has a “swipe” fingerprint sensor. A swipe sensor is small and resembles a skinny elongated rectangle. To capture a fingerprint, gently swipe or pull your fingertip over the sensor (starting at the second knuckle) **towards yourself** (Figure B-2). Swiping too fast or too slow will result in a failed capture. The **Choose Finger** screen has a [Practice] button; click it to practice capturing your fingerprint. When you are comfortable with how

your fingerprint is captured, proceed to enroll a finger.

- Once OmniPass has successfully acquired the fingerprint, the **Verify Fingerprint** screen will automatically appear. To verify your enrolled fingerprint, place your fingertip on the sensor and hold it there as if you were having a fingerprint captured. Successful fingerprint verification will show a green fingerprint in the capture window and the text **Verification Successful** under the capture window.

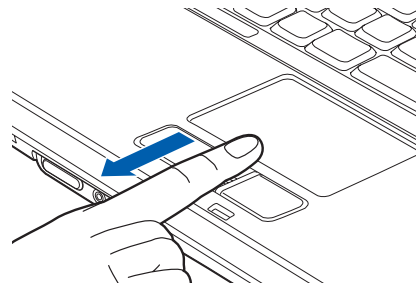

Figure B-2 Swiping a finger

USING OMNIPASS

You are now ready to begin using OmniPass. Used regularly, OmniPass will streamline your authentications.

Password Replacement

You will often use the password replacement function. When you go to a restricted access website (e.g., your bank, your web-based email, online auction or payment sites), you are always prompted to enter your login credentials. OmniPass can detect these prompts and you can teach OmniPass your login credentials. The next time you go to that website, you can authenticate with your fingerprint to gain access.

OmniPass Authentication Toolbar

After installing OmniPass and restarting, you will notice a dialog you have not seen before at Windows Logon. This is the OmniPass Authentication Toolbar, and it is displayed whenever the OmniPass authentication system is invoked. The OmniPass authentication system may be invoked frequently: during Windows Logon, during OmniPass Logon, when unlocking your workstation, when resuming from standby or hibernate, when unlocking a password-enabled screensaver, during password replacement for remembered site or application logins, and more. When you see this toolbar, OmniPass is prompting you to authenticate.

The **Logon Authentication** window indicates what OmniPass-restricted function you are attempting. The icons in the lower left (fingerprint and key) show what authentication methods are available to you. Selected authentication methods are highlighted while unselected methods are not. When you click the icon for an unselected authentication method, the authentication prompt associated with that method is displayed.

When prompted to authenticate, you must supply the appropriate credentials: an enrolled finger for the fingerprint capture window or your master password for the master password prompt (the key icon).

Remembering a Password

OmniPass can remember any application, GUI, or password protected resource that has a password prompt.

Using the following procedure, you can store a set of credentials into OmniPass. These credentials will then be linked to your “master password” or fingerprint.

Go to a site that requires a login (username and password), but *do not log in yet*. At the site login prompt, enter your username and password in the prompted fields, but *do not enter the site* (do not hit [Enter], [Submit], [OK], or Login). Right-click the OmniPass notification area icon and select **Remember Password** from the submenu. The Windows arrow cursor will change to a golden key OmniPass cursor. Click this OmniPass cursor in the login prompt area, but do not click the [Login] or [Submit] button.

Associating a Friendly Name

After clicking the OmniPass key cursor near the login prompt, OmniPass will prompt you to enter a “friendly name” for this site. You should enter something that reminds you of the website, the company, or the service you are logging into. In its secure database, OmniPass associates this friendly name with this website.

Additional Settings for Remembering a Site

When OmniPass prompts you to enter a “friendly name” you also have the opportunity to set how OmniPass authenticates you to this site. There are three effective settings for how OmniPass handles a remembered site.

The default setting is **Automatically click the “OK” or “Submit” button for this password protected site once the user is authenticated**. With this setting, each time you navigate to this site OmniPass will prompt you for your master password or fingerprint authentication device. Once you have authenticated with OmniPass, you will automatically be logged into the site.

Less secure is the option to **Automatically enter this password protected site when it is activated. Do not prompt for authentication**. Check the upper box to get this setting, and each time you navigate to this site OmniPass will log you into the site without prompting you to authenticate.



This setting is more convenient in that whenever you go to a site remembered with this setting, you will bypass any authentication procedure and gain instant access to the site. But should you leave your system unattended with your OmniPass user logged in, anyone using your system can browse to your password protected sites and gain automatic access.

If you uncheck both boxes in **Settings for this Password Site**, OmniPass will prompt you for your master password or fingerprint authentication device. Once you have authenticated with OmniPass your credentials will be filled in to the site login prompt, but you will have to click the website [OK], [Submit], or [Login] button to gain access to the site.

Click **Finish** to complete the remember password procedure. The site location, the credentials to access the site, and the OmniPass authentication settings for the site are now stored in the OmniPass secure database. The OmniPass authentication settings (**Settings for this Password Site**) can always be changed in **Vault Management**.

Logging in to a Remembered Site

Whether or not OmniPass prompts you to authenticate when you return to a remembered site is determined by **Settings for this Password Site** and can be changed in **Vault Management**.

The following cases are applicable to using OmniPass to login to: Windows, remembered websites, and all other password protected resources.

With Master Password

Once you return to a site you have remembered with OmniPass, you may be presented with a master password prompt. Enter your master password and you will be allowed into the site.

Logging into Windows with a Fingerprint Device

When logging into Windows with a fingerprint device, the fingerprint capture window will now appear next to the Windows Login screen. Place your enrolled fingertip on the sensor to authenticate. You will be simultaneously logged into Windows and OmniPass. The capture window will also appear if you have used **Ctrl-Alt-Del** to lock a system, and the fingerprint device can be used to log back in as stated above.



If a machine is locked and OmniPass detects a different user logging back in with a fingerprint, the first user will be logged out and the second user logged in.

Using the Fingerprint Sensor

In Windows XP, your login options must be set either for classic login, or for fast user switching and logon screen to be enabled to use your fingerprint to log on to Windows. To change this go to **Control Panel**, select **User Accounts** and then click **Change the way users log on or off**. If your Windows screensaver is password protected, the fingerprint capture window will now appear next to screensaver password dialog during resume. You can authenticate to your screensaver password prompt with your enrolled finger.

Password Management

OmniPass provides an interface that lets you manage your passwords. To access it, double-click the OmniPass key in the notification area. Click **Vault Management**; you will be prompted to authenticate. Once you gain access to **Vault Management**, click **Manage Passwords** under **Vault Settings**. You will see the **Manage Passwords** interface, with a list of friendly names.

You can view the credentials stored for any remembered website by highlighting the desired resource under **Password Protected Dialog** and clicking **Unmask Values**. Should a password be reset, or an account expire, you can remove stored credentials from OmniPass. Highlight the desired resource under **Password Protected Dialog** and click **Delete Page**. You will be prompted to confirm the password deletion.

The two check boxes in **Manage Passwords** govern whether OmniPass prompts you to authenticate or directly logs you into the remembered site.

OmniPass will overwrite an old set of credentials for a website if you attempt to use **Remember Password** on an already remembered site.

The exception to the above rule is the resetting of your Windows password. If your password is reset in Windows, then the next time you login to Windows, OmniPass will detect the password change and prompt you to "Update" or "Reconfirm" your password with OmniPass. Enter your new Windows password in the prompt(s) and click **OK** and your OmniPass "master password" will still be your Windows password.

OmniPass User Identities

Identities allow OmniPass users to have multiple accounts to the same site (e.g., *bob@biblmail.com* and *boballen@biblmail.com*). If OmniPass did not provide you identities, you would be limited to remembering one account per site.

To create and manage identities, double-click the OmniPass key in the notification area. Click **Vault Management**; OmniPass will prompt you to authenticate. Once you gain access to **Vault Management**, click **Manage Identities** under **Vault Settings**. You can only manage the identities of the currently logged in OmniPass user

To add a new identity, click **New Identity** or double-click **Click here to add a new identity**. Name the new identity and click **[OK]**, then click **[Apply]**. You can now switch to the new identity and start remembering passwords.

To delete an identity, highlight the identity you want to delete and click **[Delete Identity]**, then click **[Apply]**.



When you delete an identity, all of its associated remembered sites and password protected dialogs are lost.

To set the default identity, highlight the identity you want as default and click **[Set as Default]**; click **[Apply]** to ensure the settings are saved. If you log in to OmniPass with a fingerprint device, you will automatically be logged in to the default identity for that OmniPass user. You can choose the identity with which you are logging in if you login using "master password".

Choosing User Identity during Login

To choose your identity during login, type your username in the **User Name:** field. Press **[Tab]** and see that the **Domain:** field self-populates. Click the **Password:** field to bring the cursor to it, and you will see the pull-down menu in the **Identity:** field. Select the identity you wish to login as and then click **OK** to login.

Switch User Identity

To switch identities at any time, right-click the OmniPass notification area icon and click **Switch User Identity** from the submenu. The **Switch Identity** dialog will appear. Select the desired identity then click **OK**.

Identities and Password Management

On the **Manage Passwords** interface of the **Vault Management** tab of the OmniPass Control Center, there is a pull-down selection box labeled, **Identity**. This field lets you choose which identity you are managing passwords for. When you select an identity here, only those password protected dialogs that are associated with that identity are shown. You can perform all the functions explained in "Password Management" on page 101.

CONFIGURING OMNIPASS

This section gives an overview of both the **Export/Import** function and the OmniPass Control Center.

Exporting and Importing Users

Using the OmniPass Control Center, you can export and import users in and out of OmniPass. The export process backs up all remembered sites, credentials, and any enrolled fingerprints for an OmniPass user. All OmniPass data for a user is backed up to a single encrypted database file. During the import process, the Windows login of the exported user is required. If the proper credentials cannot be supplied, the user profile will not be imported.



- You should periodically export your user profile and store it in a safe place. If anything happens to your system, you can import your OmniPass profile to a new system and have all your remembered settings and fingerprints instantly.
- You don't forget the Windows login credentials when exporting. When you examine the importation, you are prompted for authentication. The credentials that will allow a user profile to be imported are the Windows login credentials of the exported user. They are the credentials that had to be submitted when the user profile was exported. You will need User Name, Password, and Domain.

Exporting an OmniPass User Profile

To export a user, open the OmniPass Control Center, and click **Import/Export User** under **Manage Users**.

Click **Exports an OmniPass user profile**. OmniPass will prompt you to authenticate. Upon successfully authentication, you must name the OmniPass user profile and decide where to save it. An .opi file is generated, and you should store a copy of it in a safe place.

This .opi file contains all your user specific OmniPass data, and it is both encrypted and password protected. This user profile does NOT contain any of your encrypted data files.

Importing an OmniPass User Profile



You cannot import a user into OmniPass if there already is a user with the same name enrolled in OmniPass.

To import an OmniPass user open the OmniPass Control Center, and click **Import/Export User** under **Manage Users**. Click **Imports a new user into OmniPass** and then select **OmniPass Import/Export File (*.opi)** and click **Next**. OmniPass will then prompt you to browse for the file you had previously exported (.opi file). When you select the .opi file for importation, OmniPass will prompt you for authentication. The credentials that will allow a user profile to be imported are the Windows login credentials of the exported user. They are the credentials that had to be submitted when the user profile was exported. You will need **User Name**, **Password**, and **Domain**. If you don't remember the value for **Domain**, in a PC or SOHO environment **Domain** should be your computer name.

OmniPass will notify you if the user was successfully imported.

Things to Know Regarding Import/Export

- Assume you export a local Windows User profile from OmniPass. You want to import that profile to another machine that has OmniPass. Before you can import the profile, a Windows user with the same login credentials must be created on the machine importing the profile.

Example: I have a Windows user with the username "Tom" and the password "Sunshine" on my system. I have enrolled Tom into OmniPass and remembered passwords. I want to take all my passwords to new system. I export Tom's OmniPass user profile. I go to my new system and using the Control Panel I create a user with the username "Tom" and the password "Sunshine". I can now successfully import the OmniPass user data to the new system.

- If you export an OmniPass-only user, you can import that user to any computer running OmniPass, provided that a user with that name is not already enrolled in OmniPass.
- If you attempt to import a user profile who has the same name as a user already enrolled in OmniPass, the OmniPass import function will fail.

OMNIPASS CONTROL CENTER

This section will serve to explain functions within the OmniPass Control Center that weren't explained earlier.

You can access the OmniPass Control Center any of three ways:

- Double-click the golden OmniPass key shaped icon in the Windows taskbar (typically in the lower-right corner of the desktop)
- Click the **Start** button; select the **Programs** group; select the **Softex** program group; and click the **OmniPass Control Center** selection.
- Open the Windows **Control Panel** (accessible via **Start** button --> **Settings** --> **Control Panel**) and double-click the **Softex OmniPass** icon.

User Management

The User Management tab has two major interfaces: **Add/Remove User** and **Import/Export User**. Import/Export User functionality is documented in "Exporting and Importing Users" on page 101. Add/Remove User functionality is straightforward.

If you click **Adds a new user to OmniPass** you will start the OmniPass Enrollment Wizard. The Enrollment Wizard is documented in "User Enrollment" on page 98.

If you click **Removes a user from OmniPass**, OmniPass will prompt you to authenticate. Authenticate with the credentials (or enrolled fingerprint) of the user you wish to remove. OmniPass will prompt you to confirm user removal. Click **OK** to complete user removal.



Removing a user will automatically destroy all OmniPass data associated with that user. All identities and credentials associated with the user will be lost.

If you are sure about removing the user, we recommend you export the user profile.

User Settings

The User Settings tab has four interfaces: **Audio Settings**, **Taskbar Tips**, and **Enrollment**. User settings allow users to customize OmniPass to suit their individual preferences. Under **User Settings** (**Audio Settings** and **Taskbar Tips**) you can set how OmniPass notifies the user of OmniPass events (e.g., successful login, access denied, etc.). The details of each setting under the **Audio Settings** and **Taskbar Tips** interfaces are self-explanatory.

The **Enrollment** interface allows you to enroll fingerprints. For the procedure to enroll and authentication device refer to *Chapter 2.3*. To enroll additional fingerprints, click **Enroll Authentication Device**, and authenticate with OmniPass. Select the fingerprint recognition device in the **Select Authentication Device** screen (it should already be marked by a green check if you have a finger enrolled) and click **Next**.

System Settings

The OmniPass **Startup Options** interface can be found in the System Settings tab. With these options you can specify how your OmniPass Logon is tied to your Windows Logon.

The first option, **Automatically log on to OmniPass as the current user**, will do just as it says; during Windows login, you will be logged on to OmniPass using your Windows login credentials. If the user logging into Windows was never enrolled into OmniPass, upon login no one will be logged on to OmniPass. This setting is appropriate for an office setting or any setting where users must enter a username and password to log into a computer. This is the default setting.

With the second option, **Manually log on to OmniPass at startup**, OmniPass will prompt you to login once you have logged on to Windows.

With the third option, **Do not log on to OmniPass at startup**, OmniPass will not prompt for a user to be logged on.

You can manually log on to OmniPass by right-clicking the OmniPass taskbar icon and clicking **Log in User** from the right-click menu.

TROUBLESHOOTING

You cannot use OmniPass to create Windows users. You must first create the Windows user, and you will need administrative privileges to do that. Once the Windows user is created, you can add that user to OmniPass using the same username and password.

Cannot add Windows users to OmniPass

If you experience difficulties adding a Windows user to OmniPass, you may need to adjust your local security settings. You can do this by going to **Start**, **Control Panel**, **Administrative Tools**, and **Local Security Settings**. Expand **Local Policies**, expand **Security Options**, and double-click **Network Access: Sharing and Security Model for Local Accounts**. The correct setting should be *Classic - Local Users Authenticate as Themselves*.

Cannot add a User with a Blank Password to OmniPass

If you experience difficulties adding a user with a blank password to OmniPass, you may need to adjust your local security settings. First attempt the procedure explained in the *Cannot add Windows user to OmniPass* section. If the difficulties persist, then try the following procedure.

Click **Start**, **Control Panel**, **Administrative Tools**, and **Local Security Settings**. Expand **Local Policies**, expand **Security Options**, and double-click **Accounts: Limit local account use of blank passwords to console login only**. This setting should be set to **Disabled**.

Dialog appears after OmniPass authentication during Windows Logon

After installing OmniPass on your system, you can choose to logon to Windows using OmniPass. You authenticate with OmniPass (via master password, or an enrolled security device) and OmniPass logs you into Windows. You may, during this OmniPass authentication, see a **Login Error** dialog box.

This dialog box occurs when OmniPass was unable to log you into Windows with the credentials supplied (username and password). This could happen for any of the following reasons:

- Your Windows password has changed
- Your Windows account has been disabled

If you have difficulties due to the first reason, you will need to update OmniPass with the changed Windows account password. Click **Update Password**. You'll be prompted with a dialog to reconfirm your password.

Enter the new password to your Windows user account and click **OK**. If the error persists, then it is unlikely the problem is due to your Windows user account password changing.

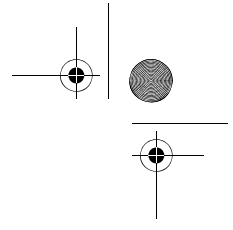
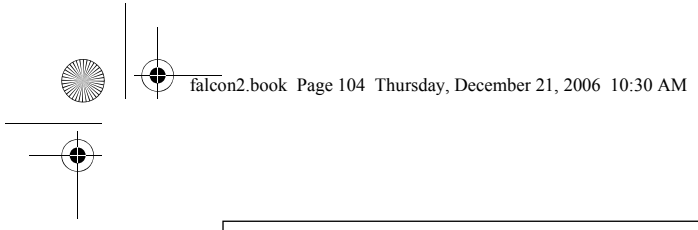

LifeBook A3000 Series Notebook

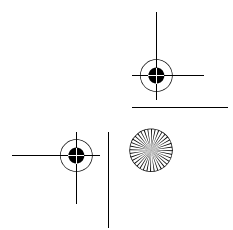
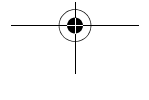
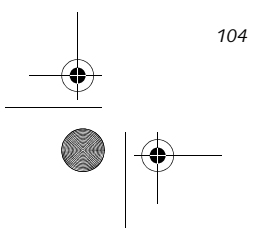
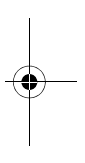
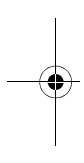

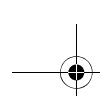

Index

A

AC	
adapter	23
plug adapters	64
Anti-theft lock slot	9
Application Panel	19
Auto/Airline Adapter	23
Automatically Downloading Driver Updates	59

B

Battery	31
alarm	31
bay	10
care	64
charging indicator	11
cold-swapping	32
conserving power	27
dead	51
faulty	51
increasing life	64
level indicators	11
lithium ion battery	31
low	31
problems	51, 52
recharging	31
replacing	32
shorted	32
standby mode	31
BIOS	
guide	26
setup utility	25
Bluetooth	93
Where to Find Information	93
Boot	25
Built-in Speakers	48

C

CapsLock	12
Click Me!	26
Clicking	15
Cold-swapping	32
Configuration Label	10, 69
Controls and Connectors	6
Conventions Used	1
Cursor	15
Cursor Keys	13

D

DC Power Jack	23
Device Ports	42, 70
DIMM	40
Disk	
care	64
Display Panel	6, 24
adjusting	24
brightness	24
closing	24
latch	6
opening	24
problems	53
Display Timeout	28
Double-Clicking	15
Dragging	16
Drivers and Application Restore Disc	57
DVD drive	
access indicator	12
problems	48
tray release	56

E

Emergency Optical Drive Release	7
Error Messages	55
ExpressCards	38
External Floppy Disk Drive	
problems	49
External Video Port	9, 43

F

FDU	59, 71
Fingerprint Sensor Device	97
enrolling a fingerprint	99
getting started	97
installing OmniPass	97
logging into a remembered site	100
OmniPass authentication toolbar	99
password replacement	99
remembering a password	100
uninstalling OmniPass	98
user enrollment	98
using OmniPass	99
Flexible Bay	
Modular Multi-Format DVD Writer	33
Fujitsu Contact Information	1
Fujitsu Driver Update utility	59, 71

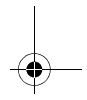
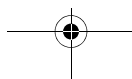
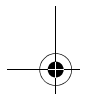
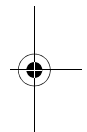
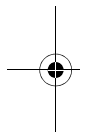



Fujitsu LifeBook	
storing	63
traveling	64
Function Key	
F10	14
F3	13
F4	13
F5	13
F6	14
F7	14
F8	14, 18
F9	14, 18
FN	13
H	
Hard Disk Drive	
problems	49
Headphone Jack	6, 43
Hibernation Feature	27
disable/enable	27
I	
Infrared Port	43
Internal LAN Jack	42
K	
Keyboard	6, 13
cursor keys	13
function keys	13
numeric keypad	13
problems	49
windows keys	13
L	
LAN (RJ-45) Jack	9
LifeBook Application/Media Player Panel	6
M	
Media Player	
care	65
Control Panel	34
Software	34
software	33
using	34
Memory	
capacity	41
compartment	10, 40
installing	40
problems	49
removing	40, 41
upgrade module	40
Memory Stick	
installing	36
removing	37
Memory Stick/SD/xD Card	36, 37
Microphone Jack	7, 43
Microsoft Works	72
Modem	9, 50
Modem Jack	42
Modem Result Codes	56
Mouse	
problems	49
N	
Numeric Keypad	13
NumLk	12
O	
Optical Digital Audio-Out Jack	6
Optical Drive	7, 33
control panel	34
loading	33
removing	34
tray release	34
P	
PC Card	
care	65
inserting	39
problems	50
removing	38, 39
slot	8
Point and Write Pad	16
Pointing Device	
See Touchpad	15
Power	
AC adapter	23
Auto/Airline adapter	23
failure	50, 51
indicator	11
management	27
off	28
on	25
problems	52
sources	23
Power Management	27
Power On Self Test	25, 55
Power/Suspend/Resume Button	6, 27

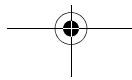
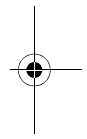
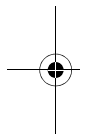

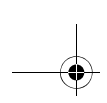

Index

Pre-Installed Software 71
 Adobe Acrobat Reader 71
 Fujitsu HotKey 71
 Google Toolbar 71
 LifeBook Application Panel 71
 manuals 71
 Norton Internet Security 71
 PowerDVD 71

R

Registration 26
 Removing a Memory Stick 37
 Restarting 28
 Restoring Your Pre-installed Software 57
 RJ-11 42
 RJ-45 42

S

ScrLk 12
 SD Card
 installing 36
 removing 37
 SDRAM 10, 40
 Security Panel 19
 Shock Sensor Utility 58
 Specifications 69
 Audio 69
 Chipset 69
 Dimensions and Weight 70
 Environmental Requirements 70
 Keyboard 70
 Memory 69
 Microprocessor 69
 Power 70
 Video 69
 Standby Mode 27
 Status Indicator Panel 6, 11
 Stereo Speakers 6

T

Touchpad 15
 buttons 15
 controls 16
 Touchpad Pointing Device 6
 Troubleshooting 47

U

Unpacking 5
 USB 2.0 50
 problems 50
 USB 2.0 Ports 8, 9, 10, 42

V

Volume control 18

W

Warranty 1
 Windows keys 13
 application key 13
 start keys 13
 Wireless LAN
 Before Using the Wireless LAN 86
 Connection using Wireless Zero Tool 88
 Infrastructure Mode 86
 IP address information 92
 Specifications 92
 Troubleshooting 89
 Wireless LAN Glossary 90

X

xD Card
 installing 36
 removing 37

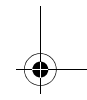
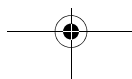
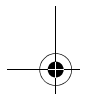
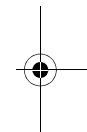
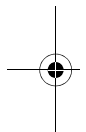

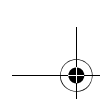

LifeBook A3000 Series Notebook - Index

