

For Maintenance Purpose Only

TeamPad 400G Operation Guide

To Safely Use This Product

About this Manual:

This manual contains important information for safely using this product. Thoroughly read this manual before using the product. In particular, thoroughly read until fully understanding the "Notes on Safety" in this manual before using this product. Refer to this manual when necessary, so keep this manual in an easy-to-refer to place.

FUJITSU makes every effort to prevent users and observers from being injured and to prevent property from suffering from damage. To ensure no harm to you, observers, or the equipment itself, be sure to use the product according to the instructions in this manual.

<Safety for TeamPad400G for Mobile Communication Terminal>

Aircraft Safety

Do not turn on the WAN module of your TeamPad 400G when in an aircraft. The use of WAN function in an aircraft may be dangerous to the operation of the aircraft, disrupt the cellular network and is illegal.

Explosive Atmospheres

- Users are advised not to use the equipment when at a refueling point.
- Users are reminded of the need to observe restrictions on the use of radio equipment in fuel depots, chemical plants or where blasting operations are in progress.

Road Safety

It is advised that a hand-held microphone should not be used by the driver while the vehicle is moving, except in an emergency. Speak only into a fixed, neck slung or clipped-on microphone when it would not distract your attention from the road.

Non-Ionising Radiations

Users are advised that for satisfactory operation of the equipment and for the safety of personnel, it is recommended that no part of the human body be allowed to come too close to the antenna during operation of the equipment.

First Edition Aug. 2004

The contents of this manual may be revised without prior notice.

All Rights Reserved, Copyright © FUJITSU LIMITED 2004

FCC WARNING:

[FHT401S3BW / FHT401S3W]

Changes or modifications not expressly approved by the party responsible for compliance could void the user's authority to operate the equipment.

This equipment has been tested and found to comply with the limits for a Class B digital device, pursuant to part 15 of the FCC Rules. These limits are designed to provide reasonable protection against harmful interference in a residential installation.

This equipment generates, uses and can radiate radio frequency energy and, if not installed and used in accordance with the instructions, may cause harmful interference to radio communications. However, there is no guarantee that interference will not occur in a particular installation. If this equipment does cause harmful interference to radio or television reception, which can be determined by turning the equipment off and on, the user is encouraged to try to correct the interference by one or more of the following measures:

- Reorient or relocate the receiving antenna
- Increase the separation between the equipment and receiver.
- Connect the equipment into an outlet on a circuit different from that to which the receiver is connected.
- Consult the dealer or an experienced radio/TV technician for help.

RF Exposure Statement:

The available scientific evidence does not show that any health problems are associated with using low power wireless devices. There is no proof, however, that these low power wireless devices are absolutely safe. Low Power Wireless Devices emit low levels of radio frequency energy (RF) in the microwave range while being used. Whereas high levels of RF can produce health effects (by heating tissue), exposure to low-level RF that does not produce heating effects causes no known adverse health effects. Many studies of low-level RF exposures have not found any biological effects. Some studies have suggested that some biological effects might occur, but such findings have not been confirmed by additional research. This equipment has been tested without accessories because the accessories do not contain any metal parts. It was found to comply with FCC radiation exposure limits set forth for an uncontrolled equipment, and it meets the FCC radio frequency (RF) Exposure Guidelines in Supplement C to OET65. The highest SAR level of the equipment was 0.125W/kg at Body.

This transmitter must not be co-located or operated in conjunction with any other antenna or transmitter.

Contents

Chapter 1 Outline	1-1
1.1 HHC Types and Options.....	1-1
1.2 Exterior Views.....	1-2
1.3 Specifications.....	1-3
Chapter 2 Operations.....	2-1
2.1 Holding the HHC.....	2-2
2.2 Turning On and Off the HHC Power.....	2-2
2.3 Adjusting LCD Brightness.....	2-2
2.4 Key Functions.....	2-3
2.4.1 Key labels.....	2-3
2.4.2 Functions of major keys.....	2-4
2.5 Handling the Battery.....	2-5
2.5.1 Recharging the batter.....	2-5
2.5.2 Replacing the battery pack.....	2-6
2.6 USB interface.....	2-8
2.7 Bar Code Reader (Laser scanner).....	2-8
2.8 Notes.....	2-9
2.8.1 Installation (Initialization).....	2-9
Chapter 3 Operating the DIAG Function Test Program	3-1
3.1 Starting DIAG.....	3-1
3.2 ROM Test.....	3-2
3.3 RAM Test.....	3-3
3.4 Display Test.....	3-4
3.5 Key/Touch.....	3-5
3.6 File Test.....	3-6
3.7 Scanner Test.....	3-7
3.8 Battery Test.....	3-8
3.9 Headset Test.....	3-9
3.10 IRDA Test.....	3-10
Chapter 4 Vehicle Charger.....	4-1
4.1 Outline.....	4-1
4.2 Component Names.....	4-1
4.3 Connection.....	4-2
4.4 Charging.....	4-3
4.5 Specifications.....	4-4
4.6 Cleaning.....	4-5
Chapter 5 Multi Charger.....	5-1
5.1 Outline.....	5-1
5.2 Component Names.....	5-2
5.3 Connection.....	5-3
5.4 Charging.....	5-4
5.5 Specifications.....	5-5
5.6 Cleaning.....	5-6

Chapter 6 USB adapter	6-1
6.1 Outline.....	6-1
6.2 Component Names.....	6-1
6.3 Operations Summary.....	6-1
6.4 Connection.....	6-2
6.5 Communication.....	6-4
6.6 Recharging.....	6-5
6.7 Specifications.....	6-6
Chapter 7 LAN adapter.....	7-1
7.1 Outline.....	7-1
7.2 Component Names.....	7-1
7.3 Operations Summary.....	7-1
7.4 Connection.....	7-2
7.5 Communication.....	7-4
7.6 Recharging	7-5
7.7 Specifications	7-6

Chapter 1 Outline

This chapter provides general information about the TeamPad 400G Series hand-held computers (HHCs), including their exterior views and specifications.

1.1 HHC Types and Options

The HHC is full-compatibility with the industry-standard Windows-CE machines.

The TeamPad 400G Series HHCs will support options such as memory cards.

The HHCs run Windows-CE as an operating system. In addition, specialized application software is available to meet specific and general needs.

The TeamPad 400G Series HHCs are grouped into the following two types:

- FHT401S3BW: Windows-CE.NET 4.2, color LCD, with a laser scanner, with a SS radio and Bluetooth.
- FHT401S3W: Windows-CE.NET 4.2, color LCD, with a laser scanner, with a SS radio, without Bluetooth.

The HHCs are connectable to the following units:

- FHTUA411: USB adapter
Unit for connecting HHC to main system by the USB interface.
The battery pack in HHC can be charged.
- FHTUL411: LAN adapter
Unit for connecting HHC to main system by the LAN interface.
The battery pack in HHC can be charged.
- FHTCC411: Vehicle charger.
In-vehicle unit.
Battery pack in HHCs can be charged.
- FHTMA411W: Multi charger
4-slot Main unit charger.
Four battery packs in HHCs can be charged at a time.

1.2 Exterior Views

The HHCs are powered from an internal lithium-ion battery pack (which is recharged at the same time the HHC is placed in the USB adapter/LAN adapter/Vehicle charger). They come with 64 MB RAM installed (not including an optional memory card). This high-capacity RAM (and the CPU) allows the HHCs to be used as personal computers.

RAM data is protected to be stored by internal back-up mass capacitor. Each HHC can communicate with a host computer or another HHC by the several kinds of interface such as Compact Flash card, miniSD memory card, IrDA, USB and SS Radio.

Figure 1.2 shows TeamPad 400G



Figure 1.2 TeamPad 400G Series HHC

1.3 Specifications

This section summarizes the specifications of the TeamPad 400G Series HHCs.

Table 1.1 TeamPad 400G Series HHC specifications (1/2)

ITEM		Standard type	Bluetooth type
Control	CPU	intel PXA 255(400MHz)	
	Memory	RAM: 64MB ROM: 64MB FFS: 32MB	
	OS	Windows-CE .NET 4.2	
Display	Type	3.5inch TFT COLOR LCD	
	Size	240 × 320 pixels	
	Character	Alphanumeric	
	LCD Light	LED back Light	
	Controller	QVGA (MQ1132)	
Keyboard	Tactile	10-key, Function keys plus a scanner trigger key	
	Touch panel	Pen and touch panel	
Barcode Scanner *1	Speed	Approximately 100 scan/sec	
	Depth of field	Approximately 5 to 40 cm	
	Reading angle	Approximately 23/47 degree	
	Code type	JAN/EAN/UPC/NW7/EAN128/ CODE39/CODE93/ CODE128/ITF	
Storage card		Compact Flash card (Type II) slot × 1 mini SD memory card slot × 1	
USB Interface		USB 1.1 (Slave/Host)	
Infrared Interface		IrDA V1.0	
Wireless Interface		WLAN:IEEE802.11b (Internal antenna)	WLAN:IEEE802.11b /Bluetooth (Internal antenna)
Audio		UCB1400 (Philips) Internal speaker	
Vibration		Motor × 1	

Table 1.1 TeamPad 400G Series HHC specifications (2/2)

ITEM		Standard type	Blue Tooth type	
Power	Main battery	Rechargeable Lithium-ion battery pack 1) Standard capacity battery pack 3.6 V/1800mAh(1 cell) 2) Large capacity battery pack 3.6V/3600mAh(2 cell option)		
	Sub battery	Mass capacitor(Memory is held for 3 min.)		
	Operating time *2 (with a new battery)	about 6 hours(1cell)/12hours(2cell option)		
	Back-up time	Memory	(1) 7 days (25°C, with full-charged Main battery) (2) 3 minutes (25°C, with Mass capacitor)	
		RTC	16 days (25°C, with Mass capacitor)	
Charging time		Approximately 3 hours (at the Pack charged)		
Operating temperature/humidity		-5°C to +50°C Up to 85%RH		
Storage temperature/humidity		-20°C to +60°C Up to 95%RH		
Size	Measurement	75 × 160 × 19 mm		
	Weight	Approximately 280g		
Environment		Splashing at 3-5mm/min		
		Memory contents guaranteed in Event of a drop of up to 5 ft On concrete surface.(Based on Fujitsu evaluation method.)		
		ESD 15 kV		
Option		USB adapter/LAN adapter/Vehicle charger/Multi charger/ Battery pack charger /AC adapter/strap etc.		
Approvals		FCC Part 15 class B		

*Note) The battery consumption condition is as follows.

(1) Specifications are subject to change without notice.

(2) Under endurance operating condition rate (full-charged new battery, Wireless connection, Back Light on, repeated operating of scan and data transmission/reception)

Chapter 2 Operations

This chapter provides operating instructions for the TeamPad 400G Series hand-held computers (HHCs).

Figure 2.1 shows the keyboard and display (LCD) of a HHC. The HHC is powered from the internal lithium-ion battery pack.

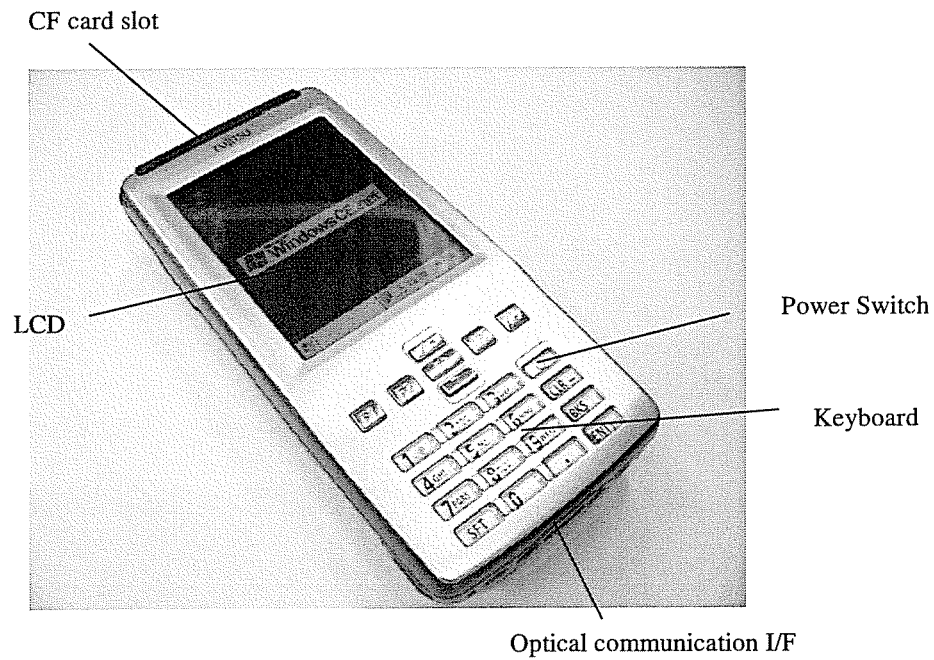

Figure 2.1 HHC keyboard and display(FHT401S3BW/FHT401S3W)

2.1 Holding the HHC

The HHCs are furnished with a wrist strap on their back so you can hold them securely during use. Hold the HHC as shown in Figure 2.1.1.

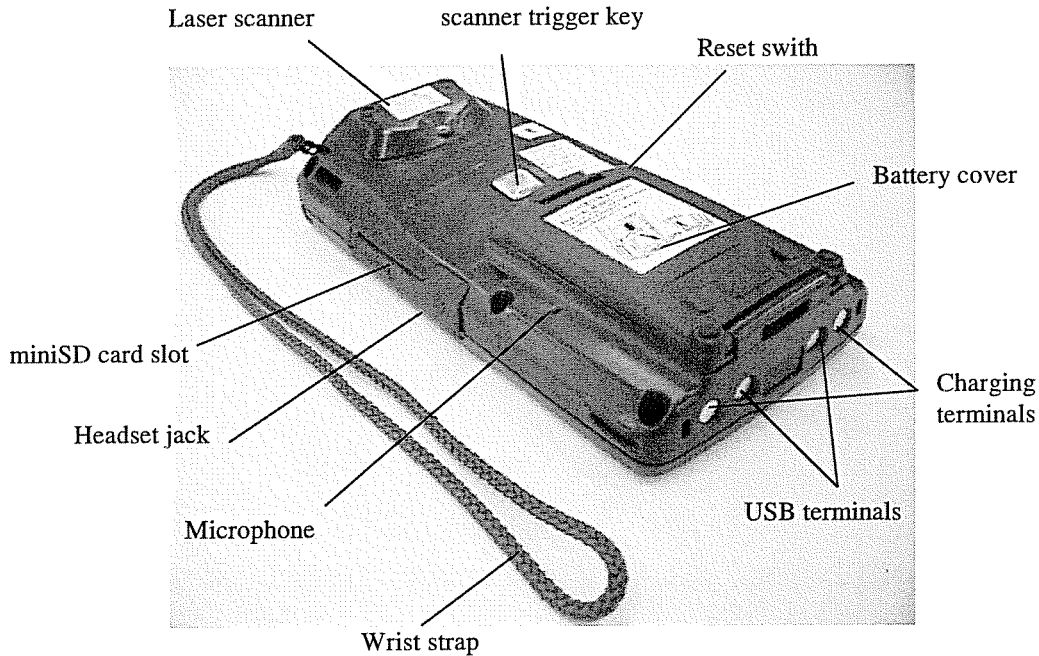

Figure 2.1.1 Holding the HHC

2.2 Turning On and Off the HHC Power

To turn on the HHC, press the [PWR] key. (Press time approximately 0.5 seconds)

To turn it off, press the [PWR] key. (Press time approximately 0.5 seconds)

2.3 Adjusting LCD Brightness

[SFT] + [F3] key: Increases Brightness.

[SFT] + [F4] key: Decreases Brightness.

To adjust the LCD Brightness, press the above keys until the desired brightness is attained.

2.4 Key Functions

As stated in Chapter 1, the HHC keyboard contains a set of 10 keys. This section shows the key labels and explains the functions of major keys.

2.4.1 Key labels

Figure 2.5.1 shows the labels of those keys that are functional when the [SFT] key is pressed or not.

(1) Normal state

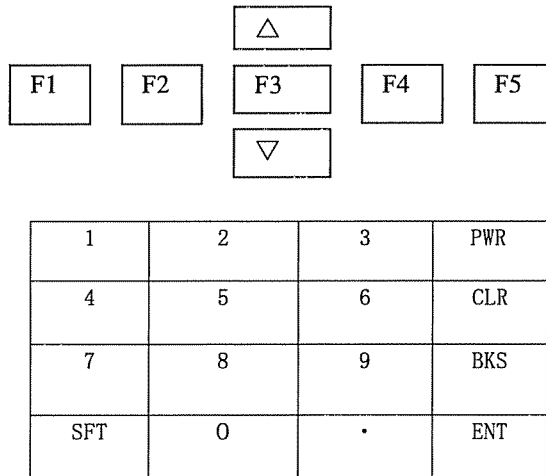

(2) When the [SFT] key is pressed

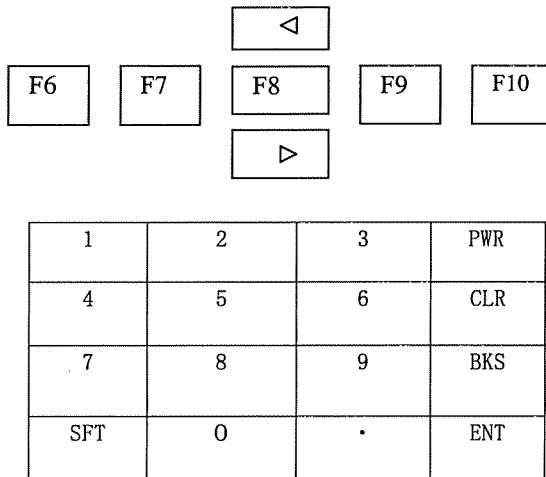

Figure 2.5.1 Key labels

2.4.2 Functions of major keys

The table below describes typical functions of major keys.

[Examples]

Key	Function
0 to 9	Enter numeric characters
.	Dot
CLR	Clear
BKS	Erases the last character of the text on display.
ENT	Validates an entry.
SFT	Second function key
PWR (Power on/off)	Turns on/off the HHC.
—	Moves the cursor to up (by one position).
—	Moves the cursor to down (by one position).
◀	Moves the cursor to left (pushed with SFT key)
▶	Moves the cursor to right (pushed with SFT key)
SFT + BKS	ESC
SFT + ENT	CTRL
SFT + CLR	— (Displays the previous line)
SFT + F1	F6
SFT + F2	F7
SFT + F3	F8 (decreases the brightness of LCD backlight)
SFT + F4	F9 (increases the brightness of LCD backlight)
SFT + F5	F10 (soft keyboard)

2.5 Handling the Battery

HHCs are powered from the internal lithium-ion battery pack.

As the battery begins to run low on power, the message "Low Main Battery Alarm" will appear on the screen, telling you that the battery needs recharging.

The battery has an estimated service life of about 500 recharge and discharge cycles. Depending on the usage, the battery may expire less than 500 cycles.

Only use the proper lithium-ion battery specified below:

Manufacture: Fujitsu Ltd.

Drawing number: CA05951-6216/KD54003-L014

2.5.1 Recharging the battery

While HHCs are placed in the USB adapter/LAN adapter, their internal lithium-ion battery pack begins recharging automatically. The battery, once discharged, requires about 3 hours to recharge completely.

The battery pack also takes about 3 hours to recharge when using the charger supplied with the HHC. For specific recharging instructions, refer to the relevant documentation.

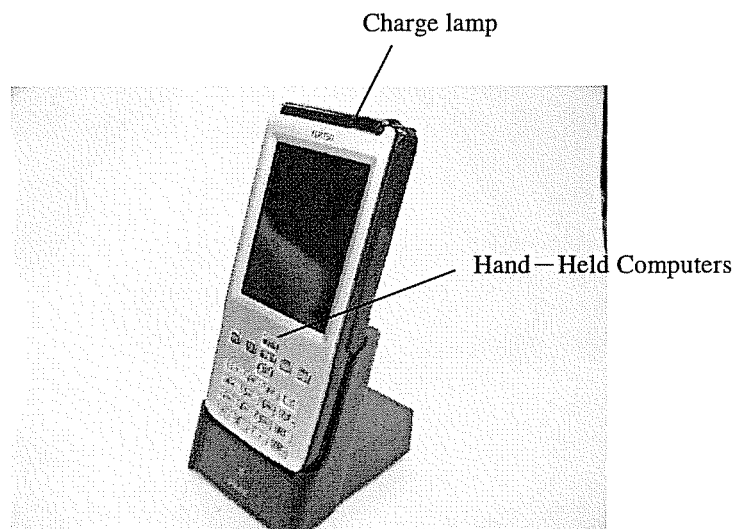

Figure 2.5.1 Recharging the lithium-ion battery pack

1. Charging the HHC

When charging the HHC, follow these steps:

- (1) HHC is mounted on the charger.

The charge lamp of HHC lights up in orange during charge of a battery.

- (2) The charge will be completed for approximately 3 hours. The lamp will be changed to green when completed.

2.5.2 Replacing the battery pack

The lithium-ion battery pack is expendable. Depending on the usage, the battery may expire less than 500 cycles. For disposal of the replaced battery, see the [Warning] in this Section.

To replace the battery, follow these steps:

- (1) Turn off the HHC's power
- (2) Turn over the HHC (see (a)).

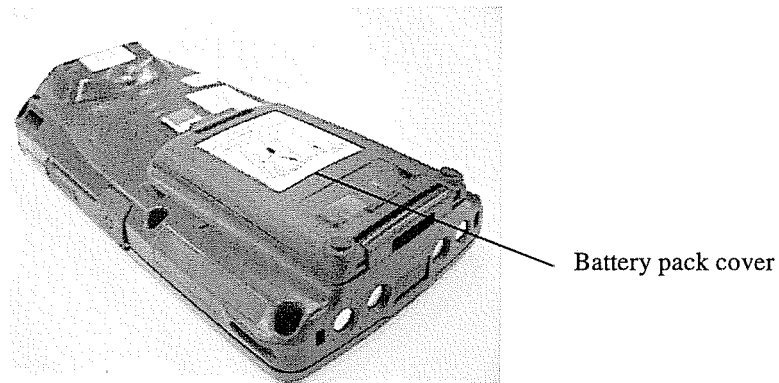

(a)

- (3) Slide the battery cover lock in the direction of the arrow to lift the cover up while holding the protuberances on both side of battery pack cover (see (b)).

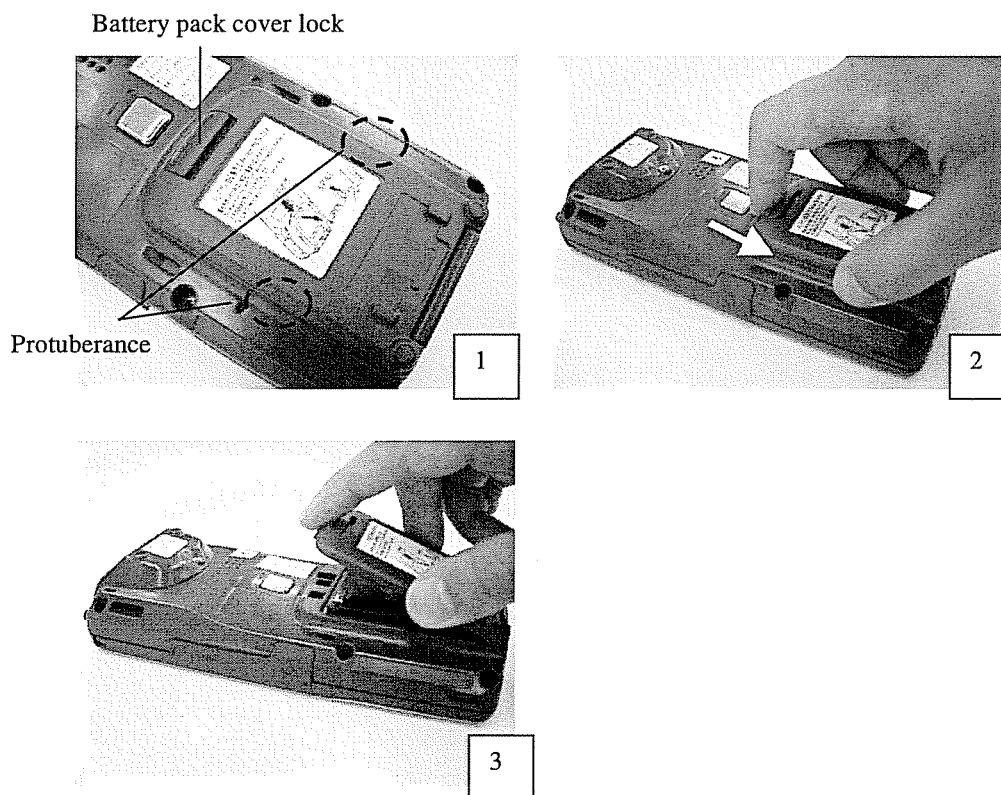

(b)

- (4) Pull the net ribbon up and remove the battery (see (c)).

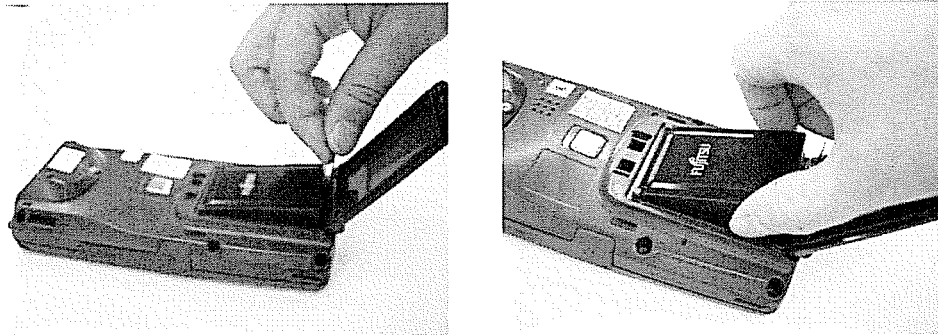

(c)

Figure 2.5.2 Replacing the lithium-ion battery pack

CAUTION: DANGER OF EXPLOSION IF BATTERY IS INCORRECTLY REPLACED. REPLACE ONLY WITH THE SAME OR EQUIVALENT TYPE RECOMMENDED BY THE MANUFACTURER. DISCARD USED BATTERIES ACCORDING TO THE MANUFACTURER'S INSTRUCTIONS.

ATTENTION: IL Y A DANGER D'EXPLOSION S'IL Y A REMPLACEMENT INCORRECT DE LA BATTERIE. REMPLACER UNIQUEMENT A VEC UNE BATTERIE DU MÊME TYPE OU D'UN TYPE RECOMMANDÉ PAR LE CONSTRUCTEUR. METTRE AU RÉBUT LES BATTERIES USAGÉES CONFORMÉMENT AUX INSTRUCTIONS DU FABRICANT.

⚠ WARNING

Batteries may explode if not installed correctly. Replace with batteries of the same type or equivalent as recommended by the manufacturer. Dispose of used batteries as per the manufacturer's instructions.

2.6 USB Interface

The HHCs have an USB slave and host contact.

This transmission, however, requires the use of a USB adapter.

2.7 Bar Code Reader(Laser scanner)

Operations

- 1) Press the read switch.

A red scanning line is emitted from the scanner read window.

- 2) Position the bar code reader so that the scanning line lies across the bar code.

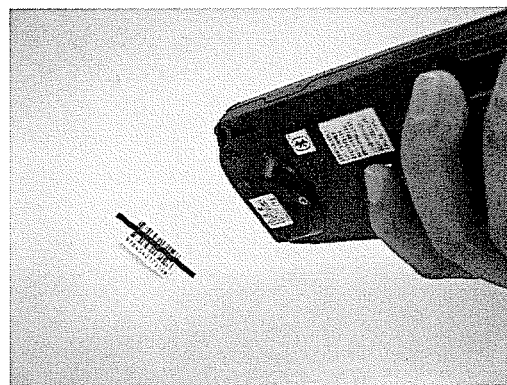
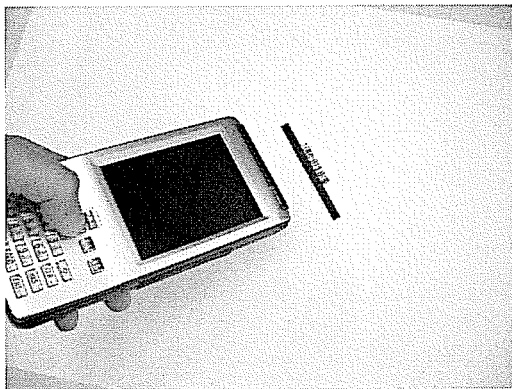

- 3) When reading is complete, the scanning line automatically turns off.
- 4) Then, release the read switch.

⚠ WARNING

While the scanning line is being emitted, do not look into the reading window. Doing so may damage your eyes.

Note

- When the HHC determines that there is no bar code at the reading window, the HHC stops emitting the scanning line after about one second whether or not you continue to press the reading switch.
- If a bar code cannot be read, try reading it again by changing the location of the scanning line, the distance or the angle between the bar code and the HHC.
- If the scanning line extends across more than one bar code, the bar code read cannot be determined.

Reading characteristics of the laser scanner (reference figures)

This section shows the relationship between narrow bar width, reading depth, and scanning width at 23degC.

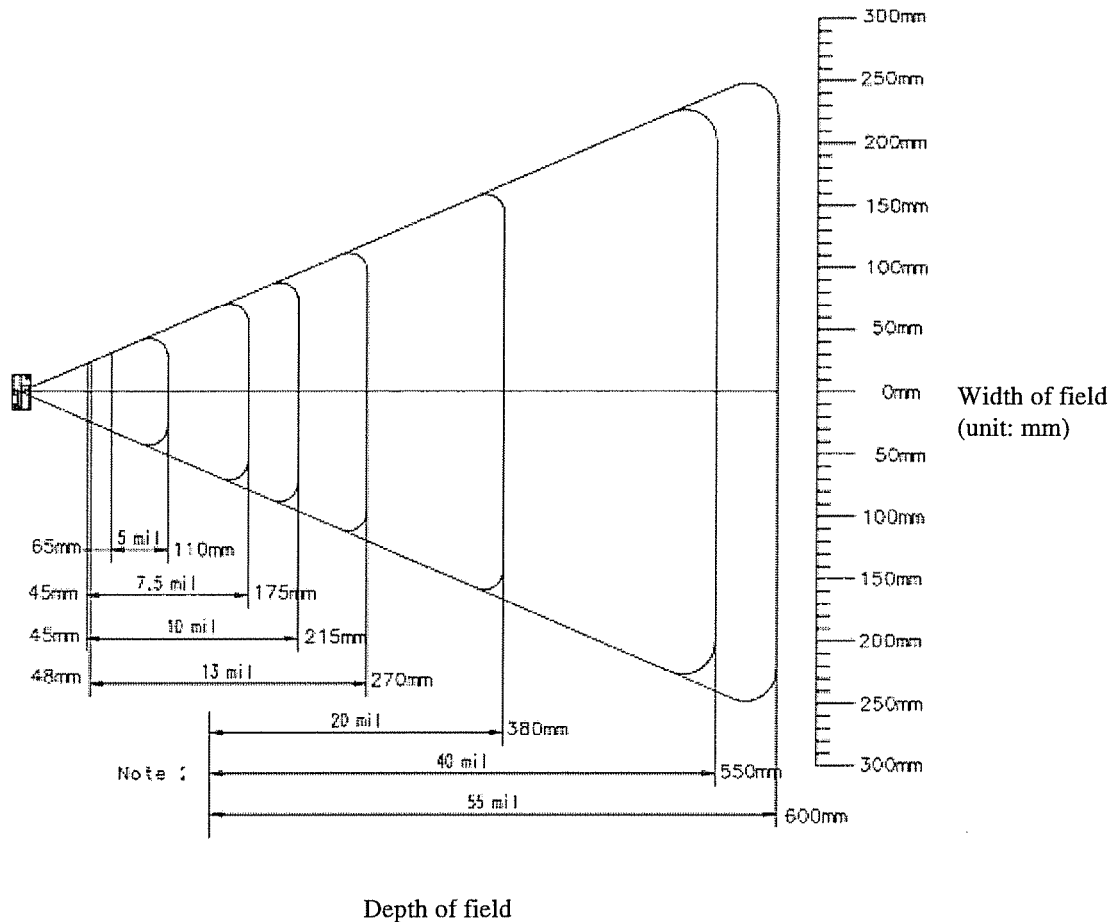

Note: Near ranges on lower densities are largely dependent upon the width of the bar code and the scan angle.

2.8 Notes

This section describes the notes on operating TeamPad 400G HHC.

2.8.1 Installation (Initialization)

When turning on the HHC power for the first time, load a fully charged battery.

Chapter 3 Operating the DIAG Function Test Program

The HHC has the DIAG function for checking the operation of a connected device.

3.1 Starting DIAG MENU

Select 9 in the TeamPad setting tool to start the DIAG MENU, and the DIAG MENU is opened as shown below.

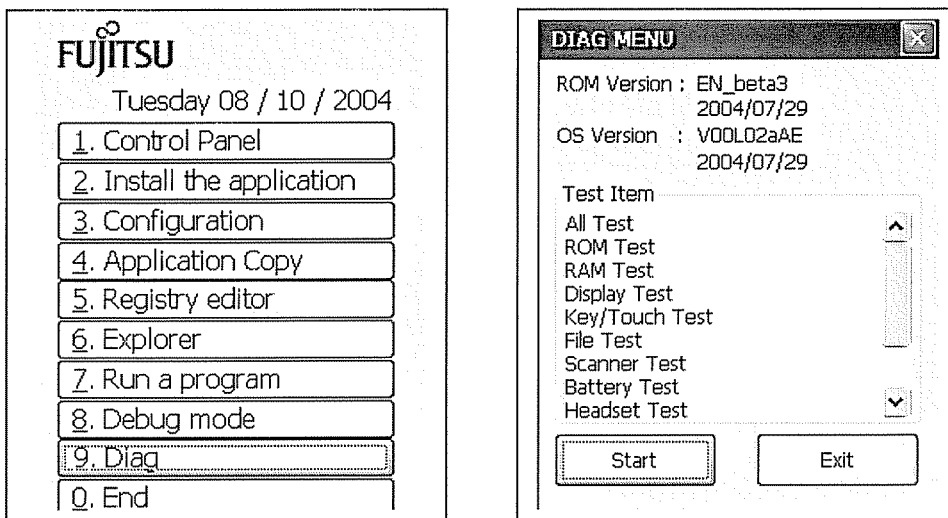

Select one of the items on the DIAG MENU and tap 「start」 button to start the corresponding DIAG function.

If tap 「Exit」 button, DIAG quits, and the processing returns to the TeamPad Setting Tool menu.

IMPORTANT

- DIAG is a test program for checking the operation of the HHC. It allows checking the operation of such units as scanner.
 - The DIAG screens and operation procedures that are explained in this manual are subject to change without notice.
-

3.2 ROM Test

Select ROM Test item and tap the 「Start」 button on the DIAG menu to start the ROM test as shown below.

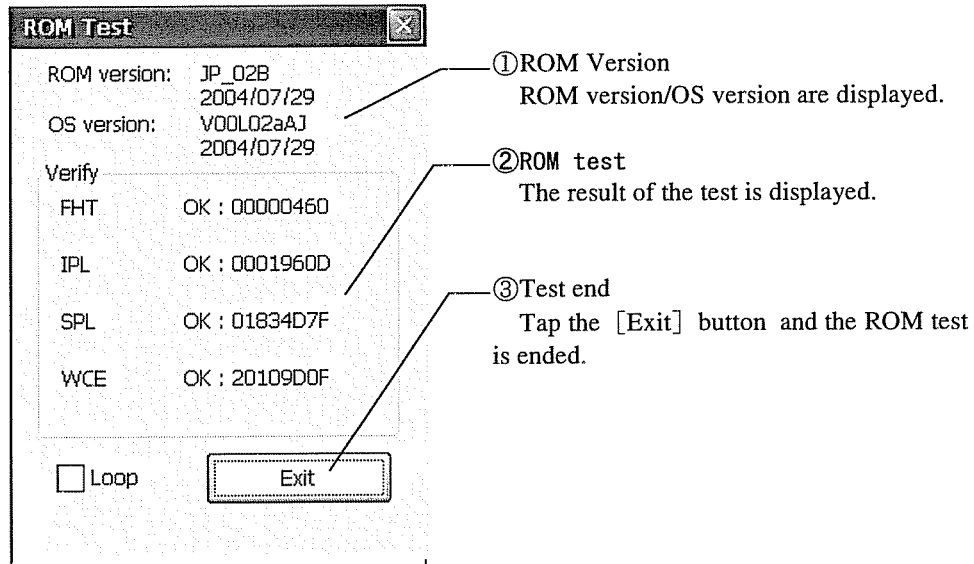

POINT

- It cannot be cancel when the test is executing. when the test finished, the [Exit] button is available.

3.3 RAM Test

Select RAM Test item and tap the 「Start」 button on the DIAG menu to start the RAM test as shown below.

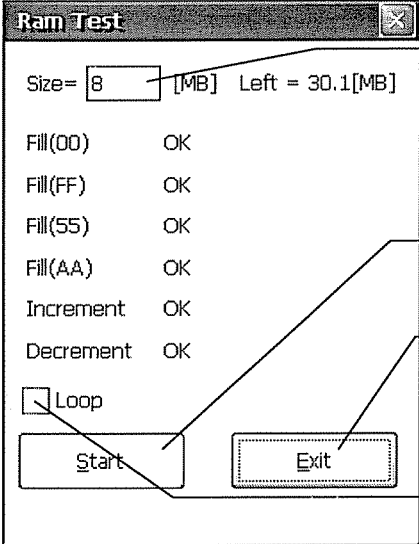

The screenshot shows a dialog box titled "Ram Test" with the following elements:

- Size=** **[MB]** **Left = 30.1[MB]**
- Fill(00) OK
- Fill(FF) OK
- Fill(55) OK
- Fill(AA) OK
- Increment OK
- Decrement OK
- Loop
-
-

Numbered callouts provide the following instructions:

- ① Specify RAM size
Specify the size of RAM(object store) for test.
- ② RAM test
The result of RAM test is displayed.
- ③ Test start
Tap the [Start] button to start the ROM test.
- ④ Test end
Tap the [Exit] button and the test is ended.
- ⑤ Loop specification
Check the [Loop] if execute the test as a loop.
uncheck the [Loop] button to stop the loop.

POINT

- The maximum specification value of RAM size equals the vacancy of the object store
-

3.4 Display Test

Select Display item and tap the 「Start」 button on the DIAG menu to start the Display test as shown below.

The display test is started and a screen display changes as a fixed cycle.

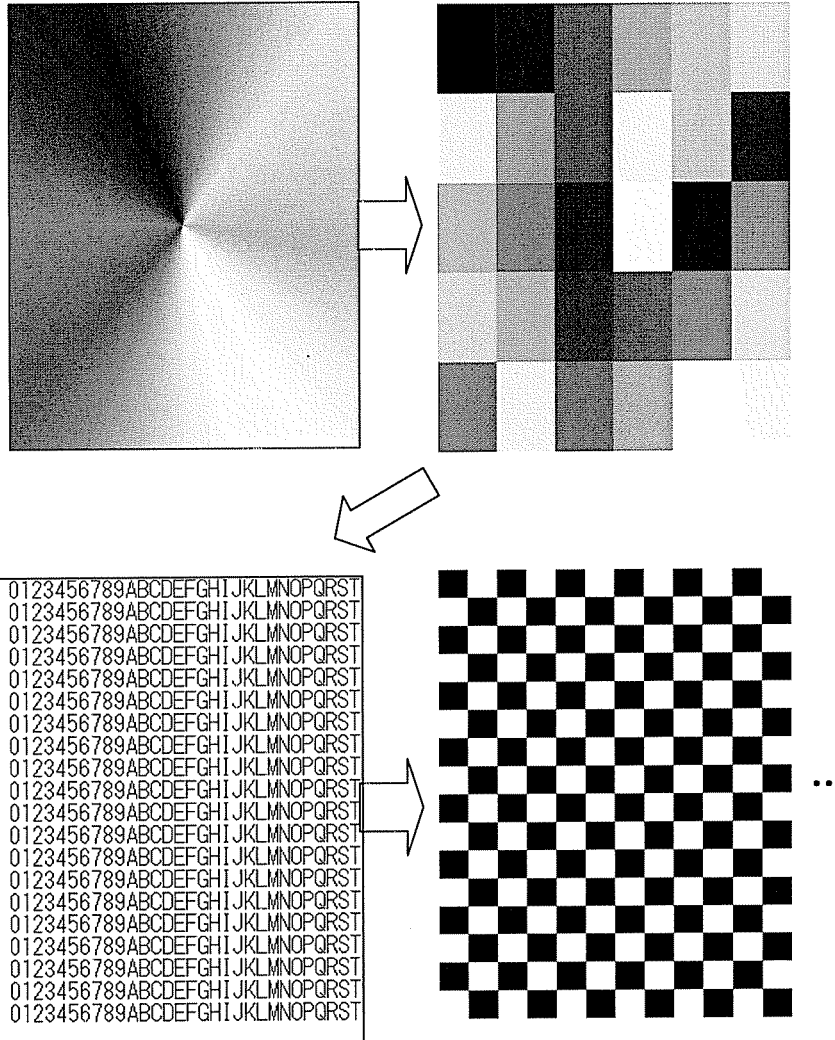

For stopping the test, keep on tapping the screen for seconds, a dialog will be displayed as shown below.

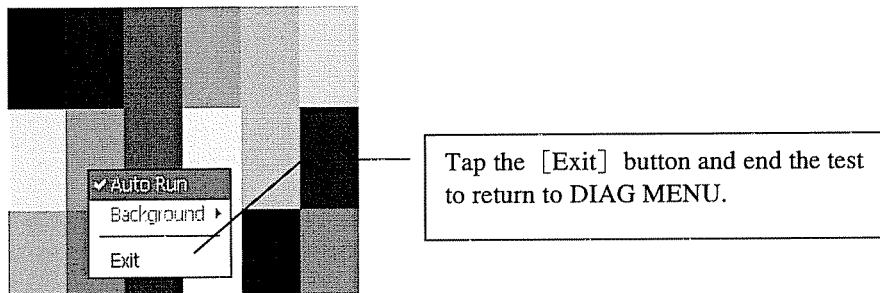

3.5 Key/touch test

Select Key/touch test item and tap the 「Start」 button on the DIAG menu to start the Key/touch test as shown below.

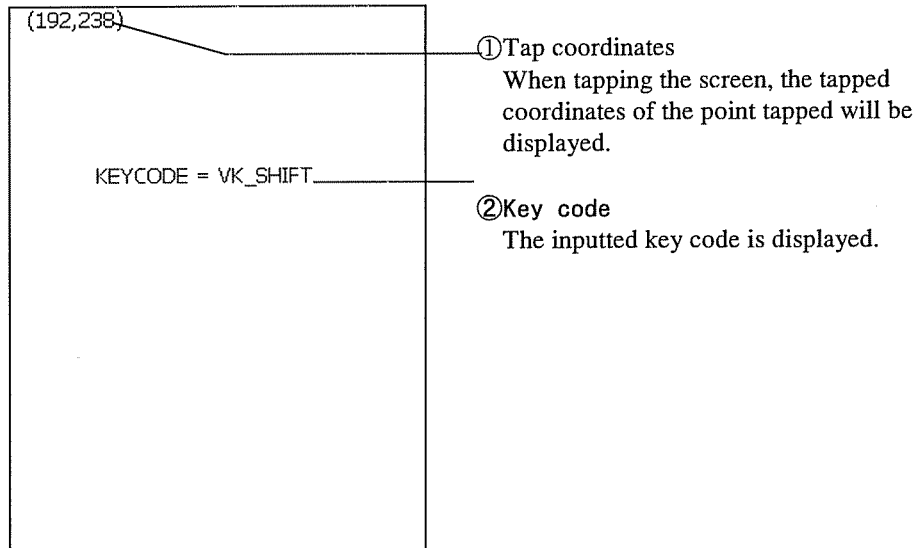

For stopping the test, keep on tapping the screen for seconds, a dialog will be displayed as shown below.

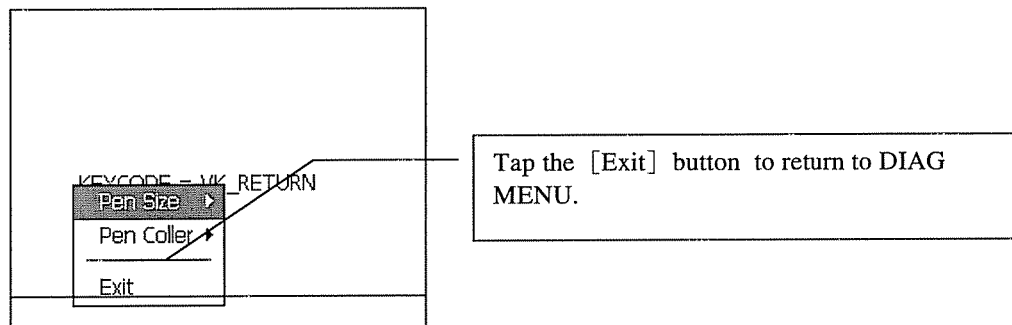

POINT

- The point that is tapped is displayed as black dot when tapping the touch panel

⚠ Caution

- Before using, the touch panel is required to be calibrated. If not, the pressed point differs from recognized point on the HHC. This causes wrong operation on the device.
- When tapping the touch panel, do not use sharp pointer like a ball point pen or a mechanical pencil. If such a pointer is used, the display will get scratches, or the device will be broken.

3.6 File Test

Select File Test item and tap the 「Start」 button on the DIAG menu to start the File test as shown below. There are four items for selecting on the File Test menu.

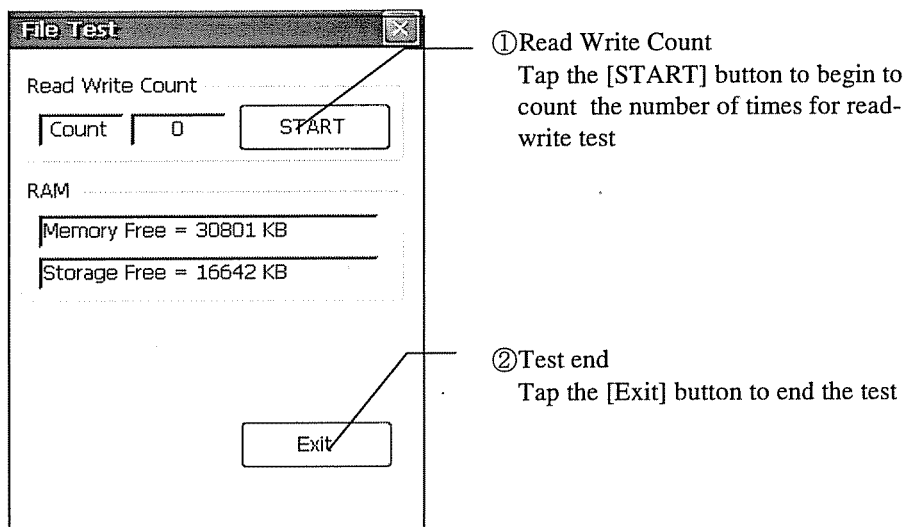
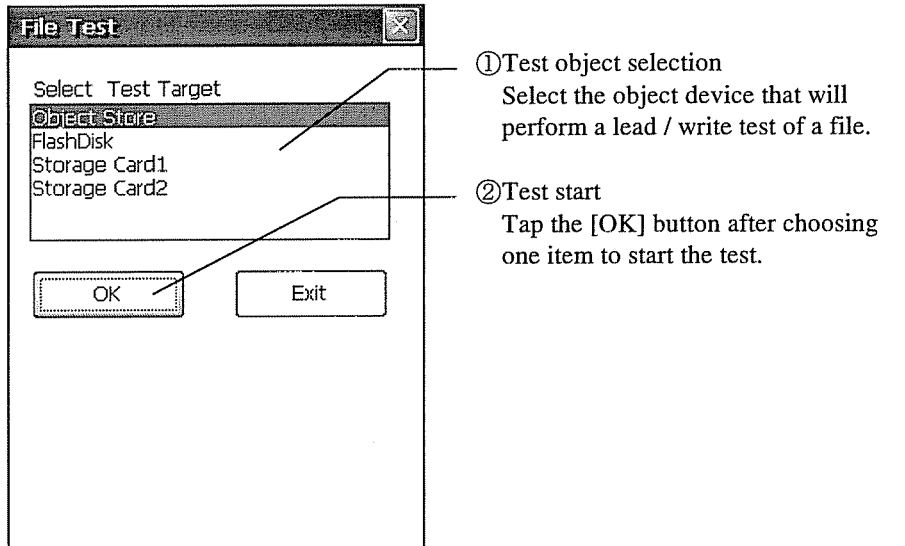

3.7 Scanner Test

Select Scanner Test item and tap the 「Start」 button on the DIAG MENU to start the Scanner test as shown below.

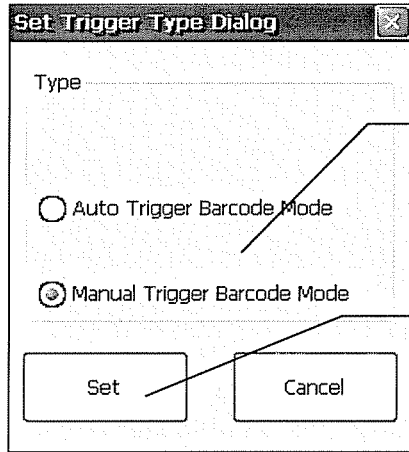

- ① Reading mode Selection
Select one reading mode from Manual Trigger Barcode Mode (reading by a trigger key) or Auto Trigger Barcode Mode (automatic reading without trigger key)
- ② Scanner test start
Tap the [Set] button to start scanner test. The following dialog will be displayed.

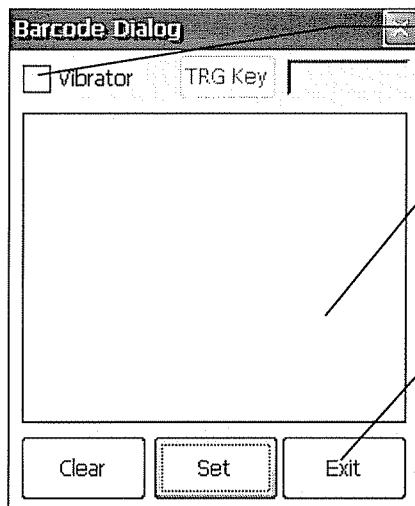

- ① Vibrator selection
The existence of vibration operation can be chosen at the time of bar code reading.
- ② Reading
Push a trigger key to read a bar code. The reading result is displayed.
- ③ Test end
Tap the [Exit] button to end the test.

POINT

- If a [trigger key] button is pushed, it can change which key is assigned to a trigger key among the "F2", "F3", "F4", "△", and "▽" keys.

3.8 Battery Test

Select Battery Test item and tap the 「Start」 button on the DIAG menu to start the Batter test as shown below

Battery Test	
Main-battery	
A/D convert data	0x039B
Voltage	7.578 v
Life Percent	75 %
Status	HIGH
Sub-battery	
A/D convert data	
Voltage	
Life Percent	
Status	
AC	
Status	OFFLINE
GetSystemPowerStatusEx2	TRUE
vCoef :	0x20D8

- ① The Main battery information
 - Main Battery Voltage (Unit: V)
 - Main Battery Residual Quantity (Unit: 100% / 75% / 50% / 25%)
 - Main Battery Status (Unit: HIGH/LOW)
- ② External power supply information
 - Display the status of the external power supply
 - (ONLINE: supply state/OFFLINE:no supply state)
- ③ Test end
 - When ending the test, tap the [x] button at the upper right of a screen, and the screen is closed.

3.9 Headset Test

Select Headset Test item and tap the 「Start」 button on the DIAG menu to start the Headset test as shown below.

If tap the [x] button at the upper right of the screen, the Head set Test will be ended and it will return to the DIAG menu.

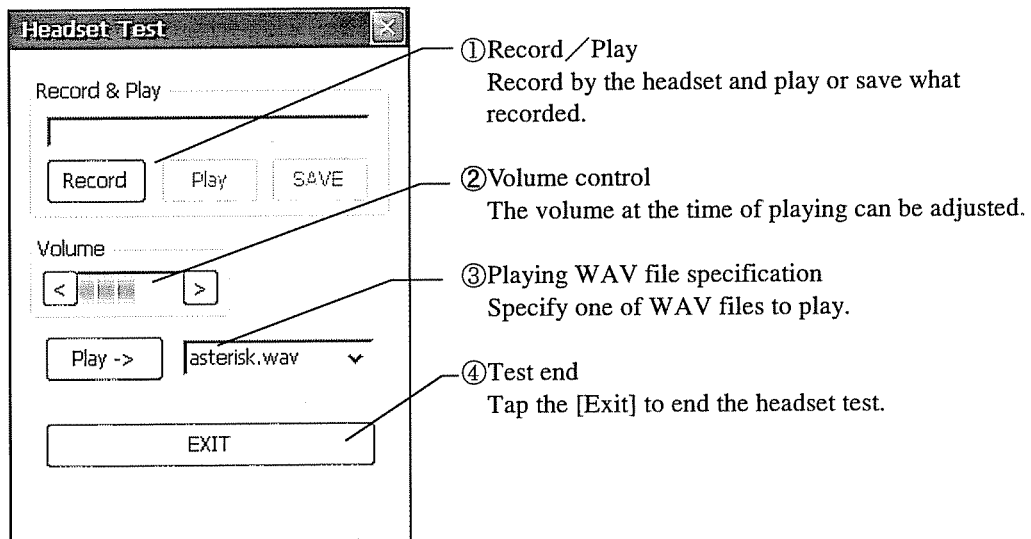

3.10 IRDA Test

Select IRDA Test item and tap the 「Start」 button on the DIAG menu to start the IRDA test as shown below.

This test is performed by the opposite communication which used two sets of equipments.

If tap the [x] button at the upper right of a screen, the IrDA Test will be ended and it will return to the DIAG menu.

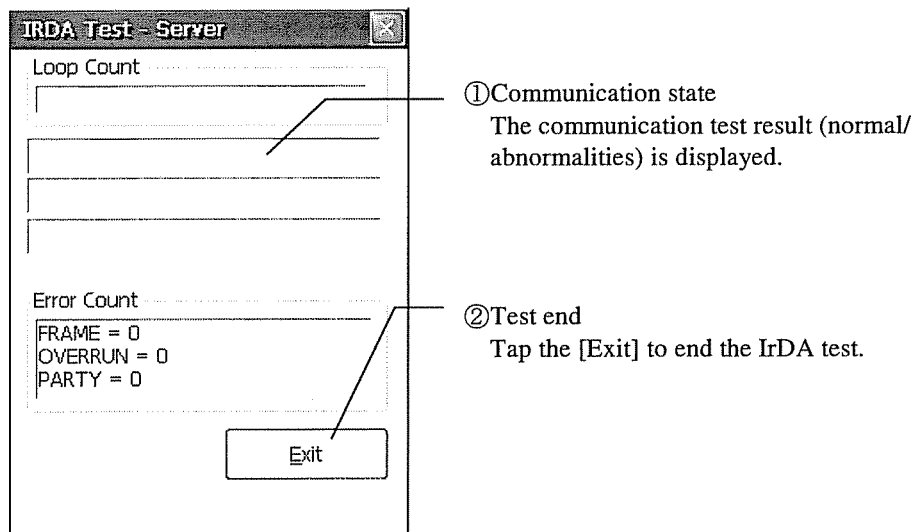
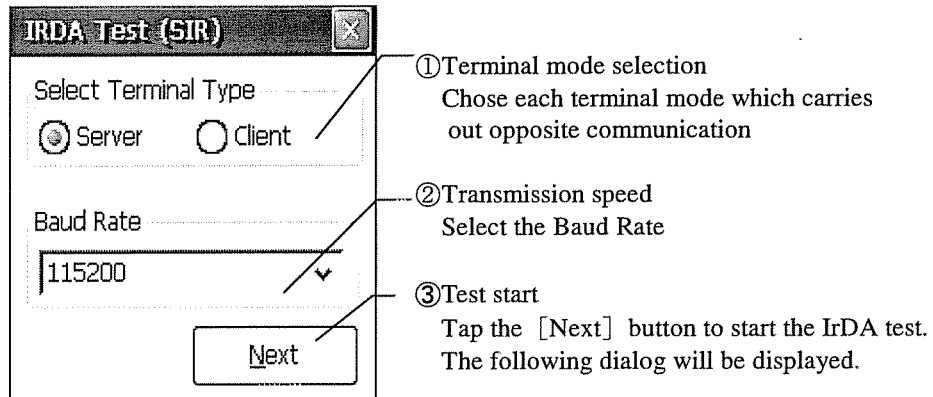

3.11 Vibrator Test

Select Vibrator Test item and tap the 「Start」 button on the DIAG menu to start the Vibrator test as shown below

If tap the [x] button at the upper right of a screen, the Vibrator Test will be ended and it will return to the DIAG menu.

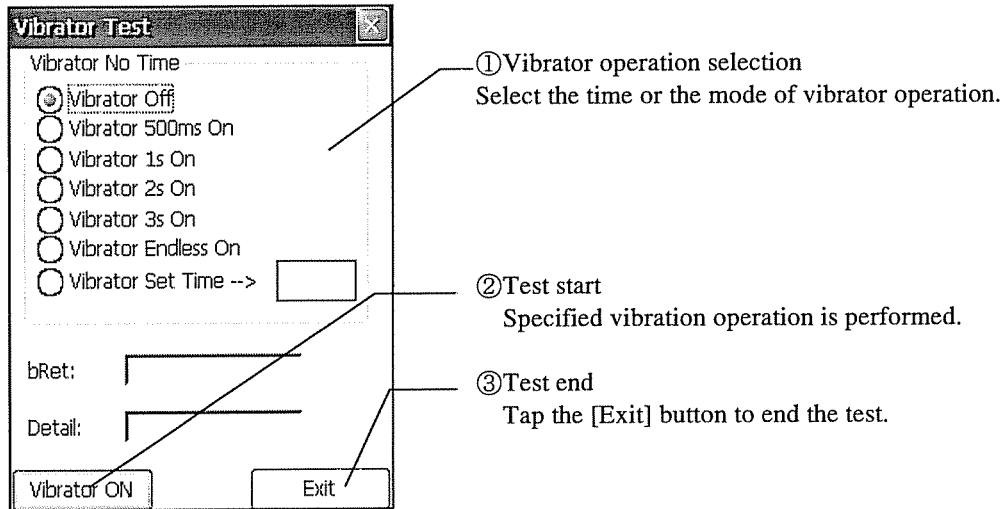

Chapter 4 Vehicle Charger

4.1 Outline

- Outline
When the TeamPad 400G Series HHC is mounted on a Vehicle charger, the HHC can be charged.
- Operation
FHTCC411 Vehicle charger does not have a power switch.
When a HHC with a battery is mounted, charging starts.

4.2 Component Names

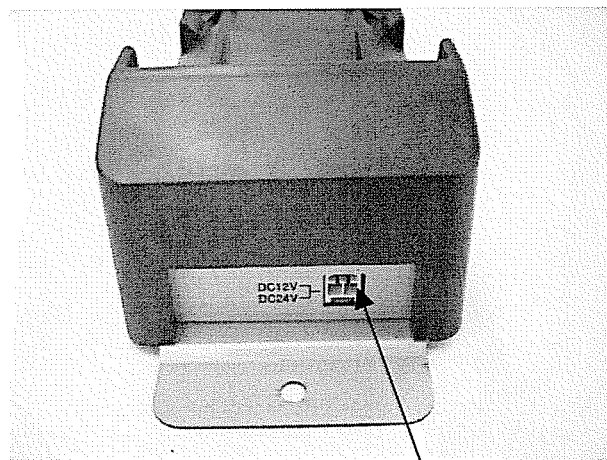
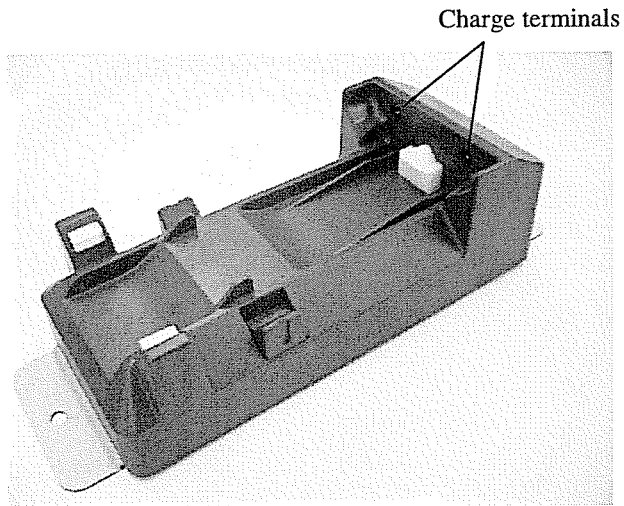

Connector (Power cable)

4.3 Connection

1. Connecting to an automobile battery

When connecting the Vehicle charger to an automobile battery, follow these steps:

- (1) The power supply cable is connected to an automobile battery.
- (2) Connect the power supply cable to the Vehicle charger.

2. Connecting to a HHC

- (1) Check that the charge terminal of the Vehicle charger and the charge terminals of the HHC are not dirty.
- (2) Mount the HHC on the Vehicle charger as shown below.

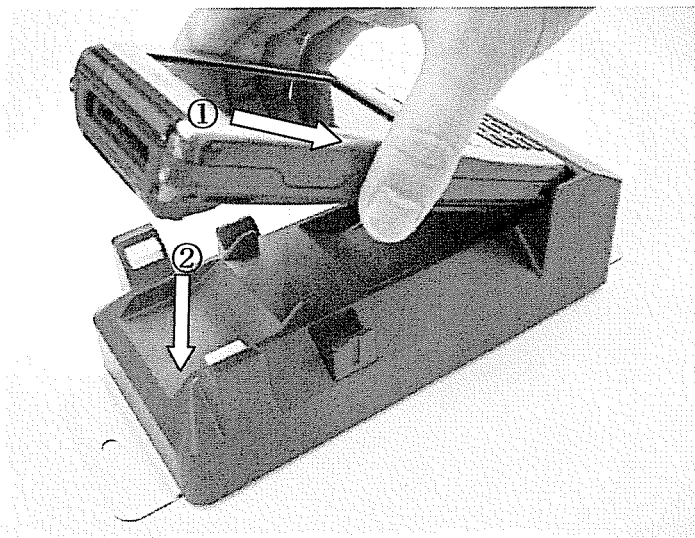

Note

If the HHC to be mounted is wet, wipe off moisture completely with gauze. If a wet HHC is mounted on the Vehicle charger, a malfunction or failure may result.

4.4 Charging

1. Charging the HHC

When charging the HHC by the Vehicle charger, follow these steps:

- (1) HHC is mounted on the Vehicle charger.

The charge lamp of HHC lights up in orange during charge of a battery.

- (2) The charge will be completed for approximately 3 hours. The lamp will be changed to green when completed.

Note

While the HHC is on, the battery is not correctly charged.

Note

If the charging terminal is dirty, the battery may not be charged. Clean a dirty charging terminal using a cotton swab and a neutral detergent.

4.5 Specifications

Item		Specifications
Charging	Charging time	About 3 hours (1 cell)
Power supply		DC12V/24V(an automobile battery)
Temperature and humidity	Operating temperature and humidity	0 to +40°C 10% to 90%RH
	Charging	0 to +40°C
	Storage temperature and humidity	-20 to +60°C 5% to 95%RH
Dimensions and weight		About 250mm(W) × 90mm(D) × 70mm(H) About 0.47kg

4.6 Cleaning

Cover

Clean the cover with a cloth moistened with isopropyl alcohol, with a cloth dipped a water and synthetic detergent solution and squeezed dry, or with a dry cloth. If the second choice is used, be sure to squeeze as much water as possible out of the cloth. Detergent entering the holder can cause a failure.

If thinner, benzene, or other volatile solvent is used for cleaning, colors may change or letters may disappear.

Chapter 5 Multi charger

5.1 Outline

- Outline

When the TeamPad 400G Series HHC is mounted on a Multi charger, the HHC can be charged.

Four battery packs in HHCs can be charged at a time.

- Operation

FHTMA411W Multi charger does not have a power switch.

When a HHC with a battery is mounted, charging starts.

5.2 Component Names

The Multi charger can be set with two ways as shown below.

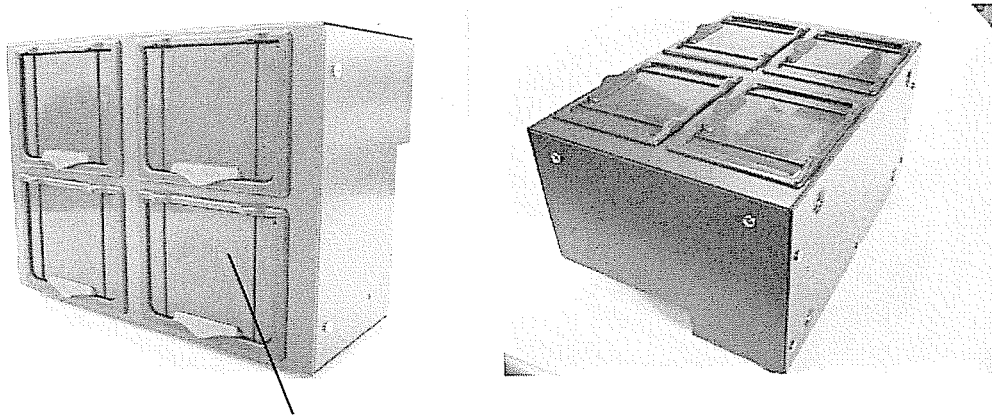

One unit with dustproof cover

Charge terminals

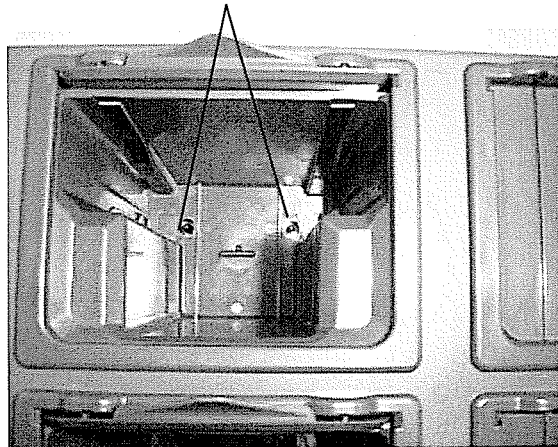

DC IN

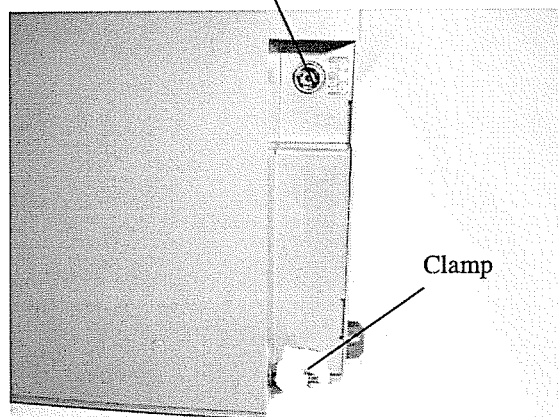

5.3 Connection

1. Connecting to a AC adapter

When connecting the Multi charger to a HHC, follow these steps:

- (1) Connect the AC adapter to the DC IN jack of Multi charger.

The AC adapter is not included with the package of the Multi charger. It should be purchased separately.

- (2) Fix a clamp attached the power cord to the Multi charger.

2. Connecting to a HHC

- (1) Open the dustproof cover of one unit that will be used.
- (2) Check that the charge terminals of the Multi charger and charge terminals of the HHC are not dirty.
- (3) Mount the HHC on the Multi charger as shown below.

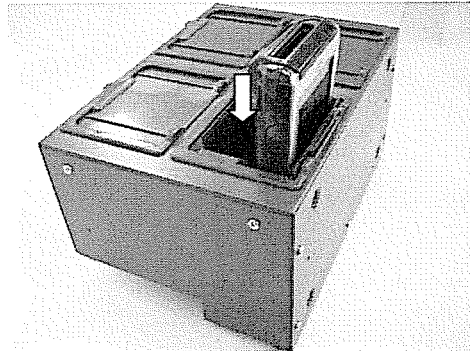
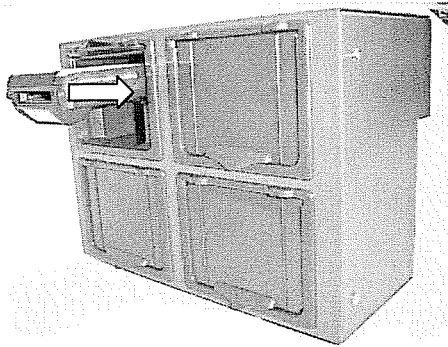

3. Connecting to four HHCs

Up to four HHCs can be charged together.

Mount the HHCs one by one as the same steps of connecting to a HHC described above.

Note

If the HHC to be mounted is wet, wipe off moisture completely with gauze. If a wet HHC is mounted on the Multi charger, a malfunction or failure may result.

5.4 Charging

1. Charging the HHC

When charging the HHC by this Multi charger, follow these steps:

- (1) HHC is mounted on the Multi charger.

The charge lamp of HHC lights up in orange during charge of a battery.

- (2) The charge will be completed for approximately 3 hours. The lamp will be changed to green when completed.

Note

While the HHC is on, the battery is not correctly charged.

Note

If the charging terminal is dirty, the battery may not be charged. Clean a dirty charging terminal using a cotton swab and a neutral detergent.

Note

When the Multi charger is not used, close the dustproof cover to protect the charge terminals from dust or dirt.

5.5 Specifications

Item		Specifications
Charging	Charging time	About 3 hours (1 cell)
Power supply		AC100-240V, 50/60Hz
Temperature and humidity	Operating temperature and humidity	0 to +40°C 10% to 90%RH
	Charging	0 to +40°C
	Storage temperature and humidity	-20 to +60°C 5% to 95%RH
Dimensions and weight		About 241mm(W) × 125mm(D) × 173mm(H) About 2.5kg

5.6 Cleaning

Cover

Clean the cover with a cloth moistened with isopropyl alcohol, with a cloth dipped a water and synthetic detergent solution and squeezed dry, or with a dry cloth. If the second choice is used, be sure to squeeze as much water as possible out of the cloth. Detergent entering the holder can cause a failure.

If thinner, benzene, or other volatile solvent is used for cleaning, colors may change or letters may disappear.

Chapter 6 USB adapter

6.1 Outline

Mounting the Team Pad 400G Series HHC on the USB adapter enables you to communicate with the host computer, as well as recharge its internal battery pack.

6.2 Component Names

Front View

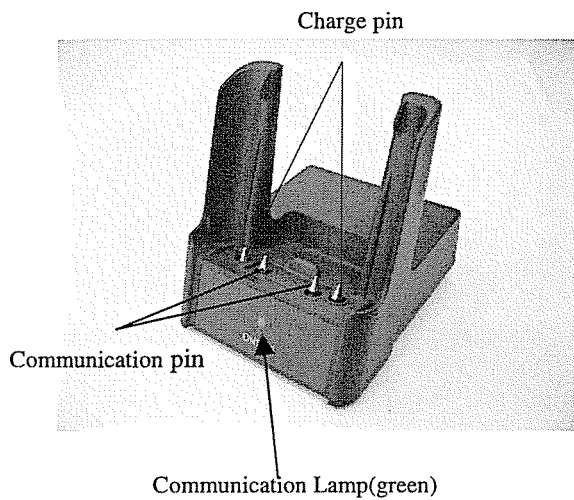

Back View

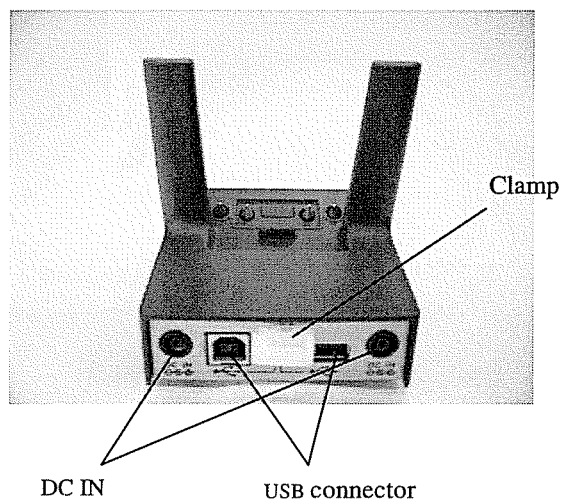

6.3 Operations Summary

Mount a battery-loaded HHC into the USB adapter, and battery recharging starts (with the charge lamp of HHC being illuminated).

The HHC, when put into a communication state, begins communicating with the host computer to which it is connected.

6.4 Connection

Follow the procedure stated below to connect the USB adapter with the master unit.

6.4.1 Connection with the AC Adapter.

1. Plug the power cord to the USB adapter.

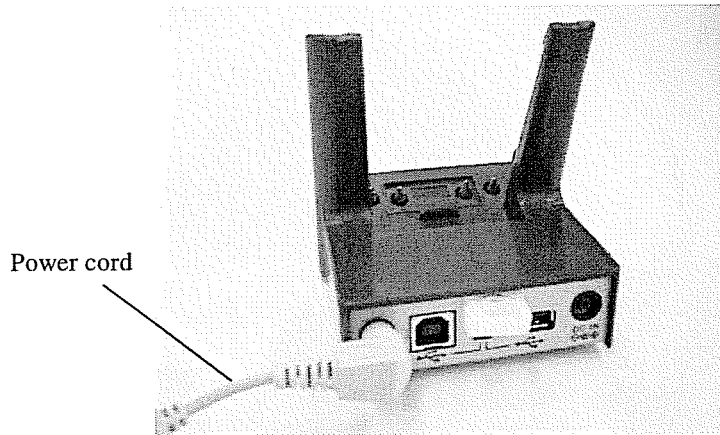

6.4.2 Connection with the USB cable

1. Attach the USB cable (FHTCB271) to the USB connector of the USB adapter.

The USB cable is not included with the package of the USB adapter. It should be purchased separately.

2. Fix a clamp attached the USB cable (FHTCB271) to the USB adapter.

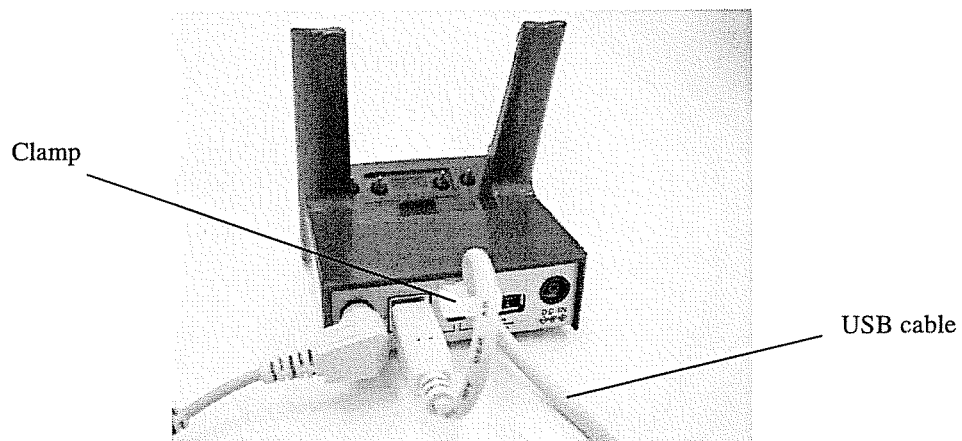

6.4.3 Connection with the Master Unit

1. Unplug the power cord of the USB adapter from the wall outlet and switch off the master unit.
2. Attach the USB cable (FHTCB271) to the USB connector of the master unit.
3. Plug the power cord of the USB adapter in a wall outlet and switch on the master unit after making sure that the cable connections are correct.

6.4.4 Connection with the HHC

1. Make sure that the communication pin of USB adapter and communication pin of the HHC are clean.
2. Hold the HHC with its control panel face toward you and slide it into the USB adapter toward the charge pins. The two units are now connected.

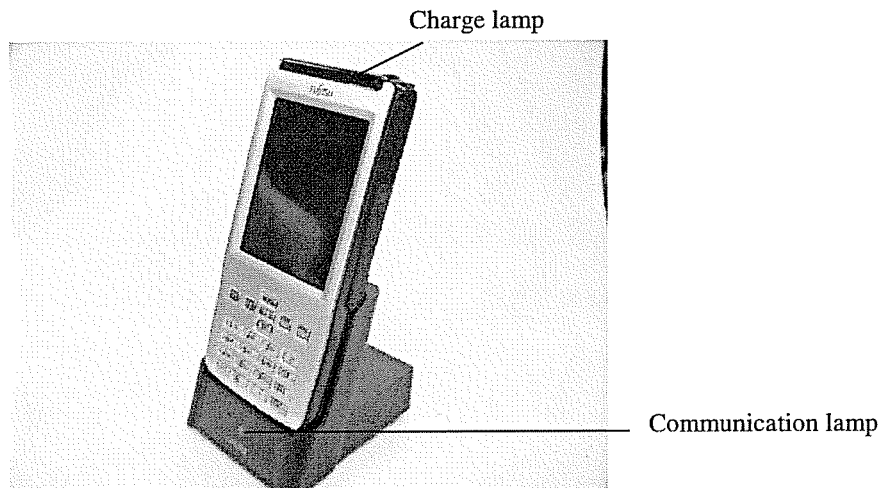

If the communication pins are dirty, the communication may fail. Wipe the communication pins with a cotton swab moistened with neutral detergent diluted with water.

6.5 Communication

1. Plug the USB adapter power cord in a wall outlet.
2. Insert it in the USB adapter, and Place the HHC in communication state.
The communication lamp on the USB adapter lights green during communication.
3. The communication lamp switches off when the communication ends normally.

NOTE

Data may be lost if the power cord of the USB adapter is unplugged from the wall outlet during communication.

Do not unplug the USB adapter power cord before communication ends.

WARNING

A communication error may not be detected if the HHC is removed from the USB adapter during communication, but it may become impossible to exit the communication-in-progress screen. This is not a failure.

Place the HHC back into the USB adapter promptly, or switch the HHC off and on again if this symptom occurs.

6.6 Recharging

Follow the procedure below by using the USB adapter to recharge the HHC.

- (1) Plug the USB adapter power cord in a wall outlet.
- (2) Confirm that the required is mounted.
- (3) Connect the HHC to the USB adapter, recharge begins.
- (4) The charge lamp lights orange during recharge.
- (5) The charge will be completed for approximately 3 hours. The lamp will be changed to green when completed.

NOTICE

Keep the HHC switched off during recharge.

NOTICE

It is impossible to charge its battery completely if the HHC is kept switched on during a recharge.

Specify that the handy terminal be switched off automatically if you want to start recharging after the end of communication.

NOTICE

A dirty charge pin may hamper a normal recharge. Clean any dirty charge pin with a cotton swab dampened with a neutral detergent solution.

NOTICE

Charge the battery at room temperature (10 to 30°C).

6.7 Specifications

Item		Specification
Communication interface	Connection condition	Contact pins
	Synchronization method	Asynchronous
Master unit side interface	Connection condition	USB 1.1 /12Mbps
	Synchronization method	Asynchronous
Communications indicator		Green LED illuminated for the duration of communication, off at a successful ending of the session of communication.
Charge function	Charge time	About 3 hours (1 cell)
Power supply		AC100 – 240 V, 50/60 Hz
Temperature	Operating	0°C to 40°C
	Charging	0°C to 40°C
	Storage	-10°C to 50°C
Humidity	Operating	10% to 90% RH
	Storage	5% to 95% RH
Dimensions		82(Wide) x 96 (deep) x 91 (high) mm
Weight		About 0.25 kg

Chapter 7 LAN adapter

7.1 Outline

Mounting the Team Pad 400G Series HHC on the LAN adapter enables you to communicate with the host computer, as well as recharge its internal battery pack.

7.2 Component Names

Front View

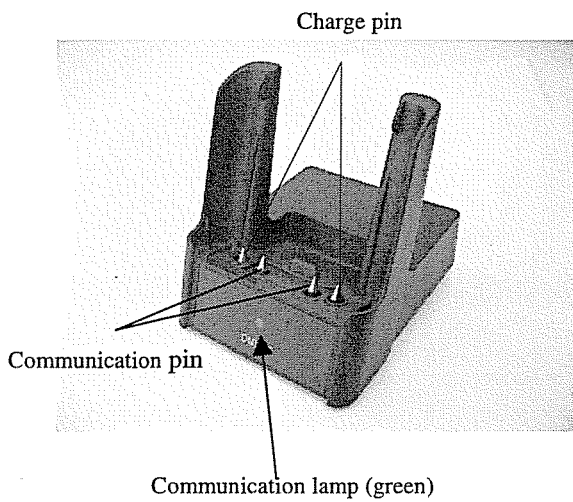

Back View

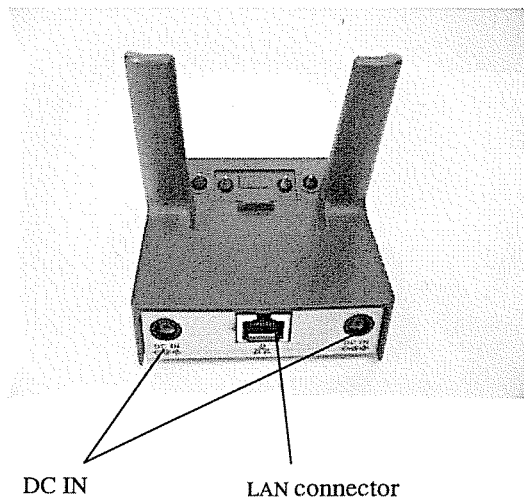

7.3 Operations Summary

Mount a battery-loaded HHC into the LAN adapter, and battery recharging starts (with the charge lamp of HHC being illuminated).

The HHC, when put into a communication state, begins communicating with the host computer to which it is connected.

7.4 Connection

Follow the procedure stated below to connect the LAN ADAPTER with the master unit.

7.4.1 Connection with the AC Adapter.

Plug the power cord to the LAN adapter

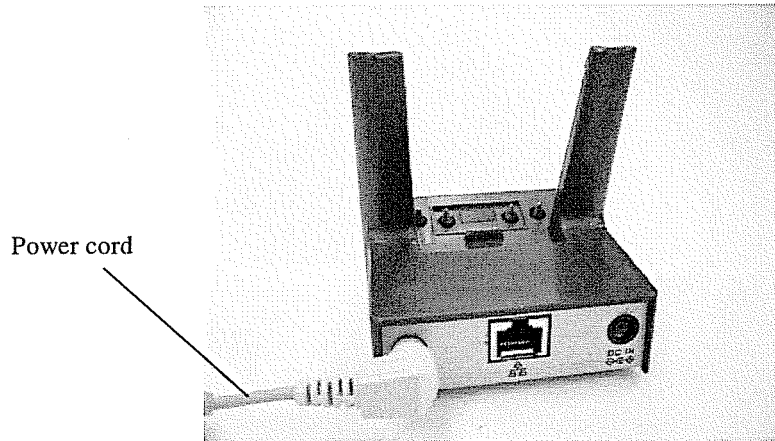

7.4.2 Connection with the LAN cable

Attach the LAN cable to the USB connector of the LAN adapter.

The LAN cable is not included with the package of the LAN adapter. It should be purchased separately.

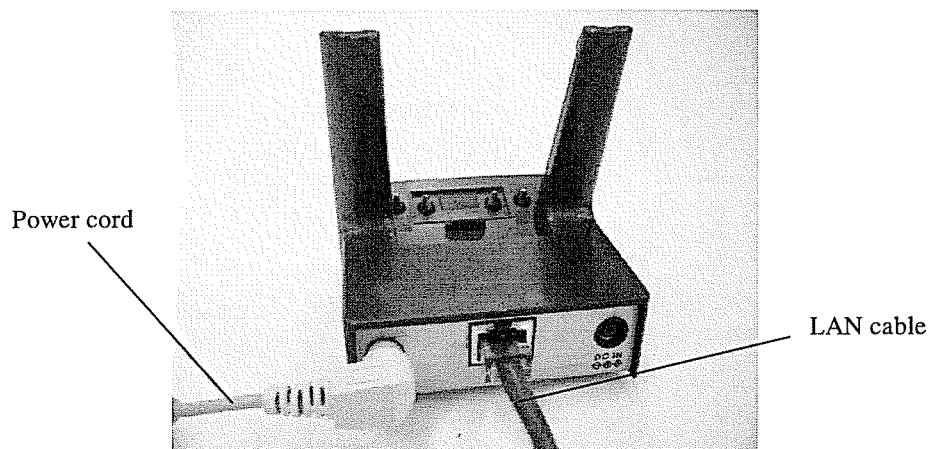

7.4.3 Connection with the Master Unit

1. Unplug the power cord of the LAN adapter from the wall outlet and switch off the master unit.
2. Attach the LAN cable to the LAN connector of the master unit.
3. Plug the power cord of the LAN adapter in a wall outlet and switch on the master unit after making sure that the cable connections are correct.

7.4.4 Connection with the HHC

1. Make sure that the communication pin of LAN adapter and communication pin of the HHC are clean.
2. Hold the HHC with its control panel face toward you and slide it into the LAN adapter toward the charge pins. The two units are now connected.

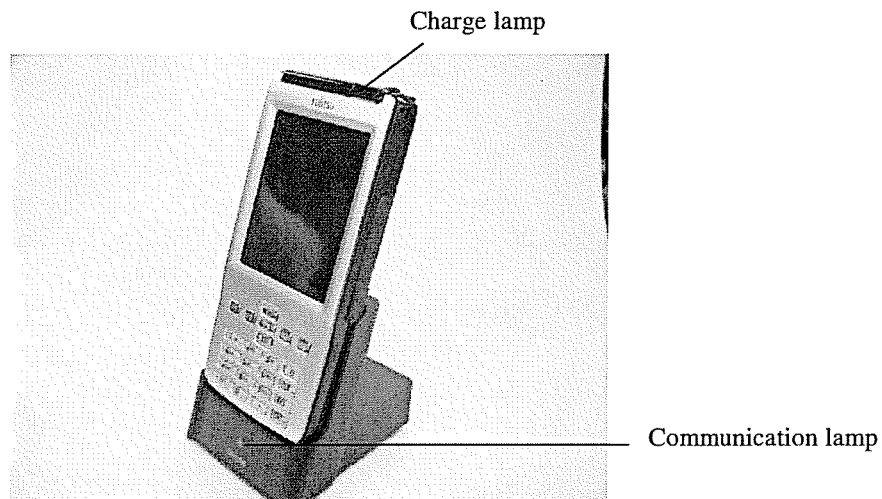

If the communication pins are dirty, the communication may fail. Wipe the communication pins with a cotton swab moistened with neutral detergent diluted with water.

7.5 Communication

1. Plug the LAN adapter power cord in a wall outlet.
2. Insert it in the LAN adapter, and Place the HHC in communication state.
The communication lamp on the LAN adapter lights green during communication.
3. The communication lamp switches off when the communication ends normally.

NOTE

Data may be lost if the power cord of the LAN adapter is unplugged from the wall outlet during communication.

Do not unplug the LAN adapter power cord before communication ends.

WARNING

A communication error may not be detected if the HHC is removed from the LAN adapter during communication, but it may become impossible to exit the communication-in-progress screen. This is not a failure.

Place the HHC back into the LAN adapter promptly, or switch the HHC off and on again if this symptom occurs.

7.6 Recharging

Follow the procedure below by using the LAN adapter to recharge the HHC.

- (1) Plug the LAN adapter power cord in a wall outlet.
- (2) Confirm that the required is mounted.
- (3) Connect the HHC to the LAN adapter, recharge begins.
- (4) The charge lamp lights orange during recharge.
- (5) The charge will be completed for approximately 3 hours. The lamp will be changed to green when completed.

NOTICE

Keep the HHC switched off during recharge.

NOTICE

It is impossible to charge its battery completely if the HHC is kept switched on during a recharge.

Specify that the handy terminal be switched off automatically if you want to start recharging after the end of communication.

NOTICE

A dirty charge pin may hamper a normal recharge. Clean any dirty charge pin with a cotton swab dampened with a neutral detergent solution.

NOTICE

Charge the battery at room temperature (10 to 30°C).

7.7 Specifications

Item		Specifications
HHC/LAN adapter interface (USB I/F)		USB 1.1/12Mbps
Host computer/LAN adapter interface (LAN I/F)		IEEE802.3/10BASE-T
Communications indicator		Green LED illuminated for the duration of communication, off at a successful ending of the session of communication.
Charge function	Charge time	About 3 hours (1cell)
Power supply		AC100 – 240 V, 50/60 Hz
Temperature	Operating	0 to +40°C
	Charging	0 to +40°C
	Storage	-20°C to +60°C
Humidity	Operating	10°C to 90%RH
	Storage	5 to 95%RH
Dimensions		82(W) × 96 (D) × 91 (H) mm
Weight		About 0.25kg

FUJITSU