



F-11C

INSTRUCTION MANUAL '11.X

docomo **SMART**series

DOCOMO W-CDMA, GSM/GPRS, Wireless LAN System

Thank you for purchasing "docomo SMART series F-11C" mobile terminal.

Before using F-11C, read this manual to ensure safe use and handling.

About manuals for F-11C

The operations of F-11C are described in this manual, "使いかたガイド (Guide)" (installed in FOMA terminal) and "Instruction manual (detailed version)" (in pdf format).

Instruction manual (this manual)

This manual provides information about screens and operations of basic functions.

"使いかたガイド (Guide)" (installed in FOMA terminal)





This guide provides overviews and operations of frequently-used functions. (In Japanese only)
In F-11C Stand-by display, **[MENU]** ▶ **[6]** Tool ▶ **[#]** Guide ▶ Select a search method

"Instruction manual (detailed version)" (in pdf format)

This manual provides detailed information and operations of all the functions. (In Japanese only)
<From a PC> This manual can be downloaded from NTT DOCOMO website.
<http://www.nttdocomo.co.jp/support/trouble/manual/download/index.html>
* The URL and contents are subject to change without prior notice.

- In this "F-11C INSTRUCTION MANUAL", "F-11C" mobile terminal is usually referred to as "FOMA terminal".
- The images or illustration used in this manual are examples. They may differ from the actual displays.
- The images used in this manual assume that Kisekai Tool is set to "White" and Color theme setting is set to "White".
- In this manual, "authenticate" indicates the operating procedure for entering the terminal security code in 4-8 digits (⇒P41) or performing fingerprint authentication.

Basic package

<p>F-11C (including Back Cover F6Z and warranty)</p>		<p>Battery Pack F19</p> 	<p>Desktop Holder F33</p>  <p>Desktop Holder F33 is made of recycled ABS from used products.</p> 	<p>Instruction manual</p> 
Compatible options ⇒PXX				

- Unauthorized copying of parts of or this entire manual is prohibited.
- The contents in this manual, URL and contents are subject to change without prior notice.

Contents

FOMA terminal 2 What you can do with F-11C 3 Part names and functions 4 Usage styles 6	Precautions (Always follow these directions) 7 Handling precautions 16 Waterproof/Dustproof function 21	Introduction
Before Using 26 Screen Explanation 29 Character Entry 33	Sound/Screen Setting 36 Lock/Security 41	Basic Operation
Call Telephone 47 Mail 56 Phonebook 60		Connect
i-mode/Full Browser/Smart Browser 62 i-Channel 64		Search
Camera 67 1Seg 69 Music 71	i-appli 73 i-motion/Movie 74	Enjoy
Osaifu-Keitai 75 i-concier 76 Convenient tools 77	Data Management 81	More Convenient
Support 87 Appendix 94 Index 112		Others

FOMA terminal

- Because your FOMA terminal uses wireless transmission, it may not function in locations where it is difficult for radio waves to penetrate, such as tunnels, underground passages and some buildings, in areas where radio waves are weak, or out of service area. Even when you are high up in a tall building or condominium and nothing blocks your view outside, your FOMA terminal may not be able to receive or transmit signals. Also, communication may be interrupted even when the signal meter on your FOMA terminal indicates there are strong radio waves and you are not moving (traveling).
- Use your FOMA terminal in a way that does not disturb others in public spaces, crowded locations or quiet places.
- Because your FOMA terminal uses radio waves to communicate, it is possible that a third party may attempt to tap your calls. However, the W-CDMA, GSM/GPRS, Wireless LAN system automatically applies a confidential communication function to all calls, so even if a third party could somehow tap a call, they only hear noise.
- Your FOMA terminal encodes voice communication as digital data. When you are operating your FOMA terminal while moving to a location subject to weaker radio wave conditions, the transmitted digital data may not be correctly decoded and as a result the decoded voice may differ somewhat from the actual voice.
- Maintain a separate record of the data (Phonebook, Schedule, Memo, Recorded messages, Voice memos, Moving picture memos, etc.) you registered in your FOMA terminal. Note that DOCOMO assumes no responsibility for any loss of saved contents of data resulting from malfunction, repair, changing of the model or other handling of FOMA terminal.
- You are recommended to save important data to microSD card. Using DOCOMO keitai datalink, you can transfer and save phonebook, mail, schedule and other data to a PC.
- The user hereby agrees that the user shall be solely responsible for the result of the use of SSL/TLS. Neither DOCOMO nor the certifier as listed herein makes any representation and warranty as for the security in the use of SSL/TLS. If the data should be erased, DOCOMO assumes no responsibility for the loss of any data.
Certifier : VeriSign Japan K.K., Cybertrust Japan Co., Ltd., GlobalSign K.K., RSA Security Japan Ltd., SECOM Trust Systems Co., Ltd., Comodo CA Ltd., Entrust, Inc., Go Daddy, Inc.
- This FOMA terminal supports FOMA Plus-Area and FOMA HIGH-SPEED Area.
- FOMA terminal can be used only via the FOMA network provided by DOCOMO and DOCOMO's roaming area.

What you can do with F-11C

Waterproofness/Dustproofness 21

Waterproofness of IPX5 and IPX8 and dustproofness of IP5X are provided by firmly closing the external connection jack cap and installing the back cover in a locked state.

Quick voice activation 32

Just speaking a keyword of function you want to use activates the function. It is useful when you do not know where is a desired function in the menu or when you want to activate the function immediately.

使いかたガイド (Guide) 32

Without the instruction manual at your hand, you can check readily the operations of function you want to use. By searching from the function list or entering a keyword, you can view the outline or operation for the function and also activate the function. (In Japanese only)

Smart Browser 62

WebKit, adopted by Smartphone etc., enables to view contents on the Internet comfortably by touch operation.

i-concier 76

It is a service that Machi-chara (a character on the stand-by display) supports your life like a butler or concierge. It stores your various information (area of residence, memo, schedule, ToruCa, phonebook, etc.) and offers you information that matches contents of Memo or Schedule, your living area or current location, or preferences and interest at the right time. (In Japanese only)





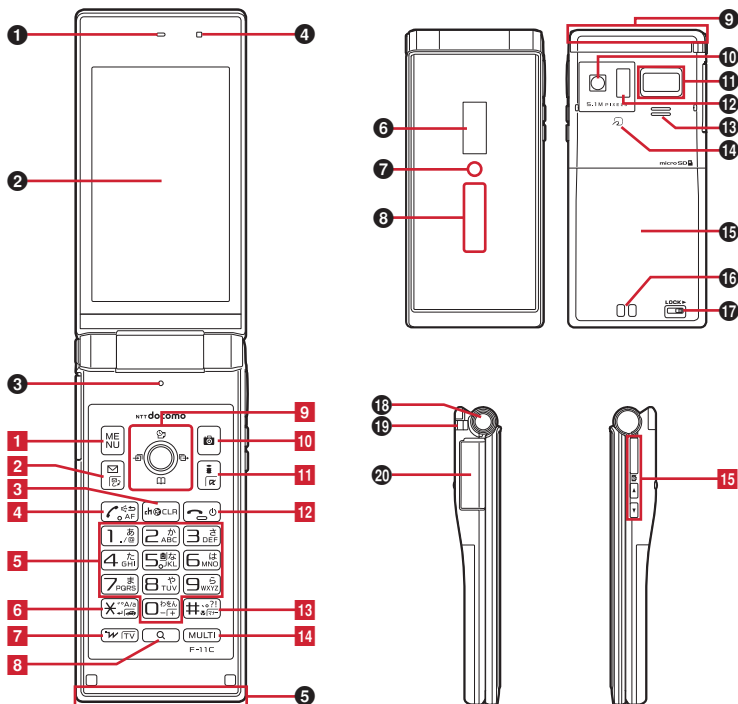

















Part names and functions

Part names of F-11C and major functions assigned to each part are as follows.



To use the function with *, press the key for 1 second or more.

- ① Earpiece
- ② Display
- ③ Microphone for calling and recording
- ④ Light sensor for sensing the ambient lightness to adjust the brightness of the display
- ⑤ 1Seg antenna used for 1Seg watching
- ⑥ Sub-display
- ⑦ Charging light
- ⑧ Light for opening/closing FOMA terminal, using camera, etc.
- ⑨ FOMA antenna is built-in
- ⑩ Camera
- ⑪ Fingerprint sensor for registering fingerprint and authentication
- ⑫ Infrared data port for infrared communication or infrared remote control function
- ⑬ Speaker
- ⑭  mark for placing over IC card reader for Osaifu-Keitai and iC transmission
- ⑮ Back cover
- ⑯ Charging jack
- ⑰ Back cover lever
- ⑱ Open assist button
- ⑲ Strap opening
- ⑳ Jack for charger, earphone, etc.

- 1  Display the menu
- 2  Display the mail menu, switch text input modes or check new mail/message*
- 3  Display i-Channel or return to the previous screen
- 4  Start voice call, switch to hands-free call or perform quick voice activation*
- 5  -  Enter phone number or characters, or select menu item
- 6  Enter "*" or voiced/semi-voiced sound, or start/cancel Public mode (Drive mode)*
- 7  Start/Exit i-Widget, or watch 1Seg*
- 8  (Search key) Activate Quick search/i-mode voice search*
- 9  Multi-cursor key for moving the cursor
 -  : Perform an operation
 -  : Display Schedule, or adjust sound volume
 -  : Display Phonebook, adjust sound volume or add a phonebook entry*
 -  : Display Received calls
 -  : Display Redial or start/cancel IC card lock*
- 10  Start the still camera shooting*
- 11  Display iMenu or i-appli folder*
- 12  Exit a running function, or turn ON/OFF the FOMA terminal by pressing for 2 seconds or more
- 13  Enter "#" or punctuation, or start/cancel Silent mode*
- 14  Multitask key for starting another function during a call or operation, or start/cancel Privacy view*
- 15 Side keys
 -  Record video, start the still camera shooting and operate Music player
 -  Stop the ring alert, vibrator or adjust sound volume
 -  Mail/message inquiry, adjust sound volume, and activate High-pitched alarm

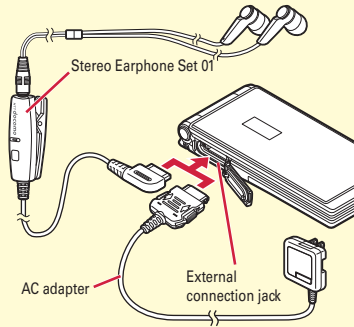

**Connection of Stereo Earphone Set 01 (Optional)
for external connection jack**

* AC adapter uses a common jack.









Precautions (Always follow these directions)

- Before using your FOMA terminal, or when necessary, read the precautions below to ensure safe use and handling. After reading this manual, keep it carefully.
- These precautions are intended to protect you and others around you. Read and follow them carefully to avoid injury, damage to the product or damage to property.
- The signs below differentiate between the levels of danger that can occur if the product is not used within the specified guidelines.

 DANGER	This sign denotes that death or serious injury may directly result from improper use.
 WARNING	This sign denotes that death or serious injury may result from improper use.
 CAUTION	This sign denotes that minor injury or damage to property may result from improper use.

- The symbols below show specific directions.

 Don't	This symbol denotes that the action is prohibited.
 No disassembly	This symbol denotes that disassembling the phone or its components is not allowed.

 No wet hands	This symbol denotes that using the phone or its components with wet hands is not allowed.
 No liquids	This symbol denotes that using the phone or its components in a bathroom or other highly humid area is not allowed.
 Do	This symbol denotes that an instruction must be obeyed at all times.
 Unplug	This symbol denotes that the equipment should be unplugged.

■ Precautions contain the description below.

Handling FOMA terminal, battery pack, adapter, desktop holder and UIM (common)	8
Handling FOMA terminal	9
Handling battery pack	11
Handling adapter and desktop holder	12
Handling UIM	13
Handling mobile phones near electronic medical equipment.....	13

Handling FOMA terminal, battery pack, adapter, desktop holder and UIM (common)

DANGER



Don't

Do not use, store, or leave the equipment in hot areas such as near flames or in areas under strong direct sunlight such as inside a vehicle.

May cause fire, burns or injuries.



Don't

Do not put the terminal into heating cooking device such as microwave oven or high-pressure container.

May cause fire, burns, injuries, electric shock.



No disassembly

Do not disassemble or remodel the equipment.

May cause fire, burns, injuries, electric shock.



No liquids

Do not let the terminal get wet with water, drinking water, urine of pet animals, etc.

May cause fire, burns, injuries, electric shock.
For waterproofness, refer to ⇒P21



Do

Use the battery pack and adapter specified by NTT DOCOMO for your FOMA terminal.

May cause fire, burns, injuries, electric shock.

WARNING



Don't

Do not throw the equipment or give hard shock to it.

May cause fire, burns, injuries, electric shock.



Don't

Keep conductive materials (metal pieces, pencil lead, etc.) from coming in contact with the charging jack or external connection jack. Do not put those materials inside the terminal.

May cause fire, burns, injuries, electric shock.



Don't

Do not cover or wrap the terminal with a blanket, etc while using or charging.

May cause fire or burns.



Do

Turn FOMA terminal OFF and stop charging before entering a place such as a gas station where flammable gases are generated.

The gas may catch fire.

When using Osaifu-Keitai in a place as a gas station, turn OFF the terminal before using it. (When IC card lock is activated, deactivate it before turning OFF the terminal.)



Do

If the equipment starts giving off a strange smell, overheats, becomes discolored or deformed during use, charging or in storage, immediately perform the following operations.

- Remove the power plug from the wall outlet or cigarette lighter socket.
- Turn FOMA terminal OFF.
- Remove the battery pack from FOMA terminal.

Failure to do so may cause fire, burns, injuries, electric shock.

CAUTION



Don't

Do not leave the equipment on unstable or sloping surfaces.

May cause injuries.



Don't

Do not store the equipment in extremely humid, dusty or hot areas.

May cause fire, burns, electric shock.



Do

Children using the equipment should be instructed in proper operation by an adult. Do not allow them to use the equipment without adult supervision.
May cause injuries.



Do

Store the equipment out of reach of small children.
May be accidentally swallowed or cause injuries.



Do

Be careful especially when using FOMA terminal connected to the adapter continuously for a long time.
If you use i-αppli, a videophone call or 1Seg watching while charging the battery for a long time, FOMA terminal, battery pack and adapter may be heated.
Directly touching a hot part for a long time, you may have redness, itching or rash on your skin, or it may result in low-temperature burns depending on your constitution and/or health condition.

Handling FOMA terminal



WARNING



Don't

Do not direct the infrared data port toward your eye and transmit signals.
May cause harmful effect on eyes.



Don't

Do not direct the infrared data port toward home electric appliances etc. equipped with infrared device when using infrared communication.
May cause an accident because of malfunction of infrared device.



Don't

Do not turn on the light by getting the lighting part closer to other person's eyes.
May impair eyesight. And may cause accidents like injury etc., by dazzling or astounding other people.



Don't

Do not put foreign objects such as liquid like water, metal pieces or burnable things into UIM or microSD card slot.
May cause fire, burns, injuries, electric shock.



Don't

Do not turn on the light aiming directly at the driver of the car etc.
May disturb driving and cause an accident.



Do

Turn FOMA terminal OFF in areas where use is prohibited, such as in airplanes and hospitals.

Failure to do so may cause electronic equipment or electronic medical equipment to fail or malfunction. If the function which automatically turns the power ON is set, cancel the setting before turning the power OFF.
When using the phone in a medical facility, be sure to observe the regulations of the facility. If you do prohibited act such as using the phone in an airplane, you will be punished according to law.



Do

When you talk by setting handsfree or ring alert is sounding, keep FOMA terminal away from your ear.
And, when connecting the earphone/microphone etc. to the FOMA terminal and play a game or music, adjust the volume moderately.
Too loud volume may cause a hearing loss. And, if you cannot hear the sound around you clearly, it may cause an accident.



Do

If you have weak heart, be careful when setting the Vibrate alert (vibration) or alert volume setting.

May cause harmful effect on heart.



Do

When you use electronic medical equipment, check with the equipment manufacturer to determine how the device is affected by radio waves before using.

May cause harmful effect on electronic medical equipment etc.



Do

Turn FOMA terminal OFF near high-precision electronic control equipment or electronic equipment using low-power signals.

Failure to do so may cause the equipment to fail or malfunction.

* Examples of electronic equipment to avoid.

Hearing aids, implanted pacemakers or defibrillators, other electronic medical equipment, fire alarms, automatic doors and other automatic control equipment.

Users wearing implanted pacemakers or defibrillators or other electronic medical equipment should check with the manufacturer or sales outlet about the effect of radio frequencies on the equipment.



Do

When the display or camera lens is accidentally broken, be careful of broken glass or exposed internal parts of FOMA terminal.

Surfaces of display and camera lens are made of plastic panels and they are structured for the glass not to scatter, however, if you mistakenly touch broken or exposed parts, you may be injured.



Do

To sound the high-pitched alarm, always keep FOMA terminal away from your ears.

Failure to do so may cause hearing defect.

CAUTION



Don't

Do not swing FOMA terminal by antenna or its strap.

May cause accident such as injury to yourself or others by hitting.



Don't

Do not use damaged FOMA terminal.

May cause fire, burns, injuries, electric shock.



Don't

When using the motion tracking or motion sensor, check the safety around you, hold FOMA terminal firmly, and do not shake it unnecessarily.

May cause accident such as injuries.



Don't

If the display part is accidentally broken and the liquid crystal leaks out, do not make the substance contact with your skin of face or hands.

May cause loss of sight or skin problems.

If the liquid crystal gets into your eyes or mouth, rinse it with clean water and see a doctor immediately.

And, if the liquid adheres to skin or clothing, use alcohol etc. to wipe it off, then wash with soap.



Do

To use the terminal in car, check with automobile manufacturer or dealer to determine how the device is affected by radio waves before using.

In rare cases, using the phone in some vehicle models can cause the vehicle's electronic equipment to malfunction. In that case, stop using the terminal immediately.



Do

Mobile phones can give some users skin problems such as itching, allergic reactions or rashes. If you develop skin problems, stop using the phone immediately, and see a doctor.→ "Material list (P14)"



Do

When opening or closing FOMA terminal, take care not to have your fingers or strap caught by the terminal.
May cause accident such as injuries.



Do

When watching the display, take a certain distance from the display in a fully bright place.
May reduce visual acuity.

Handling battery pack

- Check that the battery type matches the type displayed on the battery pack label.

Display	Battery type
Li-ion 00	Li-ion battery



DANGER



Don't

Do not connect a wire or other metal objects to the jack. And, do not carry or store FOMA terminal with objects like a metal necklace.

May cause the battery pack to ignite, burst, heat or leak.



Don't

Check the orientation of battery pack to install it to FOMA terminal, and do not try to force the battery pack onto FOMA terminal if you are having trouble installing it.

May cause battery pack to ignite, burst, heat or leak.



Don't

Do not throw the battery pack into the fire.

May cause battery pack to ignite, burst, heat or leak.



Don't

Do not nail the battery pack, hit with a hammer or step on it.

May cause battery pack to ignite, burst, heat or leak.



Do

If the battery pack's fluid etc. contacts eyes, immediately flush the eyes with clean water and see a doctor right away. Do not rub the eyes.

May cause loss of sight.



WARNING



Don't

If the battery pack seems to have abnormalities such as deformation or scratches due to falling, never use it.

May cause battery pack to ignite, burst, heat or leak.



Do

If the battery pack leaks or gives off a strange smell, immediately remove it from the vicinity of open flames.

The vapors from leaking battery pack fluid may ignite or explode.



Do

Be careful not to let your pet bite the battery pack.

May cause battery pack to ignite, burst, heat or leak.



CAUTION



Don't

Do not discard old battery packs together with other garbage.

May cause igniting or environmental destruction. Tape the terminals of old battery packs to insulate them, and then bring them into a sales outlet such as docomo Shop. If your local municipality has a battery recycling program, dispose of them as provided for.



Don't

Do not use or charge a wet battery pack.
May cause battery pack to ignite, burst, heat or leak.



Do

If fluid etc. leaks out from the battery pack, do not make the fluid contact with your skin of face or hands.

May cause loss of sight or skin problems.
If the fluid etc. put into your eyes or mouth, or contacts skin or clothes, immediately flush the contacted area with clean water.
If the fluid put into the eyes or mouth, immediately see a doctor after flushing.

Handling adapter and desktop holder

WARNING



Don't

Do not use the adapter cord if it gets damaged.

May cause fire, burns, electric shock.



Don't

Do not use the AC adapter or desktop holder in a bathroom or other highly humid area.

May cause fire, burns, electric shock.



Don't

Always use the DC adapter with a negative-ground vehicle. Do not plug it into a positive-ground vehicle.

May cause fire, burns, electric shock.



Don't

When it starts to thunder, do not touch adapter.

May cause electric shock.



Don't

Do not short the charging jack while it is connected to the outlet or cigarette lighter socket. Do not touch the charging jack with a part of your body such as your hand or finger.

May cause fire, burns, electric shock.



Don't

Do not place heavy objects on the adapter cord.

May cause fire, burns, electric shock.



Don't

When you insert and remove AC adapter from power outlet, do not contact a metal strap or other metal objects with the jack.

May cause fire, burns, electric shock.



No wet hands

Do not touch the adapter cord, desktop holder or outlet with wet hands.

May cause fire, burns, electric shock.



Do

Only use with the specified power source and voltage.

When charging FOMA terminal overseas, use AC Adapter for global use.
If incorrect voltage is used, this may cause fire, burns or electric shock.

AC adapter : AC100V
DC adapter : 12 or 24V DC (specific for negative ground vehicle)
AC adapter for global use : Between 100V and 240V AC (Connect to the AC outlet for internal household use)



Do

If the DC adapter's fuse blows, replace it only with the specified fuse.

May cause fire, burns, electric shock. For the specified fuse, see the instructions that come with the DC adapter.



Do

Wipe off any dust that accumulates on the power plug.

Failure to do so may cause fire, burns, electric shock.



When you connect the AC adapter to an outlet, firmly connect to the outlet.

Do

Failure to do so may cause fire, burns, electric shock.



When you disconnect the adapter from the outlet or cigarette lighter socket, do not pull the adapter cord with excessive force. Instead, hold the power plug to disconnect.

Do

May cause fire, burns, electric shock.



Unplug

Always remove the power plug from the outlet or cigarette lighter when not using the adapter for an extended period.

Failure to do so may cause fire, burns, electric shock.



Unplug

Immediately remove the power plug from the outlet or cigarette lighter socket if water or other fluids get into the adapter.

Failure to do so may cause fire, burns, electric shock.



Unplug

Always remove the power plug from the cigarette lighter socket when cleaning the equipment.

Failure to do so may cause fire, burns, electric shock.

Handling UIM



CAUTION



Do

Be careful of the cut surface when removing UIM.

May cause injuries.

Handling mobile phones near electronic medical equipment

These precautions are based on the guidelines produced at the Electromagnetic Compatibility Conference Japan, regarding the protection of electronic medical equipment from radio waves emitted by mobile phone units.



WARNING



Do

Obey the following rules inside medical facilities.

- Do not bring FOMA terminal into operating rooms (ORs), intensive care units (ICUs) or coronary care units (CCUs).
- Turn FOMA terminal OFF in hospital wards.
- Turn FOMA terminal OFF in hospital lobbies and corridors if electronic medical equipment could be nearby.
- If the medical facility has specified zones where use or possession of mobile devices is prohibited, obey those instructions.
- If the function to automatically turn ON the power is set, cancel the setting before turning the power OFF.



Do

Turn FOMA terminal OFF in crowded trains or other public places where pacemaker or defibrillator wearers could be nearby.

FOMA terminal's signals may affect the operation of implanted pacemakers or defibrillators, and other devices.



Do

Wearers of implanted pacemakers or defibrillators must carry and use FOMA terminal at least 22 cm away from the implanted device.

FOMA terminal's signals may affect the operation of implanted pacemakers or defibrillators, and other devices.



Do

When electronic medical equipment other than implanted pacemakers or defibrillators are in use outside of medical facilities (such as in home care settings), check with the device manufacturer to determine how the device is affected by electrical signals.
FOMA terminal's signals may affect the performance of electronic medical equipment.

Material list

Part		Material	Surface treatment
Exterior case	Movable part Display	PC resin	UV hard coating
	Movable part Rear surface	PA-GF resin	UV hard coating
	Fixed part Keypad	PA-GF resin	UV hard coating
	Fixed part Battery	PC+ABS resin	UV hard coating
	Back cover	PC+ABS resin	UV hard coating
	Back cover lock lever	POM resin	None
	Back cover lock plate	Stainless steel	None
	Back cover (body)	Stainless steel	None
	Back cover (gasket)	Silicon rubber	None
Display panel		Hardened glass	Shatterproof film

Part		Material	Surface treatment
Camera lens	Camera panel	High heat resistance transparent material (シルプラス®)	UV hard coating
	Camera ring (Color: BLACK, RED)	ABS resin	Chrome-plating
	Camera ring (Color: WHITE)	Acrylate resin	None
Light lens		PC resin	None
Side keys		PC resin	UV hard coating
Keypad		PC resin	UV hard coating
External connection jack cap	Body	PC resin	UV hard coating
	Flexure	Elastomer resin (TPE)	None
	Water stop	PC resin	None
	Water stop rubber	Silicon rubber	None
Charging jack	Contacts	Stainless steel	Gold plating
	Attaching holder section	LCP resin	None
External connection jack		Stainless steel	Tin plating
Facing sheet around keypad		PET resin	UV hard coating

Part		Material	Surface treatment
Movable part/Rear surface	Facing panel	ABS resin	UV hard coating
	Corner pad	Elastomer resin (TPEE)	None
	Screw sheet	Polyester film	None
Screw (battery install recess)		Stainless steel	None
Battery install recess face		PC board	Gold plating
Battery contacts	Battery contacts connector	PPS resin	None
	Battery contacts	Beryllium copper	Gold plating (base : Ni-Pd plating)
Battery pack	Battery pack	PC resin	None
	Contacts	Beryllium copper	Gold plating
Fingerprint sensor		Flexible PC board	None
UIM tray		POM resin	None

Handling precautions

General

- **F-11C is waterproof/dustproof, however, do not allow water or dust to seep into FOMA terminal and do not allow accessories or optional devices to get wet or let dust attach.**
 - Battery pack, adapter, UIM are not waterproof/dustproof. Do not use in a bathroom or other highly humid area or do not let rain attach. Or putting the terminal on your body, humidity of sweat may cause internal corrosion and malfunction. Note that malfunctions, which are determined to be caused by water as result of inspections, are not covered by the warranty. Since these conditions are outside the scope of the warranty, a repair, if at all possible, is charged.
- **Clean FOMA terminal with a dry soft cloth (such as a cloth for eyeglasses).**
 - Rubbing it roughly with a dry cloth may scratch the display.
 - Drops of water or dirt left on the display may cause stains.
 - If FOMA terminal is wiped with alcohol, paint thinner, benzene or detergent, the printing may disappear or color may fade.
- **Clean the jack occasionally with a dry cotton swab etc.**
 - If the jack is soiled, connection gets worse and it may cause power to be turned off or insufficient battery charge, so clean the jack with a dry cotton swab etc. Also, be careful never to damage the jack when cleaning it.
- **Do not place FOMA terminal near an air-conditioner outlet.**
 - The rapid change in temperature may cause condensation, causing internal corrosion and malfunction.

- **When using, be careful not to subject excessive force to FOMA terminal or the battery.**
 - If FOMA terminal is crammed into a brimming bag or placed in a pocket and sat on, display, internal PCBs or battery pack may be damaged or malfunction. And, if external devices are plugged into the external connection jack (earphone/microphone jack), the breakage of the connector or malfunction may result.
- **Do not rub or scrape the display with a metal piece etc.**
 - It may scratch the display, causing malfunction or damage.
- **Carefully read the separate instructions that come with the battery pack and adapter.**

FOMA terminal

- **Do not press the surface of the touch panel strongly or operate it with sharp objects such as a nail, a ballpoint pen and a pin.**
 - It may damage the touch panel.
- **Avoid extreme temperature.**
 - Use FOMA terminal where the temperature ranges between 5 and 40°C (limited to the temporary use in a bathroom etc. when temperature is above 36°C) and humidity ranges between 45 and 85%.
- **FOMA terminal may affect land-line phones, TVs or radios in use nearby, so use it as far as possible from these appliances.**
- **Maintain a separate record of the data you saved in your FOMA terminal.**
 - If the data is deleted, DOCOMO assumes no responsibility for the loss of any data.
- **Do not drop FOMA terminal or subject it to shocks.**
 - May cause malfunction or damage.
- **Do not plug external devices into the external connection jack (earphone/microphone jack) at a slant, or do not pull it forcibly while it is plugged.**
 - May cause malfunction or damage.

- **Do not close FOMA terminal with the strap etc. held inside.**
 - May cause malfunction or damage.
- **It is normal for FOMA terminal to become warm during use or charging. Continue to use it.**
- **Do not leave FOMA terminal with the camera in areas under strong direct sunlight.**
 - May cause discoloring or burn-in of materials.
- **Use FOMA terminal with the external connection jack cap closed.**
 - Dust and/or water brought into FOMA terminal cause troubles.
- **Do not use FOMA terminal with the back cover removed.**
 - May cause removal of battery pack, malfunction or damage.
- **Do not put extreme thick sticker on the keypad face.**
 - May cause malfunction, damage or erroneous operation.
- **Do not put label or sticker on the back side of display.**
 - Label or sticker may be hooked when opening/closing FOMA terminal and may cause malfunction or damage.
- **Do not rotate the display with FOMA terminal closed.**
 - It may scratch the part around the display and keypad, and it may cause malfunction or damage.
- **Do not put strong impact on the fingerprint sensor or scratch its surface.**
 - It may cause malfunction of fingerprint sensor and disable authentication operation.
- **Clean the fingerprint sensor with a dry soft cloth (such as a cloth for eyeglasses).**
 - If the fingerprint sensor is dirty or water is sit on its surface, the sensor cannot read fingerprints, and it may cause decrease authentication performance or malfunction.
- **While microSD card is being used, do not take the card out and do not turn off FOMA terminal.**
 - May cause data loss or malfunction.

- **Do not bring magnetic cards etc. close to FOMA terminal nor clip it by FOMA terminal.**
 - Magnetic data in cash cards, credit cards, telephone cards, floppy disks, etc. may be erased.
- **Do not bring magnetized objects close to FOMA terminal.**
 - Bringing strong magnetism close may cause a malfunction.

Battery pack

- **The battery pack is a consumable part.**
 - Replace the battery pack if FOMA terminal has extremely short operation time on a full charge, though it may vary by operating conditions. Purchase a new battery pack of the specified type.
- **Charge the battery in an area within the proper ambient temperature range (5-35°C).**
- **The operation time provided by the battery pack varies by the operating environment and battery pack's deterioration.**
- **The battery pack may swell out as it comes to near the end of its lifetime depending on the usage conditions, but it is not a problem.**
- **Be careful especially about the following points when preserving the battery pack.**
 - Keeping under the state of the full charge (right after charging ends)
 - Keeping under the state of the empty charge (too exhausted to turn on FOMA terminal)

They may cause the battery pack performance to be degraded or its lifetime to be shortened.

A recommended battery level to keep the battery pack is the battery icon in 2 cells or in 40 % of remaining battery level as a guide.

Adapter

- Charge the battery in an area within the proper ambient temperature range (5-35°C).
- Do not charge the battery in the areas below.
 - In areas of excessive humidity, dust or vibrations
 - Near land-line phones or TVs/radios
- It is normal for the adapter to become hot while charging. Continue to use it.
- When using the DC adapter for charging, keep the vehicle engine running.
 - The vehicle's battery could become flat.
- When using an outlet with a mechanism preventing unplugging, follow the handling instructions for that outlet.
- Do not give strong shock. Do not deform the charging jack.
 - Doing so may cause malfunction.

UIM

- Do not use excessive force to install/remove UIM.
- Note that DOCOMO assumes no responsibility for malfunctions occurring as the result of inserting and using UIM with another IC card reader/writer.
- Always keep UIM ICs clean.
- Clean UIM with a soft, dry cloth (such as a cloth for eyeglasses).
- Maintain a separate record of the data you saved in UIM.
 - If the data is deleted, DOCOMO assumes no responsibility for the loss of any data.
- To preserve the environment, bring the old UIM to a sales outlet such as docomo Shop.
- Take care not to scratch, touch accidentally or short IC.
 - May cause data loss or malfunction.
- Do not drop UIM or subject it to shocks.
 - May cause malfunction.
- Do not bend UIM or place heavy objects on it.
 - May cause malfunction.
- Do not install UIM into FOMA terminal with a label or sticker put on.
 - May cause malfunction.

Bluetooth® devices

- This FOMA terminal is equipped with the security features, that are compliant with Bluetooth standards for communication via Bluetooth. However, depending on the settings, there may not be enough security. Be aware of security risks when using Bluetooth.
- DOCOMO assumes no responsibility for any information which may be leaked during communication via Bluetooth.
- You can use headset, handsfree, audio, keyboard, dial-up connection, data transfer, serial port, image transfer or health devices with FOMA terminal. An audio/video remote control may be available with an audio device (only Bluetooth compatible devices).
- Frequency bands
 - Frequency bands used by FOMA terminal Bluetooth function are as below.

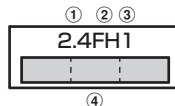

- ① 2.4 : Radio equipment that uses the 2400 MHz band.
- ② FH : The modulation is the FH-SS method.
- ③ 1 : The expected interference distance is 10 m or shorter.
- ④  : All bandwidths between 2400 MHz and 2483.5 MHz are used, and the bandwidth used by mobile object identification devices cannot be avoided.



Cautions on using Bluetooth devices

In the bandwidth used by this terminal, in addition to home electric appliances such as a microwave oven and industrial/scientific/medical devices, in-plant radio stations used to identify mobile objects used in production lines of a factory that require a license, specified low power radio stations, or amateur radio stations that do not require a license (hereafter "other radio stations") can be in operation.

1. Before using this terminal, check whether other radio stations are in operation in your neighborhood.
2. If radio wave interference occurs between the terminal and "other radio stations", use the terminal in a different location or "Turn the power OFF" to avoid the radio wave interference.
3. For details, contact "General Inquiries" on the last page of this manual.



FeliCa reader/writer

- FeliCa reader/writer function of FOMA terminal uses weak waves requiring no licenses for radio stations.
- It uses 13.56 MHz frequency band. When using other reader/writers in your surroundings, keep FOMA terminal away sufficiently from them. Before using the FeliCa reader/writer, confirm that there are no radio stations using the same frequency band nearby.

FM transmitter

- FM transmitter of FOMA terminal uses weak waves requiring no licenses for radio stations.
- It uses 77.4 - 85.0MHz frequency band. To use it, set frequency not to common to FM radio station of the area you use to avoid affecting FM radio users in neighborhood.

CAUTION

- **Do not use a remodeled FOMA terminal. Using a remodeled terminal violates the Radio Law.**
FOMA terminal is certified according to technical standard conformance of specified wireless equipment based on the Radio Law, and as a proof of it, the "Technical Compliance Mark (TCM)" is depicted on the engraved sticker of FOMA terminal.
If you remodel FOMA terminal by removing its screws, your certification of technical standard conformance becomes invalid.
Do not use FOMA terminal with its certification of technical standard conformance invalid as it violates the Radio Law.
- **Be careful when you use FOMA terminal while driving a car etc.**
Using a mobile phone while driving is subject to penal regulations.
However, absolutely necessary cases such as rescue of a sick person or maintaining public's safety are exempted.
- **Use the Bluetooth function only in Japan.**
The Bluetooth function of the FOMA terminal is compliant with wireless standards and is authorized for use only in Japan.
If you use this function overseas, you may be punished.
- **Use FeliCa reader/writer function only in Japan.**
FeliCa reader/writer function of FOMA terminal conforms to Japanese radio standards.
If you use this function overseas, you may be punished.
- **Use FM transmitter only in Japan.**
FM transmitter of FOMA terminal is compliant with wireless standards and is authorized for use only in Japan.
If you use this function overseas, you may be punished.

Waterproof/Dustproof function

F-11C provides waterproofness of IPX5^{*1}, IPX8^{*2} and dustproofness of IP5X^{*3} with firmly closing the external connection jack cap and installing the back cover in a locked state.

- *1 IPX5 means that a phone keeps functioning after applying a jet flow of 12.5 L/min. from every direction from a distance of approximately 3 m for at least 3 minutes using water nozzle in 6.3 mm inner diameter.
- *2 For F-11C, IPX8 means that a phone keeps functioning after F-11C is slowly submerged to depth of 1.5m in static tap water at room temperature, left there for 30 minutes and then taken out, and the mobile phone keeps shooting still images or moving pictures in approximately 30 minutes in static tap water at room temperature.
- *3 IP5X means a protection degree that a phone keeps functioning and safety after it is placed in a device with dust in diameter 75 μ or less for 8 hours, agitated and then taken out.

❖ What you can do with waterproofness/dustproofness of F-11C

- **You can talk or watch 1Seg programs without using an umbrella in the rain (for rainfall of 20 mm or less per hour).**
 - When your hands or the FOMA terminal are wet, avoid installing/removing the back cover or opening/closing the external connection jack cap.

- **You can also shoot still images and moving pictures in the pool depth of 1.5 m.**
 - Do not perform other operations underwater than shooting still images and moving pictures.
 - If you put the terminal in water of swimming pool, be sure to have it within 30 minutes.
 - If FOMA terminal gets wet with water from the swimming pool, wash it in specified procedure (\Rightarrow P23).
- **You can use FOMA terminal in a bathroom.**
 - Do not put the terminal in the bathtub. Do not use the terminal in hot water. May cause malfunction.
 - Never put FOMA terminal in hot spring water or water containing soap, detergent or bath powder.

To ensure waterproofness/dustproofness

To avoid water/dust ingress, be sure to observe the following points.

- Do not throw any liquid other than room-temperature tap water on FOMA terminal, or soak it in such liquid.
- When using the external connection jack, pull the cap up with your finger by the groove as shown in the illustration.

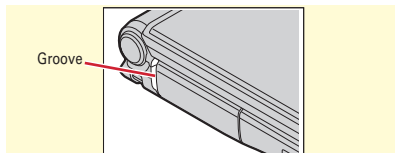

After using the external connection jack, close the cap as the direction shown in the, and make sure that the cap is completely closed without slack by pushing the tab in.

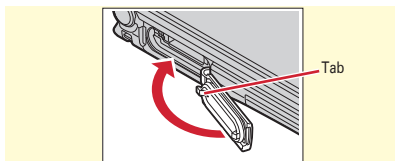

- For installing the back cover, see "Installing back cover" of "Attaching UIM/battery pack". ⇒P26
- Securely lock the back cover and firmly close the external connection jack cap. Even a fine obstacle (one hair, one grain of sand, tiny fiber, etc.) put between contact surfaces may allow water to enter.
- Do not poke the microphone, earpiece or speaker with a swab or sharp object.
- Do not let FOMA terminal fall. It may become scratched causing the waterproof/dustproof performance to degrade.
- The external connection jack cap and the rubber packing of the rear side of the back cover play an important role for keeping waterproof performance. Do not deform the back cover by twisting etc. or peel off or damage the rubber packing. Also, prevent dust from adhering to it.

● ● ●
To keep FOMA terminal waterproofness/dustproofness, replacement of parts is required every 2 years regardless of whether FOMA terminal appears normal or abnormal. DOCOMO replaces the parts as a chargeable service. Bring FOMA terminal to a sales outlet such as a DOCOMO-specified repair office.

Important precautions

Do not perform actions shown in the illustrations below.

<Example>



Using Soap/Detergent/
Bath powder



Washing with
brush/sponge



Machine-washing



Applying strong
water flow



Soaking in
ocean water



Using in
hot spring

Observe the following precautions to use FOMA terminal properly.

- Accessories and optional devices are not waterproof/dustproof. When watching 1Seg etc. with FOMA terminal installed in the included desktop holder, do not use it in a bathroom, shower room, kitchen or lavatory even if it is not connected to the AC adapter.
- Do not apply water flow stronger than allowed (⇒P21) (e.g., such water flow that gives you pain when applied to your skin directly from a faucet or shower). F-11C provides IPX5 waterproof performances. However, it causes malfunction.
- If FOMA terminal gets wet with salt water, sea water, refreshing beverage or mud or soil adhered, wash it immediately. If they dry out, it is hard to remove the dirt and it may cause damage or malfunction.
- Do not put FOMA terminal in hot water, use it in a sauna or apply hot airflow (from a hair dryer etc.) to it.

- Do not move in water or slam the terminal against the surface of water with FOMA terminal opened.
- If you put the terminal in tap water or in water of swimming pool, be sure to have it within 30 minutes.
- When you use the terminal in swimming pool, obey rules of the facility.
- FOMA terminal does not float on water.
- Do not leave water on FOMA terminal. May short-circuit the power jacks, or in a cold region, water may freeze causing malfunction.
- Do not leave water on the microphone, earpiece or speaker. Such water may interfere with talking.
- Do not leave water on the temperature/humidity sensor. Measuring temperature and humidity may not be correct.
- If the back cover is damaged, replace it. Water may enter inside from a damaged section causing troubles such as electric shocks or corrosion of the battery.
- If FOMA terminal gets wet with water or other liquids with the external connection jack cap or the back cover open, the liquid may get inside the terminal causing electric shocks or malfunction. Stop using FOMA terminal, turn the power OFF, remove the battery pack and contact a DOCOMO-specified repair office.
- If the external connection jack cap, or the rubber gasket on the rear side of the back cover is damaged or deformed, replace it at DOCOMO-specified repair office.

● ● ●
 DOCOMO does not guarantee actual operations under all states. Malfunctions deemed to be caused by inappropriate operation by the customer are not covered by the warranty.

Washing FOMA terminal

With pressing and holding the external connection jack cap not to open, wash the terminal in tap water without rubbing hard.

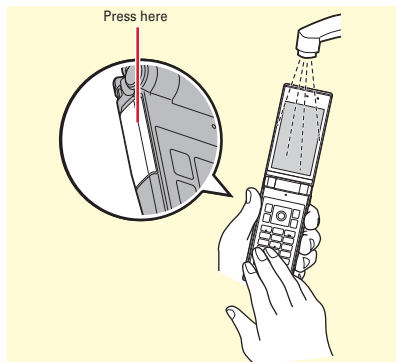

- Do not apply water flow stronger than allowed (⇒P21) (e.g., such water flow that gives you pain when applied to your skin directly from a faucet or shower).
- In locked state with the back cover attached, with pressing and holding the external connection jack cap not to open, wash the terminal in tap water in room temperature without rubbing hard.
- Do not use brush, sponge, soap, detergent, etc.
- If mud or soil is adhered to the terminal, do not open, close or rotate the terminal. Eliminate the dirt first by shaking several times in tap water of wash-basin and then wash the terminal with running water.
- After washing, wipe the surface with dry cloth well, drain water by the following procedure and let the terminal dry naturally.

Draining water from FOMA terminal

When FOMA terminal is wet, water may flow out after wiping it off; drain the water in the following steps.

- ① Hold the hinge section of FOMA terminal firmly and wipe off moisture on FOMA terminal surface and back side with dry, clean cloth etc.



- ② Shake FOMA terminal approximately 20 times, firmly holding its hinge section, until there is no more water splattering.

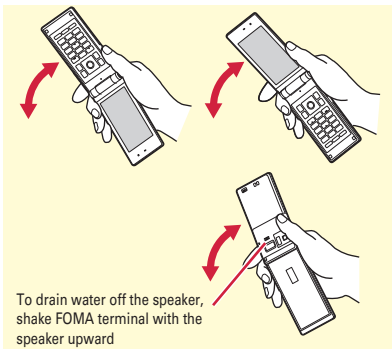

- ③ Swing FOMA terminal in about 10 times against dry, clean cloth etc. to wipe off water remaining in the microphone, earpiece, speaker, keypad, hinges or charging jack, etc. In addition, swing the right side of the display face against cloth about 10 times to wipe off the water remaining in earpiece (right in the illustration below).

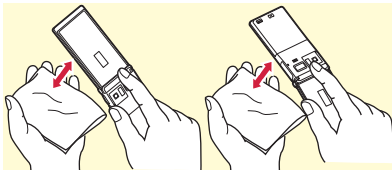

- ④ Wipe off water drained from FOMA terminal with dry, clean cloth etc., and dry naturally.
- Water, if any, remaining in FOMA terminal may ooze up after wiping off.
 - Do not wipe off water remaining in gaps directly with a cotton swab etc.

Charging

Check the following before and after charging.

- Check if FOMA terminal is not wet. Never try to charge the battery pack when FOMA terminal is wet.
- Accessories and optional devices are not waterproof/dustproof.
- When charging the battery when or after FOMA terminal is wet, adequately drain it and wipe off water with a dry, clean cloth etc., before connecting the accessory desktop holder or opening the external connection jack cap.
- When the external connection jack cap is opened for charging, close the cap firmly after charging. It is recommended to use the desktop holder for charging to prevent water from seeping inside from the external connection jack.
- Do not use the AC adapter or desktop holder in a bathroom, shower room, kitchen, lavatory or other highly humid area. May cause fire or electric shock.
- Do not touch the AC adapter or desktop holder with wet hands. May cause electric shock.

Before Using

Attaching UIM/battery pack

After turning power OFF, close FOMA terminal and hold it in your hand so that you can properly attach UIM/battery pack.

❖ Removing back cover

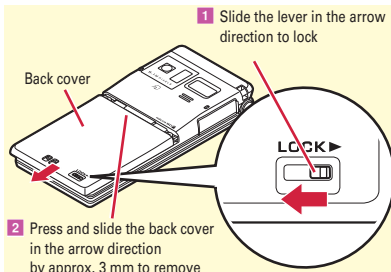

❖ Attaching UIM

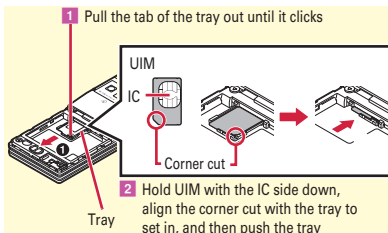

Point

- The UIM (blue) is not available for this FOMA terminal. If you have the UIM (blue), bring it to a docomo Shop to replace.

❖ Installing battery pack

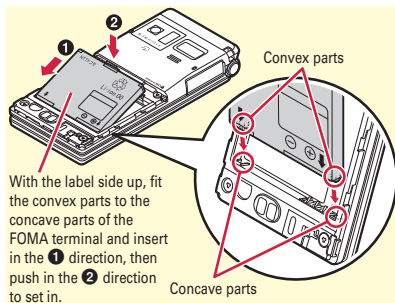

❖ Installing back cover

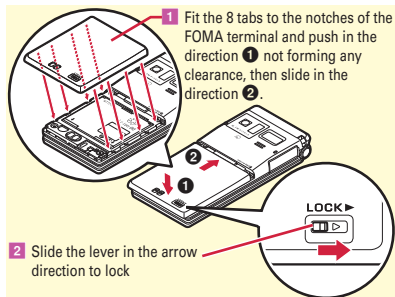

Before Using Charging

The battery pack does not have a full charge at time of purchase. Use AC adapter for FOMA terminal to charge the battery before using FOMA terminal.

Charging using desktop holder

- 1** Insert the connector of AC adapter horizontally to the accessory desktop holder, with the arrows mark side upward
- 2** Unfold the power plug and insert it into a 100V AC outlet
- 3** Close FOMA terminal and insert it into the desktop holder
- 4** Check that the charging light turns on

* After charging is completed, remove FOMA terminal from the desktop holder.

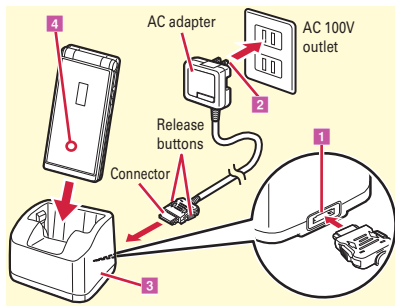

Charging using AC adapter

- 1** Open the external connection jack cap (❶), hold the connector horizontally with the arrows side upward and insert it to the jack (❷)
- 2** Unfold the power plug and insert it into a 100V AC outlet
- 3** Check that the charging light turns on

* When charging is over, pull out the power plug from the outlet, and pull out from FOMA terminal horizontally while pressing the release buttons on both sides of the connector.

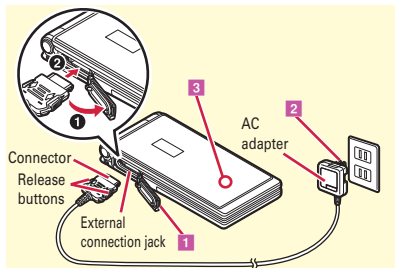

Before Using

Turning power ON - Configuring default setting

Initial setting is an operation when FOMA terminal is turned ON for the first time.

1  (2 sec. or more)

The Initial setting screen appears.

2 **Set required items** ▶  **[Complete]**

If you exit without setting Change security code and Request permit/deny., Initial setting screen reappears when the power is turned ON the next time.

3 **On a confirmation screen of software update function,** 

The stand-by display appears.

Point

- If no operation is performed, the display light is automatically turned off according to the settings in Light time-out or eco mode setting. The display light turns on again if there is any operation or incoming call.
- The battery usage state is automatically recorded while using the FOMA terminal. The record is used only for repair diagnosis.

Turning power off :  (2 sec. or more)

Changing the initial setting :  ▶   

Changing screen display to English :

 ▶     ▶ Select "English"

Before Using

Caller ID notification

Set whether to notify your phone number (caller ID) to the other party's terminal when making a voice call. Caller ID notification is set to "ON" at the time of subscription.

1  ▶ **7 TEL function** ▶ **4 Dial/Receive call setting** ▶ **3 Caller ID notification** ▶ **2 Setting** ▶ **1 ON or 2 OFF**

Point

- If you hear an announcement of requesting caller ID when making a call, set Caller ID notification or add prefix "186" to the phone number to call again.

Before Using

Checking Profile

Check a model name or own phone number. For details of checking/changing a mail address, refer to "Mobile Phone User's Guide [i-mode] FOMA version".

1  ▶ **0 Profile**

User information screen appears.

Point

Editing the profile : On User information screen,  ▶ **Authenticate** ▶ **Set required items** ▶ 

Checking a phone number during a call :

 ▶ **0**

Screen Explanation

Viewing display

The current state can be checked by the icon appearing on the screen. Major icons are as follows.

① Status area

Status icons appear. Select an area to display the status menu. ⇒P31

Battery level (Battery icon)



Signal strength (Antenna icon)



SELF : Self mode ON

: In data transfer mode

: Connecting to i-mode

: AutoKeyLock ON

: Infrared communication in operation

: Bluetooth ON

: The total calls cost exceeds the limit

: Communication using handsfree-compatible device in progress

: Handsfree ON

: Femto cell available

: Touch operation OFF

: Positioning with GPS





























: Location request setting

: Unread Area Mail exists

: In-area auto-send mail exists

: Unread i-mode mail exists

: Arrival i-concier information exists

-  : Unreceived i-mode mail exists in i-mode Center
-  : Using Smart Browser
-  : A phonebook entry, memo or schedule has secret attribute
-  : Music&Video Channel program obtaining reservation exists
-  : High-pitched alarm is "ON"
-  : Kid-safe mode ON
-  : During i-appli operation
-  : i-appli call exists
-  : Communication mode ON (USB cable connected)
-  : Alarm is set
-  : 1Seg watching/recording reserved or alarm of Memo is set
-  : Inside OFFICEED area
-  : Manner mode ON
-  : Call alert volume OFF
-  : Vibration mode for voice call ON
-  : In Public mode (Drive mode)
-  : Manner support ON
-  : Record message setting ON
-  : Keypad dial lock ON
-  : Personal data lock ON
-  : IC card lock ON
-  : Recording 1Seg in the FOMA terminal
-  : eco mode ON
-  : microSD card inserted
-  : Connected to external device using USB cable
-  : Pedometer/ACT monitor is set
-  : Software update rewrite notice
-  : Auto-update of latest pattern definition failure

② Task area

Icons indicating running features (tasks) appear.

③ New arrival



Starting from the left, missed call, recorded message, message in voice mail service, unread mail, unread ToruCa, i-appli call

④ Machi-chara

Characters moving about the screen and giving messages. In addition to the preinstalled characters, you can obtain characters by downloading.

⑤ Stand-by disp layout

Clock, weather forecast, thermo-hygrometers (TempHmd), Pedometer/Physical Activity Monitor, Calendar, Schedule, Memo, icon to activate i-concier, i-Channel ticker, graffiti pasted on the stand-by display. Touch and hold the screen for 1 second or more to display stand-by elements palette/stand-by handwriting palette, and edit freely with touch or slide operations.

⑥ Stand-by launcher

Button to activate functions displayed on the stand-by display (vertical).⇒P31

Screen Explanation

Basic operations for screen and keys

Menu operation

On the stand-by display, select **[MENU]** and then perform the functions from the menu. You can select a menu item with shortcut operations, which use the keypad, etc. or with multi-cursor operation, which uses the multi-cursor key to move the cursor.

<Example> Selecting "Calculator"

Shortcut operations

1 **[MENU]** ▶ **[6]** ▶ **[2]**

Multi-cursor key operations

1 **[MENU]** ▶ Move the cursor to "6 Tool" ▶
[OK] ▶ Move the cursor to "2
 Calculator" ▶ **[OK]**

Point

- To return to the previous screen, press **[CLR]**. To return to the stand-by display, press **[]**.

Guide area

Operations that can be performed by pressing **[MENU]**, **[]**, **[OK]**, and **[]** are displayed in the guide area.

* Terms indicated with [] in the

instructions of this manual are items displayed in the guide area.

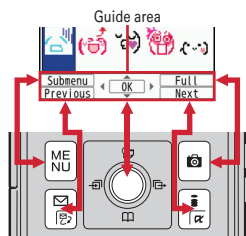

Focus mode

Select an arrival information etc. on the stand-by display using **[]** and **[]** to quickly display the corresponding information.

Screen Explanation

Quick voice activation

When you do not know a desired menu of function or you want to activate the function quickly, the function can be activated by voice sound input from the stand-by display. (In Japanese only)

1  (1 sec. or more)

For the first activation, on the guidance screen, select "利用する (Use)" or press . From the second time, "それではどうぞ ★★ 音声受付中★★" (Please go ahead ★★ voice input available★★) is displayed.

2 **Speak a function name toward the microphone within 10 seconds.**

When a message asking for re-entry appears, press  and speak again.

When the voice input is recognized, the function activates. If the function is not identified, the keyword list of 使いかたガイド (Guide) appears.

Point

- Speak clearly with natural conversation speed.
- Depending on the environment or way of speaking, recognition result may vary.
- You can speak function name (電卓 (Calculator), ワンセグ (1Seg), etc.), keyword (計算 (calculation), テレビ (TV), アドレス交換 (address exchange), etc.) or combination of keywords (写真 見る (view photo), メール 問合せ (mail check), スケジュール 4月25日 (schedule 25th April), ○○さん*にメール (mail to Mr. ○○), etc.) to activate the function.

* Name registered to the phonebook

Screen Explanation

使いかたガイド (Guide)

You can check outline of function, operations or troubleshooting. (In Japanese only)

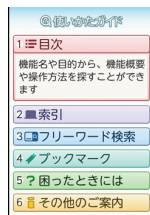
1 **[MENU] ▶ 6 Tool ▶ # Guide ▶ Select a search method**

<Guide screen>

目次 (Contents) : Search from a list of functions.

索引 (Index) : Search from a list of words sorted according to Japanese syllabary.

フリーワード検索 (Free word search) : Enter a keyword to search for.

ブックマーク (Bookmark) : Search from a list of registered bookmarks.

困ったときには (Troubleshooting) : Search from lists of troubles or error messages.

其他のご案内 (More information) : Access to guide page introducing useful site.

Point

- On a description screen, select "この機能を使う (Use this function)" to perform a function. Selecting a link item in "関連機能 (related functions)" or "→コチラ (See more)" displays a corresponding description screen.

Appendix

Specific Absorption Rate (SAR) of Mobile Phones

This model F-11C mobile phone complies with Japanese technical regulations and international guidelines regarding exposure to radio waves. This mobile phone was designed in observance of Japanese technical regulations regarding exposure to radio waves (^{*1}) and limits to exposure to radio waves recommended by a set of equivalent international guidelines. This set of international guidelines was set out by the International Commission on Non-ionizing Radiation Protection (ICNIRP), which is in collaboration with the World Health Organization (WHO), and the permissible limits include a substantial safety margin designed to assure the safety of all persons, regardless of age and health condition.

The technical regulations and international guidelines set out limits for radio waves as the Specific Absorption Rate, or SAR, which is the value of absorbed energy in any 10 grams of tissue over a 6-minute period. The SAR limit for mobile phones is 2.0 W/kg. The highest SAR value for this mobile phone when tested for use at the ear is 0.657 W/kg. There may be slight differences between the SAR levels for each product, but they all satisfy the limit.

The actual SAR of this mobile phone while operating can be well below that indicated above. This is due to automatic changes to the power level of the device to ensure it only uses the minimum required to reach the network. Therefore in general, the closer you are to a base station, the lower the power output of the device. This mobile phone can be used in positions other than against your ear. This mobile phone satisfies the international guidelines when used with a carrying case or a wearable accessory approved by NTT DOCOMO, INC.^{(*)2} In case you are not using the approved accessory, please use a product that does not contain any metals, and one that positions the mobile phone at least 1.5 cm away from your body.

The World Health Organization has stated that present scientific information does not indicate that there are harmful effects attributed to the use of mobile devices. They recommend that if you are worried about your exposure then you can limit your usage or simply use a hands-free kit to keep the mobile device away from the head and body.

Please refer to the WHO website if you would like more detailed information.

http://www.who.int/docstore/peh-emf/publications/facts_press/fact_english.htm

Please refer to the websites listed below if you would like more detailed information regarding SAR.

Ministry of Internal Affairs and Communications Website:

<http://www.tele.soumu.go.jp/e/sys/e/e/index.htm>

Association of Radio Industries and Businesses

Website: <http://www.arib-emf.org/index02.html> (in Japanese only)

NTT DOCOMO, INC. Website: <http://>

www.nttdocomo.co.jp/english/product/sar/

FUJITSU LIMITED Website: <http://www.fmworlde.net/product/phone/sar/>

^{*1} Technical regulations are defined by the Ministerial Ordinance Related to Radio Law (Article 14-2 of Radio Equipment Regulations).

^{*2} Regarding the method of measuring SAR when using mobile phones in positions other than against the ear, international standards (IEC62209-2) were set in March of 2010. On the other hand, technical regulation is currently being deliberated on by national council. (As of September, 2010)

Declaration of Conformity

The product "F-11C" is declared to conform with the essential requirements of European Union Directive 1999/5/EC Radio and Telecommunications Terminal Equipment Directive 3.1(a), 3.1(b) and 3.2. The Declaration of Conformity can be found on <http://www.fmworld.net/product/phone/doc/>.

This mobile phone complies with the EU requirements for exposure to radio waves.

Your mobile phone is a radio transceiver, designed and manufactured not to exceed the SAR* limits** for exposure to radio-frequency(RF) energy, which SAR* value, when tested for compliance against the standard was 1.140W/kg. While there may be differences between the SAR* levels of various phones and at various positions, they all meet*** the EU requirements for RF exposure.

* The exposure standard for mobile phones employs a unit of measurement known as the Specific Absorption Rate, or SAR.

** The SAR limit for mobile phones used by the public is 2.0 watts/kilogram (W/Kg) averaged over ten grams of tissue, recommended by The Council of the European Union. The limit incorporates a substantial margin of safety to give additional protection for the public and to account for any variations in measurements.

*** Tests for SAR have been conducted using standard operation positions with the phone transmitting at its highest certified power level in all tested frequency bands. Although the SAR is determined at the highest certified power level, the actual SAR level of the phone while operating can be well below the maximum value. This is because the phone is designed to operate at multiple power levels so as to use only the power required to reach the network. In general, the closer you are to a base station antenna, the lower the power output.

Federal Communications Commission (FCC) Notice

- This device complies with part 15 of the FCC rules. Operation is subject to the following two conditions :
 - ① this device may not cause harmful interference, and
 - ② this device must accept any interference received, including interference that may cause undesired operation.
- Changes or modifications made in or to the radio phone, not expressly approved by the manufacturer, will void the user's authority to operate the equipment.

FCC RF Exposure Information

This model phone meets the U.S. Government's requirements for exposure to radio waves.

This model phone contains a radio transmitter and receiver. This model phone is designed and manufactured not to exceed the emission limits for exposure to radio frequency (RF) energy as set by the FCC of the U.S. Government. These limits are part of comprehensive guidelines and establish permitted levels of RF energy for the general population. The guidelines are based on standards that were developed by independent scientific organizations through periodic and thorough evaluation of scientific studies.

The exposure standard for wireless mobile phones employs a unit of measurement known as the Specific Absorption Rate (SAR). The SAR limit set by the FCC is 1.6 W/kg. Tests for SAR are conducted using standard operating positions as accepted by the FCC with the phone transmitting at its highest certified power level in all tested frequency bands. Although the SAR is determined at the highest certified power level, the actual SAR level of the phone while operating can be well below the maximum value. This is because the phone is designed to operate at multiple power levels so as to use only the power required to reach the network. In general, the closer you are to a wireless base station antenna, the lower the power output level of the phone.

Before a phone model is available for sale to the public, it must be tested and certified to prove to the FCC that it does not exceed the limit established by the U.S. government-adopted requirement for safe exposure. The tests are performed on position and locations (for example, at the ear and worn on the body) as required by FCC for each model. The highest SAR value for this model phone as reported to the FCC, when tested for use at the ear, is 1.450W/kg, and when worn on the body, is 0.455W/kg. (Body-worn measurements differ among phone models, depending upon available accessories and FCC requirements).

While there may be differences between the SAR levels of various phones and at various positions, they all meet the U.S. government requirements.

The FCC has granted an Equipment Authorization for this model phone with all reported SAR levels evaluated as in compliance with the FCC RF exposure guidelines. SAR information on this model phone is on file with the FCC and can be found under the Equipment Authorization Search section at <http://www.fcc.gov/oet/ea/fccid/> (please search on FCC ID VQK-F11C).

For body worn operation, this phone has been tested and meets the FCC RF exposure guidelines when used with an accessory designated for this product or when used with an accessory that contains no metal and which positions the handset at a minimum distance of 1.5 cm from the body.

* In the United States, the SAR limit for wireless mobile phones used by the general public is 1.6 Watts/kg (W/kg), averaged over one gram of tissue. SAR values may vary depending upon national reporting requirements and the network band.

This equipment has been tested and found to comply with the limits for a Class B digital device, pursuant to part 15 of the FCC Rules.

These limits are designed to provide reasonable protection against harmful interference in a residential installation. This equipment generates, uses and can radiate radio frequency energy and, if not installed and used in accordance with the instructions, may cause harmful interference to radio communications.

However, there is no guarantee that interference will not occur in a particular installation.

If this equipment does cause harmful interference to radio or television reception, which can be determined by turning the equipment off and on, the user is encouraged to try to correct the interference by one or more of the following measures:

- Reorient or relocate the receiving antenna.
- Increase the separation between the equipment and receiver.
- Connect the equipment into an outlet on a circuit different from that to which the receiver is connected.
- Consult the dealer or an experienced radio/TV technician for help.

Important Safety Information

AIRCRAFT

Switch off your wireless device when boarding an aircraft or whenever you are instructed to do so by airline staff. If your device offers flight mode or similar feature consult airline staff as to whether it can be used on board.

DRIVING

Full attention should be given to driving at all times and local laws and regulations restricting the use of wireless devices while driving must be observed.

HOSPITALS

Mobile phones should be switched off wherever you are requested to do so in hospitals, clinics or health care facilities. These requests are designed to prevent possible interference with sensitive medical equipment.

PETROL STATIONS

Obey all posted signs with respect to the use of wireless devices or other radio equipment in locations with flammable material and chemicals. Switch off your wireless device whenever you are instructed to do so by authorized staff.

INTERFERENCE

Care must be taken when using the phone in close proximity to personal medical devices, such as pacemakers and hearing aids.

Pacemakers

Pacemaker manufacturers recommend that a minimum separation of 15 cm be maintained between a mobile phone and a pace maker to avoid potential interference with the pacemaker. To achieve this use the phone on the opposite ear to your pacemaker and does not carry it in a breast pocket.

Hearing Aids

Some digital wireless phones may interfere with some hearing aids. In the event of such interference, you may want to consult your hearing aid manufacturer to discuss alternatives.

For other Medical Devices :

Please consult your physician and the device manufacturer to determine if operation of your phone may interfere with the operation of your medical device.

Appendix

Export Administration Regulations

This product and its accessories may be under coverage of the Export Administration Regulations of Japan ("Foreign Exchange and Foreign Trade Control Laws" and the related laws and regulations). When exporting this product and its accessories, take necessary procedures on your responsibility and expense. For details, contact Ministry of Economy, Trade and Industry of Japan.

Appendix

Intellectual Property Right

Copyrights and portrait rights

Except for the case protected by copyright laws such as personal use, use of FOMA terminal to reproduce, alter, or publicly transmit recorded pictures or sounds, or copyrighted text, images, music or software downloaded from websites without the copyright holder's authorization is prohibited.

Note that taking photos or recordings at some demonstrations, performances or exhibitions may be prohibited even when only for personal use.

Avoid taking pictures of others with FOMA terminal without their consent or disclosing recorded pictures of others without their consent to general public through Internet websites etc., because they may infringe on portrait rights.

Trademarks



Company and product names mentioned in this manual are trademarks or registered trademarks of their respective holders.



- "FOMA", "i-mode", "i-αppli", "i-motion", "Deco-mail", "Chara-den", "ToruCa", "mopera", "WORLD CALL", "WORLD WING", "OFFICEED", "2in1", "docomo SMART series" and logos of "FOMA", "i-mode", "i-αppli", "Music&Video Channel", "iC" are trademarks or registered trademarks of NTT DOCOMO.
- "Catch Phone (Call waiting service)" is a registered trademark of Nippon Telegraph and Telephone Corporation.
- McAfee® is registered trademarks or trademarks of McAfee, Inc. and/or its affiliates in the US and/or other countries.

- Rovi, G-GUIDE, G-GUIDE MOBILE and G-Guide related logos are trademarks or registered trademarks of Rovi Corporation and/or its subsidiaries in Japan. 

- Contains Adobe® Flash® Player, Adobe® Flash® Lite® and Adobe Reader® Mobile  Powered by ADOBE FLASH®

technology by Adobe Systems Incorporated. Adobe Flash Player Copyright© 1996-2011 Adobe Systems Incorporated. All rights reserved. Adobe Flash Lite Copyright© 2003-2011 Adobe Systems Incorporated. All rights reserved. Adobe Reader Mobile Copyright© 1993-2011 Adobe Systems Incorporated. All rights reserved. Adobe, Adobe Reader, Flash and Flash Lite are either registered trademarks or trademarks of Adobe Systems Incorporated in the United States and/or other countries.

- This product contains NetFront Browser,  **NetFront** NetFront Document Viewer and NetFront Sync Client of ACCESS CO., LTD. ACCESS, the ACCESS logo and NetFront are registered trademarks or trademarks of ACCESS CO., LTD. in the United States, Japan and/or other countries. Copyright© 2011 ACCESS CO., LTD. All rights reserved.
- Powered by JBlend™ Copyright 2002-2011 Aplix Corporation. All rights reserved. JBlend and JBlend-related trademarks are trademarks or registered trademarks of Aplix Corporation in Japan and other countries. 

-  is a registered trademark of FeliCa Networks, Inc.
- FeliCa is a registered trademark of Sony Corporation.
- QR code is a registered trademark of Denso Wave Inc.
- microSDHC Logo is a trademark of SD-3C, LLC. 
- "Multitask" is a registered trademark of NEC Corporation.
- QuickTime is a registered trademark of Apple Inc., in the US and other countries.
- Microsoft[®], Windows[®], Windows Media[®], Windows Vista[®] and PowerPoint[®] are trademarks or registered trademarks of "Microsoft Corporation" in the US and other countries.
- Microsoft Excel and Microsoft Word are product names of Microsoft Corporation in the U.S.A. In this manual, they may be described as Excel and Word.
- The abbreviations of operating systems (Japanese versions) below are used in this manual.
 - Windows 7 stands for Microsoft[®] Windows[®] 7 (Starter, Home Basic, Home Premium, Professional, Enterprise and Ultimate).
 - Windows Vista stands for Windows Vista[®] (Home Basic, Home Premium, Business, Enterprise and Ultimate).
 - Windows XP indicates the Microsoft[®] Windows[®] XP Professional operating system or Microsoft[®] Windows[®] XP Home Edition operating system.
- Google and Google Map for Mobile are trademarks of Google Inc.
- The Bluetooth word mark and logos are owned by the Bluetooth SIG, Inc. and any use of such marks by NTT DOCOMO, Inc. is under license. Other trademarks and names are those of their respective owners.
- "CROSS YOU" is a trademark of Sony Corporation.

- Manufactured under license from Dolby Laboratories. Dolby and the double-D symbol are trademarks of Dolby Laboratories.
- iWnn of OMRON SOFTWARE Co., Ltd. is used for conversion methods for Japanese language, and for phrase prediction methods for English. iWnn[®] OMRON SOFTWARE Co., Ltd. 2008-2011 All Rights Reserved.
- "AXIS Font" is a trademark of AXIS Inc., and the "AXIS" font is a font developed by Type Project Inc.
- This product contains software licensed by Symbian Foundation Limited. Symbian is a registered trademark of Symbian Foundation Limited.
- "Privacy mode" is a registered trademark of FUJITSU LIMITED.
- "Uni-Type" is a universal designed font jointly-developed by LIM Corp., Ltd. and Faculty of Engineering, Chiba University. Uni-Type is a registered trademark of LIM Corp., Ltd.
- "丸ゴシック (Maru Gothic)", "レイミン (Reimin)" and "丸フォーク (Maru Fork)" are provided by Morisawa & Company, Ltd. and the copyrights of these font data belong to them. Names of "レイミン (Reimin)" and "丸フォーク (Maru Fork)" are their trademarks.
- OBEX[™], IrSimple[™], IrSS[™] and IrSimpleShot[™] are trademarks of Infrared Data Association. 
- Blu-ray Disc and its logo are trademarks.
- DVM[™] is a trademark of microphone directionality control technology of DiMAGIC (DiMAGIC Co., Ltd.). 
- Other company and product names mentioned in this manual are trademarks or registered trademarks of their respective holders.

Others

- This product contains a module developed by the Independent JPEG Group.
- FeliCa is a contactless IC card technology developed by Sony Corporation.
- This product is equipped with the technologies of GestureTek, Inc.
Copyright© 2006-2010, GestureTek, Inc. All Rights Reserved.
- OMRON Corporation's Mobile OmCR is used for a character recognition engine.
- This product contains software licensed based on Apache License V2.0. and altered as necessary by NTT DOCOMO, INC.
This product contains software licensed complying with GNU Lesser General Public License (LGPL), etc. For more details, on the FOMA terminal, [MENU] ⇒ [6] [⇄] [1] ⇒ "その他" to see in "オープンソースライセンス".
The source code of the used open source software is disclosed according to the rules of LGPL (<http://www.gnu.org/licenses/>). For more details, refer to the information on this product in the following site.
<http://www.fmworld.net/product/phone/●●●●●●●●>
- This product is licensed based on MPEG-4 Visual Patent Portfolio License. The use of MPEG-4 Video Codec function is allowed for personal and nonprofit use only in the cases below.
 - Recording moving pictures and i-motion that conform to MPEG-4 Visual Standard (hereinafter referred to as MPEG-4 Video)
 - Playing MPEG-4 Videos recorded personally by consumers not engaged in profit activities
 - Playing MPEG-4 Video supplied from the provider licensed from MPEG-LA
For further utilizing such as promotion, in-house use or profit-making business, please contact MPEG LA, LLC in U.S.

- Content owners use Windows Media digital rights management technology (WMDRM) to protect their intellectual property, including copyrights. This device uses WMDRM software to access WMDRM-protected content. If the WMDRM software fails to protect the content, content owners may ask Microsoft to revoke the software's ability to use WMDRM to play or copy protected content. Revocation does not affect unprotected content. When downloading licenses for protected content, you agree that Microsoft may include a "Revocation List" with the licenses. Content owners may require you to upgrade WMDRM to access their content. If you decline an upgrade, you cannot access a content that requires the upgrade.
- The HMM-Based Speech Synthesis Engine embedded in this product uses the Simplified BSD License.

 The HMM-Based Speech Synthesis System (HTS) hts_engine API developed by HTS Working Group
<http://hts-engine.sourceforge.net/>

Copyright© 2001-2010 Nagoya Institute of Technology, Department of Computer Science
 2001-2008 Tokyo Institute of Technology, Interdisciplinary Graduate School of Science and Engineering

All rights reserved.

Redistribution and use in source and binary forms, with or without modification, are permitted provided that the following conditions are met:

- Redistributions of source code must retain the above copyright notice, this list of conditions and the following disclaimer.
- Redistributions in binary form must reproduce the above copyright notice, this list of conditions and the following disclaimer in the documentation and/or other materials provided with the distribution.

- Neither the name of the HTS working group nor the names of its contributors may be used to endorse or promote products derived from this software without specific prior written permission.

THIS SOFTWARE IS PROVIDED BY THE COPYRIGHT HOLDERS AND CONTRIBUTORS "AS IS" AND ANY EXPRESS OR IMPLIED WARRANTIES, INCLUDING, BUT NOT LIMITED TO, THE IMPLIED WARRANTIES OF MERCHANTABILITY AND FITNESS FOR A PARTICULAR PURPOSE ARE DISCLAIMED. IN NO EVENT SHALL THE COPYRIGHT OWNER OR CONTRIBUTORS BE LIABLE FOR ANY DIRECT, INDIRECT, INCIDENTAL, SPECIAL, EXEMPLARY, OR CONSEQUENTIAL DAMAGES (INCLUDING, BUT NOT LIMITED TO, PROCUREMENT OF SUBSTITUTE GOODS OR SERVICES; LOSS OF USE, DATA, OR PROFITS; OR BUSINESS INTERRUPTION) HOWEVER CAUSED AND ON ANY THEORY OF LIABILITY, WHETHER IN CONTRACT, STRICT LIABILITY, OR TORT (INCLUDING NEGLIGENCE OR OTHERWISE) ARISING IN ANY WAY OUT OF THE USE OF THIS SOFTWARE, EVEN IF ADVISED OF THE POSSIBILITY OF SUCH DAMAGE.

General Inquiries <docomo Information Center>

0120-005-250 (toll free)

- * Service available in: English, Portuguese, Chinese, Spanish, Korean.
- * Unavailable from part of IP phones.

(Business hours : 9:00 a.m. to 8:00 p.m.)

■ From DOCOMO mobile phones (In Japanese only)

(No prefix) 151 (toll free)

- * Unavailable from land-line phones, etc.

■ From land-line phones (In Japanese only)

0120-800-000 (toll free)

- * Unavailable from part of IP phones.

(Business hours : 9:00 a.m. to 8:00 p.m. (open all year round))

- Please confirm the phone number before you dial.
- For Applications or Repairs and After-Sales Service, please contact the above-mentioned information center or the docomo shop etc. near you on the NTT DOCOMO website or the i-mode site.

▶ NTT DOCOMO website <http://www.nttdocomo.co.jp/english/>

▶ i-mode site iMenu⇒お客様サポート (user support)⇒ドコモショップ (docomo Shop) * In Japanese only

Loss or theft of FOMA terminal or payment of cumulative cost overseas <docomo Information Center>

(available 24 hours a day)

■ From DOCOMO mobile phones

International call access code
for the country you stay

-81-3-6832-6600* (toll free)

- * You are charged a call fee to Japan when calling from a land-line phone, etc.
- ※ If you use F-11C, you should dial the number +81-3-6832-6600 (to enter '+', press and hold the '0' key for at least one second).

■ From land-line phones <Universal number>

Universal number
international prefix

-8000120-0151*

- * You might be charged a domestic call fee according to the call rate for the country you stay.
- ※ For international call access codes for major countries and universal number international prefix, refer to DOCOMO International Services website.

- If you lose your FOMA terminal or have it stolen, immediately take the steps necessary for suspending the use of the FOMA terminal.
- If the FOMA terminal you purchased is damaged, bring your FOMA terminal to a repair counter specified by DOCOMO after returning to Japan.



Don't forget your mobile phone ... or your manners!

When using your mobile phone in a public place, don't forget to show common courtesy and consideration for others around you.



Li-ion 00

To prevent damage to the environment, bring used battery packs to a docomo service counter, a docomo agent or a recycle center.

Repairs

■ From DOCOMO mobile phones (In Japanese only)

(No prefix) 113 (toll free)

- * Unavailable from land-line phones, etc.

■ From land-line phones (In Japanese only)

0120-800-000 (toll free)

- * Unavailable from part of IP phones.

(Business hours : 24 hours (open all year round))

Failures encountered overseas <Network Support and Operation Center>

(available 24 hours a day)

■ From DOCOMO mobile phones

International call access code
for the country you stay

-81-3-6718-1414* (toll free)

- * You are charged a call fee to Japan when calling from a land-line phone, etc.
- ※ If you use F-11C, you should dial the number +81-3-6718-1414 (to enter '+', press and hold the '0' key for at least one second).

■ From land-line phones <Universal number>

Universal number
international prefix

-8005931-8600*

- * You might be charged a domestic call fee according to the call rate for the country you stay.
- ※ For international call access codes for major countries and universal number international prefix, refer to DOCOMO International Services website.

Sales: NTT DOCOMO, INC.
Manufacturer: FUJITSU LIMITED

2011.X (1st Edition)
CA92002-XXXX