

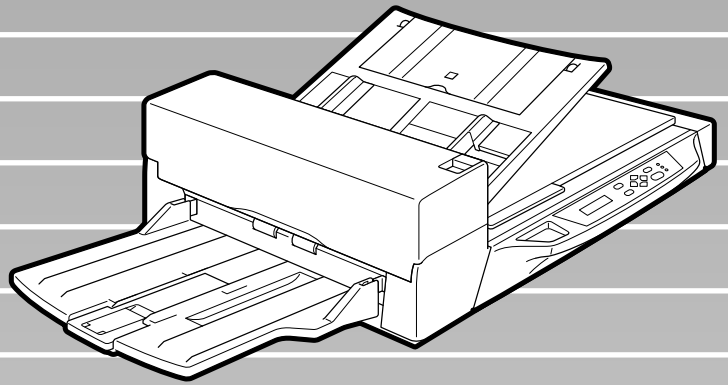

C150-E209-01EN

# ***fi-4640S Image Scanner***

## *Operator's Guide*



***fi-4640S***  
***Image Scanner***  
*Operator's Guide*

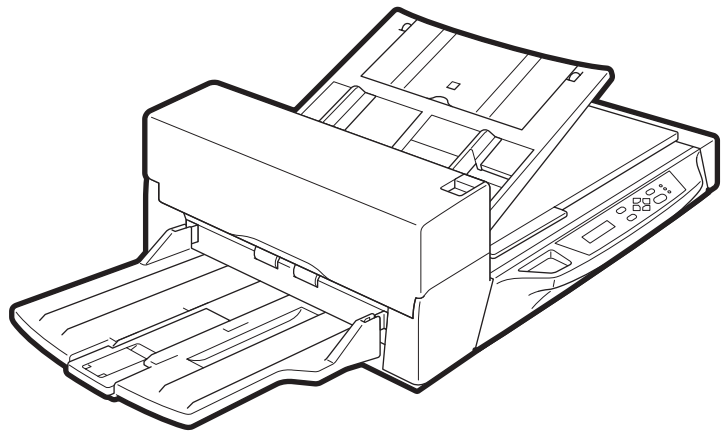

## Revisions, Disclaimers

Edition	Date published	Revised contents
01	July, 2001	First edition
Specification No. C150-E209-01EN		

**FCC declaration:** This equipment has been tested and found to comply with the limits for a Class B digital device, pursuant to Part 15 of the FCC Rules. These limits are designed to provide reasonable protection against harmful interference in a residential installation. This equipment generates, uses, and can radiate radio frequency energy and, if not installed and used in accordance with the instruction manual, may cause harmful interference to radio communications. However, there is no guarantee that interference will not occur in a particular installation. If this equipment does cause harmful interference to radio or television reception, which can be determined by turning the equipment off and on, the user is encouraged to try to correct the interference by one or more of the following measures:

- Reorient or relocate the receiving antenna.
- Increase the separation between the equipment and receiver.
- Connect the equipment into an outlet on a circuit different from that to which the receiver is connected.
- Consult the dealer or an experienced radio/TV technician for help.

**FCC warning:** Changes or modifications not expressly approved by the party responsible for compliance could void the user's authority to operate the equipment.

### NOTICE

- The use of a non-shielded interface cable with the referenced device is prohibited. The length of the parallel interface cable must be 3 meters (10 feet) or less. The length of the serial interface cable must be 15 meters (50 feet) or less.
- The length of the power cord must be 3 meters (10 feet) or less.

This Class B digital apparatus complies with Canadian ICES-003.

Cet appareil numérique de la classe B est conforme à la norme NMB-003 du Canada.

この装置は、情報処理装置等電波障害自主規制協議会（VCCI）基準に基づくクラスB情報技術装置です。この装置は、家庭環境で使用することを目的としておりますが、この装置がラジオやテレビジョン受信機に近接して使用されると、受信障害を引き起こすことがあります。取り扱い説明書に従って正しい取り扱いをして下さい。

**High Safety Required Use:** The Product is designed, developed and manufactured as contemplated for general use, including without limitation, general office use, personal use and household use, but is not designed, developed and manufactured as contemplated for use accompanying fatal risks or dangers that, unless extremely high safety is secured, could lead directly to death, personal injury, severe physical damage or other loss (hereinafter "High Safety Required Use"), including without limitation, nuclear power core control, airplane control, air traffic control, mass transport operation control, life support, weapon launching control. The Customer shall not use the Product without securing the sufficient safety required for the High Safety Required Use. In addition, Fujitsu (or other affiliate's name) shall not be liable against the Customer and/or any third party for any claims or damages arising in connection with the High Safety Required Use by the Customer of the Product.

As an ENERGYSTAR® Partner, Fujitsu Limited has determined that this scanner meets ENERGYSTAR® guidelines for energy efficiency. ENERGYSTAR® is a U. S. registered mark.

The contents of this manual may be revised without prior notice.

All Rights Reserved, Copyright © 2001 FUJITSU LIMITED.

Printed in Japan.

No part of this manual may be reproduced in any form without permission.

# Fujitsu Offices

Please send your comments on this manual or on Fujitsu products to the following addresses:

FUJITSU COMPUTER PRODUCTS OF AMERICA, INC.  
2904 Orchard Parkway, San Jose.  
California 95134-2022, U.S.A.  
TEL: 1-408-432-6333  
FAX: 1-408-432-3908  
<http://www.fcpa.com/>

FUJITSU AUSTRALIA LIMITED  
Fujitsu House 2 Julius Avenue North Ryde  
N.S.W 2113 AUSTRALIA  
TEL: 61-2-9776-4555  
FAX: 61-2-9776-4019  
<http://www.fujitsu.com.au/>

FUJITSU CANADA, INC.  
2800 Matheson Blvd. East, Mississauga.  
Ontario L4W 4X5, CANADA  
TEL: 1-905-602-5454  
FAX: 1-905-602-5457  
<http://www.fujitsu.ca/>

FUJITSU DEUTSCHLAND GmbH.  
Frankfurter Ring 211,  
8000 München 40, F.R., GERMANY  
TEL: 49-89-32378-0  
FAX: 49-89-32378-100  
<http://www.fujitsu.de/>

FUJITSU ESPAÑA, S.A.  
Edificio torre Europa 5ª  
Paseo de la Castellana 95  
Madrid 28046, SPAIN  
TEL: 34-1-581-8000  
FAX: 34-1-581-8300  
<http://www.fujitsu-europe.com/home/>

FUJITSU EUROPE LTD.  
2, Longwalk Road, Stockey Park, Uxbridge  
Middlesex, UB11 1AB, U.K.  
TEL: 44-81-573-4444  
FAX: 44-81-573-2643  
<http://www.fujitsu-europe.com/home>

FUJITSU FRANCE S.A.  
1, Place des Etats-Unis, SILIC 310,  
94588 Rungis cedex, FRANCE  
TEL: 33-1-4180-3880  
FAX: 33-1-4180-3866  
<http://www.fujitsu-europe.com/home/>

FUJITSU COMPUTERS (SINGAPORE) PTE, LTD.  
20 Science Park Road #03-01, Tele Teck Park  
Singapore Science Park II, Singapore 117674  
Republic of Singapore  
TEL: 65-777-6577  
FAX: 65-771-5669  
<http://www.fujitsu-computers.com.sg/>

FUJITSU HONG KONG Limited  
10/F, Lincoln House, Taikoo Place,  
979 King's Road, Island East, Hong Kong  
TEL: 852-827-5780  
FAX: 852-827-4724  
TLX: 62667  
<http://www.fujitsu.com.hk/>

FUJITSU ITALIA S.p.A.  
Via Nazario Sauro, 38  
20099 Sestos, Giovanni (MI), ITALY  
TEL: 39-2-26294-1  
FAX: 39-2-26294-201  
<http://www.fujitsu-europe.com/home>

FUJITSU NORDIC AB  
Kung Hans väg, S-192 68 Sollentuna, SWEDEN  
TEL: 46-8-626-4500  
FAX: 46-8-626-4588  
<http://www.fujitsu-europe.com/home>

FUJITSU LIMITED  
International Operations  
Marunouchi 1-6-1, Chiyoda-ku,  
Tokyo 100 JAPAN  
TEL: (81-3)3216-3211  
FAX: (81-3)3213-7174  
TLX: J2283  
Cable: "FUJITSU LIMITED TOKYO"  
<http://www.fujitsu.co.jp/>

## Note, Liability

---

READ ALL OF THIS MANUAL CAREFULLY BEFORE USING THIS PRODUCT. IF NOT USED CORRECTLY, UNEXPECTED INJURY MAY BE CAUSED TO USERS OR BYSTANDERS.

While all efforts have been made to ensure the accuracy of all information in this manual, FUJITSU assumes no liability to any party for any damage caused by errors or omissions or by statements of any kind in this manual, its updates or supplements, whether such errors are omissions or statements resulting from negligence, accidents, or any other cause. FUJITSU further assumes no liability arising from the application or use of any product or system described herein; nor any liability for incidental or consequential damages arising from the use of this manual. FUJITSU disclaims all warranties regarding the information contained herein, whether expressed, implied, or statutory.

FUJITSU reserves the right to make changes to any products herein, to improve reliability, function, or design, without further notice and without obligation.

# Preface

---

This manual explains how to use the fi-4640S image scanner.

This manual contains chapters on the following topics:

COMPONENTS  
INSTALLATION AND CONNECTIONS  
OPERATING INSTRUCTIONS  
ADF DOCUMENT SPECIFICATIONS  
SCANNER SPECIFICATIONS  
CONSUMABLES AND OPTIONS  
SETUP MODE

It also contains a Glossary of Terms and an Index.

Refer to the Cleaning and Maintenance Guide for information about the routine operation of the fi-4640S.

The Cleaning and Maintenance Guide contains chapters on OPERATING INSTRUCTIONS, CLEANING, REPLACEMENT OF PARTS, ADJUSTMENT and TROUBLESHOOTING.

The fi-4640S is a very fast and highly functional image scanner developed for high quality image processing, using charge-coupled device (CCD) image sensors. This scanner features high-speed simplex scanning with an automatic document feeder (ADF).

# Conventions

---

Important information that requires special attention is indicated as follows:

 **WARNING**

WARNING indicates that serious personal injury may result if you do not follow a procedure correctly.

 **CAUTION**

CAUTION indicates that minor personal injury, loss of data, or damage to the scanner may result if you do not follow a procedure correctly.

Official Fujitsu part names are indicated with an initial capital letter, as in the part name “Pick roller”.

 **NOTICE**

A NOTICE provides “how-to” tips or suggestions to help you perform a procedure correctly.



# CONTENTS

<b>❑ CHAPTER 1 COMPONENTS</b>	
Checking the Components .....	1-1
Units and Assemblies .....	1-2
Operator Panel .....	1-5
<b>❑ CHAPTER 2 INSTALLATION AND CONNECTIONS</b>	
Precautions .....	2-1
Inspection .....	2-2
Repositioning the Shipping Lock .....	2-3
Cable Connections .....	2-4
Mounting the Stacker .....	2-6
Setting the SCSI ID and the SCSI Terminator .....	2-7
<b>❑ CHAPTER 3 OPERATING INSTRUCTION</b>	
Turning the Power On .....	3-1
Waking up the Scanner from the Low Power Mode .....	3-2
Manual Feed Mode Setting .....	3-3
Loading Documents on the ADF .....	3-4
Loading Documents on the Flatbed .....	3-8
Loading Documents Larger than the Document Bed .....	3-9
Reading a Page from a Thick Book .....	3-10
<b>❑ CHAPTER 4 ADF DOCUMENT SPECIFICATION</b>	
Document Size .....	4-1
Document Quality .....	4-2
ADF Document Feeder Capacity .....	4-4
Areas not to be Perforated .....	4-5
Grounding Color Areas .....	4-6
Double Feed Detection Condition .....	4-7
Job Separation Sheet .....	4-8
<b>❑ CHAPTER 5 SCANNER SPECIFICATIONS</b>	
Basic Product Specification .....	5-1
Installation Specification .....	5-2
Dimensions .....	5-3
<b>❑ CHAPTER 6 CONSUMABLES AND OPTIONS</b>	
Consumables List .....	6-1
Options List .....	6-2
Video Interface Board Option .....	6-3
IPC-4D Option .....	6-7
fi-475PR Option (Imprinter) .....	6-8
<b>❑ CHAPTER 7 SETUP MODE</b>	
Activating the Setup Mode .....	7-1
Contents of the Setup Mode .....	7-2
<b>❑ GLOSSARY OF TERMS .....</b>	<b>GL-1</b>
<b>❑ INDEX .....</b>	<b>IN-1</b>



**CHAPTER 1**

**COMPONENTS**

COMPONENTS

**CHAPTER 2**

**INSTALLATION AND CONNECTIONS**

INSTALLATION AND  
CONNECTIONS

**CHAPTER 3**

**OPERATING INSTRUCTION**

OPERATING  
INSTRUCTION

**CHAPTER 4**

**DOCUMENT SPECIFICATION**

DOCUMENT  
SPECIFICATION

**CHAPTER 5**

**SCANNER SPECIFICATIONS**

SCANNER  
SPECIFICATIONS

**CHAPTER 6**

**CONSUMABLES AND OPTIONS**

CONSUMABLES  
AND OPTIONS

**CHAPTER 7**

**SETUP MODE**

SETUP MODE

**GLOSSARY OF TERMS**

GLOSSARY  
OF TERMS

**INDEX**

INDEX

CHAPTER

1

# COMPONENTS

---

*This chapter describes the components of the scanner, part names, operator panel arrangement, and the function of parts and LED indicators. After unpacking the scanner, confirm that all components have been received by checking them against the list in the first section.*

**Checking the Components**

**Units and Assemblies**

**Operator Panel**

# Checking the Components

These high precision components must be handled carefully. Confirm that all the components shown in the following figure have been received. If any component is missing, please contact your sales agent.

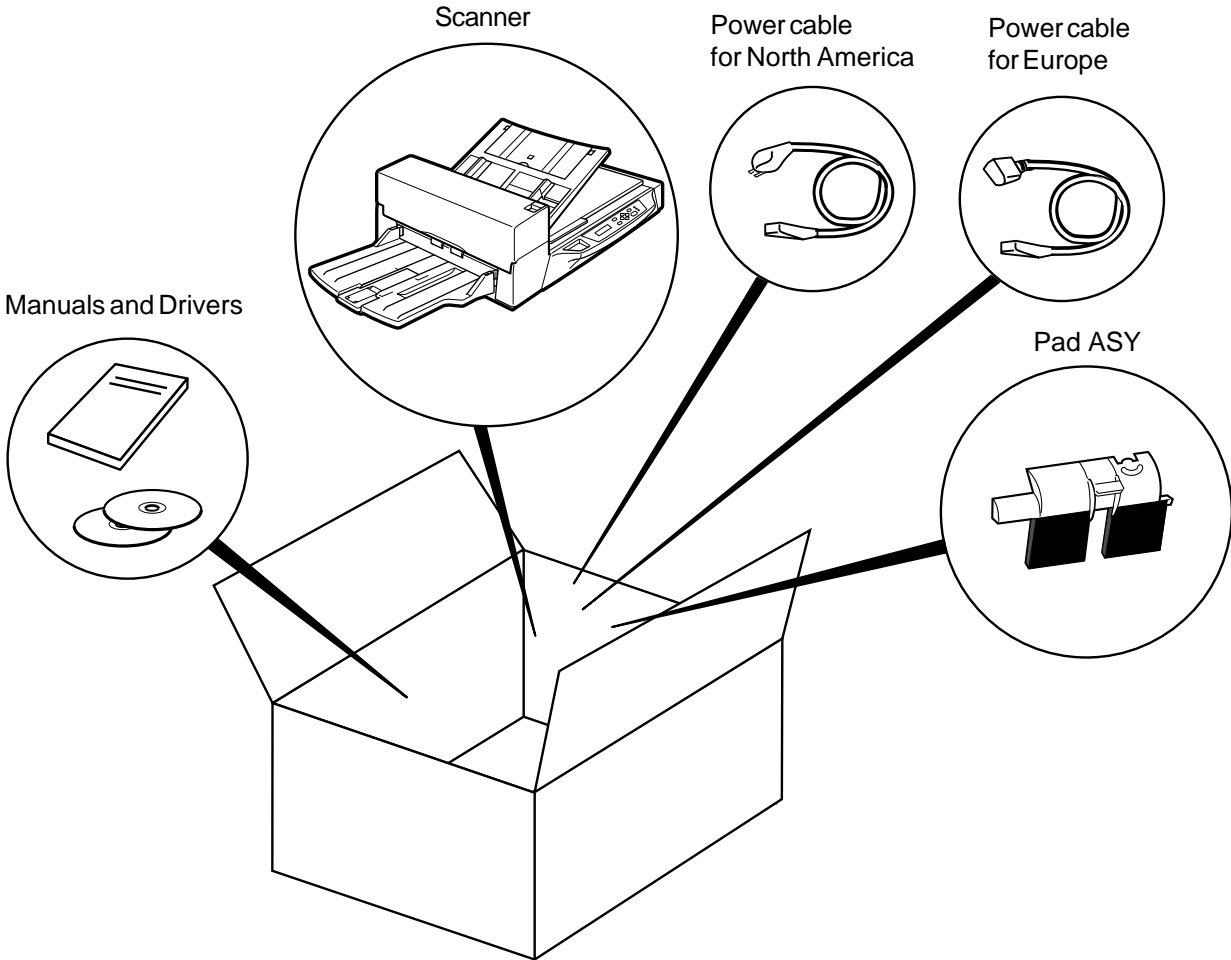

## NOTICE

One CD-ROM (User's Manual) contains "Cleaning and Maintenance" and this manual. The other CD-ROM contains scanner drivers.

# Units and Assemblies

This section shows the exterior view and assemblies of the scanner. This section also provides the name of each part and describes its functions.

## ■ Units

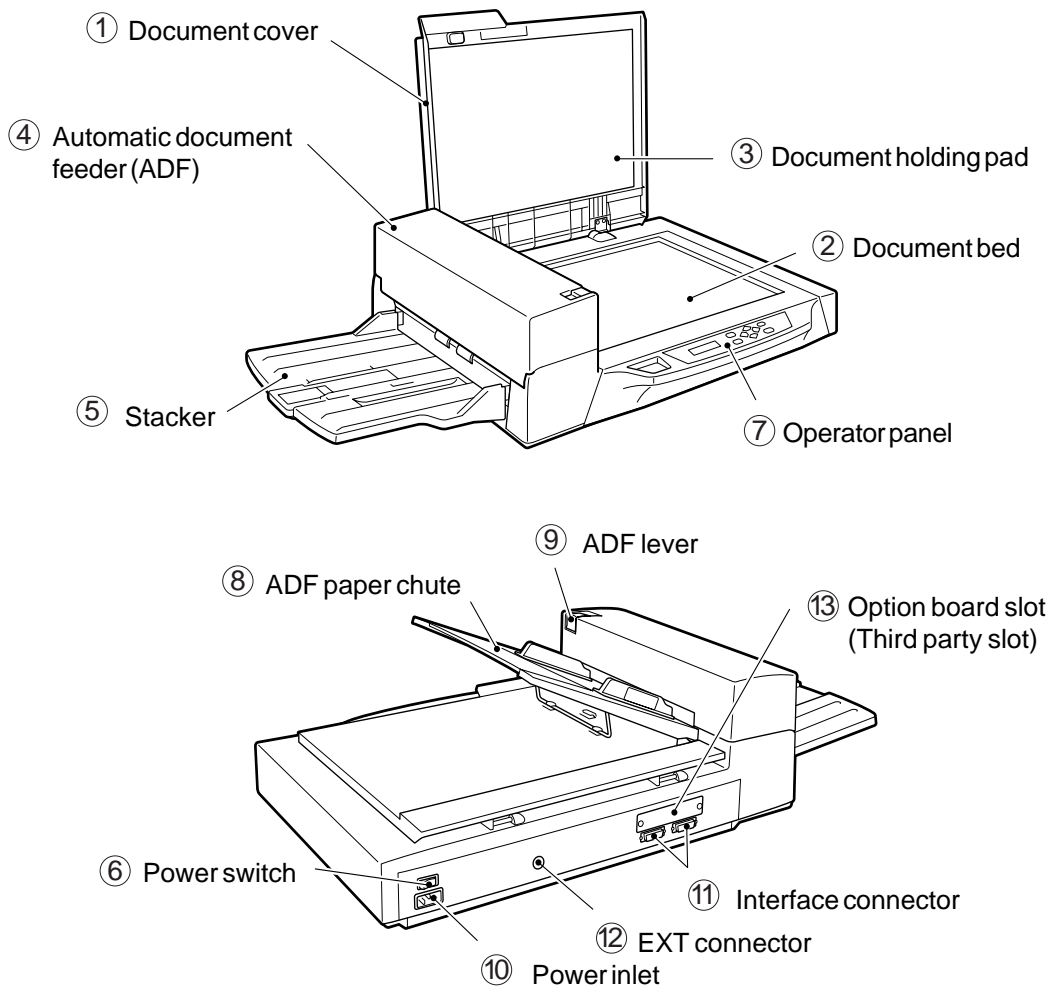

fi-4640S

## NOTICE

The shipping lock must be switched to the operating position before the scanner can be used. Refer to page 2-3.

Nº.	Part	Function
1	Document cover	Closes over and keeps in place the document to be read.
2	Document bed	Holds document to be read. Also called Flatbed (FB).
3	Document holding pad	Presses document to the Document bed.
4	Automatic document feeder (ADF)	Automatically feeds documents to the reading position.
5	Stacker	Stacks the read documents.
6	Power switch	Turns the power On or Off.
7	Operator panel	Contains indicator panel that indicates scanner status.
8	ADF paper chute	Holds the documents to be fed by the automatic document feeder (ADF).
9	ADF lever	Opens/closes the ADF to enable the removal of documents jammed in the feeder.
10	Power inlet	Connects to an AC power outlet with the power cable.
11	Interface connectors	Connect to the host system with interface cables.
12	EXT connector	Connects to an optional imprinter.
13	Option board slot (Third party slot)	An option board is installed.

## ■ Assemblies

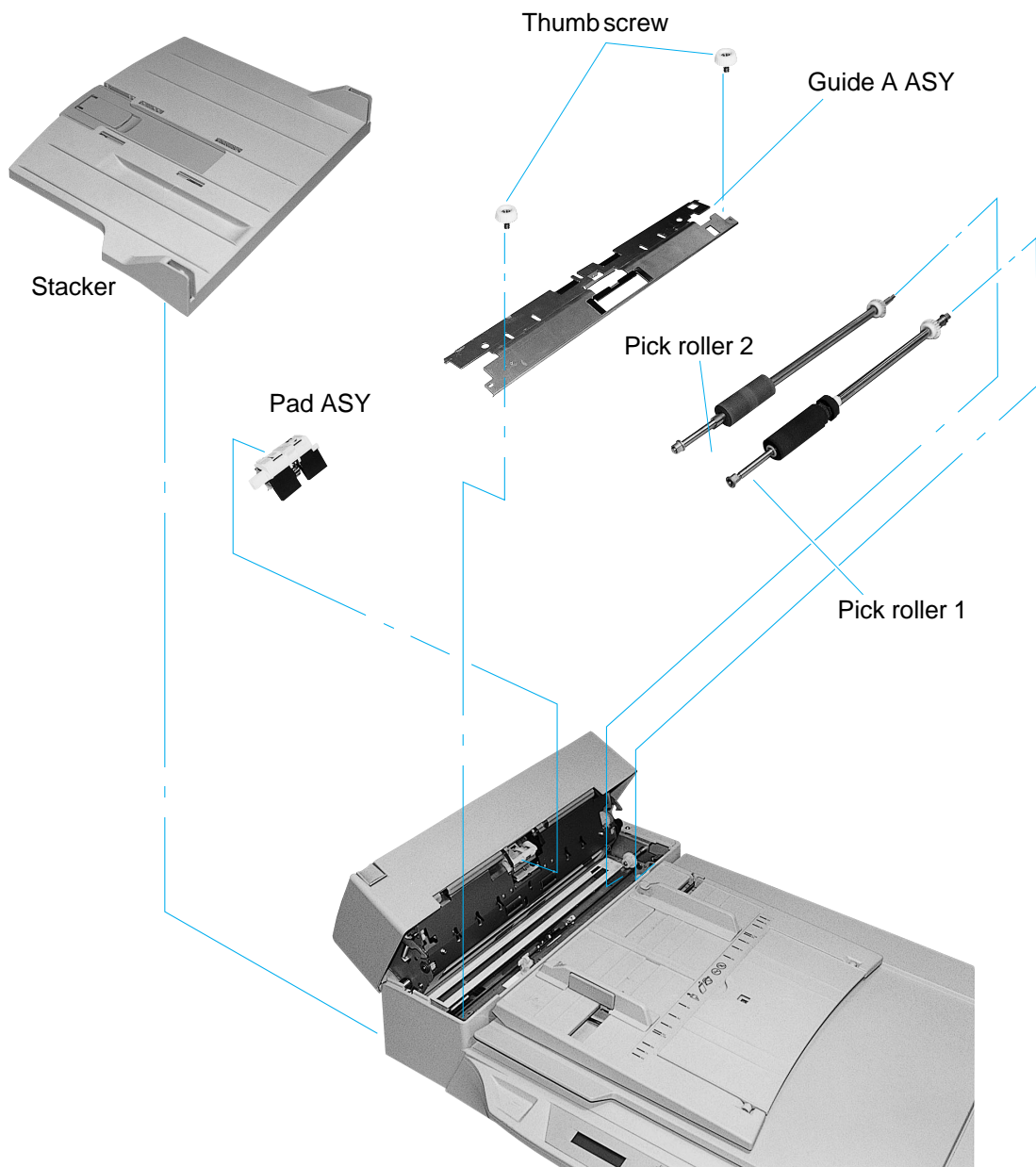



# Operator Panel

The operator panel is located on the upper right hand side of the scanner. The panel consists of an LCD display (16 characters x 2 lines), LEDs and buttons.



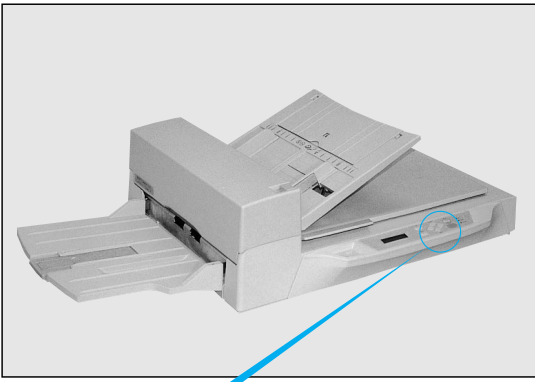

## ■ Arrangement

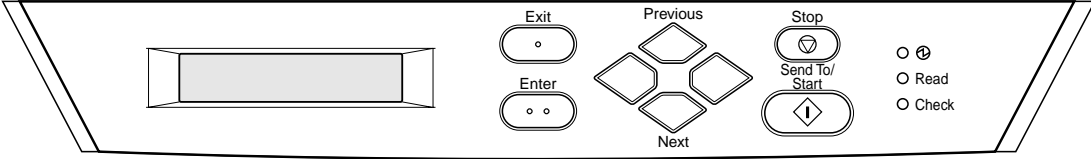

Operator panel





## ■ Button/LED Function

Name of the button and LED		Function
Button	Next 	Displays the next LCD screen.
	Previous 	Displays the previous LCD screen.
		Moves the cursor to the left.
		Moves the cursor to the right.
	Exit	When you are entering settings on the Operator panel, pressing this button returns you immediately to the "Scanner Ready" screen.
	Enter	Enters the parameter currently selected by the cursor.
	Send To/ Start	Operational only while "the Read" lamp lights when Manual start mode is set or the video interface option is used, and starts the reading. Some application software packages might use this button.
	Stop	Operational only during the read operation when the video interface option is used, and stops the reading. When the "Check" LED lights, pressing this button releases the error status (turns off "Check" and returns to the "Scanner Ready" screen). Also turns off the "Check" lamp.
LED		Indicates that the scanner is On.
	Read	Indicates the scanner is reading or ready to read.
	Check	<ul style="list-style-type: none"> <li>• If lit, this indicates that an alarm occurred. Pressing the "Stop" button turns the "Check" lamp Off.</li> <li>• If it blinks at one second intervals, this means that a jam or double feed has been detected. If the problem is jammed paper, removing the jammed paper turns off the "Check" lamp. If the problem is double feed, pressing the "Stop" button turns off the "Check" lamp.</li> <li>• If it blinks at four seconds intervals, this means that cleaning the ADF is necessary.</li> </ul>

## ■ Counter Display

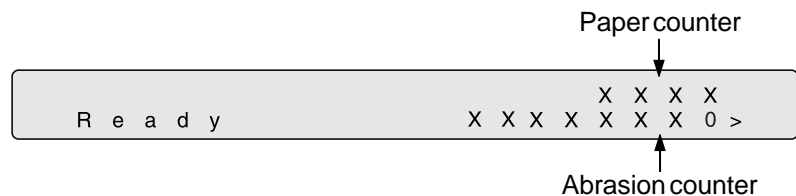
The scanner is provided with a counter display.



Counter	Function	
Paper counter	When the  button is pressed	The paper counter counts the number of scanned sheets from the start of reading until Paper Empty or an error is detected. The counter is automatically reset at the start of reading. The counter is used for checking the number of the sheets scanned in one batch.
	When the  button is pressed	This counter increments each time a document is scanned. It is not initialized until the power is turned off. The counter can be used, for example, for checking the number of sheets that have been scanned in one day.
Abrasion counter	The abrasion counter counts the accumulated number of scanned sheets. This counter increments every 10 sheets. It is useful to check the cleaning cycle or the parts replacement cycle. How to reset it is described in Chapter 6.	

### NOTICE

When the counter value is 0, no number is displayed.

## ■ Operation status

The operation status is indicated by the following messages:

<Power-on>

W a r m i n g - u p N o w ! !

<Reading>

N o w R e a d i n g !

<Waiting for Start>

The scanner displays the following screen when waiting for the Start button to be pressed:

(Only When the Video Interface Option is installed.)

S t a r t S W O N !

<Cleaning request>

When the Pick roller cleaning is necessary, the scanner displays the following on the upper line:

C l e a n P i c k r o l l e r  
N o w R e a d i n g !

When the ADF glass cleaning is necessary, the scanner displays the following on the LCD:

C l e a n A D F G l a s s  
N o w R e a d i n g !

Clean the Pick roller or the ADF glass in accordance with the manual, "Cleaning and Maintenance".

## ■ Temporary error

<Hopper empty>

P a p e r E m p t y

This message is displayed if there is no more paper on the ADF paper chute during a read operation in ADF mode. Fill the ADF paper chute with paper. To enable the read operation, press the stop button.

<Jam>

P a p e r J a m

This message is displayed if a document is jammed in the ADF. See the "Cleaning and Maintenance" manual for removing jammed documents.

<ADF cover open>

A D F - C o v e r O p e n

This message is displayed if the ADF is not closed completely. Close the ADF completely, and enable the read operation.

<Double feed error>

D o u b l e F e e d

This message is displayed when the ADF detects the Double feed error. Check the document and re-scan the document.

<No print cartridge installed>

N o I n k C a r t r i d g e

This message is displayed when the print cartridge is not installed in the imprinter. Install the print cartridge.

<Print position error or paper alarm>

P r i n t A l a r m

This message is displayed when the print position (▼ mark) of the imprinter is positioned out of the paper path or the stacker is full of paper. Set the imprinter in place or remove paper from the stacker.

## ■ Alarm

One of the following messages is displayed if an error occurs in the scanner. If one of the following error messages is displayed, turn the power Off and then On again. If the same message is displayed, contact your service representative.

<Optical alarm>

O p t i c a l   A l a r m

<FB mechanism alarm>

F l a t b e d  
M e c h a n i c a l   A l a r m

### NOTICE

When the total number of sheets scanned by the ADF is less than 100, the message above and the message below are displayed alternately. Remove the bracket (Shipping Lock) that holds the carrier in place.

C h e c k   S h i p p i n g  
L o c k

<Motor fuse alarm>

M o t o r f u s e   A l a r m

<Lamp fuse alarm>

L a m p f u s e   A l a r m

<Image transfer alarm>  
(only when SCSI is used)

I m g   T r a n s   A l a r m

<Memory alarm>

M e m o r y   A l a r m

<EEPROM alarm>

E E P R O M   A l a r m

<FAN alarm>

F A N   A l a r m

<IPC board alarm>

I P C   B o a r d   A l a r m

### NOTICE

When this message is displayed, turn Off system power and then turn it On again. Alternatively, replace the current cable with one recommended by the manufacturer of the SCSI board. When the cause of the alarm has been corrected, the scanner automatically resumes operation once power is turned On again.

<Imprinter alarm>

I m p r i n t e r   A l a r m

<Image transfer alarm>

I m g T r a n s A l a r m

<Memory alarm>

M e m o r y A l a r m

<EEPROM alarm>

E E P R O M A l a r m

<FAN alarm>

F A N A l a r m

<IPC Board alarm>

I P C B o a r d A l a r m

# ***INSTALLATION AND CONNECTIONS***

---

*The chapter describes how to install and connect the scanner.*

**Precautions**

**Inspection**

**Repositioning the Shipping Lock**

**Cable Connections**

**Mounting the Stacker**

**Setting the SCSI ID and the SCSI Terminator**



# Precautions

---

This section describes precautions to follow when installing the scanner.

To ensure the longevity and proper functioning of your scanner, do not install the scanner in the places and environments described below.

- Place the scanner away from electrical noise sources, strong magnetic fields, and air flow. If the scanner is used near an air conditioner, copying machine, or TV set, the scanner may operate incorrectly.
- Keep the scanner out of the sun and away from heaters. These environments may shorten the scanner life or cause hardware failures.
- Do not install the scanner in a place where vibrations may occur. This environment may cause hardware failures or may cause the scanner to operate incorrectly.
- Do not install the scanner in humid, dusty, or damp places. These environments may shorten the scanner life or cause hardware failures.
- Do not place the scanner where liquid spills may occur.
- Be aware of static electricity, which can damage the scanner's sensitive electronic parts. Be sure the flooring and the desk are made of materials that do not generate static electricity.

For information on the minimum required size of the installation space, see Chapter 5, "Specifications".

# Inspection

This section describes how to check the labels.

Position of two labels

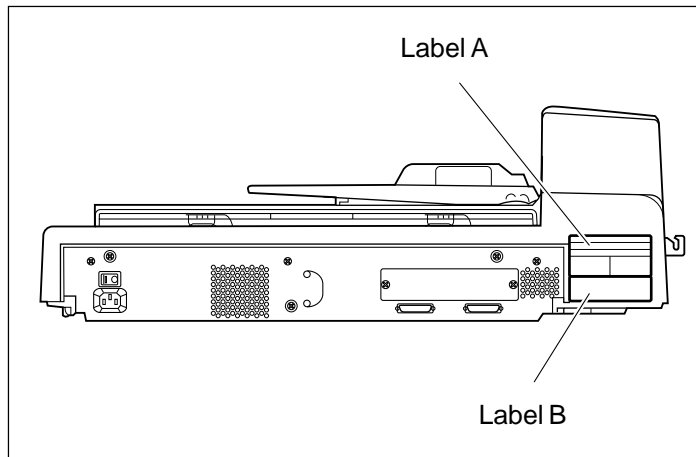

Label A (Example; your actual label may differ)

Indicates regulations and standards to which this scanner conforms.

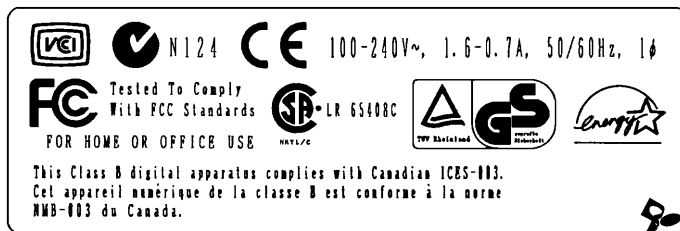

Label B (Example; your actual label may differ)

Indicates product information as follows:

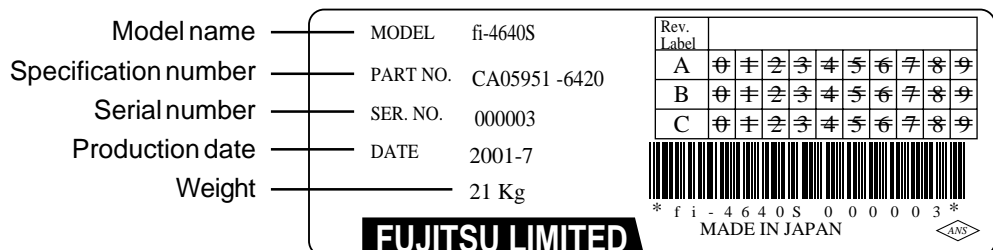

# Repositioning the Shipping Lock

To keep the scanner from being damaged during shipping, the carrier unit is fixed with a Shipping Lock. After placing the carrier unit where it will be installed, change the position of this Shipping Lock as explained below.

- ① Place the image scanner on the edge of the desktop so that the left side of the scanner (where the ADF is attached) extends from the desktop. Do not set the image scanner upside down or on its side.

## ⚠ CAUTION

Do not let the scanner hang more than 20 cm (8 in.) over the edge of the desk.

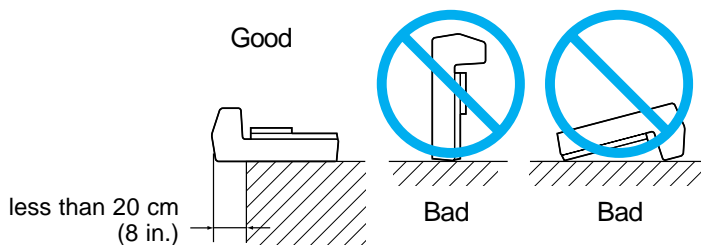

- ② Remove the shipping lock from position (A). Then, install the shipping lock at position (B).

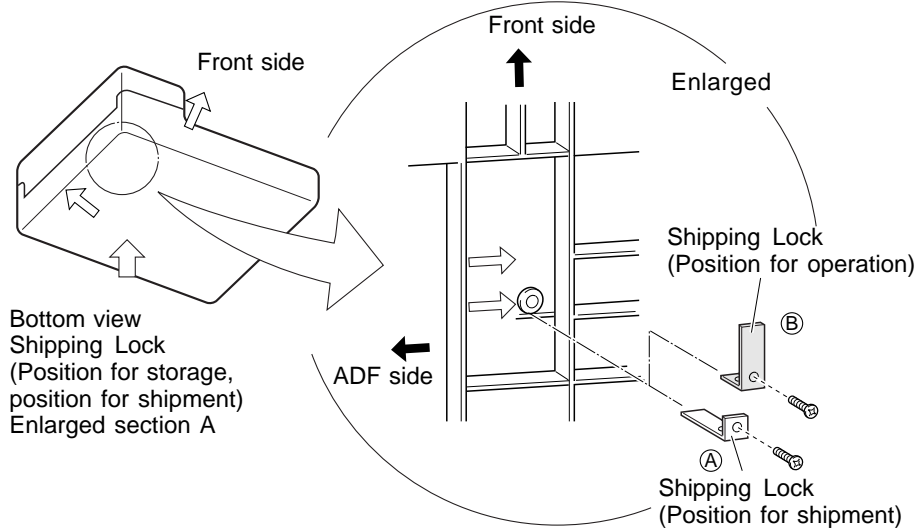

## ⚠ CAUTION

Before moving or storing the scanner, make sure that the shipping lock is set to the shipment position to prevent possible damage. Before setting the shipping lock, make sure that the carrier has been returned to the home position.

# Cable Connections

This section describes how to connect the cables.  
Connect the cables as follows:

## ■ Turning the power switch Off

Press the “O” side of the power switch to turn the power Off.

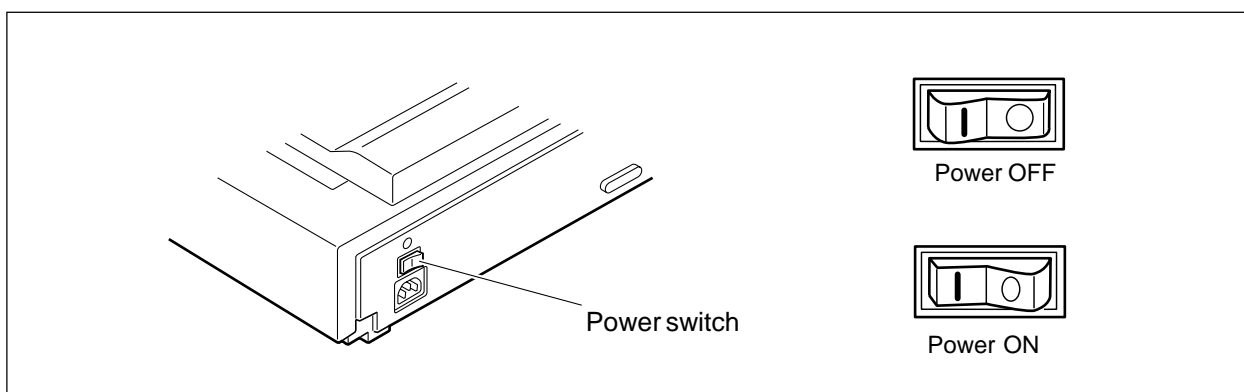

## ■ Connecting the power cable

Connect the power cable to the power inlet of the device and a power outlet.

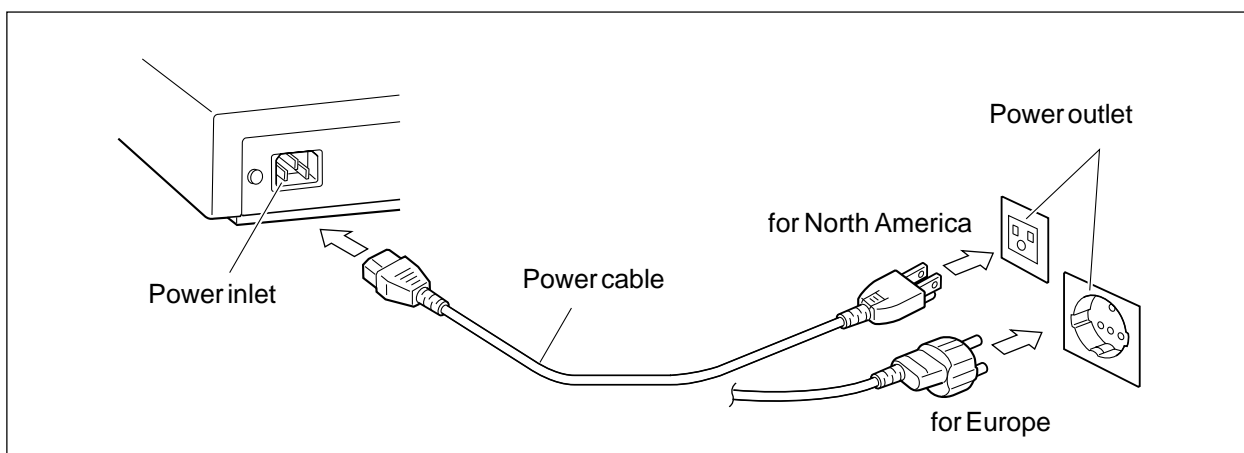

## ■ Connecting the interface cables

Connect the SCSI interface cables and secure them.

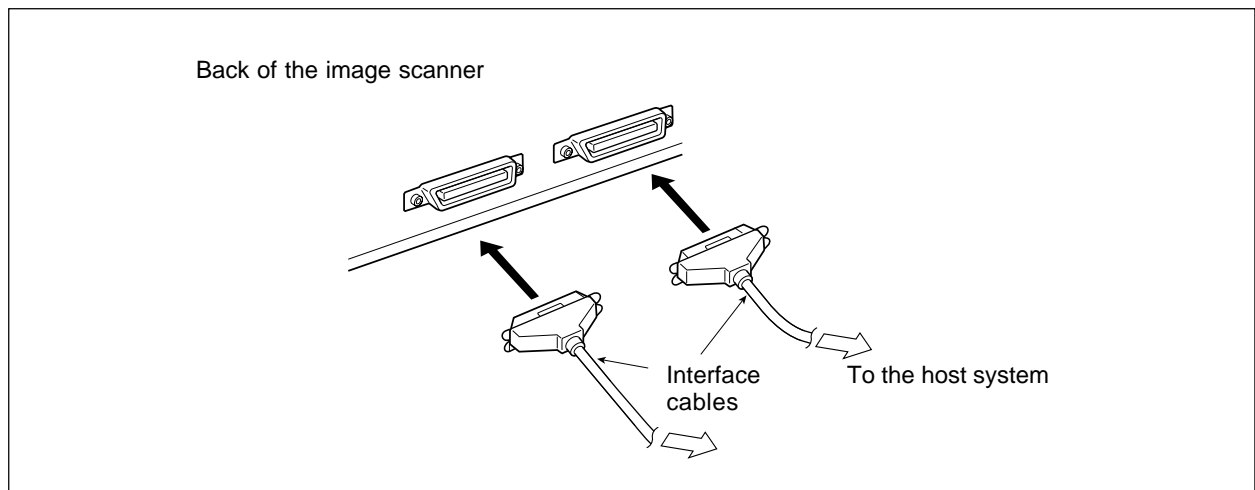

### .NOTICES

1. Factory default for the SCSI terminator is On. If the scanner is in the middle of the daisy chain or of two devices, turn the scanner termination Off via the operator panel.
2. The factory default for the SCSI ID is 5. If the ID of the scanner is the same as the other device, change the ID via the operator panel or change the ID of the other device.

# Mounting the Stacker

Mount the stacker using the following procedure.

- ① Mount the stacker.  
Hook the pins on the stacker to the claws on the image scanner.

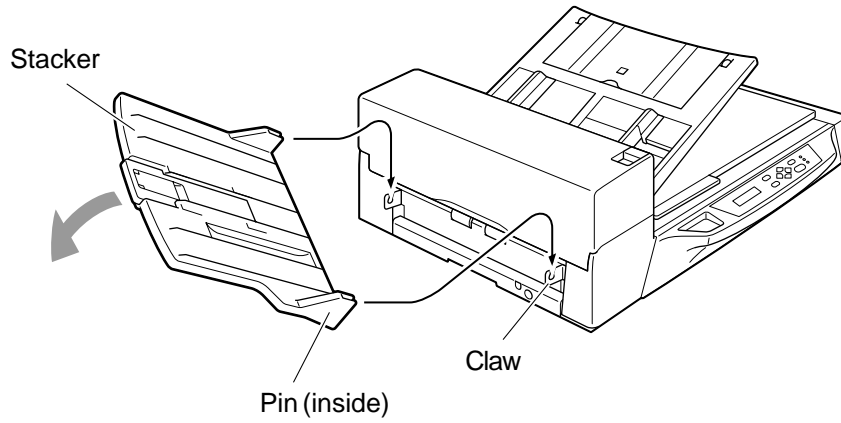

# Setting the SCSI ID and the SCSI Terminator

The default of the SCSI ID is 5. The SCSI ID is set by using the Setup mode of the operator panel. The procedure to change the SCSI ID is as follows:

- 1 Turn the power On by pressing the “I” side of the power switch (see Figure 1.1). The scanner displays “Scanner Ready” on the lower line of the LCD.

```
R e a d y >
```

- 2 Then press the “Next”  button. The scanner displays “Mode select 1”.

```
M o d e s e l e c t 1  
* M a n u a l F e e d
```

- 3 Then press the “Next”  button. The scanner displays “Mode select 2” meaning that the setup mode is ready.



```
M o d e s e l e c t 2  
* S e t u p m o d e
```

- 4 Then press the “Enter” button several times. The scanner displays the following:

```
! 0 1 D o u b l e F e e d C h e c k  
= N o / Y e s - - > 1 / 2 : s t o p
```

- 5 Press the “Next”  button several times, then the scanner displays “SCSI ID” on the upper line of the LCD.

```
! 1 1 S C S I I D  
= 0 / 1 / 2 / 3 / 4 / 5 / 6 / 7
```

- 6 Select the wished SCSI ID by pressing the “” or “” button, and press “Enter” (the SCSI ID is set.)
- 7 Press “Exit” to return to the “Scanner Ready” screen if you don’t need to change the SCSI terminator.

## NOTICE

If no other device is using the same SCSI ID, the scanner ID does not have to be changed.

## NOTICE

The new ID does not take effect until the system power is turned On again.

- 8 Press “Next”  , then the scanner displays “Terminator” on the upper line of the LCD.

```
! 1 2 T e r m i n a t o r  
o n / o f f
```

Select “On” or “Off” by pressing  or  , then press “Enter”.

## NOTICE

The scanner includes a SCSI terminator that can be turned On and Off from the operator panel of the scanner. The factory default is “On.”

- 9 Press “Exit” to return to the “Scanner Ready” state.





# ***OPERATING INSTRUCTION***

---

*This chapter describes how to turn the power on, and gives button specifications and reading mode settings for both ADF and Manual modes, how to load documents onto the ADF and Flatbed, how to load documents larger than the Document bed, and how to read a page from a thick book.*

*Refer to the “Cleaning and Maintenance” manual for routine scanner maintenance.*

**Turning the Power On**

**Waking up the Scanner from the Low Power Mode**

**Manual Feed Mode Setting**

**Loading Documents on the ADF**

**Loading Documents on the Flatbed**

**Loading Documents Larger than the Document Bed**

**Reading a Page from a Thick Book**

# Turning the Power On

This section describes how to turn the power On.

Press the “I” side of the power switch. The power turns On and the green Power lamp at the operator panel lights.

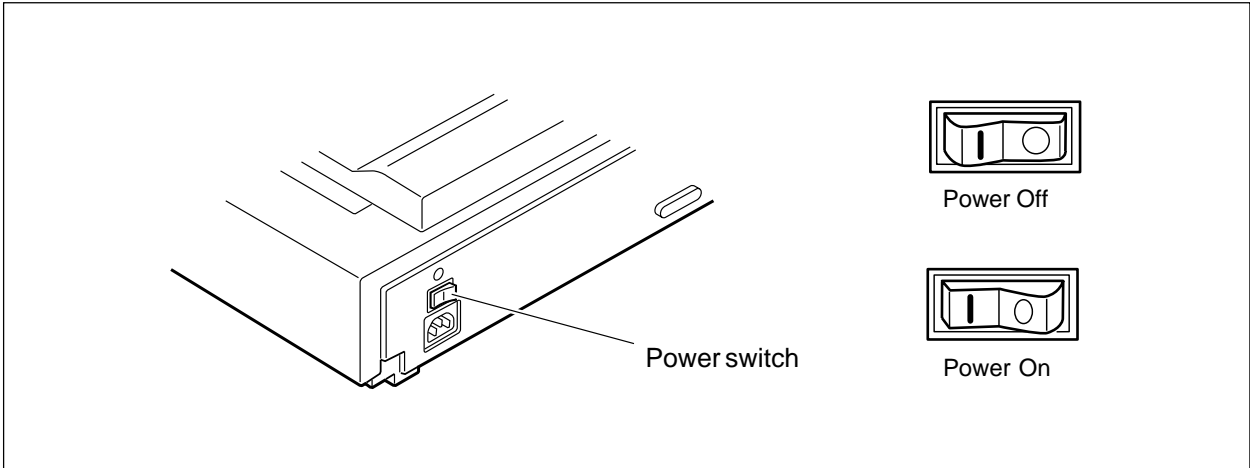

## Waking up the Scanner from the Low Power Mode

This section describes how to wake up the scanner from the Low Power Mode.

To wake up the Scanner, simply press a button, set the papers on the ADF, or send a command to scan from the host computer.

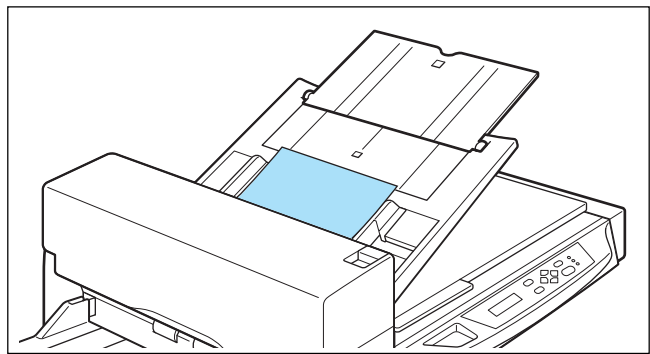
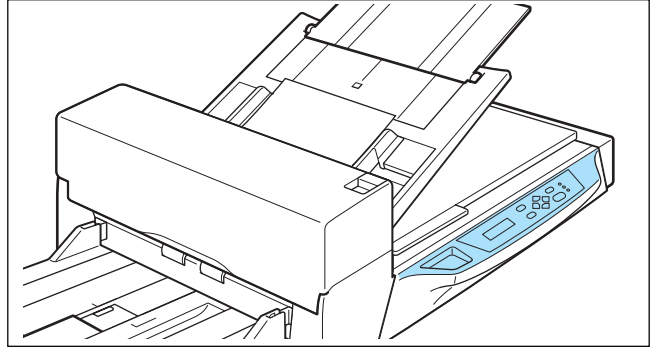

### NOTICE

As an ENERGYSTAR® partner, Fujitsu Limited declares that this scanner meets the ENERGYSTAR® guidelines for energy efficiency.

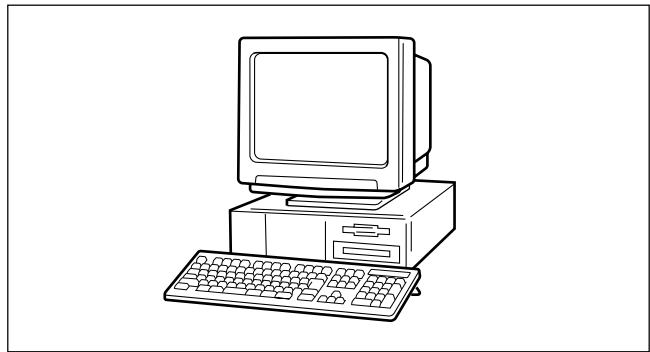

# Manual Feed Mode Setting

In this mode, the scanner waits for some predetermined time before issuing a "Paper Empty" message after all documents are read. This predetermined time (time-out limit) is specified in the Setup mode. Therefore, you can set the next documents on the ADF chute without interrupting the reading operation. The procedures for setting the manual feed mode are as follows:

- 1 Turn the power On and verify that "Scanner Ready" is displayed on the LCD.

<Screen M1>

```
XXXX
Ready XXXXXXXX0 >
```

- 2 Press **Next** then the scanner displays Screen M2.

<Screen M2>

```
Mode Select 0
☐ Reading Mode
```

## NOTICE

The "Mode Select 0" screen is skipped over to "Mode Select 1" when your scanner is controlled through the SCSI interface.

- 3 Press **Next** then the scanner displays Screen M3.

<Screen M3>

```
Mode Select 1
M Manual Feed
```

- 4 Press **Enter** then the scanner displays Screen M4.

<Screen M4>

```
M01 Manual Feed
=No / Yes
```

- 5 Select "Yes" by pressing **◊**. Then press **Enter**.

- 6 Press **Exit** to return to the "Scanner Ready" screen. Note that "Manual Feed" is shown on the LCD. This means that the scanner is in Manual Feed mode.

<Screen M1>

```
Manual XXXX
Ready XXXXXXXX0 >
```

# Loading Documents on the ADF

## NOTICE

Be sure to change the position of the shipping lock according to the “Installation and Connection” procedure before operation.

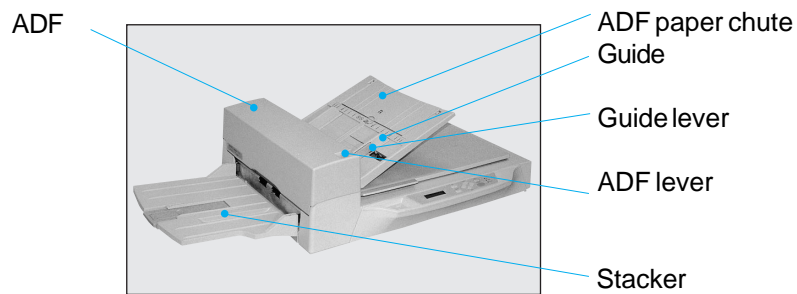

- 1** Lift up the ADF paper chute and lock the bar in its operating position.

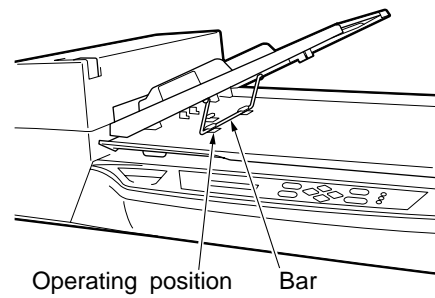

## NOTICES

Note the following when preparing the paper.

- Remove paper clips and staples. Flatten the staple holes.

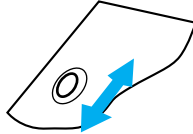

- Read the following documents using the Flatbed:
  - Paper with clips or staples.
  - Paper written on with wet ink.
  - Paper of uneven thickness (for example, envelopes).
  - Paper with large rumples or curls.
  - Paper with folds or tears.
  - Tracing paper.
  - Coated paper.
  - Carbon paper.
  - Paper shorter than A8 (portrait) size or wider than A3 size or 11 x 17 inches.
  - Materials other than paper (for example, clothes, sheet metal, or OHP film).
  - Photographic paper.
  - Paper with perforations on the side.
  - Non-rectangular paper.
  - Very thin paper.
- Set documents on the ADF so that the curl of the leading edge does not exceed the measures shown below.

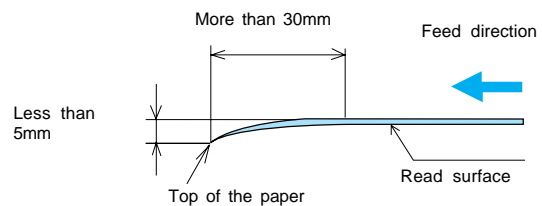
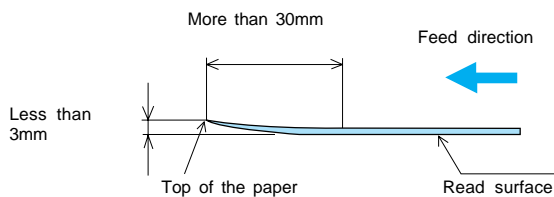

- To avoid skewing, do not feed documents of different widths during the same batch.

- 3** Adjust the stacker extension to the paper size, and then flip out the plate.

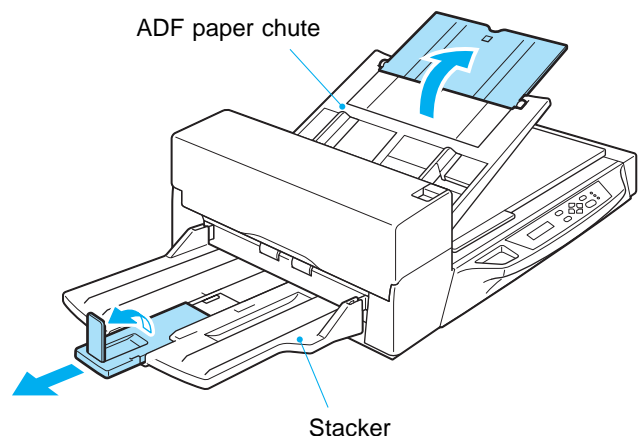

## NOTICES

Note the following when preparing the paper.

- Remove paper clips and staples. Flatten the staple holes.

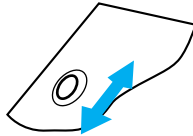

- Read the following documents using the Flatbed:
  - Paper with clips or staples.
  - Paper written on with wet ink.
  - Paper of uneven thickness (for example, envelopes).
  - Paper with large rumples or curls.
  - Paper with folds or tears.
  - Tracing paper.
  - Coated paper.
  - Carbon paper.
  - Paper smaller than A8 (portrait) size or wider than A3 size.
  - Materials other than paper (for example, clothes, sheet metal, or OHP film).
  - Photographic paper.
  - Paper with perforations on the side.
  - Non-rectangular paper.
  - Very thin paper.
- Set documents on the ADF so that the curl of the leading edge does not exceed the measures shown below.

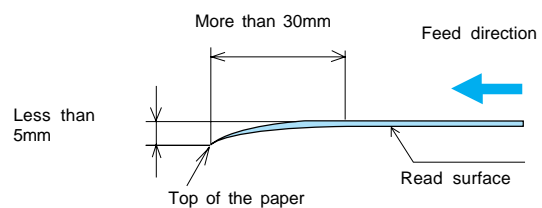
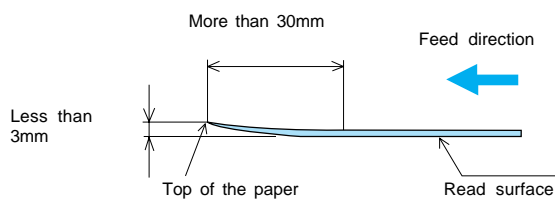

- To avoid skewing, do not feed documents of different widths during the same batch.

- 3** Adjust the stacker extension to the paper size, and then flip out the plate.

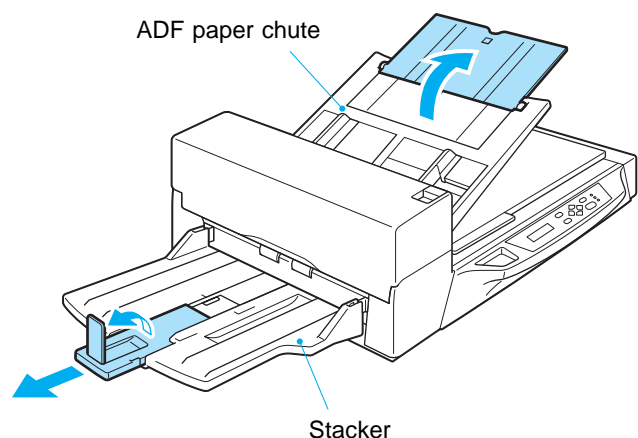

- 4** Set the guides so that there is a small clearance between the document edges and the guides. Load the document face down on the ADF paper chute and adjust the guides to the document width.

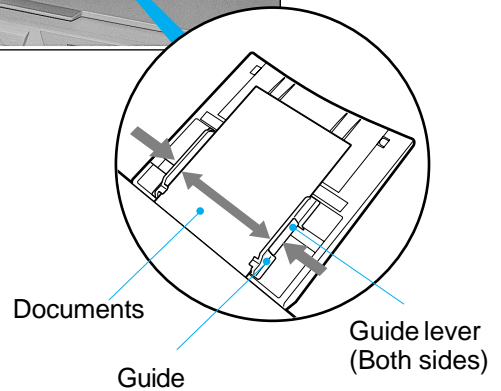
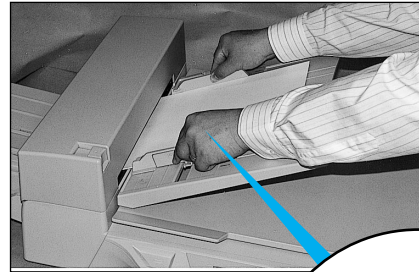

#### NOTICES

- Squeeze the guide lever to free the guides.
- Do not load document stacks thicker than 8 mm.
- Set the guides so that they touch the document sides.

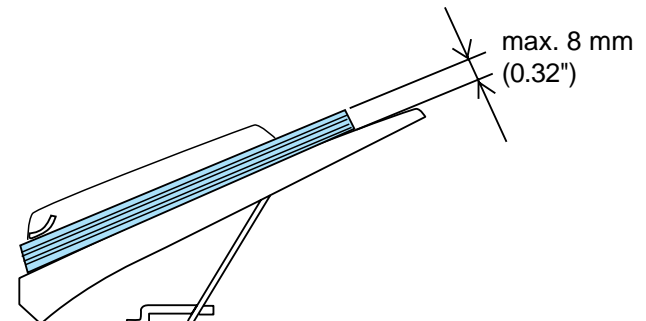

- 5** After the read command is issued from the host system and the documents are read, scanned documents are expelled into the stacker for removal.

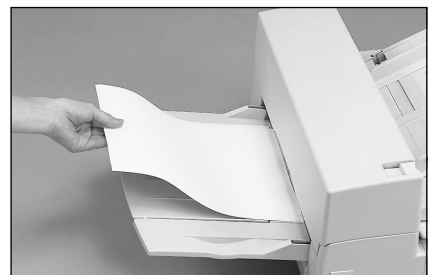



# Loading Documents on the Flatbed

## CAUTION

Do not look directly at the light source during the read operation.

### Scanner parts involved when loading documents

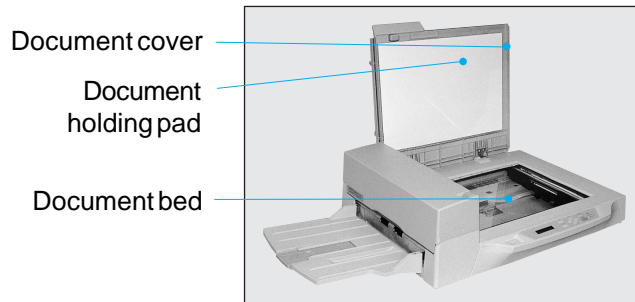

- 1** Open the document cover.

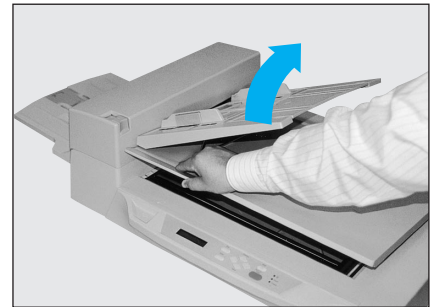

- 2** Place the document face down and align the top left corner with the reference mark.

- 3** Slowly close the Document cover.

- 4** Issue the read command from the host system.

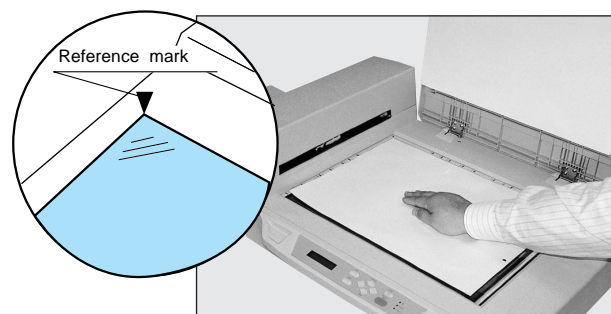

# Loading Documents Larger than the Document Bed

## CAUTION

Do not look directly at the light source during read operation.

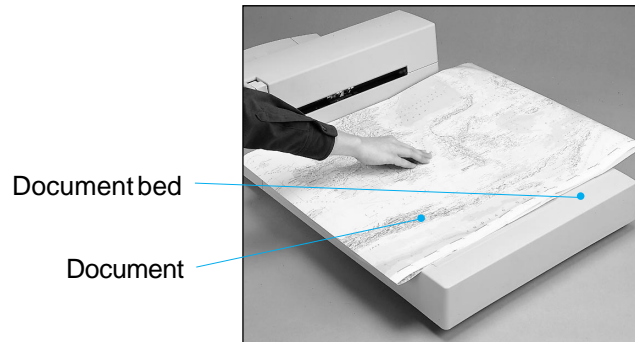

- 1** Open the Document cover to an angle of approximately 90 degrees and slide the cover in the direction of the arrow to remove it.

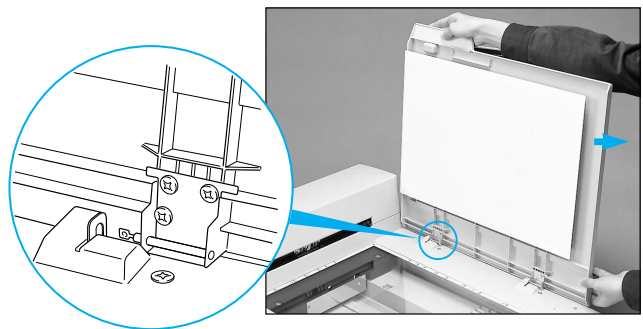

- 2** Place the document face down on the Document bed. Issue the read command from the host system.

- 3** After the read operation, remove the document, re-attach the Document cover and close it gently.



# Reading a Page from a Thick Book

## CAUTION

Do not look directly at the light source during the read operation.

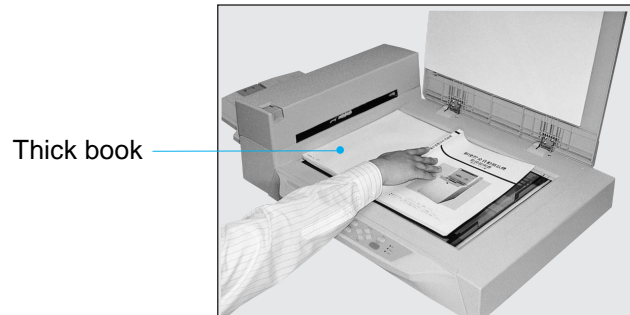

- 1** Open the Document cover.

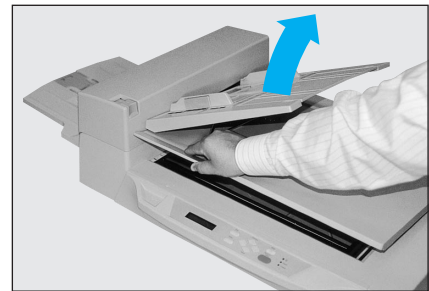

- 2** Place the book face down on the Document bed.

- 3** Issue the read command from the host system. Keep the cover open for the reading operation.

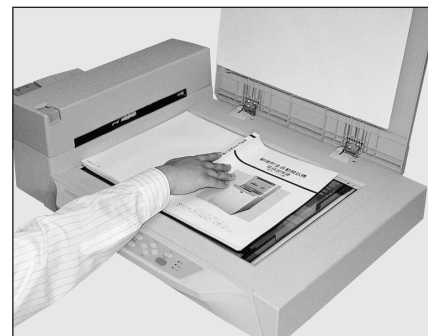

## NOTICE

Do not move the book during the read operation.

# ***ADF DOCUMENT SPECIFICATION***

---

*This chapter describes the document size and document quality required to use the ADF successfully.*

**Document Size**

**Document Quality**

**ADF Document Feeder Capacity**

**Areas not to be Perforated**

**Grounding Color Areas**

**Double Feed Detection Condition**

**Job Separation Sheet**

# Document Size

---

The following figure shows document sizes that the scanner can read using the ADF.

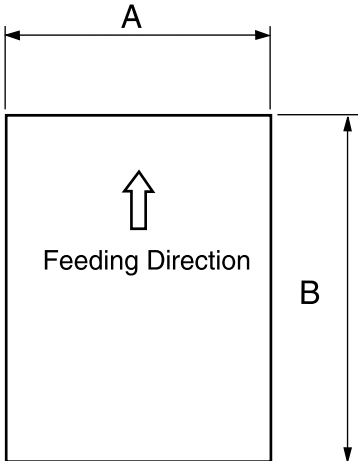

Scanner	Maximum		Minimum	
	A	B	A	B
fi-4640S	297 mm (11.7")	432 mm (17")	53 mm (2.1")	74 mm (2.9")

# Document Quality

This section describes the types and weights of paper that the scanner can read and precautions in preparing documents to ensure maximal scanner functioning.

## ■ Document type

The recommended paper type for documents is as follows:

- Woodfree paper
- Plain paper (for example, the paper type specified for XEROX 4024)

When using any other type of paper, test feed a few sheets with the ADF to ensure the paper feeds properly before performing a large-scale reading operation.

Any paper can be used on the flatbed. However, the ground color specification must satisfy the specification described in the Grounding Color Area section.

## ■ Paper weight

The paper weight should fall within the following ranges:

- 52 to 127 g/m<sup>2</sup> (13.9 to 34 lb), 127g/m<sup>2</sup> (34lb) for A8

## ■ Precautions

### CAUTION

As there is always a slight chance that a document may be damaged when using the ADF, important original documents should never be fed through the ADF. Instead, read them manually using the flatbed.

A preliminary document feed test may be necessary to avoid unexpected errors. If document slip or jam in the ADF (JAM error) or double feed occurs frequently, read the documents manually using the flatbed.

The following documents may be difficult to read properly using the ADF:

- Paper with clips or staples.
- Paper written on with wet ink.
- Paper without a constant thickness. (like envelopes)
- Paper with large rumples or curls. (See the NOTICE on the next page.)
- Paper with folds or tears.
- Tracing paper.
- Coated paper (for example, some paper used for color printing).
- Carbon paper.
- Paper smaller than A8 (Portrait) size, or larger than A3 or Double Letter.
- Materials other than paper (for example, clothes, metal foil, or OHP film).
- Photographic paper.
- Paper with notches on its side.
- Non-rectangular paper.
- Very thin paper.

---

## NOTICES

1. When scanning a translucent document, set the density to light mode.
2. Carbonless papers have a chemical composition that damages the Pad and Pick roller. Therefore, note the following:

Cleaning: If mispicks occur frequently, clean the Pad and Pick roller in accordance with the "Cleaning and Maintenance" manual.

Replacement of parts: The life of the Pad and Pick roller may be shorter than if PPC paper documents are fed.

3. The leading edge of all documents fed using the ADF should be straightened so the curl of the paper meets the specifications shown below:

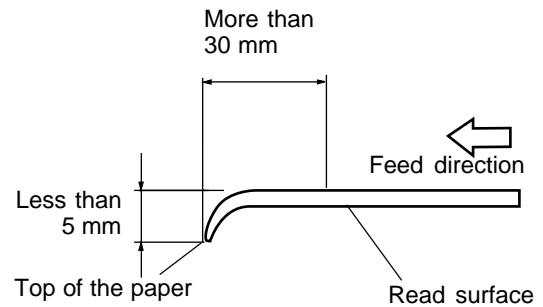
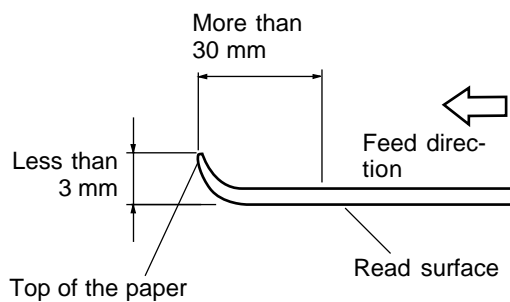

# ADF Document Feeder Capacity

The number of pages that can be loaded into the ADF chute depends on the paper size and the ream weight. This information is shown in the following graph:

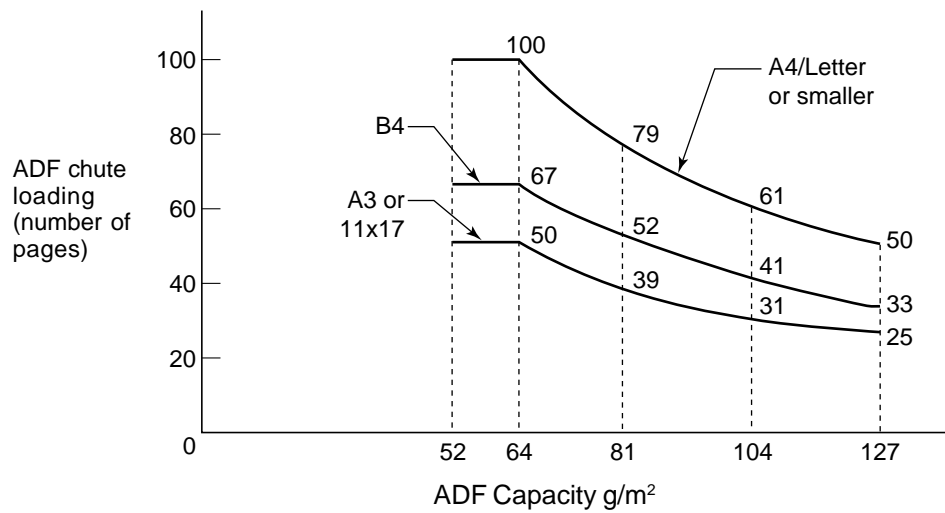

Paper weight conversion table

Country	Unit	Conversion						
		45	55	64.6	77.5	90	109.8	135
Japan	kg/ream	45	55	64.6	77.5	90	109.8	135
US	lb	13.9	17	20	24	27.9	34	41.8
Europe	g/m <sup>2</sup>	52	64	75	90	104	127	157



# Areas not to be Perforated

With the ADF, perforations in the shaded areas may cause errors. If you must read data from such a paper, use the flatbed:

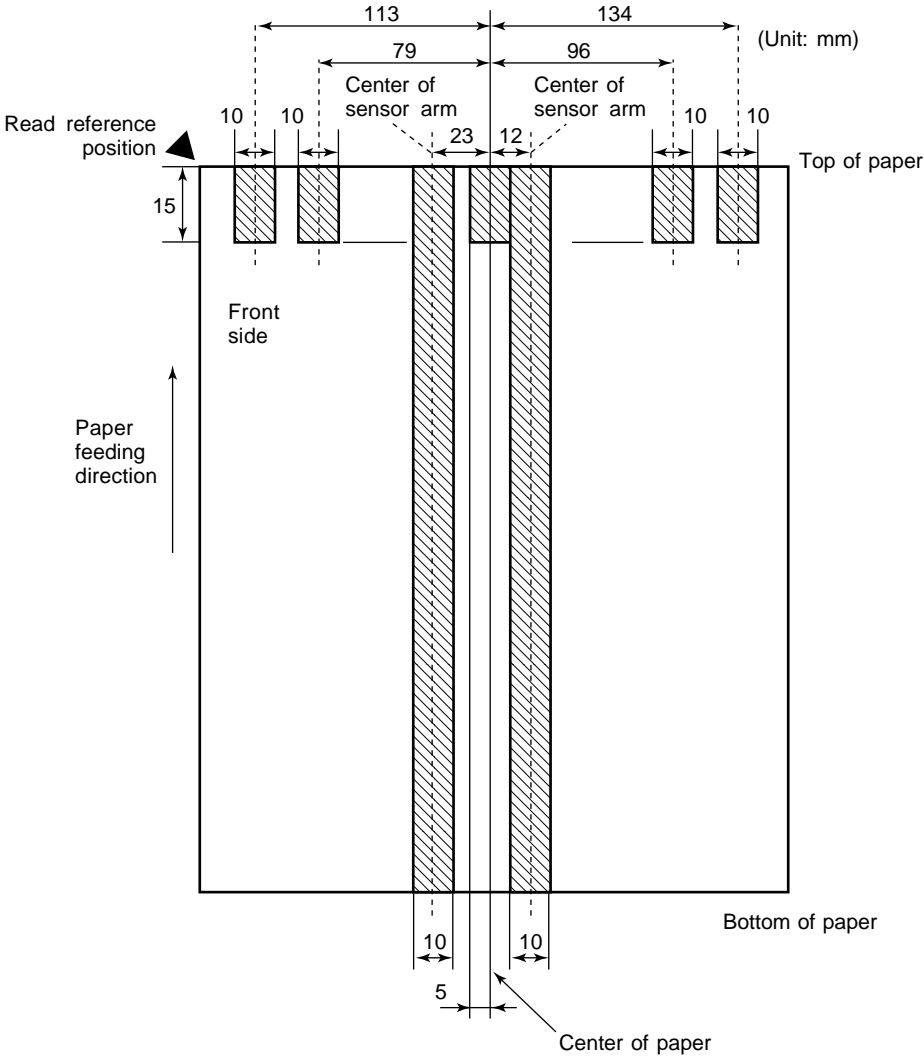

**Areas that must not be perforated**

# Grounding Color Areas

The shaded area in the Figure below should have paper grounding color (white) or drop-out color. If not, turn the white level following Off when reading.

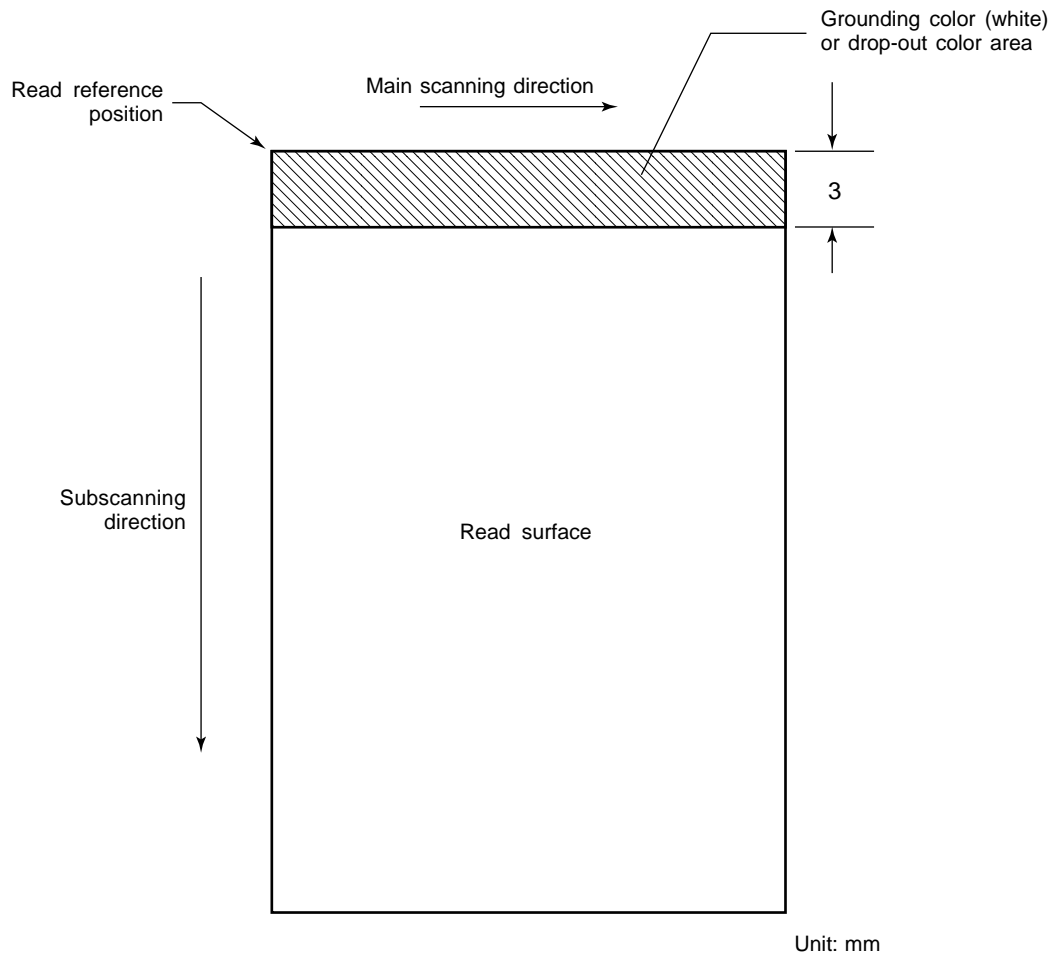

**Grounding color area**

# Double Feed Detection Condition

When the double-feed sensor is used, the thickness or the combination of the thickness and the length of the document is subject to the following specifications:

- 1 Thickness: 0.065 mm to 0.15 mm
- 2 Paper length accuracy: 1% or less
- 3 Any black print at the center of the leading edge of the paper is not allowed. (10 mm x 10 mm)
- 4 No binding holes are allowed within 35 mm of the middle (halfway point) along the center of the paper.
- 5 Printing duty: 12 % or less
- 6 The deviation of the amount of transparent light on the base color area should be less than 10 %.

## NOTICE

Certain paper types or a certain condition of paper result in lower detection rates in terms of double feed detection.

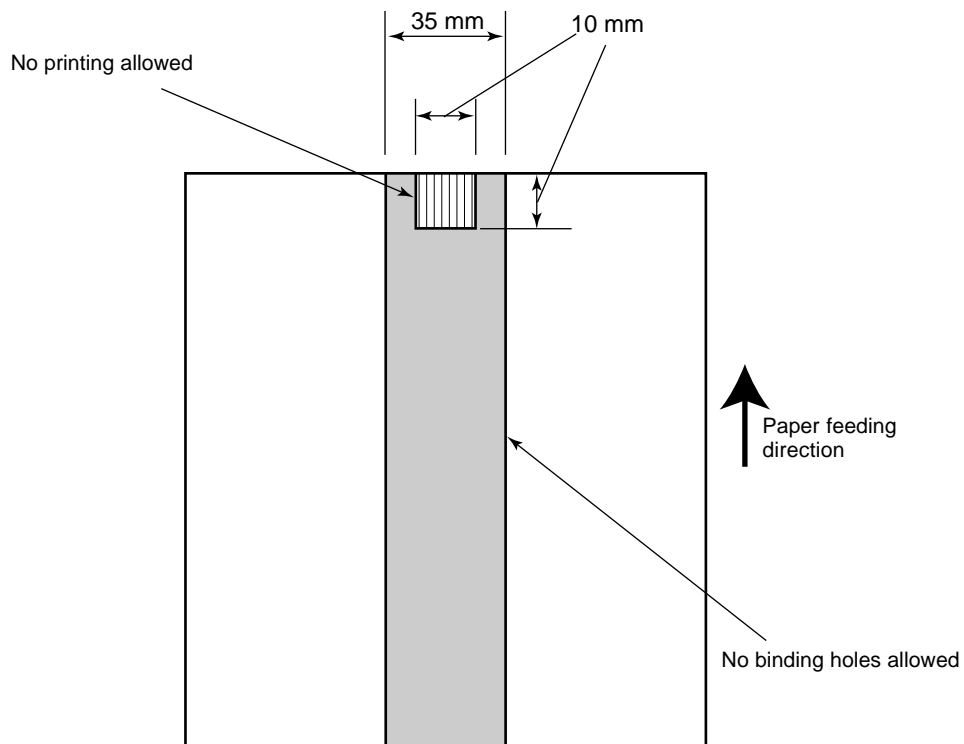

# Job Separation Sheet

## 1 Shape

The following shows the typical format of the job separation sheet.

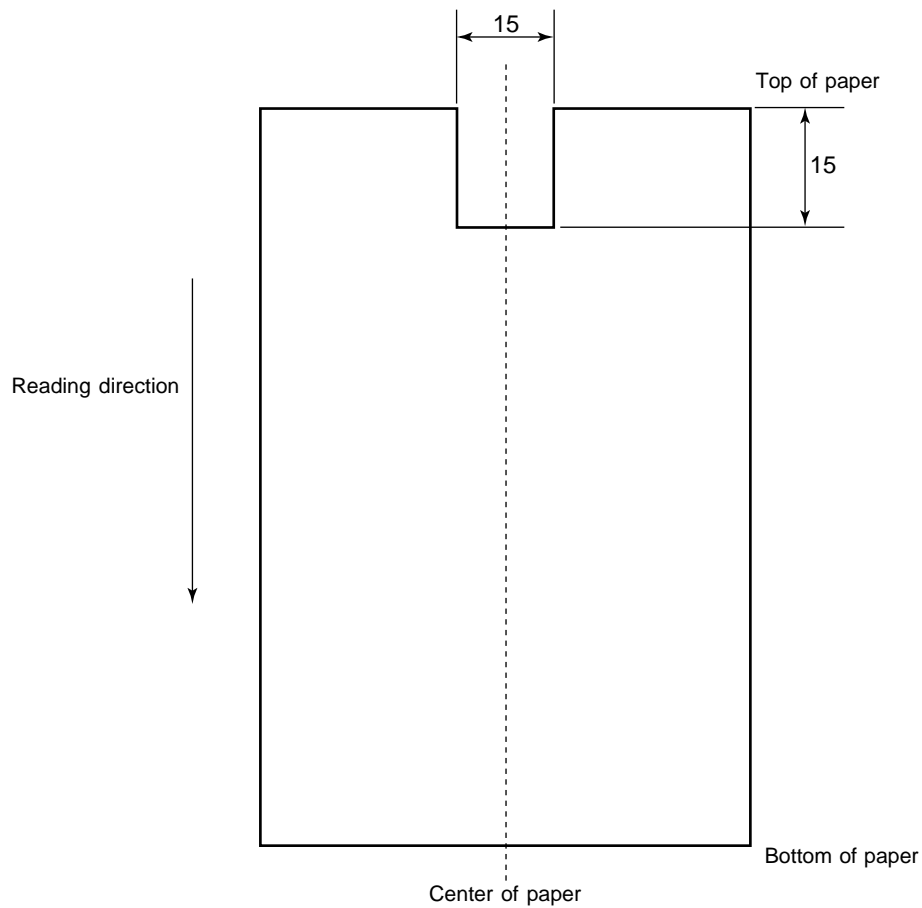

**Job separation sheet**

## 2 Paper conditions

The paper conditions are the same as the specification described before. But the paper width must be A4 or larger (210 mm or larger in width).

# ***SCANNER SPECIFICATIONS***

---

*This chapter describes the basic product specifications, installation specifications, and dimensions.*

**Basic Product Specification**

**Installation Specification**

**Dimensions**

# Basic Product Specification

Nº.	Item	Specification	Remarks
1	Operating method	ADF (simplex), flatbed	
2	Image sensor	CCD x1	
3	Light source	Inert gas (Xenon) lamp	Green
4	Document Size	Minimum	A8 (Portrait)
		Maximum	A3 or 11x17
5	Document Thickness	52 g/m <sup>2</sup> (14 lb) to 127 g/m <sup>2</sup> (34 lb)	Note *1
6	Optical Resolution	400 dpi	
7	Output Resolution	Binary	100/150/200/240/300/400/600/800 dpi
		Grayscale	100/150/200/240/300/400/600 dpi
8	Grayscale level (internal)	1024 levels (10 bits)	
9	Scanning speed (mechanical) Note *2	45ppm, 200dpi, A4, Portrait 32ppm, 300dpi, A4, Portrait 56ppm, 200dpi, A4, Landscape	Note *3
10	Halftone patterns	Dither/Error diffusion	
11	Capacity of ADF	100 sheets (A4, 64 g/m <sup>2</sup> (17 lb))	Note *4
12	Compression	MH/MR/MMR	Note *5
13	Interface Note *6	SCSI-2	High Density (Half) 50-pin, Female
		Third Party Slot	Note *7

- Notes**
- \*1: The details are described in chapter 4.
  - \*2: The actual scanning speed might differ due to host computers' environment.
  - \*3: These speeds do not contain processing time at the host computer.
  - \*4: The maximum number will differ due to the paper thickness. Refer to chapter 4.
  - \*5: The scanning speed might be slow. The usage with NO COMPRESSION is recommended.
  - \*6: Both SCSI-2 and the Third Party Slot can not be used at the same time.
  - \*7: The Power consumption of the boards should be as follows:
    - In the Low Power Mode: Less than 0.35 A
    - With fi-IPC4D option: Less than 1.5 A
    - Without fi-IPC4D option: Less than 3.0 A

# Installation Specification

The following table lists the installation specifications of the scanner.

Item		Specification		
Dimensions (mm) (Without Hopper and Stacker)		Depth	Width	Height
		696 (27.4")	521 (20.5")	234 (9.2")
Weight (kg)		21 (46.3 lb.)		
Input power	Voltage	100 to 127 VAC or 200 to 240 VAC $\pm$ 10 %		
	Phases	Single-phase		
	Frequency	50/60 $\pm$ 3 Hz		
Power consumption		160 VA or less		
Ambient condition	Device status	Operating	Not operating	
	Temperature	5 to 35°C (41 to 95°F)	-20 to 60°C (-4 to 140°F)	
	Humidity	20 to 80 %	8 to 95 %	
Heat capacity		78 kcal/H (313 BTU/H)		
Shipping Weight (kg)		27 (59.5 lb)		

# Dimensions

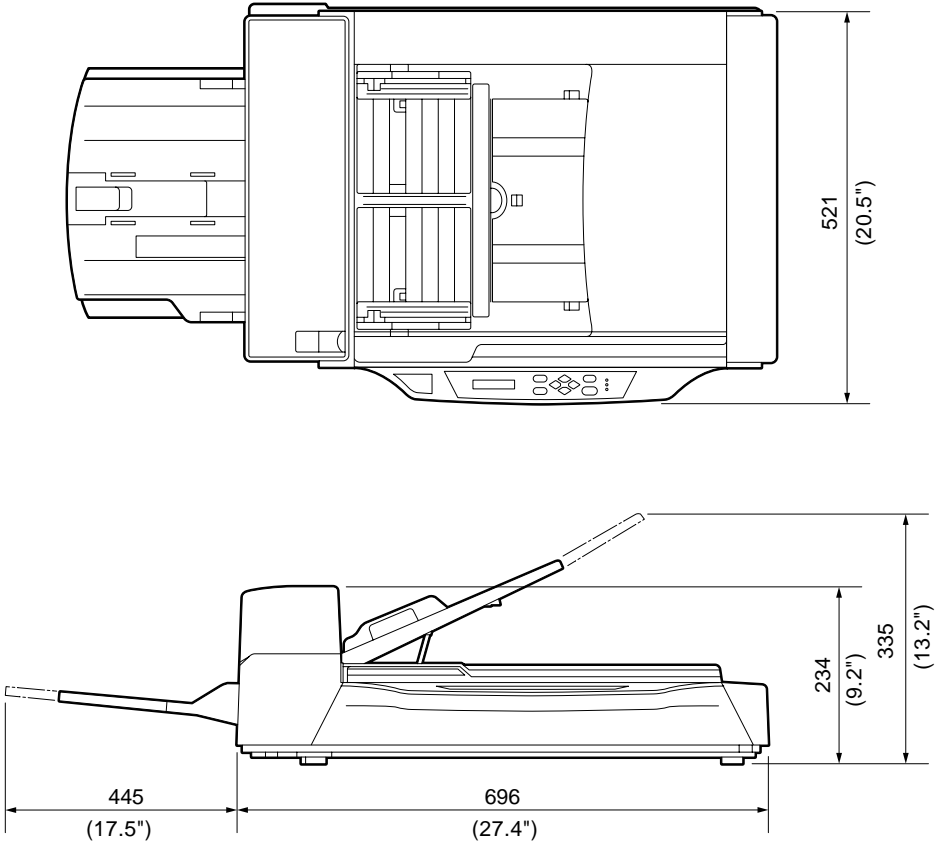

(unit: mm)





# ***CONSUMABLES AND OPTIONS***

---

*This chapter describes the consumables and options. Available options are video interface board, IPC-4D, and fi-475PR (imprinter).*

**Consumables List**

**Options List**

**Video Interface Board Option**

**IPC-4D Option**

**fi-475PR Option (Imprinter)**

# Consumables List

The following table lists consumables used for the scanner. Be sure to keep some consumables in stock. The customer is responsible for changing these items periodically, in accordance with the guideline of the service life given below and in the “Cleaning and Maintenance” manual. If they are not changed as recommended, the scanner may not function properly. The abrasion counter can be used to check the total number of documents scanned since the last replacement(s).

Name	Specification	Service life (guideline)
Pad ASY	PA03951-0151	100,000 sheets or one year.
Pick rollers	PA03951-0153	200,000 sheets or one year. (Two rollers are included.)

 **NOTICE**

Refer to the Cleaning and Maintenance guide for replacing the consumables.

 **NOTICE**

Certain paper types or conditions might reduce the life of consumables.

# Options List

---

The following table lists options available for the scanner.

Name	P/N	Remarks
Video interface board	CA02956-2391	
IPC-4D	CA02919-0521	IPC: Image processing circuit One per unit
fi-475PR	CA02956-2395	Imprinter unit with a print cartridge

Contact your representative sales agent for more information.

# Video Interface Board Option

## ■ How to Install the Video Interface Board

- 1** Loosen the two screws to remove the plate.

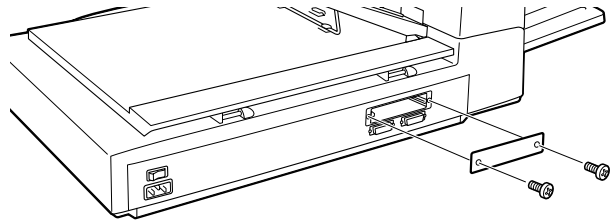

### **⚠ WARNING**

Turn Off the power before removing the Third Party Slot plate.

- 2** Insert the board along the rails of the third party slot. Make sure that the connector is connected securely. Secure the board with two screws.

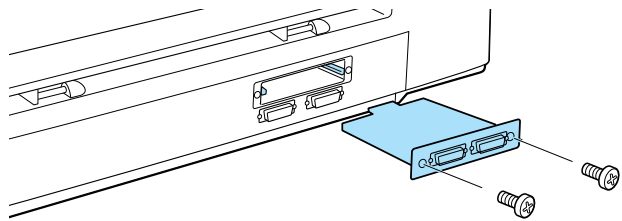

### **⚠ CAUTION**

Protective measures are required to prevent damage from static electricity.

### **📄 NOTICE**

When the scanner power is turned On again, the scanner automatically recognizes the video interface board.

## ■ Reading Mode Setting When the Video Interface Board is Installed

This section describes the button specifications and setup details for reading modes when the scanner has the video interface board in the third party slot.

When the reading mode is set by the command from the host computer, the following button operation is not required.

### NOTICE

When the video interface board is installed in the scanner, the scanner automatically recognizes the board and changes the display.

Whenever you press **[Exit]**, the scanner returns to screen M1.

- 1 Turn the power On and verify that "Scanner Ready" is displayed on the LCD.

<Screen M1>

```
XXXX
Ready XXXXXXXX0 >
```

- 2 Press **[Next]** then the scanner displays Screen M2.

<Screen M2>

```
Mode Select 0
▣ Reading Mode
```

- 3 Press **[Enter]** then the scanner displays Screen 1.

- 4 Select ADF or FB by pressing **◀** or **▶** then press **[Enter]**. The scanner displays Screen 2.

<Screen 1>

```
▣01 Image Source
= ADF / FB
```

- 5 Select "Portrait" or "Landscape" by pressing **◀** or **▶**. Then press **[Enter]**. The scanner displays Screen 3.

<Screen 2>

```
▣03 Orientation
= Port / Land
```

- 6 Select Size by pressing **◀** or **▶**. Then press **[Enter]**. The scanner displays Screen 4.







<Screen 3>

```
▣04 Size
= A4 / A3 / LT / LG / DLT
```

- 7 Select Resolution by pressing **◀** or **▶**. As the cursor moves to the left 100/150 may appear. Then press **[Enter]**. The scanner displays Screen 5.

<Screen 4>











```
▣05 Resolution
= 200 / 240 / 300 / 400
```

- 8 Select Density by pressing  or . As the cursor moves to the right,   /  /  may appear. Then press . The scanner displays Screen 6.



<Screen 5>



Density display

Without IPC-4D option	With IPC-4D option	Description
		Very dark
		Dark
AT2	AT1 (*)	Dynamic Threshold (DTC mode)
	AT2 (*)	Simplified Dynamic Threshold (IPC mode)
		Normal
		Light
		Very light

\* This parameter appears only when the IPC-4D is installed.

- 9 Select Halftone by pressing  or .

<Screen 6>

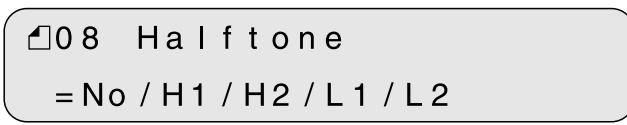

 **NOTICE**

This screen is disolayed when FB is selected in Screen 1.



Parameter	Description
No	Halftone is Off . Therefore binary reading is specified.
H1	Halftone with dither is specified.
H2	Halftone with error diffusion is specified.
L1 (*)	Automatic separation with dither is specified.
L2 (*)	Automatic separation with error diffusion is specified.

\* This parameter appears only when the IPC-4D is installed.

Press  to confirm. The scanner displays Screen 7.

<Screen 7>



- 10 Select Document Type by pressing  or .

Parameter	Description
L. (Line)	White level following is ON. Top 3mm part of the document must be left blank (grounding color is drop-out color). Use this specification for reading line arts or texts.
P. (Photo)	White level following is Off Use this specification for reading photographs.

Press  to confirm. The scanner displays Screen 8.

**11** Confirm what you have specified.

If some parameter needs to change, press  or  to select the corresponding screen and re-select the parameter by pressing  or  and finally press . If all parameters are acceptable, press  to return to the "Scanner Ready" screen.

<Screen 8 (Example)>

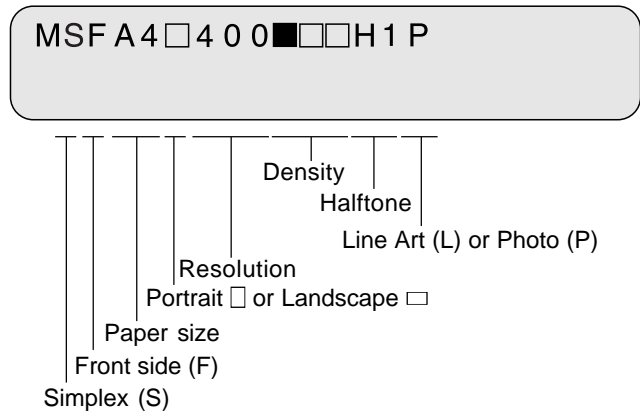



## IPC-4D Option

The IPC-4D option performs the following image processing.

Item	Description
Pre-Filter	Ball-Point Pen Filter : Smooth ball point pen strokes.
Background Removal	Remove background tone and light dither.
Dynamic Threshold	One Pass / Two Pass Dynamic Threshold : Adjust threshold level for binarizing to separate from background. Captures the light text. IPC-2 like Dynamic Threshold : Adjusts the threshold level for binarizing to separate text from backgrounds, thus capturing light text while preserving its sharpness.
Noise Removal	2x2 to 5x5 dot removal by matching : Removes isolated dots in the size of 2x2 to 5x5 pixels.
Auto Separation	Auto Separation : Automatically, detects the text area for binarizing and the photo area for dithering.
Outline Extract	Outline Extract outline of the image
Filter	Emphasis (Low/High) : Emphasis contour. Smooth: Smoothing image by averaging.

### NOTICE

For the installation and functions of the IPC-4D, refer to the supplied manual.

# fi-475PR Option (Imprinter)

The following table shows specifications of the fi-475PR Imprinter.

fi-475PR Imprinter Specifications

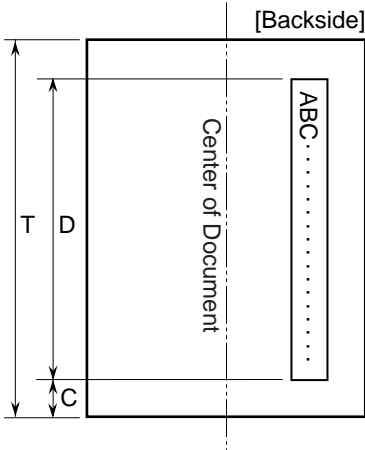
Item	Specification
Printing Method	Thermal inkjet printing
Printed Characters	Alphabet Letters: A to Z, a to z Numeric Characters: 0, 1 to 9 Symbols: ! " # \$ % & ' ( ) * + , - . / : ; < = > ? @ [ ¥ ] ^ _ ' {   } ~
Maximum Number of Characters Printed	40
Character Size	Height 2.91 mm to width 2.82 mm
Character Pitch	About 3.53 mm
Printing Area	<p>The printable area of the backside of document is as follows:</p> <div style="display: flex; align-items: center;"> <div style="margin-right: 20px;"> <p>T Length of document</p> <p><math>D \leq 140.5</math> mm (for 40 columns)</p> <p><math>C \geq 70.0</math> mm</p> <p><math>T - (C + D) \geq 42</math> mm</p> </div> <div>  </div> </div>
Consumable	Print Cartridge

## NOTICE

For installation and functions of the fi-475PR Imprinter, refer to its supplied user's guide.

CHAPTER

7

# ***SETUP MODE***

---

*This chapter describes the setup mode of the scanner.*

**Activating the Setup Mode**

**Contents of the Setup Mode**

# Activating the Setup Mode

This section describes how to activate the setup mode.

- 1 Turn the power On. Then the scanner displays "Scanner Ready" on the LCD.

<Screen M1>

```
XXXX
Ready XXXXXXXX0 >
```

- 2 If the scanner does not have a video interface option, go to the procedure step 3. Press **Next** then the scanner with the video interface option displays Screen M2.

<Screen M2>

```
Mode Select 0
☐ Reading Mode
```

- 3 Press **Next** then the scanner displays Screen M3.

<Screen M3>

```
Mode Select 1
M Manual Feed?
```

- 4 Press **Next** then the scanner displays Screen M4.

<Screen M4>

```
Mode Select 2
! Setup Mode
```

- 5 Press **Enter**. Now the scanner is at Screen 41 (page 7-4) in Setup mode.

<Screen 41>

```
!01 Double Feed
=No/Yes → 1/2:Stop
```

## NOTICE

Any time you press **Exit**, you can return to the "Scanner Ready" screen.

## Contents of the Setup Mode

This section describes the contents of the setup mode.

Nº	Item	Description	Selectable parameters	Default
1	Double feed check	Specifies the double feed detection. Double feed is detected by checking the document length and/or paper thickness.**	No/Yes	No
2	Length check =No/10/15/20 mm	Specifies the document length to enable double feed detection sets the document length.	Tolerance: No/10/15/20mm	No
3	IPC pre-setting	Scanner automatically sets the recommended reading parameters. 3 sets of parameters are available when IPC-4D is not installed.	Document: No 1: Sharpen 2: Darken Character 3: Copy Quality	No
4	Resetting of abrasion counter	Resets the abrasion counter.	---	---
5	Pick start time setting	Specifies the time from document Insertion to the start of picking. User can select the most comfortable Pick start time for the job.	Time: 0.2 to 29.8 sec	1.0 sec
6	Time-out limit setting	Specifies the time the scanner waits for the next document insertion after the last document was scanned.	Time: 27 values from 1 to 1999 sec	30 sec
7	ADF offset setting*	Specifies the horizontal and vertical offset of the image when using the ADF.	Offset: H:-2 to +3 mm V:-2 to +3 mm	Offset: H: 0 mm V: 0 mm
8	Flatbed offset setting*	Horizontal and vertical offset of the FB image is specified.	Offset: H:-2 to +3 mm V:-2 to +3 mm	Offset: H: 0 mm V: 0 mm
9	Option (IPC/Imprinter) status display	Displays the type (IPC-4D) of the IPC option. "IPC PRT" is displayed when the fi-475PR Imprinter Option is installed.	---	---
10	SCSI ID setting	The SCSI ID is selectable. Note that the new setting is made valid after power is turned off and on again.	SCSI ID: 0/1/2/3/4/5/6/7	5
11	SCSI terminator setting	Switches the SCSI terminator On/Off.	On/Off	On
12	Low Power Mode setting	Changes the default setting of the duration for power save.	5 min. to 60 min.	15 min.

(Continued)

Nº	Item	Description	Selectable parameters	Default
13	Select Interface	Selects the interface when the scanner has a board in the Third Party Slot.	Auto/SCSI/TPS	Auto
14	Display TPS Board ID Number	Displays the ID number of the board which is installed in the Third Party Slot.	---	---
15	IPC mode	When the IPC-4D image processing board is installed in the third party Slot, select this IPC-4D board or the image processing circuit built in the scanner.	Scanner/IPC4D	Scanner
16	ADF Edge Erasing	Adjusts the edge areas to be erased from the image scanned by the automatic document feeder (ADF).	Left/Right: 0 to 15 mm Top: 0 to 15 mm Bottom: -7 to +7 mm	Left/Right: 0 mm Top: 0 mm Bottom: 0 mm
17	FB Edge Erasing	Adjusts the edge areas to be erased from the image scanned by the flat bed (FB).	Left/Right: 0 to 15 mm Top: 0 to 15 mm Bottom: 0 to 15 mm	Left/Right: 0 mm Top: 0 mm Bottom: 0 mm
18	Ink Remain	Resets the ink remain counterr.	Reset/No	No
19	Numbering Print	Enables or disables the numbering counter when the fi-475PR Imprinter is installed.	On/Off	Off

\* This offset refers to the difference from the value adjusted by automatic offset adjustment.

\*\* Some restrictions apply to the detection of a double feed.

## 1. Setting double feed detection (Paper Thickness)

When you set the use of double feed detection, you must set it as follows:

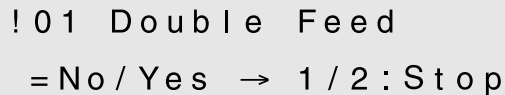

- 1 Press **Next** or **Previous** and let the scanner display Screen 41.

<Screen 41>





! 0 1 Double Feed  
= No / Yes → 1 / 2 : Stop

- 2 At Screen 41.

Press either the  or  button to set the double feed detection according to the paper thickness (transmitted light).

The paper thickness is checked using the difference between two consecutive sheets of paper fed from the ADF. On this screen, select whether or not to check for double feeding, and select the error processing.

Each time either of these buttons is pressed, the location of the blinking moves. When the  button is pressed, the blinking moves from (1) to (3). When the  button is pressed, the blinking moves in the opposite direction. However, if the setting by the host computer is valid, the location of the blinking does not move when either button is pressed.

- |                                       |   |
|---------------------------------------|---|
| (1) "No" is blinking:                 | Paper thickness is not checked.   |
| (2) "Yes" and "1" are blinking:       | Paper thickness is checked. However, a detected double feed error is displayed on the screen only; processing is continued.                 |
| (3) "Yes" and "2: Stop" are blinking: | Paper thickness is checked. When the double feed error is detected, the scan processing is stopped. The error is then reported to the host. |

If you want to disable the double feed, select "No" then press **Enter**. Press **Exit** to return.

### NOTICES

1. Double Feed detection might have better results when both the paper thickness and the paper length are used.
2. When the document in ADF is not the double fed document, the previous document might be double fed, in case the scanner stops feeding by using the double feed detection.
3. Depending on the type of printing on the document, a double feed may not be detected by the paper thickness.

## 2. Setting double feed detection (Paper Length)

- 1 Press **Next** or **Previous** and let the scanner display Screen 42.

<Screen 42>

! 0 2 Length Check  
= No / Yes → 1 / 2 : Stop

- 2 Press either the **◀** or **▶** button to set double feed detection according to paper length. The paper length is checked using the difference between two consecutive sheets of paper fed from the ADF.

Each time either of these buttons is pressed, the location of the blinking moves. When the **▶** button is pressed, the blinking moves from (1) to (3). When the **◀** button is pressed, the blinking moves in the opposite direction. However, if the setting by the host computer is valid, the location of the blinking does not move when either button is pressed.

- (1) **"No"** is blinking: Paper length is not checked.
- (2) **"Yes"** and **"1"** are blinking: Paper length is checked. However, a detected double feed error is displayed only on the screen; processing is continued.
- (3) **"Yes"** and **"2: Stop"** are blinking: Paper length is checked. When the double feed error is detected, the scan processing is stopped. The error is then reported to the host.

If you want to disable the double feed, select "No" then press **Enter**. Press **Exit** to return. After pressing **Enter**, the scanner displays the screen 42-1.

- 3 Press either the **◀** or **▶** button to set double feed detection (paper length). When the **▶** button is pressed, the blinking moves from (1) to (3). When the **◀** button is pressed, the blinking moves in the opposite direction.
  - (1) The **"10"** is blinking: Threshold is 10mm
  - (2) The **"15"** is blinking: Threshold is 15mm
  - (3) The **"20"** is blinking: Threshold is 20mm



<Screen 42-1>



! 0 2 - 1 Length  
= 1 0 / 1 5 / 2 0 mm



### 3. Setting IPC pre-set mode

When you set the use of the IPC pre-set mode, you must set it as follows:

1 Press "Next"  or "Previous"  and let the scanner display Screen 43.

2 At Screen 43, press  or  to select the pre-Setting and press  to activate the pre-setting. Then the scanner displays Screen 43-1.

<Screen 43>



```
! 03 IPC Pre-Set
= No / 1 / 2 / 3
```

#### NOTICES

The following IPC pre-settings can be selected when IPC-4D is installed:

Preset 1: Captures texts printed on the colored background

Preset 2: Produces an image with good contrast

Preset 3: OCR Smoothing

Preset 4: Image Smoothing

Preset 5: Dither

Preset 9: Suitable for pre-printed paper (color)

Preset 10: Suitable for carbon paper

The following built-in IPC pre-settings can be selected even though IPC-4D is not installed:

- Sharpen
- Darken Character
- Copy Quality

3 At Screen 43-1, select "Yes" or "No". Note that when you select "Yes", the IPC setting from the Host computer is ignored. If you select "No", the IPC setting will be changed according to the host setting. Finally press  .

<Screen 43-1>

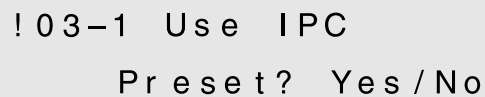



```
! 03-1 Use IPC
Preset? Yes / No
```





#### NOTICE

When you select the Copy Quality, select the scanner and printer settings carefully to get the best quality.

## 4. Reset of the abrasion counter



When you reset the abrasion counter, you must set it as follows:

- 1 Press "Next"  or "Previous"  and let the scanner display Screen 44.

- 2 At Screen 44;  
If you want to reset the abrasion counter, select "Yes" through  or  button and press . Go to procedure 3.  
If you do not want to reset the abrasion counter, select "No" and press . Finally press  to return.

<Screen 44>

```
! 0 4  A b r a s i o n  C N T
= X X X X X X  R e s e t / N o
```



- 3 At Screen 44-1;  
If you want to reset the abrasion counter, select "Yes" and press . If you do not want to reset it, select "No" and press . Press  to return.





<Screen 44-1>

```
! 0 4 - 1  R e s e t / N o w
                N o / Y e s
```

## 5. Setting the pick start time

When you set the pick start time, you must set it as follows:





- 1 Press "Next"  or "Previous"  and let the scanner display Screen 45.

- 2 At Screen 45, press  to increase the Pick start time or press  to decrease the Pick start time. Then press  to activate the setting. Finally press  to return.

<Screen 45>

```
! 0 5  P i c k  s t a r t
= 1 . 0  S e c
```

## 6. Setting the time-out limit

- 1 Press "Next"  or "Previous"  and let the scanner display Screen 46.
- 2 At Screen 46, press  to increase the number or press  to decrease the time-out limit. Then press  to activate the setting.

<Screen 46>

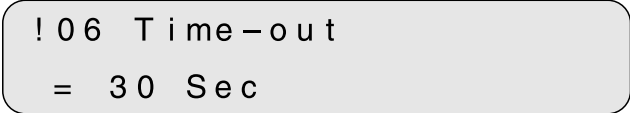

```
! 0 6 Time-out
= 3 0 Sec
```







### NOTICE

Default is 30 seconds.

- 3 Press  to return.

## 7. ADF Offset Setting

### 8. Flatbed Offset Setting

- 1 Press "Next"  or "Previous"  and let the scanner display the following:
  - Offset of the ADF: Screen 47.
  - Offset of the Flatbed: Screen 48.
- 2 At Screen 47, 48, or 49, select "Yes" by pressing the  or  button, then press . The scanner displays Screen A. (X = 7 or 9)
- 3 At Screen A, if you want to let the offset return to default, select "Yes" otherwise "No" then press . The scanner displays Screen B.

<Screen 47>

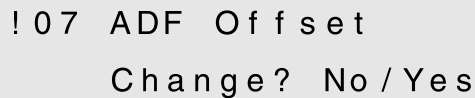

```
! 0 7 ADF Offset
Change? No / Yes
```

<Screen 48>

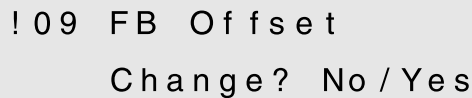

```
! 0 9 FB Offset
Change? No / Yes
```

<Screen A>

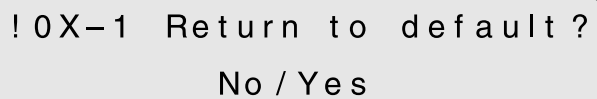

```
! 0 X-1 Return to default?
No / Yes
```

- 4 At Screen B, press  $\blacktriangleleft$  to increase the offset or press  $\blacktriangleright$  to decrease offset. The increment or decrement is 0.5 mm.

Then press **Enter** to activate the setting. The scanner displays Screen C.

- 5 At Screen C, press  $\blacktriangleleft$  to increase the offset or press  $\blacktriangleright$  to decrease the offset. Then press **Enter** to activate the setting. The scanner displays the next item of the setup mode.

<Screen B (Example of ADF Offset)>

! 07-2 ADF H  
H = + 0 . 0 mm ( + : L e f t )

<Screen B (Example of FB Offset)>

! 09-2 FB H  
H = + 0 . 0 mm ( + : L e f t )



<Screen C (Example of ADF Offset)>

! 07-3 ADF V  
V = + 0 . 0 mm ( + : U p )

<Screen C (Example of FB Offset)>

! 09-3 FB V  
V = + 0 . 0 mm ( + : U p )

## 9. Option (IPC/Imprinter) Status Display

1 Press "Next"  or "Previous"  and let the scanner display Screen 49.

<Screen 49>

```
! 1 0   I P C
=   I P C - 4 D
```

2 Screen 49 indicates that the IPC-4D option is installed.

Screen 49-1 indicates that the IPC-4D option is not installed.

<Screen 49-1> (An example)

```
! 1 0   I P C
=   N o
```



Screen 49-2 indicates that the IPC-4D option and the fi-475PR (Imprinter) option are installed.

<Screen 49-2> (An example)

```
! 1 0   I P C       P R T
=   I P C - 4 D       O K
```



3 Press  to return.

## 10. SCSI ID Setting

1 Press "Next"  or "Previous"  and let the scanner display Screen 50.



<Screen 50>

```
! 1 1   S C S I   I D
=   0 / 1 / 2 / 3 / 4 / 5 / 6 / 7
```

2 At Screen 50, press  or  to select SCSI ID. Then press  to activate the setting.



3 Press  to return.

## 11. SCSI Terminator Setting

1 Press "Next"  or "Previous"  and let the scanner display Screen 51.



<Screen 51>

```
! 1 2   T e r m i n a t o r
=           O n / O f f
```

2 At Screen 51, press  or  to select Terminator. Then press  to activate the setting.



3 Press  to return.

## 12. Low Power Mode Setting

- 1 Press "Next"  or "Previous"  and let the scanner display Screen 52.

<Screen 52>

```
! 1 3   P o w e r   S a v e
=    1 0   1 5   2 0 m i n
```

- 2 At Screen 52, press  or  to select the time duration. A minimum of 5 min to the maximum of 60 minutes can be selected. Then press **Enter** to activate the setting.

### .NOTICE



At screen 52, "No" does not mean that you can turn off the "Low Power Mode" (Power Save Mode). You cannot disable the Power Save Mode.

### .NOTICE

The default time recommended by the ENERGYSTAR® program is 15 minutes. The default for the fi-4640S scanner is 15 minutes, as recommended.

- 3 Press **Exit** to return.

## 13. Select Interface

- 1 Press "Next"  or "Previous"  and let the scanner display Screen 53.

<Screen 53>

```
! 1 4   I n t e r f a c e
=    A u t o / S C S I / T P S
```

### .NOTICE



The screen 53 will appear only when the scanner has proper interface boards or option boards in the third party slot.

- 2 At Screen 53, press  or  to select the interface type. Press **Enter** if you want to change the setting.

### .NOTICES

1. Normally, this setting does not have to be changed.
  2. When an appropriate board is installed in the third party slot of the scanner, the scanner automatically turns off the SCSI interface, activating the board in the third party slot. Screen 53 can be used to forcibly change the selected interface. The selected interface is then forcibly changed.
  3. The SCSI interface and the board installed in the third party slot cannot be used at the same time.
  4. The default is Auto.
- 3 Press **Exit** to return.

## 14. Display the TPS Board ID Number

- 1 Press "Next"  or "Previous"  and let the scanner display Screen 54.

The scanner displays the ID number if the applicable board is installed.

<Screen 54> (An Example)

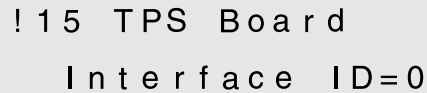



! 15 TPS Board  
Interface ID=0



### NOTICE

If the video interface board is installed properly, the display shows "ID=7".

- 2 Press  to return.

## 15. Select Built-In/IPC-4D Image Processing

- 1 Press "Next"  or  and let the scanner display the Screen 55.

- 2 At Screen 55, press  or  to select "Scanner" or "IPC-4D".

When "Scanner" is selected, the scanner uses its built-in image processing. On the other hand, the scanner uses the image processing of the IPC-4D when the IPC-4D is installed and "IPC-4D" is selected.

<Screen 55>

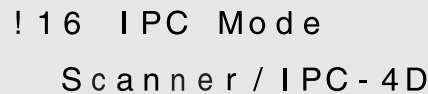

! 16 IPC Mode  
Scanner / IPC-4D

### NOTICE

The factory default is "Scanner".



### NOTICE

fi-4640S has built-in Image Processing. The following image processing is supported both by the fi-4640S and the IPC-4D. As a default, the scanner built-in functions are enabled. By setting "On" using the Operator Panel, the IPC-4D image processing overrides the built-in functions.

	Image Processing	IPC-4D	fi-4640S
1	Emphasis/Smoothing	5 x 5 matrix	3 x 3 matrix
2	Outline	Pre-threshold Laplacian	Laplacian
3	Simplified Dynamic Threshold	IPC-2 like SDTC	3 x 3 max-min



The functions of the IPC-4D are intended for compatibility with those of the IPC-3/3D (except for image quality). The matrix size used in the IPC-4D is larger than the one in the fi-4640S. The fi-4640S Built-in Dynamic Threshold is a new algorithm.

## 16. Adjust ADF Erasing Edges

1 Press "Next"  or "Previous"  and let the scanner display Screen 56.

<Screen 56>

```
! 17 ADF EdgeERS
Change? No / Yes
```

2 At Screen 56, press  or  to select "Yes" and press . Then the scanner displays Screen 56-1.



<Screen 56-1>

```
! 17 - 1 Default?
No / Yes
```

3 At Screen 56-1, select "Yes" to return the settings to the factory default or select "No" to make new settings (as shown below). Then press . The scanner displays Screen 56-2.



<Screen 56-2>

```
! 17 - 2 ADF Top
Top = 0mm
```

4 At Screen 56-2, press  or  to change the top setting. The value changes in 1 mm units. Then press  to activate the setting. The scanner displays Screen 56-3.



<Screen 56-3>

```
! 17 - 3 ADF Bottom
Btm = 0mm ( + : Up )
```

5 At Screen 56-3, press  or  to change the bottom setting. With (+:Up), the area is set upward from the bottom edge of the image. With (-:Down), the area is set downward from the bottom edge of the image. The value changes in 1 mm units. Then press  to activate the setting. The scanner displays Screen 56-4.



<Screen 56-4>

```
! 17 - 4 ADF Left
Left = 0mm
```

6 At Screen 56-4, press  or  to change the left setting. The value changes in 1 mm units. Then press  to activate the setting. The scanner displays Screen 56-5.

<Screen 56-5>

```
! 17 - 5 ADF Right
Right = 0mm
```

7 At Screen 56-5, press  or  to change the top setting. The value changes in 1 mm units. Then press  to activate the setting. The scanner displays the next setup item.



## 17. Adjust FB Erasing Edges

1 Press "Next"  $\diamond$  or "Previous"  $\diamond$  and let the scanner display Screen 57.

<Screen 57>

! 18 FB EdgeERS  
Change? No / Yes

2 At Screen 57, press  $\diamond$  or  $\diamond$  to select "Yes" and press  $\boxed{\text{Enter}}$ . Then the scanner displays Screen 57-1.

<Screen 57-1>

! 18 - 1 Default?  
No / Yes

3 At Screen 57-1, select "Yes" to return the settings to the factory default or select "No" to make new settings (as shown below). Then press  $\boxed{\text{Enter}}$ . The scanner displays Screen 57-2.

<Screen 57-2>

! 18 - 2 FB Top  
Top = 0mm

4 At Screen 57-2, press  $\diamond$  or  $\diamond$  to change the top setting. The value changes in 1 mm units. Then press  $\boxed{\text{Enter}}$  to activate the setting. The scanner displays Screen 57-3.

<Screen 57-3>

! 18 - 3 FB Bottom  
Btm = 0mm ( + : Up )

5 At Screen 57-3, press  $\diamond$  or  $\diamond$  to change the bottom setting. With (+:Up), the area is set upward from the bottom edge of the image. With (-:Down), the area is set downward from the bottom edge of the image. The value changes in 1 mm units. Then press  $\boxed{\text{Enter}}$  to activate the setting. The scanner displays Screen 57-4.

<Screen 57-4>

! 18 - 4 FB Left  
Left = 0mm

6 At Screen 57-4, press  $\diamond$  or  $\diamond$  to change the left setting. The value changes in 1 mm units. Then press  $\boxed{\text{Enter}}$  to activate the setting. The scanner displays Screen 57-5.



<Screen 57-5>

! 18 - 5 FB Right  
Right = 0mm

7 At Screen 57-5, press  $\diamond$  or  $\diamond$  to change the top setting. The value changes in 1 mm units. Then press  $\boxed{\text{Enter}}$  to activate the setting. The scanner displays the next setup item.

## 18. Reset of the Ink Remain Counter

The ink remain counter checks the service life of the print cartridge and makes a message “Please a new Ink” to prompt you to prepare a new ink cartridge. When the imprinter cannot print any more, replace the print cartridge and reset the Ink remain counter as follows. You must reset the ink remain counter even if you replace the print cartridge before its service life.

- 1 Press “Next”  or “Previous”  and let the scanner display Screen 58. First, “No” blinks.
 

<Screen 58>  
 ! 2 1    I n k    r e m a i n  
 = ■ □ □ □ □ □    R e s e t / N o
- 2 Press , then “Reset” blinks. (Screen 58-1)
 

<Screen 58-1>  
 ! 2 1    I n k    r e m a i n  
 = ■ □ □ □ □ □    R e s e t / N o
- 3 Press . The reset execution screen appears. First, “No” blinks. (Screen 58-2)
 

<Screen 58-2>  
 ! 2 1 - 1    R e s e t    N o w  
                   N o / Y e s
- 4 Press , then “Yes” blinks. (Screen 58-3)
 



<Screen 58-3>  
 ! 2 1 - 1    R e s e t    N o w  
                   N o / Y e s
- 5 Press  to perform reset operation. The ink remain indicator returns to ■■■■■■. (Screen 58-4)
 

<Screen 58-4>  
 ! 2 1    I n k    r e m a i n  
 = ■ ■ ■ ■ ■ ■    R e s e t / N o
- 6 Press . The LCD returns to the “Ready” screen.
 

R e a d y            X X X X  
                   X X X X X X X 0

## 19. Setting the Numbering Print Function (for fi-475PR Imprinter Option)

You can specify conditions of the numbering print function from the operator panel when the scanner is equipped with the fi-475PR imprinter. The numbering counter increments 1 each a sheet of paper is read. Numbering print starts with a top margin of 42 mm.

- 1 Press “Next”  or “Previous”  and let the scanner display Screen 59.
 

<Screen 59>  
 ! 2 2    N u m b e r i n g  
 =    O n / O f f

- 2 At Screen 59, press  $\diamond$  or  $\diamond$  to select "On" then press **[Enter]** if you want to activate the setting function. The scanner displays Screen 59-1, indicating that the setting function is activated.

 **NOTICE**

When the setting function is disabled, the screen is as shown right.

```
! 2 2   N u m b e r i n g
=   H o s t
```

- 3 At Screen 59-1, select the number of digits. Press  $\diamond$  or  $\diamond$  to select "5" or "8" then press **[Enter]**. The scanner displays Screen 59-2.

<Screen 59-1>

```
! 2 2 - 1   D i g i t s
=   5   /   8
```

- 4 At Screen 59-2, select the initial number. Press  $\diamond$  or  $\diamond$  to move the place of the blinking (changeable) digit and press  $\diamond$  or  $\diamond$  to change the value, then press **[Enter]**. The scanner displays Screen 59-3.

<Screen 59-2>

```
! 2 2 - 2   S t a r t   C o u n t
=   0 0 0 0 0 0 0 0
```

 **NOTICE**

The possible maximum number is 99999 (for five digits) or 16777215 (for eight digits).

- 5 At Screen 59-3, specify whether the number is initialized at hopper empty. Press  $\diamond$  or  $\diamond$  to select "On" if you want to initialize, then press **[Enter]**. The scanner displays Screen 59-4.

<Screen 59-3>

```
! 2 2 - 3   E m p t y R e s e t
=   O n / O f f
```

- 6 At Screen 59-4, specify whether the number is reset at once. Press  $\diamond$  or  $\diamond$  to select "yes" if you want to reset at once, then press **[Enter]**. The scanner terminates the setup mode.

<Screen 59-4>

```
! 2 2 - 4   R e s e t ?
                N o / Y e s
```

 **NOTICE**

The command from the host computer overrides the specification of the operator panel. When the host computer issues a command disabling the specification of the operator panel, Screen 59-4 does not appear.

# **GLOSSARY OF TERMS**

---

## **A4 size**

A standard paper size. Paper size is 210 x 297 mm.

## **A5 size**

A standard paper size. Paper size is 148 x 210 mm.

## **A6 size**

A standard paper size. Paper size is 105 x 148 mm.

## **A7 size**

A standard paper size. Paper size is 74 x 105 mm.

## **A8 size**

A standard paper size. Paper size is 53 x 74 mm.

## **Abrasion counter**

Counts the cumulative number of documents read to indicate when belts/rollers should be replaced. The number of read documents accumulates until an operator resets the counter. The counter should be reset when these consumables are replaced.

## **ASCII**

The acronym for American Standard Code for Information Interchange.

ASCII is a set of 256 codes (numbered 0 to 255) used to communicate information between a computer and another device such as a scanner.

## **Automatic separation**

An image processing method in which the scanner automatically detects difference between text and photos, and chooses the threshold accordingly. Automatic separation allows the scanner to switch between line mode and half tone mode in one pass.

## **Automatic start mode (<-> manual start mode)**

In this mode, the reading operation is activated only by issuing the the START command.

## **Backside reading = Back-side scanning**

Refers to reading the backside of the document, specifically in Duplex reading mode.

## **Bit**

The smallest unit of information in computer memory. A bit is a single digit, either a 1 or a 0, in the binary numbering system. Eight bits equal one byte.

## **Density**

In this manual, refers to a measurement of the depth of the display.

## **Dither**

Technique for producing halftone images by representing the entire grayscale with only two pixel levels, black and white.

---

## **Double feed detection**

A scanner function which detects the accidental feeding of multiple sheets by the ADF unit. Can be turned on or off by the operator.

## **Double Letter Size**

A standard paper size used in the U.S.A. and othe countries. Paper size is 11 x 17 inches.

## **dpi**

Dots per inch.

## **Dropout color**

A color which is used in the document but does not appear in the read image.

## **Duplex reading mode**

A reading mode in which both sides of the document are read.

## **Equipment Error**

An error that cannot be corrected by the operator. Call CE.

## **Error diffusion**

High-quality halftone (pseudo-grayscale) image production based on black-and-white pixel binarization. A pixel's optical density and that of adjacent pixels are summed, with black pixels relocated in their order of density as they relate to adjacent pixels.

The purpose of this technique is to minimize the average error between read and printed densities. Density data for adjacent pixels is modified by diffusing errors on the objective pixel into several pixels, which are then binarized. This maintains high grayscale levels and resolution during reading, while suppressing more patterns by dotted halftone images such as newspaper photographs.

## **FB**

In this manual, FB means flat bed.

## **Filtering**

A correction method that improves the read quality of handwritten documents. The read quality of images written in pencil or ball-pointed pen depends on the reflective light characteristics of the specific ink or lead used. Dropped pixels may produce outlines, gaps, or thin, barely connected lines due to uneven optical density. Filtering detects areas lighter than their surroundings and increases their density to improve image clarity.

## **Front-side reading = Front-side scanning**

Refers to reading the front side of the document, specifically in Duplex reading mode.

## **Halftone processing**

Any method used to reproduce a photograph which includes a shade as an image composed of dots, namely, a binary image. Dithering and error diffusion processing are examples of halftone processing.

## Hexadecimal

A base-16 numbering system (also commonly referred to as hex numbers). Since a base-16 system requires 16 digits, numbers 0 through 9 and letters A through F are used. It is convenient to express binary numbers in hexadecimal because fewer digits are required.

## Image emphasis

Density is decreased for lighter but not completely white areas adjacent to black areas. Weakening this emphasis eliminates spot noise or produces softened images.

## Image processing

An image is read with specified parameters.

## Interface

The connection that allows communication from one part of a system to another. For example, electrical signals are transferred between the computer and scanner over an interface cable.

## Inversion (Reverse-image reading)

In reverse-image reading, data is changed from black to white and vice versa.

## IPC preset mode

While reading binary images, it is necessary to set the scanner according to the quality of the sheet to be read. In this mode, these settings can be performed in advance by corresponding each setting to a pattern number.

## IPC-4D

Image processing option of this scanner.

## IRAS

Initialization of the hardware.

## Landscape orientation

A document is transported and read with the long side vertical to the moving direction.

## Letter size

A standard paper size used in the U.S.A. and other countries. Paper size is 8-1/2 x 11 inches.

## Linedrawing mode

Selecting linedrawing mode makes threshold and contrast settings effective but prevents brightness from being set. The specified threshold value determines whether black or white pixels are scanned. Line drawing mode is therefore appropriate for scanning text and line art images.

## Manual Feed mode = Manual Mode

Requires the operator to feed each document manually into the ADF paper chute.

## Manual start mode (<-> automatic start mode)

The reading operation is activated by pressing the START button in this mode. Available only when video option board is installed.

---

## **Mirror image**

The read image is symmetrically flipped to produce a mirror image of the original detected in the main scanning direction.

## **Noise removal**

Isolated noise from an image appearing as black spots in white areas and voids in black areas is removed to improve image quality.

## **Operator panel**

A panel containing the scanner indicators and buttons. The operator panel is used to control scanner operations such as loading document, selecting features, and changing setup options.

## **Outline extraction**

The boundary between black and white areas is traced and the outline extracted for closed areas.

## **PAPER JAM**

A warning informing the user that document is jammed in the transport unit, or that transportation is disabled because the transport unit is slippery. This warning also appears when a double feed is detected.

## **Photograph mode (White level follower OFF)**

Selecting photograph mode makes brightness and contrast settings effective but prevents the threshold from being set. With photograph mode, the darkness of image corresponds to the black-pixel density, making it suitable in scanning images such as photographs having gradations.

## **Photo mode = photograph mode**

A photograph is read properly in this mode.

## **Pick start time**

The period from the manual insertion of the document until picking starts after the document passes the hopper empty sensor.

## **Portrait orientation**

A document is transported and read with the long side parallel to the moving direction.

## **Paper counter**

Indicates the total number of read document from start of reading until the hopper becomes empty.

## **Read operation**

Refers to the reading operation including Simplex reading and Duplex reading.

## **RS-232C interface**

A type of serial interface. See Serial interface.

## **SCSI-ID**

Used to specify a particular SCSI device when the initiator selects a target or the target reconnects to the initiator.

---

## **Serial interface**

A standard computer interface. Information is transferred between devices over a single wire (although other wires are used for control).

With a serial interface, an interface cable greater than 3 meters (10 feet) can be used. This is often necessary in networking environments, where the scanner may be shared.

## **SETUP mode**

In this mode, users can view or set a variety of function in off-line.

## **Simplex reading mode**

Only the front side of the document is read in this mode. Place the documents face up at the center of the hopper table.

## **Smoothing**

A process that eliminates “jaggies” from slanted lines and curves. Irregular convexities are deleted and irregular concavities filled in. This is useful in OCR applications, for example.

## **Temporary Error**

An error correctable by the operator.

## **Terminator**

Devices with a SCSI interface can be daisy-chained. A resistor that includes terminal circuits needs to be placed at both ends of a cable when devices are daisy-chained. If a device (such as a scanner) is the last device in a chain, leaving an interface connector unused, a Terminator therefore must be attached to provide those terminal circuits.

## **Third Party Interface**

Optional board provided by Fujitsu or interface board provided by a third party can be installed and used.

## **Time-out limit**

This is the time the scanner waits for next document insertion after the last document feeding. The scanner returns Paper Empty when no document is set after time-out limit.

## **TPS**

Third Party Slot.





# INDEX

- A** Abrasion counter 1-7  
Activating the Setup mode 7-1  
ADF 1-2, 1-3  
ADF
  - document feeder capacity 4-4
  - erasing edges 7-3, 7-13
  - lever 1-2, 1-3
  - mode 1-9
  - paper chute 1-2Alarm 1-10  
Ambient condition 5-2  
Arrangement 1-5  
Assemblies 1-4
  
- B** Button
  - /LED Function 1-6
  
- C** Cable connection 2-4  
Check LED 1-6  
Checking the components 1-1  
Connecting
  - the interface cable 2-5
  - the power cable 2-4Consumables 6-1  
Contents of the Setup mode 7-2  
Conventions vi  
Counter display 1-7
  
- D** Density 6-5  
Dimensions 5-2, 5-3  
Document
  - bed 1-2, 1-3
  - cover 1-2, 1-3
  - holding pad 1-2, 1-3
  - Quality 4-2
  - Size 4-1
  - type 3-6, 4-2Double
  - feed detection condition 4-7
  - feed detection setting 7-2, 7-4, 7-5
  - feed error 1-9
  
- E** Enter button 1-6  
Exit button 1-6  
EXT connector 1-2
  
- F** FB erasing edges 7-3, 7-14  
Feeding direction 4-1  
fi-475PR option (imprinter) 6-2, 6-8
  
- G** Grounding color areas 4-6  
Guide A assembly 1-4
  
- H** Halftone processing 6-5  
Heat capacity 5-2  
Hopper empty 1-9
  
- I** Image processing circuit 7-3, 7-12  
Ink remain counter 7-15  
Inspection 2-2  
Inspection 2-2  
Installation specifications 5-2  
Interface connectors 1-2, 1-3  
Interface select 7-3, 7-11  
IPC
  - mode select 7-3, 7-12
  - preset mode setting 7-2, 7-6IPC-4D option 6-2, 6-7, 7-12
  
- J** Job separation sheet 4-8
  
- L** Label
  - A 2-2
  - B 2-2Landscape orientation 6-4  
LCD 1-5  
LED 1-6  
Loading documents
  - ADF 3-4
  - Flat bed 3-8Low power mode
  - setting 7-3, 7-11
  - waking up from 3-2
  
- M** Manual
  - feed mode 3-3
  - start mode 1-6Manuals and driver 1-1
  
- N** Next button 1-6  
Note, Liability iv  
Numbering print 7-15
  
- O** Offset setting 7-2, 7-8  
Operation status 1-8  
Operator panel 1-2, 1-5  
Option 6-2, 6-3, 6-7, 6-8  
Option status display 7-2, 7-10

**P** Pad Assembly 1-1, 1-4, 6-1  
Paper  
    counter 1-7  
    weight 4-2  
Perforation areas 4-5  
Pick  
    roller 1-4, 6-1  
    start time setting 7-2, 7-7  
Plain paper 4-2  
Portrait 6-4  
Power  
    cable 1-1, 2-4  
    consumption 5-2  
    inlet 1-2, 1-3, 2-4  
    switch 1-2, 1-3, 2-4, 3-1  
Precautions 2-1, 4-2  
Preface v  
Previous button 1-6

**R** Read LED 1-6  
Reading  
    mode 6-4  
    thick book 3-10  
Resetting  
    abrasion counter 7-2, 7-7  
    ink remain counter 7-2, 7-15  
Resolution 6-4

**S** Scanner 1-1  
SCSI ID setting 7-10  
SCSI terminator setting 7-10  
Select  
    interface 7-11  
    IPC mode 7-12  
Setting  
    double feed detection  
        paper thickness 7-4  
        paper length 7-5  
    IPC preset mode 7-6  
    low power mode 7-11  
    numbering print function 7-15  
    Offset 7-8  
    pick start time 7-7  
    SCSI ID 2-7, 7-10  
    SCSI terminator 2-7, 7-10  
    time-out limit 7-8  
Setup mode 7-1, 7-2  
Shipping lock 2-3  
Size 6-4  
Specifications 5-1, 5-2  
Stacker 1-2, 1-4, 2-6

Start button 1-5, 1-6  
Stop button 1-5, 1-6

**T** Temporary error 1-9  
Third party slot 1-2, 1-3  
Time-out limit setting 7-2, 7-8  
TPS board ID number display 7-3, 7-12  
Turning  
    the power on 3-1  
    the power off 2-4

**U** Units 1-2  
Units and Assemblies 1-2

**V** Video interface option 6-2, 6-3

**W** Weight 5-2

◇ (Left Arrow Key) button 1-6  
◇ (Right Arrow Key) button 1-6  
◇ (Next) button 1-6  
◇ (Previous) button 1-6  
(Send To) button 1-6  
(Start) button 1-6  
(Stop) button 1-6  
(Enter) button 1-6  
(Exit) button 1-6

FUJITSU