

FUJITSU

Fujitsu LifeBook®
P1610 Notebook

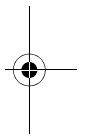

User's Guide

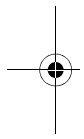
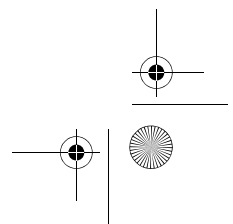
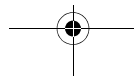
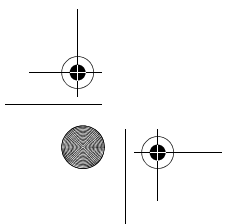

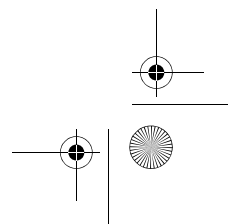
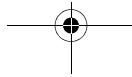
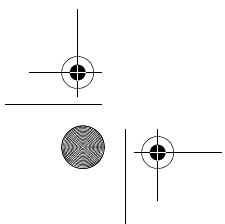
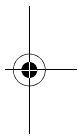
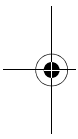
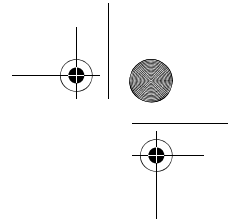
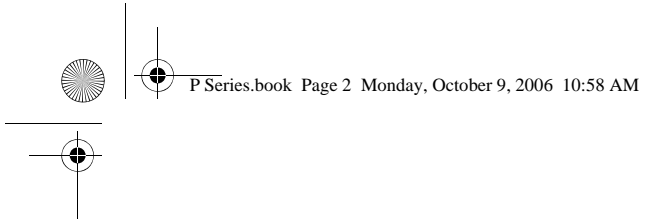

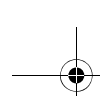

Copyright

Copyright & Trademark Information

Fujitsu Computer Systems Corporation has made every effort to ensure the accuracy and completeness of this document. However, as ongoing development efforts are continually improving the capabilities of our products, we cannot guarantee the accuracy of the contents of this document. We disclaim liability for errors, omissions, or future changes.

Fujitsu, the Fujitsu logo, and LifeBook are registered trademarks of Fujitsu Limited.

Microsoft, MS-DOS, and Windows are either registered trademarks or trademarks of Microsoft Corporation in the United States and/or other countries.

PCMCIA is a trademark of the Personal Computer Memory Card International Association.

Centrino, Intel, and Intel Core are trademarks or registered trademarks of Intel Corporation or its subsidiaries in the United States and other countries.

OmniPass is a trademark of Softex, Inc.

Atheros and Super AG are registered trademarks of Atheros Communications, Inc.

Adobe, Acrobat, and Acrobat Reader are either registered trademarks or trademarks of Adobe Systems Incorporated in the United States and/or other countries.

Realtek is a trademark of Realtek Semiconductor Corporation.

Bluetooth is a registered trademark of Bluetooth SIG, Inc.

All other trademarks mentioned herein are the property of their respective owners.

© Copyright 2006 Fujitsu Computer Systems Corporation. All rights reserved. No part of this publication may be copied, reproduced, or translated, without prior written consent of Fujitsu Computer Systems Corporation. No part of this publication may be stored or transmitted in any electronic form without the written consent of Fujitsu Computer Systems Corporation.

B5FJ-1131-01EN-00

WARNING



Handling the cord on this product or cords associated with accessories sold with this product, will expose you to lead, a chemical known to the State of California to cause birth defects or other reproductive harm.

Wash hands after handling.



DECLARATION OF CONFORMITY according to FCC Part 15

Responsible Party Name:	Fujitsu Computer Systems Corporation
Address:	1250 E. Arques Avenue, MS 122 Sunnyvale, CA 94085
Telephone:	(408) 746-6000
Declares that product:	Model Configuration: LifeBook P1610 Notebook Complies with Part 15 of the FCC Rules.

This device complies with Part 15 of the FCC rules. Operations are subject to the following two conditions: (1) This device may not cause harmful interference, (2) This device must accept any interference received, including interference that may cause undesired operation.

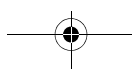

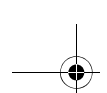

LifeBook P1600 Series Notebook

IMPORTANT SAFETY INSTRUCTIONS

This unit requires an AC adapter to operate. Use only UL Listed I.T.E. Adapters with an output rating of 16 VDC, with a minimum current of 2.5 A.

AC adapter output polarity:

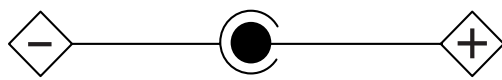

When using your notebook, basic safety precautions should always be followed to reduce the risk of fire, electric shock and injury to persons, including the following:

- Do not use this product near water for example, near a bathtub, washbowl, kitchen sink or laundry tub, in a wet basement or near a swimming pool.
- Avoid using the modem during an electrical storm. There may be a remote risk of electric shock from lightning.
- Do not use the modem to report a gas leak in the vicinity of the leak.
- Use only the power cord and batteries indicated in this manual. Do not dispose of batteries in a fire. They may explode. Check with local codes for possible special disposal instructions.
- To reduce the risk of fire, use only No. 26 AWG or larger UL Listed or CSA Certified Telecommunication Line Cord.
- For TV Tuner Models: To protect from overvoltages and transients on the Cable Distribution System, make sure that the outer shield of the coaxial cable is connected to earth (grounded) at the building premises as close to the point of cable entrance as practicable, as required per NEC Article 820.93, ANSI/NFPA 70: 2005. If you have questions about your CATV installation, contact your service provider.

SAVE THESE INSTRUCTIONS

For Authorized Repair Technicians Only



Danger of explosion if Lithium (clock) battery is incorrectly replaced. Replace only with the same or equivalent type recommended by the manufacturer. Dispose of used batteries according to the manufacturer's instruction.



For continued protection against risk of fire, replace only with the same type and rating fuse.

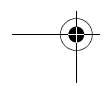
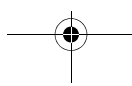

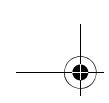

Fujitsu LifeBook® P1600 Series Notebook Table of Contents

1

PREFACE

Preface

About This Guide	3
Fujitsu Contact Information	3
Warranty	3

2

GETTING TO KNOW YOUR LIFEBOOK

Overview

Unpacking	7
Optional Accessories	7

Locating Controls and Connectors

Front and Display Components	9
Left-Side Panel Components	10
Right-Side Panel Components	11
Rear Panel Components	12
Bottom Components	13

Status Indicators

Power Indicator	14
Battery Level Indicator	14
Hard Drive Access Indicator	14
NumLk Indicator	14
CapsLock Indicator	14
ScrLk Indicator	14

Display Panel

Opening the Display Panel	15
Using the System as a Tablet	15
Adjusting Display Panel Brightness	16

Keyboard

Using the Keyboard	17
Numeric Keypad	17
Windows Keys	17
Cursor Keys	17
Function Keys	18

LifeBook Security/Application Panel

Setting up Your LifeBook Security Panel	19
Passwords	19
Operating Your Security/ Application Panel	20
Precautions	20
Uninstalling the Security Panel Application	20
Using the Lifebook Application Panel	21
Changing Button Functions	23

Pointing Device/Touch Screen

Clicking	24
Double-Clicking	24
Dragging	24
Quick Point Control Adjustment	25
Touch Screen	25

Volume Control

Controlling the Volume	27
----------------------------------	----

3

USING YOUR LIFEBOOK

Power Sources

Connecting the Power Adapters	31
---	----

Starting Your LifeBook

Power On	32
Boot Sequence	32
BIOS Setup Utility	32
Booting the System	33
Registering Your Notebook	33
Installing Click Me!	33

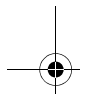
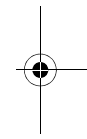
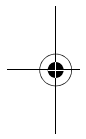

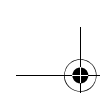

Power Management

Suspend/Resume Button	34
Standby Mode	34
Hibernate Mode	35
Display Timeout	35
Hard Disk Timeout	35
Windows Power Management	35
Restarting the System	35
Power Off	36

4

USER-INSTALLABLE FEATURES

Lithium ion Battery

Recharging the Battery	39
Replacing the Battery	40

Memory Upgrade Module

Removing Memory Modules	41
Installing a Memory Upgrade Module	42
Checking the Memory Capacity	42

Secure Digital Media

Inserting SD Cards	43
Removing An SD Card	43

PC Cards

Inserting PC Cards	44
Removing PC Cards	44

Port Replicator

Port Replicator Components	45
Attaching Port Replicator	46
Detaching Port Replicator	46

Device Ports

Modem (RJ-11) Jack	47
Internal LAN (RJ-45) jack	47
Docking Port	47
Universal Serial Bus Ports	47
Microphone Jack	47
Headphone Jack	47
External Video Port	48

5

TROUBLESHOOTING

Troubleshooting

Identifying the Problem	51
Specific Problems	51
Troubleshooting Table	52
Power On Self Test Messages	58
Modem Result Codes	59

Restoring Pre-installed Software

Restoring the Factory Image	60
Automatically Downloading Driver Updates	61

6

CARING FOR YOUR LIFEBOOK

Care and Maintenance

Keyboard	66
Batteries	66
Optional Floppy Disk Drive and Floppy Disks	66
Optional Optical Drive and Discs	67
PC Cards	67

7

SYSTEM SPECIFICATIONS

Specifications

Configuration Label	71
Physical Specifications	71
Processing Specifications	71
Memory/Storage Specifications	71
Display Specifications	71
Interface Specifications	71
Power Specifications	72
Environmental Specifications	72
Agency Approval Specifications	72
Additional Specifications	72
Regulatory Information	73

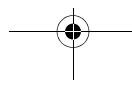

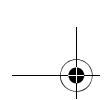

Table of Contents

8

GLOSSARY

Glossary77

APPENDIX A: INTEGRATED WIRELESS LAN USER'S GUIDE

Before Using the Wireless LAN

Wireless LAN Modes Using this Device.86
Wireless Network Considerations87
Deactivating the WLAN Device87
Activating the WLAN Device88

Configuration of the WLAN Device

Flow of Operations.89
Configuration Using Intel PROSet Software89
Configuration Using Atheros Client Utility90
Connection to the network.91

Troubleshooting the WLAN

Troubleshooting95

Wireless LAN Glossary

Glossary96

IP address information

About IP Addresses98

WLAN Specifications

Specifications99

Using the Bluetooth Device

What is Bluetooth.100
Where to Find Information About Bluetooth ..100

APPENDIX B: USING THE FINGERPRINT SWIPE SENSOR

Fingerprint Sensor Device

Introducing the Fingerprint Sensor Device103
Getting Started.....103
Installing OmniPass103
User Enrollment104
Using OmniPass.....105
Configuring OmniPass107
OmniPass Control Center.....108
Troubleshooting.....109



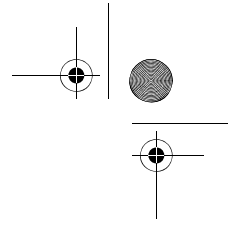
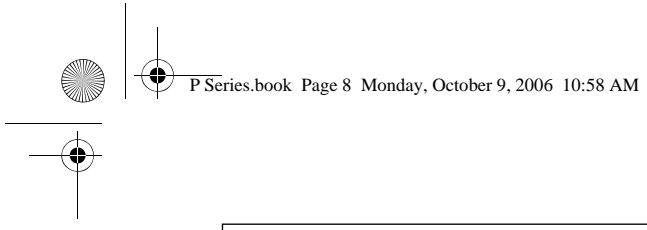

LifeBook P1600 Series Notebook

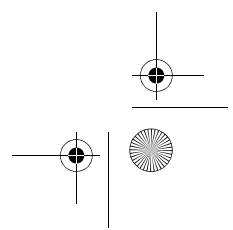
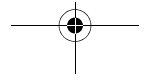
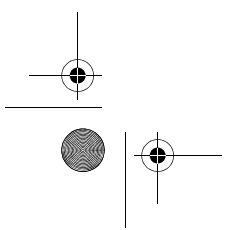
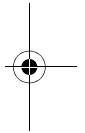
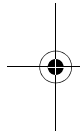

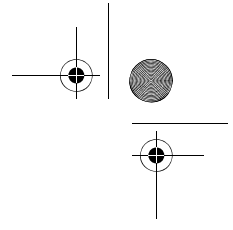
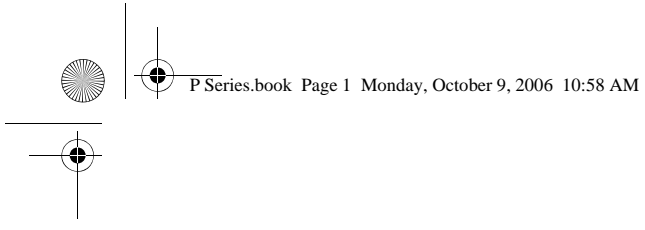

1 Preface

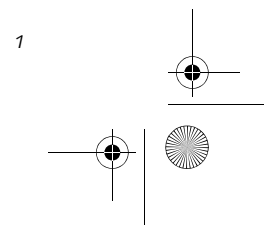
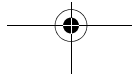
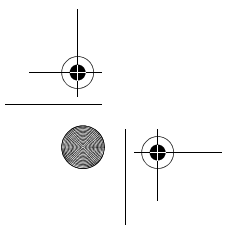
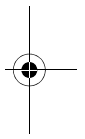
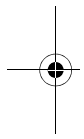

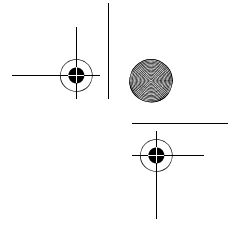
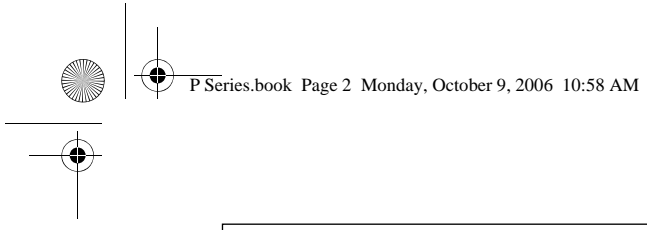

LifeBook P1600 Series Notebook

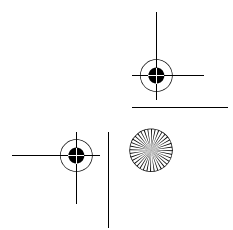
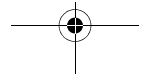
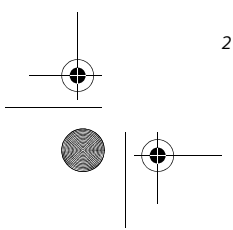
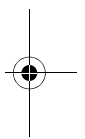
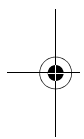

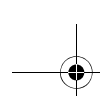

Preface

ABOUT THIS GUIDE

The LifeBook® P1600 Series notebook from Fujitsu Computer Systems Corporation is a small yet powerful convertible computer. It can be used either as a standard notebook using keyboard input, or in tablet configuration using pen input. It is powered by an Intel® Core™ Solo processor and an integrated Intel 945 GMS graphics controller with 128 MB of graphics memory. The notebook has a built-in 8.9" TFT wide XGA color display.

This manual explains how to operate your LifeBook P1600 Series notebook's hardware and built-in system software. Your notebook comes with the Microsoft® Windows® XP or Windows Tablet PC Edition 2005 operating system pre-installed.



The operating system installed on your computer determines whether your system is classified as a notebook or Tablet PC.

Conventions Used in the Guide

Keyboard keys appear in brackets.

Example: [Fn], [F1], [Esc], [Enter] and [Ctrl].

Pages with additional information about a specific topic are cross-referenced within the text.

Example: (See page xx.)

On screen buttons or menu items appear in bold.

Example: Click **OK** to restart your notebook.

DOS commands you enter appear in Courier type.

Example: Shutdown the computer?



The information icon highlights information that will enhance your understanding of the subject material.



The caution icon highlights information that is important to the safe operation of your computer, or to the integrity of your files. Please read all caution information carefully.



The warning icon warns you about possible hazards that can occur to you, your system, or your files. Please read all warning information carefully.

FUJITSU CONTACT INFORMATION

Service and Support

You can contact Fujitsu Computer Systems Service and Support the following ways:

- Toll free: 1-800-8Fujitsu (1-800-838-5487)
- Fax: 1-408-764-2724
- E-mail: 8fujitsu@us.fujitsu.com
- Website: us.fujitsu.com/computers

Before you place the call, you should have the following information ready so that the customer support representative can provide you with the fastest possible solution:

- Product name
- Product configuration number
- Product serial number
- Purchase date
- Conditions under which the problem occurred
- Any error messages that have occurred
- Type of device connected, if any

Fujitsu Online

You can go to the online Fujitsu Product catalog for your notebook by clicking on Start -> Fujitsu Weblinks -> LifeBook Accessories or by going to www.ShopFujitsu.com.

You can also reach Fujitsu Service and Support online by going to Start -> Fujitsu Weblinks -> Fujitsu Service and Support.



You must have an active internet connection to use the online URL links.

WARRANTY

Your LifeBook P1600 Series notebook is backed by an International Limited Warranty and includes toll-free technical support. Check the service kit that came with your system for warranty terms and conditions.

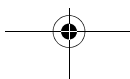

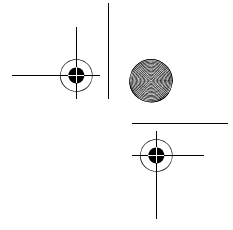
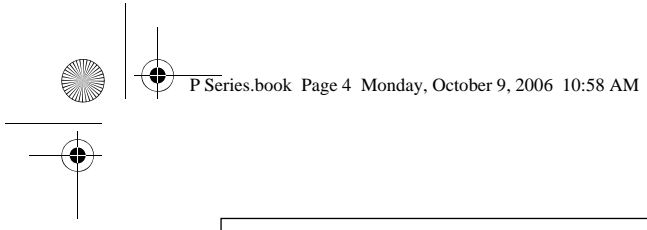

LifeBook P1600 Series Notebook

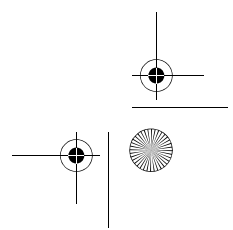
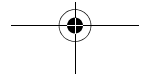
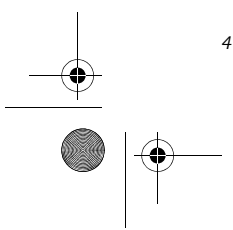
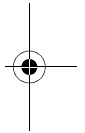
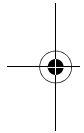

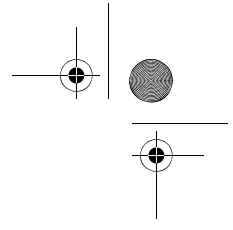
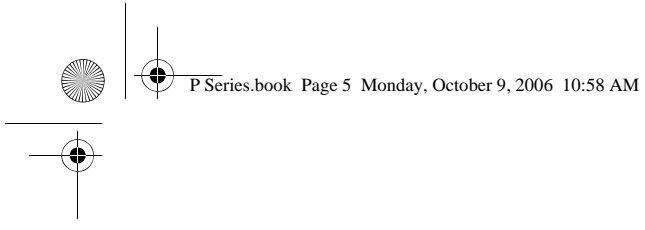

2

Getting to Know Your LifeBook

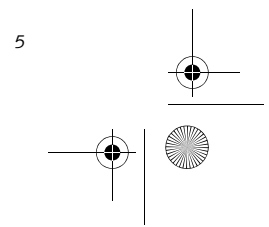
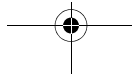
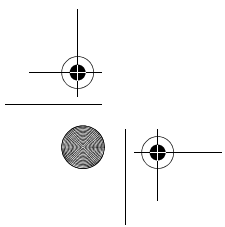
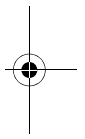
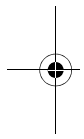

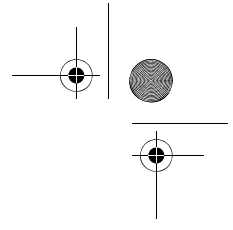
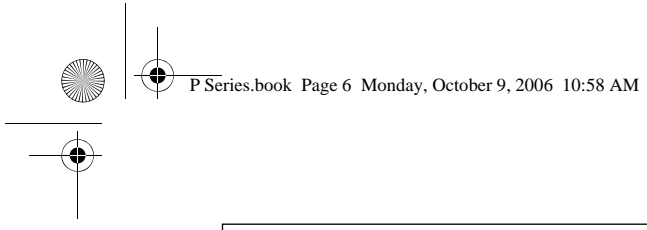

LifeBook P1600 Series Notebook

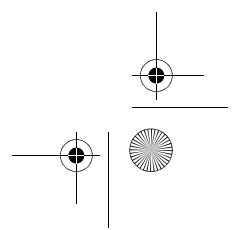
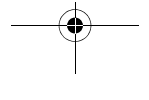
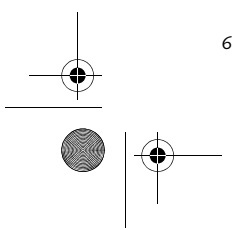
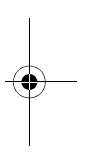
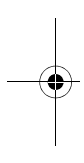

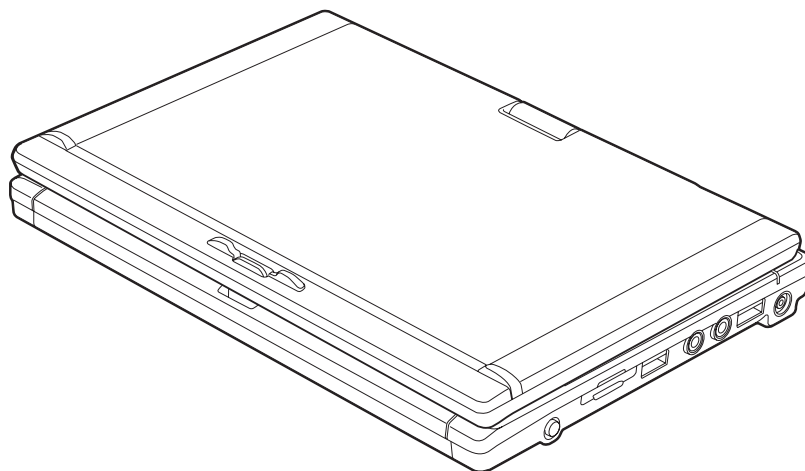

Figure 2-1. Fujitsu LifeBook P1600 series notebook

Overview

This section describes the components of your Fujitsu LifeBook P1600 Series notebook. We strongly recommend that you read it before using your system, even if you are already familiar with mobile computers.

UNPACKING

When you receive your LifeBook P1600 Series notebook, unpack it carefully, and compare the parts you have received with the items listed below.



The operating system installed on your computer determines whether your system is classified as a notebook or Tablet PC.

For a pre-configured model you should have:

- LifeBook P1600 Series notebook (*Figure 2-1*)
- AC adapter with AC power cord (*Figure 2-2*)
- Phone/Modem (RJ-11) telephone cable
- Pen
- Driver and Application Restore (DAR) CD
- Recovery CD
- Getting Started Guide
- User's Guide (this document)
- International Limited Warranty Booklet
- Certificate of Authenticity
- Lithium ion battery (pre-installed)

You may also have one or more of the following devices in the box, depending upon the configuration of your system:

- Port Replicator (*Figure 2-3*)
- External USB Floppy Disk Drive
- Additional battery(s)
- Application CD(s) for third-party software

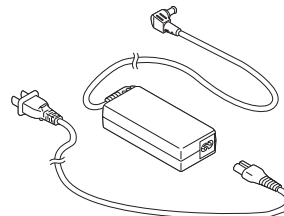

Figure 2-2. AC Adapter

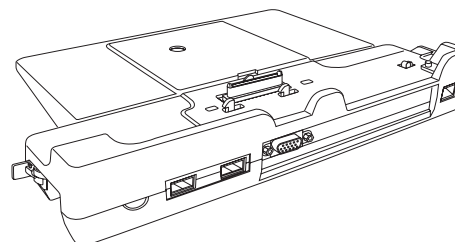

Figure 2-3. Optional Port Replicator

OPTIONAL ACCESSORIES

A variety of optional accessories is available for use with your LifeBook P1600 Series notebook. For the latest list of accessories available, be sure to frequently check the Fujitsu website at: www.shopfujitsu.com. Refer to the instructions provided with these accessories for details on their use.

LifeBook P1600 Series Notebook

Locating the Controls and Connectors

Connectors and peripheral interfaces on the LifeBook P1600 Series notebook and the optional port replicator allow you to connect a variety of devices. Specific locations are illustrated in Figures 2-4 through 2-8. The table

below provides a short description of each icon on the LifeBook P1600 Series notebook. Each of the icons is either molded into or printed on the system chassis.













Connection	LifeBook Icon	Purpose
DC in connector		Connect an external power source such as the AC adapter or auto/airline adapter.
Secure Digital (SD) Slot		The Secure Digital (SD) card slot allows you to install a flash memory card for data storage. Flash memory cards allow you to transfer data to and from a variety of different digital devices.
USB Ports		Connect Universal Serial Bus 2.0 or 1.1 compliant devices to the notebook.
Microphone Jack		Connect an external microphone. The internal microphone is disabled when you plug in an external microphone. The same icon is used for the internal microphone.
Fingerprint Sensor		Use the fingerprint sensor to log onto the system using your fingerprint as the "password".
Headphone Jack		Connect stereo headphones or powered external speakers. The internal speaker is disabled when you plug in external headphones or powered speakers.
Modem		Connect a telephone line to the internal modem using a standard RJ-11 telephone plug.
PCMCIA Card slot		Insert a Type I or Type II PC Card.
Security lock slot		The security slot allows you to secure the notebook using notebook locking devices.
Suspend/Resume button		The Suspend/Resume button allows you to suspend system activity without powering off, resume from suspend mode, and power on the system when it has been shut down from Windows.
Local Area Network (LAN)		The LAN (RJ-45) jack is used to connect the internal 10/100 Base-T/Tx Ethernet to a Local Area Network (LAN) in your office or home, or broadband devices such as a cable modem, DSL, or satellite Internet.
Battery Release Latch		The battery release latch allows you to remove the battery from your system for storage or replacement.
Wireless LAN/Bluetooth On/Off Switch		The wireless LAN switch allows you to turn power to the optional wireless LAN or Bluetooth device on and off.

Table 2-1. System icons

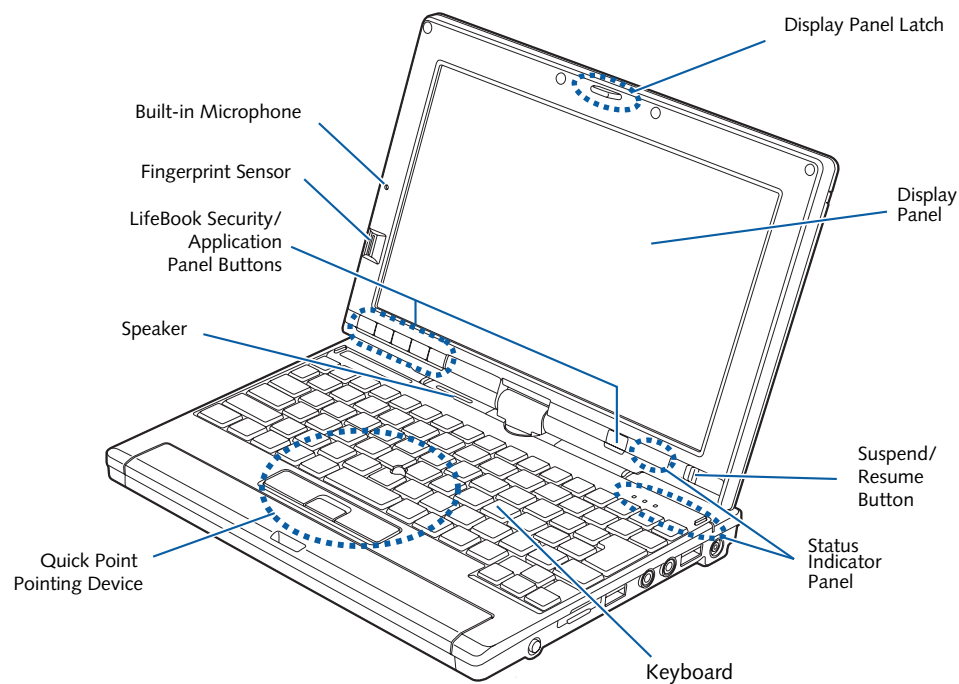

Figure 2-4. LifeBook P1600 Series notebook with display open

FRONT AND DISPLAY COMPONENTS

The following is a brief description of the front and display features of the LifeBook P1600 Series notebook. (Figure 2-4)

Display Panel Latch

The display panel latch holds the display panel in position.

Display Panel

The display panel is a color LCD panel with back lighting for the display of text and graphics and touch screen functionality.

Suspend/Resume Button

The Suspend/Resume button allows you to suspend system activity without powering off, resume your system from standby mode, and power on your system when it has been shut down from the Windows operating system. See "Power On" on page 32.

Status Indicator Panel

The Status Indicator Panel displays symbols that correspond to specific components of your LifeBook P1600 Series notebook. See "Status Indicators" on page 14.

Keyboard

A full-function keyboard with dedicated Windows keys. See "Keyboard" on page 17.

Quick Point Pointing Device

The Quick Point pointing device consists of two mouse-like buttons, one scroll button, and a cursor control button (located near the center of the keyboard). See "Quick Point Pointing Device/Touch Screen" on page 24.

Speaker

The speaker allows you to listen to sound from your system.

LifeBook Security/Application Buttons

The LifeBook P1600 Series notebook Security/Application Buttons provide application launch capabilities. See "LifeBook Security/ Application Panel" on page 19.

Fingerprint Sensor

The fingerprint recognition sensor allows you to log into Windows or other applications by replacing your username and password. See "Fingerprint Sensor Device" on page 103.

Built-in Microphone

The built-in microphone allows you to input mono audio.



LifeBook P1600 Series Notebook

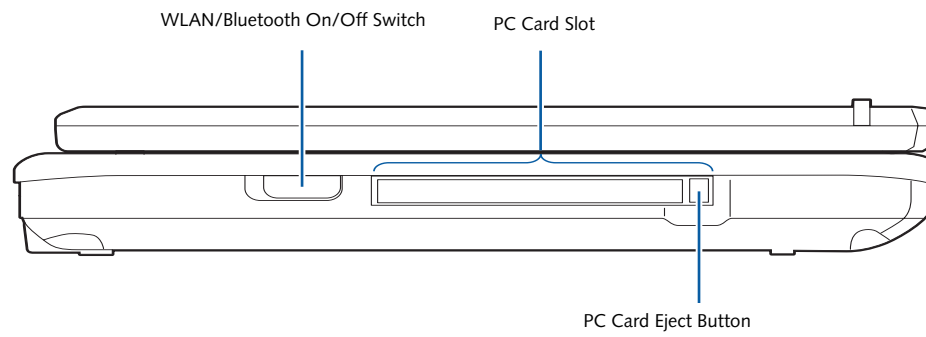

Figure 2-5. LifeBook P1600 Series notebook left-side panel

LEFT-SIDE PANEL COMPONENTS

Following is a brief description of your notebook's left-side components. (Figure 2-5)

WLAN/Bluetooth On/Off Switch

The wireless LAN/Bluetooth On/Off Switch is used to power off the wireless devices when not in use.

PC Card Slot

The PC Card Slot allows you to insert a PCMCIA Card. The PC Card Eject Button is used when ejecting a PC Card from the slot. See "Inserting PC Cards" on page 44.

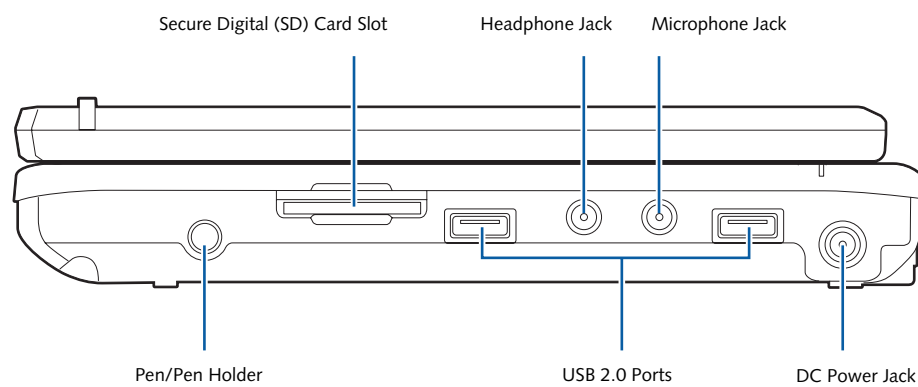

Figure 2-6. LifeBook P1600 Series notebook right-side panel

RIGHT-SIDE PANEL COMPONENTS

Following is a brief description of your notebook's right-side components.

SD Card

The Secure Digital (SD) card slot allows you to insert a flash memory card for data storage. Flash memory cards allow you to transfer data to and from a variety of different digital devices.

Headphone Jack

The headphone jack allows you to connect stereo headphones or powered external speakers. See "Headphone Jack" on page 47.

Microphone Jack

The microphone jack allows you to connect an external mono microphone. See "Microphone Jack" on page 47.

DC Power Jack

The DC power jack allows you to plug in the AC adapter or the optional Auto/Airline adapter to power your system and charge the internal Lithium ion Battery.

USB 2.0 Ports

The USB 2.0 ports allow you to connect Universal Serial Bus devices. See "Universal Serial Bus Ports" on page 47.

Pen/Pen Holder

The pen is used as the interface with the digitizer display.

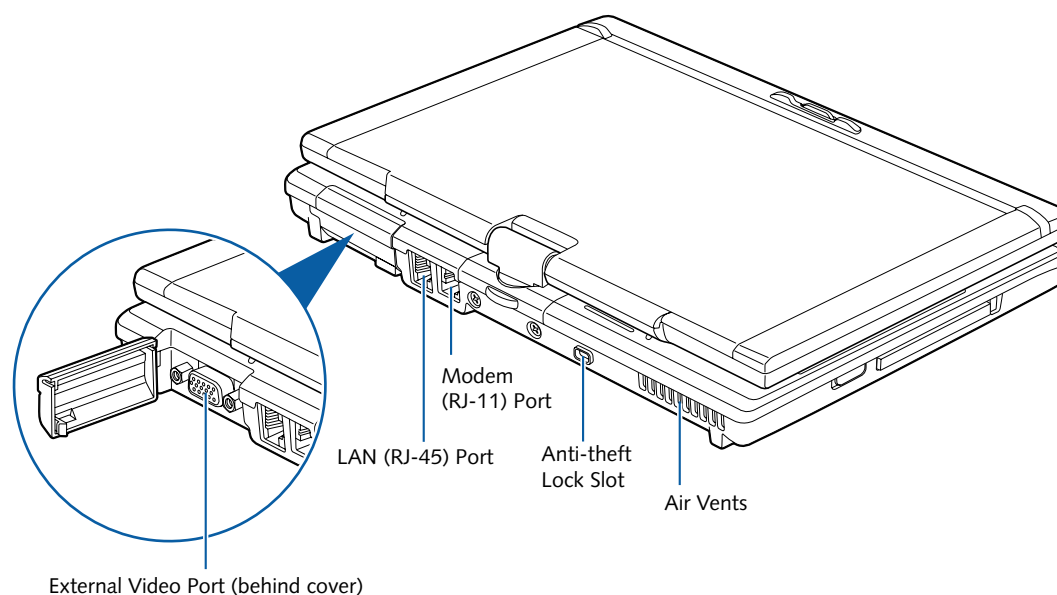

Figure 2-7. LifeBook P1600 Series notebook rear panel

REAR PANEL COMPONENTS

External Video Port

The external video port allows you to connect an external CRT monitor or LCD projector. Note that when the optional Port Replicator is attached to the system, you must use the external video port on the Port Replicator rather than the port on the system. See “External Video Port” on page 48.

LAN (RJ-45) Port

The internal LAN (RJ-45) port is used for an internal 10/100/1000 Base-Tx Ethernet. See “Internal LAN (RJ-45) jack” on page 47.

Modem (RJ-11) Telephone Port

The Modem (RJ-11) telephone port is for attaching a telephone line to the internal multinational 56K modem.



The internal multinational modem is not intended for use with Digital PBX systems. Do not connect the internal modem to a Digital PBX as it may cause serious damage to the internal modem or your entire LifeBook P1600 Series notebook. Consult your PBX manufacturer’s documentation for details. Some hotels have Digital PBX systems. Be sure to find out BEFORE you connect your modem.



The internal modem is designed to the ITU-T V.90 standard. Its maximum speed of 53000 bps is the highest allowed by FCC, and its actual connection rate depends on the line conditions. The maximum speed is 33600 bps at upload.

Anti-theft Lock Slot

The anti-theft lock slot allows you to attach an optional physical lock-down device.

Air Vents

The air vents allow proper air circulation to ensure that the system does not overheat.



To protect your notebook from damage and to optimize system performance, be sure to **keep all air all vents unobstructed, clean, and clear of debris**. This may require periodic cleaning, depending upon the environment in which the system is used.

Do not operate the notebook in areas where the air vents can be obstructed, such as in tight enclosures or on soft surfaces like a bed or cushion.



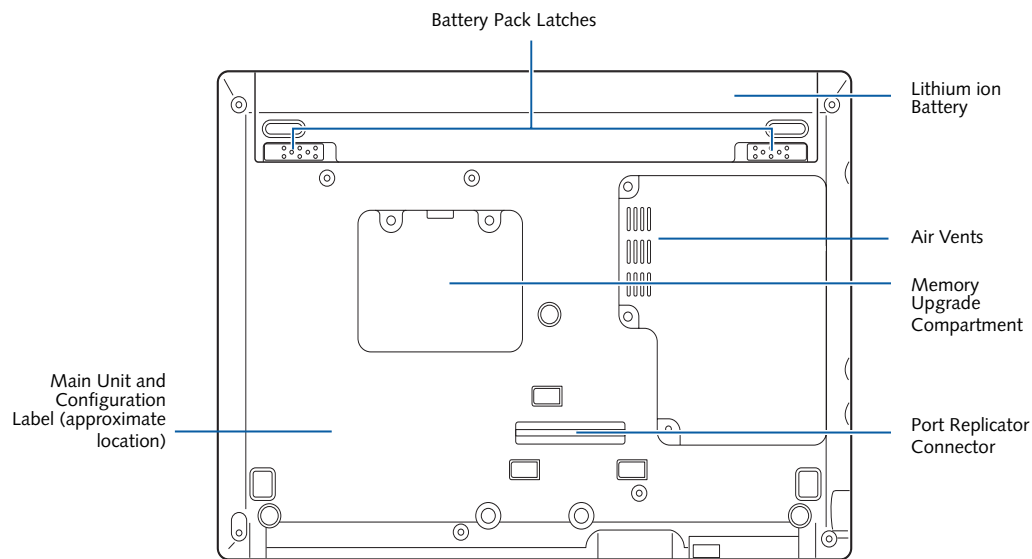
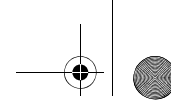

Figure 2-8. LifeBook P1600 Series notebook bottom panel

BOTTOM COMPONENTS

Following is a brief description of your notebook's bottom panel components. (Figure 2-8)

Battery Pack Latches

The battery pack latches are used to lock the Lithium ion battery pack into the battery compartment.

Lithium ion Battery

The battery compartment contains the internal Lithium ion battery. The battery should be removed when the computer is stored over a long period of time or for swapping a discharged battery with a charged Lithium ion battery. See "Lithium ion Battery" on page 39.

Air Vents

The air vents allow proper air circulation to ensure that the system does not overheat.



To protect your system from damage and to optimize system performance, be sure to **keep all air all vents unobstructed, clean, and clear of debris**. This may require periodic cleaning, depending upon the environment in which the system is used.

Do not operate the system in areas where the air vents can be obstructed, such as in tight enclosures or on soft surfaces like a bed or cushion.

Memory Upgrade Compartment

Your notebook comes with high speed DDR2 Synchronous Dynamic RAM (SDRAM). The memory upgrade compartment allows you to expand the system memory capacity of your system, hence improving overall performance. See "Memory Upgrade Module" on page 41.

Port Replicator Connector

This connector allows you to connect the optional port replicator.

Main Unit and Configuration Label

The configuration label shows the model number and other information about your LifeBook P1600 Series notebook. In addition, the configuration portion of the label has the serial number and manufacturer information that you will need to give your support representative. It identifies the exact version of various components of your system.

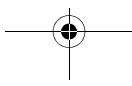

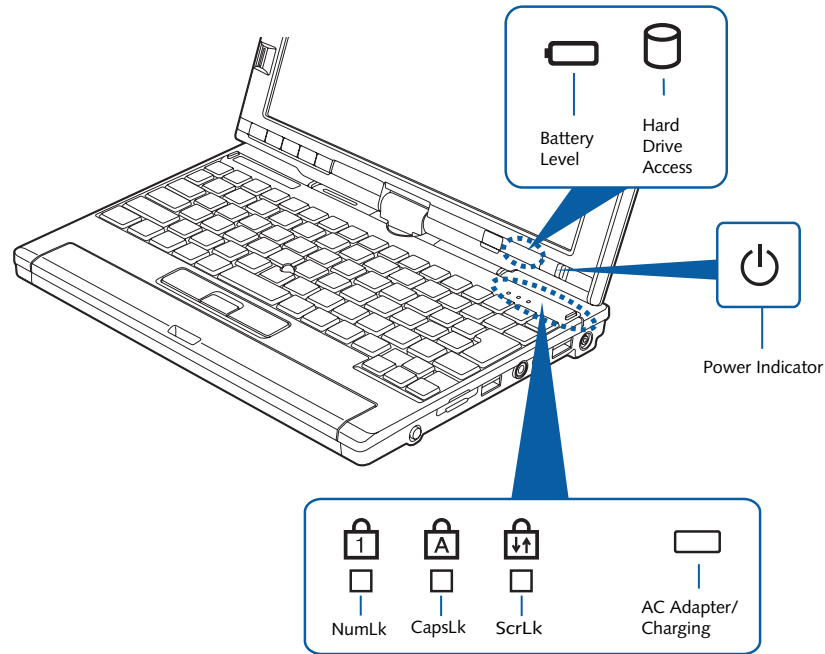

Figure 2-9. Status Indicators

Status Indicators

The status indicators display symbols that correspond to specific components of your notebook. (Figure 2-9) The symbols show how each of those components is operating. Note that keyboard-related indicators (CapsLk, NumLk, ScrLk) are located above the keyboard.



POWER INDICATOR

The Power indicator symbol located on the power button shows whether your system is operational. When it is lit blue, it means that there is power to your computer and that it is ready for use.



BATTERY LEVEL INDICATOR

The Battery Level indicators shows whether the Lithium ion battery is installed and charging, and how much charge is available within the batteries.

- **Green:** The battery is installed and fully charged.
- **Amber:** The battery is installed and is approximately half charged.
- **Red:** The battery charge is low and it should be charged with an adapter or replaced with a charged battery.



Batteries subjected to shocks, vibration or extreme temperatures can be permanently damaged.



If there is no battery activity and the power adapters are not connected, the Battery Level indicators will also be off.



HARD DRIVE ACCESS INDICATOR

The Hard Drive Access indicator lights green when your internal hard drive is being accessed.



NUMLK INDICATOR

The NumLk indicator shows that the integral keyboard is set in ten-key numeric keypad mode.



CAPSLK INDICATOR

The CapsLock indicator shows that your keyboard is set to type in all capital letters.



SCRK INDICATOR

The ScrLk indicator shows that your scroll lock is active.



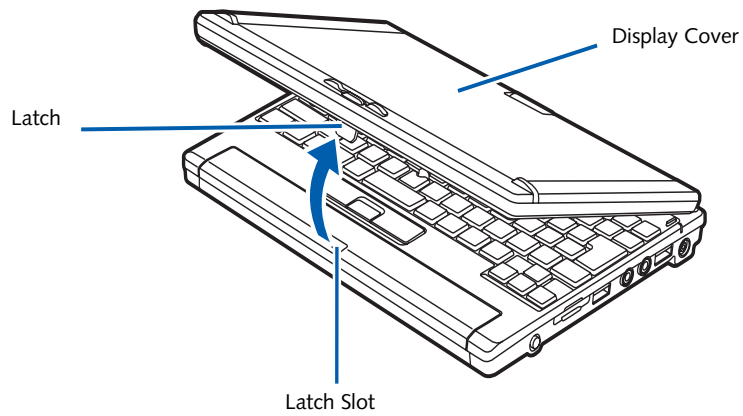

Figure 2-10. Opening the display

Display Panel

The convertible design of your LifeBook P1600 Series notebook allows you to open the display fully, rotate it 180 degrees in either direction, and lay it face up on the keyboard. This allows you to use the system as a tablet, much as you would a pad of paper.

OPENING THE DISPLAY PANEL

Lift the display cover backwards, being careful not to touch the screen, until it is at a comfortable viewing angle. (Figure 2-10)

USING THE SYSTEM AS A TABLET

If you would like to use the system as a tablet, perform the following steps.



Rotate the system display only in the direction indicated in the procedure. Turning the display in the incorrect direction could damage the hinge.



In the following step, be sure to position the display perpendicular to the keyboard, otherwise the keyboard or display cover could get scratched.

1. Lift the display until it is perpendicular to the keyboard. (Figure 2-12).
2. When the display is perpendicular to the keyboard, rotate it 180 degrees in either direction so that it is facing backwards. (Figure 2-13)
3. Holding the top edge of the display panel, pull it forward until it is lying nearly atop the keyboard.
4. Push the latch towards the display (See "A" in Figure 2-11). The latch will click twice and the top latch disappears, and the bottom latch appears (See "B" in Figure 2-11). Lay the display flush against the

system so that the latch rests in the slot in the battery pack. You can now use the system as a tablet. (Figure 2-15)

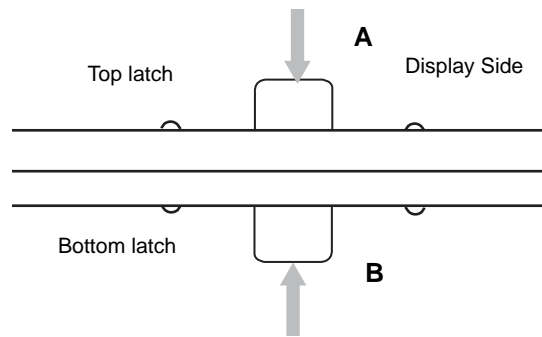

Figure 2-11. Using the Display Latch

5. To return the system to notebook configuration, repeat step 3 and 2. Be sure to turn the display in the opposite direction when performing step 2.

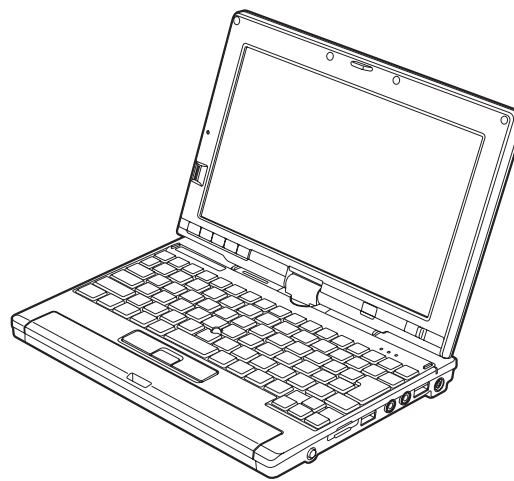
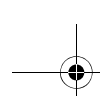

Figure 2-12. Fully open display





Display Orientations in Tablet Configuration

The display orientations are limited to two positions: landscape and portrait, as indicated in Figure 2-15.

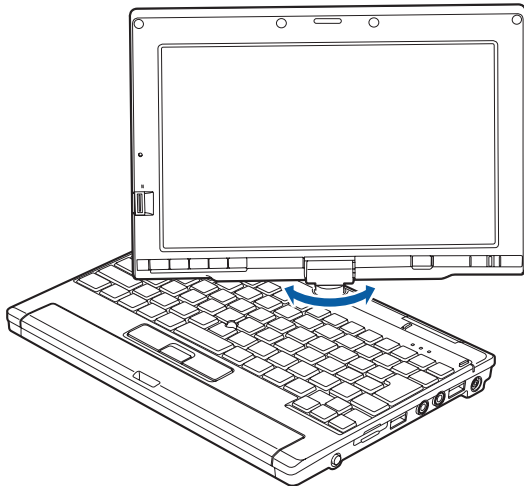

Figure 2-13. Rotating the display

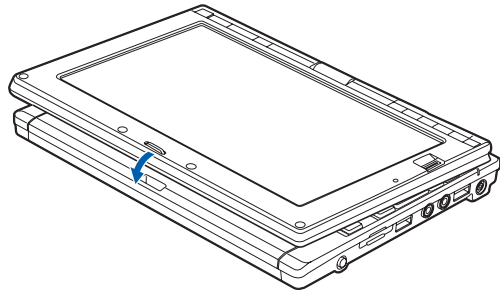

Figure 2-14. Entering tablet configuration

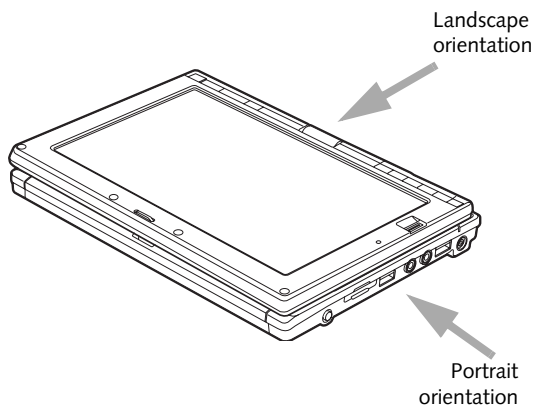

Figure 2-15. System in tablet configuration

ADJUSTING DISPLAY PANEL BRIGHTNESS

Once you have turned on your system, you may want to adjust the brightness level of the screen to a more comfortable viewing level. There are three ways to adjust the brightness, keyboard, power management utility, and Fujitsu menu.

Using Keyboard to Adjust Brightness

Adjusting the brightness using the keyboard changes the system setting (i.e., the settings you make via the function keys automatically changes the brightness settings in the system's Brightness Control settings).

- [Fn+F6]: Pressing repeatedly will lower the brightness of your display.
- [Fn+F7]: Pressing repeatedly will increase the brightness of the display.

Using Control Panel to Adjust Brightness

Windows XP Pro:

To adjust brightness with the power management utility, click Start -> Control Panel -> Brightness Control. Set the screen brightness slider for battery and AC power scenarios.

Windows XP Tablet PC Edition

To adjust brightness with the Tablet and Pen Settings utility, click Start -> Control Panel -> Tablet and Pen Settings, then select the Display tab.

Using the Fujitsu Menu to Adjust Brightness

To adjust brightness using the Fujitsu menu, click on the Fujitsu Menu icon in the system tray in the lower right corner of the screen. From the menu that appears, select Brightness Control. The Brightness Control window will open. Set the screen brightness slider for battery and AC power scenarios.

If using AC power, your brightness setting is set to its highest level by default. If using battery power your brightness settings is set to approximately mid-level by default.



The higher the brightness level, the more power the LifeBook P1600 Series notebook will consume and the faster your batteries will discharge. For maximum battery life, make sure that the brightness is set as low as possible.



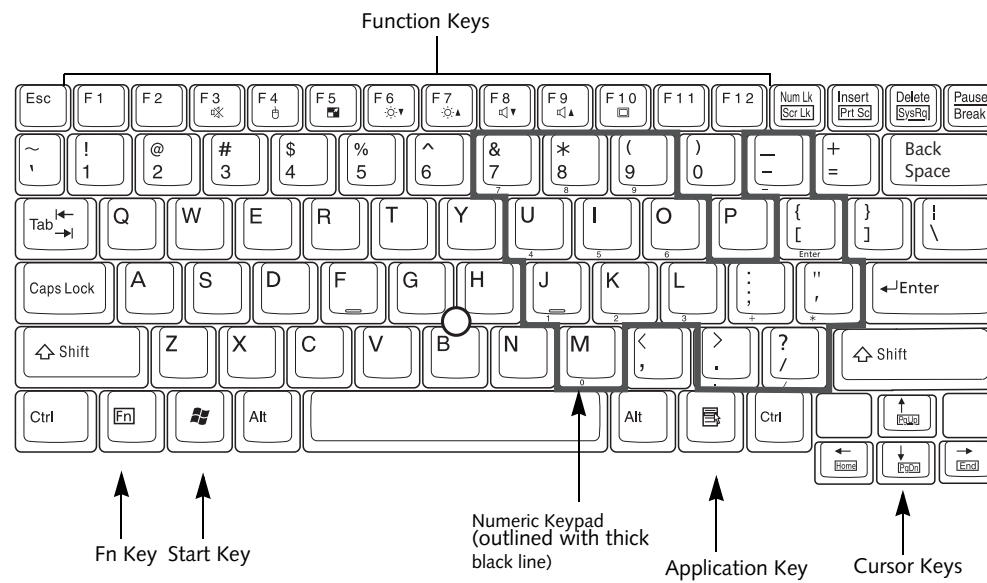

Figure 2-16. Keyboard

Keyboard

USING THE KEYBOARD

Your LifeBook P1600 Series notebook has an integral 82-key keyboard. The keys perform all the standard functions of a 101-key keyboard, including the Windows keys and other special function keys. This section describes the following keys. (Figure 2-16)

- **Numeric keypad:** Your system allows certain keys to serve dual purposes, both as standard characters and as numeric and mathematical keys. The ability to toggle between the standard character and numerical keys is controlled through the [NumLk] key.
- **Cursor keys:** Your keyboard contains four arrow keys for moving the cursor or insertion point to the right, left, up, or down within windows, applications and documents.
- **Function keys:** The keys labeled [F1] through [F12], are used in conjunction with the [Fn] key to produce special actions that vary depending on what program is running.
- **Windows keys:** These keys work with your Windows operating system and function the same as the onscreen Start menu button, or the right button on your pointing device.

NUMERIC KEYPAD

Certain keys on the keyboard perform dual functions as both standard character keys and numeric keypad keys. NumLk can be activated by pressing the [NumLk] key. Turning off the NumLk feature is done the same way. Once this feature is activated you can enter numerals 0 through 9, perform addition (+), subtraction (-), multiplication (*), or division (/), and enter decimal points (.) using the keys designated as ten-key function keys. The keys in the numeric keypad are marked on the front edge of the key to indicate their secondary functions. (Figure 2-16)

WINDOWS KEYS

Your LifeBook P1600 Series notebook has two Windows keys: a Start key and an Application key. The Start key displays the Start menu. This button functions the same as your onscreen Start menu button. The Application key functions the same as your right mouse button and displays shortcut menus for the selected item. (Please refer to your Windows documentation for additional information regarding the Windows keys.) (Figure 2-16)

CURSOR KEYS

The cursor keys are the four arrow keys on the keyboard which allow you to move the cursor up, down, left, and right in applications. In programs such as Windows Explorer, it moves the "focus" (selects the next item up, down, left, or right). (Figure 2-16)

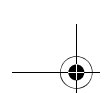

FUNCTION KEYS

Your system has 12 function keys, F1 through F12. The functions assigned to these keys differ for each application. You should refer to your software documentation to find out how these keys are used. (Figure 2-16)

[Fn] Key

The [Fn] key provides extended functions for the notebook and is always used in conjunction with another key.

- [Fn+F3]: Pressing [F3] while holding [Fn] will toggle the Audio Mute on and off.
- [Fn+F4]: Pressing [F4] while holding [Fn] will toggle the built-in pointing device on and off. Note that the [Fn+F4] combination only works if Manual Setting is selected in the BIOS. (See "Entering the BIOS Setup Utility" on page 32)
- [Fn +F5]: Pressing [F5] while holding [Fn] allows you to toggle between video compensation and no compensation. (Video compensation controls spacing on the display. When it is enabled, displays with less than 1024 x 600 or 800 x 600 pixel resolution will still cover the entire screen.)
- [Fn+F6]: Pressing [F6] repeatedly while holding [Fn] will lower the brightness of your display. Note that adjusting the brightness using the keyboard changes the system setting.
- [Fn+F7]: Pressing [F7] repeatedly while holding [Fn] will increase the brightness of the display.
- [Fn+F8]: Pressing [F8] repeatedly while holding [Fn] will decrease the volume of your system.
- [Fn+F9]: Pressing [F9] repeatedly while holding [Fn] will increase the volume of your system.
- [Fn+F10]: Pressing [F10] while holding [Fn] allows you to change your selection of where to send your display video. Each time you press the combination of keys you will step to the next choice. The choices, in order, are: built-in display panel only, external monitor only, and both built-in display panel and external monitor.

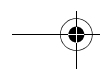
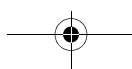
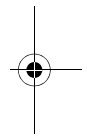
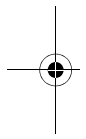

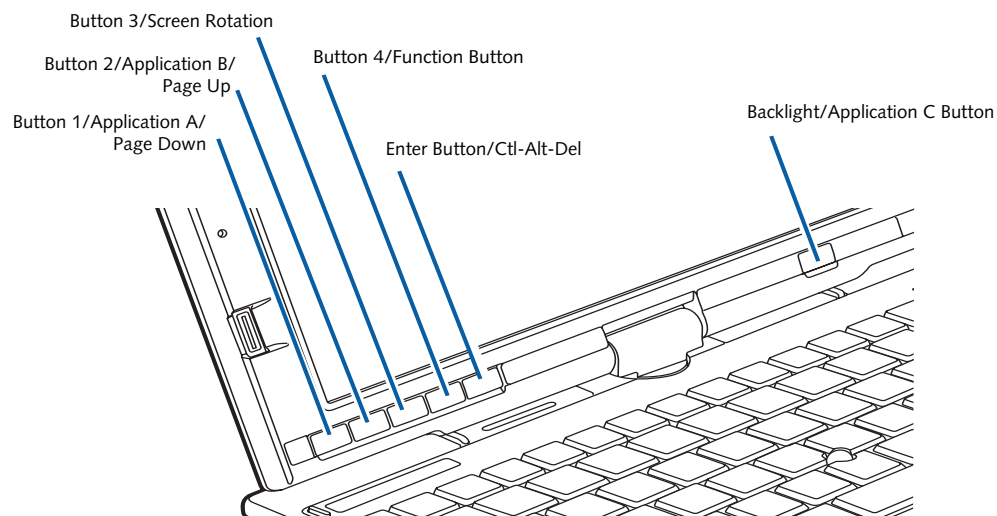
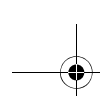

Figure 2-17. LifeBook P1600 Series notebook application buttons

LifeBook Security/ Application Panel

A unique feature of your LifeBook notebook is the Security/Application Panel that allows you to secure your notebook from unauthorized use. The Security/Application Panel also allows you to launch applications with the touch of a button when your system is on.

If the security system is activated, upon starting your notebook or resuming from Standby mode the security system requires you to enter a password code using the buttons on the Security/Application Panel. After entering a correct password, your notebook resumes system operation. (Figure 2-17)

SETTING UP YOUR LIFEBOOK SECURITY PANEL

When you receive your LifeBook notebook, the security panel application is pre-installed without any passwords. The following sections provide detailed information on your security panel, how to set, change or remove passwords.

Numbered Buttons

Use these buttons to enter your password.

Enter Button

After entering the button strokes, push this button to enter the password into the LifeBook notebook.

PASSWORDS

The user and supervisor password may be set on this notebook. A supervisor password is typically the same for all LifeBook notebooks in a working group, office, or company to allow for system management. Individual

LifeBook notebooks in a group environment should not use a common password. A password consists of one to five button strokes plus the enter button. A valid stroke consists of pushing one or up to four buttons simultaneously. The following are valid button strokes:

- Pushing [4] by itself
- Pushing [2] and [3] at the same time
- Pushing [1], [2], and [4] at the same time
- Pushing [1], [2], [3], and [4] at the same time

The following are valid passwords. The numbers within braces ({ }) are button strokes using more than one button.

- {[2]+[3]}, [1], [enter]
- [4], [enter]
- {[1]+[3]}, {[2]+[3]+[4]}, [1], [4], [2], [enter]

Setting Passwords

When shipped from the factory, no passwords are set. You have a choice of having no password or setting a supervisor and user password. You must set the supervisor password before the user password.



- The purpose of supervisor password is to be able to bypass the user password in case the user password is forgotten. The supervisor password alone will not lock the system.
- You have to set both the supervisor and user passwords for the security panel to work.

Setting Supervisor Password

You must have set a supervisor password before setting any user passwords. The supervisor password can bypass the user password.

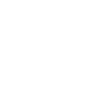

LifeBook P1600 Series Notebook

1. Go to the **Start** menu.
2. Click on **Run**.
3. Type in:
C:\Program Files\Fujitsu\
Security Panel Application\
Supervisor\FJSECS.EXE,
then press [Enter]
4. Follow the on-screen instructions to set the Supervisor password.

Setting User Password

1. Go to the **Start** menu.
2. Click on **Programs**.
3. Click on **Security Panel Application and Set User Password**.
4. Follow the on-screen instructions to set the user password.



You may change or remove the supervisor or user password by repeating the steps defined above.

OPERATING YOUR LIFEBOOK SECURITY/ APPLICATION PANEL

The security lock feature is in effect both when the system resumes from Off or Standby state. You always need to push the Suspend/Resume button to input the user password. Your system will not begin the boot sequence without entering your supervisor/user password.

From Off State

1. Turn on your system.
2. When the Security Indicator flashes, enter the password and press Enter button.
For example, if the password is 22222,
Press Button Number 2 five times and press Enter button.
The LifeBook notebook will boot to normal operation.

From Standby State

1. Press your Suspend/Resume button.
2. When the Security Indicator flashes, enter the password and press Enter button.
The notebook should resume normal operation.

Incorrect Password Entry

If an invalid supervisor or user password is entered three times in succession, the system will “beep” for about one minute. If a valid password is entered within a minute (while system beeps), the beeping will stop and the notebook will resume normal operation. If no or an invalid password is entered while the system beeps, the system

will return to its previous locked state (standby or off) and the Security Indicator will go off. To reactivate the notebook after a password failure, you must press the Suspend/Resume button, then enter a correct password.



Remember the user password you specified on the Security Panel Application. If you forget the password you will not be able to use your computer. The supervisor password can override the user password.

PRECAUTIONS**Opening and Closing the Cover**

Closing the cover automatically places the notebook into Standby mode. Opening the cover does not automatically place the notebook into normal operation. Instead, you must enter the proper security password after pushing the Suspend/Resume button.

Low Battery Operations

If your LifeBook notebook has low battery, pushing the suspend/resume button only turns on the Security Indicator. Your notebook does not unlock, the Security Indicator turns off after one minute. To resume normal operation, first attach a power supply to the notebook. Then you may unlock the notebook.

UNINSTALLING THE SECURITY PANEL APPLICATION

You have two options when uninstalling the security panel application:

- Uninstall the security panel application software. This will disable all security feature.
- Uninstall the security panel application with password still active. This will not allow any changes to the password.

Uninstalling the Security Panel Application Software

Remove passwords when User wants no password protection whatsoever and doesn't want to give anybody the utility to set a password on their computer. In this case, if passwords (supervisor, user, or both) are set, the passwords must first be cleared before removing the application. To clear passwords, follow same procedure in setting the passwords, except this time, check the “Remove Supervisor (and/or) User Password” box, as appropriate. Click [Next]. Enter the password. When asked to confirm that you want to remove the password, click [OK], then click [Finish].

Removing Security Panel Application with Passwords Still Active

Using this feature will not allow any changes to the password.



Removing the applications does not remove the password. It simply removes the utility to change/add/remove passwords. To change your password you must reinstall the application.

User:

1. Go to **Start Menu**, Click on **Control Panel**.
2. Open **Add/Remove Programs Properties** in the Control Panel.
3. Select the **Security Panel Application** in the list, and click **Add/Remove**.
4. When the **Confirm File Deletion** box appears, click **Yes**.

Supervisor:

1. Go to **Start Menu**, Click on **Control Panel**.
2. Open **Add/Remove Programs Properties** in the Control Panel.
3. Select the **Security Panel Application for Supervisor** in the list, and click **Add/Remove**.
4. When the **Confirm File Deletion** box appears, click **Yes**.

Reinstalling the Security/Application Panel

To reinstall supervisor or user security application, you will need your Drivers and Applications CD. The **Utilities\Security Application Panel** folder contains two separate folders: **Supervisor** and **User**. The setup files for supervisor and user security applications are contained in those folders.

1. Go to the **Utilities\Security Application Panel\Supervisor** folder on the CD and double-click the **setups.exe** file. The **Installing Security Panel Application** window will appear. Follow the instructions on the screen.
2. Go to the **Utilities\Security Application Panel\User** folder on the CD and double-click the **setup.exe** file. The **Installing Security Panel Application** window will appear. Follow the instructions on the screen.

Supervisor and user passwords can be set via Windows software using the **FJSECS.exe** and **FJSECU.exe** files, respectively. **FJSECU.exe** for the user password cannot run without first setting a supervisor password. You need to run **FJSECS.exe** first to set the supervisor password. Follow instructions under **Setting Passwords** on page 19.

If you forget both passwords, please contact Fujitsu Computer Systems Service and Support at 1-800-8FUJITSU (1-800-838-5487). Fujitsu Computer Systems Corporation charges a service fee for unlocking a password restricted LifeBook notebook. When calling please have a valid credit card and provide proof of ownership. You will then be given instructions on where to ship your notebook.

USING THE LIFEBOOK APPLICATION PANEL

Five application buttons are located on the bottom left-hand side of the display and when it is configured to be used as a notebook. (Figure 2-17) One additional button is located on the right-hand side of the display adjacent to the battery indicator.

All six of the buttons have primary functions. Five of the buttons have secondary functions when used as application buttons. The secondary functions are activated by pressing the **Function (Fn)** button while pressing the application button. See Table 2-2 for specific functions. The secondary functions of the **Application A** and **B** buttons can be changed to launch any application. See "Changing Button Functions" on page 23.

Page Down / Application A Button

When you press the **Page Down** button when the system is running, each press of the button will scroll the screen down one frame. This allows you to navigate quickly through large documents.

When you press the **Fn** button while you press then release the **Page Down/Application A** button, you will automatically start whichever program is assigned to the button. The default application for this button is **Calculator**.

See "Changing Button Functions" on page 23 to select a different application for this button.

Page Up / Application B Button

When you press the **Page Up** button when the system is running, each press of the button will scroll the screen up one frame. This allows you to navigate quickly through large documents.

When you press the **Fn** button while you press then release the **Page Up/Application B** button, you will automatically start whichever program is assigned to the button. The default application for this button is **WordPad (Windows XP Professional)** or **MS Journal (Windows XP Tablet PC Edition)**.

See "Changing Button Functions" on page 23. to select a different application for this button.

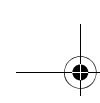

LifeBook P1600 Series Notebook







Button Icon	Primary Function	Secondary Function (Fn + Button)
	Page Down	User-defined Application A <i>Default = Calculator</i>
	Page Up	User-Defined Application B <i>Windows XP Professional Default = WordPad</i> <i>Windows XP Tablet PC Edition Default = MS Journal</i>
	Screen Rotation	VGA-Out
	Secondary Function Selection	Fujitsu Menu Utility
	Ctl+Alt+Del Button	None
	Backlight On/Off	User-Defined Application C <i>No Default assigned</i>

Table 2-2. Application Button Functions

Screen Rotation / VGA-Out Button

The screen rotation feature would normally be used only when the system is configured as a tablet. When you would like to use the tablet as an eBook, for example, you would use the portrait orientation; when accessing spreadsheets or using the system as a notebook, you would more typically use landscape orientation.

When the system is changed to tablet configuration, the orientation automatically changes to portrait mode by default.



The screen orientation default can be changed, first use the Screen Rotation button to select the desired orientation, then go to the Control Panel and double-clicking on the Fujitsu Display Control icon (Windows XP Pro) or Fujitsu Tablet Controls icon (Windows XP Tablet PC Edition) and click the [Save Current Profile] button. Note that the default orientations must be configured separately for Docked and Undocked modes.

When you press the **Screen Rotation / VGA-Out** button, the system screen orientation changes from portrait (vertical) to landscape (horizontal) or from landscape to portrait.

Function / Fujitsu Menu Utility Button

The **Function** button works in conjunction with the other application buttons to provide additional functionality for the buttons. Refer to specific details above.

Pressing the **Fn** button twice in succession causes the Fujitsu Menu Utility to appear on your screen, allowing you to modify certain system settings.

Ctl+Alt+Del Button

Pressing and holding the **Ctl-Alt-Del** button for up to 750 milliseconds launches the Logon screen or the Windows Task Manager (if the system hasn't yet been configured).

Backlight On-Off / Application C Button

When you press the **Backlight On-Off** button when the system is running, each press of the button will toggle the backlight on and off. This is designed as a power saving feature for use when the backlight is not required.

When you press the **Fn** button while you press then release the **Backlight On-Off/Application C** button, you will automatically start whichever program is assigned to the button. There is no assigned default application for this button.

See "Changing Button Functions" on page 23, to select a different application for this button.



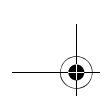

CHANGING BUTTON FUNCTIONS

The Application A, B, and C buttons can be changed to launch a program or perform an action you select. By default, the Application A button launches the Calculator and the Application B button launches WordPad (Windows XP Professional) or MS Journal (Windows XP Tablet PC Edition). The Application C button does not have an application assigned as a default, but one can be assigned as noted below.

To launch different applications or cause the Application A, B, or C buttons to perform a specific action:

Windows XP Professional:

1. Double-click on the Tablet Button Settings icon in the Control Panel.
2. Select the button you would like to change from the list.
3. Click [Change] and open the drop down list in the Action: field.
4. Select the action you would like the button to perform. If you want to launch a program, click on Launch an Application then browse to the location of the program.
5. Click [OK], then click [OK] again. The buttons will now perform the actions you have assigned to them.

Windows XP Tablet PC Edition:

1. Double-click on the Tablet and Pen Settings icon in the Control Panel.
2. Select the Tablet Buttons tab.
3. Select the button you would like to change from the list.
4. Click [Change] and open the drop down list in the Action: field.
5. Select the action you would like the button to perform. If you want to launch a program, click on Launch an Application then browse to the location of the program.
6. Click [OK], then click [OK] again. The buttons will now perform the actions you have assigned to them.

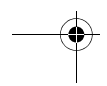
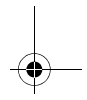
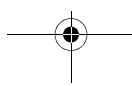
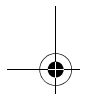
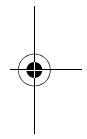
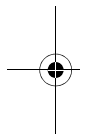

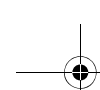

LifeBook P1600 Series Notebook

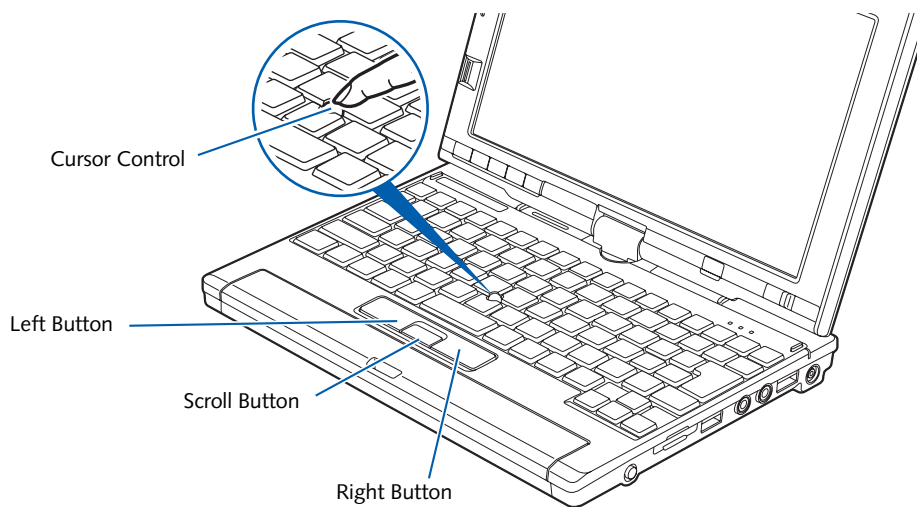

Figure 2-18. Touchpad pointing device

Quick Point Pointing Device/Touch Screen

The Quick Point is built into your LifeBook notebook. It is used to control the movement of the cursor to select items on your display panel. The Quick Point is composed of a cursor control at the center of the keyboard and three buttons on the palm rest of your computer. The cursor control works the same way a mouse ball does, and moves the cursor around the display. It only requires light pressure with the tip of your finger, and the more pressure you use, the faster the cursor will move. The left button functions the same as a left mouse button while the right button has the same function as a right mouse button. When used with the cursor control, the middle button allows you to scroll up and down a screen. The actual functionality of the buttons may vary depending on the application that is being used. (Figure 2-19)

CLICKING

Clicking means pushing and releasing a button. To left-click, move the cursor to the item you wish to select, press the left button once, and then immediately release it. (Figure 2-19) To right-click, move the cursor to the item you wish to select, press the bottom button once, and then immediately release it.

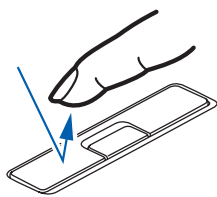

Figure 2-19 Clicking

DOUBLE-CLICKING

Double-clicking means pushing and releasing the left button twice in rapid succession. This procedure does not function with the right button. To double-click, move the cursor to the item you wish to select, press and release the left button twice. (Figure 2-20)

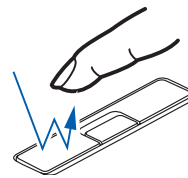

Figure 2-20 Double-clicking



- If the interval between clicks is too long, the double-click will not be executed.
- Parameters for the Quick Point can be adjusted from the Mouse dialog box located in the Windows Control Panel.

DRAGGING

Dragging means pressing and holding the left button, while moving the cursor. To drag, move the cursor to the item you wish to move. Press and hold the left button while moving the item to its new location and then release it. (Figure 2-21)

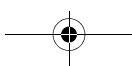

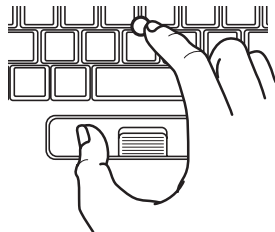

Figure 2-21 Dragging

QUICK POINT CONTROL ADJUSTMENT

The Windows Control Panel allows you to customize your Quick Point with selections made from within the Mouse Properties dialog box. There are three aspects of Quick Point operation, which you can adjust:

- **Buttons:** This tab lets you set up the buttons for right or left handed operation, in addition to setting up the time interval allowed between clicks in double-clicking.
- **Pointers:** This tab lets you set up the scheme for the cursor depending on its functionality.
- **Pointer Options:** This tab lets you set up a relation between the speed of your finger motion and the speed of the cursor. It also allows you to enable a Pointer Trail for the cursor arrow.

TOUCH SCREEN

The integrated Touch Screen allows you to use either the included stylus or your fingertip, as a pointing device.



Do not use excessive force when tapping or writing on the screen with the stylus or your finger. Excessive force could result in damage to the LCD and/or Touch Screen.

You can use the stylus to click, double-click, drag items and icons, or to draw like a pen or pencil in applications that support this behavior, such as drawing or painting programs. See the documentation that came with your application for details. (Figure 2-22)

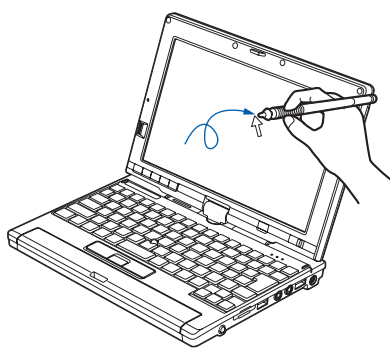

Figure 2-22 Using the Stylus with the Touch Screen



To avoid potential scratching and damage, never use anything but the included stylus or your finger with the Touch Screen.



To purchase additional or replacement styluses, visit Fujitsu's accessories website at: www.shopfujitsu.com.

Clicking

To left-click, touch the object you wish to select and then lift the stylus tip immediately. You also have the option to perform the left-click operation by tapping lightly with your finger on the Touch Screen once. (Figure 2-23)

Right-Clicking

Windows XP Professional:

To right-click, go to Start -> Control Panel -> Touch Panel. From the Right Button Simulation tab you can specify a right button tool by using the selected button prior to the desired right mouse click.

Windows XP Tablet PC Edition:

Right-click can be accomplished by holding the pen down until a circular icon appears. To change the settings for the right-click feature, go to Start -> Control Panel -> Tablet and Pen Settings. In the Pen Options tab, select "Press and Hold" then click the [Settings] button.

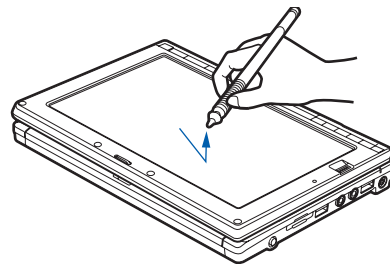

Figure 2-23 Clicking the Touch Screen

Double-Clicking

To double-click, touch the item twice, and then immediately remove the stylus tip. You also have the option to perform the double-click operation by tapping your finger twice lightly on the Touch Screen. (Figure 2-24)

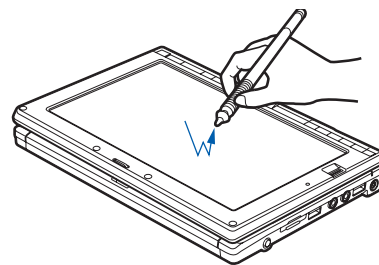
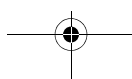
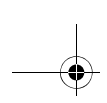

Figure 2-24 Double-clicking the Touch Screen





Dragging

Dragging means moving an item with the stylus by touching the screen, moving and then lifting the stylus. To drag, touch the Touch Screen with your stylus on the item you wish to move. While continuing to touch the screen with the stylus, drag the item to its new location by moving the stylus across the screen, and then lifting the stylus to release it. Dragging can also be done using your fingertip. (Figure 2-25)

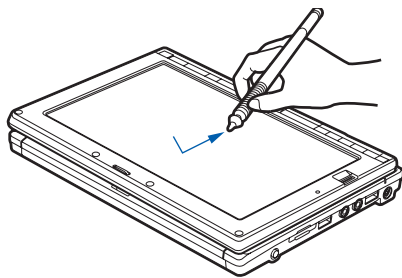

Figure 2-25 Dragging on the Touch Screen

Calibrating the Touch Screen

In order to ensure accurate tracking between the stylus and cursor, you must run the Touch Screen Calibration Utility before you use the Touch Screen for the first time, or after you change the display resolution and/or orientation.

To run the calibration utility:

1. Go to Start -> Control Panel. If you are not in Classic View, select "Switch to Classic View" in the left panel.
2. *Windows XP Professional:* Double-click the Touch Panel icon and select the Calibration tab.
Windows XP Tablet PC Edition: Double-click the Tablet and Pen Settings icon and select the Settings tab.
3. *Windows XP Professional:* Press the [Calibrate Now] button.
Windows XP Tablet PC Edition: Click the [Calibrate] button.
4. Adjust the display of your notebook to a comfortable angle and find the (+) symbol in the upper-left corner of the display.



Do not use excessive force when tapping on the screen during calibration. Use of excessive force could result in damage to the LCD and/or touch panel.



When using the stylus to calibrate the screen, be sure to avoid touching the screen with your fingers; doing so could result in faulty calibration.

5. Using the stylus, firmly touch the screen directly on the (+) symbol. Lift the stylus from the screen and the target will move to a different location on the screen.
6. Repeat step 4 until you have selected all of the (+) symbols.
7. Once you have selected all the symbols, press the [Update] button (Windows XP Professional) or the [OK] button (Windows XP Tablet PC Edition).
8. Touch the stylus to various points on the screen to verify that the screen is correctly calibrated. If you are not satisfied with the screen's calibration, press the [Calibrate Now] (or [Calibrate]) button to begin again.

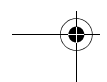
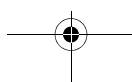
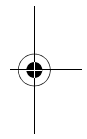
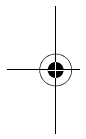

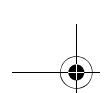

Volume Control

Your Fujitsu LifeBook notebook has multiple volume controls which interact with each other.



Any software that contains audio files will also contain a volume control of its own. If you install an external audio device that has an independent volume control, the hardware volume control and the software volume control will interact with each other. It should be noted that if you set your software volume to Off, you will override the external volume control setting.

CONTROLLING THE VOLUME

The volume can be controlled in several different ways:

- Volume can be set from within the Volume Control in the Notification Area at the bottom right of your screen.
- Volume can be controlled with the [F8] and [F9] functions keys. Pressing [F8] repeatedly while holding [Fn] will decrease the volume of your notebook. Pressing [F9] repeatedly while holding [Fn] will increase the volume of your notebook.
- Volume can be controlled by many volume controls that are set within individual applications.
- Certain external audio devices you might connect to your system may have hardware volume controls.
- Each source discussed above puts an upper limit on the volume level that must then be followed by the other sources.

We recommend that you experiment with the various volume controls to discover the optimal sound level.

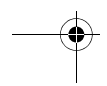
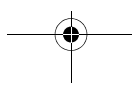
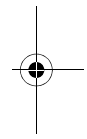
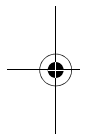

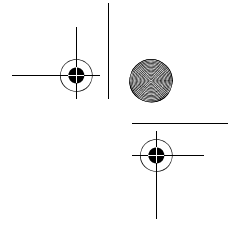
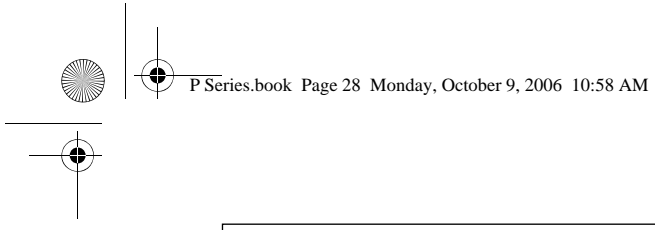

LifeBook P1600 Series Notebook

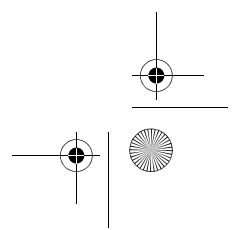
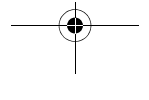
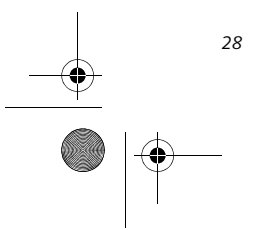
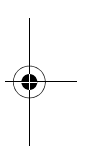
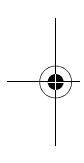

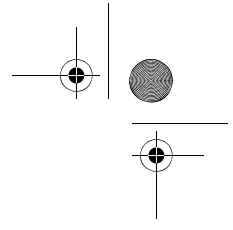
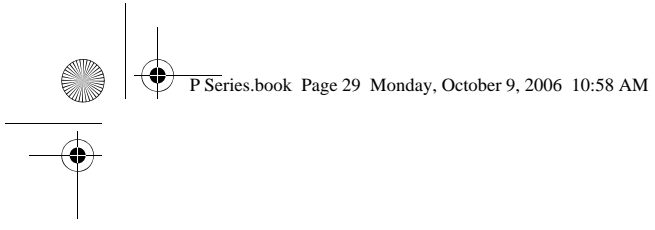

3 Using Your LifeBook

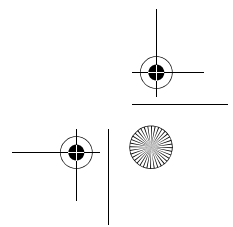
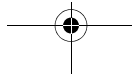
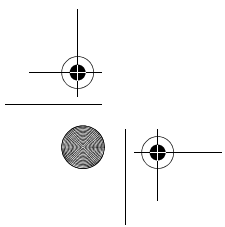
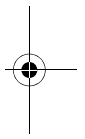
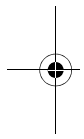

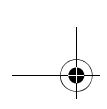

LifeBook P1600 Series Notebook

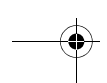
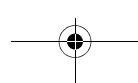
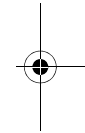
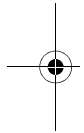

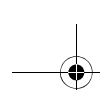

Getting Started

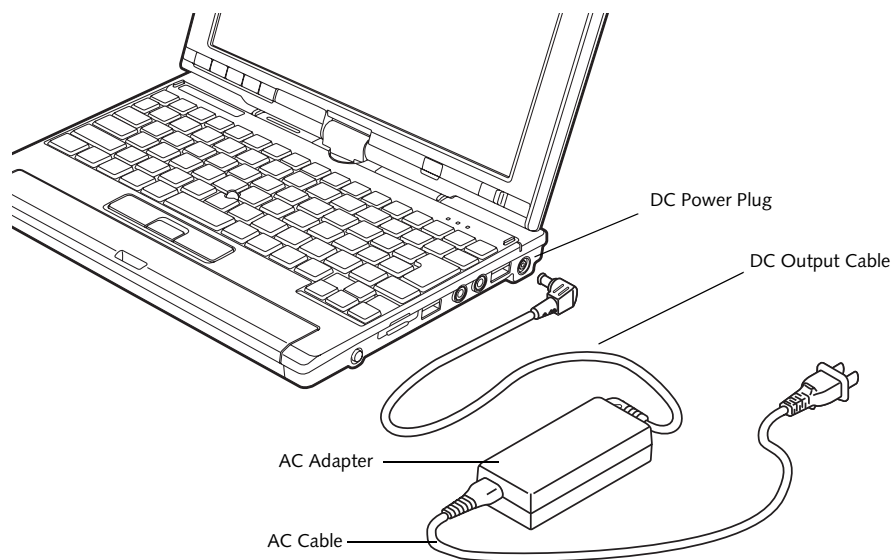

Figure 3-1. Connecting the AC Adapter

Power Sources

Your LifeBook P1600 Series notebook has three possible power sources: a primary Lithium ion battery, an AC adapter or an optional Auto/Airline adapter.

CONNECTING THE POWER ADAPTERS

The AC adapter or optional Auto/Airline adapter provides power for operating your system and charging the battery.

Connecting the AC Adapter

1. Plug the DC output cable into the DC power jack of your notebook.
2. Plug the AC adapter into an AC electrical outlet.
(Figure 3-1)

Connecting the Optional Auto/Airline Adapter

1. Plug the DC output cable into the DC power jack on your notebook.
2. Plug the Auto/Airline adapter into the cigarette lighter of an automobile with the ignition key in the On or Accessories position.
OR
3. Plug the Auto/Airline adapter into the DC power jack on an airplane seat.

Switching from AC Adapter Power or the Auto/Airline Adapter to Battery Power

1. Be sure that you have a charged battery installed.
2. Remove the AC adapter or the Auto/Airline adapter.



The Lithium ion battery is not charged upon purchase. Initially, you will need to connect either the AC adapter or the Auto/Airline adapter to use your system.

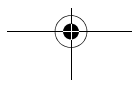
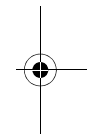
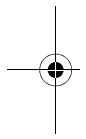

Starting Your LifeBook

POWER ON

The Suspend/Resume button is used to turn on your LifeBook P1600 Series notebook from its off state. Once you have connected your AC adapter or charged the internal Lithium ion battery, you can power on your notebook. (See figure 2-4 on page 9 for location).



When you turn on your notebook, be sure you have a power source. This means that a battery is installed and charged, or that a power adapter is connected and has power.

Slide the Power/Suspend/Resume button to the right to start your system. When you are done working you can either leave your system in Standby mode, (See “Standby Mode” on page 34), or you can turn it off. See “Power Off” on page 36.



When the system display is closed, the Suspend/Resume button is disabled. This feature prevents the system from being accidentally powered up when not in use.

When you Power On your system, it will perform a Power On Self Test (POST) to check the internal parts and configuration for correct functionality. If a fault is found, your system will emit an audio warning and/or an error message will be displayed. See “Power On Self Test Messages” on page 58. Depending on the nature of the problem, you may be able to continue by starting the operating system or by entering the BIOS setup utility and revising the settings.

After satisfactory completion of the Power On Self Test (POST), your notebook will load your operating system.



Never turn off your notebook during the Power On Self Test (POST) or it will cause an error message to be displayed when you turn your system on the next time. See “Power On Self Test Messages” on page 58.

BOOT SEQUENCE

The procedure for starting-up your notebook is termed the Bootup sequence and involves your system's BIOS. When your notebook is first turned on, the main system memory is empty, and it needs to find instructions to start up your notebook. This information is in the BIOS program. Each time you power up or restart your system, it goes through a boot sequence which displays a Fujitsu logo until your operating system is loaded.

During booting, your system is performing a standard boot sequence including a Power On Self Test (POST). When the boot sequence is completed without a failure and without a request for the BIOS Setup Utility, the system displays the operating system's opening screen.

The boot sequence is executed when:

- You turn on the power to your notebook.
- You restart your notebook from the Windows Shut Down dialog box.
- The software initiates a system restart (e.g., when you install a new application).

BIOS SETUP UTILITY

The BIOS Setup Utility is a program that sets up the operating environment for your notebook. Your BIOS is set at the factory for normal operating conditions, therefore there is no need to set or change the BIOS' environment to operate your system.

The BIOS Setup Utility configures:

- Device control feature parameters, such as changing I/O addresses and boot devices.
- System Data Security feature parameters, such as passwords.

Entering the BIOS Setup Utility

To enter the BIOS Setup Utility do the following:

1. Turn on or restart your notebook.
2. Press any key or click your mouse once the Fujitsu logo appears on the screen. This will open the main menu of the BIOS Setup Utility with the current settings displayed.
3. Press the [RIGHT ARROW] or [LEFT ARROW] key to scroll through the other setup menus to review or alter the current settings.

BIOS Guide

A guide to your system's BIOS is available online. Please visit our service and support website at <http://www.computers.us.fujitsu.com/support>. Once there, select LifeBook BIOS Guides from the pull-down menu for your notebook series. If you are unsure of your system's BIOS number, refer to your packing slip.



If your data security settings require it, you may be asked for a password before the BIOS main menu will appear.



Getting Started

BOOTING THE SYSTEM

We strongly recommend that you not attach any external devices until you have gone through the initial power on sequence.

When you turn on your LifeBook notebook for the first time, it will display a Fujitsu logo on the screen. If you do nothing the system will load the operating system, and then the Windows Welcome will begin.

Registering Windows with Microsoft

In order to ensure that you receive the most benefit from the Windows operating system, it should be registered the first time you use it.

After you receive the Windows Welcome screen, you will be prompted to enter registration information in the following order.

First of all, you will need to read and accept the End User License Agreements (EULAs). After accepting the EULAs, you will be asked if you want to enable the Automatic Updates feature. Acceptance of this feature is recommended because it allows your system to be updated automatically whenever an important change becomes available for your notebook.



- If you reject the terms of the license agreement you will be asked to review the license agreement for information on returning Windows or to shut down your LifeBook notebook.
- You cannot use your LifeBook notebook until you have accepted the License Agreement. If you stop the process, your system will return to the beginning of the Windows Welcome Process, even if you shut your system down and start it up again.

Several additional windows will appear, prompting you to enter a name and description for your computer, an Administrator password, and a domain name. Read the instructions on the screens carefully and fill in the information as directed.

You will then be automatically connected to the Internet, if you have an appropriate connection available. If an automatic connection is not possible, you will be advised on how to select and change an available connection at a later date. You will then be asked if you want to register with Microsoft. If you are not connected to a phone line and plan to register at a later time, you may click the **Skip** button.

Once you are connected to the Internet, you will be asked if you wish to continue with the registration. If you select **Yes** you will then enter your name and address, and email address if desired. Click **Next** to complete registration.

REGISTERING YOUR NOTEBOOK

How do I register my notebook?

You can register your LifeBook by going to our website:

<http://www.computers.us.fujitsu.com/support>

You will need to be set up with an Internet Service Provider (ISP) to register online.



INSTALLING CLICK ME!



Before installing the Click Me! utility, be sure to turn on your WLAN/Bluetooth On/Off switch.

The first time you boot up your system, you will see an icon called Click Me! in the Start menu. When you click the Click Me! icon, your system will automatically install Fujitsu-customized settings and applications. It is important to run the utility to ensure all functions work as intended.

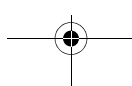

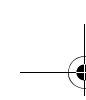

Power Management

Your LifeBook P1600 Series notebook has many options and features for conserving battery power. Some of these features are automatic and need no user intervention, such as those for the internal modem. However, others depend on the parameters you set to best suit your operating conditions, such as those for the display brightness. Internal power management for your notebook may be controlled from settings made in your operating system, pre-bundled power management application, or from settings made in BIOS setup utility.

Besides the options available for conserving battery power, there are also some things that you can do to prevent your system battery from running down as quickly. For example, you can create an appropriate power saving profile, put your system into Standby mode when it is not performing an operation, and you can limit the use of high power devices. As with all mobile, battery powered computers, there is a trade-off between performance and power savings.

Power Mode	System Activity	Events causing system to enter mode state
Fully On Mode	System is running. CPU, system bus, and all other interfaces operate at full speed.	<ul style="list-style-type: none"> ▪ From Standby mode: System operation resumed (Suspend/Resume button pressed, resume on modem ring, resume on time). ▪ From Hibernation mode: Suspend/Resume button pressed. ▪ From Off mode: Suspend/Resume button pressed.
Standby Mode (Suspend-to-RAM)	Resume system logic remains powered and RAM remains powered to maintain active data. All other devices are turned off.	<ul style="list-style-type: none"> ▪ Standby timeout occurs. ▪ Suspend request issued by software or by pressing the Suspend/Resume button. ▪ Low battery.
Hibernation Mode (Suspend-to-Disk)	Windows saves desktop state (including open files and documents) to hard disk. CPU stops. All other devices are turned off.	<ul style="list-style-type: none"> ▪ Suspend timeout occurs. ▪ Clicking Start -> Shut Down -> Hibernate (It may be necessary to Enable Hibernate Support from Windows Power Options.) ▪ Low battery condition
Power Off	System is fully powered off except for logic components required for Suspend/Resume button and real-time clock operation.	<ul style="list-style-type: none"> ▪ System shutdown. ▪ Low battery condition

Table 3-1. System Power States

SUSPEND/RESUME BUTTON

When your notebook is active, the Suspend/Resume button can be used to manually put your system into Standby mode. Push the Suspend/Resume button to the right when your notebook is active, but not actively accessing anything, and immediately release the button. You will hear two short beeps and your system will enter Standby mode. (See figure 2-4 on page 9 for location).

If your notebook is suspended, pushing the Suspend/Resume button will return your system to active operation. You can tell whether or not your system is in Standby mode by looking at the Power indicator. See “” on page 14. If the indicator is visible and not flashing, your system is fully operational. If the indicator is both visible and flashing, your system is in Standby mode. If the indicator is not visible at all, the power is off or your system is in Hibernate mode (See *Hibernate Mode*)

STANDBY MODE

Standby mode in Windows saves the contents of your notebook's system memory during periods of inactivity by maintaining power to critical parts. This mode will turn off the CPU, the display, the hard drive, and all of the other internal components except those necessary to maintain system memory and allow for restarting. Your system can be put in Standby mode by:

- Pressing the Suspend/Resume button when your system is turned on.
- Selecting Standby from the Windows Shut Down menu.
- Timing out from lack of activity.
- Allowing the battery to reach the Dead Battery Warning condition.
- Closing the system cover.

Your notebook's system memory typically stores the file(s) on which you are working, open application(s) information, and any other data required to support the operation(s) in progress. When you resume operation



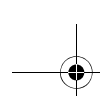

Getting Started

from Standby mode, your system will return to the point where it left off. To resume operation, you must use the Suspend/Resume button to resume operation, and there must be an adequate power source available, or your system will not resume.



If you are running your notebook on battery power, be aware that the battery continues to discharge while your system is in Standby mode, though not as fast as when fully operational.

HIBERNATE MODE

The Hibernate mode saves the contents of your notebook's system memory to the hard drive as a part of the Suspend/Resume mode. Your system is pre-configured to perform this function. The Hibernate mode can also be configured through the system BIOS to run in other ways depending on what you need to accomplish. See "BIOS Setup Utility" on page 32.

- Standby or Hibernate modes should not be used with certain PC Cards. Check your PC Card documentation for more information.
- Disabling the Suspend/Resume button prevents it from being used to put your notebook in Standby or Hibernate mode. The resume function of the button cannot be disabled.
- If your notebook is actively accessing information when you enter Standby or Hibernate mode, changes to open files are not lost. The files are left open and memory is kept active during Standby mode or the memory is transferred to the hard drive during Hibernate mode.
- When PC Cards or external devices are in use, Save-to-Disk mode cannot return to the exact state prior to suspension, because all peripheral devices will be re-initialized when the system restarts.
- The main advantage of using Hibernate mode is that power is not required to maintain your data. This is very important if you will be leaving your system in a suspended state for a prolonged period of time. The drawback of using Hibernate mode is that it lengthens the power down and power up sequences and resets peripheral devices.



Using Hibernate Mode

Hibernate default setting is enabled for Windows XP.

To enable or disable the Hibernation feature follow these easy steps:

1. From the Start menu, select Control Panel -> Power Options.
2. Select the **Hibernate** tab and then select the box to enable or disable this feature.

To use Hibernate mode with your system:

1. From the Start menu, select Control Panel -> Power Options.
2. Select the **Power Schemes** tab and in the **System hibernates boxes**, select the amount of time you want to elapse until the system goes into hibernation (when plugged in and when running on battery power).

DISPLAY TIMEOUT

The Video Timeout is one of the power management parameters. This feature saves power by turning off the display if there is no keyboard or pointer activity for the user selected timeout period. Any keyboard or pointer activity will cause the display to restart automatically. This feature is independent of the Suspend/Resume button and can be enabled and disabled in Windows Power Management.

HARD DISK TIMEOUT

The Hard Disk Timeout is another one of the power management parameters. This feature saves power by turning off the hard drive if there is no hard drive activity for the user selected timeout period. Any attempt to access the hard drive will cause it to restart automatically. This feature is independent of the Suspend/Resume button and can be enabled and disabled in Windows.

WINDOWS POWER MANAGEMENT

The Power Options icon located in the Windows Control Panel allows you to configure some of the power management settings. For example, you can use the Power Options to set the timeout values for turning off the display and hard disks whether you are running the notebook on battery power or one of the adapters.

RESTARTING THE SYSTEM

If your system is on and you need to restart it, be sure that you use the following procedure.

1. Click the **Start** button, and then click **Turn Off Computer**.
2. Select the **Restart** button from within the Turn Off Computer window.



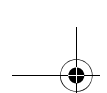

Turning off your system without exiting Windows or turning on your system within 10 seconds of the system being shut off may cause an error when you start the next time.

POWER OFF

Before turning off the power by choosing Turn Off Computer from the Windows Start menu, check that the Hard Drive access indicator is off. (See Figure 2-9 on page 14) If you turn off the power while accessing a disk there is a risk of data loss. To ensure that your notebook shuts down without error, use the Windows shut down procedure.

Using the correct procedure to shut down from Windows allows your notebook to complete its operations and turn off power in the proper sequence to avoid errors. The proper sequence is:

1. Click the **Start** button, and then click **Turn Off Computer**.
2. Select the **Turn Off** option from within the window.

If you are going to store your notebook for a month or more, see the Care and Maintenance section.

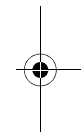
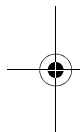

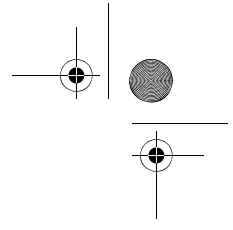
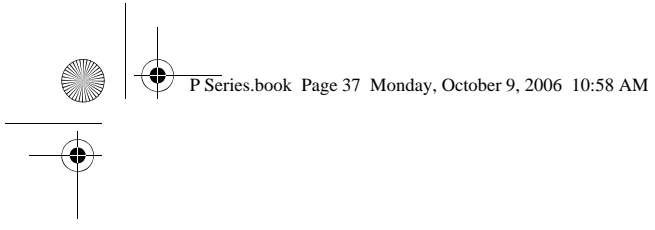

4

User-Installable Features

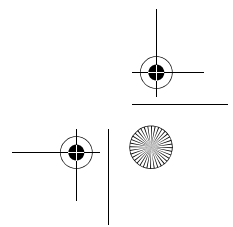
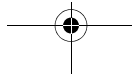
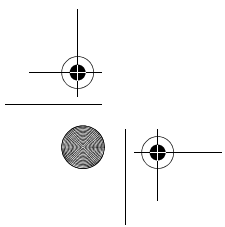
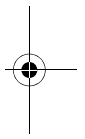
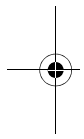

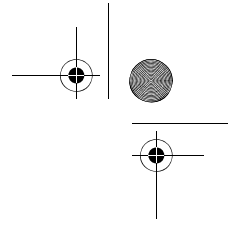
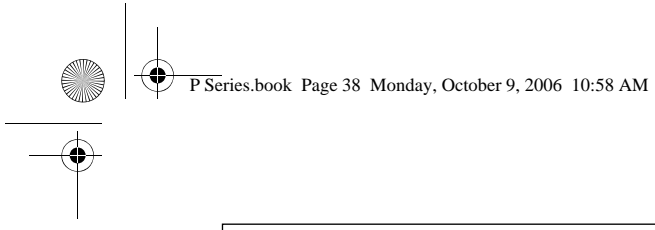

LifeBook P1600 Series Notebook

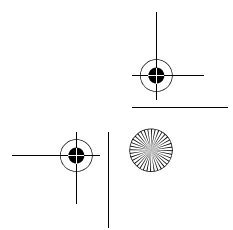
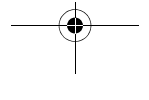
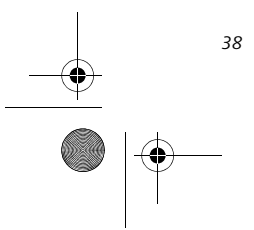
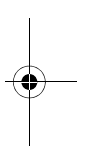
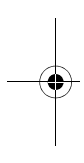



User-Installable Features

Lithium ion Battery

Your LifeBook P1600 Series notebook has a Lithium ion battery that provides power for operating your notebook when no external power source is available. The battery is durable and long lasting, but should not be exposed to extreme temperatures, high voltages, chemicals or other hazards.

The Lithium ion battery operating time may become shorter if it is used under the following conditions:

- When used at temperatures lower than 41° F (5° C) or higher than 95° F (35° C). Extreme temperatures not only reduce charging efficiency, but can also cause battery deterioration. The Charging icon on the Status Indicator panel will flash when you try to charge a battery that is outside its operating temperature range. See "" on page 14.
- When using a high current device such as a modem, CD-ROM drive, or hard drive, using the AC adapter will conserve your battery life.

- Do not leave a faulty battery in your system. It may damage your AC adapter, optional Auto/Airline adapter, or your notebook itself. It may also prevent operation of your notebook by draining all available current into the bad battery.



- Under federal, state, or local law it may be illegal to dispose of batteries by putting them in the trash. Please take care of our environment and dispose of batteries properly. Check with your local government authority for details regarding recycling or disposing of old batteries. If you cannot find this information elsewhere, contact your support representative at 1-800-8Fujitsu.



Actual battery life will vary based on screen brightness, applications, features, power management settings, battery condition and other customer preferences. CD-ROM drive or hard drive usage may also have a significant impact on battery life. The battery charging capacity is reduced as the battery ages. If your battery is running low quickly, you should replace it with a new one.

RECHARGING THE BATTERY

If you want to know the condition of the Lithium ion battery, check the Battery Level indicator located on the Status Indicator panel. The indicator changes as the battery level changes.

The Lithium ion battery is recharged internally using the AC adapter or Auto/Airline adapter. To recharge the battery make sure the battery that needs to be charged is installed in your notebook and connect the AC or Auto/Airline adapter.



Make sure that the Battery Charging indicator and the Battery Level indicator icon on the Status Indicator Panel light.

There is no memory effect on the Lithium ion battery, therefore you do not need to discharge the battery completely before recharging. The charge times will be longer if your system is in use while the battery is charging. If you want to charge the battery more quickly, put your system into Standby mode, or turn it off while the adapter is charging the battery. See "Power Management" on page 34.



Using heavy current devices such as a modem or frequent CD-ROM and PCMCIA powered external device accesses may prevent charging completely.

Low Battery State

When the battery is running low, the Battery Level indicator will glow red. If you do not respond to the low battery alarm, the batteries will continue to discharge until they are too low to operate. Your notebook will then go into Standby mode to try and protect your data for as long as possible. There is no guarantee that your data will not be lost once the system reaches this point.

- Once the low battery indicator appears you must save all your data and put your notebook into Standby mode until you can provide a new power source. You should provide a charged battery or AC or Auto/Airline Adapter as soon as possible.



- When you are in Standby mode there must always be at least one power source active. If you remove all power sources while your notebook is in Standby mode, any data that has not been saved to the hard drive will be lost.

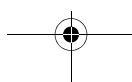
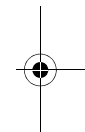
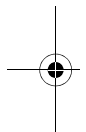



Once your notebook goes into Dead Battery Suspend mode you will be unable to resume operation until you provide a source of power either from an adapter, or a charged battery. Once you have provided power, you will need to press the Suspend/Resume button to resume operation. In the Dead Battery Suspend mode, your data can be maintained for some time, but if a power source is not provided promptly, the Power indicator will stop flashing and go out, meaning that you have lost the data that was not stored. Once you provide power, you can continue to use your system while an adapter is charging the battery.

REPLACING THE BATTERY

Your LifeBook P1600 Series notebook comes with one battery pack; you might want to consider purchasing a spare. By keeping a spare battery fully charged, you can immediately swap with one that is not charged.

There are two ways to swap batteries: cold-swapping and hot-swapping. Cold-swapping means swapping batteries when the system has been powered down; hot-swapping is performed when the system is powered by AC power.

Cold-swapping batteries

To cold-swap batteries in your battery compartment, follow these easy steps: (Figure 4-1)

1. Have a charged battery ready to install.
2. Shut down your system and disconnect the AC adapter.
3. Lift the display enough to pull the display latch from the slot.
4. Press the battery release latches to open the compartment.
5. Remove the battery from the compartment.
6. Slide the new battery into the compartment.
7. Close the compartment and the battery release latches will click into place.
8. Plug in the AC adapter and turn the power on.

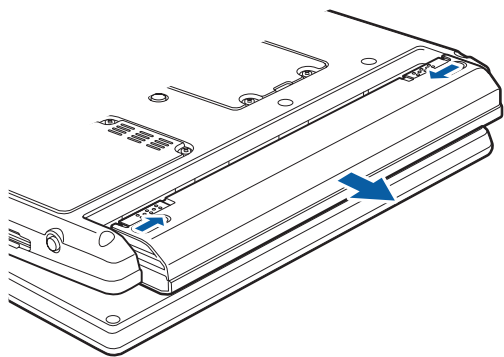

Figure 4-1. Removing the Battery

Hot-swapping Batteries

To hot-swap batteries in your battery compartment follow these easy steps: (Figure 4-1)

1. Close any open files and put your system into Standby mode.
2. Connect an AC adapter or Auto/Airline power adapter to provide power to the system.
3. Lift the display enough to pull the display latch from the slot.
4. Press the battery release latches inward to open the compartment.
5. Remove the battery from the compartment.
6. Slide the new battery into the compartment.
7. Close the compartment and the battery release latches will click into place.
8. Press the Suspend/Resume button to return your system to normal operation.



If the Lithium ion battery connector is not fully seated, you may not be able to use your notebook or charge your battery.

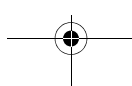

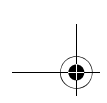

Memory Upgrade Module

Your Fujitsu LifeBook P1600 Series notebook comes with a minimum of 512 MB of high speed Double Data Rate Synchronous Dynamic RAM 2 (DDR2 SDRAM), 533 MHz factory installed. To increase your system's memory capacity, you may install a memory upgrade module. The memory upgrade must be a dual-in-line (DIMM) SDRAM module. To ensure 100% compatibility, purchase the SDRAM module only from the Fujitsu web store at www.shopfujitsu.com.

The system contains components that can be severely damaged by electrostatic discharge (ESD). To minimize risk to the components, observe the following precautions:

- Be sure to power down your system before adding or removing system components. Even if the system is in hibernate or standby states, data could be lost or memory could be damaged if power is still available to the system.
- When installing or removing a memory module, hold it by the edge so as not to touch any contacts or chips. Be careful not to touch any internal computer terminals or components; the oil from your fingers could cause a short to the components.



Electrical equipment may be hazardous if misused. Operations of this product or similar products, must always be supervised by an adult. Do not allow children access to the interior of any electrical products and do not permit them to handle any cables.



Do not remove any screws from the memory upgrade module compartment except those specifically shown in the directions for installing and removing the module.

REMOVING MEMORY MODULES

1. Turn off power to your LifeBook notebook and remove any power adapter (AC or auto/airline).
2. Make sure that all the connector covers are closed.
3. Turn the system bottom side up, and remove the screws of the memory upgrade module compartment. (Figure 4-2)
4. Remove the cover.

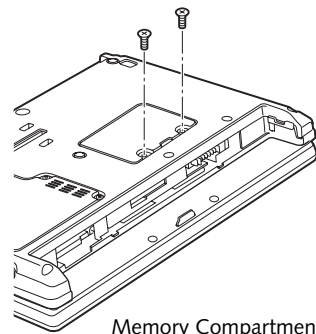

Memory Compartment Cover

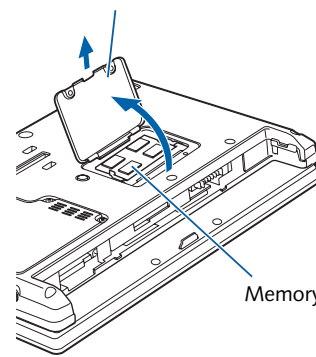

Memory Module

Figure 4-2. Opening the Memory Upgrade Compartment

5. Pull the clips sideways away from each side of the memory upgrade module at the same time. (Figure 4-3)
6. While holding the clips out, remove the module from the slot by lifting it up and pulling towards the rear of your notebook.
7. Store the memory module in a static guarded sleeve.
8. Install a new module as outlined in the procedure below.
9. Replace the cover.
10. Replace the screws.

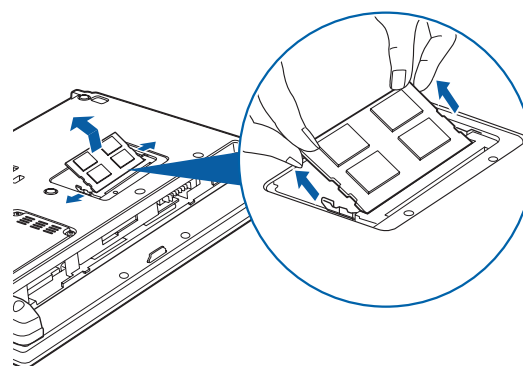

Figure 4-3. Removing a Memory Module



INSTALLING A MEMORY UPGRADE MODULE

1. Remove the new memory upgrade module from the static guarded sleeve.
2. Align the memory upgrade module with the component side up. Align the connector edge of the memory upgrade module with the connector slot in the compartment. (Figure 4-4)
3. Insert the memory upgrade module at a 45° angle. Press the connector edge of the module firmly down and into the connector until it lodges under the retaining clip. You will hear a click when it is properly in place.
4. Replace the cover. (Figure 4-4)
5. Replace the screws.

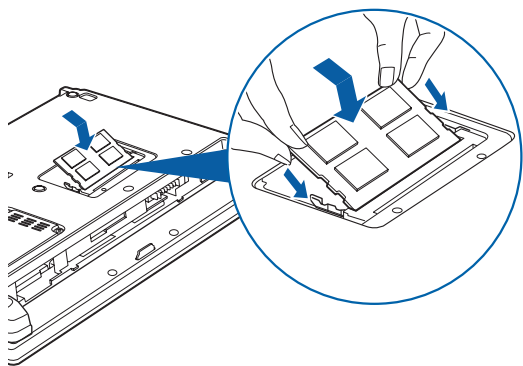

Figure 4-4. Replacing the Memory Compartment Cover



The memory upgrade module is not something you routinely remove from your notebook. Once it is installed, you should leave it in place unless you want to change system memory capacity.

CHECKING THE MEMORY CAPACITY

Once you have changed the system memory capacity by either adding or removing a memory upgrade module, be sure to check that your system has recognized the change.



Your notebook uses Dynamic Video Memory Technology (DVMT), which allows the video driver to dynamically determine the amount of memory that is used. Your system can use a maximum of 128 MB of system memory for video functions.

You can check the memory capacity by clicking [Start] -> Control Panel, then double-clicking the System icon. Select the General tab and check the amount of memory under "Computer."

The amount of memory displayed should be approximately the total of all memory modules installed. There may be a discrepancy of several megabytes which are allocated for fixed video memory.



If the total memory displayed is incorrect, check that your memory upgrade module is properly installed. (If the module is properly installed and the capacity is still not correctly recognized, see *Troubleshooting* on page 52.)

User-Installable Features

Figure 4-5. Inserting an SD Card

Secure Digital Media

Your LifeBook notebook supports Secure Digital (SD) cards, on which you can store and transfer data to and from a variety of digital devices. These cards use flash memory architecture, which means they don't need a power source to retain data.

Secure Digital (SD) Cards allow portable storage among a variety of devices, such as cell phones, GPS systems, digital cameras, and PDAs. SD Cards transfer data quickly, with low battery consumption. It uses flash memory architecture.

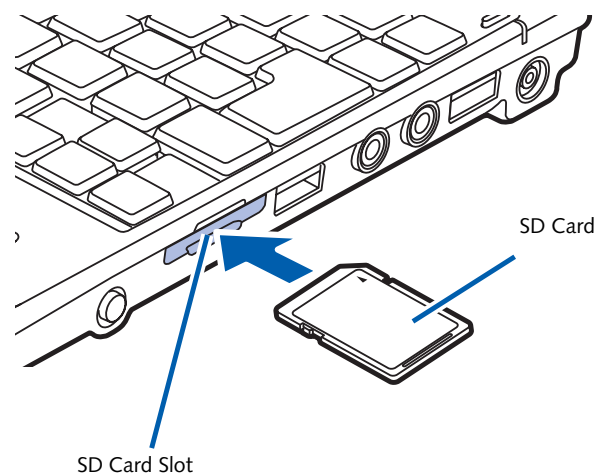
INSERTING SD CARDS

SD Cards are inserted in the SD Card slot (Figure 4-5). To insert an SD Card, follow these steps:



- Inserting or removing an SD Card during your LifeBook notebook's shutdown or bootup process may damage the card and/or your LifeBook notebook.
- Do not insert a card into a slot if there is water or any other substance on the card as you may permanently damage the card, your LifeBook notebook, or both.

1. See your SD Card manual for instructions on the insertion of your card. Some cards may require that your system is off while inserting them.
2. Make sure there is no card currently in the slot. If there is, see Removing an SD Card.
3. Insert your card into the slot with the product label facing up.
4. Push the card firmly into the slot until it is seated in the connector.

REMOVING AN SD CARD

To remove an SD Card, first see your SD Card manual for instructions. Some cards may require your LifeBook notebook to be in Suspend Mode or Off while removing them. Prior to removing the card from the slot, first select it using the Safely Remove Hardware icon in the notification area. To remove the card, push it in to release it, then pull it out.

LifeBook P1600 Series Notebook

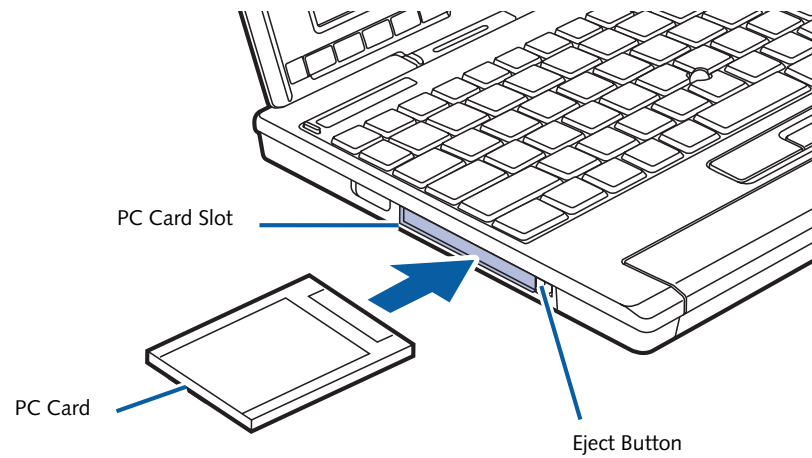

Figure 4-6. Inserting/Removing PC Cards

PC Cards

Your LifeBook notebook supports Type I and Type II PC Cards, which can perform a variety of functions.

Some available PC Cards:

- Wireless Wide Area Network (WAN) cards
- Fax/data modem cards
- Local area network (LAN) cards
- IDE solid-state disk cards
- SCSI cards
- Other PC Cards that conform to PCMCIA 2.1 or CardBus standards

For further information, refer to the instructions supplied with your PC Card.

INSERTING PC CARDS

PC Cards are inserted in the PC Card slot. To insert a PC Card, follow these steps: (Figure 4-6)



- Inserting or removing a PC Card during your notebook's shutdown or bootup process may damage the card and/or your notebook.
- Do not insert a PC Card into a slot if there is water or any other substance on the card as you may permanently damage the card, your notebook, or both.

1. See your PC Card manual for specific instructions on the insertion of your card. Some PC Cards may require your notebook to be Off while inserting them.
2. Make sure there is no PC Card currently in the slot. If there is, see Removing PC Cards.
3. Insert your PC Card into the slot, with the product label facing up.

4. Push the card into the slot firmly until it is seated in the opening.



Windows has a shutdown procedure for PC Cards that must be followed before removing a card. (Review your operating system manual for the correct procedure)

REMOVING PC CARDS

To remove a PC Card, follow these steps:

1. See your PC Card manual for specific instructions on removing your card. Some PC Cards may require your notebook to be in Standby Mode or Off while removing them.



If the dialog box states that the device cannot be removed, you must save all of your open files, close any open applications and shut down your LifeBook.

2. Push the Eject button until it pops out, and then push it in to eject the card. This will allow you to remove the card.



If the PC Card has an external connector and cable, do not pull the cable when removing the card.

User-Installable Features

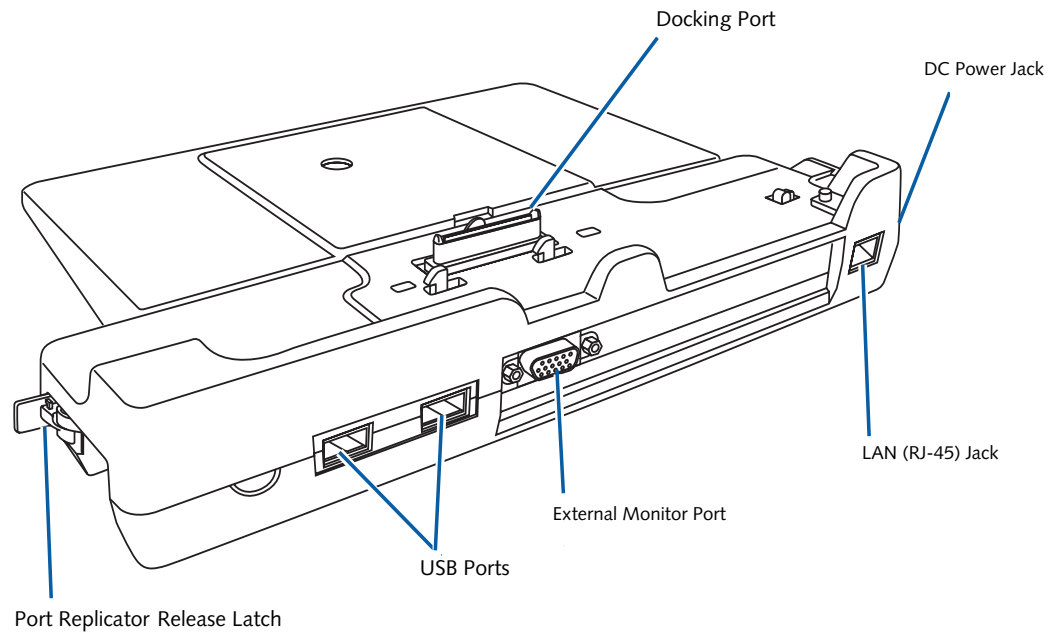

Figure 4-7. Port Replicator rear panel

Port Replicator

An optional Port Replicator is available from Fujitsu to support your LifeBook P1600 Series notebook. The Port Replicator extends the functionality of your system by providing ports to connect USB devices, an external monitor, external speaker, or a LAN device. The Port Replicator connects to the bottom of your notebook. See “Device Ports” on page 47.

PORT REPLICATOR COMPONENTS

Following is a description of the Port Replicator components. (Figure 4-7)

DC Power Jack

The DC power jack allows you to plug in the AC adapter to power your notebook and charge the internal Lithium ion battery.

USB 2.0 Ports (Qty. 2)

Universal Serial Bus (USB) 2.0 ports allow you to connect USB devices. USB 2.0 ports are backward-compatible with USB 1.1 devices.

External Monitor Port

The external monitor port allows you to connect an external VGA or SVGA monitor. Note that if a Port Replicator is attached, you must use the external monitor port on the Port Replicator, not the one on your system.

LAN (RJ-45) Jack

The LAN jack allows you to connect a LAN to the Port Replicator. Note that when the system is attached to the Port Repli-

cator, the LAN Jack on the Port Replicator should be used, not the one on the system.

Docking Port

The docking port connects the Port Replicator to your LifeBook notebook.

Port Replicator Release Latch

Pull the Port Replicator Release latch away from the Port Replicator to remove the Port Replicator from your notebook.

- The system contains components that can be severely damaged by electrostatic discharge (ESD). To minimize risk to the components, observe the following precautions:
 - Before docking or undocking your LifeBook notebook (when using a port replicator), it is a good practice to always touch a grounded metal object to discharge static electricity built up in your body.
 - Be sure to power down your system before adding or removing system components. Even if the system is in hibernate or standby states, data could be lost or memory could be damaged if power is still available to the system.



ATTACHING PORT REPLICATOR

To attach the Port Replicator, align the Port Replicator connector on the bottom of your notebook with the connector on the Port Replicator and push the corners down simultaneously. (Figure 4-8)

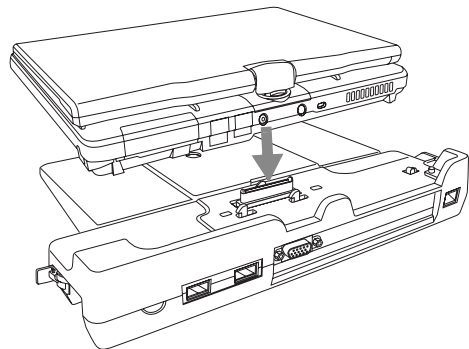

Figure 4-8. Attaching the Port Replicator

DETACHING PORT REPLICATOR

To detach the Port Replicator:

1. Pull the Port Replicator's release latch away from the Port Replicator to release it from your notebook. (Figure 4-9)

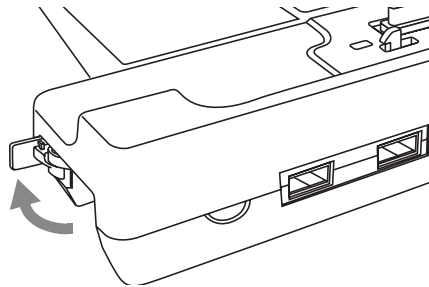

Figure 4-9. Unlatching the Port Replicator

2. Pull the notebook away from the Port Replicator to detach it from your system. (Figure 4-10)

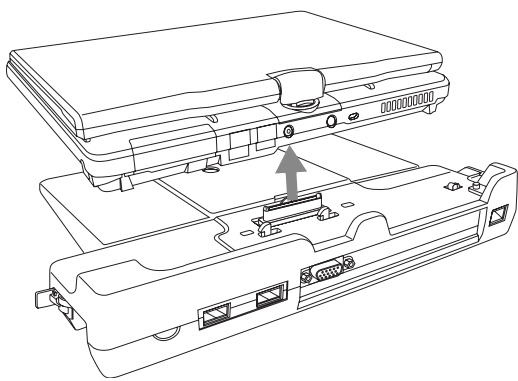

Figure 4-10. Removing the Port Replicator

Device Ports

Your LifeBook P1600 Series notebook and the optional Port Replicator come equipped with multiple Device Ports to which you can connect an external device including: disk drives, keyboards, modems, printers, etc.

MODEM (RJ-11) JACK

The modem (RJ-11) jack is used for an internal modem. To connect the telephone cable follow these easy steps: (See figure 2-7 on page 12 for location)

1. Align the connector with the jack opening.
2. Push the connector into the jack until it is seated.
3. Plug the other end of the telephone cable into a telephone outlet.

The internal modem is not intended for use with Digital PBX systems. Do not connect the internal modem to a Digital PBX as it may cause serious damage to the internal modem or your entire LifeBook P1600 Series notebook. Consult your PBX manufacturer's documentation for details. Some hotels have Digital PBX systems. Be sure to find out BEFORE you connect your modem.



- The internal modem is designed to the ITU V.90 standard. Its maximum speed of 53000 bps is the highest allowed by FCC, and its actual connection rate depends on the line conditions. The maximum speed is 33600 bps at upload.
- The internal modem on all LifeBook P1600 Series notebook's from Fujitsu Computer Systems Corporation are certified for use in the United States and Canada.

INTERNAL LAN (RJ-45) JACK

The internal LAN (RJ-45) jack is used for an internal 10/100/1000 BaseTx Ethernet connection. You will need to configure your notebook to work with your particular network. (Please refer to your network administrator for information on your network configuration.) To connect the LAN cable follow these easy steps: (See figure 2-7 on page 12 for location)

Note that the optional Port Replicator is designed to cover the LAN jack located on the system. This design ensures that the LAN jack on the Port Replicator is the only one used when the Port Replicator is installed.



1. Align the connector with the jack opening.
2. Push the connector into the jack until it is seated.
3. Plug the other end of the cable into a LAN outlet.

DOCKING PORT

The docking port is used for the connection of your system to an optional port replicator. In order to connect your system to one of these devices follow the instructions that came with your port replicator. (See figure 2-8 on page 13 for location)

UNIVERSAL SERIAL BUS PORTS

The two Universal Serial Bus 2.0 ports (USB) allow you to connect USB devices such as external floppy disk drives, external DVD drives, game pads, pointing devices, keyboards and/or speakers. USB 2.0 is downward-compatible with USB 1.1 devices, so older USB devices will work with these ports. USB 2.0 is a much faster design, running forty times faster than USB 1.1.

In order to connect a USB device, follow these easy steps: (See figure 2-7 on page 12 for location)

1. Align the connector with the port opening.
2. Push the connector into the port until it is seated.

MICROPHONE JACK

The microphone jack allows you to connect an external mono microphone. Your microphone must be equipped with a 1/8" (3.5 mm) mono mini-plug in order to fit into the microphone jack of your notebook. In order to connect a microphone follow these easy steps: (See figure 2-6 on page 11 for location)

1. Align the connector with the port opening.
2. Push the connector into the port until it is seated.

HEADPHONE JACK

The headphone jack allows you to connect headphones or powered external speakers to your notebook. Your headphones or speakers must be equipped with a 1/8" (3.5 mm) stereo mini-plug. In order to connect headphones or speakers follow these easy steps: (See figure 2-6 on page 11 for location)

1. Align the connector with the port opening.
2. Push the connector into the port until it is seated.

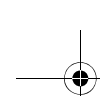

If you plug headphones into the headphone jack, the built-in stereo speakers will be disabled.

EXTERNAL VIDEO PORT

The external video port allows you to connect an external monitor or LCD projector. In order to connect an external device follow these easy steps: (See figure 2-7 on page 12 for location). There is also an external VGA monitor on the port replicator (See figure 4-7 on page 45 for location).

1. Remove the cover from the port opening, if present.
2. Align the connector with the port opening.
3. Push the connector into the port until it is seated.
4. Tighten the two hold-down screws, located on each side of the connector.



When an external monitor is plugged in, pressing the [Fn] + [F10] keys allows you to change your selection of where to send your display video. Each time you press the key combination, you will step to the next choice, starting with the built-in display panel only, moving to the external monitor only, finally moving to both the built-in display panel and an external monitor.

When an external monitor is plugged in, pressing the LifeBook Application Panel Secondary Function buttons (Fn + Screen Rotation Button) also allows you to change your selection of where to send your display video.



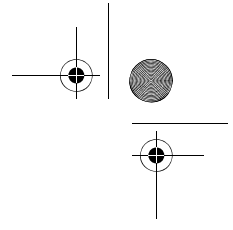
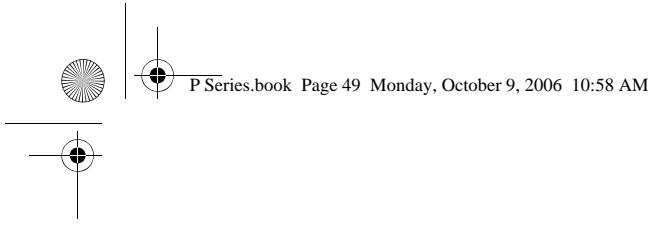

5

Troubleshooting

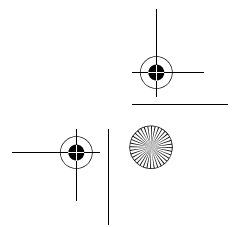
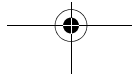
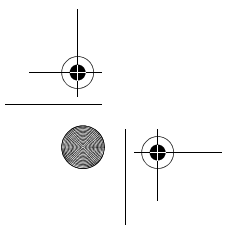
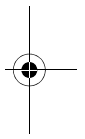
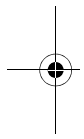

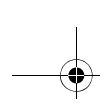

LifeBook P1600 Series Notebook

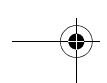
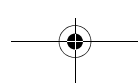
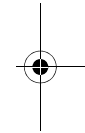
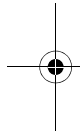



Troubleshooting

Your LifeBook P1600 Series notebook is sturdy and subject to few problems in the field. However, you may encounter simple setup or operating problems that you can solve on the spot, or problems with peripheral devices, that you can solve by replacing the device. The information in this section helps you isolate and resolve some of these straightforward problems and identify failures that require service.

IDENTIFYING THE PROBLEM

If you encounter a problem that you are having difficulty in solving, go through the following procedure before pursuing further troubleshooting:

1. Turn off your notebook.
2. Make sure the AC adapter is plugged into your system and to an active AC power source.
3. Make sure that any card inserted in the PC Card slot is seated properly. You can also remove the card from the slot, thus eliminating it as a possible cause of failure.
4. Make sure that any devices connected to the external connectors are plugged in properly. You can also disconnect such devices, thus eliminating them as possible causes of failure.
5. Turn on your notebook. Make sure it has been off at least 10 seconds before you turn it on.
6. Go through the boot sequence.
7. If the problem has not been resolved, refer to the Troubleshooting Table, that follows, for more detailed troubleshooting information.
8. If you still have the problem after taking all of the above approaches, please check our support website at <http://www.computers.us.fujitsu.com/support> for possible known support issues.



- If you keep notes about what you have tried, your support representative may be able to help you more quickly by giving additional suggestions over the phone.
- Do not return a failed notebook to your supplier until you have talked to a support representative.

9. If you have tried the solutions suggested in the Troubleshooting Table and checked our website for possible solutions without success, contact your support representative:

Toll free: 1-800-8Fujitsu

E-mail: 8fujitsu@us.fujitsu.com

Website:

<http://www.computers.us.fujitsu.com/support>

Before you place the call, you should have the following information ready so that the customer support representative can provide you with the fastest possible solution:

- Product name
- Product configuration number
- Product serial number
- Purchase date
- Conditions under which the problem occurred
- Any error messages that have occurred
- Type of device connected, if any

See the Configuration Label on the bottom of your notebook for configuration and serial numbers. (See *figure 2-8 on page 13* for location)

SPECIFIC PROBLEMS

Using the Troubleshooting Table

When you have problems with your notebook, try to find the symptoms under the Problem column of the troubleshooting table for the feature giving you difficulty.

You will find a description of common causes for that symptom under the column Possible Cause and what, if anything, you can do to correct the condition under Possible Solutions. All possible causes or solutions may not apply to your notebook.



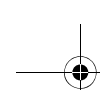

LifeBook P1600 Series Notebook

TROUBLESHOOTING TABLE

Problem	Page	Problem	Page
Audio Problems	page 52	USB Device Problems	page 53
Docking Problems	page 52	PC Card Problems	page 54
Hard Drive Problems	page 52	Power Failures	page 54
Keyboard or Mouse Problems	page 52	Shutdown and Startup Problems	page 55
Pen Input Problems	page 53	Video Problems	page 56
Memory Problems	page 53	Miscellaneous Problems	page 57
Modem Problems	page 53		

Problem	Possible Cause	Possible Solutions
Audio Problems		
There is no sound coming from the built-in speakers.	The software volume control is set too low.	Adjust the sound volume control settings in your software, operating system and applications.
	Headphones are plugged into your notebook.	Plugging in headphones disables the built-in speakers, remove the headphones.
	Software driver is not configured correctly.	Refer to your application and operating system documentation for help.
	Sound could have been muted with function keys.	Press [F3] while holding the [Fn] key to toggle the sound on and off.
Port Replicator Problems		
System does not turn on when installed in optional Port Replicator	Port Replicator AC adapter is not plugged in.	Provide power to the Port Replicator.
	LifeBook is not properly seated in the Port Replicator.	Remove and re-dock your notebook.
Hard Drive Problems		
You cannot access your hard drive.	The setup utility is incorrectly set for your internal (Primary Master) hard drive.	Revise BIOS settings to set the Primary Master correctly. See "BIOS Setup Utility" on page 32.
	The wrong drive designator was used by an application when a bootable CD-ROM was used to start the system.	Verify drive designator used by application is in use by the operating system. When the operating system is booted from a CD, drive designations are automatically adjusted.
	Security is set so your operating system cannot be started without a password.	Verify your password and security settings.
Keyboard or Mouse Problems		
The built-in keyboard does not seem to work.	The notebook has gone into Standby mode.	Push the Suspend/Resume button.
	Your application has locked out your keyboard.	Try to use your integrated pointing device to restart your system. If this fails, turn your system off by pressing the suspend/resume button for 10 seconds or more, and then turn it back on.
	The NumLock key has been toggled on.	Press the NumLock key to toggle it off.



Troubleshooting

Problem	Possible Cause	Possible Solutions
You have installed an external keyboard or mouse, and it does not seem to work.	Your external device is not properly installed.	Re-install your device. See "Device Ports" on page 47.
	Your operating system software is not set up with the correct driver for that device.	Check your device and operating system documentation and activate the proper driver.
You have connected an external keyboard or a mouse and it seems to be locking up the system.	Your operating system software is not set up with the correct driver for that device.	Check your device and operating system documentation and activate the proper driver.
	Your system has crashed.	Try to restart your system. If that fails, turn off the power by pressing the suspend/resume button for at least 10 seconds, and then power back on.
Pen Input Problems		
Cursor is not tracking the pen	The system may be uncalibrated	If the cursor on the screen appears to be misaligned with the pen or is not accurately tracking the pen, calibrate the pen. See "Calibrating the Touch Screen" on page 26.
"Ink crossword" application doesn't work properly.	System has incorrect resolution	This LifeBook model uses a lower resolution than the minimum required by the application. The Ink Crossword application (found in Tablet PC Experience Pack) cannot be used with this model.
Memory Problems		
Power On screen or Info menu of BIOS setup utility information, does not show the correct amount of installed memory.	Your memory upgrade module is not properly installed.	Turn off your system. Remove and re-install your memory upgrade module. See "Memory Upgrade Module" on page 41.
	You have a memory failure.	Check for Power On Self Test (POST) messages. See "Power On Self Test Messages" on page 58.
Modem Problems		
Messages about modem operation.	Messages about modem operation are generated by whichever modem application is in use.	See your application software documentation for additional information.
Modem does not appear to work.	Modem may not have been initialized.	Verify that the modem has been initialized by the operating system. To do so, right-click on My Computer and select the Hardware tab. Click [Device Manager] and click on the "+" symbol that appears next to Modems. Verify that your device is listed as installed.
USB Device Problems		
You have installed a USB device, but your notebook does not recognize the device, or the device does not seem to work properly.	The device is not properly installed.	Remove and re-install the device. See "Device Ports" on page 47.
	The device may have been installed while an application was running, so your system is not aware of its installation.	Close the application and restart your notebook.
	Your software may not have the correct driver active.	See your software documentation and activate the correct driver.

LifeBook P1600 Series Notebook

Problem	Possible Cause	Possible Solutions
You have installed a USB device, but your notebook does not recognize the device, or the device does not seem to work properly. (continued)	Your device and another device are assigned the same I/O address.	Check all I/O addresses located within the BIOS setup utility and any other installed hardware or software to make sure there are no duplications.
PC Card Problems		
A card inserted in the PC Card slot does not work or is locking up the system.	The card is not properly inserted.	Remove and re-insert the card. See "PC Cards" on page 43.
	The card may have been inserted while an application was running, so your notebook is not aware of its insertion.	Close the application and restart your notebook.
	Your software may not have the correct driver active.	See your software documentation and activate the correct driver.
Power Failures		
You turn on your notebook and nothing seems to happen.	The installed battery is completely discharged or there is no power adapter (AC or Auto/Airline) installed.	Check the Status Indicator Panel to determine the presence and condition of the battery. See "Status Indicators" on page 14. Install a charged battery or a Power adapter.
	The battery is installed but is faulty.	Use the Status Indicator Panel to verify the presence and condition of the battery. See "Status Indicators" on page 14. If a battery is indicating a short, remove that battery and operate from another power source or replace that battery.
	The battery is low.	Check the Status Indicator Panel to determine the presence and condition of the battery. See "Status Indicators" on page 14. Use a Power adapter until the battery is charged.
	The AC or auto/airline adapter is not plugged in properly.	Verify that your adapter is connected correctly. See "Power Sources" on page 31.
	The Power adapter (AC or auto/airline) is faulty.	Try a different Power adapter or install a charged optional second battery.
	The Power adapter (AC or auto/airline) has no power from the AC outlet, airplane seat jack, or the car's cigarette lighter.	Move the AC cord to a different outlet, check for a line switch or tripped circuit breaker for the AC outlet. If you are using an auto/airline adapter in a car make sure the ignition switch is in the On or Accessories position.
Your notebook turns off all by itself.	The power management parameters are set for auto timeouts which are too short for your operating needs.	Press any button on the keyboard, or move the mouse to restore operation. If that fails, push the Suspend/Resume button. Check your power management settings, or close your applications and go to the Power Savings menu of the setup utility to adjust the timeout values to better suit your operation needs.
	You have a battery failure.	Verify the condition of the battery using the Status Indicator panel, and replace or remove any battery that is shorted. See "Status Indicators" on page 14.

Troubleshooting

Problem	Possible Cause	Possible Solutions
Your notebook turns off all by itself. (continued)	You are operating on battery power only and have ignored a low battery alarm until the battery is at the dead battery state and your machine has gone into Dead Battery Suspend mode.	Install a power adapter and then push the Suspend/Resume button. See "Power Sources" on page 31.
	Your power adapter has failed or lost its power source.	Make sure the adapter is plugged in and the outlet has power.
Your notebook will not work on battery alone.	The battery is dead.	Replace the battery with a charged one or install a Power adapter.
	No battery is installed.	Install a charged battery.
	The battery is improperly installed.	Verify that the battery is properly connected by re-installing them.
	Your battery is faulty.	Verify the battery condition using the Status Indicator panel and replace or remove any battery that is shorted. See "Status Indicators" on page 14.
The battery seems to discharge too quickly.	You are running an application that uses a great deal of power due to frequent hard drive or CD-ROM access, or use of a modem or LAN PC card.	Use a power adapter for this application when at all possible.
	The power savings features may be disabled.	Check the power management and/or setup utility settings in the Power Savings menu and adjust according to your operating needs.
	The brightness is turned all the way up.	Turn down the brightness adjustment. The higher the brightness the more power your display uses.
	The battery is very old.	Replace the battery.
	The battery has been exposed to high temperatures.	Replace the battery.
	The battery is too hot or too cold.	Restore the system to normal operating temperature. The Charging icon on the Status Indicator panel will flash when the battery is outside its operating range.
	The AC Adapter is defective.	Replace with another AC Adapter to see if the problem persists. Replace any defective AC Adapters.
Shutdown and Startup Problems		
The Suspend/Resume button does not work.	The Suspend/Resume button is disabled from the Advanced submenu of the Power menu of the setup utility.	Enable the button from the setup utility.
	You did not hold the button in long enough.	Hold the button longer. This may need to be a few seconds if your application is preventing the CPU from checking for button pushes.
	There may be a conflict with the application software.	Close all applications and try the button again.

LifeBook P1600 Series Notebook

Problem	Possible Cause	Possible Solutions
The system powers up, and displays power-on information, but fails to load the operating system.	The boot sequence settings of the setup utility are not compatible with your configuration.	Set the operating source by pressing the [F2] key while the Fujitsu logo is on screen, entering the setup utility and adjusting the source settings from the Boot menu. See "BIOS Setup Utility" on page 32.
	You have a secured system requiring a password to load your operating system.	Make sure you have the right password. Enter the setup utility and verify the Security settings and modify them as accordingly. See "BIOS Setup Utility" on page 32.
An error message is displayed on the screen during the boot sequence.	Power On Self Test (POST) has detected a problem.	See the Power On Self Test (POST) messages to determine the meaning and severity of the problem. Not all messages are errors; some are simply status indicators. See "Power On Self Test Messages" on page 58.
Your system display won't turn on when the system is turned on or when the system has resumed.	The system may be password-protected.	Check the status indicator panel to verify that the Security icon is blinking. If it is blinking, enter your password.
Your notebook appears to change setup parameters when you start it.	BIOS setup changes were not saved when you made them and exited the BIOS setup utility returning it to previous settings.	Make sure you select Save Changes And Exit when exiting the BIOS setup utility.
	The BIOS CMOS back-up battery has failed.	Contact your support representative for repairs. This is not a user-serviceable part.
Video Problems		
The built-in display is blank when you turn on your notebook.	The angle of the display and the brightness settings are not adequate for your lighting conditions.	Move the display and the brightness control until you have adequate visibility.
	The optional Port Replicator is attached, an external monitor is plugged in, and the system is set for an external monitor only.	Pressing [F10] while holding down the [Fn] key allows you to change your selection of where to send your display video. Each time you press the combination of keys you will step to the next choice. The choices, in order are: built-in display only, external monitor only, both built-in display and external monitor.
	The power management timeouts may be set for very short intervals and you failed to notice the display come on and go off again.	Press any button the keyboard, or move the mouse to restore operation. If that fails, push the Suspend/Resume button. (The display may be shut off by Standby mode, Auto Suspend or Video Timeout)
The notebook turned on with a series of beeps and your built-in display is blank.	Power On Self Test (POST) has detected a failure which does not allow the display to operate.	Contact your support representative.
Your system display won't turn on when the system is turned on or when the system has resumed.	The system may be password-protected.	Check the status indicator panel to verify that the Security icon is blinking. If it is blinking, enter your password.
The display goes blank by itself after you have been using it.	Power management timeouts may be set for very short intervals and you failed to notice the display come on and go off.	Press any button on the keyboard, or move the mouse to restore operation. If that fails, push the Suspend/Resume button. (The display may be shut off by Standby Mode, Auto Suspend or Video Timeout)

Troubleshooting

Problem	Possible Cause	Possible Solutions
The display goes blank by itself after you have been using it. (continued)	The notebook has gone into Video Timeout, Standby Mode, or Hibernate Mode because you have not used it for a period of time.	Press a button on the keyboard, or move the mouse to restore operation. If that fails, push the Suspend/Resume button. Check your power management settings, or close your applications and go to the Power Savings menu of the setup utility to adjust the timeout values to better suit your operation needs. See "BIOS Setup Utility" on page 32.
The display does not close.	A foreign object, such as a paper clip, is stuck between the display and the keyboard.	Remove all foreign objects from the keyboard.
The display has bright or dark spots.	If the spots are very tiny and few in number, this is normal for a large LCD display.	This is normal; do nothing.
	If the spots are numerous or large enough to interfere with your operation needs.	The display needs technical diagnosis; contact your support representative.
The application display uses only a portion of your screen and is surrounded by a dark frame.	You are running an application that does not support the lower pixel resolution and display compression is enabled.	When compensation is disabled, a clearer but smaller display for applications that use lower than the system resolution will result. You can fill the screen but have less resolution by changing your compensation setting. (See the Video Features submenu, located within the Advanced menu of the BIOS. See "BIOS Setup Utility" on page 32.
You have connected an external monitor and it does not display any information.	Your BIOS setup is not set to enable your external monitor.	Try toggling the video destination by pressing [Fn] and [F10] together, or check your BIOS setup and enable your external monitor. (See the Video Features submenu, located within the Advanced Menu of the BIOS. See "BIOS Setup Utility" on page 32.
	Your external monitor is not properly installed.	Reinstall your device. See "External Video Port" on page 48.
	Your operating system software is not set up with the correct software driver for that device.	Check your device and operating system documentation and activate the proper driver.
You have connected an external monitor and it does not come on.	Your external monitor may not be compatible with your system.	See your monitor documentation and the External Monitor Support portions of the Specifications section. See "Specifications" on page 71.
Miscellaneous Problems		
An error message is displayed on the screen during the operation of an application.	Application software often has its own set of error message displays.	See your application manual and help displays screens for more information. Not all messages are errors some may simply be status.
Can't change screen orientation using Tablet and Pen Settings.	Incorrect system resolution.	This LifeBook uses a lower resolution than that required by this feature. To rotate the screen, use the Rotation button.

POWER ON SELF TEST MESSAGES

The following is an alphabetic list of error-and-status messages that Phoenix BIOS and/or your operating system can generate and an explanation of each message. Error messages are marked with an *. If an error message is displayed that is not in this list, write it down and check your operating system documentation both on screen and in the manual. If you can find no reference to the message and its meaning is not clear, contact your support representative for assistance.

nnnn Cache SRAM Passed

Where nnnn is the amount of system cache in kilobytes successfully tested by the Power On Self Test. (This can only appear if you have an SRAM PC Card installed.)

***Extended RAM Failed at offset: nnnn**

Extended memory not working or not configured properly. If you have an installed memory upgrade module, verify that the module is properly installed. If it is properly installed, you may want to check your Windows Setup to be sure it is not using unavailable memory until you can contact your support representative.

nnnn Extended RAM Passed

Where nnnn is the amount of memory in kilobytes successfully tested.

***Failing Bits: nnnn The hex number nnnn**

This is a map of the bits at the memory address (in System, Extended, or Shadow memory) which failed the memory test. Each 1 (one) in the map indicates a failed bit. This is a serious fault that may cause you to lose data if you continue. Contact your support representative.

***Fixed Disk x Failure or Fixed Disk Controller Failure (where x = 1-4)**

The fixed disk is not working or not configured properly. This may mean that the hard drive type identified in your setup utility does not agree with the type detected by the Power On Self Test. Run the setup utility to check for the hard drive type settings and correct them if necessary. If the settings are OK and the message appears when you restart the system, there may be a serious fault which might cause you to lose data if you continue. Contact your support representative.

***Invalid NVRAM media type**

Problem with NVRAM access. In the unlikely case that you see this message you may have some display problems. You can continue operating but should contact your support representative for more information.

***Keyboard controller error**

The keyboard controller test failed. You may have to replace your keyboard or keyboard controller but may be able to use an external keyboard until then. Contact your support representative.

***Keyboard error**

Keyboard not working. You may have to replace your keyboard or keyboard controller but may be able to use an external keyboard until then. Contact your support representative.

***Keyboard error nn**

BIOS discovered a stuck key and displays the scan code for the stuck key. You may have to replace your keyboard but may be able to use an external keyboard until then. Contact your support representative.

***Operating system not found**

Operating system cannot be located on either drive A: or drive C: Enter the setup utility and see if both the fixed disk, and drive A: are properly identified and that the boot sequence is set correctly. Unless you have changed your installation greatly, the operating system should be on drive C:. If the setup utility is correctly set, your hard drive may be corrupted and your system may have to be re-installed from your back up media.

***Parity Check 1 nnnn**

Parity error found in the system bus. BIOS attempts to locate the address and display it on the screen. If it cannot locate the address, it displays "????". This is a potentially data destroying failure. Contact your support representative.

***Parity Check 2 nnnn**

Parity error found in the I/O bus. BIOS attempts to locate the address and display it on the screen. If it cannot locate the address, it displays "????". This is a potentially data destroying failure. Contact your support representative.

***Press <F1> to resume, <F2> to SETUP**

Displayed after any recoverable error message. Press the [F1] key to continue the boot process or the [F2] key to enter Setup and change any settings.

***Previous boot incomplete – Default configuration used**

Previous Power On Self Test did not complete successfully. The Power On Self Test will load default values and offer to run Setup. If the previous failure was caused by incorrect values and they are not corrected, the next boot will likely fail also. If using the default settings does not allow you to complete a successful boot sequence, you should turn off the power and contact your support representative.



Troubleshooting

***Real time clock error**

Real-time clock fails BIOS test. May require board repair. Contact your support representative.

***Shadow RAM Failed at offset: nnnn**

Shadow RAM failed at offset nnnn of the 64k block at which the error was detected. You are risking data corruption if you continue. Contact your support representative.

nnnn Shadow RAM Passed

Where nnnn is the amount of shadow RAM in kilobytes successfully tested.

***System battery is dead – Replace and run SETUP**

The BIOS CMOS RAM memory hold up battery is dead. This is part of your BIOS and is a board mounted battery which requires a support representative to change. You can continue operating but you will have to use setup utility default values or reconfigure your setup utility every time you turn off your notebook.

System BIOS shadowed

System BIOS copied to shadow RAM.

***System CMOS checksum bad – run SETUP**

BIOS CMOS RAM has been corrupted or modified incorrectly, perhaps by an application program that changes data stored in BIOS memory. Run Setup and reconfigure the system.

***System RAM Failed at offset: nnnn**

System memory failed at offset nnnn of in the 64k block at which the error was detected. This means that there is a fault in your built-in memory. If you continue to operate, you risk corrupting your data. Contact your support representative for repairs.

nnnn System RAM Passed

Where nnnn is the amount of system memory in kilobytes successfully tested.

***System timer error**

The timer test failed. The main clock that operates the computer is faulty. Requires repair of system board. Contact your support representative for repairs.

UMB upper limit segment address: nnnn

Displays the address of the upper limit of Upper Memory Blocks, indicating released segments of the BIOS memory which may be reclaimed by a virtual memory manager.

Video BIOS shadowed

Video BIOS successfully copied to shadow RAM.

MODEM RESULT CODES

The operating system and application software that is factory installed detects the modem characteristics and provides the necessary command strings to operate the modem. The internal modem operation is controlled by generic AT commands from the operating system and application software. The standard long form result codes may, in some cases, be displayed on your screen to keep you informed of the actions of your modem. The operating system and application software may suppress display of the result codes.

Examples of result codes are:

- OK
- NO CARRIER
- NO DIALTONE
- CONNECT 53000 (Connection complete at 53,000 bps.)
- ERROR
- FAX
- RING (This means an incoming call.)
- BUSY
- NO ANSWER

When using the internal modem with applications that are not factory installed refer to the application documentation.



Restoring Your Pre-installed Software

The Drivers and Applications Restore (DAR) CD contains sets of device drivers and Fujitsu utilities (in specific directories) that are unique to your notebook configuration for use as documented below.



If you have access to the internet, visit the Fujitsu Support website at <http://www.computers.us.fujitsu.com/support> to check for the most current information, drivers and hints on how to perform recovery and system updates. See "Automatically Downloading Driver Updates" on page 61.

Re-Installing Individual Drivers and Applications

The Drivers and Applications CD can be used to selectively re-install drivers and/or applications that may have been un-installed or corrupted.



There may be certain free third-party applications pre-installed on your system that are not on the DAR CD. The latest versions of the applications can be downloaded from the third-party's website.

To re-install drivers and/or applications:

1. Boot up the system and insert the DAR CD after Windows has started. A Fujitsu Installer screen is displayed after the CD is inserted.
2. After reading the License Agreement, click [I agree].
3. A window will appear containing a list of applications, drivers, and utilities that you can install from the Drivers and Applications CD.



The components listed are color-coded in terms of their install status. Blue indicates that the component can be installed. Green indicates that the component needs to be installed separately. Grey indicates a component that is already installed; grey items can be reinstalled, but prior to installation you will receive a reminder that the component is already installed.

4. In the list, check off all the components you want to install. If you want to install all components, click [Select All]. Clicking [Select All] will select all of the blue-coded components; you must select grey and green components separately.

5. Once you have selected the components you wish to install, click [Install Selected Subsystems]; the components will be installed.
6. After the components are installed, click [OK], then click [Yes] when asked if you want to reboot the system.

RESTORING THE FACTORY IMAGE

The Restore Disc that came with your system contains two utilities:

- The **Recovery** utility allows you to restore the original contents of the C: drive.
- The **Hard Disk Data Delete** utility on this disc is used to delete all data on your hard disk and prevent it from being reused. Do not use the Hard Disk Data Delete utility unless you are absolutely certain that you want to erase your entire hard disk, including all partitions.



- The use of this disc requires that you have a device capable of reading CDs attached to your system. If you do not have a built-in CD player, you will need to attach an external player. For more information on available external devices, visit our website at: www.shopfujitsu.com.

- This disc can only be used with the system with which it was purchased.

BOOT Priority Change

Before restoring an image, you must first verify that your system is set up to boot from the CD drive. To verify/change the boot-up priority (rather than booting-up from the hard drive or an external floppy disk drive), perform the following steps:

1. Start your system and press the [F2] key when the Fujitsu logo appears. You will enter the BIOS Setup Utility.
2. Using the arrow keys, go to the Boot menu.
3. Arrow down to the Boot Device Priority submenu. Press [Enter].
4. If "Optical Media Drive" or "CD-ROM Drive" is not at the top of the list, arrow down to the drive in the list, and press the space bar (or the + key) to move it to the top of the list. (The system attempts to boot from the devices in the order in which they are listed.). Note that the BIOS for some systems will indicate "CD-ROM Drive", even when a DVD drive is connected.
5. If you have an *external* drive connected, proceed to step 6; otherwise, proceed to step 7.
6. If you have an external drive connected:

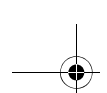

Troubleshooting

- Select the Advanced menu in the BIOS window.
 - Scroll down to the USB Features submenu and press the Enter key to open it.
 - If Legacy USB Support is disabled, press the space bar to enable it.
 - Scroll down to SCSI SubClass Support and press the space bar to enable it.
7. Press [F10], then click on [Yes] to exit the BIOS Setup Utility and return to the boot process.
- After you have changed the boot priority, you can restore a backup image when you are booting up.

Procedure

1. Turn on the power to your system.
2. Ensure that you have a device that can read CDs either installed in your system or attached externally to it.
3. Insert the Restore Disc into the drive tray.
4. Reboot your system.
5. After the system reboots, follow the instructions that appear to either restore your system image or erase all data from your hard disk.

AUTOMATICALLY DOWNLOADING DRIVER UPDATES

Your system has a convenient tool called the Fujitsu Driver Update (FDU) utility. With FDU, you can choose to automatically or manually go to the Fujitsu site to check for new updates for your system.

The FDU icon  should appear in the notification area at the bottom right of your screen (roll the cursor over the icons to find the correct one). If the FDU icon does not appear in the notification area, it can be started by going to [Start] -> All Programs, and clicking on Fujitsu Driver Update; this will create the icon automatically.

To invoke the FDU menu, right-click on the FDU icon. The menu contains the following items:

- **Check for updates now**
Allows for manual driver update search. The first time it is used, you are prompted to agree to a user agreement. After clicking on the icon, the FDU automatically connects with the Fujitsu site to check for updates and downloads them. While downloading, the icon has a red bar through it, indicating that it cannot be used while the download is in process. When the update is complete, a message appears informing you of the fact.
- **Enable Automatic Update Notifications**
Automatically searches for new updates on a regular basis (approximately every 3 days).
- **Show update history**
Brings up a screen that displays a history of updates that have been made via the FDU.
- **About Fujitsu Driver Update**
Displays the FDU version number and copyright information
- **Fujitsu Driver Update Readme**
Displays the FDU readme.

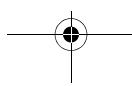
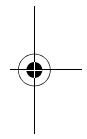
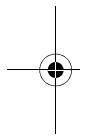

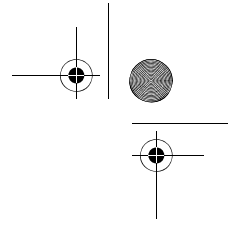
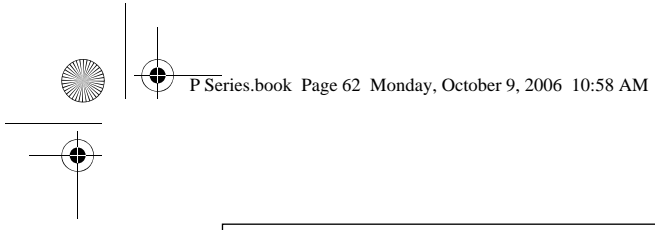

LifeBook P1600 Series Notebook

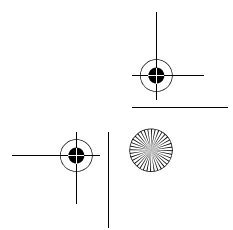
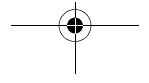
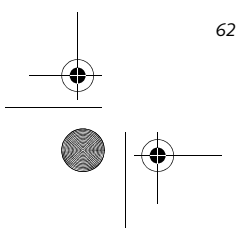
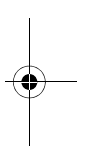
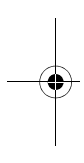

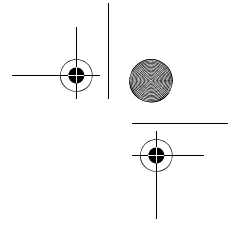
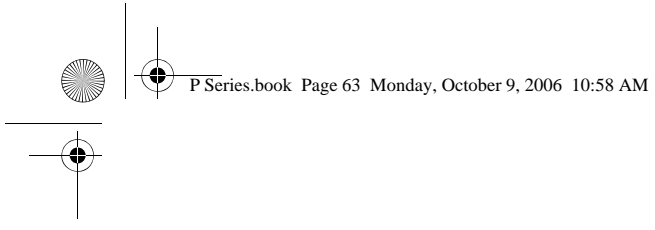

6 Care and Maintenance

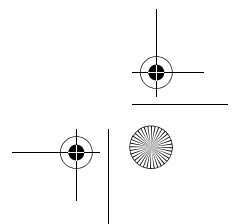
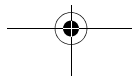
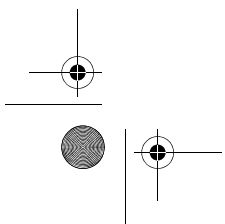
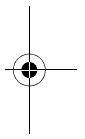
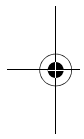

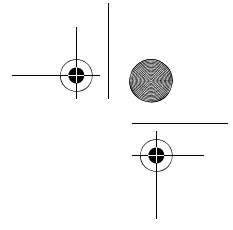
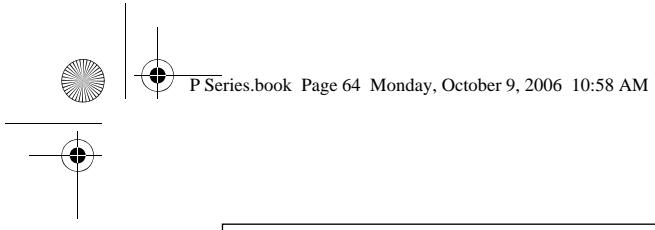

LifeBook P1600 Series Notebook

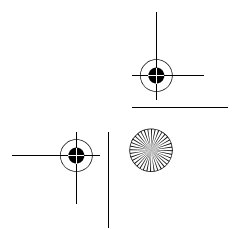
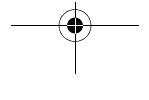
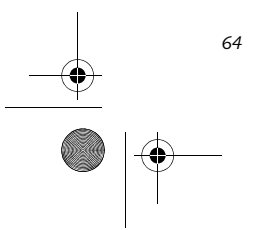
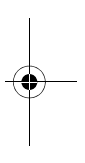
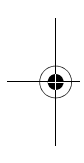

Care and Maintenance

If you use your LifeBook P1600 Series notebook carefully, you will increase its life and reliability. This section provides some tips for looking after the system and its devices.



Electrical equipment may be hazardous if misused. Operations of this product or similar products, must always be supervised by an adult. Do not allow children access to the interior of any electrical products and do not permit them to handle any cables.

LIFEBOOK P1600 SERIES NOTEBOOK Caring for your LifeBook

- Your notebook is a durable but sensitive electronic device. Treat it with care.



Do not use excessive force when tapping or writing on the screen with the stylus or your finger. Use of excessive force could result in damage to the LCD and/or Touch Screen.

- Make a habit of transporting it in a suitable carrying case.
- To protect your notebook from damage and to optimize system performance, be sure to **keep all air all vents unobstructed, clean, and clear of debris**. This may require periodic cleaning, depending upon the environment in which the system is used.
- Do not operate the system in areas where the air vents can be obstructed, such as in tight enclosures or on soft surfaces like a bed or cushion.
- Do not attempt to service the computer yourself. Any unauthorized service performed on the computer will void the warranty.
- Always follow installation instructions closely.
- Keep it away from food and beverages.
- If you accidentally spill liquid on your notebook:
 1. Turn it off.
 2. Position it so that the liquid can run out.
 3. Let it dry out for 24 hours, or longer if needed.
 4. If your system will not boot after it has dried out, call your support representative.
- Do not use your notebook in a wet environment (near a bathtub, swimming pool).
- Always use the AC adapter and batteries that are approved for your system.
- Avoid exposure to sand, dust and other environmental hazards.

- Do not expose your notebook to direct sunlight for long periods of time as temperatures above 140° F (60° C) may damage your system.
- Keep the covers closed on the connectors and slots when they are not in use.
- Do not put heavy or sharp objects on the computer.
- If you are carrying your notebook in a briefcase, or any other carrying case, make sure that there are no objects in the case pressing on the lid.
- Do not drop your notebook.
- Do not touch the screen with any sharp objects.

Cleaning your LifeBook

- Always disconnect the power plug. (Pull the plug, not the cord.)
- Clean your system with a damp, lint-free cloth. Do not use abrasives or solvents.
- Use a soft cloth to remove dust from the screen. Never use glass cleaners.

Storing your LifeBook

- If storing your notebook for a month or longer, turn the system off, fully charge the battery, then remove and store all Lithium ion batteries.
- Store your notebook and batteries separately. If you store your system with a battery installed, the battery will discharge, and battery life will be reduced. In addition, a faulty battery might damage the system.
- Store your notebook in a cool, dry location. Temperatures should remain between 13° F (-25° C) and 140° F (60° C).

Traveling with your LifeBook

- Do not transport your system while it is turned on.
- Do not check your system as baggage. Carry it with you.
- When traveling with the hard drive removed, wrap the drive in a non-conducting materials (cloth or paper). If you have the drive checked by hand, be ready to install the drive if needed. Never put your hard drive through a metal detector. Have your hard drive hand-inspected by security personnel. You can however, put your hard drive through a properly tuned X-ray machine.
- Take the necessary plug adapters if you're traveling overseas. Check the following diagram to determine which adapter you'll need or ask your travel agent.



LifeBook P1600 Series Notebook



Outlet Type	Location
	United States, Canada, Mexico, parts of Latin America, Japan, Korea, the Philippines, Taiwan
	Russia and the Commonwealth of Independent States (CIS), most of Europe, parts of Latin America, the Middle East, parts of Africa, Hong Kong, India, most of South Asia
	United Kingdom, Ireland, Malaysia, Singapore, parts of Africa
	China, Australia, New Zealand

Figure 6-1. Outlet types

KEYBOARD**Caring for your Keyboard**

The keyboard of your computer is a very sensitive instrument. It is made up of many switches that are activated when you press on the keys. The keyboard is a major component of the heat dissipation system in a notebook. Due to heat and size considerations the keyboard is not sealed. Because the keys are so close together, it is not easy for the user to see when liquids have fallen onto the circuitry below the keys.

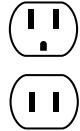
Attempting to clean the keyboard with a spray on cleaner or rag soaked with cleaner the liquid can drip onto the circuitry sight unseen. Once the liquid seeps between the layers of circuitry, it can cause corrosion or other damage to the circuits. This can result in keys which no longer operate, or which, when pressed, record the wrong characters and other similar failures.

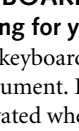
There is no repair for this problem other than replacement. The solution is to become aware of the issue and take appropriate steps to protect your keyboard.

To clean the keyboard, use a rag dampened slightly with cleaning solution. Use extreme care to prevent liquid from dripping between the keys. Spraying directly on the keys should be avoided. The spray should be applied first to the cloth, and then the cloth wiped over the keys.

BATTERIES**Caring for your Batteries**

- Always handle batteries carefully.
- Do not short-circuit the battery terminals (that is, do not touch both terminals with a metal object). Do not carry loose batteries in a pocket or purse where they

may mix with coins, keys, or other metal objects. Doing so may cause an explosion or fire.

- Do not drop, puncture, disassemble, mutilate or incinerate the battery.
- Recharge batteries only as described in this manual and only in ventilated areas.
- Do not leave batteries in hot locations for more than a day or two. Intense heat can shorten battery life.
- Do not leave a battery in storage for longer than six months without recharging it.

Increasing Battery Life

- Keep brightness to the lowest comfortable level.
- Set the power management for maximum battery life.
- Put your notebook in Standby mode when it is turned on and you are not actually using it.
- Disable the Windows CD auto insert function.
- Always use fully charged batteries.

OPTIONAL FLOPPY DISK DRIVE AND FLOPPY DISKS**Caring for your Floppy Disks**

- Avoid using floppy disks in damp and dusty locations.
- Never store a floppy disk near a magnet or magnetic field.
- Do not use a pencil or an eraser on a disk or disk label.
- Avoid storing the floppy disks in extremely hot or cold locations, or in locations subject to severe temperature changes. Store at temperatures between 50° F (10° C) and 125° F (52° C).
- Do not touch the exposed part of the disk behind the metal shutter.

Caring for your Optional Floppy Disk Drive

- To clean, wipe the floppy disk drive clean with a dry soft cloth, or with a soft cloth dampened with water or a solution of neutral detergent. Never use benzene, paint thinner or other volatile material.
- Avoid storing the floppy disk drive in extremely hot or cold locations, or in locations subject to severe temperature changes. Store at temperatures between 50° F (10° C) and 125° F (52° C).
- Keep the floppy disk drive out of direct sunlight and away from heating equipment.
- Avoid storing the floppy disk drive in locations subject to shock and vibration.
- Never use the floppy disk drive with any liquid, metal, or other foreign matter inside the drive or disk.
- Never disassemble or dismantle your floppy disk drive.



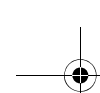

Care and Maintenance

OPTIONAL OPTICAL DRIVE AND DISCS

Caring for your discs

CDs and DVD discs are precision devices and will function reliably if given reasonable care.

- Always store your discs in their case when not in use.
- Always handle discs by the edges and avoid touching the surface.
- Avoid storing any discs in extreme temperatures.
- Do not bend discs or set heavy objects on them.
- Do not spill liquids on discs.
- Do not scratch discs.
- Do not put a label on discs.
- Do not get dust on discs.
- Never write on the label surface with a ballpoint pen or pencil. Always use a felt pen.
- If a disc is subjected to a sudden change in temperature, cold to warm condensation may form on the surface. Wipe the moisture off with a clean, soft, lint free cloth and let it dry at room temperature. DO NOT use a hair dryer or heater to dry discs.
- If a disc is dirty, use only a disc cleaner or wipe it with a clean, soft, lint free cloth starting from the inner edge and wiping to the outer edge.

Caring for your Optional Optical Drive

Your optical drive is durable but you must treat it with care. Please pay attention to the following points:

- The drive rotates the compact disk at a very high speed. Do not carry it around or subject it to shock or vibration with the power on.
- Avoid using or storing the drive where it will be exposed to extreme temperatures.
- Avoid using or storing the drive where it is damp or dusty.
- Use of a commercially-available lens cleaner kit is recommended to maintain the drive lens.
- Avoid using or storing the drive near magnets or devices that generate strong magnetic fields.
- Avoid using or storing the drive where it will be subjected to shock or vibration.
- Do not disassemble or dismantle the optical drive.

PC CARDS

Caring for your PC Cards

PC Cards are durable, but you must treat them with care. The documentation supplied with your PC Cards provides specific information for caring for the cards.

When you don't have a PC Card installed in your system, you should be sure to install the PC Card slot inserts that came with your system. These will help to keep dust and dirt out of your system.

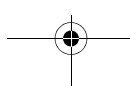
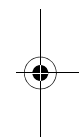
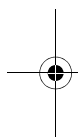

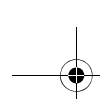

LifeBook P1600 Series Notebook

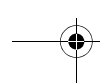
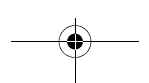
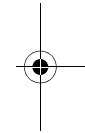
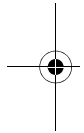

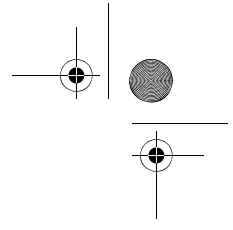
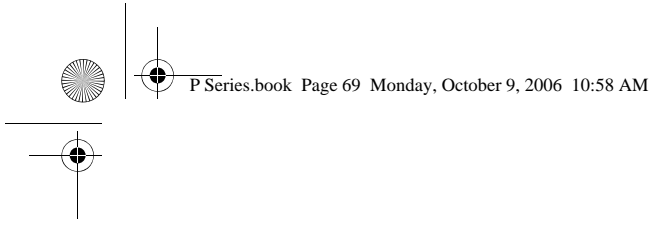

7 System Specifications

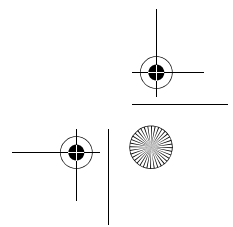
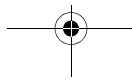
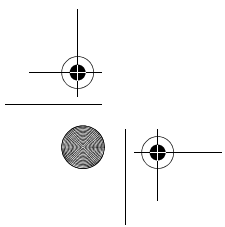
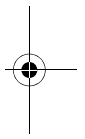
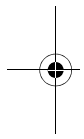

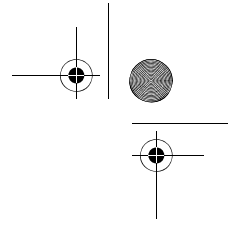
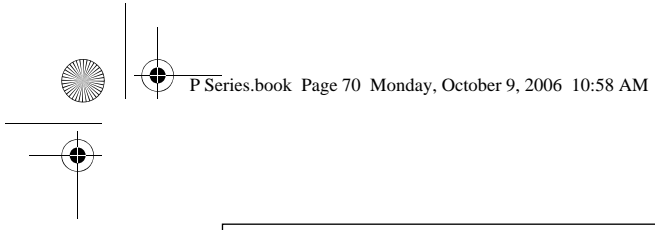

LifeBook P1600 Series Notebook

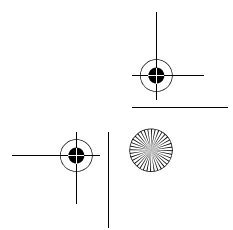
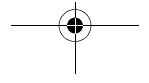
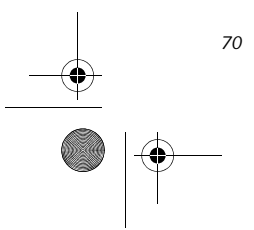
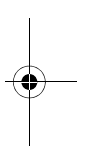
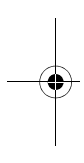

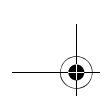

Specifications

Specifications

This section provides the hardware and environmental specifications for your LifeBook P1600 Series notebook. Specifications of particular configurations will vary.

CONFIGURATION LABEL

Your LifeBook P1600 Series notebook has a configuration label located on the bottom. (See figure 2-8 on page 13 for location). This label contains specific information regarding the options you've chosen for your notebook. Following is an example label and information on how to read your own configuration label.

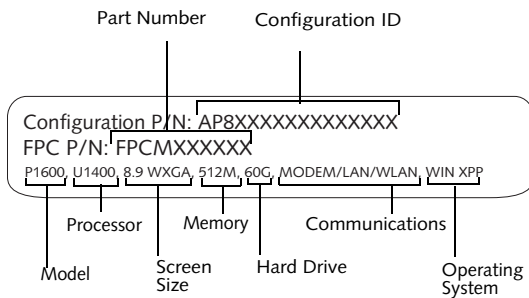
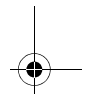
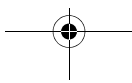
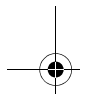
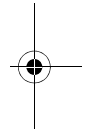
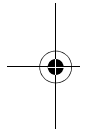

Figure 7-1. Configuration Label

LifeBook P1600 Series notebook Specifications	
The specifications for your particular model may vary. To determine the specifications for your system, please visit our website at: us.fujitsu.com/computers .	
Physical Specifications	
Dimensions	9.13" w x 6.57" d x 1.36" / 1.46" (232 mm x 167 mm x 34.5/37 mm)
Processing Specifications	
CPU/Speed	Intel® Core™ Solo Processor ULV U1400 (1.2 GHz)
Front Side Bus (FSB)	533 MHz
Chip set	945GMS
Memory/Storage Specifications	
Main RAM	<ul style="list-style-type: none"> 512 MB and 1.0 GB SDRAM modules available, with a system maximum of 1.0 GB (DDR2 533 MHz) 172-pin Micro DIMM slot
L2 cache	2 MB on-die
BIOS ROM	8 Mb (for System BIOS) plus 8 Mb (for fingerprint recognition)

LifeBook P1600 Series notebook Specifications	
Hard disk drive	<ul style="list-style-type: none"> 1.8" HDD 30 GB, 60 GB or 80 GB IDE (4200 rpm) DMA 100 Shock-mounted Shock Sensor feature SMART Support
Display Specifications	
Display	8.9" TFT WXGA (1280 x 768), 16M colors: <ul style="list-style-type: none"> Color LCD Resistive Digitizer 32-bit color External monitor support: SXGA (1280 x 1024 maximum) Dot pitch: 0.240 x 0.240 mm
VRAM	Up to 128 MB of shared memory using Unified Memory Architecture (UMA). Dynamically responds to application requirements and allocates the proper amount of memory for optimal graphics and performance.
Interface Specifications	
Integrated Interfaces	<ul style="list-style-type: none"> Modem (RJ-11) LAN (RJ-45) USB 2.0 x 2 DC-In Analog RGB, Mini D-SUB 15-pin connector for external VGA monitor Docking connector
Interfaces on Optional Port Replicator	<ul style="list-style-type: none"> DC Power LAN (RJ-45) 15-pin D-SUB connector for external VGA monitor USB 2.0 x 2 Docking Port
PC Card Slot	Dedicated slot for PCMCIA Card, Type I or II
SD Slot	Dedicated slot for SD Card
User Interface support	<ul style="list-style-type: none"> Keyboard Pitch: 19 mm, Stroke: 2 mm Quick Point pointing device with scroll button Passive digitizer with pen input On-screen keyboard



LifeBook P1600 Series Notebook

LifeBook P1600 Series notebook Specifications	
Audio	<ul style="list-style-type: none"> • Sigmatel ST9228 • Internal digital microphone • Mono speaker • Mono microphone and stereo headphone jacks • 26 adjustable audio levels
User Controls	<ul style="list-style-type: none"> • Programmable Security/Application Buttons, each with primary and secondary functions (default applications: Calculator and WordPad) as well as security functions • Trusted Platform Module (TPM) support • Suspend/Resume button
Status Indicators (LEDs)	<ul style="list-style-type: none"> • Power • Battery charging • Battery level • Hard disk drive • Caps Lock • Num Lock • Scroll Lock
Power Specifications	
Main Battery	<ul style="list-style-type: none"> • 3-cell • Removable, Lithium ion • 10.8 V @2600 mAh, max. 28 WHr • Recharge Time: Approximately 2.5 hours
Optional Battery	<ul style="list-style-type: none"> • 6-cell • Removable, Lithium ion • 10.8V @ 5200 mAh, max. 56.0 WHr • Recharge Time: Approximately 4.5 hours
AC Adapter	Autosensing 100 - 240V, supplying 16 VDC, with a minimum current of 2.5 A
Environmental Specifications	
Temperature	Operating: 41° to 95° F (5° to 35° C) Non-operating: 5° to 140° F (-15° to 60° C)

LifeBook P1600 Series notebook Specifications	
Humidity	Operating: 20 to 85% non-condensing Non-operating: 8 to 85% non-condensing
Agency Approval Specifications	
Emissions	<ul style="list-style-type: none"> • EN55022 (CISPR22) Class B • FCC 15, Class B • FCC 15C, 15.247 • ICES-003 • Canada RSS-210 • ETSI EN 300 328-1 V1.3.1: 2001 • ETSI EN 300 328-2 V1.2.1: 2001_12 • ETSI EN 301 498-17 V1.2.1: 2002 • ETSI EN 301 498-1 V1.4.1: 2002
Immunity	<ul style="list-style-type: none"> • EN55024 (1998), +A1
Safety	<ul style="list-style-type: none"> • UL and cUL Listed, UL 60950-1
Telecom	<ul style="list-style-type: none"> • FCC Part 68 • IC CS-03
Additional Specifications	
Operating Systems	<ul style="list-style-type: none"> • Microsoft® Windows® XP Pro • Microsoft Windows XP Tablet PC Edition

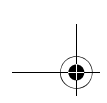

Regulatory Information



Changes or modifications not expressly approved by Fujitsu could void this user's authority to operate the equipment

FCC NOTICES

Notice to Users of Radios and Television

These limits are designed to provide reasonable protection against harmful interference in a residential installation. This equipment generates, uses, and can radiate radio frequency energy and, if not installed and used in accordance with the instructions, may cause harmful interference to radio communications. However, there is no guarantee that interference will not occur in a particular installation. If this equipment does cause harmful interference to radio or television reception, which can be determined by turning the equipment off and on, the user is encouraged to try to correct the interference by one or more of the following measures:

- Reorient or relocate the receiving antenna.
- Increase the separation between the equipment and receiver.
- Connect the equipment into an outlet that is on a different circuit than the receiver.
- Consult the dealer or an experienced radio/TV technician for help.

Shielded interconnect cables must be employed with this equipment to ensure compliance with the pertinent RF emission limits governing this device.

Notice to Users of the US Telephone Network

This equipment contains an internal modem that complies with Part 68 of the FCC rules. On the bottom of this equipment is a label that contains, among other information, the FCC registration number and ringer equivalence number (REN) for this equipment. If requested, this information must be provided to the telephone company.

This equipment is designed to be connected to the telephone network or premises wiring using a standard jack type USOC RJ11C. A plug and jack used to connect this equipment to the premises wiring and telephone network must comply with the applicable FCC Part 68 rules and requirements adopted by the ACTA. A compliant telephone cord and modular plug is provided with this product. It is designed to be connected to a compatible modular jack that is also compliant.

The ringer equivalent number (REN) of this equipment is 0.1B as shown on the label. The REN is used to determine the number of devices that may be connected to a telephone line. Excessive RENs on a telephone may result in the devices not ringing in response to an

incoming call. In most but not all areas, the sum of RENs should not exceed five (5.0). To be certain of the number of devices that may be connected to a line, as determined by the total RENs, contact the local telephone company.

If this equipment causes harm to the telephone network, the telephone company will notify you in advance that temporary discontinuance of service may be required. But if advance notice isn't practical, the telephone company will notify the customer as soon as possible. Also, you will be advised of your right to file a complaint with the FCC if you believe it is necessary.

The telephone company may make changes in its facilities, equipment, operations or procedures that could effect the operation of the equipment. If this happens the telephone company will provide advance notice in order for you to make necessary modifications to maintain uninterrupted service.

If trouble is experienced with this equipment, for repair or warranty information, please refer to the manual or contact Fujitsu Computer Systems Corporation, Customer Service. If the equipment is causing harm to the telephone network, the telephone company may request that you disconnect the equipment until the problem is resolved.

The equipment cannot be used on public coin service provided by the telephone company. Connection to party line service is subject to state tariffs. (Contact the state public utility commission, public service commission or corporation commission for information).

If your home has specially wired alarm equipment connected to the telephone line, ensure the installation of this computer does not disable your alarm equipment. If you have any questions about what will disable alarm equipment, consult your telephone company or a qualified installer.

The Telephone Consumer Protection Act of 1991 makes it unlawful for any person to use a computer or other electronic device to send any message via a telephone fax machine unless such message clearly contains in a margin at the top or bottom of each transmitted page or on the first page of the transmission, the date and time it is sent and an identification of the business or other entity, or other individual sending the message and the telephone number of the sending machine or such business, other entity, or individual.

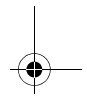
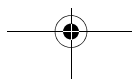
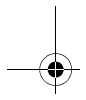
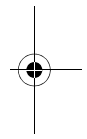
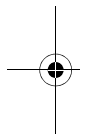

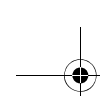

DOC (INDUSTRY CANADA) NOTICES
Notice to Users of Radios and Television

This Class B digital apparatus meets all requirements of Canadian Interference-Causing Equipment Regulations.

CET appareil numérique de la class B respecte toutes les exigences du Règlement sur le matériel brouilleur du Canada.

Notice to Users of the Canadian Telephone Network

NOTICE: This equipment meets the applicable Industry Canada Terminal Equipment Technical Specifications. This is confirmed by the registration number. The abbreviation, IC, before the registration number signifies that registration was performed based on a Declaration of Conformity indicating that Industry Canada technical specifications were met. It does not imply that Industry Canada approved the equipment.

Before connecting this equipment to a telephone line the user should ensure that it is permissible to connect this equipment to the local telecommunication facilities. The user should be aware that compliance with the certification standards does not prevent service degradation in some situations.

Repairs to telecommunication equipment should be made by a Canadian authorized maintenance facility. Any repairs or alterations not expressly approved by Fujitsu or any equipment failures may give the telecommunication company cause to request the user to disconnect the equipment from the telephone line.

NOTICE: The Ringer Equivalence Number (REN) for this terminal equipment is 0.1B. The REN assigned to each terminal equipment provides an indication of the maximum number of terminals allowed to be connected to a telephone interface. The termination on an interface may consist of any combination of devices subject only to the requirement that the sum of the Ringer Equivalence Numbers of all the devices does not exceed five.



For safety, users should ensure that the electrical ground of the power utility, the telephone lines and the metallic water pipes are connected together. Users should NOT attempt to make such connections themselves but should contact the appropriate electric inspection authority or electrician. This may be particularly important in rural areas.

Avis Aux Utilisateurs Du Réseau Téléphonique Canadien

AVIS: Le présent matériel est conforme aux spécifications techniques d'Industrie Canada applicables au matériel terminal. Cette conformité est confirmée par le numéro d'enregistrement. Le sigle IC, placé devant le numéro d'enregistrement signifie que l'enregistrement s'est effectué conformément à une déclaration de conformité et indique que les spécifications techniques d'Industrie Canada ont été respectées. Il n'implique pas qu'Industrie Canada a approuvé le matériel.

Avant de connecter cet équipement à une ligne téléphonique, l'utilisateur doit vérifier s'il est permis de connecter cet équipement aux installations de télécommunications locales. L'utilisateur est averti que même la conformité aux normes de certification ne peut dans certains cas empêcher la dégradation du service.

Les réparations de l'équipement de télécommunications doivent être effectuées par un service de maintenance agréé au Canada. Toute réparation ou modification, qui n'est pas expressément approuvée par Fujitsu, ou toute défaillance de l'équipement peut entraîner la compagnie de télécommunications à exiger que l'utilisateur déconnecte l'équipement de la ligne téléphonique.

AVIS: L'indice d'équivalence de la sonnerie (IES) du présent matériel est de 0.1B. L'IES assigné à chaque dispositif terminal indique le nombre maximal de terminaux qui peuvent être raccordés à une interface téléphonique. La terminaison d'une interface peut consister en une combinaison quelconque de dispositifs, à la seule condition que la somme d'indices d'équivalence de la sonnerie de tous les dispositifs n'excède pas 5.



Pour assurer la sécurité, les utilisateurs doivent vérifier que la prise de terre du service d'électricité, les lignes téléphoniques et les conduites d'eau métalliques sont connectées ensemble. Les utilisateurs NE doivent PAS tenter d'établir ces connexions eux-mêmes, mais doivent contacter les services d'inspection d'installations électriques appropriés ou un électricien. Ceci peut être particulièrement important en régions rurales.

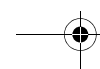
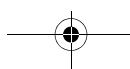

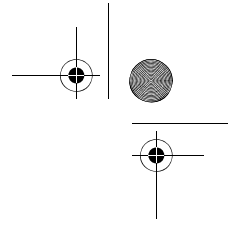
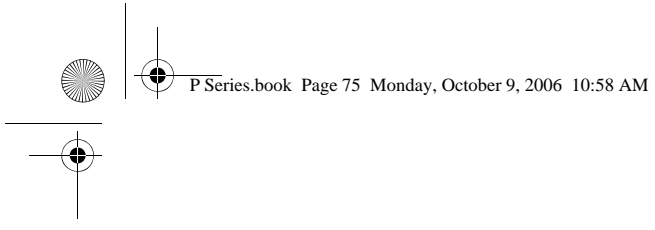

8 Glossary

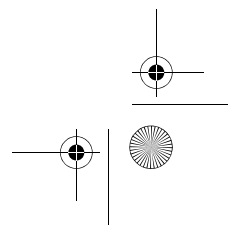
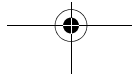
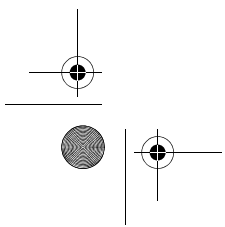
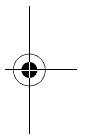
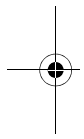

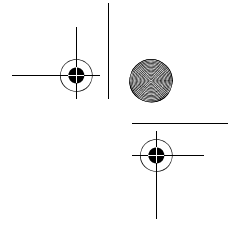
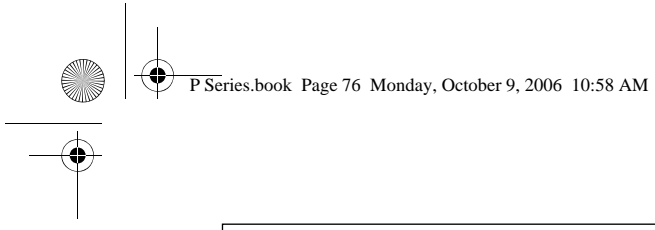

LifeBook P1600 Series Notebook

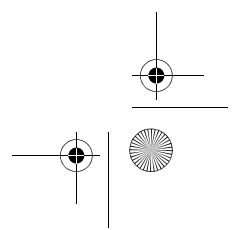
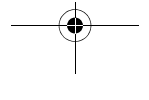
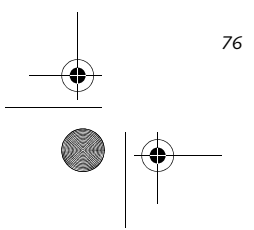
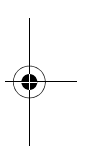
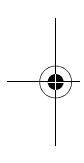

Glossary

AC Adapter

A device which converts the AC voltage from a wall outlet to the DC voltage needed to power your notebook.

ACPI

Advanced Configuration and Power Interface

Active-Matrix Display

A type of technology for making flat-panel displays which has a transistor or similar device for every pixel on the screen.

AdHoc

A designation for wireless LAN network configuration. It indicates a form of communication limited to those personal computers which have wireless LAN function. For details, refer to "Ad hoc mode" on page 86.

ADSL

Asymmetric Digital Subscriber Line
Technology for transporting high bit-rate services over ordinary phone lines.

Auto/Airline Adapter

A device which converts the DC voltage from an automobile cigarette lighter or aircraft DC power outlet to the DC voltage needed to power your notebook.

BIOS

Basic Input-Output System. A program and set of default parameters stored in ROM which tests and operates your notebook when you turn it on until it loads your installed operating system from disk. Information from the BIOS is transferred to the installed operating system to provide it with information on the configuration and status of the hardware.

Bit

An abbreviation for binary digit. A single piece of information which is either a one (1) or a zero (0).

bps

An abbreviation for bits per second. Used to describe data transfer rates.

Boot

To start-up a computer and load its operating system from disk, ROM or other storage media into RAM.

Bus

An electrical circuit which passes data between the CPU and the sub-assemblies inside your notebook.

Byte

8 bits of parallel binary information.

Cache Memory

A block of memory built into the micro-processor which is much faster to access than your system RAM and used in specially structured ways to make your overall data handling time faster.

CardBus

A faster, 32-bit version of the PC Card interface which offers performance similar to the 32-bit PCI architecture.

CD-ROM

Compact disk read only memory. This is a form of digital data storage which is read optically with a laser rather than a magnetic head. A typical CD-ROM can contain about 600MB of data and is not subject to heads crashing into the surface and destroying the data when there is a failure nor to wear from reading.

Channel

The frequency band of wireless LAN to be used in communications over wireless LAN or at the access point.

CMOS RAM

Complementary metal oxide semiconductor random access memory. This is a technology for manufacturing random access memory which requires very low levels of power to operate.

Command

An instruction which you give your operating system. Example: run a particular application or format a floppy disk.

Configuration

The combination of hardware and software that makes up your system and how it is allocated for use.

CRT

Cathode Ray Tube. A display device which uses a beam of electronic particles striking a luminescent screen. It produces a visual image by varying the position and intensity of the beam.

Data

The information a system stores and processes.

DC

Direct current. A voltage or current that does not fluctuate periodically with time.

Default Value

A pre programmed value to be used if you fail to set your own.

DHCP

Dynamic Host Configuration Protocol

A protocol used for automatically fetching communication parameters such as IP addresses. The side which assigns IP address is called DHCP server and the side that is assigned it is called DHCP client.

DIMM

Dual-in-line memory module.

Disk

A spinning platter of magnetic data storage media. If the platter is very stiff it is a hard drive, if it is highly flexible it is a floppy disk, if it is a floppy disk in a hard housing with a shutter it is commonly called a diskette.

Disk Drive

The hardware which spins the disk and has the heads and control circuitry for reading and writing the data on the disk.

Diskette

A floppy disk in a hard housing with a shutter.

DMA

Direct Memory Access

Special circuitry for memory to memory transfers of data which do not require CPU action.

DMI

Desktop Management Interface

A standard that provides PC management applications with a common method of locally or remotely querying and configuring PC computer systems, hardware and software components, and peripherals.

DNS

Domain Name System

A function that controls the correspondence of IP addresses assigned to a computer with the name. Even for those computers whose IP addresses are unknown, if their names are known, it is possible to communicate with them.

DOS

Disk Operating System (MS-DOS is a Microsoft Disk Operating System).

Driver

A computer program which converts application and operating system commands to external devices into the exact form required by a specific brand and model of device in order to produce the desired results from that particular equipment.

ECP

Extended Capability Port. A set of standards for high speed data communication and interconnection between electronic devices.

Encryption Key (Network Key)

Key information used to encode data for data transfer.

This device uses the same encryption key to encode and decode the data, and the identical encryption key is required between the sender and receiver.

ESD

Electro-Static Discharge. The sudden discharge of electricity from a static charge which has built-up slowly. Example: the shock you get from a doorknob on a dry day or the sparks you get from brushing hair on a dry day.

Extended Memory

All memory more than the 640KB recognized by MS-DOS as system memory.

FCC

Federal Communication Commission.

Floppy Disk

A spinning platter of magnetic data storage media which is highly flexible.

GB

Gigabyte.

Hard drive

A spinning platter of magnetic data storage media where the platter is very stiff.

I/O

Input/Output. Data entering and leaving your notebook in electronic form.

I/O Port

The connector and associated control circuits for data entering and leaving your notebook in electronic form.

IDE

Intelligent Drive Electronics. A type of control interface for a hard drive which is inside the hard drive unit.

IEEE 1394

Industry standard that allows you to connect between your notebook and a peripheral device such as a digital camera. Also known as "Firewire" or "iLINK".

IEEE802.11a

One of the wireless LAN standards prescribed by the 802 committee in charge of establishing standards of LAN technology in IEEE (Institute of Electrical and Electronic Engineers). This standard allows communications at the

Glossary

maximum speed of 54 Mbps by using a 5 GHz band which can freely be used without radio communication license.

IEEE802.11b

One of the wireless LAN standards prescribed by 802 committee in charge of establishing standards of LAN technology in IEEE (Institute of Electrical and Electronic Engineers). It allows communications at the maximum speed of 11 Mbps by a band of 2.4 GHz (ISM band) which can freely be used without radio communication license.

IEEE802.11g

One of the wireless LAN standards prescribed by 802 committee in charge of establishing standards of LAN technology in IEEE (Institute of Electrical and Electronic Engineers). It allows communications at the maximum speed of 54 Mbps by a band of 2.4 GHz (ISM band) which can freely be used without radio communication license.

Infrared

Light just beyond the red portion of the visible light spectrum which is invisible to humans.

Infrastructure

A designation of Wireless LAN network configurations. It indicates a form of communication using an Access Point.

IP Address

An address used for computers to communicate in the TCP/IP environment.

Current IPv4 (version 4) uses four values in the range between 1 and 255. (Example: 192.168.100.123).

There are two types of IP address: global address and private address.

The global address is an only address in the world. It is controlled by JPNIC (Japan Network Information Center). A private address is an only address in the closed network.

IR

An abbreviation for infrared.

IrDA

Infrared Data Association. An organization which produces standards for communication using infrared as the carrier.

IRQ

Interrupt Request

An acronym for the hardware signal to the CPU that an external event has occurred which needs to be processed.

KB

Kilobyte.

LAN

Local Area Network

An interconnection of computers and peripherals within a single limited geographic location which can pass programs and data amongst themselves.

LCD

Liquid Crystal Display

A type of display which makes images by controlling the orientation of crystals in a crystalline liquid.

Lithium ion Battery

A type of rechargeable battery which has a high power-time life for its size and is not subject to the memory effect as Nickel Cadmium batteries.

LPT Port

Line Printer Port. A way of referring to parallel interface ports because historically line printers were the first and latter the most common device connected to parallel ports.

MAC Address

Media Access Control Address

A unique physical address of a network card. For Ethernet, the first three bytes are used as the vendor code, controlled and assigned by IEEE. The remaining three bytes are controlled by each vendor (preventing overlap), therefore, every Ethernet card is given a unique physical address in the world, being assigned with a different address from other cards. For Ethernet, frames are sent and received based on this address.

MB

Megabyte.

Megahertz

1,000,000 cycles per second.

Memory

A repository for data and applications which is readily accessible to your notebook's CPU.

MHz

Megahertz.

MIDI

Musical Instrument Digital Interface. A standard communication protocol for exchange of information between computers and sound producers such as synthesizers.

Modem

A contraction for MOdulator-DEModulator. The equipment which connects a computer or other data terminal to a communication line.

Monaural

A system using one channel to process sound from all sources.

MPU-401

A standard for MIDI interfaces and connectors.

MTU

Maximum Transmission Unit

The maximum data size that can be transferred at a time through the Internet or other networks. You can set a smaller MTU size to obtain successful communication, if you have difficulty transferring data due to the fact that the maximum size is too large.

Network authentication

The method of authentication performed by wireless LAN clients to connect with the access point. There are two types: open system authentication and shared key authentication. The type of authentication must be set to each client and also coincide with the setting of access point with which to communicate. Network authentication is sometimes called authentication mode.

Network key

Data that is used for encrypting data in data communication. The personal computer uses the same network key both for data encryption and decryption, therefore, it is necessary to set the same network key as the other side of communication.

Network name (SSID: Security Set Identifier)

When a wireless LAN network is configured, grouping is performed to avoid interference or data theft. This grouping is performed with "Network name (SSID)". In order to improve security, the network key is set allowing no communication unless "Network name (SSID)" coincides with the network key.

NTSC

National TV Standards Commission. The standard for TV broadcast and reception for the USA.

Open system authentication

One of network authentication types for wireless LAN. Since there is no check of network key upon authentication, clients can connect to the access point without submitting correct network keys. However, in case of actual communications, the same network key must be set. Open system authentication is sometimes called Open key authentication.

Operating System

A group of control programs that convert application commands, including driver programs, into the exact form required by a specific brand and model of micro-processor in order to produce the desired results from that particular equipment.

Partition

A block of space on a hard drive which is set aside and made to appear to the operating system as if it were a separate disk, and addressed by the operating system accordingly.

PCMCIA

PCMCIA is a trademark of the Personal Computer Memory Card International Association. The Personal Computer Memory Card International Association is an organization that sets standards for add-in cards for personal computers.

Peripheral Device

A piece of equipment which performs a specific function associated with but not integral to a computer. Examples: a printer, a modem, a CD-ROM.

Pitch (keyboard)

The distance between the centers of the letter keys of a keyboard.

Pixel

The smallest element of a display, a dot of color on your display screen. The more pixels per area the clearer your image will appear.

POST

Power On Self Test. A program which is part of the BIOS which checks the configuration and operating condition of your hardware whenever power is applied to your notebook. Status and error messages may be displayed before the operating system is loaded. If the self test detects failures that are so serious that operation can not continue, the operating system will not be loaded.

PPPoE

Point to Point Protocol over Ethernet.

A protocol for Ethernet, using a Point-to-Point Protocol (PPP), which is used for connection on the phone line.

Program

An integrated set of coded commands to your computers telling your hardware what to do and how and when to do it.

Protocol

Procedures and rules use to send and receive data between computers.

- Method of sending and receiving data
- Process used to handle communication errors

Glossary

Conditions required for communication are organized in procedures for correct transfer of information.

RAM

Random Access Memory. A hardware component of your notebook that holds binary information (both program and data) as long as it has the proper power applied to it.

RAM Module

A printed circuit card with memory and associated circuitry which allows the user to add additional memory to the computer without special tools.

Reset

The act of reloading the operating system. A reset erases all information stored in RAM.

Restart

See Reset.

Resume

To proceed after interruption. In your notebook this refers to returning to active operation after having been in one of the suspension states.

ROM

Read Only Memory. A form of memory in which information is stored by physically altering the material. Data stored in this way can not be changed by your notebook and does not require power to maintain it.

SDRAM

Synchronous Dynamic Random Access Memory.

Serial Port

A connection to another device through which data is transferred one bit at a time on a single wire with any other wires only for control of the device not for transfer of data.

Shared key authentication

One of the network authentication types for wireless LAN. Upon authentication, the access point checks whether the same network key is set to the client. If the client uses a wrong network key or the network key itself is not set, authentication is unsuccessful, allowing no communications with the access point.

SMART

Self-Monitoring, Analysis and Reporting Technology (SMART) is an emerging technology that provides near-term failure predictions for hard drives. When SMART is enabled the hard drive monitors pre-determined drive attributes that are susceptible to degradation over time. If a failure is likely to occur, SMART makes a status report available so that the notebook can prompt the user to back up the data on the drive. Naturally not all failures are predictable. SMART predictability is limited to those attributes which the drive can self-monitor. In

those cases where SMART can give advance warning, a considerable amount of precious data can be saved.

SRAM

Static random access memory. A specific technology of making RAM which does not require periodic data refreshing.

SSID

Service Set Identifier

Specifies which network you are joining. Some systems allow you to specify any SSID as an option so you can join any network.

Standby

To make inoperative for a period of time. Your notebook uses various suspension states to reduce power consumption and prolong the charge of your battery.

Status Indicator

A display which reports the condition of some portion of your hardware. On your notebook this is an LCD screen just above the keyboard.

Stereo (audio)

A system using two channels to process sound from two different sources.

Subnet mask

TCP-IP network is controlled by being divided into multiple smaller networks (subnets). IP address consists of the subnet address and the address of each computer. Subnet mask defines how many bits of IP address comprise the subnet address. The same value shall be set among computers communicating with each other.

SVGA

Super VGA.

S-Video

Super Video. A component video system for driving a TV or computer monitor.

System Clock

An oscillator of fixed precise frequency which synchronizes the operation of the system and is counted to provide time of day and date.

TCP/IP

Transmission Control Protocol/Internet Protocol. A standard Internet protocol that is most widely used.

TFT

Thin Film Transistor – A technology for flat display panels which uses a thin film matrix of transistors to control each pixel of the display screen individually.

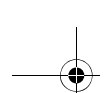

UL

Underwriters Laboratories – An independent organization that tests and certifies the electrical safety of devices.

USB

Universal Serial Bus.

Standard that allows you to simultaneously connect up to 127 USB devices such as game pads, pointing devices, printers, and keyboards to your computer.

VGA

Video Graphics Array. A video display standard originally introduced by IBM with the PS/2 series of personal computers.

VRAM

Video Random Access Memory. A memory dedicated to video display data and control.

Wi-Fi Compatible

Wi-Fi (Wireless Fidelity) Identifies that the product has passed the interoperability test, supplied by the WECA (Wireless Ethernet Compatibility Alliance), which guarantees the interoperability of wireless IEEE 802.11 LAN products. For more information on the Wi-Fi standard, go to the WECA website at: www.wirelessethernet.com.

WLAN

Wireless Local Area Network. A wireless interconnection of computers and peripherals within a single limited geographic location which can pass programs and data amongst themselves.

Write Protect

Prevent alteration of the binary state of all bits in a storage media. Example: all information on a device such as a floppy diskette; a block of space in a storage media such as a partition of a hard drive; a file or directory of floppy diskette or hard drive.

XGA

Extended VGA.

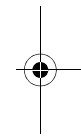
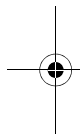

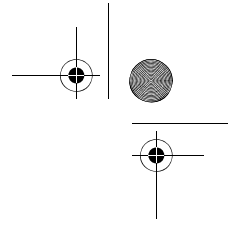
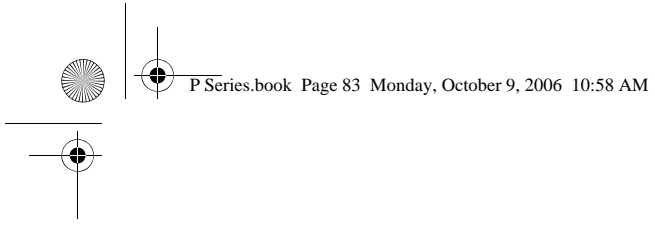

Appendix A

Integrated Wireless LAN* User's Guide

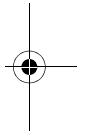
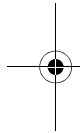

***Optional Device**

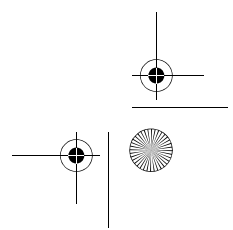
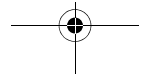
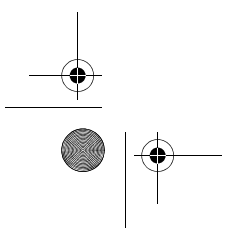

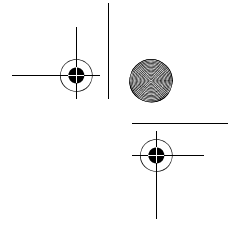
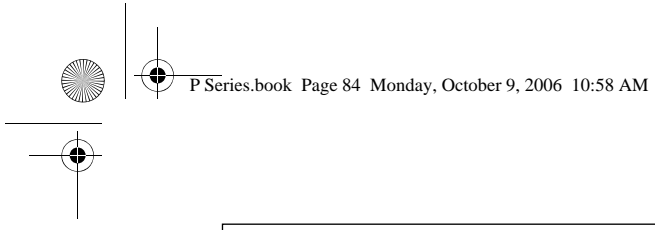

LifeBook P1600 Series Notebook

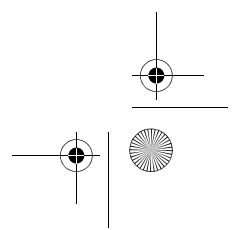
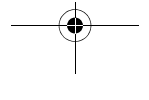
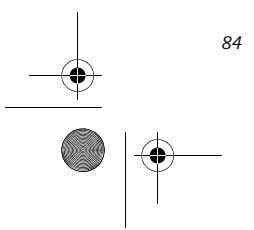
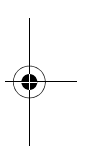
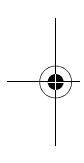

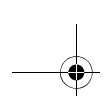

FC FCC REGULATORY INFORMATION

Please note the following regulatory information related to the wireless LAN device.

Regulatory Notes and Statements

Wireless LAN, Health and Authorization for use

Radio frequency electromagnetic energy is emitted from Wireless LAN devices. The energy levels of these emissions, however, are far much less than the electromagnetic energy emissions from wireless devices such as mobile phones. Wireless LAN devices are safe for use by consumers because they operate within the guidelines found in radio frequency safety standards and recommendations. The use of Wireless LAN devices may be restricted in some situations or environments, such as:

- On board an airplane, or
- In an explosive environment, or
- In situations where the interference risk to other devices or services is perceived or identified as harmful.

In cases in which the policy regarding use of Wireless LAN devices in specific environments is not clear (e.g., airports, hospitals, chemical/oil/gas industrial plants, private buildings), obtain authorization to use these devices prior to operating the equipment.

Regulatory Information/Disclaimers

Installation and use of this Wireless LAN device must be in strict accordance with the instructions included in the user documentation provided with the product. Any changes or modifications made to this device that are not expressly approved by the manufacturer may void the user's authority to operate the equipment. The manufacturer is not responsible for any radio or television interference caused by unauthorized modification of this device, or the substitution or attachment of connecting cables and equipment other than those specified by the manufacturer. It is the responsibility of the user to correct any interference caused by such unauthorized modification, substitution or attachment. The manufacturer and its authorized resellers or distributors will assume no liability for any damage or violation of government regulations arising from failure to comply with these guidelines.

This device must not be co-located or operating in conjunction with any other antenna or transmitter.

For operation within 5.15~5.25 GHz frequency range, the device is restricted to indoor environments, and the antenna of this device must be integral.

Federal Communications Commission statement

This device complies with Part 15 of FCC Rules.

Operation is subject to the following two conditions: (1) This device may not cause interference, and, (2) This device must accept any interference, including interference that may cause undesired operation of this device.

FCC Interference Statement

This equipment has been tested and found to comply with the limits for a Class B digital device, pursuant to Part 15 of the FCC Rules. These limits are designed to provide reasonable protection against harmful interference in a residential installation. This equipment generates, uses, and can radiate radio frequency energy. If not installed and used in accordance with the instructions, it may cause harmful interference to radio communications. However, there is no guarantee that interference will not occur in a particular installation.

If this equipment does cause harmful interference to radio or television reception, which can be determined by turning the equipment off and on, the user is encouraged to try and correct the interference by one or more of the following measures:

1. Reorient or relocate the receiving antenna.
2. Increase the distance between the equipment and the receiver.
3. Connect the equipment to an outlet on a circuit different from the one the receiver is connected to.
4. Consult the dealer or an experienced radio/TV technician for help.

FCC Radio Frequency Exposure statement

The available scientific evidence does not show that any health problems are associated with using low power wireless devices. There is no proof, however, that these low power wireless devices are absolutely safe. Low power wireless devices emit low levels of radio frequency energy (RF) in the microwave range while being used. Whereas high levels of RF can produce health effects (by heating tissue), exposure to low-level RF that does not produce heating effects causes no known adverse health effects. Many studies of low-level RF exposure have not found any biological effects. Some studies have suggested that some biological effects might occur, but such findings have not been confirmed by additional research. The wireless LAN radio device has been tested and found to comply with FCC radiation exposure limits set forth for an uncontrolled equipment and meets the FCC radio frequency (RF) Exposure Guidelines in Supplement C to OET65.

The maximum SAR value measured from the devices are:

- Intel PROSet Wireless LAN (WM3945ABG): 1.42 W/kg
- Intel PROSet Wireless LAN (WM3945ABG) + Bluetooth Simultaneous: 1.42 W/kg
- Atheros Wireless LAN (AR5XB6): 1.57 W/kg
- Atheros Wireless LAN (AR5XB6) + Bluetooth Simultaneous: 1.55 W/kg

Export restrictions

This product or software contains encryption code which may not be exported or transferred from the US or Canada without an approved US Department of Commerce export license. This device complies with Part 15 of FCC Rules, as well as ICES 003 B / NMB 003 B. Operation is subject to the following two conditions: (1) this device may not cause harmful interference, and (2) this device must accept any interference received, including interference that may cause undesirable operation. Modifications not expressly authorized by Fujitsu Computer Systems Corporation may invalidate the user's right to operate this equipment.

Canadian Notice

The device for the 5150-5250 MHz band is only for indoor usage to reduce the potential for harmful interference to co-channel mobile satellite systems.

The maximum antenna gain of 6 dBi permitted (for devices in the 5250-5350 MHz, 5470-5725 MHz, and 5725-5825 MHz bands) to comply with the e.i.r.p. limit as stated in A9.2 of RSS210.

In addition, users are cautioned to take note that high power radars are allocated as primary users (meaning they have priority) of 5250-5350 MHz and 5650-5850 MHz bands and these radars could cause interference and/or damage to LE-LAN devices.

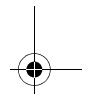
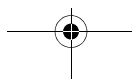
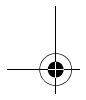
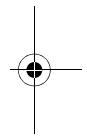
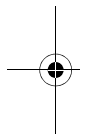

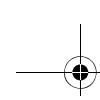

Before Using the Wireless LAN

This manual describes the procedures required to properly setup and configure the integrated Wireless LAN Mini-PCI device (referred to as "WLAN device" in the rest of the manual). Before using the WLAN device, read this manual carefully to ensure it's correct operation. Keep this manual in a safe place for future reference.

Wireless LAN Devices Covered by this Document

This document is applicable to systems containing one of the following two devices. Most of the procedures are identical. Sections that differ between the three devices have been noted in the text:

- Intel PRO/Wireless 3945ABG Network Connections (WM3945ABG) Network Connections
- Atheros AR5006EXS Mini-Card wireless network card (AR5BXB6)

Characteristics of the WLAN Device

- The WLAN device is a Mini-PCI card attached to the main board of the mobile computer.
- The WLAN devices operate in license-free RF bands, eliminating the need to procure an FCC license to operate. Both WLAN devices operate in the 2.4GHz Industrial, Scientific, and Medical (ISM) RF band and the lower and middle bands of the 5GHz Unlicensed National Information Infrastructure (UNII) bands.
- The Intel PRO/Wireless 2915ABG and Atheros AR5002X WLAN devices are capable of three operating modes: IEEE 802.11a, IEEE 802.11b and IEEE 802.11g.

- Encoding of data is modulated using Direct Sequence Spread Spectrum (DSSS) and Complementary Code Keying (CCK) when the WLAN device is operating in IEEE 802.11b mode and Orthogonal Frequency Division Multiplexing (OFDM) when operating in IEEE 802.11a or IEEE 802.11g mode.
- The WLAN device is Wi-Fi certified and operates at the maximum data transfer rate of 54 Mbps in IEEE 802.11a or IEEE 802.11g mode and 11 Mbps in IEEE 802.11b mode.
- The WLAN device supports the following encryption methods - WEP, CKIP, TKIP, and AES encryption.

WIRELESS LAN MODES USING THIS DEVICE

Ad Hoc Mode

(See Figure A-1)

"Ad Hoc Mode" refers to a wireless network architecture where wireless network connectivity between multiple computers is established without a central wireless network device, typically known as Access Point(s). Connectivity is accomplished using only client devices in a peer-to-peer fashion. That is why Ad Hoc networks are also known as peer-to-peer networks. Ad Hoc networks are an easy and inexpensive method for establishing network connectivity between multiple computers.

Ad Hoc mode requires that the SSID, network authentication, and encryption key settings are identically configured on all computers in the Ad Hoc network.

Figure A-1. Ad Hoc Mode Network

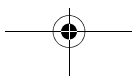
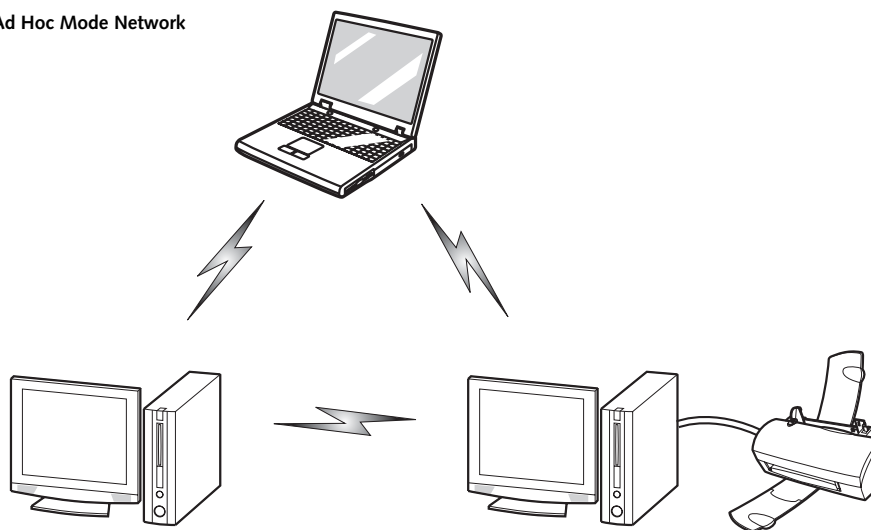

Access Point (Infrastructure) Mode*(See Figure A-2)*

Infrastructure mode refers to a wireless network architecture in which devices communicate with wireless or wired network devices by communicating through an Access Point. In infrastructure mode, wireless devices can communicate with each other or can communicate with a wired network. Corporate wireless networks operate in infrastructure mode because they require access to the wired LAN in order to access computers, devices, and services such as file servers, printers, and databases.

How to Handle This Device

The WLAN device comes pre-installed in your mobile computer. Under normal circumstances, it should not be necessary for you to remove or re-install it. The Operating System that your mobile computer comes with has been pre-configured to support the WLAN device.

WIRELESS NETWORK CONSIDERATIONS

- The WLAN devices support IEEE 802.11a, IEEE 802.11b and IEEE 802.11g.
- The WLAN devices operate in the 2.4GHz ISM band and the 5 GHz lower, middle, and upper UNII bands.

- Microwave ovens will interfere with the operation of WLAN device as microwave ovens operate in the same 2.4GHz frequency range that IEEE 802.11b/g devices operate in. Interference by microwaves does not occur with IEEE 802.11a radio which operates in the 5 GHz RF band.
- Wireless devices that transmit in the 2.4GHz frequency range may interfere with the operation of WLAN devices in IEEE 802.11b/g modes. Symptoms of interference include reduced throughput, intermittent disconnects, and large amounts of frame errors. It is **HIGHLY** recommended that these interfering devices be powered off to ensure the proper operation of the WLAN device.

DEACTIVATING THE WLAN DEVICE

Deactivation of the WLAN device may be desired in certain circumstances (to extend battery life) or where certain environments require it (i.e. hospitals, clinics, airplanes, etc.). Fujitsu mobile computers employ two methods with which to deactivate the WLAN device:

- Using the Wireless On/Off Switch
- In Windows, using the Intel PROSet Software or Atheros Client Utility software.

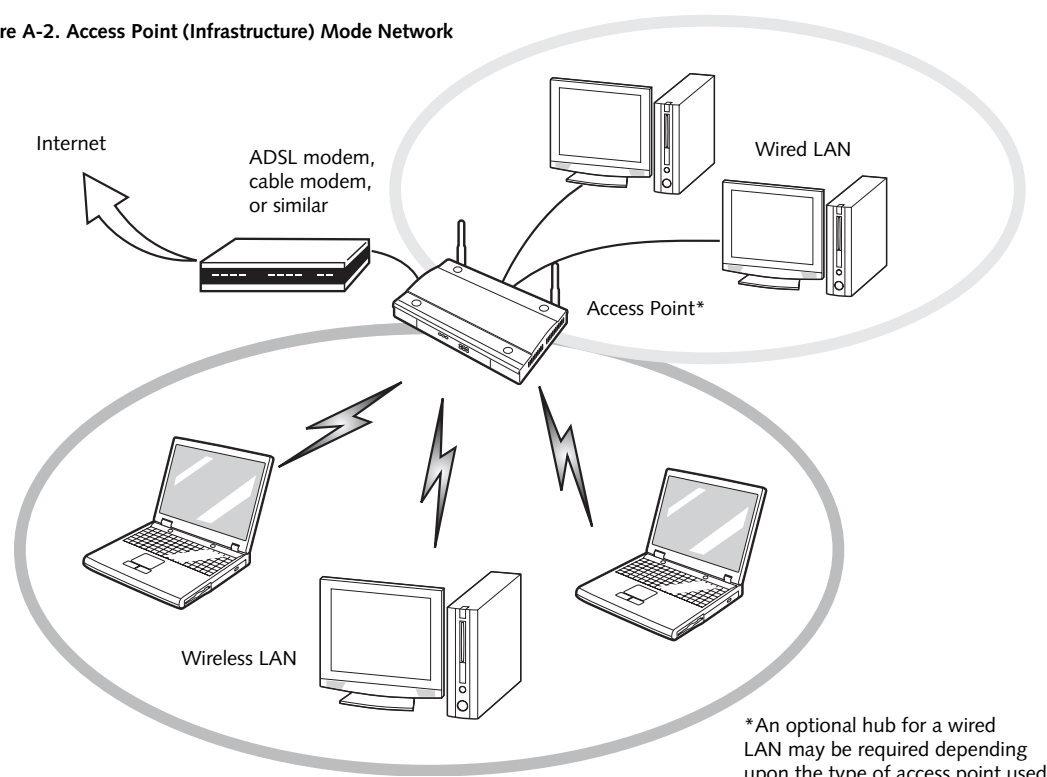
Figure A-2. Access Point (Infrastructure) Mode Network

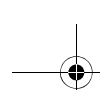

Deactivation using the Wireless On/Off Switch

The WLAN device can be deactivated quickly and efficiently by toggling the Wireless On/Off Switch to the Off position. (Figure A-3)

The Wireless On/Off switch has no effect on non-Wireless LAN models.

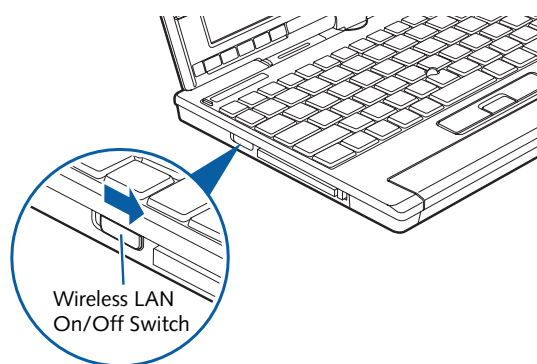

Figure A-3. Wireless LAN On/Off Switch Location

Deactivation using the Intel PROSet Software

The WLAN device can also be deactivated in Windows using the Intel PROSet Software. The procedure to accomplish this:

1. Click [Start]-> [All Programs].
2. Select Intel ProSet Wireless, then click on Intel ProSet Wireless from the menu that appears. The Intel ProSet Wireless utility will be displayed.
3. At the bottom left corner of the window, select Wireless Off from the dropdown list.

Deactivation using Atheros Client Utility software

1. Right-click on Atheros Client Utility icon in the system tray. Select "Open Atheros Client Utility" from the menu.
2. Choose Action and click Disable Radio.

ACTIVATING THE WLAN DEVICE

Activation of the WLAN device can be accomplished using the same methods as the deactivation process

- Using the Wireless On/Off Switch
- In Windows using the Intel PROSet Software or Atheros Software

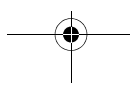
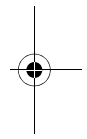
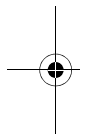



Configuration of the WLAN Device

The WLAN Device can be configured to establish wireless network connectivity using one of the following tools:

- Intel PROSet Software - The Intel PROSet Software allows for multiple profile setup and supports automatic profile switching. Support for most industry standard security solutions is contained in this software.
- Atheros Client Utility - The Atheros Client Utility software allows for multiple profile setups and supports automatic profile switching. Support for most industry standard security solutions is contained in this software.

FLOW OF OPERATIONS

1. Activate the WLAN Device (See Activating the WLAN Device on page 88 for more information).
2. Configure the Wireless Network parameters.
 - Enter the network name (SSID)
 - Choose the appropriate WLAN architecture (Ad Hoc or Infrastructure)
 - Choose Authentication method: Open, Shared, WPA-Enterprise, WPA2-Enterprise, WPA-Personal, or WPA2-Personal
 - If using static WEP keys, enter static WEP key and choose key index.
3. Configure network settings (See Configure Network Parameters on page 89 for more information)
 - TCP/IP settings
 - Workgroup or Domain settings.

CONFIGURATION USING INTEL PROSET SOFTWARE

This section explains the procedure to properly configure the WLAN device using the Intel PROSet Software. Pre-defined parameters will be required for this procedure. Please consult with your network administrator for these parameters:

Network Name - Also known as the SSID

Network Key (WEP) - Required if using static WEP keys.

Authentication Type - Open, Shared, WPA, or WPA-PSK

Procedure

1. Activate the WLAN device using either the Wireless On/Off Switch or the Intel PROSet software.
2. Click the [Start] button first and then [All Programs].
3. Click the icon [Intel PROSet Wireless] to execute the Intel PROSet Wireless software.
4. Click the [Add] button. The General Settings dialog displays.
5. Enter a profile name in the Profile Name field.
6. Enter the network SSID, in the Network Name (SSID) field.
7. Click Infrastructure or Ad Hoc for the operating mode.
8. Click [Advanced].
9. The Mandatory Access Point option is only used if Infrastructure mode is selected. Use this option to connect to a specific access point. Enter the MAC address for the access point. Click OK to save the setting and return to the General Settings page.
10. Click [Next].
11. If you are using Cisco CCX, click Cisco Options to enable Cisco CKIP data encryption on the Security Settings page. Check the Cisco Compatible Extensions Options. If you have checked the Cisco's "Mixed-Cell" box in the Advanced Setting, this option must also be checked.
12. Click [OK].
13. Click Next.
14. Select Open, Shared, WPA-Enterprise, WPA2-Enterprise, WPA-Personal, or WPA2-Personal in the Network Authentication options.
15. Select either None, WEP, CKIP (if Enable Cisco Client eXtensions is enabled, use CKIP or WEP), or TKIP for the data encryption.
16. If WEP is selected, select either 64 or 128-bit for the Encryption Level.
17. Select the key index 1, 2, 3 or 4.
18. Enter the WEP key if required. If your network does not employ a 802.1x/EAP security mechanism, please skip to step 24.

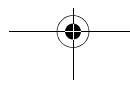
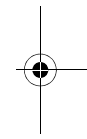
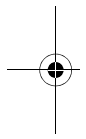

19. Click the Enable 802.1x checkbox to enable the 802.1x security option. Please contact your network administrator if configuration of this setting is required.
20. Select the appropriate Authentication Type. Please contact your network administrator if configuration of this setting is required.
21. After selecting your authentication type, enter the user name, domain, and password of the user you have created on the authentication server. The user name and password do not have to be the same as name and password of your current Windows user login.
22. Click [OK] to save the settings.
23. From the Intel ProSet Wireless page, click the new profile name shown in the Profile List. Use the up and down arrows to position the priority of the new profile in the priority list.
24. Click the Connect button to connect to the network.
25. Click [Close] if you want to close the Intel(R) PROSet for Wireless window.

CONFIGURATION USING ATHEROS CLIENT UTILITY SOFTWARE

This section explains the procedure to properly configure the WLAN device using the Atheros Client Utility. Pre-defined parameters will be required for this procedure. Please consult with your network administrator for these parameters:

Network Name - Also known as the SSID

Network Key (WEP) - Required if using static WEP keys.

Authentication Type - Open, Shared, WPA, or WPA-PSK

Procedure

1. Activate the WLAN device using either the Wireless On/Off Switch or the Atheros Client Utility
2. Right-click on the "Atheros Client Utility" icon in the system tray, and select "Open Atheros Client Utility" from the menu.
3. From the Current Status page, click the Profile Management tab.
4. If this is your first time using this utility, highlight the profile [Default] and Click the [Modify] button, otherwise Click the [New] button. The General Settings dialog displays.

5. From the General page, enter a profile name in the Profile Name field.
6. Enter the network SSID, in the SSID1 field. If you wish to create a profile that can connect to up to 3 different wireless networks, SSID's can be entered in the SSID2 and SSID3 fields as well.
7. Click the Security tab.
8. The Security tab allows for the configuration of the Security modes listed in the table below. Please select the radio button of the desired security mode. If these settings are not known to you, please consult with your network administrator for the correct settings.

Field Name	Description
WPA	Enables the use of Wi-Fi Protected Access. Choosing WPA opens the WPA EAP drop-down menu. Options include TLS and PEAP. If these settings are not known to you, please consult with your network administrator for the correct settings.
WPA-PSK	Enables WPA-Pre-Shared Key. Click on the Configure button to enter the WPA Passphrase. If these settings are not known to you, please consult with your network administrator for the correct settings.
802.1x	Enables 802.1x security. If these settings are not known to you, please consult with your network administrator for the correct settings. Choosing this option opens the 802.1x EAP type drop-down menu. Options include TLS, PEAP, and LEAP
Pre-Shared Key	Enables the use of pre-shared keys that are defined on both the access point and the station. This is where static WEP keys are entered. Click the Configure button to fill in the Define Pre-Shared Keys window.
None	No security

9. Click OK
10. Click the Advanced tab
11. The Advanced tab allows for the configuration of the options detailed in the table below

Field Name	Description
Power Save Mode	Options are Maximum, Normal, or Off
Network Type	Options are AP (Infrastructure) or Ad Hoc
802.11b Preamble	Specifies the preamble setting in 802.11b. The default setting is Short and Long (Access Point mode), which allows both short and long headers in the 802.11b frames. Set to Long Only to override allowing short frames.
Transmit Power Level	Options are selectable, depending upon whether 802.11b/g or 802.11a is used.
Wireless Mode	Specifies 5 GHz 54 Mbps, 2.4 GHz 11 Mbps, or 2.4 GHz 54 Mbps operation in an access point network.
Wireless Mode when Starting Ad Hoc Network	Specifies 5GHz 54 Mbps, 2.4 GHz 11 Mbps, or 2.4 GHz 54 Mbps to start an Ad Hoc network if no matching network name is found after scanning all available modes.

12. Click OK
13. If the profile you just created does not activate immediately, click the Profile Management tab, highlight the desired Profile, and click Activate.
14. Click [Close] if you want to close the Atheros Client Utility.

CONNECTION TO THE NETWORK

This section explains connection to the network.

If there is an administrator of the network, contact the network administrator for data settings.

Setting the network

Perform the "Setting TCP/IP" and "Confirming the computer and work group names" operations required for network connection.

Setting TCP/IP



To change the setting of the IP address, you need to be logged in from Windows as an administrator.

1. Click the [Start] button first and then [Control Panel].
2. If the Control Panel is in Category view, switch to Classic view by clicking "Switch to Classic View"

under Control Panel the left frame. (If you are already in Classic view, "Switch to Category View" will be displayed.)

3. Double-click [Network Connections]. A list of currently installed networks will be displayed.
4. Right-click [Wireless Network Connection] in the list, and then click [Properties] in the menu displayed. The [Wireless Network Connection Properties] window will be displayed.
5. Click the [General] tab if it is not already selected.
6. Click [Internet Protocol (TCP/IP)] and then click [Properties]. The [Internet Protocol (TCP/IP) Properties] window will be displayed.
7. Set the IP address as follows:
 - **For ad hoc connection:** Select [Use the following IP address:] and then enter data for [IP address] and [Subnet mask]. See page 98 for IP address setting.
 - **For access point (infrastructure) connection:** If your network uses DHCP, select [Obtain an IP address automatically] and [Obtain DNS server address automatically]. If your network uses static IP addresses, consult with your network administrator for the correct IP address settings.
8. Click the [OK] button. Processing will return to the [Wireless Network Connection Properties] window.
9. Click the [OK] button.
10. Close the [Network Connection] window.

Following this operation, confirm the names of the computer and the workgroup as follows.

Confirming the computer and work group names



To modify the computer name and/or the work group name, you need to be logged in from Windows as an administrator.

1. Click the [Start] button, then [Control Panel].
2. If the Control Panel is in Category view, switch to Classic view by clicking "Switch to Classic View" under Control Panel the left frame. (If you are already in Classic view, "Switch to Category View" will be displayed.)
3. Double-click the [System] icon. The [System Properties] window will be displayed.
4. Click the [Computer Name] tab.

LifeBook P1600 Series Notebook

5. Confirm the settings of [Full computer name:] and [Workgroup:].

a. The setting of [Full computer name:] denotes the name for identifying the computer. Any name can be assigned for each personal computer.



To change the name, click [Change] and then proceed in accordance with the instruction messages displayed on the screen.

Enter the desired name in less than 15 ASCII character code format. Identifiability can be enhanced by entering the model number, the user name, and other factors.

b. [Workgroup name] is the group name of the network. Enter the desired name in less than 15 ASCII character code format.

For ad hoc connection: Assign the same network name to all personal computers existing on the network.

For access point (infrastructure) connection: Assign the name of the work group to be accessed.

6. Click the [OK] button. If a message is displayed that requests you to restart the personal computer, click [Yes] to restart the computer.

Setting the sharing function

Set the sharing function to make file and/or printer sharing with other network-connected personal computers valid.

This operation is not required unless the sharing function is to be used.

The folder and printer for which the sharing function has been set will be usable from any personal computer present on the network.



To share a file and/or the connected printer, you need to be logged in as an administrator.

Setting the Microsoft network-sharing service

1. Click the [Start] button first and then [Control Panel].
2. If the Control Panel is in Category view, switch to Classic view by clicking "Switch to Classic View" under Control Panel the left frame. (If you are already in Classic view, "Switch to Category View" will be displayed.)

3. Double-click [Network Connections]. A list of currently installed networks will be displayed.

4. Right-click [Wireless Network Connection] in the list, and then click [Properties] in the menu displayed. The [Wireless Network Connection Properties] window will be displayed.

5. If [File and Printer Sharing for Microsoft Networks] is displayed, proceed to step 6. If [File and Printer Sharing for Microsoft Networks] is not displayed, skip to step 7.

6. Make sure that the [File and Printer Sharing for Microsoft Networks] check box is checked, and then click the [OK] button. Skip to "Setting file-sharing function".

7. Click [Install]. The [Select Network Component Type] window will be displayed.

8. Click [Service], then click the [Add] button. The [Select Network Service] window will be displayed.

9. Click [File and Printer Sharing for Microsoft Networks] and then click the [OK] button. Processing will return to the [Wireless Network Connection Properties] window, and [File and Printer Sharing for Microsoft Networks] will be added to the list.

10. Click the [Close] button.

Setting the file-sharing function

The procedure for setting the file-sharing function follows, with the "work" folder in drive C: as an example.

1. Click the [Start] button first and then [My Computer].
2. Double-click [Local disk (C:)].
3. Right-click the "work" folder (or whichever folder you want to share), and then click [Sharing and Security...] in the menu displayed. The [Folder Name Properties] window will be displayed.



Setting the file-sharing function for the file which has been used to execute Network Setup Wizard is suggested on the screen. For the wireless LAN, however, since security is guaranteed by entry of the network name (SSID) and the network key, the steps to be taken to set the file-sharing function easily without using Network Setup Wizard are given below.

4. Click [Sharing] if it isn't already selected.

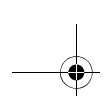

5. Click the link stating "If you understand the security risks, but want to share files without running the wizard, click here".
6. Click "Just enable file sharing" and click [OK].
7. Check the [Share this folder on the network] check box.



To specify the corresponding folder as a read-only folder, select the [Read only] checkbox under the General tab.

8. Click the [OK] button. The folder will be set as a sharable folder, and the display of the icon for the "work." folder will change.

Setting the printer-sharing function

1. Click the [Start] button first and then [Printers and FAX]. A list of connected printers will be displayed.
2. Right-click the printer for which the sharing function is to be set, and then click [Sharing] in the menu displayed. The property window corresponding to the selected printer will be displayed.



Setting the printer-sharing function when Network Setup Wizard has been executed is suggested on the screen. For the wireless LAN, however, since security is guaranteed by entry of the network name (SSID) and the network key, the steps to be taken to set the printer-sharing function without using Network Setup Wizard are laid down below.

3. Click the [Sharing] tab.
4. Click [Share this printer].
5. Enter the sharing printer name in [Share name].
6. Click the [OK] button.

Confirming connection

After you have finished the network setup operations, access the folder whose sharing has been set for other personal computers. Also, confirm the status of the radio waves in case of trouble such as a network connection failure.



In the case of access point (infrastructure) connection, enter the necessary data for the access point before confirming connection. Refer to the manual of the access point for the access point setup procedure.

Connecting your personal computer to another personal computer

1. Click [Start] first and then [My Computer]. The [My Computer] window will be displayed in the left frame.
2. Click [My Network Places] in the "Other Places" list. The window [My Network Places] will be displayed.
3. Click [View workgroup computers] under Network Tasks in the left frame.
4. Double-click the personal computer to which your personal computer is to be connected. The folder that was specified in "Setting the file-sharing function" on page 92 will be displayed.
5. Double-click the folder to be accessed.

Confirming the status of the radio

1. Right-click the Intel PRO Wireless icon in the lower right corner of the screen.
2. Click [Open Intel PROSet for Wireless]. The Intel PROSet for Wireless window opens.
3. Contained within the General tab and the Details section (accessed by pressing the [Details] button), you will find the current operating status of the radio. (When the radio is turned off or the computer is not yet connected, some of the conditions will not be displayed.)

- **Profile Name**
The current configuration profile is displayed.
- **Network Name (SSID)**
Displays the Network Name (SSID) currently used by the radio.
- **IP Address**
The IP address of the current profile.
- **Signal Quality**
Displays a message stating the current quality of the signal.
- **Signal Strength**
Displays a graphic representation of the current signal strength.

Additionally, in the lower section of the display, you will see a variety of different measurements related to the WLAN. For additional information about the items, click on the "Help?" button:

- Adapter MAC Address
- Band
- Supported Data Rates

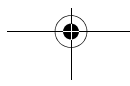

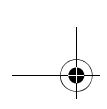

LifeBook P1600 Series Notebook

- Radio Frequency
- Channel Number
- Network Authentication
- Data Encryption
- 802.1x Authentication Type
- 802.1x Authentication Protocol
- CCX Version
- CCX TPC
- CCX Power Levels
- Access Point MAC Address
- Mandatory Access Point

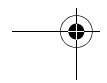
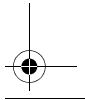
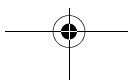
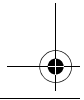
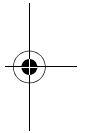
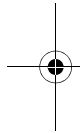

Troubleshooting the WLAN

TROUBLESHOOTING

Causes and countermeasures for troubles you may encounter while using your wireless LAN are described in the following table.

Problem	Possible Cause	Possible Solution
Unavailable network connection	Incorrect network name (SSID) or network key	<p>Ad hoc connection: verify that the network names (SSID's) and network keys (WEP) of all computers to be connected have been configured correctly. SSID's and WEP key values must be identical on each machine.</p> <p>Access Point (Infrastructure) connection: set the network name (SSID) and network key to the same values as those of the access point.</p> <p>Set the Network Authentication value identically to that of the Access Point. Please consult your network administrator for this value, if necessary.</p>
	Weak received signal strength and/or link quality	<p>Ad hoc connection: Retry connection after shortening the distance to the destination computer or removing any obstacles for better sight.</p> <p>Access Point (Infrastructure) connection: Retry connection after shortening the distance to the access point or removing any obstacles for better sight.</p> <p>To check the wave condition, refer to the following page: "Confirming the status of the radio waves" on page 93.</p>
	The WLAN device has been deactivated or disabled	Check if the wireless switch is turned ON. Also verify "Disable Radio" is not checked in "Network setting" window. Refer to "Activating the Wireless LAN" on page 88.
	The computer to be connected is turned off	Check if the computer to be connected is turned ON.
	RF interference from Access Points or other wireless networks	The use of identical or overlapping RF channels can cause interference with the operation of the WLAN device. Change the channel of your Access Point to a channel that does not overlap with the interfering device.
	Wireless network authentication has failed	Re-check your Network Authentication, Encryption, and Security settings. Incorrectly configured security settings such as an incorrectly typed WEP key, a misconfigured LEAP username, or an incorrectly chosen authentication method will cause the LAN device to associate but not authenticate to the wireless network.
	Incorrectly configured network settings	<p>Recheck the configuration of your network settings.</p> <p>For the method of checking, refer to the following page: "Connection to the Network" on page 91.</p>
	Incorrect IP address configuration	This only applies to networks using static IP addresses. Please contact your network administrator for the correct settings.

Wireless LAN Glossary

GLOSSARY

Access point

Wireless network device used to bridge wireless and wired network traffic.

Ad Hoc Mode

Ad Hoc Mode refers to a wireless network architecture where wireless network connectivity between multiple computers is established without a central wireless network device, typically known as Access Points. Connectivity is accomplished using only client devices in a peer-to-peer fashion. For details, refer to "Ad hoc connection" on page 86.

CCX (Cisco Compatible Extensions)

Implementation that provides improved wireless data security, ensuring certified compatibility with Cisco wireless access points.

Channel

Range of narrow-band frequencies used by the WLAN device to transmit data. IEEE 802.11b/g - 11 channels, 22 MHz wide channels.

DHCP (Dynamic Host Configuration Protocol)

A protocol that provides a means to dynamically allocate IP addresses to computers on a local area network.

DNS (Domain Name System)

A data query service that provides a mechanism with which to translate host names into Internet addresses.

EAP

Extensible Authentication Protocol

A protocol implementation that provides a framework to allow easier user authentication.

IEEE 802.11a

Wireless LAN standard that supports a maximum data rate of 54 Mbps. 802.11a devices operate in the 5 GHz lower and middle UNII bands.

IEEE 802.11b

Wireless LAN standard that supports a maximum data rate of 11 Mbps. 802.11b devices operate in the 2.4 GHz ISM band.

IP address

The logical 32-bit host address defined by the Internet Protocol that uniquely identifies a computer on a network. The IP address is usually expressed in dotted decimal notation.

LAN (Local Area Network)

A LAN or Local Area Network is a computer network (or data communications network) which is confined to a limited geographical area.

MAC address (Media Access Control Address)

A MAC address (also called an Ethernet address or IEEE MAC address) is the 48-bit address (typically written as twelve hexadecimal digits, 0 through 9 and A through F, or as six hexadecimal numbers separated by periods or colons, e.g., 0080002012ef, 0:80:0:2:20:ef) which uniquely identifies a computer that has an Ethernet interface.

MTU (Maximum Transmission Unit)

The maximum size of data which can be transmitted at one time in networks including the Internet. In an environment whose maximum size of data is too large to correctly receive data, normal communications can be restored by setting the size of MTU to a smaller value.

Network key

Data that is used for encrypting data in data communication. The personal computer uses the same network key both for data encryption and decryption, therefore, it is necessary to set the same network key as the other side of communication.

Network name (SSID: Security Set Identifier)

When a wireless LAN network is configured, grouping is performed to avoid interference or data theft. This grouping is performed with "Network name (SSID)". In order to improve security, the network key is set allowing no communication unless "Network name (SSID)" coincides with the network key.

Open system authentication

Null authentication method specified in the 802.11 standard that performs no authentication checks on a wireless client before allowing it to associate.

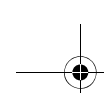

PEAP (Protected Extensible Authentication Protocol)

An improvement over EAP, making authentication much easier to achieve.

PPPoE (Point to Point Protocol over Ethernet)

A method of allowing the authentication protocol adopted in telephone line connection (PPP) to be used over an Ethernet.

Protocol

A procedure or rule of delivering data among computers. Ordered data communication is allowed by making all conditions required for communication including the method of data transmission/reception and actions upon communication errors into procedures.

Shared key authentication

802.11 network authentication method in which the AP sends the client device a challenge text packet that the client must then encrypt with the correct WEP key and return to the AP. If the client has the wrong key or no key, authentication will fail and the client will not be allowed to associate with the AP. Shared key authentication is not considered secure, because a hacker who detects both the clear-text challenge and the same challenge encrypted with a WEP key can decipher the WEP key.

SSID (Service Set Identifier)

Service Set Identifier, a 32-character unique identifier attached to the header of packets sent over a WLAN that acts as a password when a mobile device tries to connect to the BSS. The SSID differentiates one WLAN from another, so all access points and all devices attempting to connect to a specific WLAN must use the same SSID. A device will not be permitted to join the BSS unless it can provide the unique SSID. Because the SSID is broadcast in plain text, it does not supply any security to the network.

Subnet mask

TCP-IP network is controlled by being divided into multiple smaller networks (subnets). IP address consists of the subnet address and the address of each computer. Subnet mask defines how many bits of IP address comprise the subnet address. The same value shall be set among computers communicating with each other.

TCP/IP (Transmission Control Protocol/Internet Protocol)

A standard protocol of the Internet.

TKIP (Temporal Key Integrity Protocol)

Security feature that is a WEP enhancement to defend against known wireless data security issues.

WEP (Wired Equivalent Privacy)

Standard wireless security provided by the Wi-Fi standard, used for protecting wireless data.

Wi-Fi

Wi-Fi, or Wireless Fidelity, is a set of standards for wireless local area networks (WLAN) based on the IEEE 802.11 specifications. Certified products can use the official Wi-Fi logo, which indicates that the product is interoperable with any other product also showing that logo.

WPA (Wi-Fi Protected Access)

Strong replacement for WEP, providing improved data encryption and user authentication.



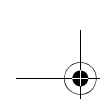

IP address information

ABOUT IP ADDRESSES



IP addressing is much more complicated than can be briefly explained in this document. You are advised to consult with your network administrator for additional information.

If IP address is unknown, set IP address as follows:

If you have an access point (DHCP server) on the network, set the IP address as follows:

[Obtain an IP address automatically]



A DHCP server is a server that automatically assigns IP addresses to computers or other devices in the network. There is no DHCP server for the AdHoc network.

If the IP address is already assigned to the computer in the network, ask the network administrator to check the IP address to be set for the computer.

If no access point is found in the network:

An IP address is expressed with four values in the range between 1 and 255.

Set the each computer as follows: The value in parentheses is a subnet mask.

<Example>

Computer A: 192.168.100.2 (255.255.255.0)

Computer B: 192.168.100.3 (255.255.255.0)

Computer C: 192.168.100.4 (255.255.255.0)

:

:

Computer X: 192.168.100.254 (255.255.255.0)

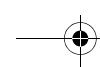
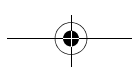
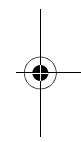
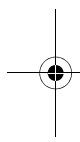

Specifications

Item	Specification
Type of network	The Atheros AR5006X (AR5XB6) and the Intel PRO/Wireless 3945ABG (WM3945ABG) Network Connections WLAN devices conform to IEEE 802.11a and 802.11b/g (Wi-Fi based)*.
Transfer rate	(Automatic switching) IEEE 802.11a/g: 54 Mbps maximum data rate IEEE 802.11b: 11 Mbps maximum data rate
Active frequency	802.11b/g: 2400~2473 MHz 802.11a: 5050 ~ 5850 MHz
Number of channels	802.11a: 8 independent channels 802.11b/g: 11 channels, 3 non-overlapping channels
Typical operating distances**	802.11a: 40 ft. (12 m) @ 54 Mbps; 300 ft. (91 m) @ 6 Mbps 802.11b: 100 ft. (30 m) @ 11 Mbps; 300 ft. (91 m) @ 1 Mbps 802.11g: 100 ft. (30 m) @ 54 Mbps; 300 ft. (91 m) @ 1 Mbps
Security	Encryption Types - WEP, TKIP, AES*** WPA 1.0 compliant Encryption key lengths supported: 64 bits, 128 bits, and 152 bits (Atheros module using AES encryption only) 802.1x/EAP
Maximum recommended number of computers to be connected over wireless LAN (during ad hoc connection)	10 units or less ****

* "Wi-Fi based" indicates that the interconnectivity test of the organization which guarantees the interconnectivity of wireless LAN (Wi-Fi Alliance) has been passed.

** The communication ranges shown above will increase or decrease depending on factors such as number of walls, reflective material, or interference from external RF sources.

*** Encryption with network key (WEP) is performed using the above number of bits, however, users can set 40 bits/104 bits after subtracting the fixed length of 24 bits.

**** Depending on practical environments, the allowable number of computers to be connected may be decreased.

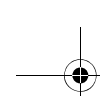

Using the Bluetooth Device

The Integrated Bluetooth module (EYTF3CSFT) is an optional device available for Fujitsu mobile computers.

WHAT IS BLUETOOTH

Bluetooth technology is designed as a short-range wireless link between mobile devices, such as laptop computers, phones, printers, and cameras. Bluetooth technology is used to create Personal Area Networks (PANs) between devices in short-range of each other.

WHERE TO FIND INFORMATION ABOUT BLUETOOTH

The Bluetooth module contains a robust Help user's guide to assist you in learning about operation of the Bluetooth device.

To access the Help file, click [Start] -> All Programs, and click on Toshiba. Select Bluetooth, then select User's Guide.

For additional information about Bluetooth Technology, visit the Bluetooth website at: www.bluetooth.com.

Canadian Notice

To prevent radio interference to the licensed service, this device is intended to be operated indoors and away from windows to provide maximum shielding. Equipment (or its transmit antenna) that is installed outdoors is subject to licensing.

Warranty

Users are not authorized to modify this product. Any modifications invalidate the warranty.

This equipment may not be modified, altered, or changed in any way without signed written permission from Fujitsu. Unauthorized modification will void the equipment authorization from the FCC and Industry Canada and the warranty.

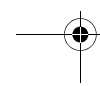
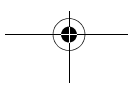
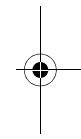
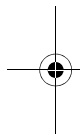

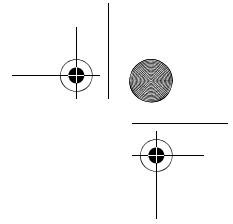
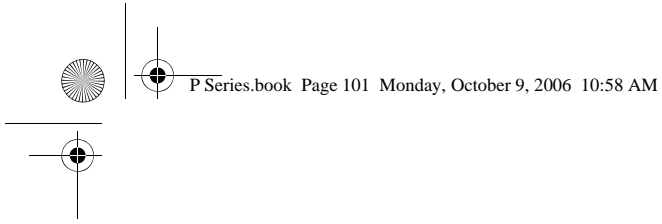

Appendix B

Using the Fingerprint Swipe Sensor

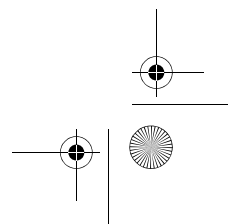
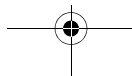
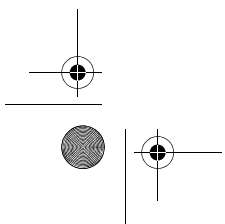
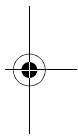
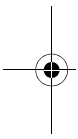

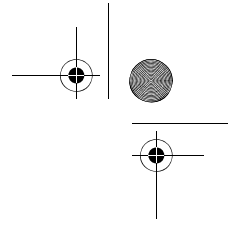
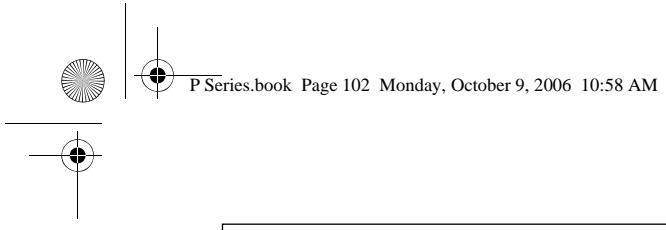

LifeBook P1600 Series Notebook

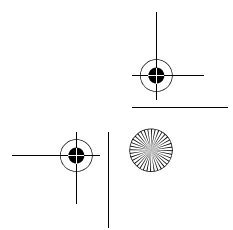
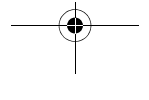
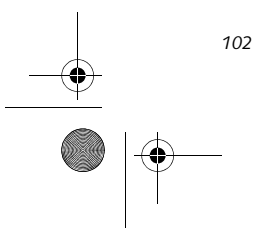
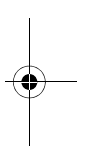
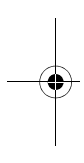

Fingerprint Sensor Device

INTRODUCING THE FINGERPRINT SENSOR DEVICE

Your system has a fingerprint sensor device in the location shown in the figure below.

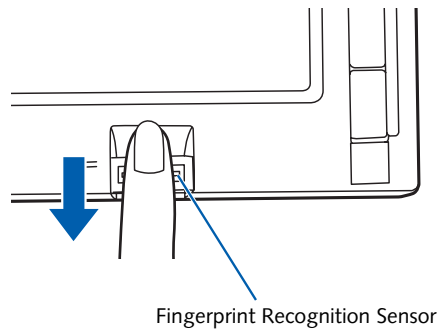

Figure B-1 Fingerprint sensor

With a fingerprint sensor, you can avoid having to enter a username and password every time you want to:

- Log onto Windows
- Recover from suspend mode
- Cancel a password-protected screen saver
- Log into homepages that require a username and password

After you have “enrolled” - or registered - your fingerprint, you can simply swipe your fingertip over the sensor for the system recognize you.

The fingerprint sensor uses Softex OmniPass which provides password management capabilities to Microsoft Windows operating systems. OmniPass enables you to use a “master password” for all Windows, applications, and on-line passwords.

OmniPass requires users to authenticate themselves using the fingerprint sensor before granting access to the Windows desktop. This device results in a secure authentication system for restricting access to your computer, applications, websites, and other password-protected resources.

OmniPass presents a convenient graphical user interface, through which you can securely manage passwords, users, and multiple identities for each user.

GETTING STARTED

This section guides you through the preparation of your system for the OmniPass fingerprint recognition application. You will be led through the OmniPass installation process. You will also be led through the procedure of enrolling your first user into OmniPass.

INSTALLING OMNIPASS

If OmniPass has already been installed on your system, skip this section and go directly to “User Enrollment” on page 104. You can determine whether OmniPass has already been installed by checking to see if the following are present:

- The presence of the gold key-shaped OmniPass icon in the system tray at the bottom right of the screen.
- The presence of the Softex program group in the Programs group of the Start menu

System Requirements

The OmniPass application requires space on your hard drive; it also requires specific Operating Systems (SO's). The minimum requirements are as follows:

- Windows XP Home Edition, Windows XP Professional or Windows 2000 operating system
- At least 35 MB available hard disk space

Installing the OmniPass Application

If OmniPass is already installed on your system, go to “User Enrollment” on page 104. Otherwise continue with this section on software installation.



For installation, OmniPass requires that the user installing OmniPass have administrative privileges to the system. If your current user does not have administrative privileges, log out and then log in with an administrator user before proceeding with OmniPass installation.

To install OmniPass on your system you must:

1. Insert the installation media for the OmniPass application into the appropriate drive. If you are installing from CD-ROM or DVD-ROM, you must find and launch the OmniPass installation program (setup.exe) from the media.
2. Follow the directions provided in the OmniPass installation program. Specify a location to which you would like OmniPass installed. It is recommended that you NOT install OmniPass in the root directory (e.g. C:\).
3. Once OmniPass has completed installation you will be prompted to restart your system. Once your system has rebooted you will be able to use OmniPass. If you choose not to restart immediately after installation, OmniPass will not be available for use until the next reboot.

The installation program automatically places an icon (Softex OmniPass) in the Windows Control Panel as well as a golden key shaped icon in the taskbar.

Verifying Information about OmniPass

After you have completed installing OmniPass and restarted your system, you may wish to check the version of OmniPass on your system.

To check the version information of OmniPass:

1. From the Windows Desktop, double-click the key-shaped OmniPass icon in the taskbar (usually located in the lower right corner of the screen), or, Click the **Start** button, select **Settings**, and click **Control Panel** (if you are using Windows XP you will see the Control Panel directly in the Start menu; click it, then click **Switch to Classic View**). Double-click **Softex OmniPass** in the Control Panel, and the OmniPass Control Center will appear. If it does not appear, then the program is not properly installed,

or,

Click the **Start** button, select **Programs**, and from the submenu select the **Softex** program group, from that submenu click **OmniPass Control Center**.

2. Select the **About** tab at the top of the OmniPass Control Panel. The About tab window appears with version information about OmniPass.

Uninstalling OmniPass



For uninstallation, OmniPass requires that the user uninstalling OmniPass have administrative privileges to the system. If your current user does not have administrative privileges, log out and then log in with an administrator user before proceeding with OmniPass uninstallation.

To remove the OmniPass application from your system:

1. Click **Start** on the Windows taskbar. Select **Settings**, and then **Control Panel**.
2. Double-click **Add/Remove Programs**.
3. Select **OmniPass**, and then click **Change/Remove**.
4. Follow the directions to uninstall the OmniPass application.
5. Once OmniPass has finished uninstalling, reboot your system when prompted.

USER ENROLLMENT

Before you can use any OmniPass features you must first enroll a user into OmniPass.

Master Password Concept

Computer resources are often protected with passwords. Whether you are logging into your computer, accessing your email, e-banking, paying bills online, or accessing network resources, you often have to supply credentials

to gain access. This can result in dozens of sets of credentials that you have to remember.

During OmniPass user enrollment a “master password” is created for the enrolled user. This master password “replaces” all other passwords for sites you register with OmniPass.

Example: A user, John, installs OmniPass on his system (his home computer) and enrolls an OmniPass user with username “John_01” and password “freq14”. He then goes to his webmail site to log onto his account. He inputs his webmail credentials as usual (username “John_02” and password “tablet”), but instead of clicking [Submit], he directs OmniPass to **Remember Password**. Now whenever he returns to that site, OmniPass will prompt him to supply access credentials.

John enters his OmniPass user credentials (“John_01” and “freq14”) in the OmniPass authentication prompt, and he is allowed into his webmail account. He can do this with as many websites or password protected resources he likes, and he will gain access to all those sites with his OmniPass user credentials (“John_01” and “freq14”). This is assuming he is accessing those sites with the system onto which he enrolled his OmniPass user. OmniPass does not actually change the credentials of the password protected resource. If John were to go to an Internet cafe to access his webmail, he would need to enter his original webmail credentials (“John_02” and “tablet”) to gain access. If he attempts his OmniPass user credentials on a system other than where he enrolled that OmniPass user, he will not gain access.



The basic enrollment procedure assumes you have no hardware authentication devices or alternate storage locations that you wish to integrate with OmniPass. If you desire such functionality, consult the appropriate sections after reviewing this section.

Basic Enrollment

The Enrollment Wizard will guide you through the process of enrolling a user. Unless you specified otherwise, after OmniPass installation the Enrollment Wizard will launch on Windows login. If you do not see the Enrollment Wizard, you can bring it up by clicking **Start** on the Windows taskbar; select **Programs**; select **Softex**; click **OmniPass Enrollment Wizard**.

1. Click **Enroll** to proceed to username and password verification. By default, the OmniPass Enrollment Wizard enters the credentials of the currently logged in Windows user.
2. Enter the password you use to log in to Windows. This will become the “master password” for this OmniPass user. In most cases, the **Domain:** value



will be your Windows computer name. In a corporate environment, or when accessing corporate resources, the **Domain:** may not be your Windows computer name. Click [Next] to continue.

3. In this step OmniPass captures your fingerprint. Refer to “Enrolling a Fingerprint” on page 105 for additional information.
4. Next, choose how OmniPass notifies you of various events. We recommend you keep **Taskbar Tips on Beginner mode taskbar tips** and **Audio Tips** on at least **Prompt with system beeps only** until you get accustomed to how OmniPass operates. Click [Next] to proceed with user enrollment. You will then see a Congratulations screen indicating your completion of user enrollment.
5. Click [Done] to exit the OmniPass Enrollment Wizard. You will be asked if you'd like to log in to OmniPass with your newly enrolled user; click [Yes].

Enrolling a Fingerprint

Enrolling a fingerprint will increase the security of your system and streamline the authentication procedure.

You enroll fingerprints in the OmniPass Control Center. With an OmniPass user logged in, double-click the system tray OmniPass icon. Select the **User Settings** tab and click **Enrollment** under the **User Settings** area. Click **Enroll Authentication Device** and authenticate at the authentication prompt to start device enrollment.

1. During initial user enrollment, you will be prompted to select the finger you wish to enroll. Fingers that have already been enrolled will be marked by a green check. The finger you select to enroll at this time will be marked by a red arrow. OmniPass will allow you re-enroll a finger. If you choose a finger that has already been enrolled and continue enrollment, OmniPass will enroll the fingerprint, overwriting the old fingerprint. Select a finger to enroll and click [Next].
2. It is now time for OmniPass to capture your selected fingerprint. It may take a several capture attempts before OmniPass acquires your fingerprint. Should OmniPass fail to acquire your fingerprint, or if the capture screen times out, click [Back] to restart the fingerprint enrollment process.

Your system has a “swipe” fingerprint sensor. A swipe sensor is small and resembles a skinny elongated rectangle. To capture a fingerprint, gently swipe or pull your fingertip over the sensor (starting at the second knuckle) towards yourself. Swiping too fast or too slow will result in a failed capture. The **Choose Finger** screen has a [Practice] button; click it to practice capturing your fingerprint. When you are comfortable with how your fingerprint is captured, proceed to enroll a finger.

3. Once OmniPass has successfully acquired the fingerprint, the **Verify Fingerprint** screen will automatically appear. To verify your enrolled fingerprint, place your fingertip on the sensor and hold it there as if you were having a fingerprint captured. Successful fingerprint verification will show a green fingerprint in the capture window and the text **Verification Successful** under the capture window.

USING OMNIPASS

You are now ready to begin using OmniPass. Used regularly, OmniPass will streamline your authentication procedures.

Password Replacement

You will often use the password replacement function. When you go to a restricted access website (e.g., your bank, your web-based email, online auction or payment sites), you are always prompted to enter your login credentials. OmniPass can detect these prompts and you can teach OmniPass your login credentials. The next time you go to that website, you can authenticate with your fingerprint to gain access.

OmniPass Authentication Toolbar

After installing OmniPass and restarting, you will notice a dialog you have not seen before at Windows Logon. This is the OmniPass Authentication Toolbar, and it is displayed whenever the OmniPass authentication system is invoked. The OmniPass authentication system may be invoked frequently: during Windows Logon, during OmniPass Logon, when unlocking your workstation, when resuming from standby or hibernate, when unlocking a password-enabled screensaver, during password replacement for remembered site or application logins, and more. When you see this toolbar, OmniPass is prompting you to authenticate.

The **Logon Authentication** window indicates what OmniPass-restricted function you are attempting. The icons in the lower left (fingerprint and key) show what authentication methods are available to you. Selected authentication methods are highlighted while unselected methods are not. When you click the icon for an unselected authentication method, the authentication prompt associated with that method is displayed.

When prompted to authenticate, you must supply the appropriate credentials: an enrolled finger for the fingerprint capture window or your master password for the master password prompt (the key icon).

Remembering a Password

OmniPass can remember any application, GUI, or password protected resource that has a password prompt.

Using the following procedure, you can store a set of credentials into OmniPass. These credentials will then be linked to your “master password” or fingerprint.

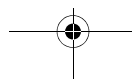
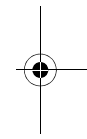
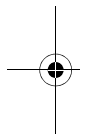

Go to a site that requires a login (username and password), but *do not log in yet*. At the site login prompt, enter your username and password in the prompted fields, but *do not enter the site* (do not hit [Enter], [Submit], [OK], or Login). Right-click the OmniPass system tray icon and select **Remember Password** from the submenu. The Windows arrow cursor will change to a golden key OmniPass cursor. Click this OmniPass cursor in the login prompt area, but do not click the [Login] or [Submit] button.

Associating a Friendly Name

After clicking the OmniPass key cursor near the login prompt, OmniPass will prompt you to enter a “friendly name” for this site. You should enter something that reminds you of the website, the company, or the service you are logging into. In its secure database, OmniPass associates this friendly name with this website.

Additional Settings for Remembering a Site

When OmniPass prompts you to enter a “friendly name” you also have the opportunity to set how OmniPass authenticates you to this site. There are three effective settings for how OmniPass handles a remembered site.

The default setting is **Automatically click the “OK” or “Submit” button for this password protected site once the user is authenticated**. With this setting, each time you navigate to this site OmniPass will prompt you for your master password or fingerprint authentication device. Once you have authenticated with OmniPass, you will automatically be logged into the site.

Less secure is the option to **Automatically enter this password protected site when it is activated. Do not prompt for authentication**. Check the upper box to get this setting, and each time you navigate to this site OmniPass will log you into the site without prompting you to authenticate.



This setting is more convenient in that whenever you go to a site remembered with this setting, you will bypass any authentication procedure and gain instant access to the site. But should you leave your system unattended with your OmniPass user logged in, anyone using your system can browse to your password protected sites and gain automatic access.

If you uncheck both boxes in **Settings for this Password Site**, OmniPass will prompt you for your master password or fingerprint authentication device. Once you have authenticated with OmniPass your credentials will be filled in to the site login prompt, but you will have to click the website [OK], [Submit], or [Login] button to gain access to the site.

Click **Finish** to complete the remember password procedure. The site location, the credentials to access the site, and the OmniPass authentication settings for the site are now stored in the OmniPass secure database. The OmniPass authentication settings (**Settings for this Password Site**) can always be changed in **Vault Management**.

Logging in to a Remembered Site

Whether or not OmniPass prompts you to authenticate when you return to a remembered site is determined by **Settings for this Password Site** and can be changed in **Vault Management**.

The following cases are applicable to using OmniPass to login to: Windows, remembered websites, and all other password protected resources.

With Master Password

Once you return to a site you have remembered with OmniPass, you may be presented with a master password prompt. Enter your master password and you will be allowed into the site.

Logging into Windows with a Fingerprint Device

When logging into Windows with a fingerprint device, the fingerprint capture window will now appear next to the Windows Login screen. Place your enrolled fingertip on the sensor to authenticate. You will be simultaneously logged into Windows and OmniPass. The capture window will also appear if you have used **Ctrl-Alt-Del** to lock a system, and the fingerprint device can be used to log back in as stated above.



If a machine is locked and OmniPass detects a different user logging back in with a fingerprint, the first user will be logged out and the second user logged in.

In Windows XP, your login options must be set either for classic login, or for fast user switching and logon screen to be enabled to use your fingerprint to log on to Windows. To change this go to **Control Panel**, select **User Accounts** and then click **Change the way users log on or off**. If your Windows screensaver is password protected, the fingerprint capture window will now appear next to screensaver password dialog during resume. You can authenticate to your screensaver password prompt with your enrolled finger.

Password Management

OmniPass provides an interface that lets you manage your passwords. To access this GUI, double-click the OmniPass key in the system tray. Click **Vault Management**; you will be prompted to authenticate. Once you gain access to **Vault Management**, click **Manage Passwords** under **Vault Settings**. You will see the **Manage Passwords** interface, with a list of friendly names.

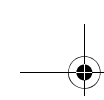

You can view the credentials stored for any remembered website by highlighting the desired resource under **Password Protected Dialog** and clicking **Unmask Values**. Should a password be reset, or an account expire, you can remove stored credentials from OmniPass. Highlight the desired resource under **Password Protected Dialog** and click **Delete Page**. You will be prompted to confirm the password deletion.

The two check boxes in **Manage Passwords** govern whether OmniPass prompts you to authenticate or directly logs you into the remembered site.

OmniPass will overwrite an old set of credentials for a website if you attempt to use **Remember Password** on an already remembered site.

The exception to the above rule is the resetting of your Windows password. If your password is reset in Windows, then the next time you login to Windows, OmniPass will detect the password change and prompt you to "Update" or "Reconfirm" your password with OmniPass. Enter your new Windows password in the prompt(s) and click **OK** and your OmniPass "master password" will still be your Windows password.

OmniPass User Identities

Identities allow OmniPass users to have multiple accounts to the same site (e.g., *bob@biblomail.com* and *boballen@biblomail.com*). If OmniPass did not provide you identities, you would be limited to remembering one account per site.

To create and manage identities, double-click the OmniPass key in the system tray. Click **Vault Management**; OmniPass will prompt you to authenticate. Once you gain access to **Vault Management**, click **Manage Identities** under **Vault Settings**. You can only manage the identities of the currently logged in OmniPass user

To add a new identity, click **New Identity** or double-click **Click here to add a new identity**. Name the new identity and click [OK], then click [Apply]. You can now switch to the new identity and start remembering passwords.

To delete an identity, highlight the identity you want to delete and click [Delete Identity], then click [Apply].



When you delete an identity, all of its associated remembered sites and password protected dialogs are lost.

To set the default identity, highlight the identity you want as default and click [Set as Default]; click [Apply] to ensure the settings are saved. If you log in to OmniPass with a fingerprint device, you will automatically be logged in to the default identity for that OmniPass user. You can choose the identity with which you are logging in if you login using "master password".

Choosing User Identity during Login

To choose your identity during login, type your username in the **User Name:** field. Press [Tab] and see that the **Domain:** field self-populates. Click the **Password:** field to bring the cursor to it, and you will see the pull-down menu in the **Identity:** field. Select the identity you wish to login as and then click **OK** to login.

Switch User Identity

To switch identities at any time, right-click the OmniPass system tray icon and click **Switch User Identity** from the submenu. The **Switch Identity** dialog will appear. Select the desired identity and then click **OK**.

Identities and Password Management

On the **Manage Passwords** interface of the **Vault Management** tab of the OmniPass Control Center, there is a pull-down selection box labeled, **Identity**. This field lets you choose which identity you are managing passwords for. When you select an identity here, only those password protected dialogs that are associated with that identity are shown. You can perform all the functions explained in "Password Management" on page 106.

CONFIGURING OMNIPASS

This section gives an overview of both the **Export/Import** function and the OmniPass Control Center.

Exporting and Importing Users

Using the OmniPass Control Center, you can export and import users in and out of OmniPass. The export process backs up all remembered sites, credentials, and any enrolled fingerprints for an OmniPass user. All OmniPass data for a user is backed up to a single encrypted database file. During the import process, the Windows login of the exported user is required. If the proper credentials cannot be supplied, the user profile will not be imported.



- You should periodically export your user profile and store it in a safe place. If anything happens to your system, you can import your OmniPass profile to a new system and have all your remembered settings and fingerprints instantly.
- You don't forget the Windows login credentials when exporting. When you examine the importation, you are prompted for authentication. The credentials that will allow a user profile to be imported are the Windows login credentials of the exported user. They are the credentials that had to be submitted when the user profile was exported. You will need User Name, Password, and Domain.

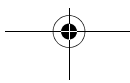

Exporting an OmniPass User Profile

To export a user, open the OmniPass Control Center, and click **Import/Export User** under **Manage Users**.

Click **Exports an OmniPass user profile**. OmniPass will prompt you to authenticate. Upon successfully authentication, you must name the OmniPass user profile and decide where to save it. An .opi file is generated, and you should store a copy of it in a safe place.

This .opi file contains all your user specific OmniPass data, and it is both encrypted and password protected. This user profile does NOT contain any of your encrypted data files.

Importing an OmniPass User Profile



You cannot import a user into OmniPass if there already is a user with the same name enrolled in OmniPass.

To import an OmniPass user open the OmniPass Control Center, and click **Import/Export User** under **Manage Users**. Click **Imports a new user into OmniPass** and then select **OmniPass Import/Export File (*.opi)** and click **Next**. OmniPass will then prompt you to browse for the file you had previously exported (.opi file). When you select the .opi file for importation, OmniPass will prompt you for authentication. The credentials that will allow a user profile to be imported are the Windows login credentials of the exported user. They are the credentials that had to be submitted when the user profile was exported. You will need **User Name**, **Password**, and **Domain**. If you don't remember the value for **Domain**, in a PC or SOHO environment **Domain** should be your computer name.

OmniPass will notify you if the user was successfully imported.

Things to Know Regarding Import/Export

- Assume you export a local Windows User profile from OmniPass. You want to import that profile to another machine that has OmniPass. Before you can import the profile, a Windows user with the same login credentials must be created on the machine importing the profile.

Example: I have a Windows user with the username "Tom" and the password "Sunshine" on my system. I have enrolled Tom into OmniPass and remembered passwords. I want to take all my passwords to new system. I export Tom's OmniPass user profile. I go to my new system and using the Control Panel I create a user with the username "Tom" and the password "Sunshine". I can now successfully import the OmniPass user data to the new system.

- If you export an OmniPass-only user, you can import that user to any computer running OmniPass, provided that a user with that name is not already enrolled in OmniPass.
- If you attempt to import a user profile who has the same name as a user already enrolled in OmniPass, the OmniPass import function will fail.

OMNIPASS CONTROL CENTER

This section will serve to explain functions within the OmniPass Control Center that weren't explained earlier.

You can access the OmniPass Control Center any of three ways:

- Double-click the golden OmniPass key shaped icon in the Windows taskbar (typically in the lower-right corner of the desktop)
- Click the **Start** button; select the **Programs** group; select the **Softex** program group; and click the **OmniPass Control Center** selection.
- Open the Windows **Control Panel** (accessible via **Start** button --> **Settings** --> **Control Panel**) and double-click the **Softex OmniPass** icon.

User Management

The User Management tab has two major interfaces: **Add/Remove User** and **Import/Export User**. Import/Export User functionality is documented in "Exporting and Importing Users" on page 107. Add/Remove User functionality is straightforward.

If you click **Adds a new user to OmniPass** you will start the OmniPass Enrollment Wizard. The Enrollment Wizard is documented in "User Enrollment" on page 104.

If you click **Removes a user from OmniPass**, OmniPass will prompt you to authenticate. Authenticate with the credentials (or enrolled fingerprint) of the user you wish to remove. OmniPass will prompt you to confirm user removal. Click **OK** to complete user removal.



Removing a user will automatically destroy all OmniPass data associated with that user. All identities and credentials associated with the user will be lost.

If you are sure about removing the user, we recommend you export the user profile.

User Settings

The User Settings tab has four interfaces: **Audio Settings**, **Taskbar Tips**, and **Enrollment**. User settings allow users to customize OmniPass to suit individual preferences. Under **User Settings** (**Audio Settings** and **Taskbar Tips**)



you can set how OmniPass notifies the user of OmniPass events (e.g., successful login, access denied, etc.). The details of each setting under the **Audio Settings** and **Taskbar Tips** interfaces are self-explanatory.

The **Enrollment** interface allows you to enroll fingerprints. For the procedure to enroll and authentication device refer to *Chapter 2.3*. To enroll additional fingerprints, click **Enroll Authentication Device**, and authenticate with OmniPass. Select the fingerprint recognition device in the **Select Authentication Device** screen (it should already be marked by a green check if you have a finger enrolled) and click **Next**.

System Settings

The **OmniPass Startup Options** interface can be found in the System Settings tab. With these options you can specify how your OmniPass Logon is tied to your Windows Logon.

The first option, **Automatically log on to OmniPass as the current user**, will do just as it says; during Windows login, you will be logged on to OmniPass using your Windows login credentials. If the user logging into Windows was never enrolled into OmniPass, upon login no one will be logged on to OmniPass. This setting is appropriate for an office setting or any setting where users must enter a username and password to log into a computer. This is the default setting.

With the second option, **Manually log on to OmniPass at startup**, OmniPass will prompt you to login once you have logged on to Windows.

With the third option, **Do not log on to OmniPass at startup**, OmniPass will not prompt for a user to be logged on.

You can manually log on to OmniPass by right-clicking the OmniPass taskbar icon and clicking **Log in User** from the right-click menu.

TROUBLESHOOTING

You cannot use OmniPass to create Windows users. You must first create the Windows user, and you will need administrative privileges to do that. Once the Windows user is created, you can add that user to OmniPass using the same username and password

Cannot add Windows users to OmniPass

If you experience difficulties adding a Windows user to OmniPass, you may need to adjust your local security settings. You can do this by going to **Start**, **Control Panel**, **Administrative Tools**, and **Local Security Settings**. Expand **Local Policies**, expand **Security Options**, and double-click **Network Access: Sharing and Security Model for Local Accounts**. The

correct setting should be *Classic - Local Users Authenticate as Themselves*.

Cannot add a User with a Blank Password to OmniPass

If you experience difficulties adding a user with a blank password to OmniPass, you may need to adjust your local security settings. First attempt the procedure explained in the *Cannot add Windows user to OmniPass* section. If the difficulties persist, then try the following procedure.

Click **Start**, **Control Panel**, **Administrative Tools**, and **Local Security Settings**. Expand **Local Policies**, expand **Security Options**, and double-click **Accounts: Limit local account use of blank passwords to console login only**. This setting should be set to **Disabled**.

Dialog appears after OmniPass authentication during Windows Logon

After installing OmniPass on your system, you can choose to logon to Windows using OmniPass. You authenticate with OmniPass (via master password, or an enrolled security device) and OmniPass logs you into Windows. You may, during this OmniPass authentication, see a **Login Error** dialog box.

This dialog box occurs when OmniPass was unable to log you into Windows with the credentials supplied (username and password). This could happen for any of the following reasons:

- Your Windows password has changed
- Your Windows account has been disabled

If you are having difficulties due to the first reason, you will need to update OmniPass with your changed Windows account password. Click **Update Password** and you will be prompted with a dialog to reconfirm your password.

Enter the new password to your Windows user account and click **OK**. If the error persists, then it is unlikely the problem is due to your Windows user account password changing.

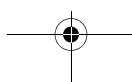
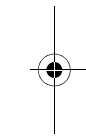
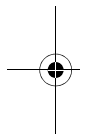

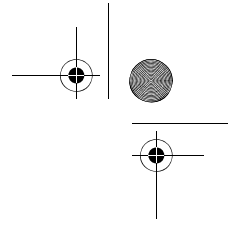
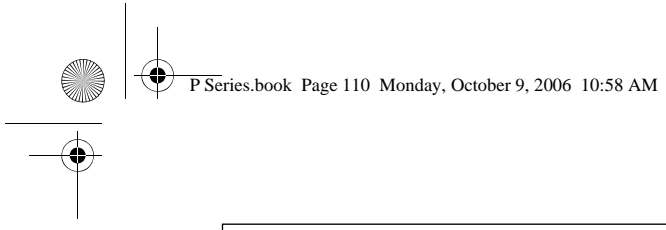

LifeBook P1600 Series Notebook

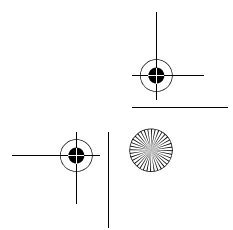
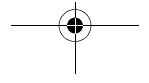
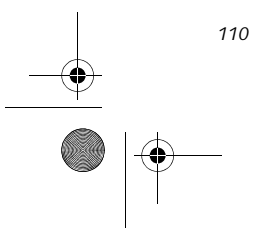
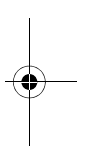
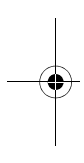

Index

A

- AC
 - adapter 31
 - plug adapters 65
- Anti-theft Lock Slot 12
- Auto/Airline Adapter 31
- Automatically Downloading Driver Updates 61

B

- Battery 39
 - alarm 39
 - care 66
 - cold-swapping 40
 - conserving power 34
 - dead 55
 - faulty 55
 - increasing life 66
 - level indicators 14
 - lithium ion battery 39
 - low 39
 - problems 55
 - recharging 39
 - replacing 40
 - shorted 40
 - suspend mode 39
- battery release latch 8
- BIOS
 - guide 32
 - setup utility 32
- Bluetooth
 - Where to Find Information 100
- Boot Sequence 32
- Built-in Microphone 13
- Button Icons 22

C

- CapsLock Indicator 14
- CD-ROM care 67
- Changing Button Functions 23
- Click Me! 33
- Closed Cover Switch 9
- Configuration Label 13
- Conventions used 3
- Cursor Keys 17

D

- DC in connector 8
- DC Power Jack 11, 31
- Device Ports 47
- DIMM 41
- Display Panel 9
 - brightness 16
 - latch 9
 - opening 15
 - problems 56, 57
- Display Timeout 35
- Docking Port 47
- Drivers and Application Restore CD 60

E

- Error Messages 58
- External Monitor Port 12, 48

F

- FDD 61
- Fingerprint Sensor Device 103
 - Configuring OmniPass 107
 - Getting Started 103
 - Installing OmniPass 103
 - Introducing the Fingerprint Sensor Device 103
 - OmniPass Control Center 108
 - Troubleshooting 109
 - Uninstalling OmniPass 104
 - User Enrollment 104
 - Using OmniPass 105
- Floppy Disk
 - care 66
- Fujitsu Driver Update utility 61
- Function Key
 - F10 18
 - F3 18
 - F4 18
 - F5 18
 - F6 18
 - F7 18
 - F8 18
 - F9 18
 - FN 18
 - Fn 18

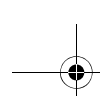

H

Hard Disk Drive
 access indicator 14
 problems 52
 Hard Disk Timeout 35
 Headphone Jack 8, 10, 47
 Hibernate Mode 35
 Hibernation Feature 35

I

Internal LAN Jack 47

K

Keyboard 9, 17
 cursor keys 17
 numeric keypad 17
 problems 52
 windows keys 17

L

LAN (RJ-45) Jack 12
 LifeBook Application Panel 19
 LifeBook P Series notebook
 care 65
 specifications 71
 storing 65
 traveling 65
 unpacking 7
 LifeBook P Series notebook specifications
 additional 72
 agency approval 72
 display specifications 71
 environmental 72
 physical specifications 71, 72
 power 72
 LifeBook Security Application Panel 9, 19
 operating 20
 passwords 19
 uninstalling 20
 Local Area Network (LAN) 8

M

Memory
 capacity 42
 compartment 13, 42
 installing 41
 problems 53
 removing 42
 upgrade module 41
 Memory Stick
 installing 43
 Microphone Jack 8, 47

Microprocessor 71
 modem 8, 12, 53
 Modem (RJ-11) Port 12
 Modem Jack 47
 Modem Result Codes 59
 Mouse 52, 53

N

Numeric Keypad 17
 NumLk Indicator 14

O

optional accessories 7

P

PC Card
 care 67
 installing 44
 problems 54
 removing 44
 slot 10
 Pen 11
 Port Replicator 45
 attaching 46
 detaching 46
 problems 52
 Port Replicator Connector 13
 Power
 AC adapter 31
 Auto/Airline adapter 31
 failure 54
 indicator 14
 management 34
 off 36
 power on 32
 problems 55
 sources 31
 Power Management 34, 35
 Power On Self Test 32, 58

Q

Quick Point
 clicking 24
 control adjustment 25
 double-clicking 24
 dragging 24

R

Registration 33
 Re-Installing Individual Drivers and Applications 60
 Removing a Memory Stick 43
 Restarting the system 35



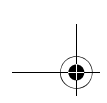

Index

Restoring the Factory Image60
 Restoring Your Pre-installed Software60
 RJ-1147
 RJ-458, 47

S

ScrLk Indicator14
 SD Card
 removing43
 SD Card Slot11
 SD Cards
 removing43
 SDRAM13, 41
 Secure Digital Card
 removing43
 Security lock slot8
 Shut Down36
 Specifications71
 Standby Mode35
 status indicators9, 14
 Suspend Mode34
 Suspend/Resume Button8, 9, 34

T

Touch Screen25
 calibrating26
 clicking25
 double-clicking25
 dragging26
 Touchpad Pointing Device9, 26
 Troubleshooting51
 battery55
 built-in Speakers52
 hard drive52
 memory53
 mouse/keyboard52
 PC Card54
 port replicator52
 ports53, 54
 power54
 video56

U

Universal Serial Bus Port47
 USB47
 problems53, 54
 USB 2.0
 ports12
 USB port8
 Using the system as a Tablet15

V

volume control27

W

Windows keys17
 Application key17
 Start key17
 Wireless LAN
 access point (infrastructure) mode87
 activating the WLAN device88
 ad hoc mode86
 before using the wireless LAN86
 configuration89
 deactivating the WLAN device87
 devices covered by this document86
 IP address information98
 modes86
 specifications99
 troubleshooting95
 using Atheros Client Utility software90
 using Intel PROSet software89
 wireless LAN glossary96
 wireless network considerations87
 WLAN On/Off Switch8, 10



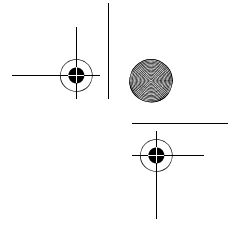
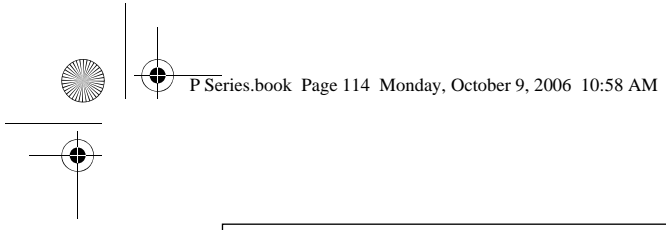

LifeBook P1600 Series Notebook

