

P3PC-1792-01ENZO

Color Image Scanner

ScanSnap

S510

Operator's Guide

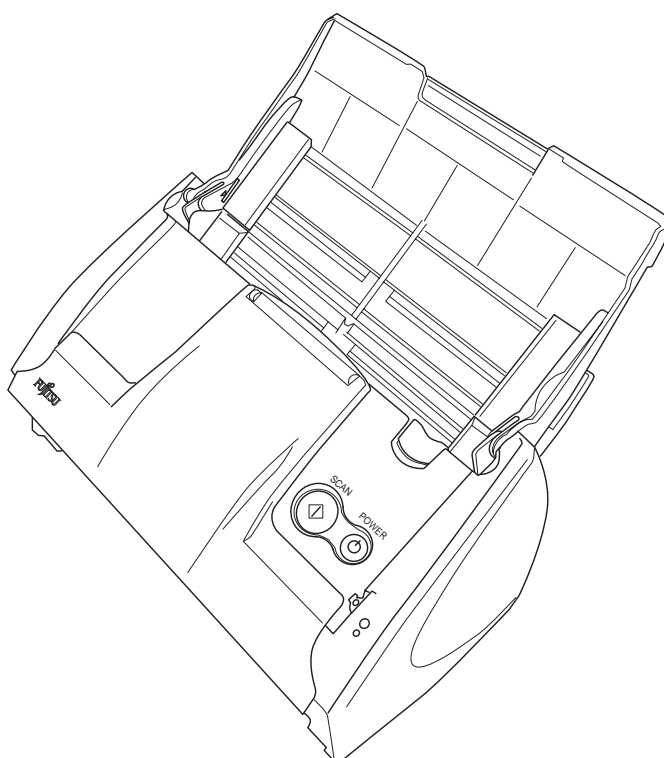

FUJITSU

Introduction



Thank you for purchasing Color Image Scanner ScanSnap S510 (hereinafter referred to as the "ScanSnap").

The ScanSnap is a scanner that is capable of double-sided scanning in both monochrome and color. The ScanSnap has the following advantages:

■ **You can turn images on paper into PDF files and made PDF files searchable by just pressing the [SCAN] button!**

You can turn documents cluttering up your desk into PDF files to manage and archive them on your computer. By using Adobe® Acrobat®, which comes with the ScanSnap, you can view, edit, and search PDF files right at your fingertips.

PDF files are easy to print and share scanned images by e-mail.

In addition to the advantages above, the ScanSnap can automatically recognize the type of documents, color or black-and-white, so that the size of the scanned image file can be reduced when documents containing both color and black-and-white pages are scanned. (Moreover, the ScanSnap can automatically remove blank pages from the document to further reduce the size of the file.)

■ **You can scan documents with speed and efficiency!**

Double-sided color documents of A4 or letter size paper can be scanned at a speed of about 18 sheets/minute (when Scan mode is set to Normal, Color mode is set to Auto, and Compression rate is set to 3). (*1)

(*1) -Depending on the document, scanning speed may become slower in "B&W (Black&White)" mode (due to process for converting data scanned in color to monochrome data).

Example: Scanning color brochures in "B&W" mode

-When "Correct skewed character strings automatically," "Allow automatic image rotation," and/or automatic text recognition is enabled, scanning speed may become slower.

■ **You can eliminate the nuisance of a bulky device!**

Smaller than a sheet of A4 or letter size paper, the ScanSnap can fit unobtrusively on your desktop all the time.

■ **You can file business cards with ease!**

With CardMinder™, which is supplied with the ScanSnap, business cards can be easily filed and searched for using the OCR function.

■ **The Quick menu is newly added for beginners to operate the ScanSnap with automatic ease!**

When the [SCAN] button is pressed, the Quick menu is displayed. What you should do is to select the action you want to perform on the Quick menu. The Quick menu is simple enough for first-time use by completely neophytes. (Quick menu mode)

■ **You can send off the scanned image by e-mail or output the scanned image to the printer immediately after scanning!**

Without starting applications, you can attach the scanned image to e-mail or make copies of the scanned image by outputting it to the printer.

■ **You can convert paper documents into Word/Excel/PowerPoint files!**

With ABBYY FineReader for ScanSnap™, you can convert the scanned document directly into the Word/Excel/PowerPoint file.

Note: The ScanSnap does not conform to TWAIN and ISIS standards.

This Operator's Guide describes how to handle and operate the ScanSnap. Before using the ScanSnap, be sure to read this document thoroughly for proper operation.

Introduction	i
■ Regulatory Information	vi
■ Liability	viii
■ Trademarks	ix
■ Safety Precautions	xi
Chapter 1 Before You Start Using the ScanSnap	1
1.1 Checking the Contents of the Scanner Package	2
1.2 Names and Functions of Components	3
Chapter 2 Connecting the ScanSnap	5
2.1 Installing the Supplied Programs.....	6
2.2 Connecting the ScanSnap to your PC	21
Chapter 3 Using the ScanSnap.....	29
3.1 Flow of Operations	30
3.2 Paper Size of Documents to be Scanned.....	46
3.3 Loading Documents	49
Chapter 4 Setting the ScanSnap.....	63
4.1 About the ScanSnap Icon	64
4.2 Changing Scanning Settings.....	67
4.3 Saving Scanning Settings.....	92
4.4 Using the ScanSnap Quick Menu	103
4.5 Changing Carrier Sheet Settings	106

4.6 About Automatic Interaction with Applications.....	111
Chapter 5 About Actions	115
5.1 About Actions in the Action List	116
5.2 Saving Data in the Specified Folder.....	117
5.3 Sending Files by E-Mail	129
5.4 Using the ScanSnap as a Copy Machine.....	145
5.5 Converting into Word / Excel / PowerPoint Files.....	155
Chapter 6 Using the ScanSnap in Various Ways	169
6.1 Using ScanSnap Manager.....	170
6.2 Using Adobe Acrobat.....	197
6.3 Scanning Business Cards	202
6.4 Using ScanSnap Organizer.....	208
Chapter 7 Troubleshooting	217
7.1 Clearing Document Jams.....	218
7.2 Troubleshooting Checklist	220
Chapter 8 Daily Care	229
8.1 Cleaning Materials	230
8.2 Cleaning the Scanner Exterior	231
8.3 Cleaning the Inside of the Scanner.....	232
8.4 Cleaning Carrier Sheet.....	235

Chapter 9 Replacing Consumables and Carrier Sheet.....	237
9.1 Replacing Consumables	238
9.2 Replacing the Pad ASSY.....	240
9.3 Replacing the Pick Roller.....	243
9.4 Purchasing the Carrier Sheet	250
Appendix A Updating ScanSnap Manager	251
Appendix B Uninstalling ScanSnap	253
Appendix C Quick Menu Mode / Left-Click Menu Mode	255
Appendix D Installation Specifications.....	259
Repairs	261
Index.....	263

■ Regulatory Information

FCC declaration

This equipment has been tested and found to comply with the limits for a Class B digital device, pursuant to Part 15 of the FCC Rules. These limits are designed to provide reasonable protection against harmful interference in a residential installation. This equipment generates, uses, and can radiate radio frequency energy and, if not installed and used in accordance with the instruction manual, may cause harmful interference to radio communications. However, there is no guarantee that interference will not occur in a particular installation. If this equipment does cause harmful interference to radio or television reception, which can be determined by turning the equipment off and on, the user is encouraged to try to correct the interference by one or more of the following measures:

- Reorient or relocate the receiving antenna.
- Increase the separation between the equipment and receiver.
- Connect the equipment into an outlet on a circuit different from that to which the receiver is located.
- Consult your dealer or an experienced radio/TV technician.



Changes or modifications not expressly approved by the party responsible for compliance could void the user's authority to operate the equipment.

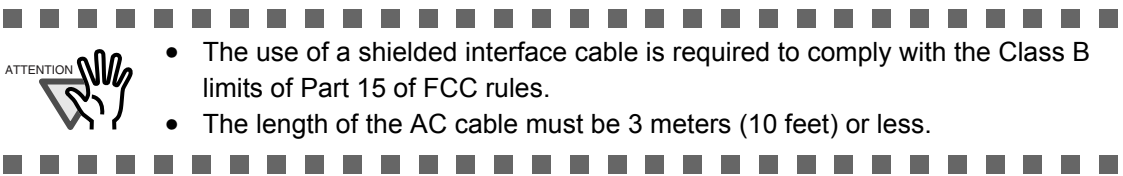

- The use of a shielded interface cable is required to comply with the Class B limits of Part 15 of FCC rules.
- The length of the AC cable must be 3 meters (10 feet) or less.

Canadian DOC Regulations

This digital apparatus does not exceed the Class B limit for radio noise emissions from digital apparatus set out in the Radio interference Regulations of the Canadian Department of Communications.

This Class B digital apparatus complies with Canadian ICES-003.

Le présent appareil numérique n'émet pas de parasites radioélectriques dépassant les limites applicables aux appareils numériques de la classe B et prescrites dans le Règlement sur le brouillage radioélectrique dictées par le Ministère des Communications du Canada. Cet appareil numérique de la classe B est conforme à la norme NMB-003 du Canada.

Bescheinigung des Herstellers / Importeurs

Für den S510 wird folgendes bescheinigt:

- In Übereinstimmung mit den Bestimmungen der EN45014(CE) funktentstört
- Maschinenlärminformationsverordnung 3. GPSGV: Der höchste Schalldruckpegel beträgt 70 dB (A) oder weniger, gemäß EN ISO 7779.

International ENERGY STAR® Program

As an ENERGY STAR® Partner, PFU LIMITED has determined that this product meets the ENERGY STAR® guidelines for energy efficiency.

The International ENERGY STAR® Office Equipment Program is an international program that promotes energy saving through the penetration of energy efficient computers and other office equipment.

The program backs the development and dissemination of products with functions that effectively reduce energy consumption. It is an open system in which business proprietors can participate voluntarily. The targeted products are office equipment such as computers, monitors, printers, facsimiles, copiers, scanners, and multifunction devices. Their standards and logos are uniform among participating nations.



■ Liability

READ ALL OF THIS MANUAL CAREFULLY BEFORE USING THIS PRODUCT. IF THIS PRODUCT IS NOT USED CORRECTLY, UNEXPECTED INJURY MAY BE CAUSED TO USERS OR BYSTANDERS.

While all efforts have been made to ensure the accuracy of all information in this manual, PFU assumes no liability to any party for any damage caused by errors or omissions or by statements of any kind in this manual, its updates or supplements, whether such errors are omissions or statements resulting from negligence, accidents, or any other cause. PFU further assumes no liability arising from the application or use of any product or system described herein; nor any liability for incidental or consequential damages arising from the use of this manual. PFU disclaims all warranties regarding the information contained herein, whether expressed, implied, or statutory.

Use in High-safety Applications

This product has been designed and manufactured on the assumption that it will be used in office, personal, domestic, regular industrial, and general-purpose applications. It has not been designed and manufactured for use in applications (simply called "high-safety applications" from here on) that directly involve danger to life and health when a high degree of safety is required, for example, in the control of nuclear reactions at nuclear power facilities, automatic flight control of aircraft, air traffic control, operation control in mass-transport systems, medical equipment for sustaining life, and missile firing control in weapons systems, and when provisionally the safety in question is not ensured. The user should use this product with adopting measures for ensuring safety in such high-safety applications. PFU LIMITED assumes no liability whatsoever for damages arising from use of this product by the user in high-safety applications, and for any claims or compensation for damages by the user or a third party.

About the use of mercury



Lamp(s) inside this product contain mercury and must be recycled or disposed of according to local, state, or federal laws.

To avoid unexpected injury, read the following carefully.

Doing the following actions may result in serious personal injuries:

- Do not put the substance in the lamp in your mouth as it contains mercury.
- Do not incinerate, crush, or shred the scanner.
- Do not breathe the chemical liquid contained in the scanner parts.

■ Trademarks

Microsoft, Windows, and PowerPoint are registered trademarks of Microsoft Corporation in the United States and/or other countries.

Word and Excel are the products of Microsoft Corporation.

Adobe, the Adobe logo, and Acrobat are either registered trademarks of Adobe Systems Incorporated in the United States and/or other countries.

Intel and Pentium are trademarks or registered trademarks of Intel Corporation its subsidiaries in the United States and other countries.

ScanSnap, ScanSnap logo, and CardMinder are the trademarks of PFU LIMITED.

Other product names are the trademarks or registered trademarks of the respective companies.

ABBYY™ FineReader™ 7.x Engine © ABBYY Software House 2005.

OCR by ABBYY Software House. All rights reserved.

ABBYY, FineReader are trademarks of ABBYY Software House.

How Trademarks Are Indicated In This Manual

ScanSnap: ScanSnap S510

CardMinder: CardMinder™ 3.0

References to operating systems (OSs) are indicated as follows:

Windows 2000: Microsoft® Windows® 2000 Professional operating system

Windows XP: Microsoft® Windows® XP Professional operating system (32-bit)

Microsoft® Windows® XP Home Edition operating system (32-bit)

Windows Vista: Microsoft® Windows® Vista™ Home Basic operating system (32-bit)

Microsoft® Windows® Vista™ Home Premium operating system (32-bit)

Microsoft® Windows® Vista™ Business operating system (32-bit)

Microsoft® Windows® Vista™ Ultimate operating system (32-bit)

Windows: Windows 2000, Windows XP, and Windows Vista

Adobe Acrobat: Adobe® Acrobat®

All descriptions in this manual are based on the premises that Adobe Acrobat supplied with the ScanSnap is used. Unless otherwise specified, Adobe Acrobat herein refers to Adobe Acrobat supplied with the ScanSnap. The version of Adobe Acrobat supplied with the ScanSnap is subject to change without notice. If the screen examples in this document differ from actual ones, please refer to "Adobe Acrobat Help."

ABBYY FineReader: ABBYY™ FineReader™ for ScanSnap

PFU TimeStamp: PFU TimeStamp for Adobe® Acrobat®



The screenshots used in this manual are of Windows XP.

Depending on the operating systems you are using, the screen examples and operations may differ from the actual ones.



About Mouse Operations

In this manual, mouse operations are defined as follows:

- Click: refers to clicking on the left mouse button one time (=> Left-click).
- Right-click: refers to clicking on the right mouse button one time.
- Double-click: refers to clicking twice in rapid succession on the left mouse button down.

Manufacturer

PFU LIMITED

International Sales Dept., Imaging Business Division, Products Group

Solid Square East Tower, 580 Horikawa-cho, Saiwai-ku, Kawasaki-shi Kanagawa 212-8563, Japan

Phone: (81)(44) 540-4538

All Rights Reserved, Copyright © PFU LIMITED 2007.

■ Safety Precautions

This manual describes important details for users to use this product safely and correctly. Read this manual thoroughly before you start using this product. Be sure to read and fully understand the Safety Precautions in this manual, in particular. In addition, keep this manual handy during use of this product, so that you can refer to it quickly when necessary.

Warning Indications Used In This Manual

In this manual, the following signs are used to indicate a risk of physical injury and damage, so that safe and correct use of this product can be ensured and possible danger and injury to the operator and other persons can be avoided.



This sign warns the operator that improper use, indicated with this sign, may cause death or severe injury of the operator or people in the vicinity, if not followed.



This sign warns the operator that improper use, indicated with this sign, may cause minor injury of the operator, or damage to equipment or property, if not followed.

Symbols Used In This Manual

In this manual, the following symbols are used to describe operations as well as indicate warnings.

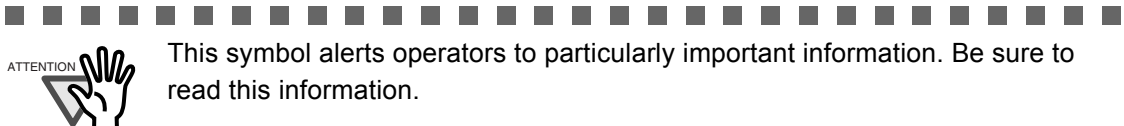

This symbol alerts operators to particularly important information. Be sure to read this information.

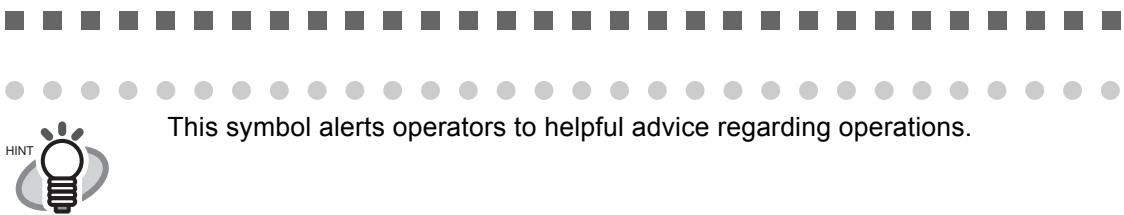

This symbol alerts operators to helpful advice regarding operations.



This symbol shows operations to perform on your computer.



This symbol shows operations to perform with your scanner.



A TRIANGLE symbol indicates that special care and attention is required. The drawing inside the triangle shows the specific caution.



A CIRCLE with a diagonal line inside shows action which users may not perform. The drawing inside or under the circle shows the specific action that is not allowed.



Outline characters on a colored background show instructions users should follow. It may also include the drawing that shows the specific instruction.

About the Hot Surface Hazard Warning Label

The following warning labels are attached to this product.

	The area around the part to which this warning label is affixed can become very hot. Please take serious caution as the heat can cause burns.
--	---

	Do NOT remove the warning labels from the scanner. Avoid them from being stained, so that the warning labels are plainly visible.
--	---

Screen Examples In This Manual

The screen examples in this manual are subject to change without notice in the interest of product improvement.

If actual screens differ from those used as examples in this manual, operate by following the actual ones referring to the User's Manual of the scanner.

The screenshots used in this manual are for the ScanSnap Manager and the CardMinder applications.

The screen examples in this manual are created according to Microsoft Corporation's Guideline.

About Maintenance

Repairs should be done by properly trained repair technicians.

When this product needs servicing, please contact the store where you purchased it or any authorized FUJITSU Image Scanner service provider.



The following describes important warnings described in this manual.

Do not touch the AC cable with wet hands.



Do not touch the power plug with wet hands. Doing so might cause electric shock.

Do not damage the AC cable.



A damaged AC cable may cause fire or electric shock.

Do not place heavy objects on AC cables, or pull, bend, twist, heat, damage or modify AC cables.

Do not use damaged AC cables or power plugs, and AC cables or power plugs when the wall socket is loose.

Use only specified AC cable, AC adapter, and connector cables



Use only the specified AC cable, AC adapter, and connector cables. Failure to use the correct cables might cause electric shock and equipment failure.

Do not use the AC cable, AC adapter, and connector cables provided with this scanner for other devices, since this might cause equipment failure and other troubles or an electric shock.

Use this scanner only at the indicated power voltage. Do not connect to multiple-power strips.



Use this scanner only at the indicated power voltage and current. Improper power voltage and current might cause fire or electric shock.

Also, do not connect to multiple-power strips.

Wipe any dust from the power plug.



Wipe off any dust from metal parts on the power plug or metal fittings with a soft, dry cloth. Accumulated dust might cause fire or electric shock.

Do not install in locations subject to oil smoke, steam, humidity, and dust.



Do not install the scanner in locations subject to oil smoke, steam, humidity, and dust. Doing so might cause a fire or electric shock.

Do not use the scanner if you smell strange odor.



If you detect heat coming from the device or detect other problems such as smoke, strange smells or noises, immediately turn off the scanner and then disconnect its power plug.

Make sure that the smoking has stopped, and then contact the store where you bought the scanner or an authorized FUJITSU scanner service provider.

Turn the scanner OFF if it is damaged.



If the scanner is damaged for any reason, turn off the scanner and unplug the power cable before contacting the store where you purchased the scanner.

Do not put liquids inside the scanner.



- Do not insert or drop metal objects in to the scanner.
- Do not scan wet documents or documents with paper clips or staples.
- Do not splash or allow the scanner to get wet.



If foreign objects (water, small metal objects, liquids, etc.) get inside the scanner, immediately turn off the scanner and disconnect the power plug from the power outlet, then contact the store where you bought the scanner or the Maintenance Service Center.



Pay particular attention to this warning in households where there are small children.

Do not touch the inside of the scanner unless necessary.



Do not take apart or modify the scanner. The inside of the scanner contains high-voltage components. Touching these components might cause fire or electric shock.



The following illustrates important cautions described in this manual.

Do not install the scanner on unstable surfaces.



Install the scanner on a flat, level surface. Make sure none of the scanner parts protrudes outside the desktop.

Do not install the scanner on unstable surfaces. Install the scanner on a level surface that is free of vibration to prevent it from falling.



Install the scanner on a strong surface that will support the weight of the scanner and other devices.

Firmly insert the power plug.



Firmly insert the power plug into the power outlet as far it can go.

Do not block the ventilation ports.



Do not block the ventilation ports. Blocking the ventilation ports generates heat inside of scanner, which may results in fire or scanner failure.

Do not place heavy objects or climb on top of the scanner.



Do not place heavy objects on the scanner or use the top surface of the scanner for performing other work. Improper installation might cause injuries.

Before moving the scanner, unplug the power cord from the electrical outlet.



Do not move the scanner with the power and interface cables connected as this might damage the cables, causing fire, electric shock or injuries.

Before moving the scanner, be sure to disconnect the power plug from the power outlet, and disconnect data cables. Also, make sure that the floor is free of obstructions.

Protect the scanner from static electricity.



Install the scanner away from strong magnetic fields and other sources of electronic noise. Also, protect the scanner from static electricity as this might cause the scanner to malfunction.

Do not use aerosol sprays near the scanner.



Do not use aerosol sprays to clean the scanner. Aerosol sprays cause dirt and dust to enter the scanner, resulting in scanner failure and malfunction.

Avoid any contact when scanner is working.



Avoid touching any scanner mechanism when scanning as this may cause injuries.

Unplug the power cord from the electrical outlet when the scanner is not used for an extended period of time.



For your safety, unplug the power cord from the electrical outlet when the scanner is not used for an extended period of time.

Do not expose the scanner to direct sunlight.



Do not install the scanner in a location exposed to direct sunlight or near any heating apparatus. Doing so increases the inside temperature of the scanner, and a fire or failure may occur. Install the scanner in a well-ventilated location.

Do not use the scanner immediately after moving it from a cold place into a warm room.



Do not use the device immediately after moving it from a cold place into a warm room. This may cause condensation, which might lead to scanning errors. Let the device dry about one or two hours before you use it.

Be careful not to cut your fingers



When handling the paper or Carrier Sheet, be careful not to cut your fingers by the paper or Carrier Sheet.



Chapter 1



Before You Start Using the ScanSnap

This chapter describes the necessary preparations for using the ScanSnap.

1.1 Checking the Contents of the Scanner Package	2
1.2 Names and Functions of Components	3

1.1 Checking the Contents of the Scanner Package

When you unpack the scanner package, find the packaging list first, and then make sure that the ScanSnap and all items in the packaging list are present.

If anything is missing or damaged, contact the store where you purchased the product.

1.2 Names and Functions of Components

This section describes the names of parts and their functions.

■ Front View

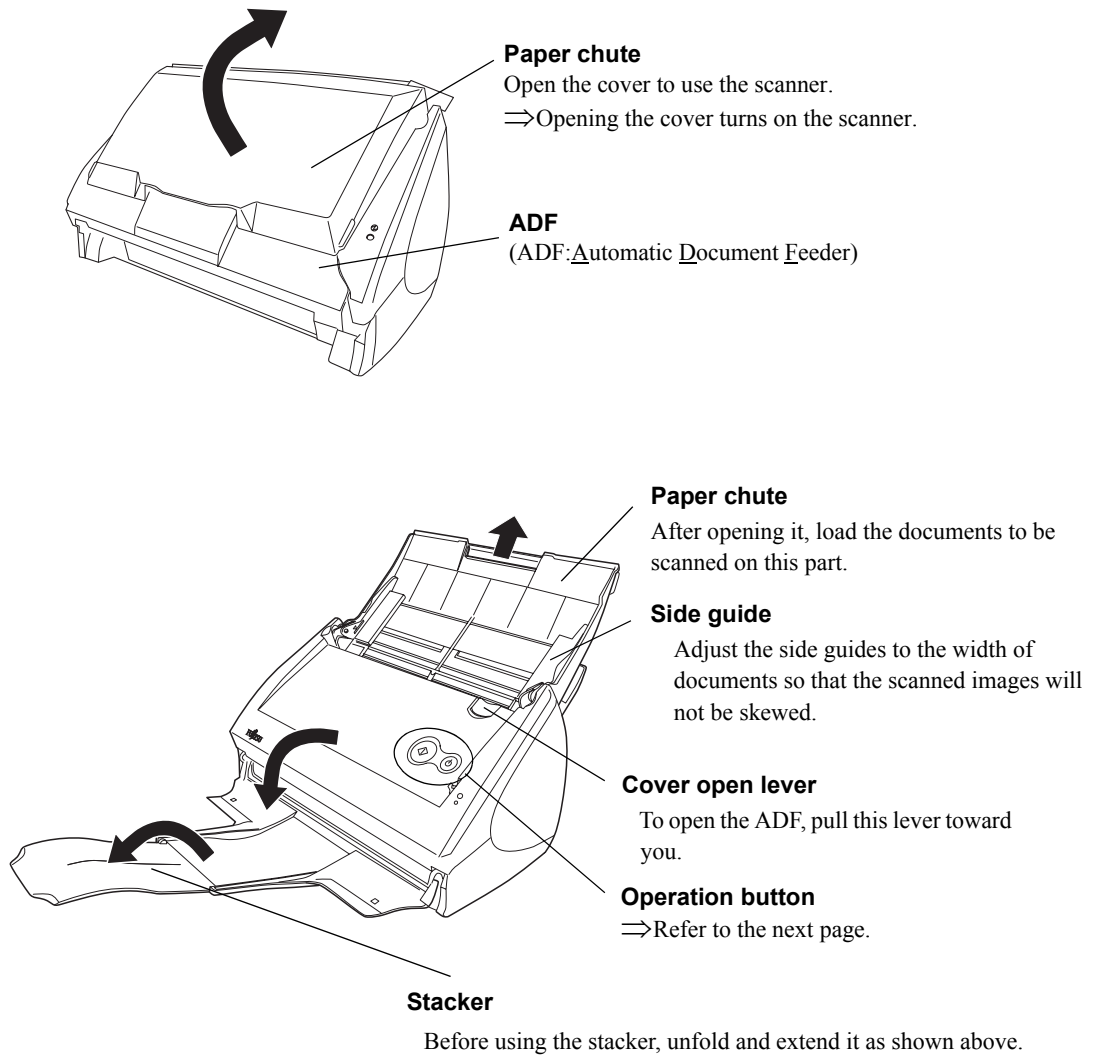

 You can also use the ScanSnap without unfolding the Stacker.

■ Operation Button

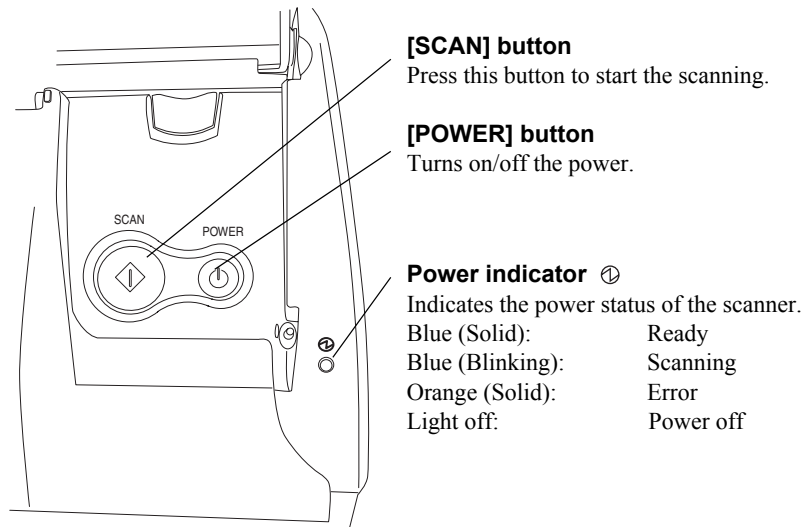

■ Rear View

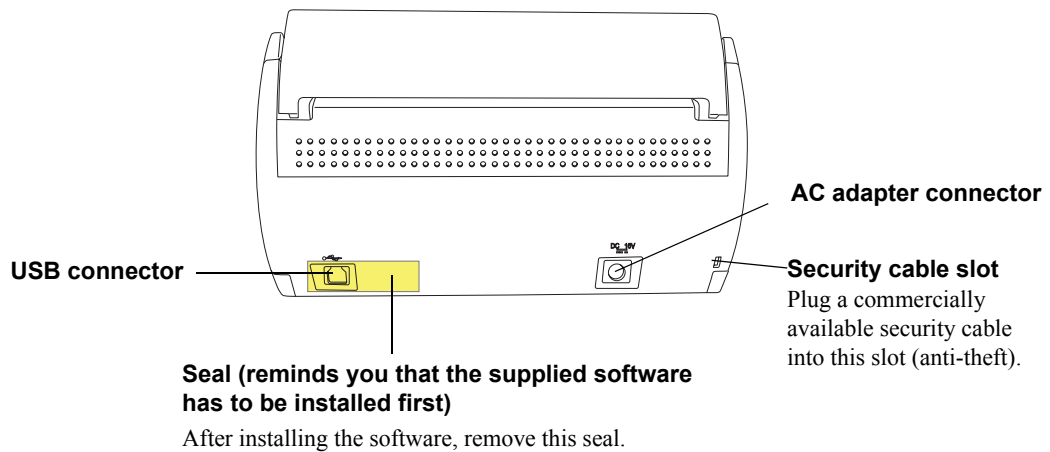

Chapter 2



Connecting the ScanSnap

This chapter describes how to connect the ScanSnap to your personal computer. Before you connect the ScanSnap, install the supplied programs (Adobe Acrobat, ABBYY FineReader for ScanSnap, ScanSnap Manager, ScanSnap Organizer, CardMinder, and PFU TimeStamp) on your personal computer.



- Be sure to install ScanSnap Manager before connecting the ScanSnap to your personal computer.
If you connect the ScanSnap to the personal computer before installing ScanSnap Manager, the ScanSnap will not operate correctly.
- * If you have connected the ScanSnap to the personal computer before installing ScanSnap Manager, the "Found New Hardware Wizard" dialog box appears (this dialog box might be slightly different depending on the operating system running on your personal computer). If this dialog box appears, click the [Cancel] button to close the Wizard dialog box, and install ScanSnap Manager first.
- When the ScanSnap is connected to a personal computer, other models (fi-5110EOX Series or ScanSnap S500) or another S510 cannot be used on the same personal computer.



For details about the installation area for the scanner, refer to "Appendix C Quick Menu Mode / Left-Click Menu Mode" (page 255).

2.1 Installing the Supplied Programs..... 6

2.2 Connecting the ScanSnap to your PC 21

2.1 Installing the Supplied Programs

"Installation" of programs is the act of copying the program files supplied with the ScanSnap into the hard disk of your personal computer so that the environment for using the ScanSnap is created on the personal computer in which you install the program files.

■ Before Installing the Supplied Programs for the ScanSnap

Before installing the supplied programs for the ScanSnap, perform the following preparations:

1. Check your system.

The system requirements for the ScanSnap are as follows:

■ Operating system

One of the following operating systems is required:

- Windows 2000
- Windows XP
- Windows Vista

	Windows 2000	Windows XP	Windows Vista
ScanSnap Manager	✓	✓*1	✓*4
ScanSnap Organizer	✓	✓*1	✓*4
CardMinder	✓	✓*1	✓
Adobe Acrobat	✓*3	✓*2	-
ABBYY FineReader for ScanSnap	✓	✓*1	✓

*1: Service Pack 1 or later must be applied

*2: Service Pack 2 or later must be applied

*3: Service Pack 4 or later must be applied

*4: Search and password functions are based on those of Adobe Acrobat, and, therefore, not guaranteed to work in Windows Vista.

■ Personal computer

- Intel® Pentium® 4 1.8 GHz or higher
- CD-ROM drive (used for installation)
- USB port (USB 2.0/1.1)

■ **RAM**

For Windows 2000 and Windows XP:

256 MB or more (512 MB or more is recommended when you scan documents while selecting "Excellent" in the "Image quality" drop down list.)

For Windows Vista:

512 MB or more

■ **Free disk space**

- ScanSnap Manager 280 MB
- ScanSnap Organizer 320 MB
- CardMinder 120 MB
- Adobe Acrobat 670 MB
(plus 270 MB for file cache at installation)
- ABBYY FineReader for ScanSnap 270 MB



- The ScanSnap may not function if it is connected to the USB port on the keyboard or the monitor.
- If you are using a commercially available USB hub, use a type equipped with an AC adapter.
- To connect the ScanSnap with USB 2.0, it is required that the USB port and the hub be compliant with USB 2.0. When you connect the ScanSnap with USB 1.1 port, scanning speed may slow down. Therefore, use the USB 2.0 compatible one if your computer has the USB 2.0 compatible port.
- If the CPU and memory do not meet the required specifications, scanning speed will slow down.



2. Make sure that the ScanSnap is not yet connected to your personal computer.
3. Start up your personal computer.
Log on as a user with "Administrator" privileges (computer administrator privileges when using Microsoft Windows XP Home Edition operation system).
4. Exit all programs and close all windows.

■ Installing Adobe Acrobat

Install Adobe Acrobat using the following procedure from the "Adobe Acrobat 7.0 CD-ROM" supplied with the ScanSnap.



Adobe Acrobat can be used on the following operating systems:

- Windows 2000 (Service Pack 4 or later)
- Windows XP (Service Pack 2 or later)

Other requirements:

- Internet Explorer 6.05 or later
- Screen Resolution: 1024 x 768 or higher



Adobe Acrobat is required for viewing the "ScanSnap S510 Operator's Guide," "ScanSnap Organizer User's Guide," and "CardMinder User's Guide." Adobe Acrobat can also be linked to the ScanSnap for displaying the scanned images in Adobe Acrobat.

* You do not have to install Adobe Acrobat if it is already installed on your personal computer.

⇒ Proceed to "Installing ABBYY FineReader for ScanSnap" on page 10.



Prepare the Adobe Acrobat 8.0 CD.

1. Insert the supplied "Adobe Acrobat CD" into the CD-ROM drive.

⇒ The CD-ROM is automatically recognized and the "Adobe Acrobat 8 Standard" window appears.



This window is not displayed automatically when the "Auto play" setting of your computer is deactivated. In this case, run "AutoPlay.exe" of this CD directly using the "Explore" or "My computer."



- 2. Click on the folder icon.

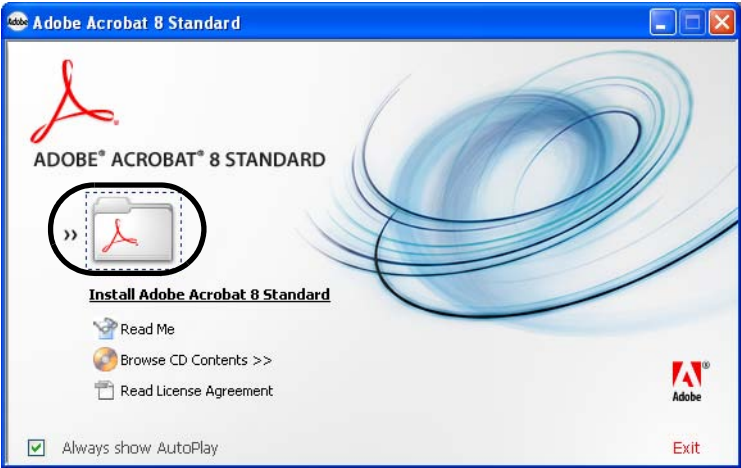

- 3. Click the [Next] button.



⇒ Installation is started and the setup dialog box appears.

- 4. Follow the on-screen instructions to install the software.

 Select "How to install" on the "Adobe Acrobat" dialog box (step 2) to learn more about the installation of Adobe Acrobat.
Refer to "Adobe Acrobat Help" about how to use Adobe Acrobat.

■ Installing ABBYY FineReader for ScanSnap

Install ABBYY FineReader for ScanSnap by using the following procedure from the "ABBYY FineReader CD" supplied with the ScanSnap.



Prepare the ABBYY FineReader CD.

1. Insert the "ABBYY FineReader CD" into the CD-ROM drive.

⇒ The "ABBYY FineReader for ScanSnap" screen appears.



- If Windows XP Service Pack 2 is installed in your computer, you may see the following dialog box when inserting the CD described above. Click the [Yes] button to show the "ABBYY FineReader for ScanSnap" screen.

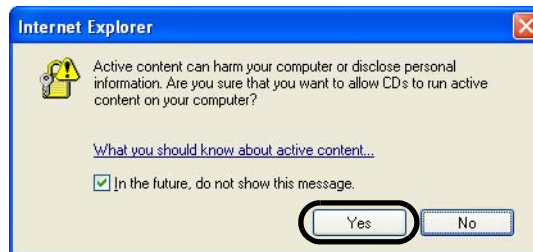

If the "In the future, do not show this message." checkbox is marked, you will not see this dialog box when inserting a CD that attempts to connect to Microsoft Internet Explorer in the future.

- You may see [Information Bar] instead of the message above. If so, first, click the [OK] button and then the yellow part with a warning for options. Next, select [Allow Blocked Content] from the menu.

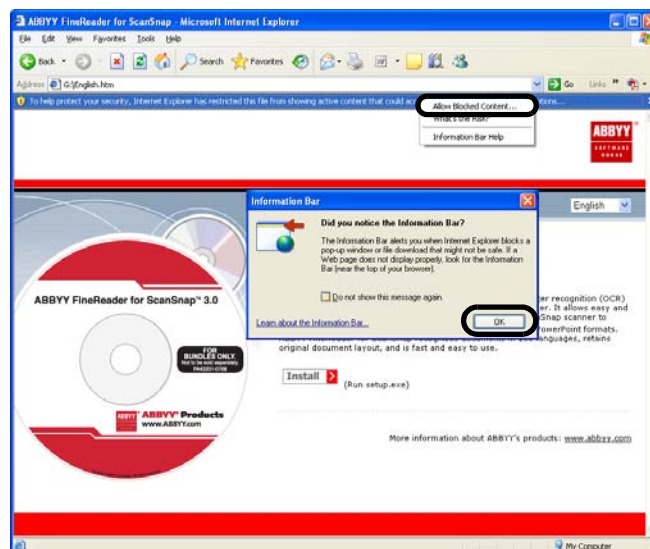

Finally, click the [Yes] button on the "Security Warning" dialog to proceed.

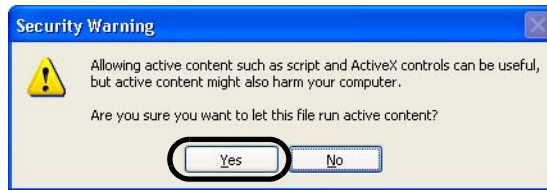

2. Click [Install>] to proceed with installation.

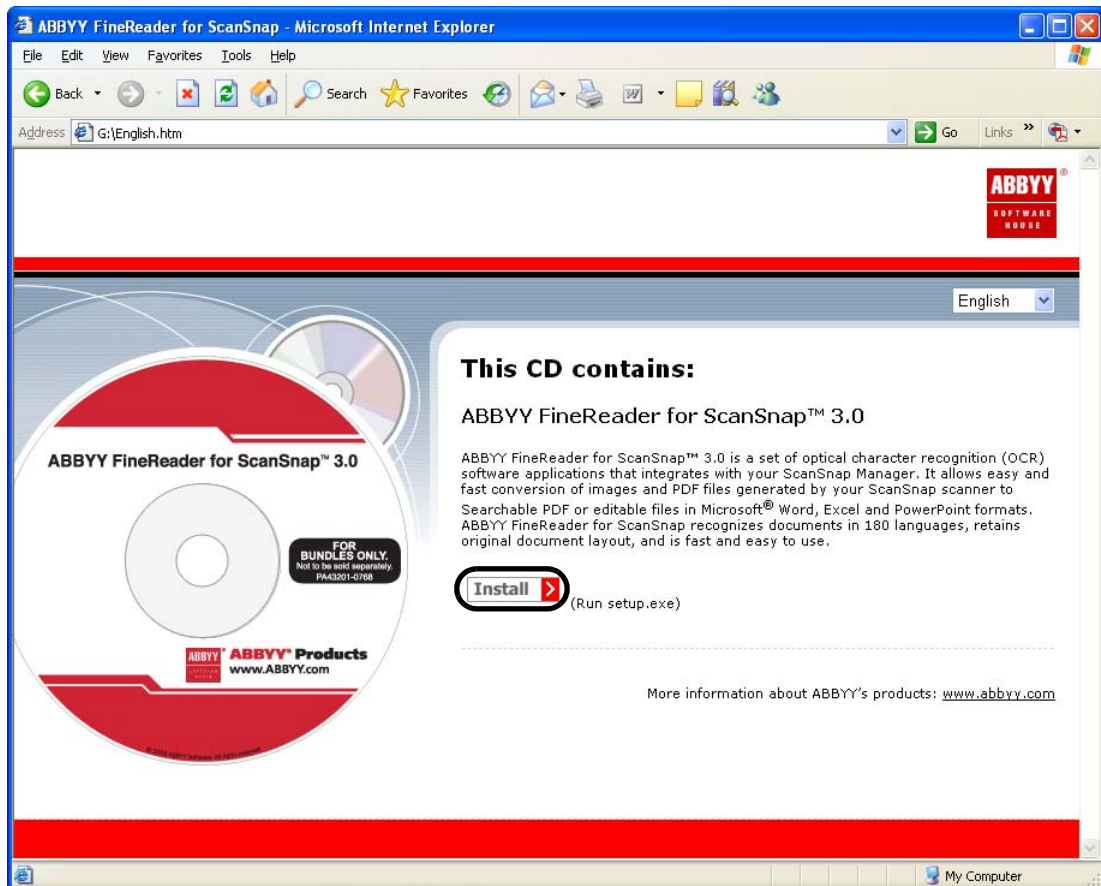

⇒ The file folder containing the setup.exe file appears.

3. Double-click the [Setup.exe] icon.

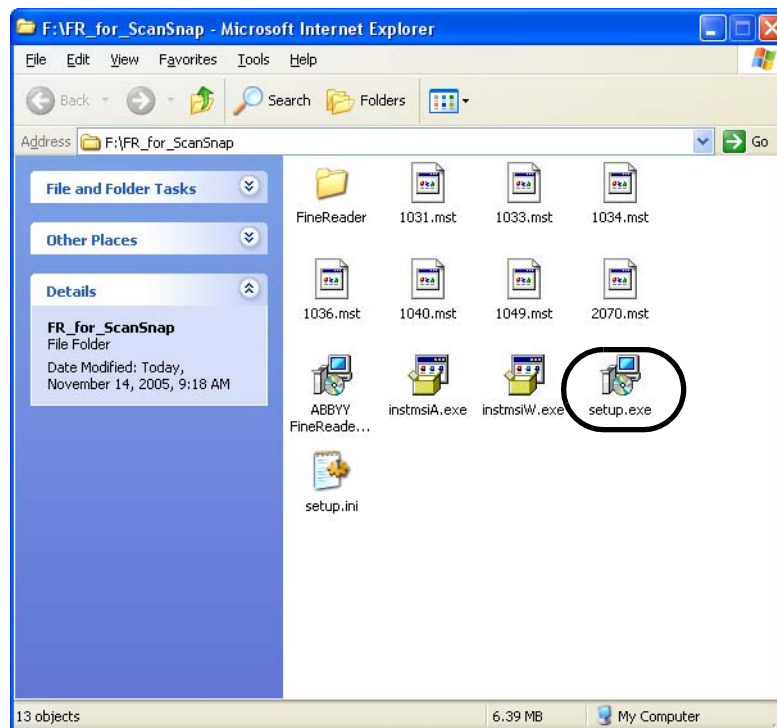

4. Select the language for this installation and click [OK].



⇒ The InstallShield Wizard for ABBYY FineReader for ScanSnap appears.

⇒ Follow the on-screen instructions to install the software.

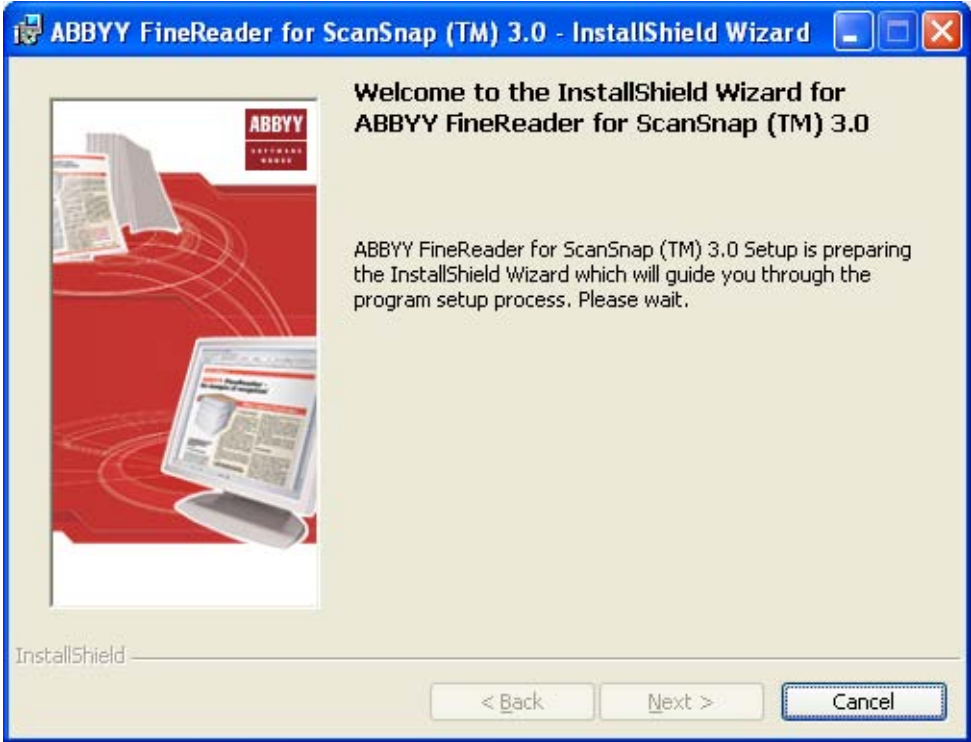

For information about how to use ABBYY FineReader for ScanSnap, refer to "ABBY FineReader for ScanSnap User's Guide."

Select [Start] ⇒ [All Programs] ⇒ [ABBY FineReader for ScanSnap™ 3.0] ⇒ [User's Guide].

■ Installing Supplied Programs

Install the supplied programs from the "ScanSnap Setup CD-ROM" that comes with this scanner. They are:

- ScanSnap Manager
- ScanSnap Organizer
- CardMinder

<Installing ScanSnap Manager, ScanSnap Organizer, and CardMinder>

Following the procedure below, install ScanSnap Manger, ScanSnap Organizer, and CardMinder.



1. Insert the "ScanSnap Setup CD-ROM" into the CD-ROM drive.

⇒ The "ScanSnap Installer" starts up, and the "ScanSnap Setup" dialog box appears.



- (1) You can read important information on installation and uninstallation as well as how the contents of the Setup CD-ROM are organized.
- (2) You can install or uninstall ScanSnap Manager, ScanSnap Organizer, and CardMinder.
- (3) You can read manuals.

Click the following buttons to view each of the respective manuals.

[ScanSnap Manager] button: displays "ScanSnap Operator's Guide (this manual)"

[ScanSnap Organizer] button: displays "ScanSnap Organizer User's Guide" that explains how to use ScanSnap Organizer.

[CardMinder] button: displays "CardMinder User's Guide" that explains how to use CardMinder.

- (4) You can view the contents of the "Setup CD-ROM."
* If you log on to Windows Vista as a standard user, this button is not available. Use Explore to view the contents of the "Setup CD-ROM."
- (5) You can visit our website and view information about support to this product. In the displayed window, click the URL, <http://scansnap.fujitsu.com>. (You must have an Internet connection.)
- (6) You can close this window.



If the "ScanSnap Setup" dialog box is not displayed even when the Setup CD is inserted into the CD-ROM drive, find "Setup.exe" in the CD-ROM drive by using Explore, and then double-click the "Setup.exe" icon.

2. Click the [Readme] button in the "ScanSnap Setup" dialog box.



- ⇒ In the Readme file, things to keep in mind when you install/uninstall programs and how the Setup CD-ROM is configured are described.
Close the Readme file when you finish reading it.

3. Click the [Install Products] button in the "ScanSnap Setup" dialog box.
Clicking the [Install Products] button installs ScanSnap Manager, ScanSnap Organizer, and CardMinder.



⇒ The "Welcome to the InstallShield Wizard for ScanSnap" dialog box appears.

4. Click the [Next] button in the "Welcome to the InstallShield Wizard for the ScanSnap" dialog box.

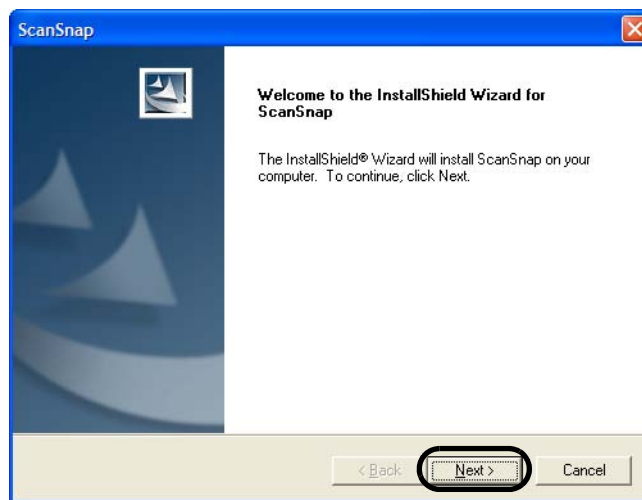

⇒ The "License Agreement" dialog box is displayed.

- 5. Read the full text of the "License Agreement." If you agree to the terms of this license, select "I accept the terms of the license agreement" and click the [Next] button.



⇒ The "Choose Destination Location" dialog box is displayed.

- 6. In the "Choose Destination Location" dialog box, choose the destination folder and click the [Next] button.

To install ScanSnap programs in the default folder, simply click the [Next] button. In most cases, you do not have to change the directory path. When the selected drive does not have enough free disk space, change the directory path. When changing the directory path, click the [Browse] button and display the "Select Directory" dialog box; select the folder to install ScanSnap programs.

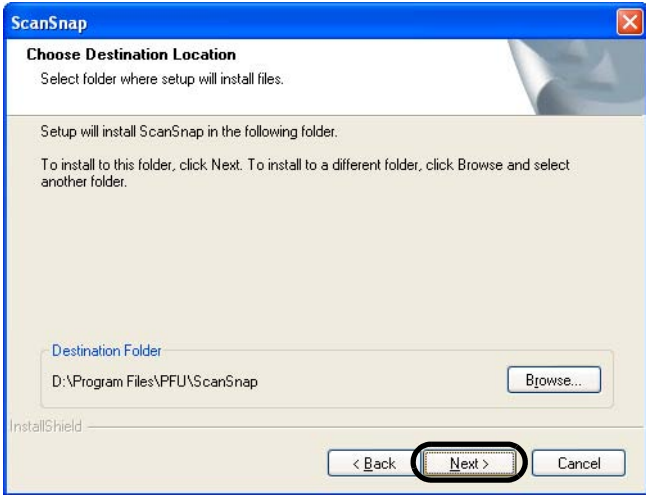

⇒ The "Setup Type" dialog box is displayed.

7. Select "Typical," "Compact," or "Custom" from options and click the [Next] button.
Select [Typical] for ordinary use.

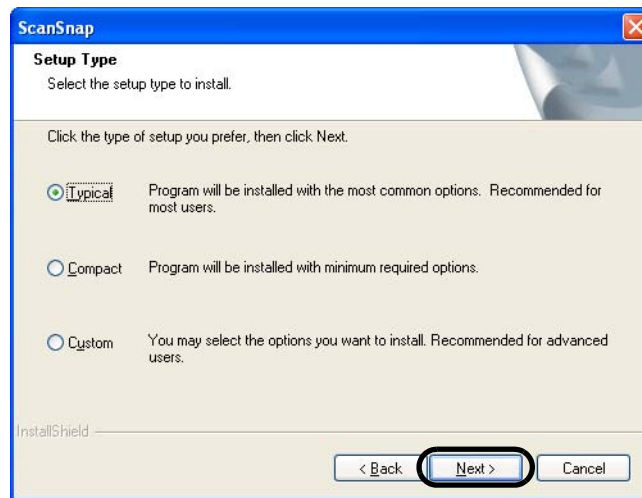

⇒ Clicking the [Next] button displays the "ScanSnap Manager Setting 1" dialog box.



Depending on the selected options, programs are installed as follows:

- Typical
ScanSnap Manager, ScanSnap Organizer, and CardMinder are installed along with the manuals for these programs.
- Compact
ScanSnap Manager is installed along with its manual.
- Custom
Only the programs of your choice and the manuals of them are installed.

8. In the "ScanSnap Manager Setting 1" dialog box, specify the method of loading the document, and then click the [Next] button.

When you want to set the document upside down and face down on the ScanSnap, select the left radio button.

When you want to set the document face up on the ScanSnap, check the right radio button.

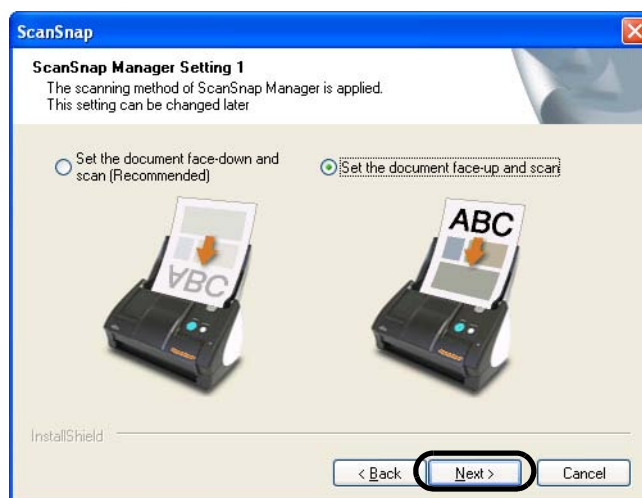

⇒ Next, the "ScanSnap Manager Setting 2" dialog box appears.

HINT 

- You can also change the setting after installation. For details, refer to "- Set the documents with its face up (page 82)" in section "4.2 Changing Scanning Settings."
- This dialog box will not appear when programs are re-installed. The settings configured before re-installation remain effective.

9. In the "ScanSnap Manager Setting 2" dialog box, if you want to receive notification about the scanning result, mark the "Notify scanning result" checkbox, and then click the [Next] button.

If the checkbox is marked, the message appears after scanning to inform you whether blank pages are automatically removed or whether images are automatically rotated.

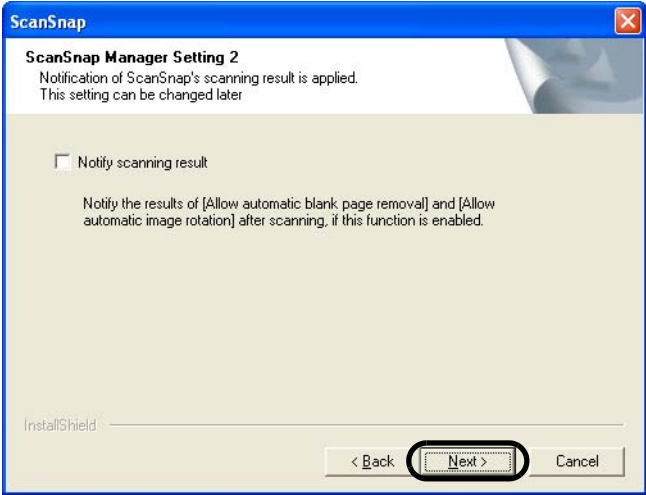

⇒ Clicking the [Next] button displays the "Start Copying Files" dialog box.

HINT 

- You can change this setting after installation. For details, refer to "Show scanning results" on page 65.
- The dialog box above will not appear when re-installing programs. The settings configured before the re-installation remain effective.

10. In the "Start Copying Files" dialog box, check the files that will be installed and click the [Next] button.

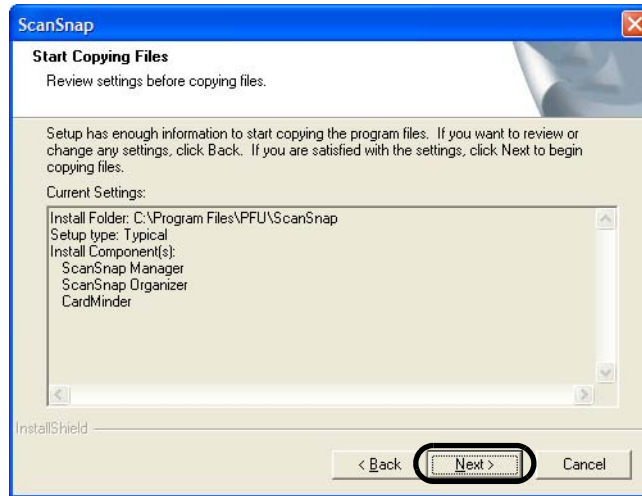

⇒ The installation is started. When the installation is complete, the "InstallShield Wizard Complete" dialog box will appear.

11. In the "InstallShield Wizard Complete" dialog box, click the [Finish] button.

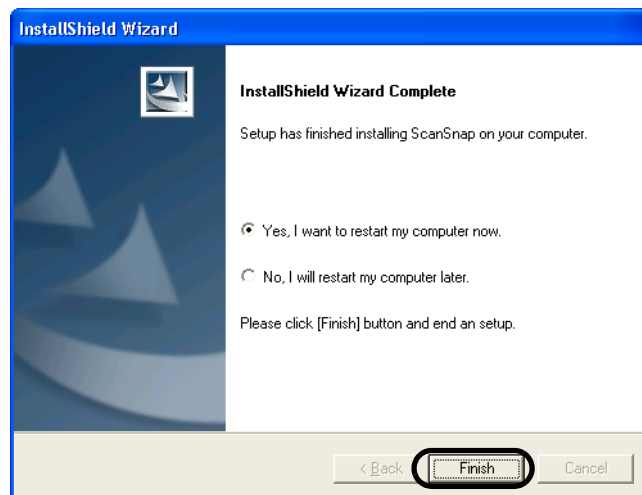

⇒ Select "Yes, I want to restart my computer now" to restart your personal computer.
⇒ Select "No, I will restart my computer later." to finish the installation. The "ScanSnap Setup" dialog box appears; click the [Exit] button to close the "ScanSnap Setup" dialog box.
(To complete the installation, you have to restart your personal computer.)



- To view the "ScanSnap S510 Operator's Guide," "ScanSnap Organizer User's Guide," and "CardMinder User's Guide," Adobe Acrobat or Adobe® Acrobat® Reader™ is required. If this software is not installed on the personal computer, install Adobe Acrobat from the "Adobe Acrobat CD" supplied with the ScanSnap.
- For how to uninstall these programs, refer to "Appendix B Uninstalling ScanSnap" on page 253.

2.2 Connecting the ScanSnap to your PC

Follow the procedure below to connect the ScanSnap to your personal computer.

1. Connect the ScanSnap to a power outlet with the AC cable.
2. Connect the ScanSnap to your personal computer with the USB cable.



- Be sure to connect the AC cable to an outlet before connecting the USB cable.
- Be sure to install ScanSnap Manager into your personal computer before connecting the ScanSnap to your personal computer. (For details about the installation, refer to "Installing the Supplied Programs (page 6)").



The following describes each of the above two procedures.

■ Connecting the Power Cable

Connect the AC cable and adapter as shown below.



Do not use AC adapters other than the following.

Manufacturer	AC-adapter model number
LEI	NU40-2160250-I3
SANKEN ELECTRIC CO., LTD	SEB55N2-16.0x (x= A-Z or Blank)



1. Connect the AC cable to the AC adapter (collectively called the power cable).

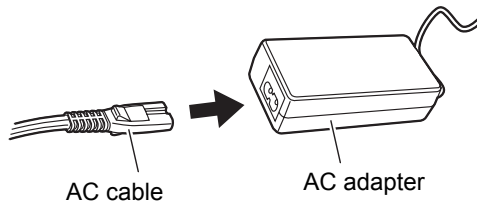

Use only the supplied AC cable and AC adapter (power cable).



-
2. Plug the power cable into the power connector on the back side of the ScanSnap, and the other end to a wall outlet.

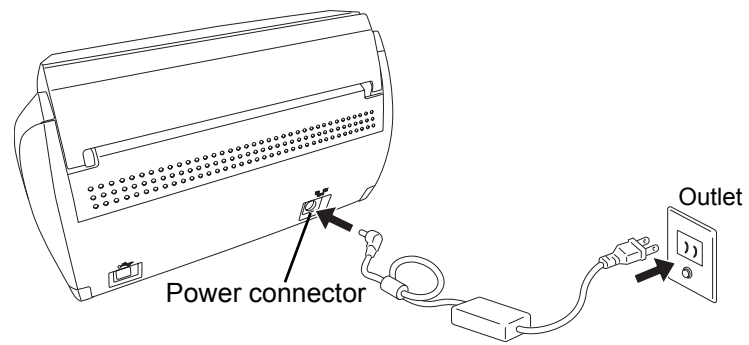

■ Connecting the USB Cable

Connect the USB cable as shown below.



- Use only the USB cable supplied with the Scanner.
- When connecting to a USB hub, be sure to connect the ScanSnap to the hub nearest your personal computer (first stage). If you connect it to a USB hub from the second stage onwards, the ScanSnap may not function correctly.
- If you connect the ScanSnap with USB 2.0, it is required that the USB port and the Hub be compliant with USB 2.0. The scanning speed may slow down when you connect the ScanSnap with USB 1.1. If your computer has the USB 2.0 compatible port, use it.



1. Remove the seal on the back side of the ScanSnap.

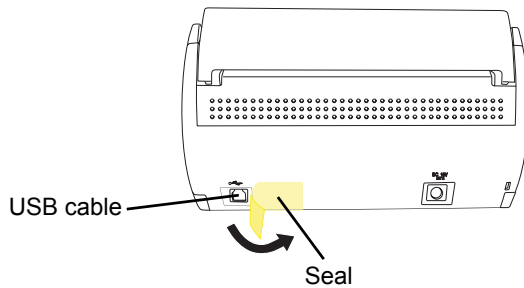

2. Connect the USB cable to the USB connector on the ScanSnap, and the other end of the USB cable into the USB port on your personal computer.

Insert the USB cable into the connector all the way to the end.

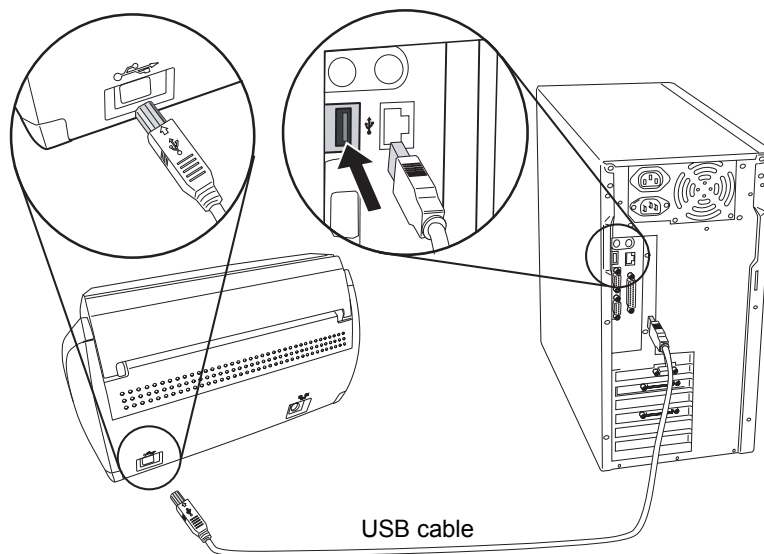

3. Open the paper chute of ScanSnap.

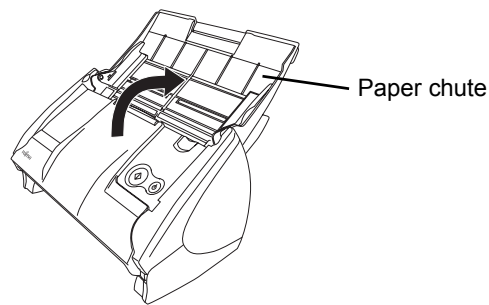

⇒ ScanSnap is automatically turned on and detected by your personal computer.



4. The ScanSnap is added as new hardware.

How to add hardware varies depending on the operating system running on your computer.

■ Windows 2000

The "Digital Signature Not Found" dialog box appears. Click the [Yes] button.



■ Windows XP

- 1) When the "Found New Hardware Wizard" dialog box appears, select "No, not this time," and then click the [Next] button.





The windows above will not appear unless Windows XP Service Pack 2 is installed.

- 2) Click the [Next] button in the following window.

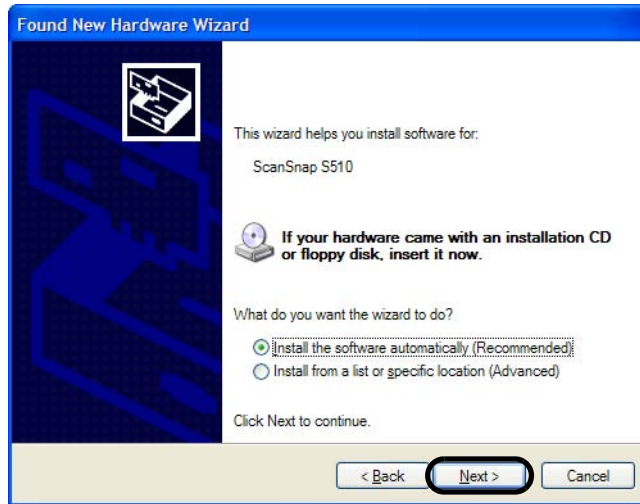

Although the message "If your hardware came with an installation CD or floppy disk, insert it now." is displayed, you do not have to insert the CD into the CD-ROM drive.

- 3) The "Hardware Installation" dialog box appears. Click the [Continue Anyway] button.



- 4) When the "Found New Hardware Wizard" dialog box informing you that the Wizard will end is displayed, click the [Finish] button.



⇒ The ScanSnap is added to your personal computer as new hardware.

■ Windows Vista

- 1) The "Found New Hardware" dialog box appears; select "Locate and install driver software (recommended)" in the dialog box.

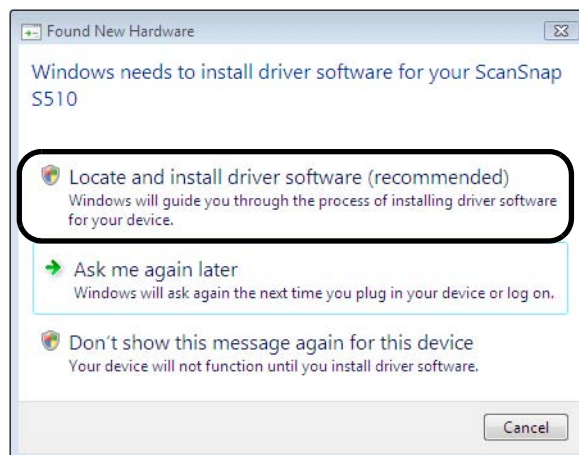

- 2) The "User Account Control" dialog box appears; click the [continue] button.

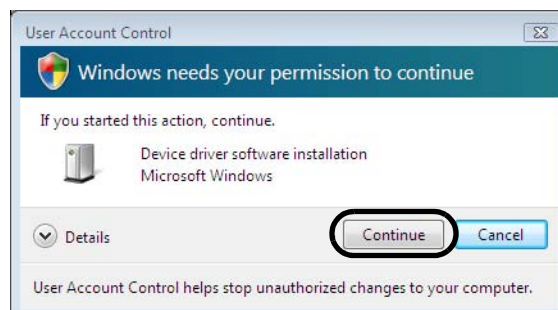

- 3) The "Windows Security" message appears; select "Install this driver software anyway."

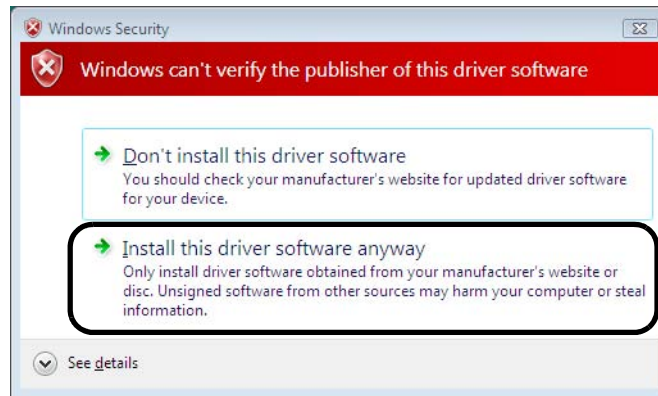

⇒ The ScanSnap is added as a new hardware device.



It may take some time for the ScanSnap Manager icon on the task bar to become the ready **S** status. Press the [POWER] button on the ScanSnap when the icon appears in not-ready **⊖** status. When you turn on/off the ScanSnap, wait for five seconds.



To turn on/off the ScanSnap, press the [POWER] button for longer than one second.
 * To prevent unintended operation, the [POWER] button does not work unless it is pressed for longer than one second.

The ScanSnap is turned on/off when:

- the paper chute on the ScanSnap is opened/closed.
 - the personal computer connected to the ScanSnap is turned on/off.
 - the [POWER] button on the scanner is pressed (with the paper chute open).
- However, power on/off of the ScanSnap is controlled by opening and closing the paper chute, and therefore, the ScanSnap will not be turned on unless the paper chute is open, even if the personal computer is turned on.

Leave the ScanSnap connected to the personal computer, and you can turn on/off the ScanSnap simply by opening/closing the paper chute when necessary.



Chapter 3



Using the ScanSnap

This chapter describes the basic operations of the ScanSnap.

3.1 Flow of Operations	30
3.2 Paper Size of Documents to be Scanned	46
3.3 Loading Documents	49

3.1 Flow of Operations



This section describes the flow of operations starting with the scanning of documents on the ScanSnap to the saving of scanned images in PDF format.

■ Basic Flow of Operations

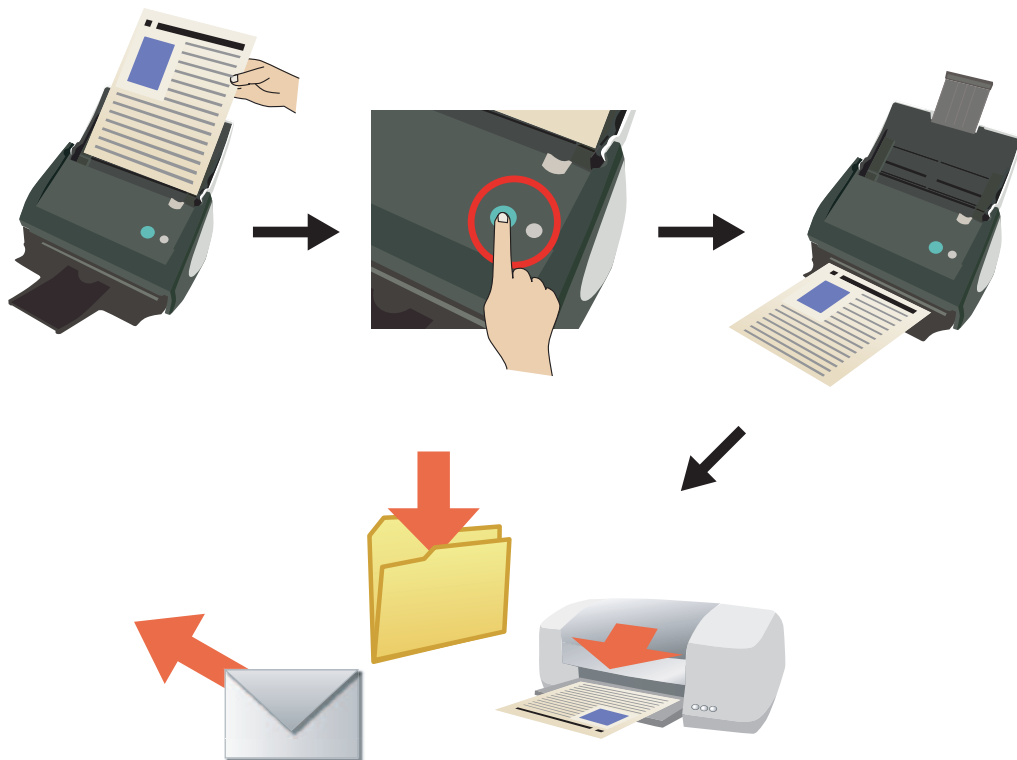
With the document loaded on the ScanSnap, simply press the [SCAN] button, and you can save the scanned documents to files, attach them to e-mail, and print them with the printer.



The ScanSnap has two buttons as follows:

	Simply press this button to scan the document.
	To turn on/off the ScanSnap, press this button.

With the [SCAN] button  , you can scan documents in two different ways. Perform a scan in a way that suits the preferences of you.

- (1) Select an action you want to perform in the ScanSnap Quick Menu after scanning.
- (2) Select an application or a profile before scanning.

Use either way according to your preferences.

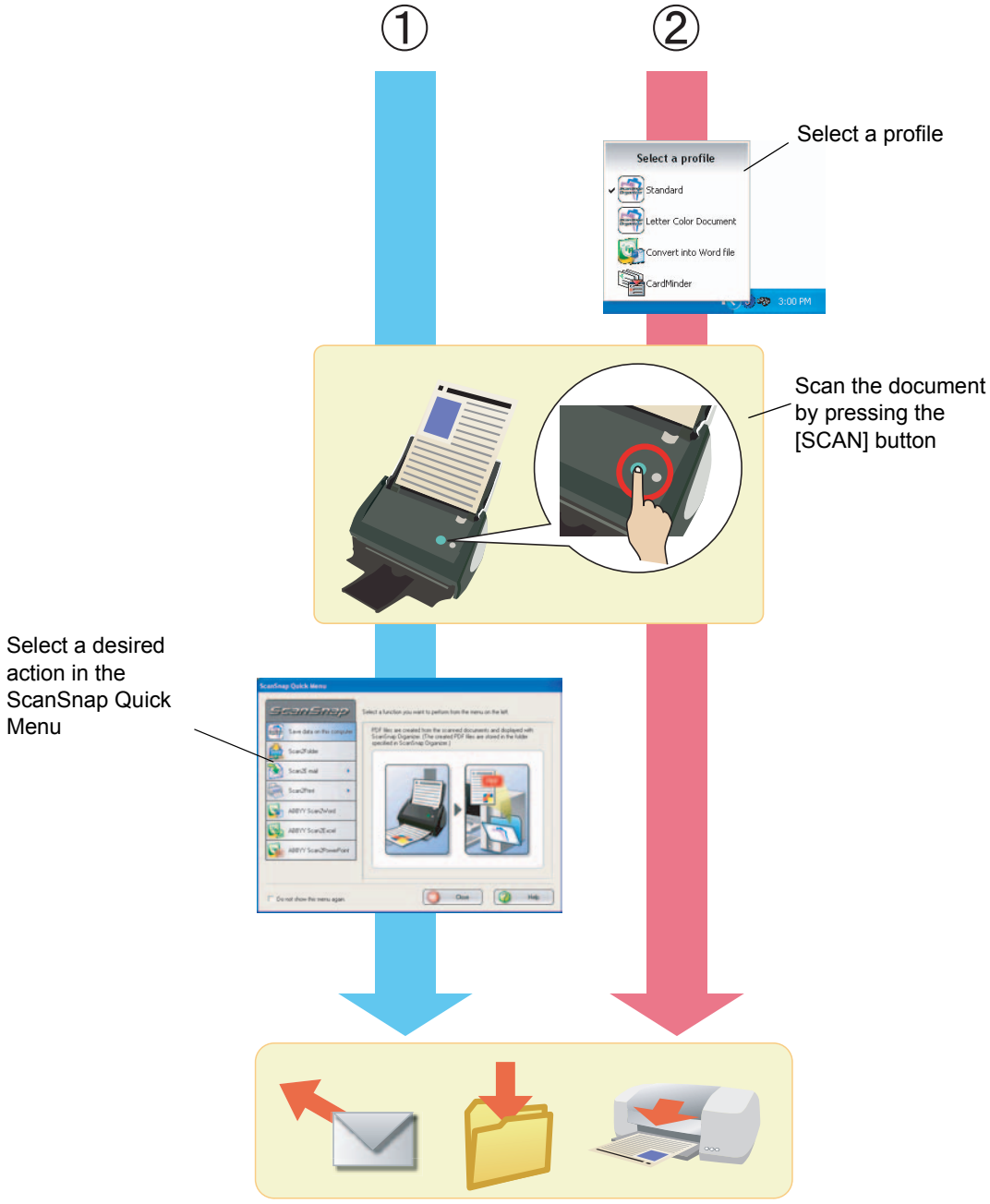



You can switch between the above two modes by checking and unchecking [Use ScanSnap Quick Menu] in the Right-Click Menu, which pops up when the ScanSnap Manager icon () on the task bar is right-clicked. For details, refer to "Use Quick Menu" (page 65).

1. The way that you select an action after scanning in the menu.
<Quick Menu Mode>

1) Press the [SCAN] button to scan the document.



2) The ScanSnap Quick Menu appears after scanning.



3) Select a desirable action in the ScanSnap Quick Menu.

⇒ An application starts up for you to perform the selected action.



The Quick Menu Mode has the following features:

- You can perform a desirable action with point and click operations by using the menu simple enough for beginners.
- This way of scanning is suitable when you want to perform various actions after scanning. You do not have to specify an application in advance.

2. The way that you scan the document by using a specific application (profile).
<Left-Click Menu Mode>

1) On the Left-Click Menu, select a desirable application (profile).



2) Press the [SCAN] button to scan the document.

⇒ The selected application starts up for you to perform the selected action.





The Left-Click Menu Mode has the following features:

- You can scan the document at the press of a button.
- This way of scanning is suitable when you want to scan the document by using a profile you have configured in advance.
- You can add profiles modified to suit the needs or preferences of you.



The following gives you detailed descriptions of a series of operations.

For the combination of  ([SCAN] button) and <ScanSnap Quick Menu Mode>, see "Scanning documents in Quick Menu Mode" on page 35.

For the combination of  ([SCAN] button) and <Left-Click Menu Mode>, see "Scanning documents in Left-Click Menu Mode" on page 40.

■ Preparation



1. Make sure that the Power cable is connected to the ScanSnap.
2. Make sure that the ScanSnap is connected to your personal computer properly.

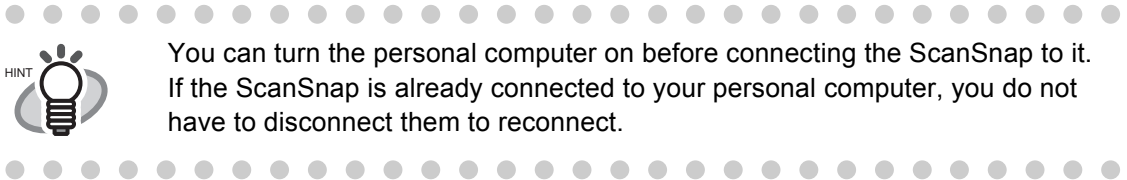

You can turn the personal computer on before connecting the ScanSnap to it. If the ScanSnap is already connected to your personal computer, you do not have to disconnect them to reconnect.

3. Turn on your personal computer.

⇒ The ScanSnap Manager icon appears on the task bar when Windows starts.

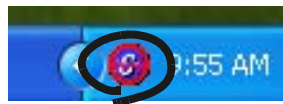

4. Open the paper chute.

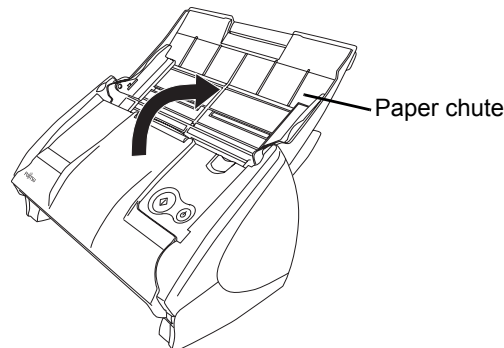

⇒ The ScanSnap is turned on and the ScanSnap Manager icon will change from  to .

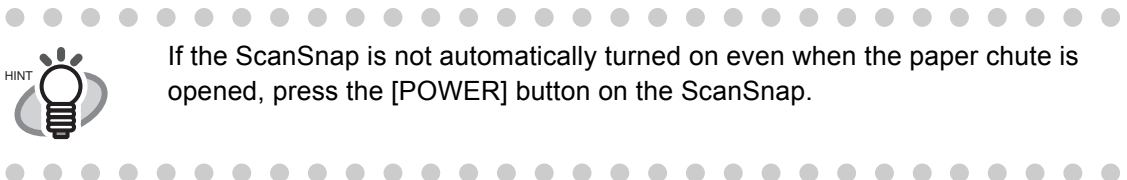

If the ScanSnap is not automatically turned on even when the paper chute is opened, press the [POWER] button on the ScanSnap.

■ Scanning documents in Quick Menu Mode



- 1. Check for the ScanSnap Manager icon on the task bar as shown below.



If the ScanSnap Manager icon is not displayed on the task bar, from the [Start] menu, select [All Programs] ⇒ [ScanSnap Manager] ⇒ [ScanSnap Manager] to start up ScanSnap Manager. Generally, ScanSnap Manager is registered under "Startup" programs, so that its icon is displayed on the task bar when Windows starts. If it is not registered under "Startup" programs, from [Start] menu, select [All Programs] ⇒ [ScanSnap Manager] ⇒ [Startup Register] to register it.

- 2. Check that [Use ScanSnap Quick Menu] is marked in the menu that pops up when the ScanSnap Manager icon is right-clicked.

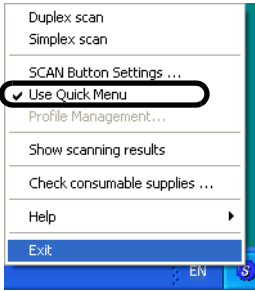

If [Use ScanSnap Quick Menu] is not marked, scanning is performed in Left-Click Menu Mode. For how to scan the document in the Left-Click Menu Mode, refer to "Scanning documents in Left-Click Menu Mode" (page 40).



- 3. Load the document onto the ScanSnap.
Refer to "3.2 Paper Size of Documents to be Scanned" (page 46) and "3.3 Loading Documents" (page 49) for more information.

4. Press the [SCAN] button  on the ScanSnap.

⇒ The scanning is started.



- By default, documents are scanned in "Duplex" mode when you press the [SCAN] button. In the "ScanSnap Manager - Scan and Save Settings" dialog box, you can switch the scanning mode of the [SCAN] button to "Simplex" mode.
- Scanning can also be started by using the ScanSnap Manager icon  on the task bar.
For details about this operation, refer to "4.1 About the ScanSnap Icon" (page 64).



- Do not connect or disconnect other USB devices during the scanning operation.
- Do not close the paper chute during the scanning operation.
- Do not switch the user to log in during the scanning operation. Otherwise, the scanning is canceled.

⇒ The power indicator (lamp)  on the ScanSnap blinks blue during the scanning operation.
The following window appears to indicate the scanning status.

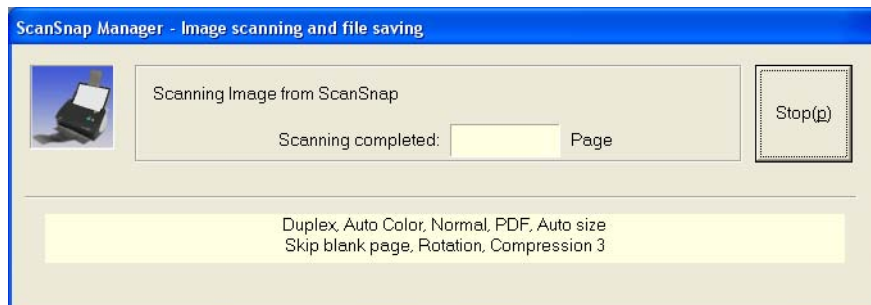

⇒ When the scanning is complete, the ScanSnap Quick Menu appears.



- Select an action you want to perform in the Action List on the left side of the ScanSnap Quick Menu.

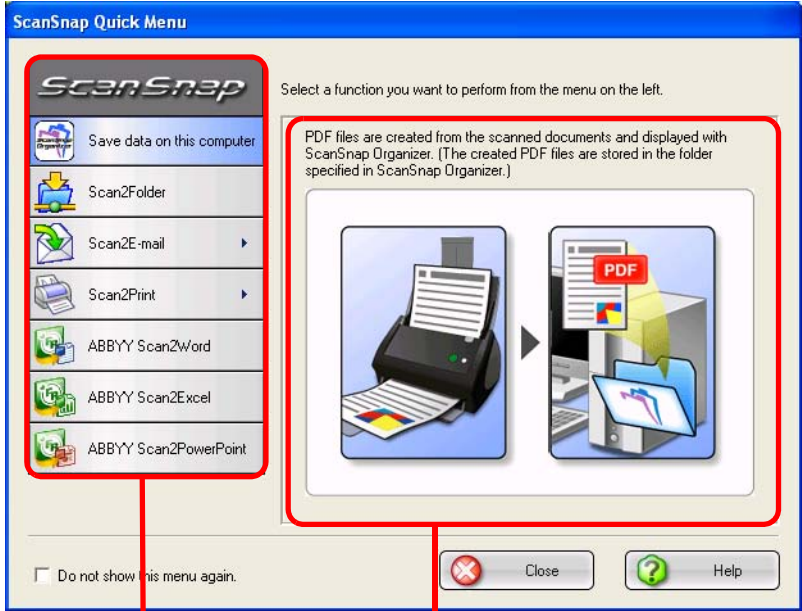

Action List

Descriptions of the selected action

Action List

Action	Description
Save data on this computer *1	PDF files are created from the scanned images, and ScanSnap Organizer is started to display the scanned images. Those files are saved in a folder (on your personal computer) specified in ScanSnap Organizer.
Scan2Folder	PDF files are created from the scanned images and saved in a specified folder (shared folder). ⇒ "5.2 Saving Data in the Specified Folder" (page 117)
Scan2E-mail	PDF files are created from the scanned images and an e-mail program is started with the PDF files attached to e-mail. ⇒ "5.3 Sending Files by E-Mail" (page 129)
Scan2Print	Scanned images are printed with a printer. ⇒ "5.4 Using the ScanSnap as a Copy Machine" (page 145)

ABBYY Scan2Word *2	The scanned images are processed through OCR and converted into Word files. ⇒ "5.5 Converting into Word / Excel / PowerPoint Files" (page 155)
ABBYY Scan2Excel *2	The scanned images are processed through OCR and converted into Excel files. ⇒ "5.5 Converting into Word / Excel / PowerPoint Files" (page 155)
ABBYY Scan2PowerPoint *2	The scanned images are processed through OCR and converted into PowerPoint files. "5.5 Converting into Word / Excel / PowerPoint Files" (page 155)

*1: This Action button does not appear unless ScanSnap Organizer is installed.

*2: This Action button does not appear unless ABBYY FineReader for ScanSnap 3.0 is installed.

⇒ An application corresponding to the selected action starts up to perform the selected action. (If you perform "Save data on this computer," PDF files are created based on the scanned documents and stored in a folder specified in ScanSnap Organizer. Then, ScanSnap Organizer starts up to display the stored images.)

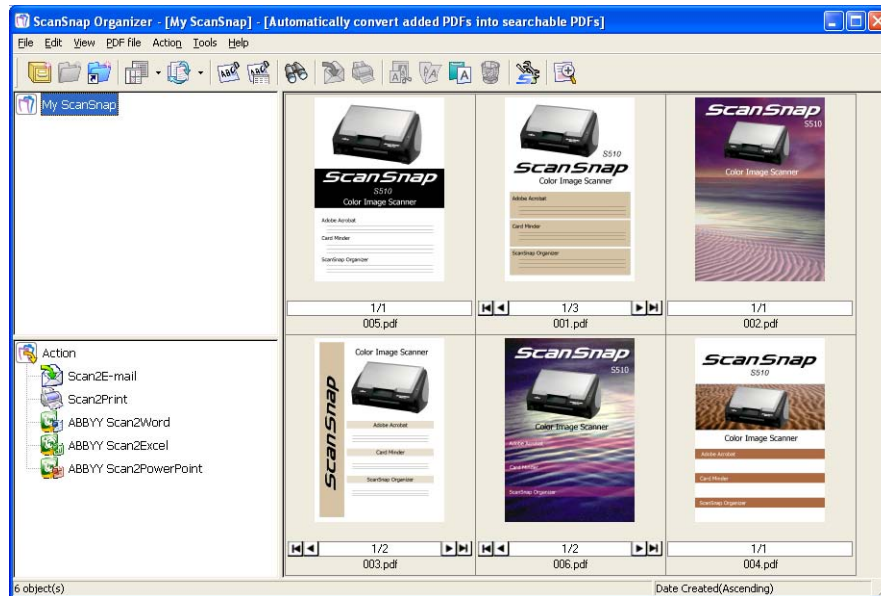

For details about the settings for the scanning, file name, and destination to save data, refer to "4.2 Changing Scanning Settings" (page 67).

About the scanning of Business cards, refer to section "6.4 Using ScanSnap Organizer" (page 208).



- By default, documents are scanned using the settings below.
 - Image quality: Normal
 - Color mode: Auto Color Detection
- Before scanning documents of printed or handwritten text, mark the "Setting for text only document" checkbox. In the ScanSnap Manager - Scan and Save Settings" dialog box, select the [Scanning] tab, and then the [Option] button to display the "Read mode option" dialog box in which you can enable the above function. For details, refer to section "4.2 Changing Scanning Settings" (page 67).
- In the Quick Menu Mode, scanned images cannot be saved in JPEG format. To save images in JPEG format, use the Left-Click Menu Mode. For information about how to scan in the Left-Click Menu Mode, refer to "3.1 Flow of Operations" (page 40).
- For details about changing the document scan settings, refer to section "4.2 Changing Scanning Settings" (page 67). In the "ScanSnap Manager - Scan and Save Settings" dialog box, you can change the following settings:
 - Folder in which scanned images are saved
 - File name of scanned images
 - Scanning mode (whether to perform fast scanning or excellent scanning, whether to produce sharp text images, whether to automatically remove blank pages, correct skewed images, change orientation of pages, load the document face up, and continue scanning another document)
 - Whether to text recognize the scanned document to make PDF files searchable
 - Whether to include all scanned pages in a PDF file or create PDF files, each of which includes a preset number of pages
 - Paper size of documents to be scanned
 - File size of scanned images (compression rate)
 Scanned images may be scaled in some degree.
- When ScanSnap Organizer and/or CardMinder is running and one of these applications becomes active, the ScanSnap automatically interacts with the active application. Scanned document images are opened with the active application. Interaction is disabled when the application becomes inactive or when it is closed.

For details on the automatic interaction, refer to section "4.6 About Automatic Interaction with Applications" (page 111).



- When the ScanSnap Quick Menu is displayed, the ScanSnap does not work even if you press the [SCAN] button. Select one of actions in the menu and complete the action before scanning another document.
- Do not move, delete, rename files in other applications when the ScanSnap Quick Menu is displayed.

■ Scanning documents in Left-Click Menu Mode



1. Check for the ScanSnap Manager icon on the task bar as shown below.



HINT

If the ScanSnap Manager icon is not present on the task bar, from the [Start] menu, select [All Programs] ⇒ [ScanSnap Manager] ⇒ [ScanSnap Manager] to start up ScanSnap Manager.

Generally, ScanSnap Manager is registered with "Startup," so that its icon appears on the task bar when Windows starts up. If ScanSnap Manager is not registered with "Startup," from the [Start] menu, select [All Programs] ⇒ [ScanSnap Manager] ⇒ [Startup Register] to register it.

2. Unmark [Use ScanSnap Quick Menu] in the menu that pops up when the ScanSnap Manager icon  is right-clicked.

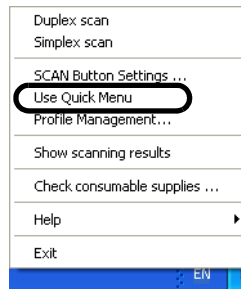

HINT

- When [Use ScanSnap Quick Menu] is marked, the document is scanned in Quick Menu Mode. For details about the Quick Menu Mode, refer to "3.1 Flow of Operations" (page 35).



3. Load the document onto the ScanSnap.
Refer to "3.2 Paper Size of Documents to be Scanned" (page 46) and "3.3 Loading Documents" (page 49) for more information.

4. Press the [SCAN] button  on the ScanSnap.

⇒ The scanning is started.



- By default, documents are scanned in "Duplex" mode when you press the [SCAN] button. In the "ScanSnap Manager - Scan and Save Settings" dialog box, you can switch the scanning mode of the [SCAN] button to "Simplex" mode.
- Scanning can also be started by using the ScanSnap Manager icon  on the task bar.
For details about this operation, refer to section "4.1 About the ScanSnap Icon" (page 64).



- Do not connect or disconnect other USB devices during the scanning operation.
- Do not close the paper chute during the scanning operation.
- Do not switch the user to log in during the scanning operation.



⇒ The power indicator (lamp)  on the ScanSnap blinks blue during the scanning operation. The following window appears to indicate the scanning status.

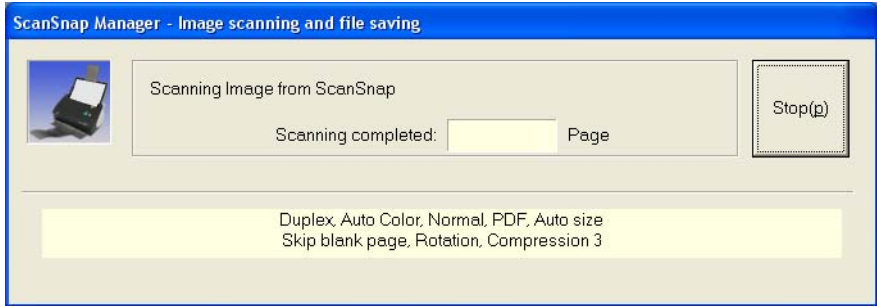

⇒ The supplied application (ScanSnap Organizer) becomes active, and you can view the scanned images.

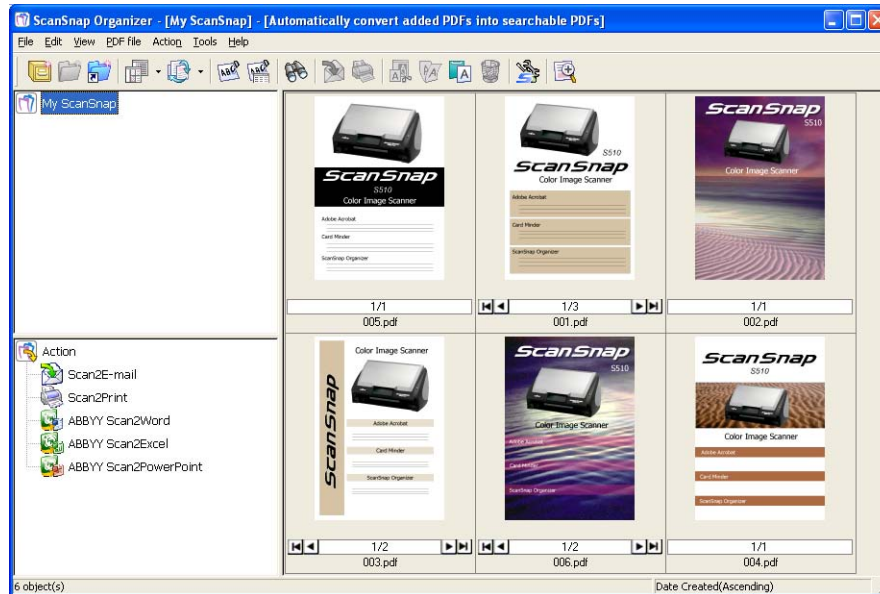

For details about the settings for the scanning, file name, and destination to save data, refer to section "4.2 Changing Scanning Settings" (page 67).

About the scanning of Business cards, refer to section "6.3 Scanning Business Cards" (page 202).



- By default, documents are scanned using the settings below.
 - Image quality: Normal
 - Color mode: Auto Color Detection
- Before scanning documents of printed or handwritten text, mark the "Setting for text only document" checkbox. In the "ScanSnap Manager - Scan and Save Settings" dialog box, select the [Scanning] tab, and then the [Option] button to display the "Read mode option" dialog box in which you can enable the above function. For details, refer to section "4.2 Changing Scanning Settings" (page 67).
- The application that starts up automatically after scanning is the one selected on the [Application] tab of the "ScanSnap Manager - Scan and Save Settings" dialog box. For details, refer to section "4.2 Changing Scanning Settings" (page 67).
- Scanned images can also be saved in JPEG format. To save images in JPEG format, change scanning settings beforehand. For information about scanning settings, refer to section "4.2 Changing Scanning Settings" (page 67).
- In the "ScanSnap Manager - Scan and Save Settings" dialog box, you can change the following settings:
 - Application that interacts with the ScanSnap.
 - Folder in which scanned images are saved
 - File name of scanned images
 - Scanning mode (whether to perform fast scanning or excellent scanning, whether to produce sharp text images, whether to automatically remove blank pages, correct skewed images, change orientation of pages, load the document face up, and continue scanning another document)
 - File format of scanned images (*.pdf/*.jpg)
 - Whether to text recognize the scanned document to make PDF files searchable
 - Whether to include all scanned pages in a PDF file or create PDF files, each of which includes a preset number of pages
 - Whether to password-protect the created PDF files
 - Whether to apply a digital signature/time-stamp
 - Paper size of images to be scanned
 - File size of scanned images (compression rate)

Scanned images may be scaled in some degree.
- In Adobe Acrobat, you can process scanned images (in PDF format) as follows. For details, refer to [Acrobat Help].
 - **Reduce PDF file size**
From the menu, select [File] - [Reduce File Size]
- When ScanSnap Organizer or CardMinder becomes active, the ScanSnap automatically interacts with the active application. While an application is interacting with the ScanSnap, the ScanSnap Quick Menu is disabled, and scanned images are stored in the active application. Scanned document images are opened with the active application. Interaction is disabled when the application becomes inactive or when it is closed.

■ Turning the ScanSnap On/Off

You can turn on/off the ScanSnap by doing either of the following:

- Turn on/off the personal computer.
- Open/close the paper chute of the ScanSnap.

The ScanSnap is turned on/off in conjunction with the personal computer connected. Therefore, you do not have to press the power button on the ScanSnap to turn it on/off.

- **When you turn off the personal computer or close the paper chute of the ScanSnap...**
⇒ The power indicator goes off and the ScanSnap is turned off.
- **When you turn on the personal computer or open the paper chute of the ScanSnap...**
⇒ The power indicator illuminates and the ScanSnap is turned on.

To turn off the ScanSnap with the paper chute open, press the [POWER] button on the ScanSnap.



To turn on/off the ScanSnap, press the [POWER] button for longer than one second.

* To prevent unintended operation, the [POWER] button does not work unless it is pressed for longer than one second.



Depending on specifications of your personal computer, the following symptoms may occur. Even so, the ScanSnap is not malfunctioning.

- The ScanSnap is initialized several times during startup.
- It may take 2 to 3 minutes until the power indicator goes off after the personal computer is turned off.

■ Finishing Scanner Operation

Exiting ScanSnap Manager



When you do not want ScanSnap Manager to stay resident on your computer, right-clicking the ScanSnap Manager icon  on the task bar, and select "Exit" in the Right-Click menu to exit ScanSnap Manager.



If you exit ScanSnap Manager, you can no longer use the ScanSnap. To activate ScanSnap Manager again, from the [Start] menu, select [All Programs] ⇒ [ScanSnap Manager] ⇒ [ScanSnap Manager].



Disconnecting the ScanSnap



1. Close the paper chute to turn off the ScanSnap.

⇒ The ScanSnap Manager icon on the task bar changes to the inactive state .

2. Disconnect the USB cable from your personal computer.
3. Disconnect the Power cable from the power outlet.



The ScanSnap is turned on/off in conjunction with the personal computer or opening/closing of the paper chute. Ordinarily, you can forget about turning on/off the ScanSnap being connected to the personal computer.



3.2 Paper Size of Documents to be Scanned

The ScanSnap can scan any paper size in the table below.

Without Using the Carrier Sheet	
Type	Standard office paper Post cards, Business cards
Weight	52 g/m ² to 127 g/m ² (14 lb to 34 lb)
Size	Letter (8.5 x 11 in. (216 x 279.4 [mm])) Legal (8.5 x 14 in. (216 x 355.6 [mm])) A4 (210 x 297 [mm]) A5 (148 x 210 [mm]) A6 (105 x 148 [mm]) B5 (JIS) (182 x 257 [mm]) B6 (JIS) (128 x 182 [mm]) Post card (100 x 148 [mm]) Business card (90 x 55 [mm], 55 x 90 [mm]) Custom Width: 50.8 to 216 [mm] (2 to 8.5 [in.]) Length: 50.8 to 360 [mm] (2 to 14.17 [in.])

With the Carrier Sheet	
Type	Standard office paper, Post card, Business card, Photograph, Clipping
Weight	Up to 127 g/m ² (Up to 34 lb) *when scanning half fold paper Up to 63.5 g/m ² (Up to 17 lb)
Size	A3 (297 x 420 [mm]) A4 (210 x 297 [mm]) A5 (148 x 210 [mm]) A6 (105 x 148 [mm]) B4 (JIS) (257 x 364 [mm]) B5 (JIS) (182 x 257 [mm]) B6 (JIS) (128 x 182 [mm]) Post card (100 x 148 [mm]) Business card (90 x 55 [mm], 55 x 90 [mm]) Letter (8.5 x 11 [in.] (216 x 279.4 [mm])) 11 x 17 (11 x 17 [in.] (279.4 x 431.8 [mm])) Custom Width: 50.8 to 216 [mm] (2 to 8.5 [in.]) Length: 50.8 to 297 [mm] (2 to 11.69 [in.]) *For B4, A3 and 11 x 17, fold in two when scanning



- Documents hand-written with a pencil may be smeared during a scan. It is recommended that the Carrier Sheet be used. If such documents are scanned without using the Carrier Sheet, the rollers of the ScanSnap get dirty and multi-feeding may be caused. In the case where you scan such documents without using Carrier Sheet, clean the rollers as often as possible. For details, refer to "8.2 Cleaning the Scanner Exterior" (page 231).
- Carbonless paper contains chemical substances that may damage the Pad ASSY and/or rollers such as the pick roller. When scanning documents of carbonless paper, keep in mind the following:
 - Clean the Pad ASSY and rollers as frequently as possible.
 - The service life of the ScanSnap may be shorter than you use woodfree paper.
- The pad and/or rollers of the ScanSnap could be damaged if photographs or sheets of paper affixed to the document come into contact with the pad and/or rollers during scanning.



Do not scan the following types of documents:

- Documents with paper clips and/or staples (Remove clips and staples to scan these documents.)
- Documents before ink goes dry (Scan documents after the ink goes dry)
- Documents larger than Legal (width: 8.5 in. length: 14 in.)
- Documents folded in half larger than 216 x 297 mm (W x L) (8.5 x 11.7 in.)
- Materials other than paper such as the fabric, metal foil, transparency, or plastic card.

If you scan the following types of documents without using the Carrier Sheet, the documents may be damaged or scanned incorrectly.

It is recommended that the documents be inserted inside the Carrier Sheet when you scan the documents described below with the ScanSnap.

- Documents smaller than 2 (width) x 2 (length) in.
- Documents thinner than 52 g/m² (14 lb) and thicker than 127 g/m² (34 lb)
- Documents of nonuniform thickness (e.g. envelopes and paper sheets with other paper sheets affixed)
- Wrinkled or curled documents
- Folded or torn documents
- Tracing paper
- Coated paper
- Photographs (printing paper)
- Perforated or punched documents
- Documents of not-square shaped paper
- Documents including different widths
- Carbonless paper
- Thermal paper
- Carbon paper
- Documents with photographs or sticky notes affixed

In addition, keep in mind the following points when you use the Carrier Sheet.



- Use the Carrier Sheet only for the ScanSnap.
- Avoid writing letters on, coloring, staining, or cutting the portion striped in black and white on the Carrier Sheet. Otherwise, the ScanSnap cannot scan the document with the Carrier Sheet correctly.
- Load the Carrier Sheet one by one on the ScanSnap.
- Do not place the Carrier Sheet upside-down on the ScanSnap. Otherwise, a paper jam may happen, or the Carrier Sheet may be damaged.
- Do not leave a document on the Carrier Sheet for an extended period of time. The ink on the document may be transferred onto the Carrier Sheet.
- Do not leave the Carrier Sheet in locations that are exposed to elevated temperatures; for example, locations exposed to direct sunlight or near a heating apparatus, for an extended period of time. Do not use the Carrier Sheet under high-temperature conditions. If used under such a condition, it may be deformed.
- Do not bend or pull the Carrier Sheet by force.
- Do not use a damaged Carrier Sheet. Otherwise, the ScanSnap may be damaged or may malfunction.
- To avoid the deformation of the Carrier Sheet, do not put anything heavy on it and keep it on a level surface when not in use.
- Be careful not to cut your fingers touching the edge of the Carrier Sheet.
- Do not insert more than one small-size material such as the picture and post card in the Carrier Sheet per scan. Otherwise, a paper jam may occur. It is recommended small-size materials be scanned one-by-one.
- If a paper jam occurs frequently, feed about 50 sheets of PPC paper or recycled paper, and then scan the document by using Carrier Sheet.
* You can use either unused or used PPC/recycled paper.



3.3 Loading Documents

This section describes how to load documents onto the ScanSnap.

How to load documents

1. Align the edges of the document.

Align the edges of the document as follows:

- 1) Straighten the edges of the document.
Straighten both edges of the document stack for scanning it correctly.
- 2) Check the number of sheets in the document stack.
The maximum number of sheets that can be loaded on the ScanSnap is as follows:
For A4-size paper or smaller, a document stack of 5 mm or less (50 sheets at 64 g/m² or at 17 lb).



Scanning accuracy increases when the document is loaded onto the ScanSnap so that the leading edges of the paper form a step-like pattern as shown in the figure.

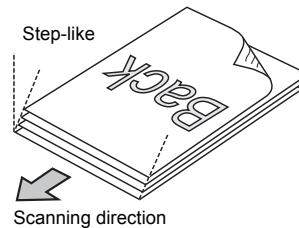

In the "ScanSnap Manager - Scan and Save Settings" dialog box, select the [Scanning] tab, and then click the [Option] button. In the "Read mode option" dialog box displayed, check whether the "Set the documents with its face up" checkbox is marked. If marked, load the document its face up and the bottom edge into ADF.

To prevent paper jams, fan the document as follows:

- 1) Extract the stack of documents of thickness 5 mm or less.
- 2) Hold the document with both hands and fan it out as shown in the figure below.

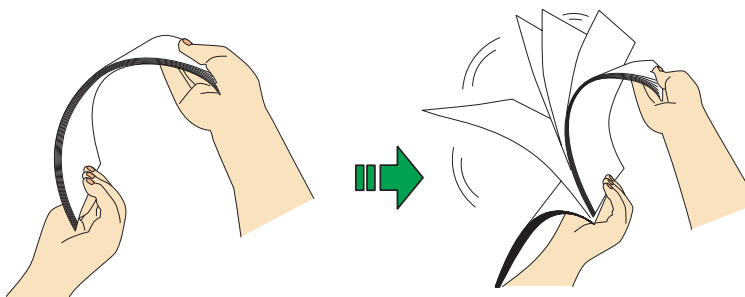

- 3) Turn the document 90 degrees, and then fan it in the different orientation again.

2. Load the document onto the paper chute.

Load the document so that the front side of the two-sided document (the first page when the document contains more than one sheet) faces the paper chute.
Do not load the document beyond the reference marks on the side guide.

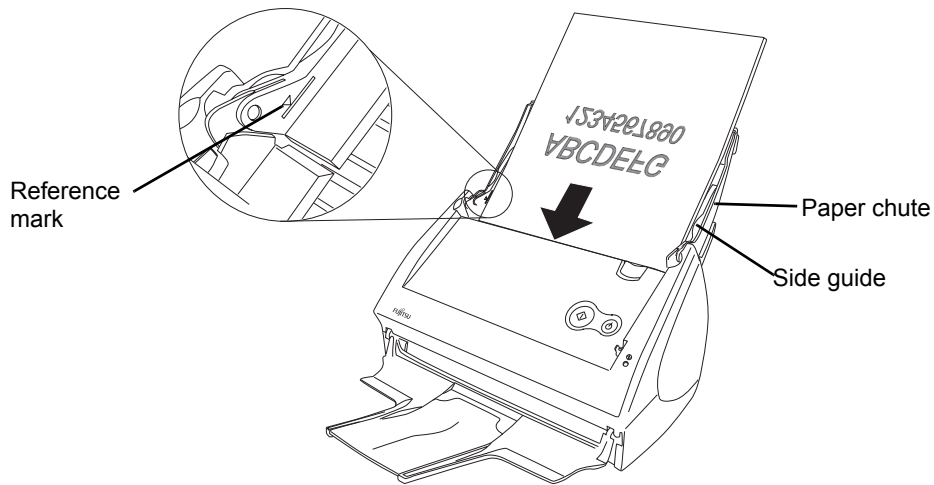

In the "ScanSnap Manager -Scan and Save Settings" dialog box, select the [Scanning] tab, and then click the [Option] button. In the "Read mode option" dialog box displayed, check whether the "Set the documents with its face up" checkbox is marked. If marked, load the document its face up and the bottom edge into ADF.

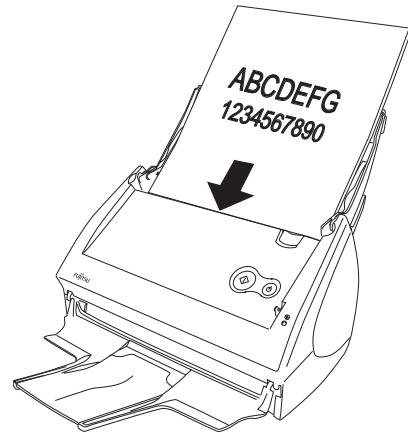

Pull out the extension of the paper chute to scan long-size documents.

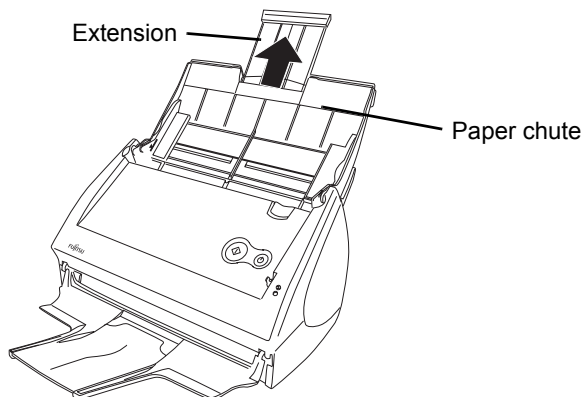

- 3. Adjust the side guides to the document width.
Move the side guides so that there is no gap between the document edge and side guide on both sides. Doing so can eliminate skewing of the document during scanning.

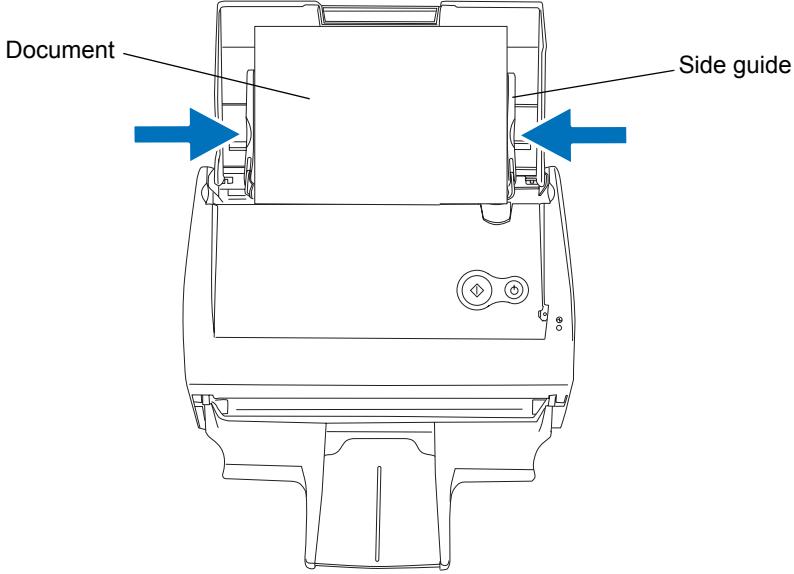

When you use the stacker, scanned document sheets are stacked on the stacker in the collated order when they have passed through the ScanSnap.

Use the stacker as described below.

- 1. Pull out the stacker toward you.

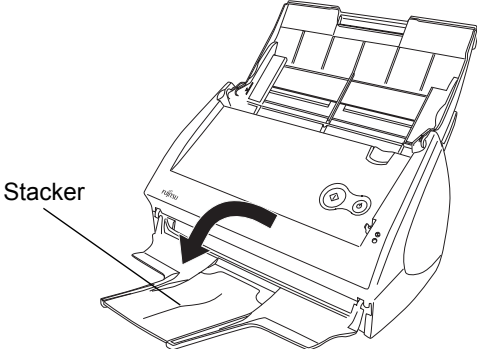

- 2. Extend the stacker.

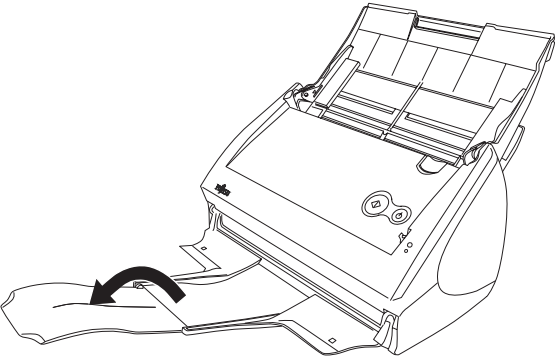

■ Loading Documents Using the Carrier Sheet

The Carrier Sheet is a plastic sheet for loading the document specifically for the ScanSnap S510/S500/fi-5110EOX2 Series. It allows you to scan documents that cannot be scanned as it is. The document of larger than A4 size, such as A3 and B4 sizes, can be scanned by folding it in half. Insert the folded document into the Carrier Sheet and scan it in duplex mode.

You can scan documents that can easily get scratched such as photographs or irregular-shaped documents difficult to load on the ScanSnap; for example, clippings of magazine and newspaper articles.

The following explains how to insert the document into the Carrier Sheet.

You can use the Carrier Sheet in two different modes according to the type of documents.

Create facing pages in one image (page 53)

Use this mode for scanning a document larger than A4 size such as A3 and B4 sizes.

Fold the document in half, scan it in duplex scanning mode, and then merge both front and back side images to make a double-page spread image.

Create front and back images separately (page 58)

Use this mode for scanning a photograph when you do not want to get scratches on the photograph, or for scanning an irregular-shaped document such as the clipping of articles, which is difficult to scan as it is. The scanned image is output in specified size.



- To use the Carrier Sheet, select [Automatic Detection] in the Paper size drop-down list on the [Paper size] tab of the ScanSnap Manager -Scan and Save Settings" dialog box. When you scan the document in "Create facing pages in one image" mode, set the Scanning side to "Duplex Scan" on the [Scanning] tab of the ScanSnap Manager -Scan and Save Settings" dialog box. If you set the Scanning side to "Simplex Scan," the produced image is the same as the one produced in "Create front and back images separately" and "Simplex Scan" mode.

For details on how to change the "Carrier Sheet" Settings, refer to section "4.5 Changing Carrier Sheet Settings" (page 106).

- When the Carrier Sheet is used for scanning, continuous scanning is not possible. Scan one piece or one page at one time.



To "Create facing pages in one image"

Use this mode for scanning a document larger than A4 size such as A3 and B4 sizes. Fold the document in half, scan it in duplex scanning mode, and then merge both front and back side images to make a double-page spread image.

(You can also merge both front and back side images of a document smaller than A4 size to output a double-page spread image.)



1. Right-click the ScanSnap Manager icon **S** on the task bar, and select "SCAN Button Settings."

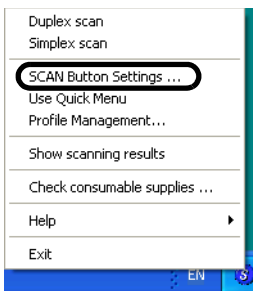

2. On the [Paper Size] tab, click the "Carrier Sheet Settings" button.



3. In the "Carrier Sheet Settings" window, select "Create facing pages in one image" in the "Mode" drop-down list, and then click the [OK] button.

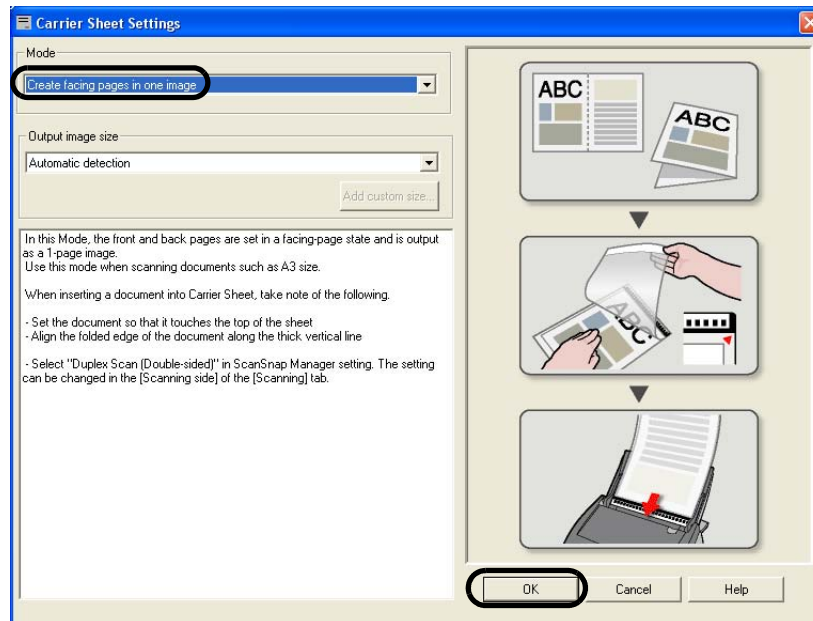

4. Select "Automatic Detection" in the "Paper size" drop-down list on the [Paper size] tab.



- 5. Select "Duplex Scan" in the "Scanning side" drop-down list on the [Scanning] tab, and click the [OK] button.

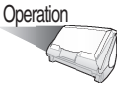
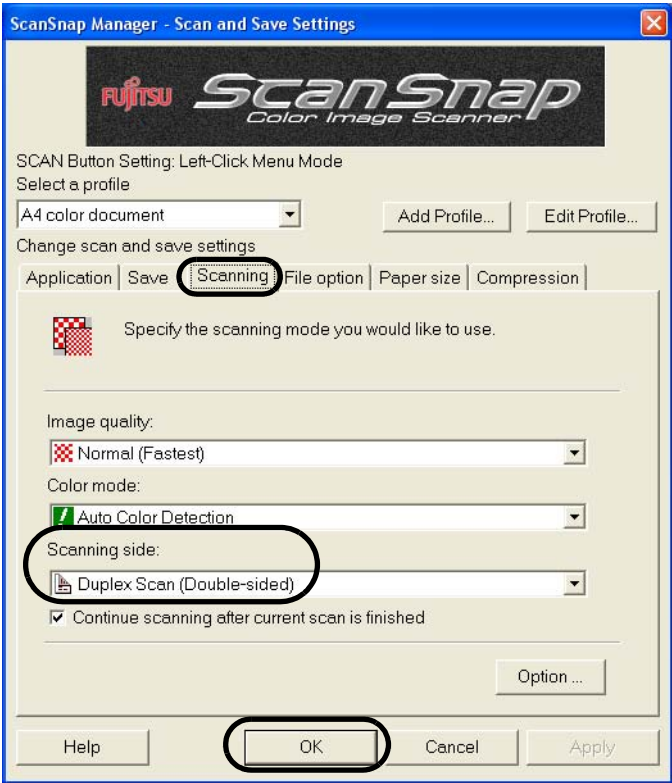

- 6. Fold the sheet to be scanned in half.
Fold the sheet tightly and smooth out the crease. Otherwise, the sheet may be skewed during scanning.

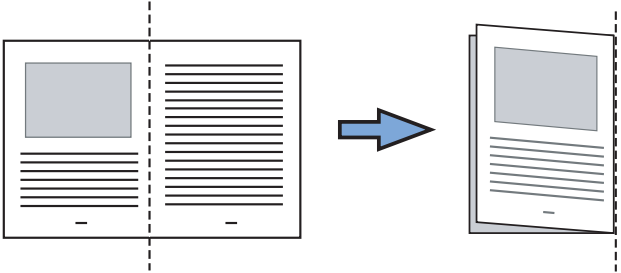

7. Open the Carrier Sheet and insert the document.

Align the fold with the right edge of the Carrier Sheet so that the document fits into the Carrier Sheet at the upper corner.

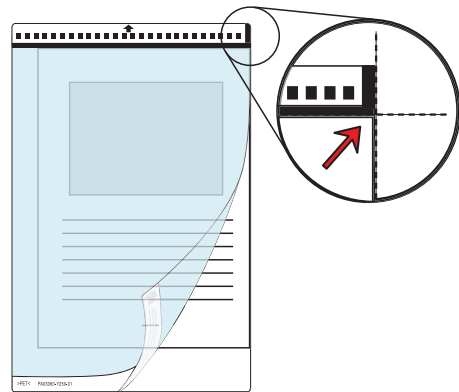

8. Load the Carrier Sheet onto the ScanSnap.

- Load the Carrier Sheet with the portion striped in black and white as the leading edge as shown in the right figure.
- Adjust the side guides to the width of the Carrier Sheet to avoid skewing.
- When the Carrier Sheet is used for scanning, continuous scanning is not possible. Scan one piece or one sheet at one time.

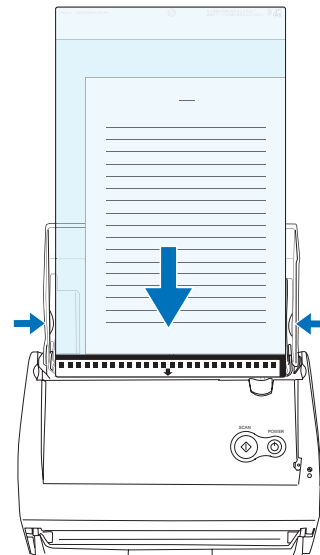

9. Press the [SCAN] button .

⇒ The front and back side images are merged into a double-page spread image.

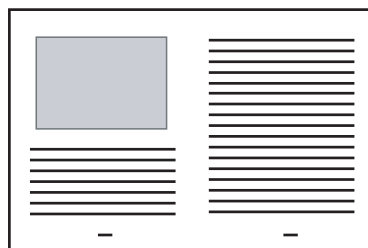



- There may be an interstice between the front and back side images, or a line may appear on the output image.
When a sheet of thick paper is scanned, images on the both right and left side may be skewed to a trapezoidal shape.
The degree of skewing varies depending on the condition of the document (how it is folded or loaded).
Troubleshoot the problem as follows, and the situation may be improved.
 - Is the document neatly folded? If not, fold it neatly.
 - Is the edge of the document aligned with the edge of the Carrier Sheet? If not, align the document with the Carrier Sheet.
 - Try to scan the document with the front side of the Carrier Sheet facing the paper chute or vice verse.
- When "Automatic Detection" is selected from the "Output image size" drop-down list in the "Carrier Sheet Settings" window, the size of the produced image may be smaller than the original.
(The image is output in A3, B4, or 11" x 17" size, whichever the smallest, so that all elements on the image are included.)
Example: When you scan the A4 size image printed at the center of an A3 size paper
⇒ A B4 size image is output.
To output an image in the original size, specify the document size in the [Output image size] drop-down list.

To "Create front and back images separately"

Use this mode for scanning a photograph with the Carrier Sheet when you do not want to get scratches on the photograph, or for scanning an irregular-shaped document such as the clipping of articles, which is difficult to scan as is.



1. Right-click the ScanSnap Manager icon **S** on the task bar, and select [Scan Button Settings].

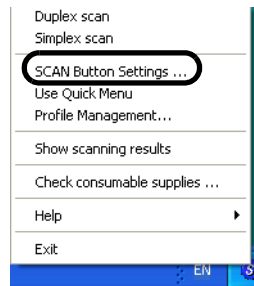

⇒ The "ScanSnap Manager -Scan and Save Settings" dialog box appears.

2. On the [Paper Size] tab, click the [Carrier Sheet Settings] button.



- 3. On the "Carrier Sheet Settings" window, select "Create front and back images separately" in the "Mode" drop-down list, and then click the [OK] button.

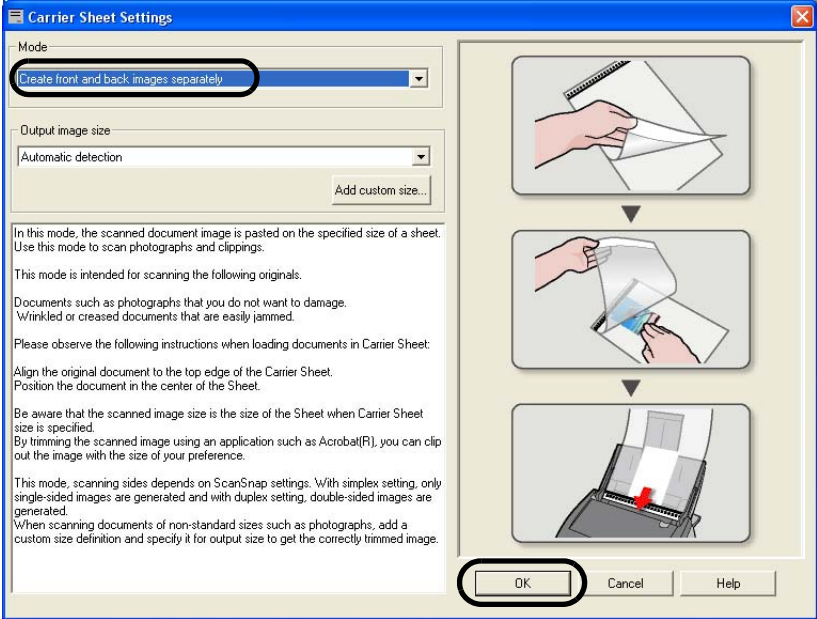

- 4. Select "Automatic detection" in the "Paper size" drop-down list on the [Paper size] tab.

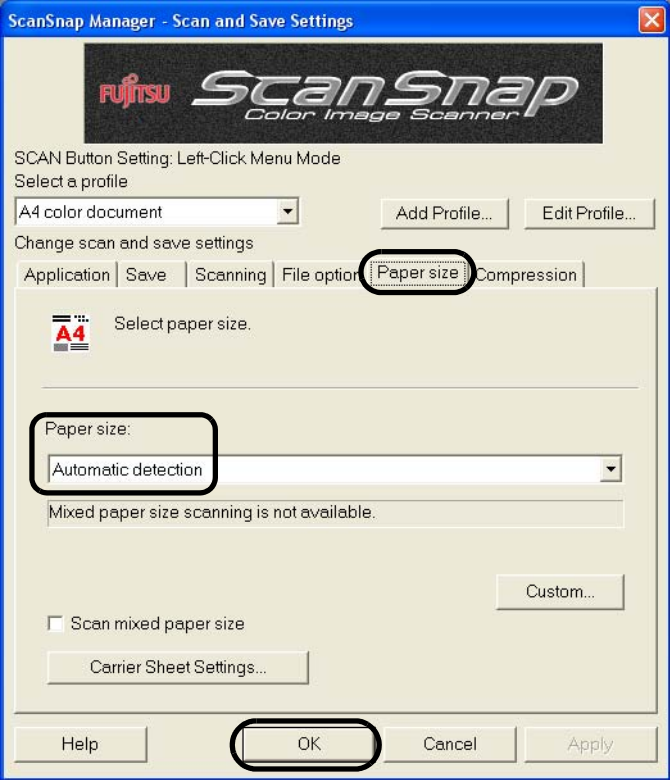



5. Open the Carrier Sheet and insert the material to scan.

Neatly align the top of the material with the top of the Carrier Sheet.
Center the material so that it is entirely contained in the Carrier Sheet.

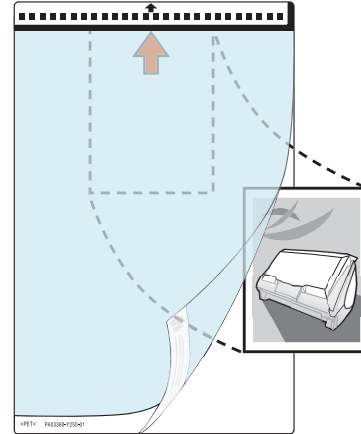

6. Load the Carrier Sheet onto the ScanSnap.

- Load the Carrier Sheet with the portion striped in black and white as the leading edge as shown in the right figure.
- Place the Carrier Sheet so that the back side of it faces up.
- Adjust the side guides to the width of the Carrier Sheet to avoid skewing.
- When the Carrier Sheet is used for scanning, continuous scanning is not possible. Scan one piece or one sheet at one time.

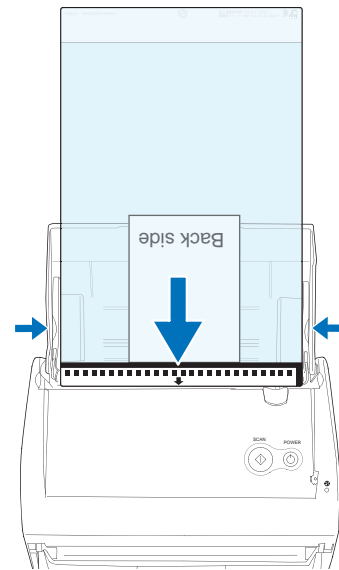

In the "ScanSnap Manager -Scan and Save Settings" dialog box, select the [Scanning] tab, and then the [Options] button to display the "Read mode option" window. When the "Set the documents with its face up" checkbox is marked in the "Read mode option" window, load the document so that its front side faces up in the correct orientation.

7. Press the [SCAN] button .

⇒ Scanning is started and the image data is generated in the specified size.



- The image is centered and output in the specified size.
When "Automatic Detection" is selected in the "Output image size" drop-down list of the "Carrier Sheet Settings" window, an optimal size is selected automatically from the available standard sizes (refer to page 108) and the image is output.
- In the "Carrier Sheet Settings" window, when "Automatic Detection" is selected in the "Output image size" drop-down list, the size of the produced image may be smaller than the original.
Example: When you scan the A5 size image printed at the center of an A4 size paper
⇒ A5 size image is output.
To output an image in the original size, specify the document size in the [Output image size] drop-down list



If the following symptoms are observed, lay the material over a piece of white paper to scan.

- The output image is not in a suitable size (when [Automatic Detection] is selected).
- The outline of the material is shaded.
- Black lines appear around the material cut out in an indefinite shape.

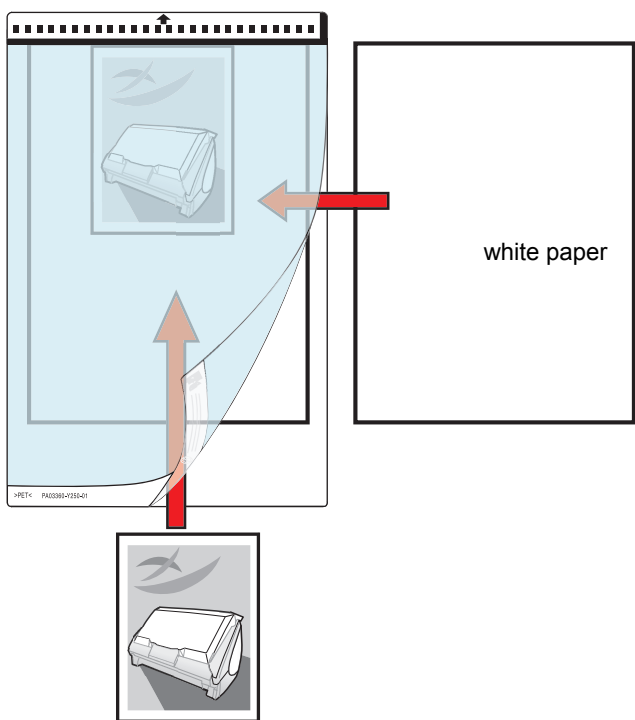

Chapter 4



Setting the ScanSnap

This chapter describes the basic settings of the ScanSnap.

4.1 About the ScanSnap Icon	64
4.2 Changing Scanning Settings	67
4.3 Saving Scanning Settings	92
4.4 Using the ScanSnap Quick Menu	103
4.5 Changing Carrier Sheet Settings	106

4.1 About the ScanSnap Icon

All functional properties on the ScanSnap are managed by ScanSnap Manger.

Ordinarily, the ScanSnap Manager icon  is added to the task bar at the lower right on the Windows desktop.

Clicking this icon shows the following menus. You can use either of the menus to start scanning, change settings, and check the status of consumables.

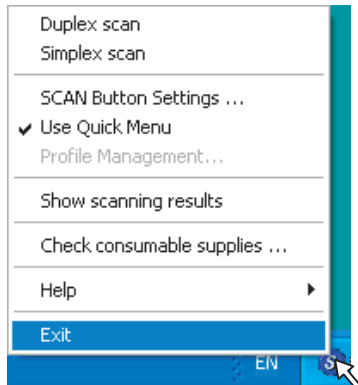

Right-Click Menu

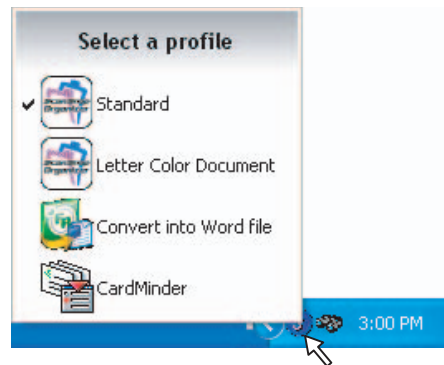



Left-Click Menu

■ Right-Click Menu

This menu appears when the ScanSnap Manager icon  is right-clicked.

In this menu, you can perform the following:

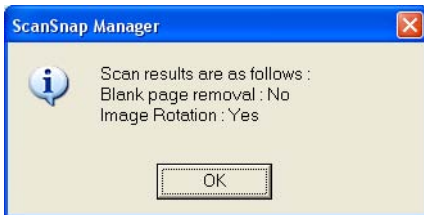
Item	Function
Duplex scan	Both the front and back sides of the document are scanned at the same time. Scanning is performed according to the settings configured in the "ScanSnap Manager - Scan and Save Settings" dialog box.
Simplex scan	Only one side of the document is scanned at one time. Scanning is performed according to the SCAN Button Settings.
SCAN Button Settings	The "ScanSnap Manger - Scan and Save Settings" dialog box appears. Settings configured in this dialog are used when scanning is performed with a [SCAN] button  press. ⇒ Refer to "4.2 Changing Scanning Settings" (page 67).
Use Quick Menu	You can switch between the Quick Menu Mode and Left-Click Menu Mode by marking/clearing this. You can select an operational mode that is enabled upon scanning with a [SCAN] button  press. ⇒ Refer to section "3.1 Flow of Operations" (page 30).
Profile Management	The "ScanSnap Manager - Scan and Save Settings" dialog box appears. You can edit profiles. ⇒ Refer to "4.3 Saving Scanning Settings" (page 92).
Show scanning results	A message appears after scanning to inform you of the scanning results, whether blank pages are removed (page 81) and/or the orientation is changed (page 82). 
Check consumable supplies	The "Check consumable status" dialog box appears. Reset consumable counters to 0 after you replace consumables. Refer to section "9.1 Replacing Consumables" (page 238).
Help	You can view the Help topics, the version information of ScanSnap Manager, and the "Preferences" (page 113) and Online Update (page 251) dialog boxes.
Exit	You can exit ScanSnap Manger.

■ Left-Click Menu

This menu appears when the ScanSnap Manager  icon is left-clicked.

Selectable profiles are listed on the Left-Click Menu.

Select a profile name on this menu, and you can switch between profiles previously configured and added to the profile list.

The selected profile is used for scanning in Left-Click Menu Mode (page 40).

For how to create and edit profiles, refer to section "4.3 Saving Scanning Settings" (page 92).

 The Left-Click Menu is not displayed in Quick Menu Mode (page 35). When you want to use the Left-Click Menu, unmark [Use ScanSnap Quick Menu] in the Right-Click Menu.

4.2 Changing Scanning Settings

To change scanning settings for the ScanSnap, use the Right-Click Menu. The following describes how to change the settings.



1. Right-click the ScanSnap Manager icon **S** on the task bar. When you want to change scanning settings, select [SCAN Button Settings].

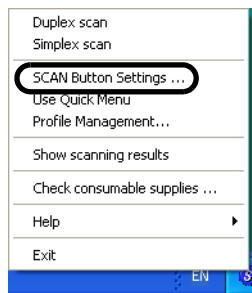

⇒ The "ScanSnap Manager - Scan and Save Settings" dialog box appears.

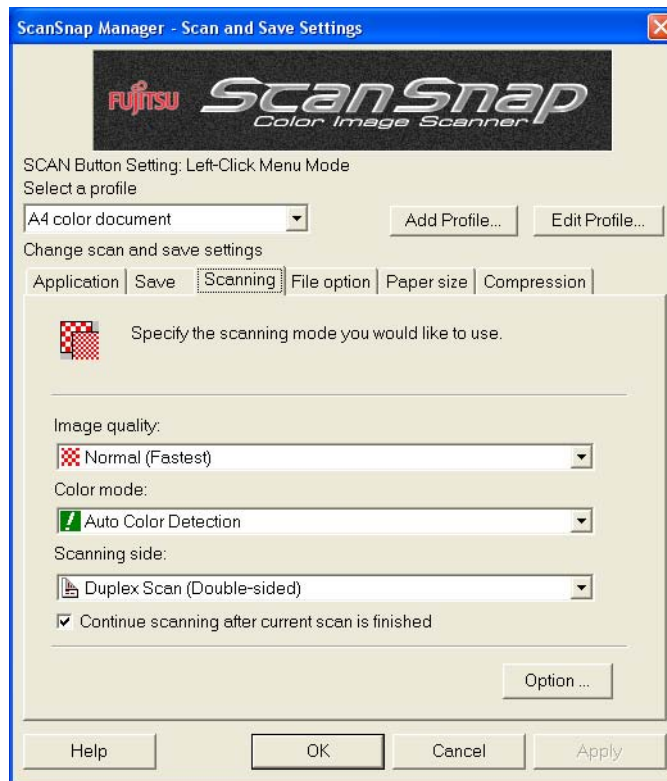



You can also display the "ScanSnap Manager - Scan and Save Settings" dialog box by double-clicking the ScanSnap Manager icon , or by pressing [Ctrl], [Shift], and [Space] keys simultaneously.

2. Change the scanning settings on each tab of the "ScanSnap Manager - Scan and Save Settings" dialog box.

The following settings can be changed:

- The application that starts automatically and interacts with ScanSnap ⇨ [Application](page 71)
- The destination to save scanned images ⇨ [Save](page 74)
- Scan mode (fast or slow, excellent or normal, color or black-and-white, enable or disable "setting for text only document," "automatic blank page removal," "correct skewed character strings automatically," "allow automatic image rotation," and/or "set the document with its face up," and whether "Continue scanning after current scan is finished")⇨ [Scanning] (page 78)
- File format for the scanned image ⇨ [File option](page 83)
(file format, OCR, number of pages per PDF file, and password for PDF files)
- Paper size of the document ⇨ [Paper size](page 87)
(Carrier Sheet settings)
- File size for saving scanned images ⇨ [Compression](page 90)



Settings for scanning vary between the Quick Menu Mode and Left-Click Menu Mode. In this section, the "Scan and Save Settings" dialog box in the Left-Click Menu Mode is used as examples.

3. Click the [OK] or [Apply] button.

⇒ Settings on the "Scan and Save Settings" dialog box have been changed.

<Setting Items>

Each setting item is described below.

Settings you can change for scanning in Quick Menu Mode differ from those in Left-Click Menu Mode.

For your convenience, each item is marked with a following symbol:

SCAN - Quick : Items that can be set in Quick Menu Mode

SCAN - Left-Click : Items that can be set in Left-Click Menu Mode

* Items with no mark can be changed in both modes.

Select a profile: **SCAN - Left-Click**

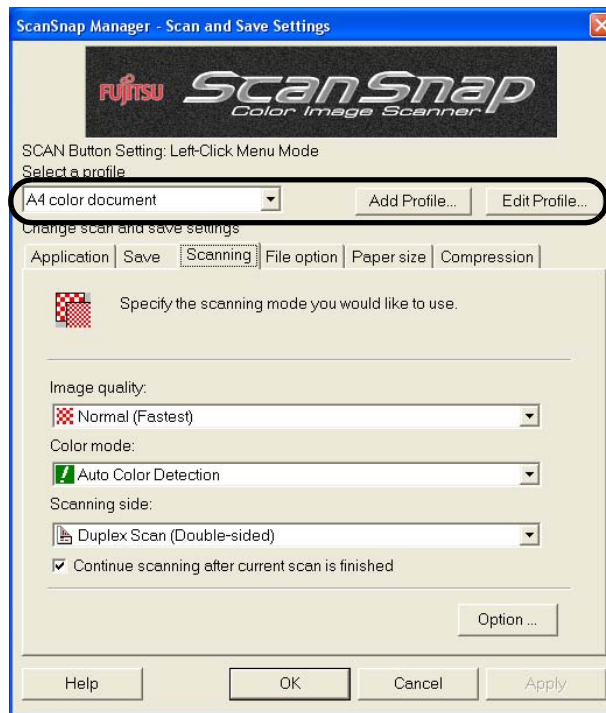

You can switch between profiles configured beforehand by selecting a profile in the "Select a profile" drop-down list.

By default, the following profiles are in the list.

- Standard
- CardMinder
- Searchable PDF



You can add profiles configured to suit your needs or preferences. For details on how to add a profile, refer to "4.3 Saving Scanning Settings" (page 92).

■ [Add Profile] Button

You can add new profiles configured to meet your preferences.

■ [Edit Profile] Button

Clicking this button displays the "Profile Management" window.

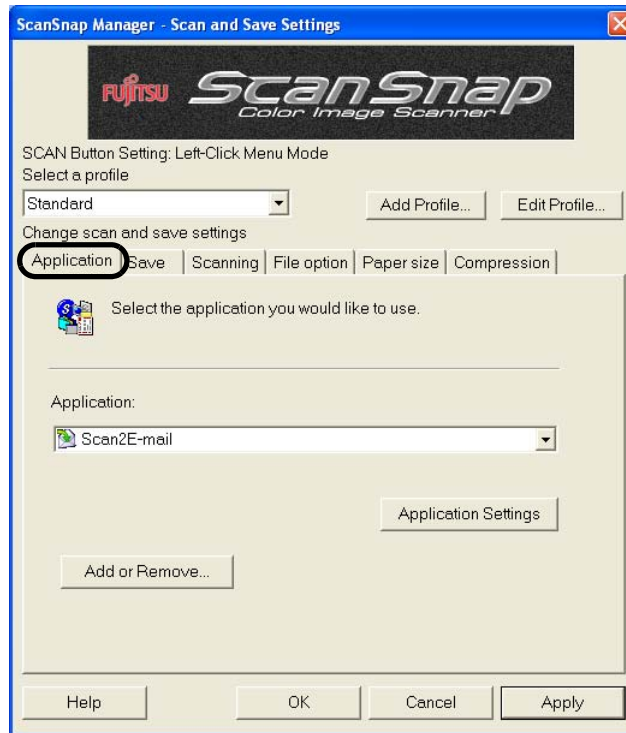

In this window, you can change profile names, delete profiles, and change the order listed. However, you cannot change or delete the "Standard" profile (a default profile).

[Application] tab **SCAN - Left-Click****■ Application:**

Specify the application to be linked to the ScanSnap to execute. The specified application starts up after the document is scanned with the ScanSnap. Click the drop-down-arrow  to select an application.

The selections are as follows:

- No application is started (Save to File)
- ScanSnap Organizer (⇒page 208)
- Adobe® Acrobat®
- Adobe® Acrobat® Reader™ or Adobe® Reader®
- CardMinder (⇒page 202)
- ABBYY Scan2Excel (⇒page 155)
- ABBYY Scan2Word (⇒page 155)
- ABBYY Scan2PowerPoint (⇒page 155)
- Scan2Folder (⇒page 117)
- Scan2E-mail (⇒page 129)
- Scan2Print (⇒page 129)



- Only the installed applications are selectable.
- If you select "No application is started (Save to File)," the scanned image is saved to file, but this operation is transparent to you. Scanning results (scanned images) are not displayed. Select this when you do not want to view the scanned image every time a document is scanned.
- When you select "CardMinder " in the "Application" drop-down list on the [Application] tab, the [Save], [File option], [Paper size], and [Compression] tabs are hidden.
- When CardMinder is active, the application selected in the "Application" drop-down list on the [Application] tab automatically switches to CardMinder. When ScanSnap Organizer is active, the application selected in the "Application" drop-down list on the [Application] tab automatically switches to ScanSnap Organizer. When either of those applications is deactivated, the application selected in the "Application" drop-down list on the [Application] tab switches to the previously selected application.

■ [Applications Settings] button

This button only appears when "Scan2E-mail" or "Scan2Print" is selected in the "Application" list. With this button, you can change the settings of the selected application.

■ [Add or Remove] button

Applications can be added to or removed from the "Application" list. Click the [Add or Remove] button to displayed the dialog box below.

(Up to 10 applications can be added.)

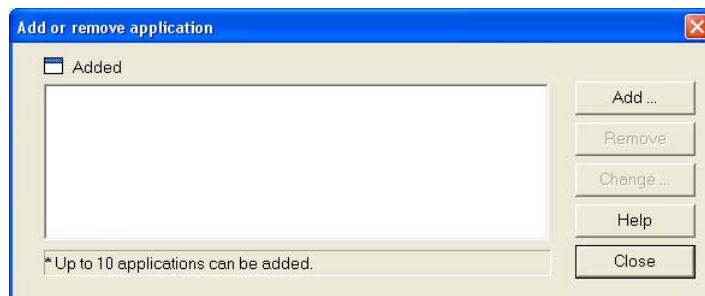

<To add an application>

- 1) Click the [Add] button.
- 2) The dialog box below appears.

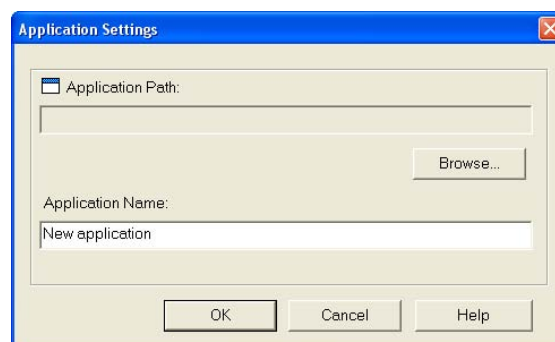

- Click the [Browse] button to select an executable file (.exe) or a shortcut file (.lnk).
⇒ The path to the selected application is displayed in the "Application Path" field.
 - Type in a name for the newly selected application.
⇒ The application name is displayed in the "Application" drop-down list.
- 3) When you have finished the procedure, click the [OK] button.
 - 4) In the dialog box below, the new application appears in the list. Click the [Close] button to close the window.

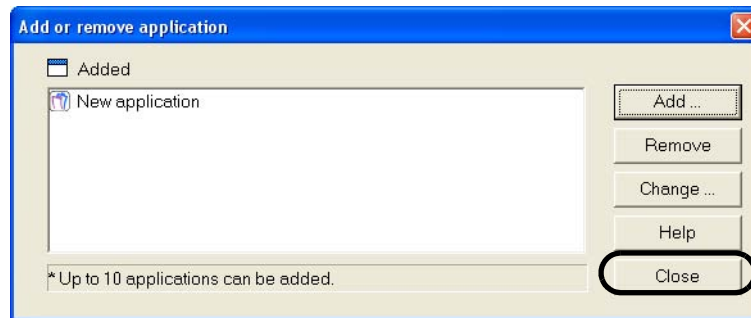

Select an application that handles JPEG (*.jpg) and/or PDF (*.pdf) file format. Scanned images cannot be displayed properly unless either of these file formats is supported.

Depending on applications, password-protected or text-recognized (process through OCR) PDF files may not be opened.

You can check whether the selected application handles the above file formats by doing the following:

Example: Check that the selected application handles the JPEG file format>

1. Create a shortcut to the application you want to add.
2. Drag a file in JPEG format (*.jpg) onto the shortcut (drag-and-drop action).
⇒ If the application starts up and the file opens, the application handles the JPEG file formats.

<To remove an application>

- 1) Select an application you want to remove in the "Add or remove application" window, and then click the [Remove] button.
- 2) The confirmation message appears. Click the [Yes] button to remove the application.
- 3) Make sure that the application is removed, and then click the [Close] button.

<To change settings>

- 1) Select an application you want to change settings (path/name) for in the "Add or remove application" window, and then click the [Change] button.
- 2) The "Application Settings" dialog box appears. Change the desired items.
- 3) After you make changes, click the [OK] button.
- 4) In the "Add or remove application" window, the application appears with a new name if you change the name. Click the [Close] button to close the window.

[Save] tab

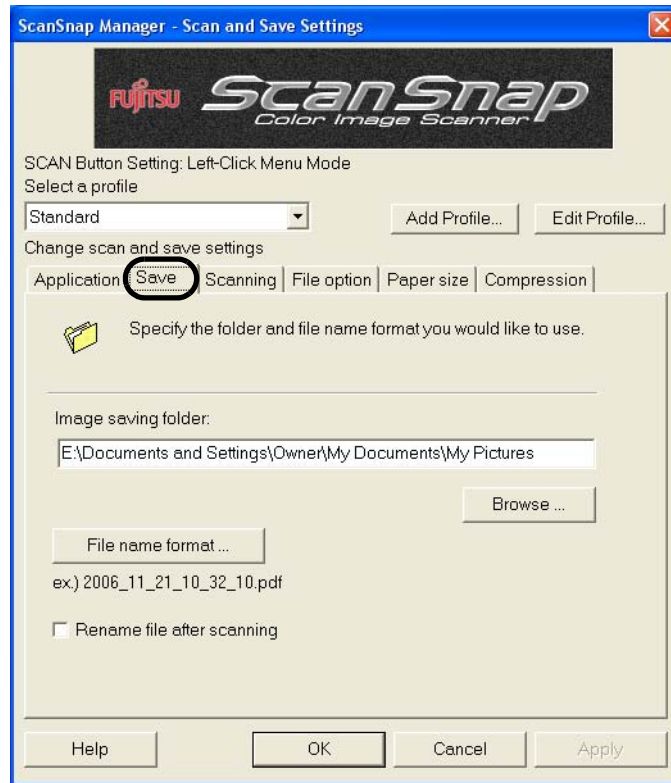

■ Image saving folder:

Specify a folder to save scanned images.

When you click the [Browse] button, the "Browse for Folder" dialog box appears.

Select a folder to save scanned images, and then click the [OK] button.





When "ScanSnap Organizer" is selected in the [Application] drop-down list, [Image saving folder] and the [Browse] button are grayed out, and you cannot specify any folder to save images from this window.

In this case, scanned images are saved in the "My ScanSnap Folder" specified in ScanSnap Organizer (page 211). (If the operating system is Windows Vista, the folder will be labeled as the "ScanSnap Folder.")

■ [Filename format] button

Specify the name of image files to save.

When you click the [File name format] button, the following dialog box appears.

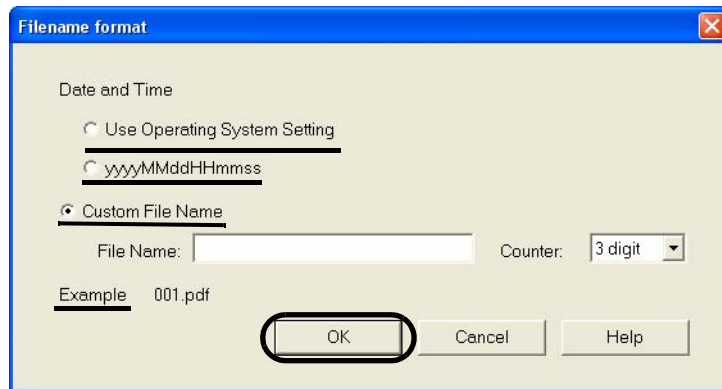

You can select one of three settings below.

- "Date and time (Use Operating System Setting)"
Files are named according to the settings of the operating system of your personal computer.
Characters inappropriate for file names (/;+,*"<>|), if used, will be replaced with "-" (hyphen).
- "Date and time (yyyyMMddHHmmss)"
The date and time are used for file names.
Example: A file saved at 19:00:50 on December 27th, 2003, in PDF format will be 20031227190050.pdf
- "Custom File Name"
A file name is the combination of a text string typed in the "File Name" field and a number of digits specified in the "Counter" drop-down list.
(An example name in each format is displayed at the bottom of the dialog box when you select the format.)



About "Counter"

- When no file with a name specified in the "File Name" field exists in the save folder (specified on the [Save] tab), a suffix number combined will be "1" ("001" if 3 is selected in the "Counter" drop-down list). The number increases in increments of 1 every time a new file is saved.
- When other files with a name specified in the "File Name" field exist in the save folder, a number combined will be the smallest available number.
Example: When files, Scan01.pdf, Scan03.pdf, and Scan04.pdf, exist in the same folder, the file you save next will be Scan02.pdf, and then Scan05.pdf, Scan06.pdf, Scan07.pdf...as long as you use the same "File Name."
- When the specified number of digits is exceeded (for example, when saving the 100th file with two digits specified), the number of digits increases by one.

Upon clicking the [OK] button, specified settings take effect.

(An example file name in the format you select is displayed under the [Filename format] button.)

■ Rename file after scanning **SCAN - Left-Click**

If this checkbox is marked, the "Save scanned image as" dialog box appears after scanning.

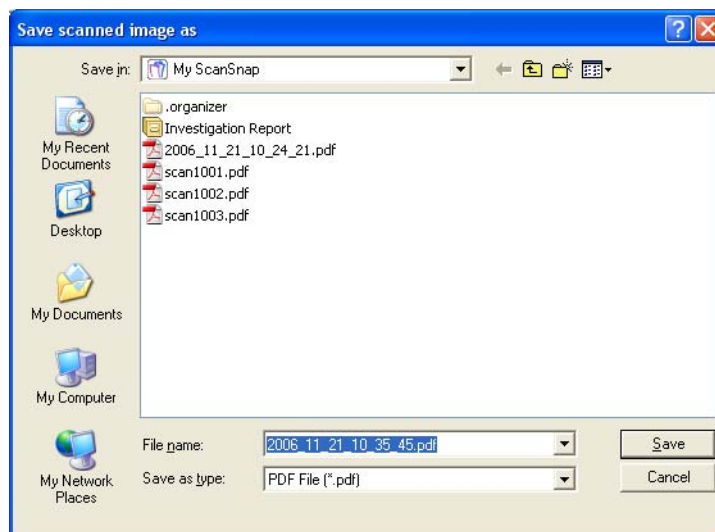

You can change folders to save the scanned images, or rename files in this window.



- The file is automatically named with a file name previously specified in the "File name format" dialog box. If you do not want to rename the file, click the [Save] button.
- When multiple files are generated per scan, each file name is followed by a serial number. (⇒ File name + Serial number + .Extension)

Example 1: In the "PDF file format option" dialog box (page 85), select [Generate one PDF file per xx page(s)]. If a scanned document contains pages exceeding the specified page number, files are named as follows:

⇒ Scan001.pdf, Scan002.pdf, Scan003.pdf...

Example 2: When files are saved in JPEG format, files are named as follows:

⇒ Scan001.jpg, Scan002.jpg, Scan003.jpg...

*The example names above are of files named using "Scan" as the file name.

*The number of digits is a number selected in the "File name format" dialog box.

[Scanning] tab

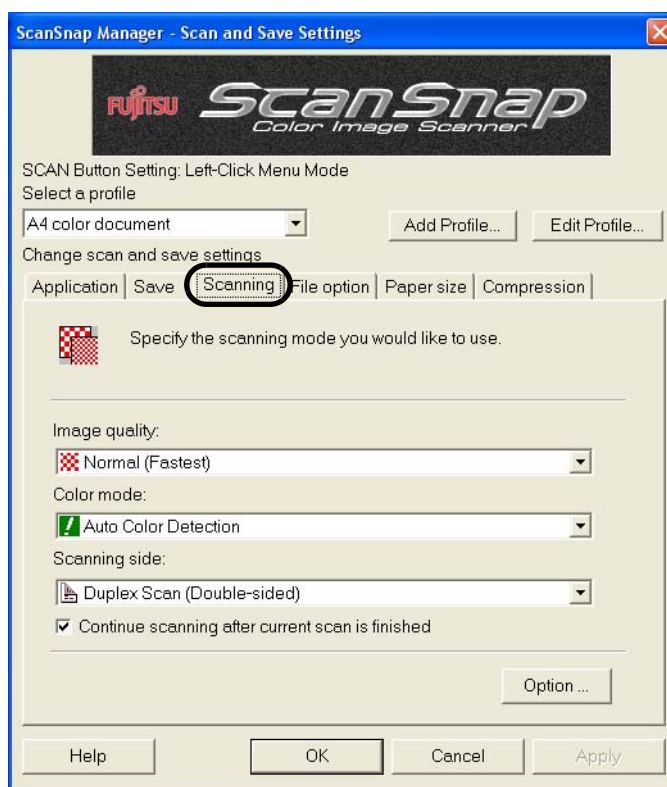

■ Image quality:

You can specify mode to scan documents, depending on your preferences (whether you want to scan documents quickly or at high quality).

Select one of the following:

- **Normal (Fastest)**
Select this mode when you wish to scan documents quickly.
- **Better (Faster)**
Select this mode when you wish to scan documents at high quality.
- **Best (Slow)**
Select this mode when you wish to scan documents at higher quality.
- **Excellent (Slower)**
Select this mode when you wish to scan documents at the highest quality



The resolution of each mode is as follows:

- Normal: equivalent to 150 dpi (color)/300 dpi (black-and-white)
- Fine: equivalent to 200 dpi (color)/400 dpi (black-and-white)
- Best: equivalent to 300 dpi (color)/600 dpi (black-and-white)
- Excellent: equivalent to 600 dpi (color)/1200 dpi (black-and-white)

Generally, the higher quality you specify, the longer it takes to scan documents and the larger the file size becomes.

■ Color mode:

You can specify whether to scan documents in color or black-and-white.

Select one of the following modes:

- **Auto Color Detection**

The ScanSnap automatically recognizes color pages and black-and-white pages, and it switches between color and B&W modes automatically.

- **Color**

The ScanSnap scans the document in color mode.

This setting suits when color pages are scanned.

- **B&W**

The ScanSnap scans the document in black-and-white mode.

This setting suits when black-and-white pages, mostly containing text, is scanned.

The file sizes are smaller than those scanned in color mode.

- **Color high compression** SCAN - Left-Click

The ScanSnap saves color document images at a high compression rate.

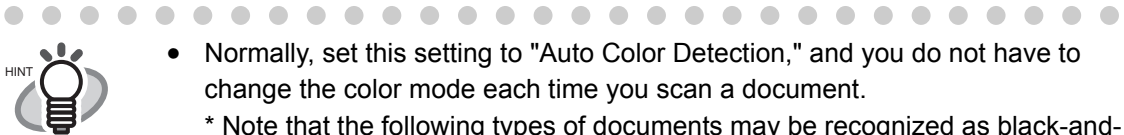

- Normally, set this setting to "Auto Color Detection," and you do not have to change the color mode each time you scan a document.
* Note that the following types of documents may be recognized as black-and-white documents.

- Faintly toned paper

- Partially colored documents

- Documents printed in two colors; many parts of documents are colored in dark color such as dark gray similar to black

To scan such documents in color mode, select "Color" in the "Color mode" drop-down list.

- In "Color high compression" mode, characters and backgrounds on the document are compressed separately, and thus, the file size of the document that mostly contains text characters becomes smaller while the quality of the characters is kept high.

However, this mode is not appropriate for scanning photographs or figures because these graphical materials are recognized as background and compressed as such, causing degradation in images.

If this setting is specified, the contrast of the image may become higher.

- Depending on the types of documents, file size may increase if you use color high compression mode than if you do not. The file size of the following types of documents may become larger.

- Documents that contain many pictures and/or graphics but fewer characters written in black

- Documents of complex layout (e.g. multiple columns)

- Documents with patterned background



■ Scanning side:

You can select the sides to be scanned (single-sided or double-sided) by pressing the

[SCAN] button  on the ScanSnap.

Select [Duplex Scan] or [Simplex Scan] from the menu.

■ Continue scanning after current scan is finished

If the checkbox is marked, the following message appears after scanning.

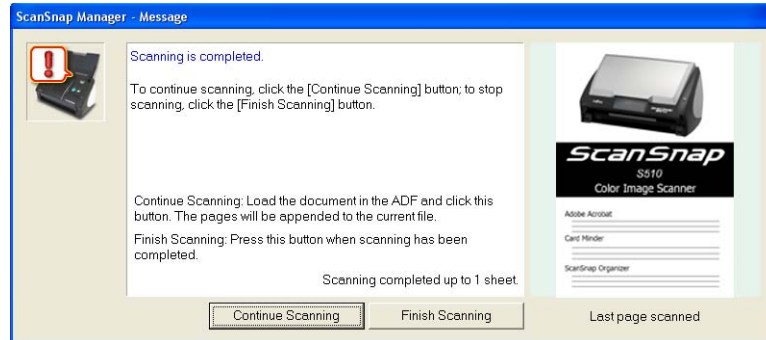

To continue scanning, load a document onto the ScanSnap, and then click the [Continue Scanning] button.

To finish scanning, click the [Finish Scanning] button.

After the [Finish Scanning] button is clicked, the scanned images are saved into one file.

* It is possible to continue scanning up to 1000 pages for one file.

* The size of a PDF file should be 1Gbyte at the maximum. Although a file larger than 1Gbyte can be created, such a file may not be opened.

Specifically, when you attempt to open the file with Adobe Acrobat, a message may appear to tell that the file is corrupted and being fixed.

■ [Option] button

In the dialog box below, you can configure detailed settings.

Clicking the [Option] button displays the "Read mode option" dialog box.

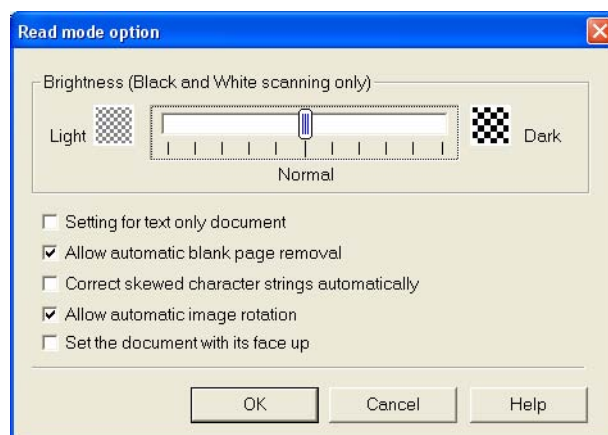

- Brightness

(Black and White scanning only)

You can set the density for scanning black-and-white images.

Moving the slider control to the left lightens scanned images while moving the slider control to the right darkens scanned images.

- * This setting is valid when "B&W" is selected in the "Color mode" drop-down list, or when a scanned document is recognized as a black-and-white document with "Auto Color Detection" selected in the "Color mode" drop-down list.

- Setting for text only document

Mark or clear this checkbox depending on documents.

- Mark this checkbox when scanning documents containing printed or handwritten text.
- Clear this checkbox when scanning documents containing photographs.

- Allow automatic blank page removal

When this checkbox is marked, blank pages in a document are automatically recognized and removed so that the output images include no blank pages.

For example, when both two-sided and one-sided documents are contained in a batch and the batch is scanned in Duplex mode, this feature removes only the back side (blank page) of one-sided documents.

- * No scanned images are output if all pages of the batch of documents are recognized as blank.



The following types of documents may be accidentally recognized as blank.

- Almost blank sheet of paper with a few characters on it
- Plain color sheet of paper (including black)

Before discarding the original documents you have scanned, check the document images for pages accidentally removed. If any, you may have to scan the documents again.



- Correct skewed character strings automatically

When this checkbox is marked, skewing is automatically detected and corrected to output images. Up to +/-5 degrees of skews can be corrected.



This function detects a document skew based on the text lines. Therefore, if the following types of documents are skewed, the skew may not be corrected:

- Documents on which the pitches of lines or characters are extremely narrow, or characters are overlapped
- Documents that have many outlined or decorated characters
- Documents that have many photographs or figures but only a few characters
- Documents that have characters on patterned background
- Documents that have characters printed in various direction (e.g. drawings)
- Documents that have long diagonal lines
- Handwritten documents

*When you scan documents above, clear the checkbox.



-
- Allow automatic image rotation
When this checkbox is marked, pages scanned upside down or in the wrong orientation are rotated and output in the right orientation.



This function detects the orientation of a document based on the text lines. Therefore, the following types of documents may not be rotated correctly:

- Documents which have many extremely large/small characters
- Documents on which pitches of lines or characters are extremely narrow, or characters are overlapped
- Documents that have many characters contacting underlines or ruled lines
- Documents that have many photographs or figures but a few characters
- Documents that have characters on patterned background
- Documents that have characters printed in various directions (e.g. plans, etc.)
- Documents that have only capital letters
- Handwritten documents
- Documents that have unclear or smeared characters

*When you scan documents above, clear the checkbox.

-
- Set the documents with its face up

Mark the checkbox if you want to scan the document as shown in the right figure.

Scanning starts with the last page from bottom up. After all pages are scanned, pages are sorted in the reverse order scanned to save to file.

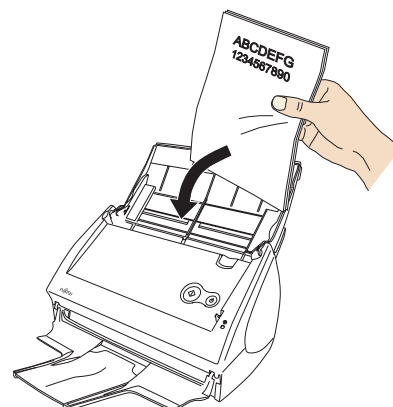

The scanning speed is slower than usual because scanned images are sorted after scanning.

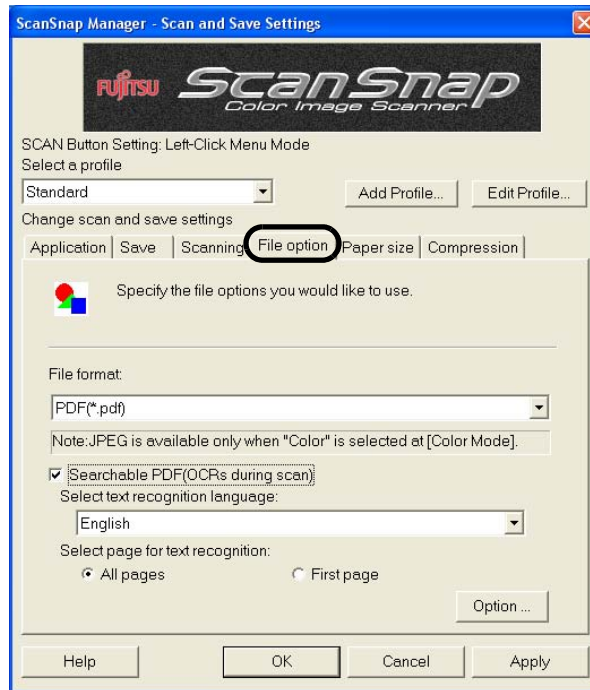
[File option] tab

■ **File format** **SCAN - Left-Click**

You can specify the file format to save scanned images.

Click the down-arrow  and select either of the following:

- PDF (*.pdf)
- JPEG (*.jpg)



The "JPEG" format is not available when "Auto Color Detection," "B&W," or "Color high compression" is selected in the [Color mode] drop-down list on the [Scanning] tab.

When "JPEG" is selected, if you select "Auto Color Detection," "B&W," or "Color high compression," the file format is automatically switched to "PDF."

■ **Searchable PDF (OCRs during scan)**

You can use this function only when PDF is selected in the [File format] drop-down list. By marking this checkbox, you can create a searchable PDF file.

■ **Select text recognition language:**

You can select a language for recognizing text.

■ **Select page for text recognition:**

- All pages
All pages are recognized as text when a PDF file is created.
- First page
Only the first page is recognized as text when a PDF file is created.



- Marking this checkbox may require an extended period of processing depending on your personal computer environment.
- ScanSnap may fail to correctly recognize the following kinds of documents (characters) as text. However, by changing Color mode and/or improving Image quality for scanning, such a document may be successfully text recognized.
 - Handwritten documents
 - Documents including smaller characters and scanned in low quality
 - Skewed documents
 - Documents written in languages other than the specified language for text recognition
 - Documents including texts written in Italic characters
 - Superscript/subscript letters and complex mathematical formulas
 - Characters are written against an unevenly-colored or patterned background
 - Characters to which effects (Shadow, Outline, and the like) are applied
 - Shaded characters
 - Documents of complex layout as well as documents including unreadable characters (due to print-through and smudges)

(It may take an extended period of time to scan documents described above.)



■ [Option] button

This function is used for configuring detailed settings of PDF files. This button is enabled when "PDF(*.pdf)" is specified at [File format:]. Click [Option] button to display the following dialog box.

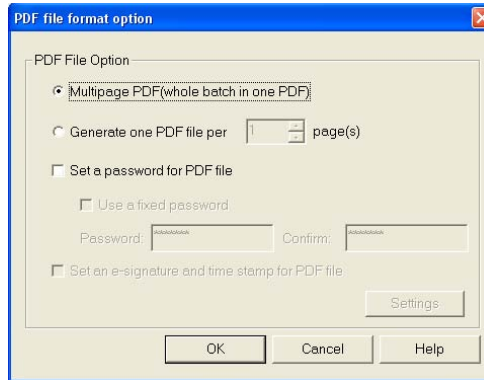

- "Multipage PDF (whole batch in one PDF)"
Creates a merged PDF file of all the scanned images.
- "Generate one PDF file per xx pages"
Create a new PDF file at each set page. For example, when "2" pages are set in this option, scanning 6 pages of documents creates 3 files.



If you select Adobe Acrobat and Adobe Reader (or Acrobat Reader) at "Application," only the first file is displayed in the dialog box when two or more files are created by one scanning. (If you select other applications, follow the specifications of the application to find out how the files are displayed.)

■ Set a password for PDF file **SCAN - Left-Click**

You can set a password for a PDF file created after scanning. It becomes impossible to open a password-protected file if you do not enter the password for that file. The "Enter password" dialog box appears whenever the scanning finishes. Enter a password two times (one is for confirmation), and then click the [OK] button.



*If you click the [Cancel] button, the file is saved as a normal PDF file without a password.

Use a fixed password

You can set a fixed password in advance for all the PDF files so that the "Enter password" dialog box will not appear when you scan.

If you select the checkbox, the [Password] and the [Confirm] fields become enabled. Enter the same password in these two fields.

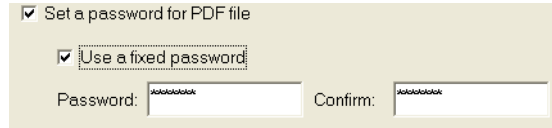

- You can set a password using the following:
 - Maximum number of characters: 16
 - Characters: A-Z, a-z, 0-9
 - Symbols: ! " # \$ % & ' () * + , - . / : ; < = > ? @ [\] ^ _ ` { | } ~
 - To use this function in Windows Vista, Adobe Acrobat must be installed on your computer.
- * Note: If you forget your password, the PDF file cannot be opened.

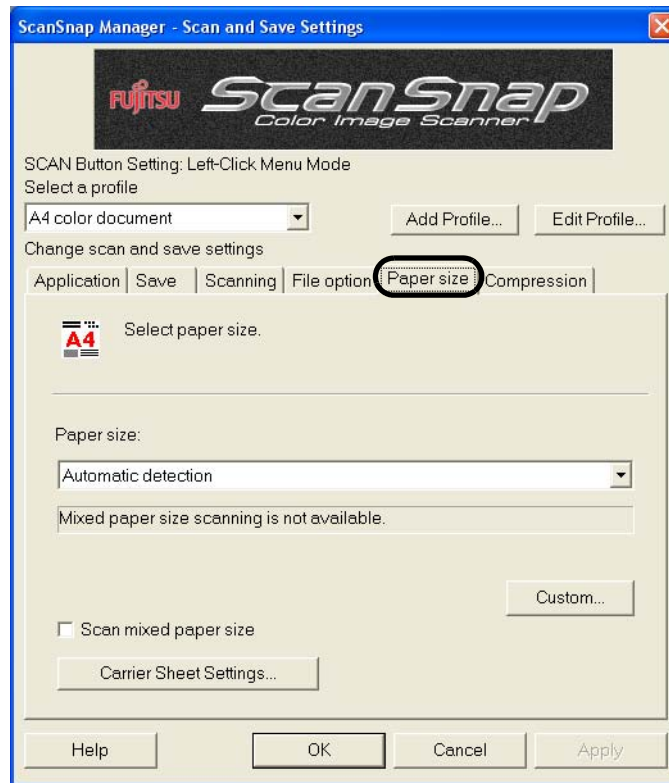

[Paper size] tab**■ Paper size:**

Specify the size of the document to be loaded on the ScanSnap.

Click the down-arrow  to select the size. The following paper sizes (W x L) can be selected.

- Automatic detection
- Letter (8.5 x 11 in (216 x 279.4 mm))
- Legal (8.5 x 14 in (216 x 355.6 mm))
- A4 (210 x 297 mm)
- A5 (148 x 210 mm)
- A6 (105 x 148 mm)
- B5 (JIS) (182 x 257 mm)
- B6 (JIS) (128 x 182 mm)
- Post card (100 x 148 mm)
- Business card (90 x 55 mm, 55 x 90 mm)
- Custom (up to 10 settings can be registered)



To use the Carrier Sheet, "Automatic detection" must be selected.

■ [Custom] button

You can use this function to register up to 10 customized document sizes at the [Paper size] menu. Clicking this button displays the following setting window:



<When adding a customized document size>

- 1) Click the [Add] button.
- 2) The following dialog box appears.

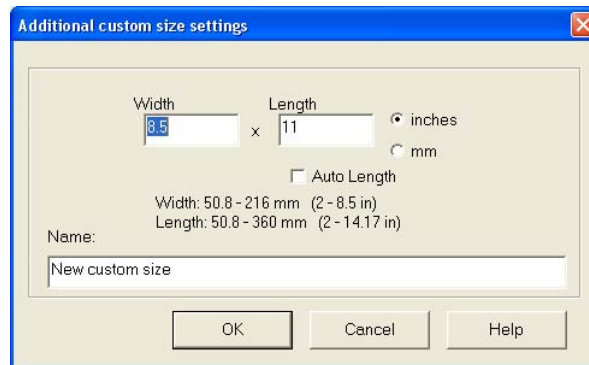

- Enter the document size within the range given below.
Width: 50.8 - 216 mm (2 - 8.5 in)
Length: 50.8 - 360 mm (2 - 14.17 in)
 - Enter a name in the [Name] field.
⇒ The name is displayed in the [Paper size] field.
- 3) To complete the setting, click the [OK] button.
⇒ The customized document size will be registered.
 - 4) Click the [Close] button to exit the "Add or Remove Custom sizes" window.

<When deleting a customized document size>

- 1) In the "Add or Remove Custom sizes" window, select the document size to be deleted and click the [Remove] button.
- 2) The confirmation message appears. Click the [Yes] button to delete the customized size.
- 3) Make sure that the selected size is deleted from the list. Click the [Close] button to exit the "Add or Remove Custom sizes" window.

<When changing the settings>

- 1) In the "Add or Remove Custom sizes" window, select the document size to be changed and click the [Change] button.
- 2) Change the settings in the "Additional custom size settings" window.
- 3) To complete the setting, click the [OK] button.
⇒ The window returns to the "Add or Remove Custom sizes" dialog box and the changes are saved.
- 4) Click the [Close] button to exit the "Add or Remove Custom sizes" window.



When you select Business card (90 mm x 55, 55 mm x 90 mm) and scan:
From the scanned length, the horizontal or vertical position is automatically recognized and scanned.
For length (loading direction), it is the actual scanned length of the card.
For width, it is fixed at 90 mm (horizontal position), or 55 mm (vertical position).



■ **"Scan mixed paper size"**

By marking the checkbox, you can scan the documents of different widths or sizes at a time.

■ **[Carrier Sheet Settings] button**

You can set or change settings to scan with the carrier sheet.



For information about how to set the Carrier Sheet Settings, refer to "4.5 Changing Carrier Sheet Settings" (page 106).



[Compression] tab

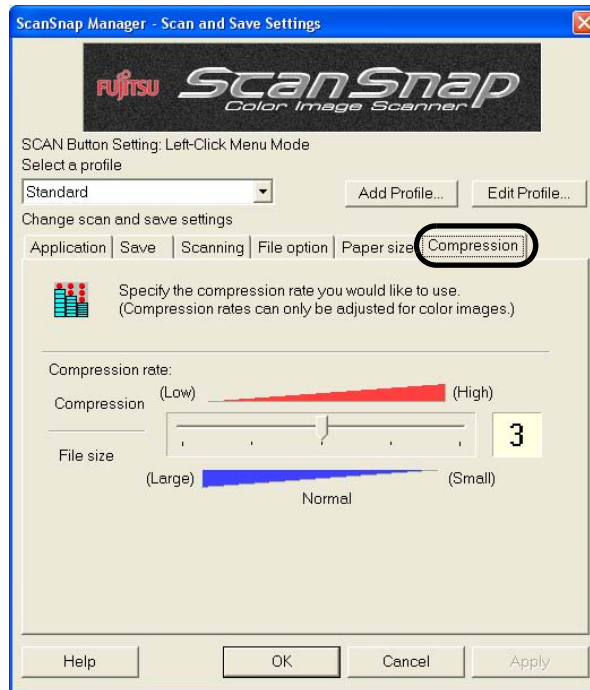

■ Compression rate:

Specify a compression rate to control file sizes of scanned images.

By moving the slider, compression rates can be changed.

The compression rate increases as the slider moves to the right. File sizes become smaller when the compression rate is high.



When the compression rate is increased, the quality of scanned images deteriorates.



- If you select "Color high compression" mode on the [Scanning] tab, the file size becomes far more smaller by increasing the compression rate.
- In "Color high compression" mode, characters and backgrounds on the document are compressed separately, and thus, the file size of the document that mostly contains text characters becomes smaller while the quality of the characters is kept high. However, this mode is not appropriate for scanning photographs or figures because these graphical materials are recognized as background and compressed as such, causing degradation in images. If this setting is specified, the contrast of the image may become higher.(page 79)
- Depending on the types of documents, file size may increase if you use color high compression mode than if you do not. The file size of the following types of documents may become larger.
 - Documents containing many pictures and/or graphics but fewer characters written in black
 - Documents of complex layout (e.g. multiple columns)
 - Documents with patterned background



About the size of image data

The following table shows a rough guideline for calculating the size of images generated when a sheet of a color document is scanned in the Simplex mode.

File type: PDF

Paper size: A4 (Brochure)

Color mode: Color

Scan mode	Compression rate				
	1	2	3	4	5
Normal quality	743	312	256	178	100
Better quality	1169	548	395	300	186
Best quality	2503	1018	790	575	352
Excellent quality	10210	4084	2884	1981	1793

Color mode: Color high compression

Scan mode	Compression rate				
	1	2	3	4	5
Normal quality	524	329	270	180	159
Better quality	787	459	393	137	97
Best quality	1107	572	238	176	147

Color mode: B&W

Scan mode	Compression rate
Normal quality	158
Better quality	247
Best quality	533
Excellent quality	2076

(unit: Kbytes)

* "Color high compression" is more effective in "Best quality" mode.

* To further decrease file sizes, change settings as follows:

- When scanning documents such as photographs or drawings, change compression rates (1 to 5).
- When scanning documents containing mostly characters in "Excellent" mode, select "Color high compression" in Color mode drop-down list.

4.3 Saving Scanning Settings

You can define up to 12 sets of preferences called profiles for scanning in Left-Click Menu Mode.

With just a click of the ScanSnap Manager icon , you can retrieve and use the saved profiles.

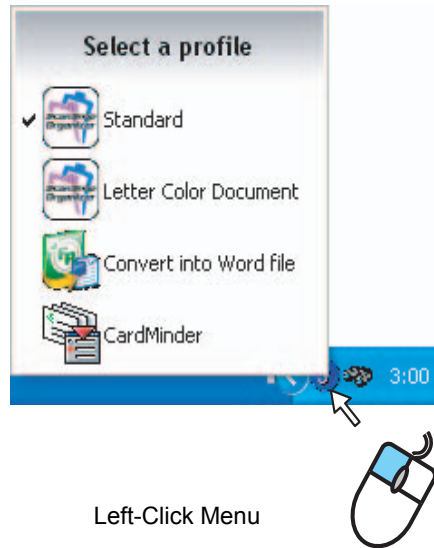

Once settings that you configure frequently for scanning are preset (profiles), you do not have to change settings in the ScanSnap Manager dialog box every time you scan documents. You can switch between profiles with simple point and click operations.



The descriptions above apply to scanning operations in the Left-Click Menu Mode.

The following explains the operations.

■ Adding Profiles



1. Right-click the ScanSnap Manager icon **S**, and make sure that [Use ScanSnap Quick Menu] is unchecked.

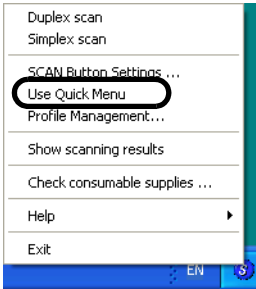

⇒ When you uncheck [Use ScanSanp Quick Menu], the Right-Click Menu above disappears once.

HINT  When [Use ScanSnap Quick Menu] is marked, the [SCAN] button enters Quick Menu Mode. You cannot add or edit profiles in the Quick Menu Mode.

2. Right-click the ScanSnap Manager icon **S**, and then select [SCAN Button Settings].

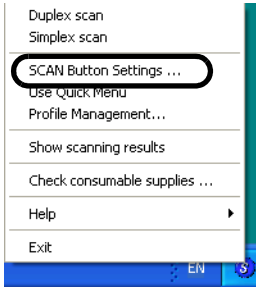

3. In the "ScanSnap Manager - Scan and Save Settings" dialog box, change scanning settings to meet your preferences.



4. When all changes have been made, click the [Add Profile] button.

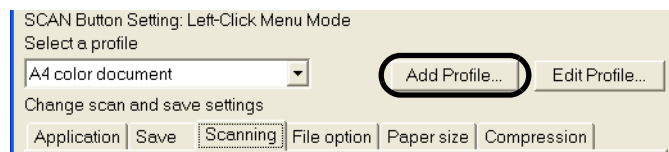

⇒ The "Add new profile" dialog box appears.

5. Type in a profile name, and then click the [OK] button.

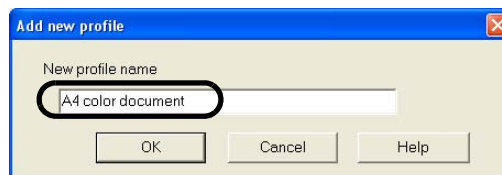

⇒ The new profile appears in the "Select a profile" drop-down list.

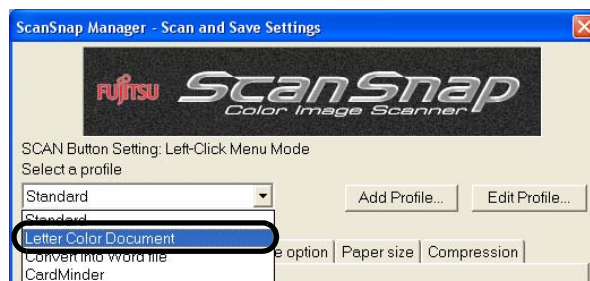

6. Click the [OK] button to close the "ScanSnap Manager - Scan and Save Settings" dialog box.

⇒ Now, you have finished adding a new profile.



- You can add up to 12 profiles, including the "Standard" profile. (The "Standard" profile cannot be deleted.)
- You can change the sequence of the profiles except for the "Standard" profile.
 1. Right-click the ScanSnap Manager icon, and then select [Profile Management] to open the "Profile Management" window.
 2. Select a profile name from the list to arrange profiles in a different sequence.
 3. Click the [Up] or [Down] button to move the profile name up or down.

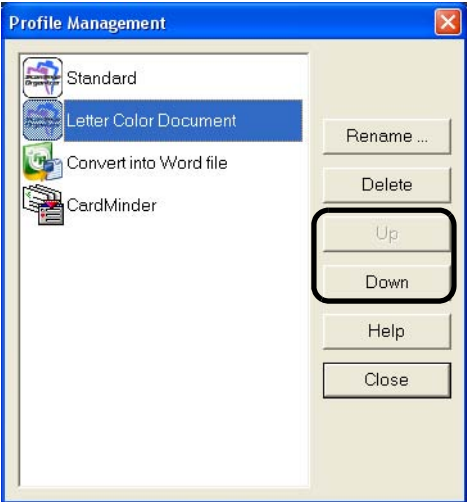

4. Click the [Close] button.

4

■ Scanning with an Added Profile



1. Left-click the ScanSnap icon .



⇒ The Left-Click Menu appears.
(Icons of applications that start-up after scanning appear on the left of each profile.)

2. Select a profile to use for scanning.

⇒ The selected profile is marked.

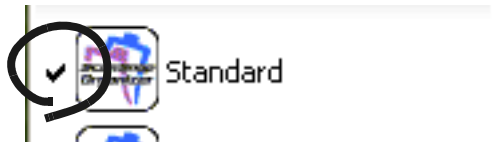

3. Load the document on the ScanSnap.

4. Press the [SCAN] button .

⇒ The document is scanned according to the settings of the selected profile.

■ Changing Settings for Profiles



1. Right-click the ScanSnap icon **S**, and then select [SCAN Button Settings].

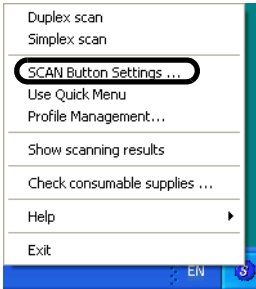

2. From the "Select a profile" drop-down list in the "ScanSnap Manager - Scan and Save Settings" dialog box, select a profile you want to change settings for.

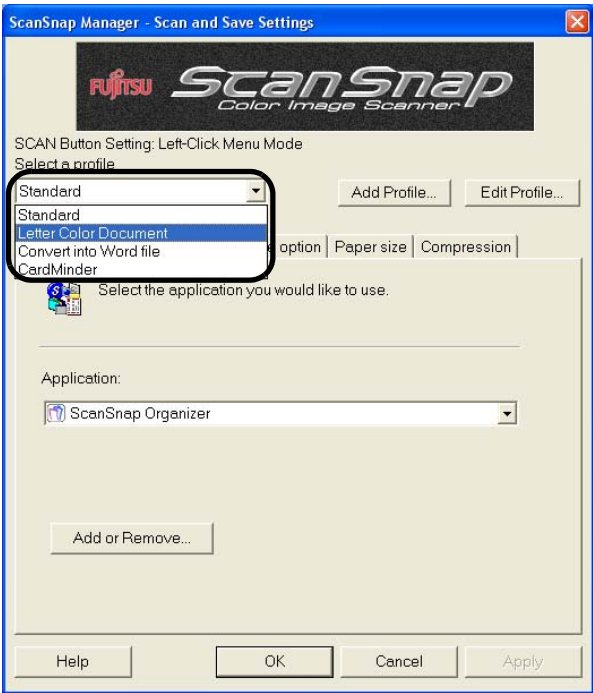

3. Change settings for the selected profile.

For detailed information on how to configure scanning settings for profiles, refer to "4.2 Changing Scanning Settings" (page 67).

- When you finish changing the settings for the selected profile, click the [OK] button.

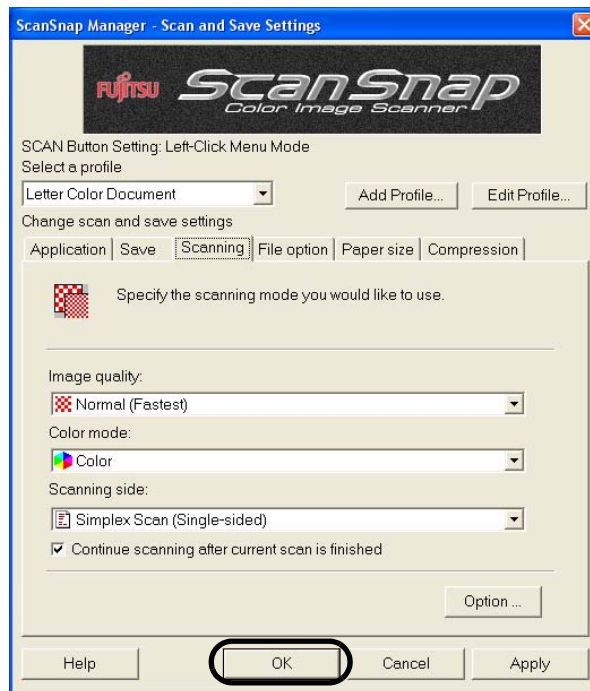

- ⇒ A confirmation message appears to ask you whether you want to overwrite the profile with new settings.



If you select another profile from the "Select a profile" drop-down list before clicking the [OK] button, the following message appears.

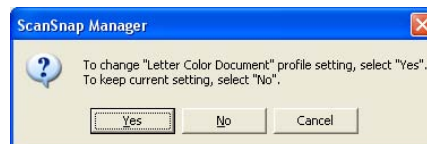

Upon clicking the [Yes] button in the message window above, new settings made to the profile take effect, and the profile is switched to another one. If the [No] button is clicked, no changes are made to the profile, and the profile is switched to another one. If the [Cancel] button is clicked, you will be returned to the "ScanSnap Manager - Scan and Save Settings" dialog box.

- To overwrite the profile, select the [Yes] button. If the [No] button is clicked, changes are reflected to the "Standard" profile.

If the [Cancel] button is clicked, you will be returned to the "ScanSnap Manager - Scan and Save Settings" dialog box.

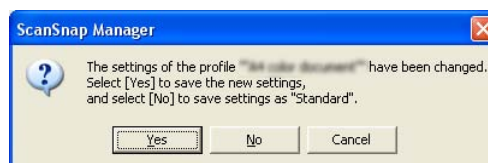

(When the settings are saved for the "Standard" profile, the confirmation message will not appear.)

Renaming Profiles



- 1. Right-click the ScanSnap icon **S**, and then select [SCAN Button Settings].

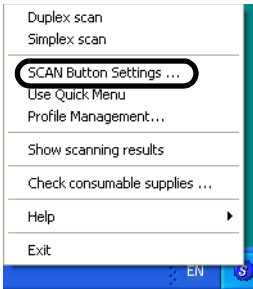

⇒ The "ScanSnap Manager - Scan and Save Settings" dialog box appears.

- 2. Click the [Edit Profile] button.



⇒ The "Profile Management" dialog box appears.

- 3. Select a profile name from the list, and click the [Rename] button.



- 4. In the "Rename" window, type in a new name.

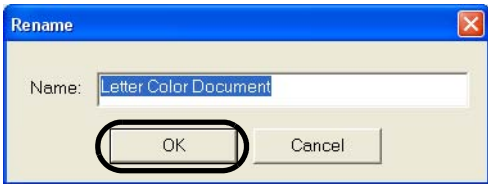

- 5. Click the [OK] button

⇒ The selected profile is renamed.



You can also invoke the "Profile Management" dialog box by right-clicking the ScanSnap icon **S**.

The "Profile Management" dialog box appears when [Profile Management] in the Right-Click Menu, which pops up.

Change profile names as you do in the "ScanSnap Manager - Scan and Save Settings" dialog box; select a profile name from the list, and then perform steps 3 to 5.

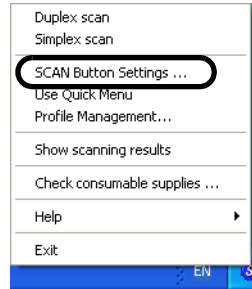

■ Deleting Profiles



- 1. Right-click the ScanSnap icon **S**, and then select [SCAN Button Settings].

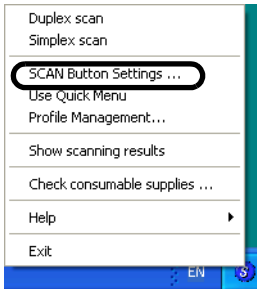

⇒ The "ScanSnap Manager - Scan and Save Settings" dialog box appears.

- 2. Click the [Edit Profile] button.



⇒ The "Profile Management" dialog box appears.

- 3. Select a profile name from the list, and then click the [Delete] button.

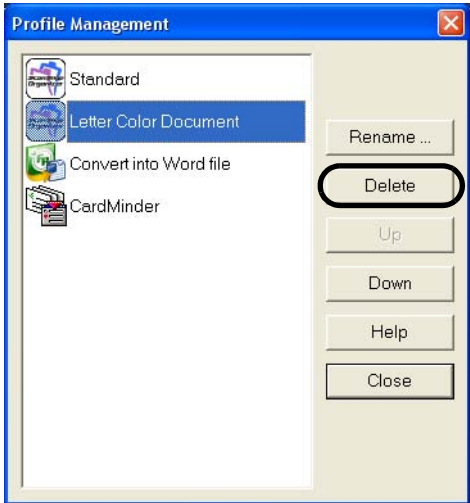



You can also invoke the "Profile Management" dialog box by right-clicking the

ScanSnap icon **S**.

The "Profile Management" dialog box appears when [Profile Management] in the Right-Click Menu, which pops up.

Delete profile names as you do in the "ScanSnap Manager - Scan and Save Settings" dialog box; select a profile name from the list, and then click the [Delete] button.

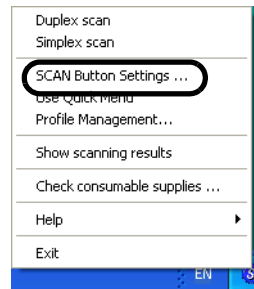

4. The "Delete Profile" dialog box appears to confirm the deletion. Click the [Yes] button to delete the profile.

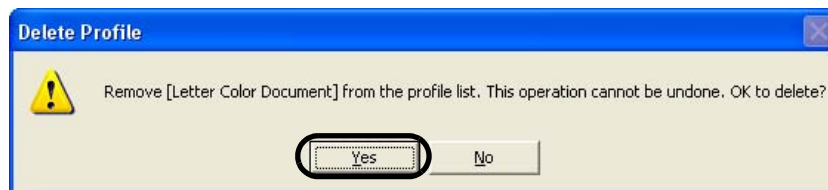

4.4 Using the ScanSnap Quick Menu

When the ScanSnap is in Quick Menu Mode, the ScanSnap Quick Menu pops up upon scanning with a [SCAN] button press.

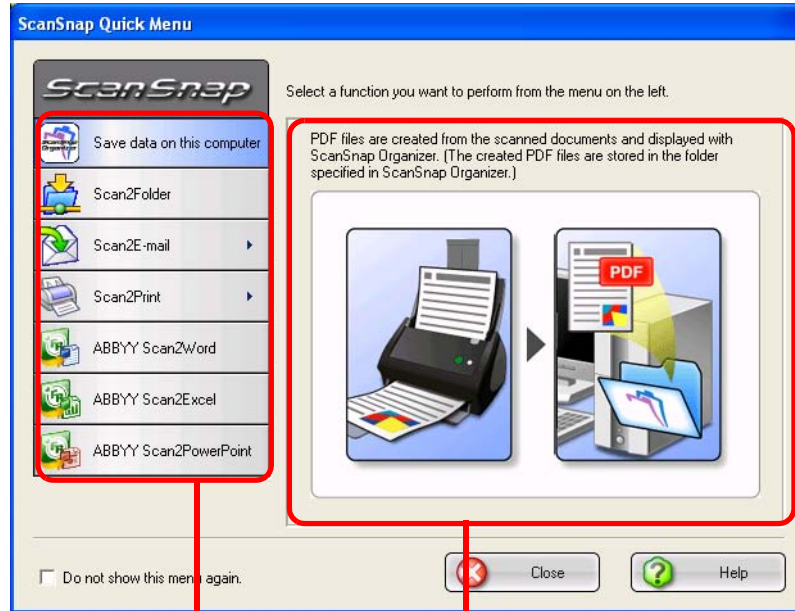

Action List

Descriptions of the selected action

In this menu, you can select an action as follows:

Action List

You can select an action you want to perform with scanned images.
Place the mouse pointer on an action and click it to perform any action.
Up to eight actions are selectable.

Action	Description
Save data on this computer *1	PDF files are created based on the scanned images, and ScanSnap Organizer is started to display the scanned images. Those files are saved in a folder (on your personal computer) specified in ScanSnap Organizer.
Scan2Folder	PDF files are created based on the scanned images and saved in a specified folder (shared folder). ⇒ "5.2 Saving Data in the Specified Folder" (page 117)

Scan2E-mail	PDF files are created based on the scanned images and an e-mail program is started with the PDF files attached to an e-mail message. ⇒ "5.3 Sending Files by E-Mail" (page 129)
Scan2Print	Scanned images are printed with the printer. ⇒ "5.4 Using the ScanSnap as a Copy Machine" (page 145)
ABBYY Scan2Word *2	The scanned images are processed through OCR and converted into Word files. ⇒ "5.5 Converting into Word / Excel / PowerPoint Files" (page 155)
ABBYY Scan2Excel *2	The scanned images are processed through OCR and converted into Excel files. ⇒ "5.5 Converting into Word / Excel / PowerPoint Files" (page 155)
ABBYY Scan2PowerPoint *2	The scanned images are processed through OCR and converted into PowerPoint files. ⇒ "5.5 Converting into Word / Excel / PowerPoint Files" (page 155)

*1: This is not available unless ScanSnap Organizer is installed.

*2: This is not available unless ABBYY FineReader for ScanSnap 3.0 is installed.

Descriptions of the selected action

An illustrated description of each action.

The [Settings] button is displayed when there are required settings to be configured for the selected action.

[Setting] button

When you find an arrow button ► on an action button, you can change settings for that action. Place the mouse cursor on the arrow button ► to display the [Setting] button of an action you want to use.

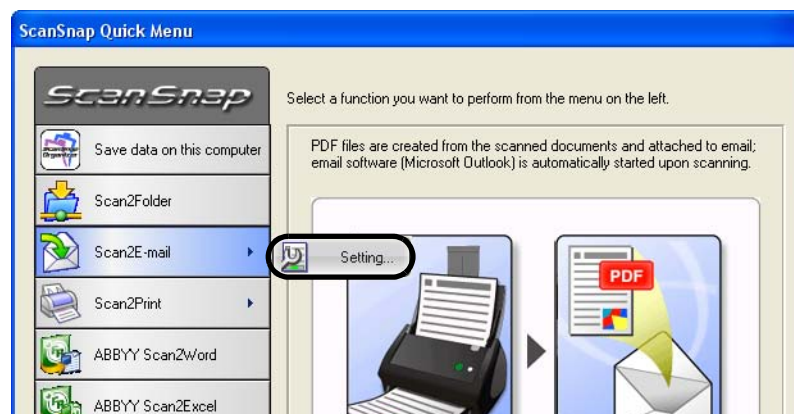



The [Setting] buttons are displayed when following actions are selected:

- Scan2E-mail (⇒ page 129)
- Scan2Print (⇒ page 129)

"Do not show this menu again" checkbox

If this checkbox is marked, the ScanSnap Quick Menu is not displayed again.

The mode used for scanning is switched from Quick Menu Mode to Left-Click Menu Mode.

When you want to use the ScanSnap Quick Menu, mark [Use ScanSnap Quick Menu] on the Right-Click Menu.

[Close] button

The action is canceled.

When this button is clicked, the following dialog box appears.

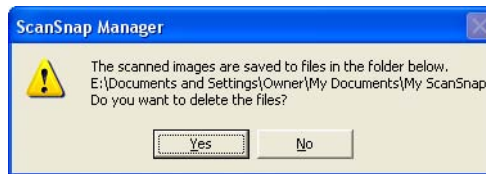

[Yes] button: Scanned images are deleted and the action is canceled.

[No] button: Scanned images are saved in a folder specified in the "ScanSnap Manager - Scan and Save Settings" dialog box in PDF format and the action is canceled.

[Cancel] button: You will be returned to the ScanSnap Quick Menu.

[Help] button:

Help topics about the ScanSnap Quick Menu are displayed.



- When the ScanSnap Quick Menu is displayed, the ScanSnap does not work even if you press the [SCAN] button. Select one of actions in the menu and complete the action before scanning another document.
- Do not move, delete, or rename files in other applications when the ScanSnap Quick Menu is displayed.

4.5 Changing Carrier Sheet Settings

Carrier Sheet settings can be changed in the "Carrier Sheet Settings" dialog box.

The "Carrier Sheet Settings" dialog box appears when the [Carrier Sheet Settings] button on the [Paper size] tab is clicked.

Right-click the ScanSnap Manager icon **S** on the task bar, and select [SCAN Button Settings] from the menu.

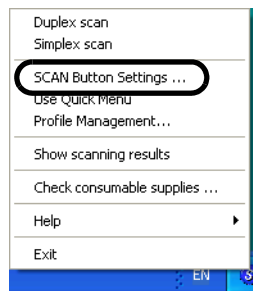

⇒ The "ScanSnap Manager - Scan and Save Settings" dialog box appears.

Click the [Carrier Sheet Setting] button on the [Paper size] tab to display "Carrier Sheet Settings" dialog box.



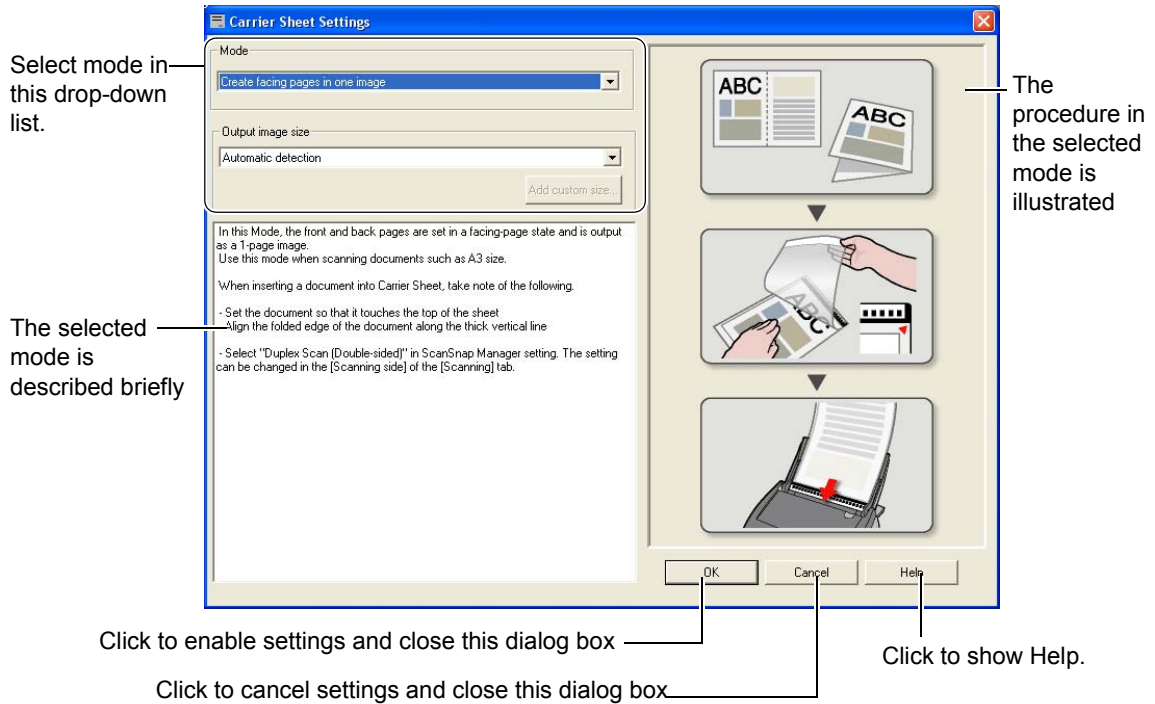

The following explains settings you can change in the "Carrier Sheet Settings" dialog box.

Mode

You can specify a method of scanning with the Carrier Sheet.

There are two modes:

- **Create facing pages in one image**

This mode is used for scanning a document in duplex mode, folding it in half. A double-page spread image is output, combining the front and back page images.

Use this mode for scanning a document larger than A4 size up to A3, B4, or 11" x 17" (single side).

- **Create front and back images separately**

This mode is used for creating scanned images in their original sizes by cropping them.

Use this mode for scanning documents that are difficult to set directly on the ScanSnap with the Carrier Sheet.

For examples; photographs, on which you do not want to make scratches, or irregular-sized documents such as clippings of articles.

In this mode, the front and back side images are output separately, if scanned in duplex mode.



- When scanning documents in [Create facing pages in one image] mode, select [Duplex Scan] in the "Scanning side" drop-down list on the [Scanning] tab of the "ScanSnap Manager - Scan and Save Settings" dialog box.
- How to load documents differs between modes. For details, refer to "3.3 Loading Documents" (page 49).

Output Image Size

You can specify an image size to output images of scanned documents.
You can select it from the following paper sizes.

Mode: Create facing pages in one image	Mode: Create front and back images separately
Automatic Detection	Automatic Detection
A3 (297 x 420 [mm])	-
-	Carrier Sheet size (216 x 297 [mm])
-	A4 (210 x 297 [mm])
-	A5 (148 x 210 [mm])
-	A6 (105 x 148 [mm])
-	Post Card (100 x 148 [mm])
B4 (JIS) (257 x 364 [mm])	-
-	B5 (JIS) (182 x 257 [mm])
-	B6 (JIS) (128 x 182 [mm])
-	Letter (8.5 x 11 [in.], 216 x 279.4 [mm])
11 x 17 (11 x 17 [in.], 279.4 x 431.8 [mm])	-
-	Business Card Portrait (55 x 90 [mm])
-	Business Card Landscape (90 x 55 [mm])
-	Custom (up to 10 sizes can be created)



- When you select [Automatic Detection] in the "Output image size" drop-down list, scanned document sizes are automatically detected, and each image is output in a standard size (other than Custom and Carrier Sheet Size) in the above table, which best matches the original document size. You do not have to select a size in the "Output image size" drop-down list every time.
- When you select [Carrier Sheet size] in the "Output image size" drop-down list, images are output in the Carrier Sheet size. With Adobe Acrobat, you can trim images to create images in a preferred size.
In Adobe Acrobat, to trim an image, select [Tools] from the menu bar, and select [Advanced Editing] ⇒ [Crop tool]. Select a rectangular area you want to trim using the Crop tool, and then double-click the selected area.



- When you select [Automatic Detection] in the "Output image size" drop-down list and scan an irregular-sized document (not in the table above), the scanned image is output in a standard size that is larger than and the nearest to the original document size. If you want to output a scanned document image in its original size, add a custom size beforehand in the "Add or Remove Custom sizes" dialog box, which appears when the [Custom] button is clicked, and then select the added size in the "Output image size" drop-down list.
- When you select [Automatic Detection] in the "Output image size" drop-down list, the output image size may be larger than the original. If so, try the following:
 - Insert a document into the Carrier Sheet so that the sides of the document and Carrier Sheet becomes parallel.
 - Adjust the side guides to the width of the Carrier Sheet to prevent the Carrier Sheet from skewing.

If the situation does not improve, select a size in the "Output image size" drop-down list.

[Add custom size] button

You can create up to 5 custom sizes.

Clicking the [Add custom size] button displays the following dialog box.

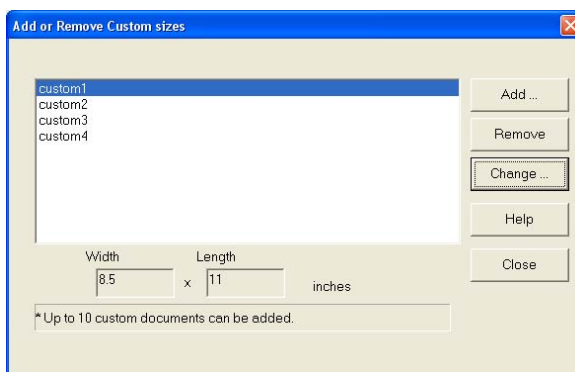

To add custom size documents

- 1) Click the [Add] button.
- 2) The following dialog box appears.

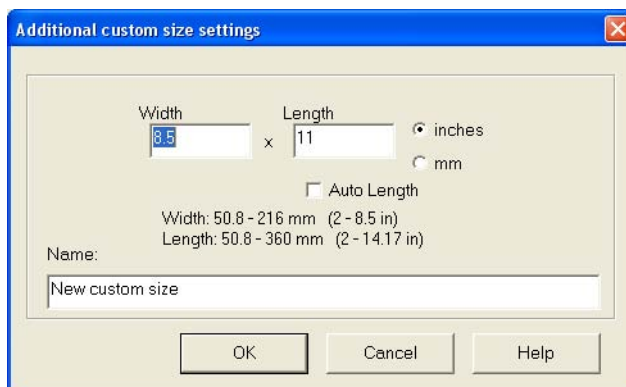

- Type in the width and length.

You can create custom sizes of the following:

Width: 50.8 - 216 mm (2 - 8.5 in.)

Length: 50.8 - 297 mm (2 - 11.69 in.)

- Type in a name you want to use for the custom size in the "Name" field.

⇒ The new name is added in the "Output image size" drop-down list.

- 3) When you finish, click the [OK] button.
⇒ A new custom size is added in the list.
- 4) Click the [Close] button to close the "Add or Remove custom sizes" dialog box.

To delete custom sizes

- 1) In the "Add or Remove custom sizes" dialog box, select a custom size you want to delete, and click the [Delete] button.
- 2) In the confirmation message window, click the [Yes] button.
- 3) In the "Add or Remove custom sizes" dialog box, verify that the custom size is deleted, and then click the [Close] button.

To change settings

- 1) In the "Add or Remove custom sizes" dialog box, select a custom size you want to change settings, and then click the [Change] button.
- 2) The "Additional custom sizes settings" dialog box appears. Make change to meet your preferences.
- 3) When you finish, click the [OK] button.
⇒ The "Add or Remove custom sizes" dialog box appears, and changes made take effect.
- 4) Click the [Close] button to close the "Add or Remove custom sizes" dialog box.

4.6 About Automatic Interaction with Applications

ScanSnap Organizer and CardMinder can automatically interact with the ScanSnap upon startup. There are two ways of interacting.

■ Automatic Interaction Mode (When to Interact)

(1) When any one of above applications is selected (active), the ScanSnap interacts with it. (Default setting)

When ScanSnap Organizer or CardMinder becomes active, or, in other words, when one of them is selected on the task bar and its window is brought to the front, an application selected in the "Application" drop-down list on the [Application] tab of the "ScanSnap Manager - Scan and Save Settings" dialog box is automatically switched to the active application. When you scan documents, scanned document images are opened with the active application.

When the application becomes inactive or it is deselected, the ScanSnap no longer interacts with the application.

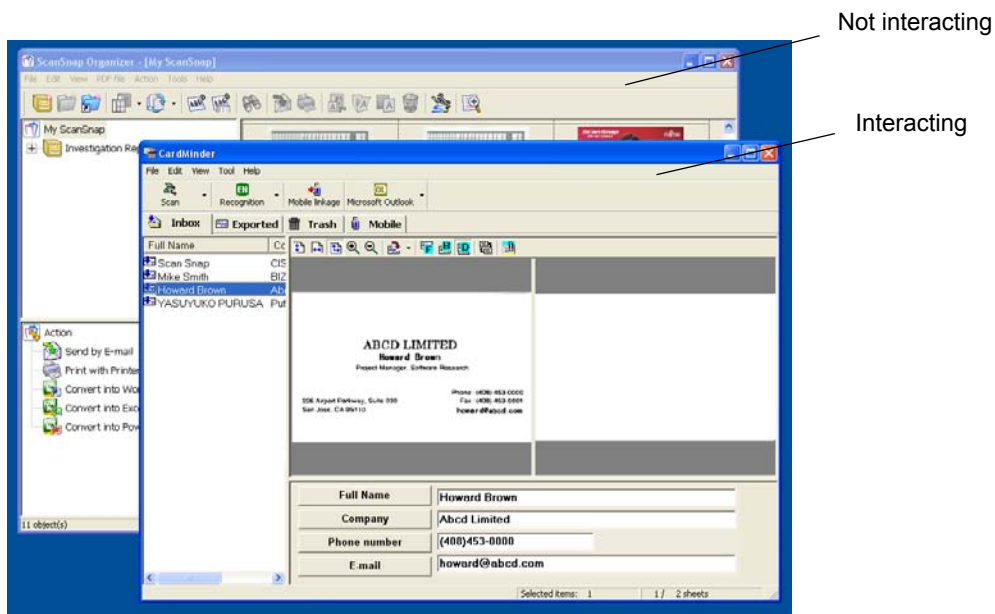

(2) The ScanSnap always interacts with an application that is running and has higher priority (when more than one application is running).

When ScanSnap Organizer or CardMinder is running, an application selected in the "Application" drop-down list on the [Application] tab of the "ScanSnap Manager - Scan and Save Settings" dialog box is automatically switched to the running application (when more than one application is running, an application that has higher priority is selected). When you scan documents scanned document images are opened with the selected application. Even if the ScanSnap is in Quick Menu Mode, the ScanSnap Quick Menu will not appear after scanning. Be aware that scanned document images are opened with the selected application.

The ScanSnap interacts with the application until you exit the application.

When more than one application is running, CardMinder has highest priority, and Rack2 Library lowest.

When the ScanSnap is in Left-Click Mode, the interacting application name on the Left-Click Menu is followed by "is interacting."



When ScanSnap Organizer is interacting with the ScanSnap

■ Changing "When to Interact" Options

Follow the procedure below to change "When to Interact" options described above.



1. Right-click the ScanSnap icon **S**, and then select [Help] ⇒ [Preferences].

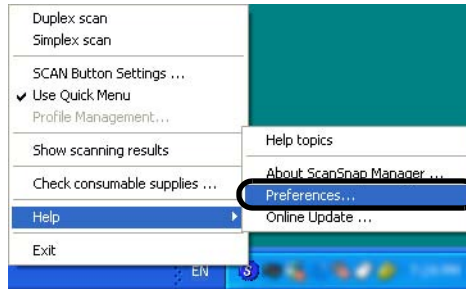

2. Select either of settings on the [Automatic interaction] tab.

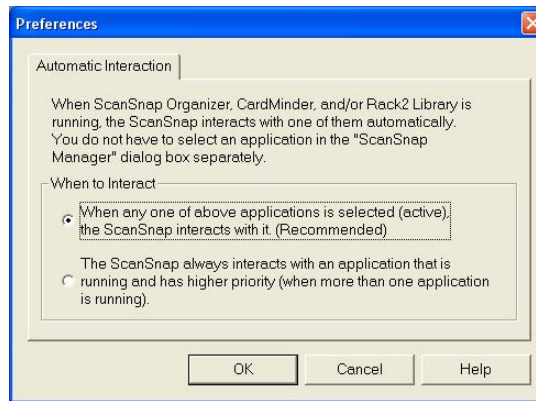

When any one of above applications is selected (active), the ScanSnap interacts with it. (Default setting)

When ScanSnap Organizer or CardMinder becomes active, or, in other words, when one of them is selected on the task bar and its window is brought to the front, an application selected in the "Application" drop-down list on the [Application] tab of the "ScanSnap Manager - Scan and Save Settings" dialog box is automatically switched to the active application.

The ScanSnap always interacts with an application that is running and has higher priority (when more than one application is running).

When ScanSnap Organizer or CardMinder is running, an application selected in the "Application" drop-down list on the [Application] tab of the "ScanSnap Manager - Scan and Save Settings" dialog box is automatically switched to the running application.

Chapter 5



About Actions

This chapter describes about actions in the Action List.

5.1 About Actions in the Action List	116
5.2 Saving Data in the Specified Folder	117
5.3 Sending Files by E-Mail	129
5.4 Using the ScanSnap as a Copy Machine	145
5.5 Converting into Word / Excel / PowerPoint Files	155

5.1 About Actions in the Action List

The ScanSnap has frequently-used functions at the ready in the Action List to help you make efficient use of your time at your office.

Actions in the Action List are helpful when:

- you want to share document files scanned with the ScanSnap with other members.
⇒ Simply press the [SCAN] button, you can save document files in a shared folder on a network upon scanning. In addition, all members are informed of the destination folder path by e-mail.
- you want to send document files used in a meeting about to start to all persons concerned.
⇒ Simply press the [SCAN] button, and you can quickly send an e-mail message with document files attached.
- you want to use a printer, rather than a copy machine, to make copies of documents.
⇒ Simply press the [SCAN] button, you can print documents with a printer.
- you want to use text in your paper documents but do not want to type it manually.
⇒ Simply press the [SCAN] button, and you can convert an electric picture of text into a form your text-based applications, such as Word, Excel, and PowerPoint, can use.

The following are explanations on how to use the Action menu.

5.2 Saving Data in the Specified Folder

This section describes how to save image files scanned with the ScanSnap in a shared folder. By using this action, you can save image files scanned with the ScanSnap in a networked folder to share information among group members.

When you scan documents with the ScanSnap, image files are created and saved in a specified folder.

A function of notifying group members of a path to the folder by e-mail is also ready.

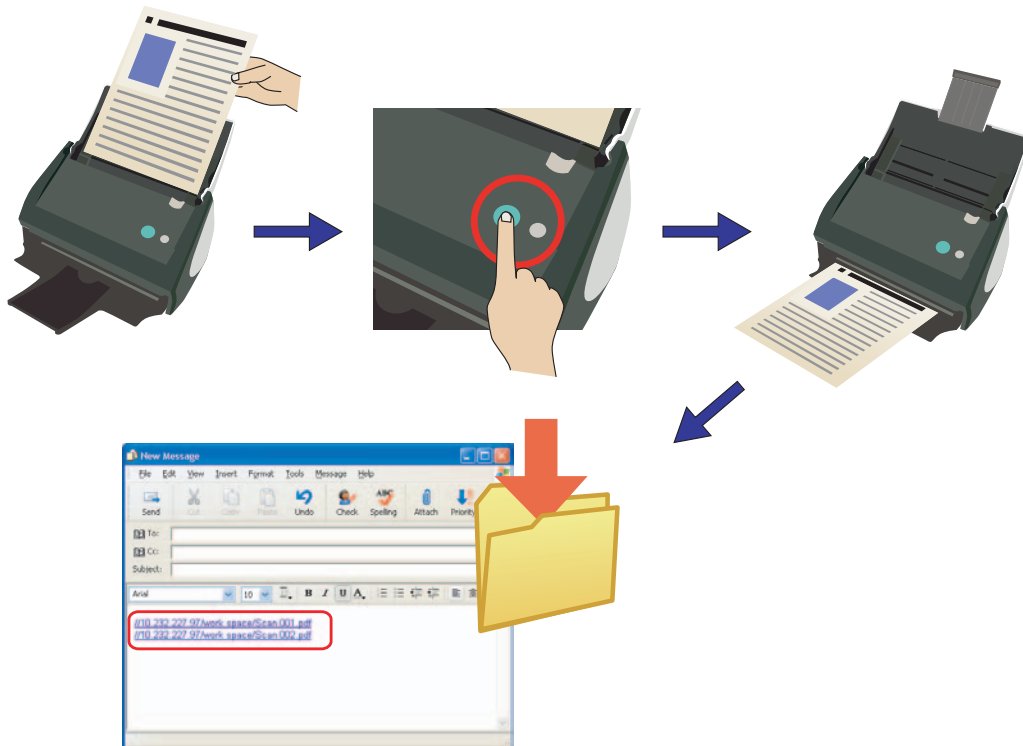



- An e-mail program selected in the "E-mail" drop-down list on the [Programs] tab of the "Internet Options" dialog box will be used; to display the "Internet Options" dialog box, select the [Tools] menu within the Microsoft® Internet Explorer browser, and then select [Internet Options].
If no e-mail program is selected, select an e-mail program you want to use in the "E-mail" drop-down list.

Operations with the following e-mail programs have been checked.

- Microsoft® Windows® Mail (in Windows Vista)
- Microsoft® Outlook® 2003
- Microsoft® Outlook Express V6.0
- Netscape Messenger V4.5
- Eudora Pro® V4.0.1
- Thunderbird Version 1.5.0.7
- Even if you use an e-mail program selected in the "E-mail" drop-down list on the [Programs] tab of the "Internet Options" dialog box (in the [Tools] menu in Microsoft® Internet Explorer), the e-mail program may not interact with the ScanSnap properly. In this case, contact the manufacturer of that e-mail program.
- It has been confirmed that attached file extensions are changed if sending attached files by e-mail failed when the following conditions are met:
 - The operating system you are using is Windows XP (Professional, Home Edition).
 - You have set Hotmail as a default e-mail program.
(File extensions are changed to those including a character "^".)
This problem occurs when a combination of Window XP and Hotmail is used. When you send attached files by e-mail through Explore, the same problem will occur.
Use other e-mail programs with which correct operations are verified (as of December 2006).

■ Operations in Quick Menu Mode



1. Load the document on the ScanSnap.

For details, refer to sections "3.2 Paper Size of Documents to be Scanned" (page 46) and "3.3 Loading Documents" (page 49).

2. Press the [SCAN] button .

⇒ Scanning is started.

⇒ When scanning is complete, the ScanSnap Quick Menu appears.

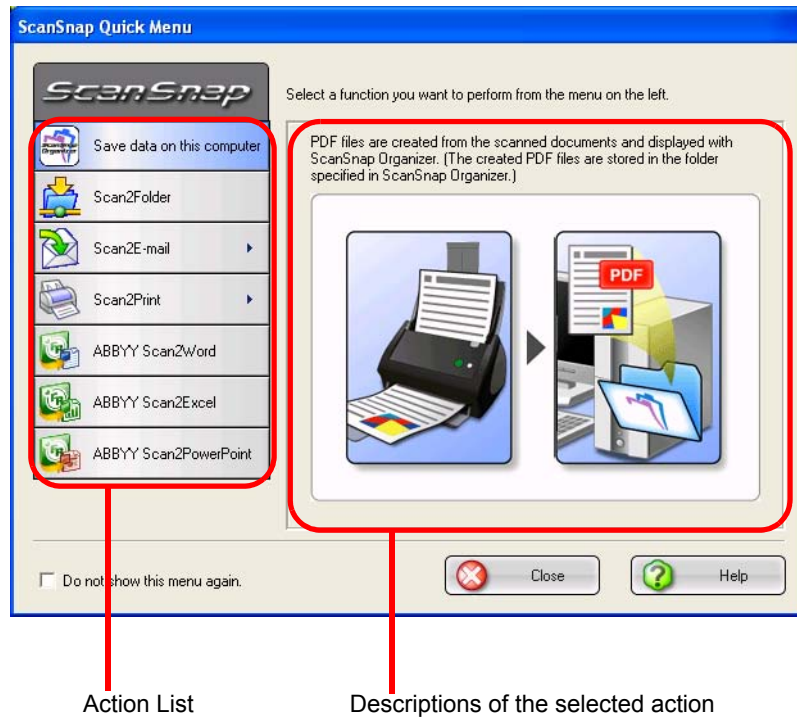

3. Place the mouse cursor on [Scan2Folder].

⇒ A description of the [Scan2Folder] action is displayed.

4. Click the [Scan2Folder] action.

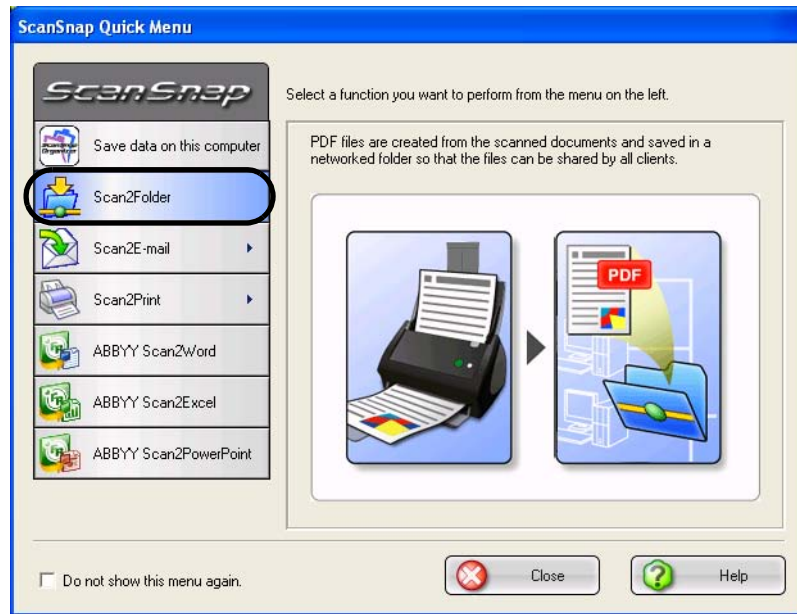

⇒ A preview window appears.

5. Verify a scanned image in the preview window.

You can also change file names and destination folders and specify whether to state a path to a destination folder in an e-mail message to notify other members of it.

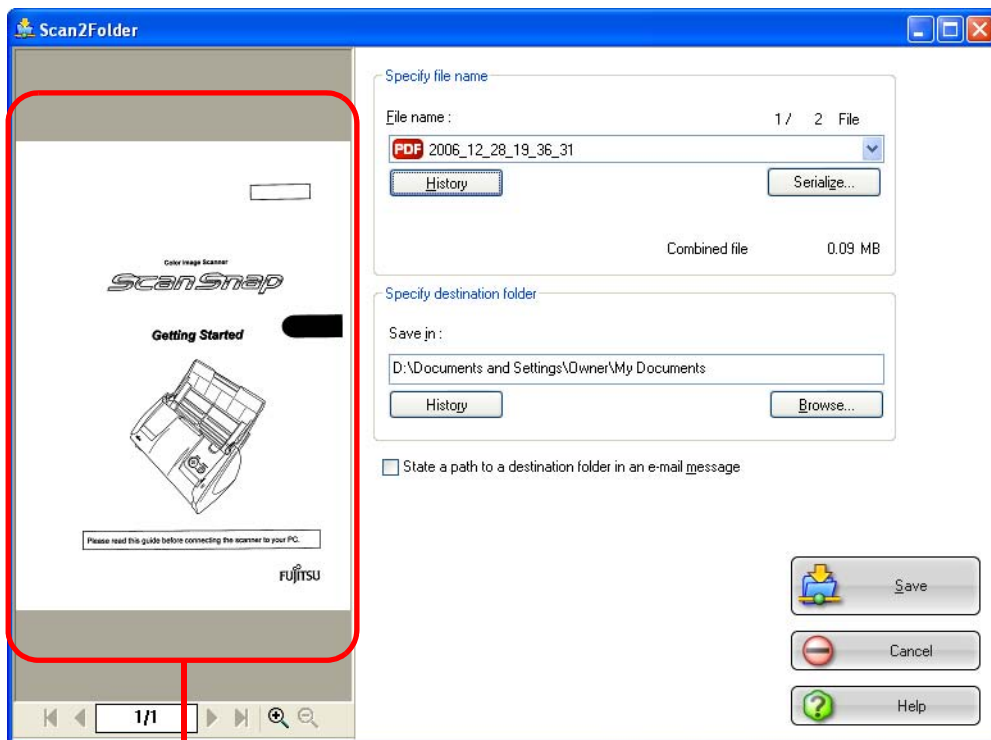







Preview Window

Preview Window

The image of the selected file is displayed.

You can use the following navigation controls for paging through documents:

-  : To go to the first page, click this First Page button.
-  : To go to the previous page, click this Previous Page button.
-  : To go to the next page, click this Next Page button.
-  : To go to the last page, click this Last Page button.
- : Current page number / Total page number
-  : To zoom in, click this button.
-  : To zoom out, click this button.

Drag the vertical scroll bar or use mouse actions to move around the page so that you can view all the areas of it when the image is enlarged.

Specify file name

The name of a selected file and the number and combined size of files are displayed under "Specify file name."

You can change file names and select a file to display.

File name

The currently selected file name is displayed.



You can type a file name in this combo box to change the file name.

Up to 100 characters can be used for a file name.

When there is more than one file to display, click the down-arrow button

() to select another file from the drop-down list.

Numbers (X / Y) to the right of "File name" are the currently displayed file's position in the list (X) and the total number of files (Y).

[History] button

File names you have specified before are displayed in the "History" list; only file names you changed in the "File name" field are added to the list. (Up to 10 file names can be listed. When the 11th or later file name is specified, a file name is deleted in chronological order.)

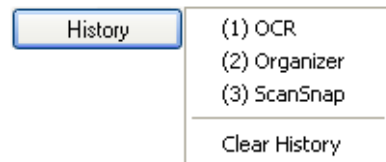

Select a file name, and all file names listed in the "File name" drop-down list are changed to the selected file name.

Selecting [Clear History] deletes all file names in the list.

[Serialize] button

When there are multiple files, a serial number is appended to the file name; a file name and serial number is combined using "_" (underscore). The maximum number of digits you can specify for a serial number is 6.

When you use this button, a currently selected file name is used in common.

Example: When there are three files in the drop-down list, Scan.pdf, Snap.pdf, and S510.pdf, if you select "Snap.pdf" in the drop-down list and specify "3" as the number of digits, names of these three files are changed to Snap_001.pdf, Snap_002.pdf, and Snap_003.pdf.

Combined file

The file size is displayed in megabytes. When there are multiple files, the combined file size is displayed.

Specify destination folder

A path to a destination folder is displayed. You can change a destination folder in this dialog box.

Save in

The path name to the currently selected folder is displayed.

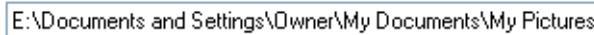

E:\Documents and Settings\Owner\My Documents\My Pictures

You can also type a path name in this field to change destination folders. Use up to 220 characters for a path name including a file name.

[History] button

The path names of folders you have specified before are displayed in the History list. (Up to 10 folder names can be added in the list. When the 11th or later path name is specified, a path name is deleted in chronological order.)

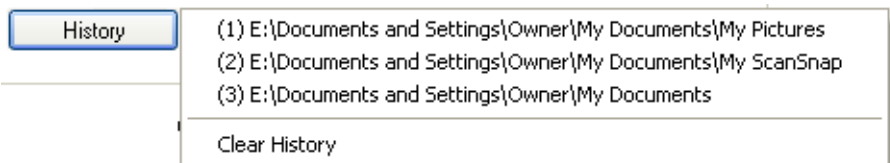

Select a path name, and the selected path name is displayed in the "Save in" field.

Selecting [Clear History] deletes all path names.

[Browse] button

Use this button when selecting a destination folder.

"State a path to a destination folder in an e-mail message" checkbox

After files are saved in a specified folder, an e-mail program is started with the path to the specified folder being stated in an e-mail message.

[Save] button

Clicking this button saves files using settings configured in this dialog box.

[Cancel] button

Clicking this button cancels all changes made in this dialog box and returns you to the previous window (the ScanSnap Quick Menu).

[Help] button

You can view Help topics related to the preview window.

6. Click the [Save] button

⇒ Files are saved in the specified folder.

⇒ When you mark the "State a path to a destination folder in an e-mail message" checkbox in this dialog box, an e-mail message is created with the path to the destination folder being stated.

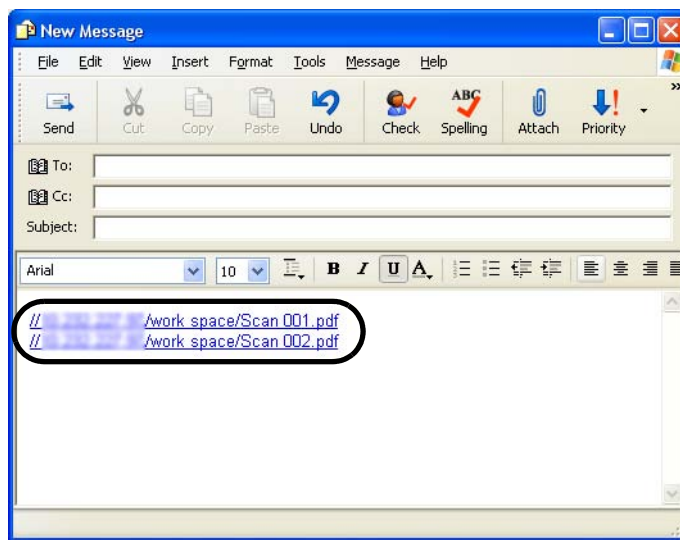

- When the ScanSnap Quick Menu is displayed, the ScanSnap does not work even if you press the [SCAN] button. Select one of actions in the menu and complete the action before scanning another document.
- Do not move, delete, or rename files in other applications after the ScanSnap Quick Menu is displayed and before the "Preview" window is closed.

■ Operations in Left-Click Menu Mode



1. Select [SCAN Button Settings] in the Right-Click Menu, which pops up when the ScanSnap Manager icon  is right-clicked.

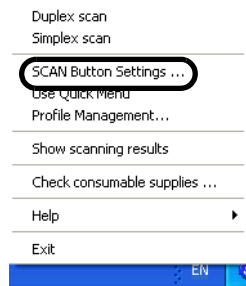

⇒ The "Scan and Save Settings" dialog box appears.

2. In the "Application" drop-down list on the [Application] tab, select "Scan2Folder."



3. Click the [OK] button.

⇒ The "ScanSnap Manager -Scan and Save Settings" dialog box closes



Changes you have made in the above procedure take effect from the next time you scan documents using the Left-Click Menu. For details on how to change settings, refer to section "4.3 Saving Scanning Settings" (page 92).



4. Load the document on the ScanSnap.

For details, refer to sections "3.2 Paper Size of Documents to be Scanned" (page 46) and "3.3 Loading Documents" (page 49)

5. Press the [SCAN] button .

⇒ Scanning is started.

⇒ When scanning is complete, the preview window appears.



6. Verify a scanned image in the preview window.

You can also change file names and destination folders and specify whether to state a path to a destination folder in an e-mail message to notify other members of it.

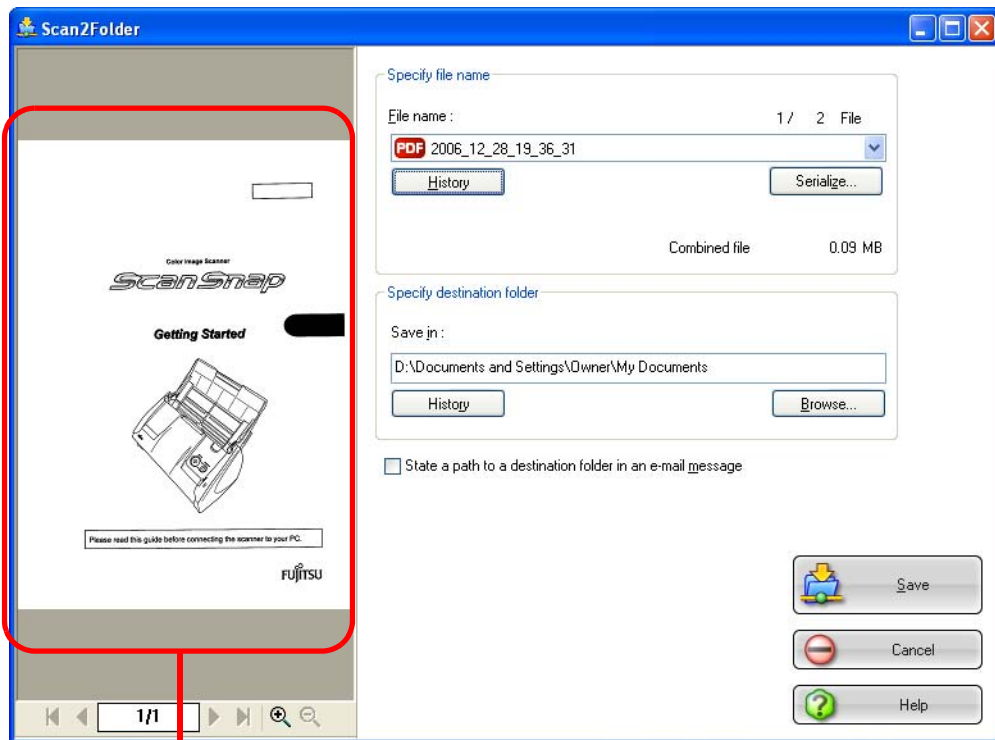







Preview Window

Preview Window

The image of the selected file is displayed.

You can use the following navigation controls for paging through documents:

-  : To go to the first page, click this First Page button.
-  : To go to the previous page, click this Previous Page button.
-  : To go to the next page, click this Next Page button.
-  : To go to the last page, click this Last Page button.
- : Current page number / Total page number
-  : To zoom in, click this button.
-  : To zoom out, click this button.

Drag the vertical scroll bar or use mouse actions to move around the page so that you can view all the areas of it when the image is enlarged.

Specify file name

The name of a selected file and the number and combined size of files are displayed under "Specify file name."

You can change file names and select a file to display.

File name

The currently selected file name is displayed.



You can type a file name in this combo box to change the file name.

Up to 100 characters can be used for a file name.

When there is more than one file to display, click the down-arrow button

() to select another file from the drop-down list.

Numbers (X / Y) to the right of "File name" are the currently displayed file's position in the list (X) and the total number of files (Y).

[History] button

File names you have specified before are displayed in the "History" list (up to 10 file names.) When the 11th or later file name is specified, a file name is deleted in chronological order.

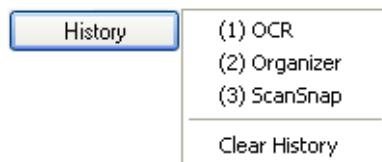

Select a file name, and all file names listed in the "File name" drop-down list are changed to the selected file name.

Selecting [Clear History] deletes all file names in the list.

[Serialize] button

When there are multiple files, a serial number is appended to the file name; a file name and serial number is combined using "_" (underscore). The maximum number of digits you can specify for a serial number is 6.

When you use this button, a currently selected file name is used in common.

Example: When there are three files in Scan.pdf, Snap.pdf, and S510.pdf, if you select "Snap.pdf" in the drop-down list and specify "3" as the number of digits, names of these three files are changed to Snap_001.pdf, Snap_002.pdf, and Snap_003.pdf.

Combined file

The file size is displayed in megabytes. When there are multiple files, the combined size files is displayed.

Specify destination folder

A path to a destination folder is displayed. You can change a destination folder in this dialog box.

Save in

The path name to the currently selected folder is displayed.

E:\Documents and Settings\Owner\My Documents\My Pictures

You can also type a path in this field to change destination folders. Use up to 220 characters for a path name.

[History] button

Folder names you have specified before are displayed in the "History" list. (Up to 10 folder names can be added to the list. When the 11th or later path name is specified, a path name is deleted in chronological order.)

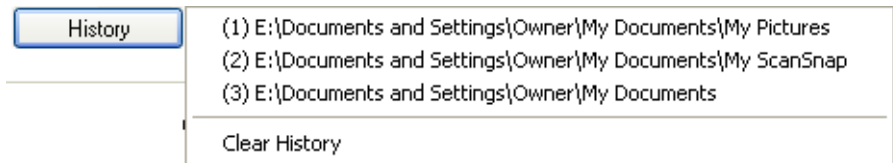

Select a folder name, and the selected folder name is displayed in the "Save in" field.

Selecting [Clear History] deletes all path names in the list.

[Browse] button

Click this button when selecting a destination folder.

"State a path to a destination folder in an e-mail message" checkbox

After files are saved in a specified folder, an e-mail program is started with the path to the specified folder being stated in an e-mail message.

[Save] button

Clicking this saves files using settings configured in this dialog box.

[Cancel] button

Clicking this button cancels saving of files.

[Help] button

You can view Help topics related to the preview window.

7. Click the [Save] button.

⇒ Files are saved in the specified folder.

⇒ When you mark the "State a path to a destination folder in an e-mail message" checkbox in this dialog box, an e-mail message is created with the path to the destination folder being stated.

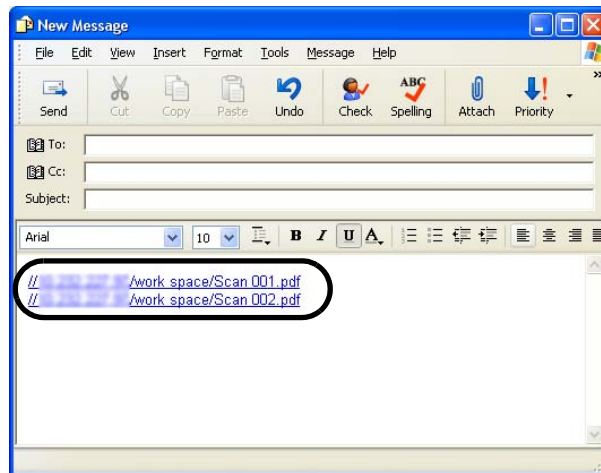

- When the "Preview" window is displayed, the ScanSnap does not work even if you press the [SCAN] button. Close the "Preview" window before scanning another document.
- Do not move, delete, or rename files in other applications when the "Preview" window is displayed.

5.3 Sending Files by E-Mail

This section describes how to send documents scanned with the ScanSnap by e-mail.

After documents are scanned with the ScanSnap, document files are created and an e-mail message appears with the document files attached.

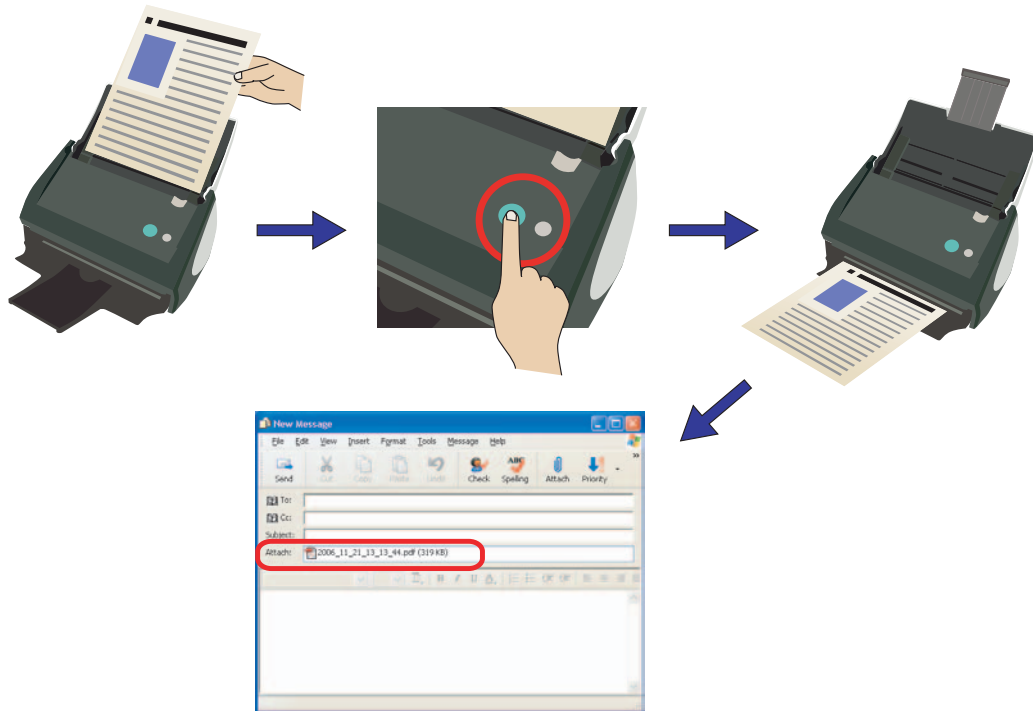



- An e-mail program selected in the "E-mail" drop-down list on the [Programs] tab of the "Internet Options" dialog box will be used; to display the "Internet Options" dialog box, select the [Tools] menu within the Microsoft® Internet Explorer browser, and then select [Internet Options].
If no e-mail program is selected, select an e-mail program you want to use in the "E-mail" drop-down list.

Operations with the following e-mail programs have been verified:

- Microsoft® Windows® Mail (in Windows Vista)
 - Microsoft® Outlook® 2003
 - Microsoft® Outlook Express V6.0
 - Microsoft® Windows Mail
 - Netscape Messenger V4.5
 - Eudora Pro® V4.0.1
 - Thunderbird Version 1.5.0.7
- Even if you use an e-mail program selected in the "E-mail" drop-down list on the [Programs] tab of the "Internet Options" dialog box (in the [Tools] menu in Microsoft® Internet Explorer), the e-mail program may not interact with the ScanSnap properly. In this case, contact the manufacturer of that e-mail program.
 - It has been confirmed that attached file extensions are changed if sending attached files by e-mail failed when the following conditions are met:
 - The operating system you are using is Windows XP (Professional, Home Edition).
 - You have set Hotmail as a default e-mail program.
(File extensions are changed to those including a character "^".)
This problem occurs when a combination of Window XP and Hotmail is used. When you send attached files by e-mail through Explore, the same problem will occur.
Use other e-mail programs with which correct operations are verified (as of December 2006).

■ Operations in Quick Menu Mode



1. Load the document on the ScanSnap.

For details, refer to section "3.2 Paper Size of Documents to be Scanned" (page 46) and section "3.3 Loading Documents" (page 49).

2. Press the [SCAN] button .

⇒ Scanning is started.

⇒ When scanning is complete, the ScanSnap Quick Menu appears.

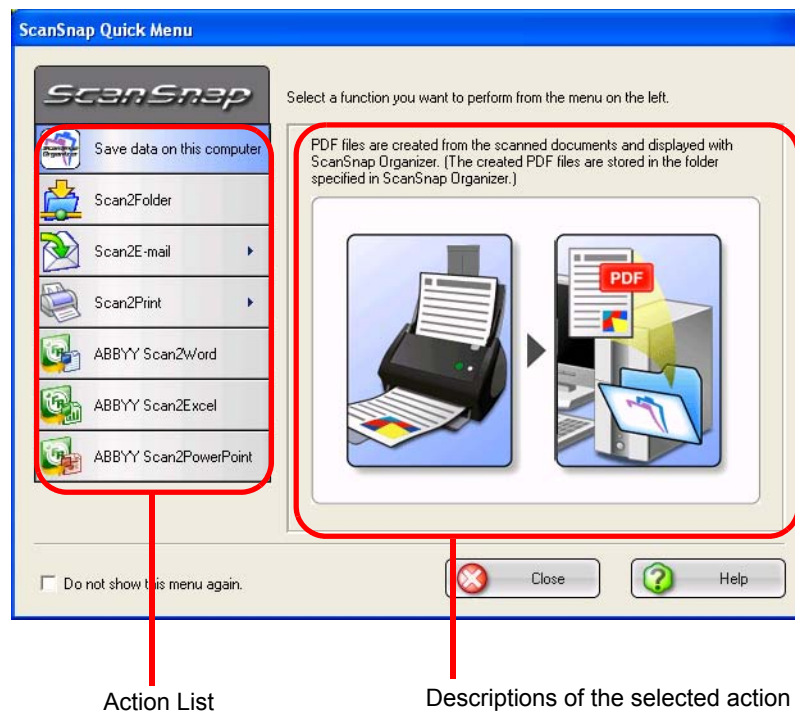

Action List

Descriptions of the selected action



3. Place the mouse cursor on [Scan2E-mail].

⇒ A description of the [Scan2E-mail] action is displayed.

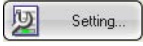
4. When you want to change settings on the [Scan2E-mail] action, place the mouse cursor on the (▶) mark, and then click the [Setting] button  .
(If you want to use default settings, go to step 5.)

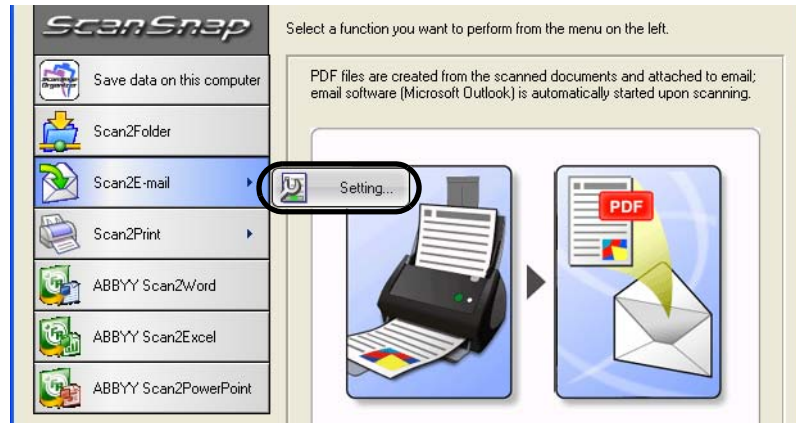

⇒ The following dialog box appears.



In this dialog box, you can change settings on the [Scan2E-mail] action as follows:

"Show preview" checkbox

A preview window appears when scanning is complete.

You can visually check a scanned image before attaching it to an e-mail message.

"Set a 'Document Open' password for PDF files" checkbox

You can set a "Document Open" password for attached PDF files.

The attached PDF files cannot be opened unless the password is entered.

Therefore, mark this checkbox when you send confidential files by e-mail.

To use this function in Windows Vista, Adobe Acrobat must be installed.

"Save scanned images to file" checkbox

You can save PDF files attached to e-mail messages in a specified folder.

The attached PDF files are saved in a folder specified on the [Save] tab of the "ScanSnap Manager - Scan and Save Settings" dialog box (page 74).

Attached file size

When attached file size exceeds a set parameter, a Warning message appears. You can specify a parameter between 1MB and 10MB.

* Even if you see a Warning message, you can send attached files by e-mail.

However, it is recommended that the attached file size be 2MB at the maximum (it depends on your system environment).

- Click the [OK] button to close the "Scan2E-mail -Options" dialog box.



When the [Settings] button of a selected action is clicked, the selected action background color changes to yellow, and other actions become unselectable. To select another action, first close the "Scan2E-mail - Options" dialog box, and then click on any point in areas other than actions, or place the mouse cursor on the selected action.

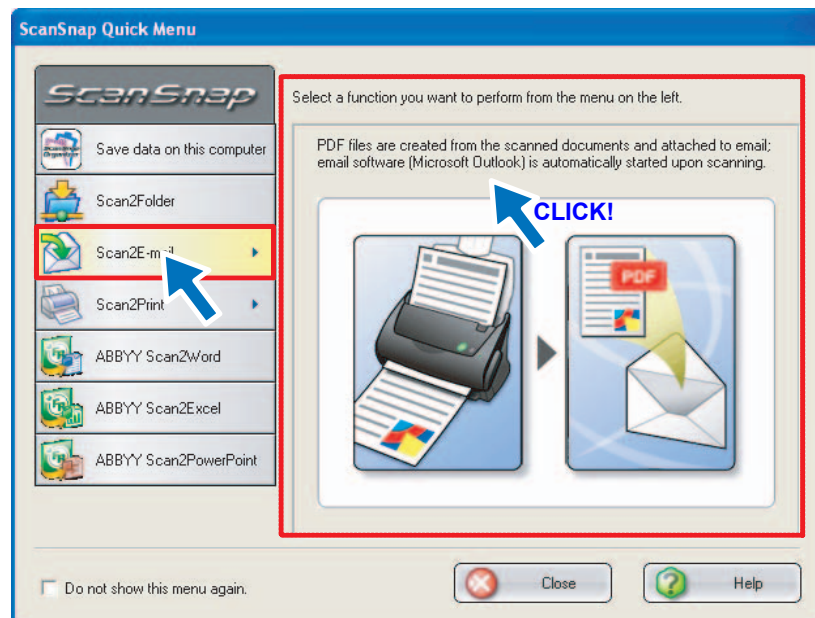

⇒ The selected action background color is changed to the original color (blue) and other actions become selectable.

6. Click [Scan2E-mail] in the Action List.

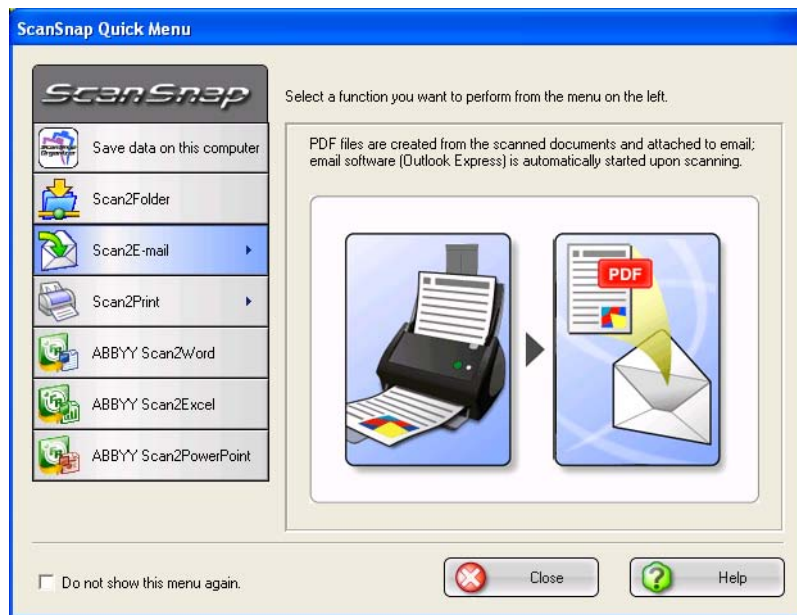

⇒ A preview window appears.
(You can change settings not to display a preview window.)

7. Verify a scanned image in the preview window.

You can also change file names and specify whether to set a "Document Open" password and whether to save files sent by e-mail.

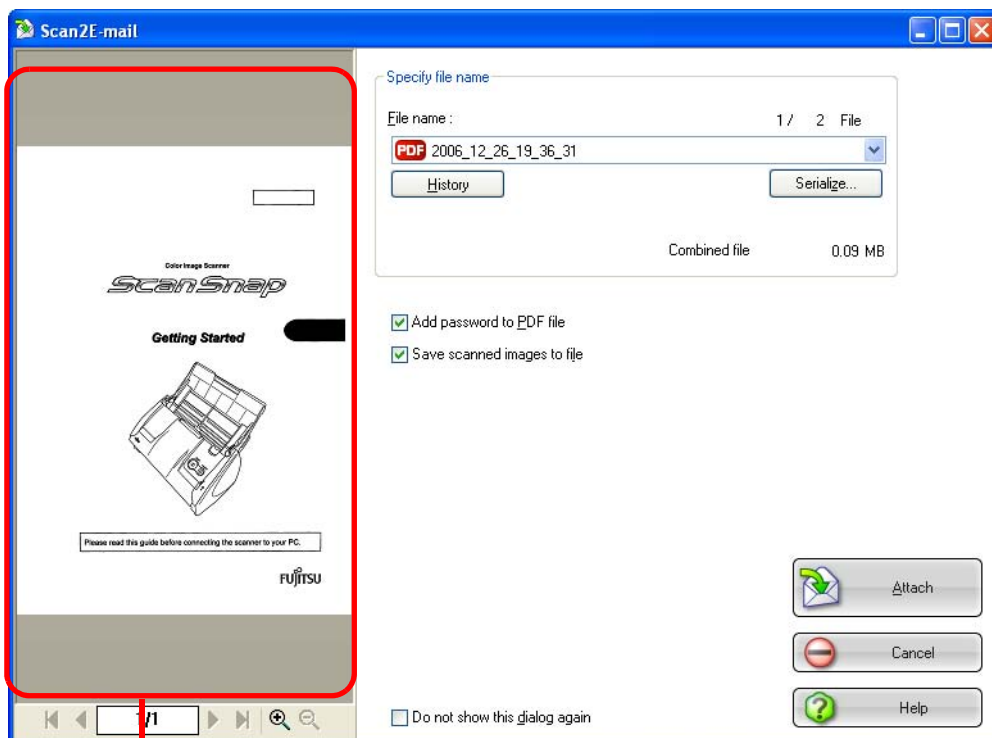







Preview Window

Preview Window

The image of the selected file is displayed.

You can use the following navigation controls for paging through documents:

-  : To go to the first page, click this First Page button.
-  : To go to the previous page, click this Previous Page button.
-  : To go to the next page, click this Next Page button.
-  : To go to the last page, click this Last Page button.
- : Current page number / Total page number
-  : To zoom in, click this button.
-  : To zoom out, click this button.

Drag the vertical scroll bar or use mouse actions to move around the page so that you can view all the areas of it when the image is enlarged.

Specify file name

The name of a selected file and the number and combined size of files are displayed under "Specify file name."

You can change file names and select a file to display.

File name

The currently selected file name is displayed.



You can type a file name in this combo box to change the file name.

Up to 100 characters can be used for a file name.

When there is more than one file to display, click the down-arrow button

() to select another file from the drop-down list.

Numbers (X / Y) to the right of "File name" are the currently displayed file's position in the list (X) and the total number of files (Y).

[History] button

File names you have specified before are displayed in the "History" list; only file names you changed in the "File name" field are added to the list. (Up to 10 file names can be added to the list. When the 11th or later file name is specified, a file name is deleted in chronological order.)

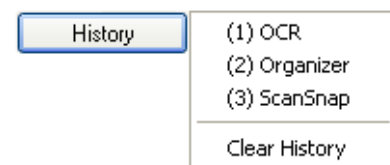

Select a file name, and all file names listed in the "File name" drop-down list are changed to the selected file name.

Selecting [Clear History] deletes all file names in the list.

[Serialize] button

When there are multiple files, a serial number is appended to the file name; a file name and serial number is combined using "_" (underscore). The maximum number of digits you can specify for a serial number is 6. When you use this button, a currently selected file name is used in common.

Example: When there are three files in the drop-down list, Scan.pdf, Snap.pdf, and S510.pdf, if you select "Snap.pdf" in the drop-down list and specify "3" as the number of digits, names of these three files are changed to Snap_001.pdf, Snap_002.pdf, and Snap_003.pdf.

Combined file

The file size is displayed in megabytes. When there are multiple files, a combined file size is displayed.

(Depending on the e-mail program you are using, the size of the attached files in the e-mail program may differ from the file size displayed here. This is because each e-mail program uses a different computation method; the actual size is the same.)

"Add a password to PDF file" checkbox

You can set a "Document Open" password for attached PDF files.

The attached PDF files cannot be opened unless a correct password is entered.

Therefore, mark this checkbox when you send confidential files by e-mail.

To use this function in Windows Vista, Adobe Acrobat must be installed.

"Save scanned images to file" checkbox

You can save PDF files attached to e-mail messages in a specified folder.

The attached PDF files are saved in a folder specified on the [Save] tab of the "ScanSnap Manager - Scan and Save Settings" dialog box (page 74).

"Do not show this dialog again" checkbox

You will not see the preview window from the next time.

You can skip step 7.

[Attach] button

Clicking this button attaches files to an e-mail message using settings configured in this dialog box.

[Cancel] button

Clicking this button cancels all changes made in this dialog box and returns you to the previous window (the ScanSnap Quick Menu).

[Help] button

You can view Help topics related to the preview window.

8. Click the [Attach] button.

⇒ If you marked the "Add a password to PDF file" checkbox in the preview window, the "Scan2E-mail - Set a password" window will appear.



Enter a password, and then click the [OK] button.

⇒ An e-mail program is started with the selected files being attached to an e-mail message.

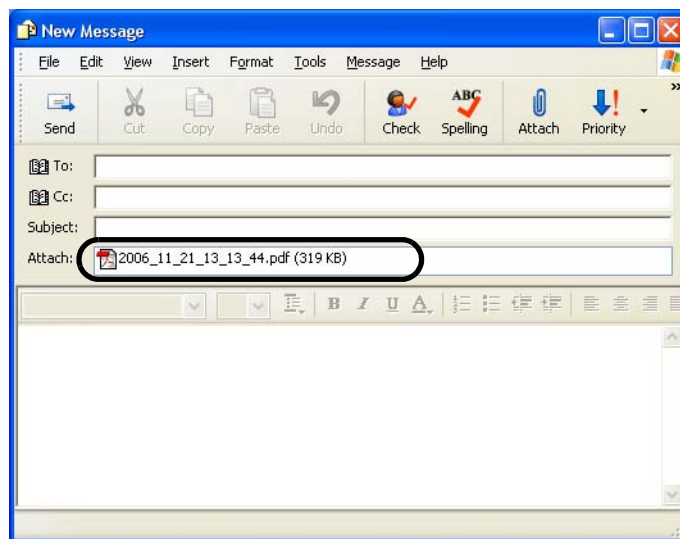

- When the ScanSnap Quick Menu is displayed, the ScanSnap does not work even if you press the [SCAN] button. Select one of actions in the menu and complete the action before scanning another document.
- Do not move, delete, or rename files in other applications after the ScanSnap Quick Menu is displayed and before the "Preview" window is closed.

■ Operations in Left-Click Menu Mode



1. Select [SCAN Button Settings] in the Right-Click Menu, which pops up when the ScanSnap Manager icon  is right-clicked.

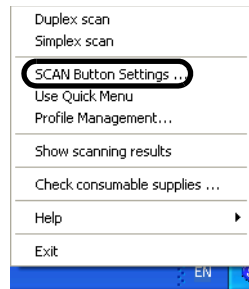

⇒ The "ScanSnap Manager - Scan and Save Settings" dialog box appears.

2. In the "Application" drop-down list on the [Application] tab, select "Scan2E-mail."

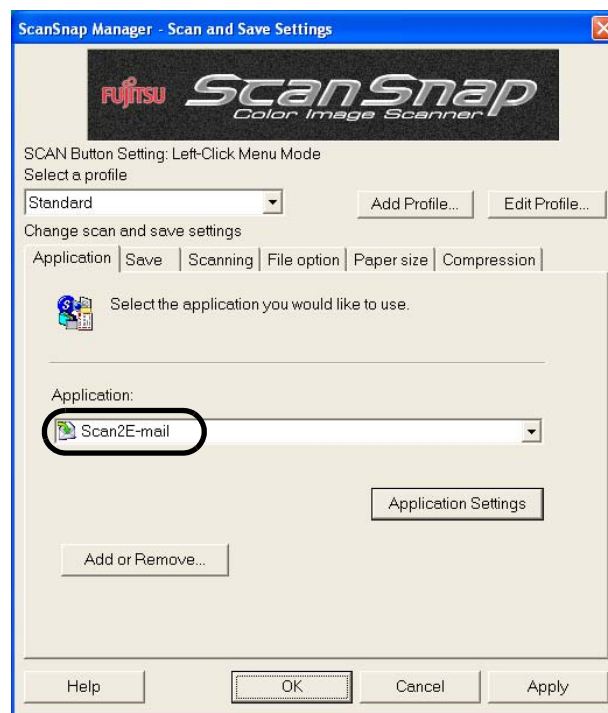

3. When you want to change settings on the [Scan2E-mail] action, click the [Application Settings] button, and then change settings.

(When you do not want to change settings, go to step 5.)

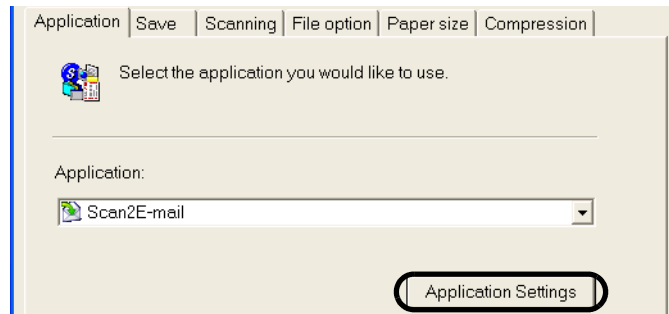

⇒ The following dialog box appears.



In this dialog box, you can change settings on the [Send by e-mail] action as follows:

"Show preview" checkbox

A preview window appears when scanning is complete.

You can visually check a scanned image before attaching it to an e-mail message.

"Set a 'Document Open' password for PDF files" checkbox

You can set a "Document Open" password for attached PDF files.

The attached PDF files cannot be opened unless the password is entered.

Therefore, mark this checkbox when you send confidential files by e-mail.

To use this function in Windows Vista, Adobe Acrobat must be installed.

"Save scanned images to file" checkbox

You can save PDF files attached to e-mail messages in a specified folder.

The attached PDF files are saved in a folder specified on the [Save] tab of the "ScanSnap Manager - Scan and Save Settings" dialog box (page 74).

Attached file size

When attached file size exceeds the set parameter, a Warning message appears.

You can specify a parameter from 1MB to 10MB.

* Even if you see a Warning message, you can send attached files by e-mail.

However, it is recommended that the attached file size be 2MB at the maximum (it depends on your system environment).

-
- Click the [OK] button.
⇒ The "Scan2E-mail - Options" dialog box is closed.

- Click the [OK] button.
⇒ The "ScanSnap Manager - Scan and Save Settings" dialog box closes.



Changes you have made in the above procedure take effect from the next time you scan documents using the Left-Click Menu.
For details on how to change settings, refer to section "4.3 Saving Scanning Settings" (page 92).



- Load the document on the ScanSnap.
For details, refer to sections "3.2 Paper Size of Documents to be Scanned" (page 46) and "3.3 Loading Documents" (page 49).

- Press the [SCAN] button .
⇒ Scanning is started.
⇒ When scanning is complete, a preview window appears.
(You can change settings not to display a preview window.)



8. Verify a scanned image in the preview window.

You can also change file names and specify whether to set a "Document Open" password.

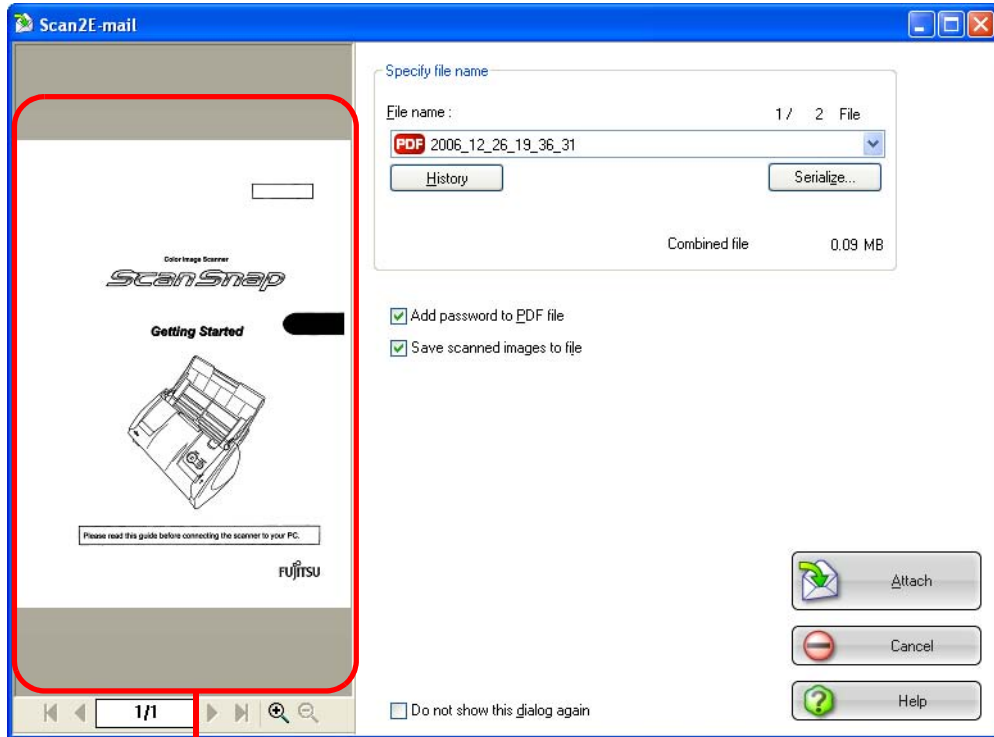







Preview Window

Preview Window

The image of the selected file is displayed.

You can use the following navigation controls for paging through documents.

-  : To go to the first page, click this First Page button.
-  : To go to the previous page, click this Previous Page button.
-  : To go to the next page, click this Next Page button.
-  : To go to the last page, click this Last Page button.
- : Current page number / Total page number
-  : To zoom in, click this button
-  : To zoom out, click this button

Drag the vertical scroll bar or use mouse actions to move around the page so that you can view all the areas of it when the image is enlarged.

Specify file name

The name of a selected file and the number and combined size of files are displayed under "Specify file name."

You can change file names and select a file to display.

File name

The currently selected file name is displayed.



You can type a file name in this combo box to change the file name.

Up to 100 characters can be used for a file name.

When there is more than one file to display, click the down-arrow button

() to select another file from the drop-down list.

Numbers (X / Y) to the right of "File name" are the currently displayed file's position in the list (X) and the total number of files (Y).

[History] button

File names you have specified before are displayed in the "History" list (up to 10 file names). When the 11th or later file name is specified, a file name is deleted in chronological order.

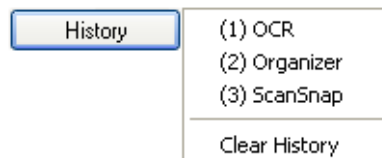

Select a file name, and all file names listed in the "File name" drop-down list are changed to the selected file name.

Selecting [Clear History] deletes all file names in the "History" list.

[Serialize] button

When there are multiple files, a serial number is appended to the file name; a file name and serial number is combined using "_" (underscore). The maximum number of digits you can specify for a serial number is 6. When you use this button, a currently selected file name is used in common.

Example: When there are three files in the drop-down list, Scan.pdf, Snap.pdf, and S510.pdf, if you select "Snap.pdf" in the drop-down list and specify "3" as the number of digits, names of these three files are changed to Snap_001.pdf, Snap_002.pdf, and Snap_003.pdf.

Combined file

The file size is displayed in megabytes. When there are multiple files, a combined file size is displayed.

(Depending on the e-mail program you are using, the size of the attached files in the e-mail program may differ from the file size displayed here. This is because each e-mail program uses a different computation method; the actual size is the same.)

"Add a password to PDF file" checkbox

You can set a "Document Open" password for attached PDF files.

The attached PDF files cannot be opened unless a correct password is entered.

Therefore, mark this checkbox when you send confidential files by e-mail.

To use this function in Windows Vista, Adobe Acrobat must be installed.

"Save scanned images to file" checkbox

You can save PDF files attached to e-mail messages in a specified folder.

The attached PDF files are saved in a folder specified on the [Save] tab of the "ScanSnap Manager - Scan and Save Settings" dialog box (page 74).

"Do not show this dialog again" checkbox

You will not see the preview window from the next time.

You can skip step 7.

[Attach] button

Clicking this button attaches files using settings configured in this dialog box.

[Cancel] button

Clicking this button cancels all changes made in this dialog box.

[Help] button

You can view Help topics related to the preview window.

9. Click the [Attach] button

⇒ If you marked the "Add a password to PDF file" checkbox in the preview window, an "Enter password" window will appear.



Enter a password, and then click the [OK] button.

⇒ An e-mail program is started and selected files are attached to an e-mail message.

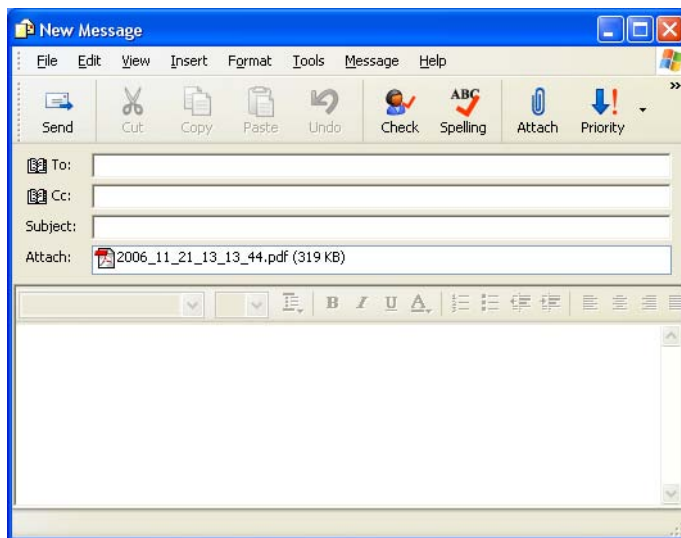

- ATTENTION 
- When the "Preview" window is displayed, the ScanSnap does not work even if you press the [SCAN] button. Close the "Preview" window before scanning another document.
 - Do not move, delete, or rename files in other applications when the "Preview" window is displayed.

5.4 Using the ScanSnap as a Copy Machine

This section describes how to print scanned image files with a printer. By printing scanned images directly from the ScanSnap, you can use the ScanSnap as a copy machine.

When you scan documents with the ScanSnap, scanned images are printed with a printer.

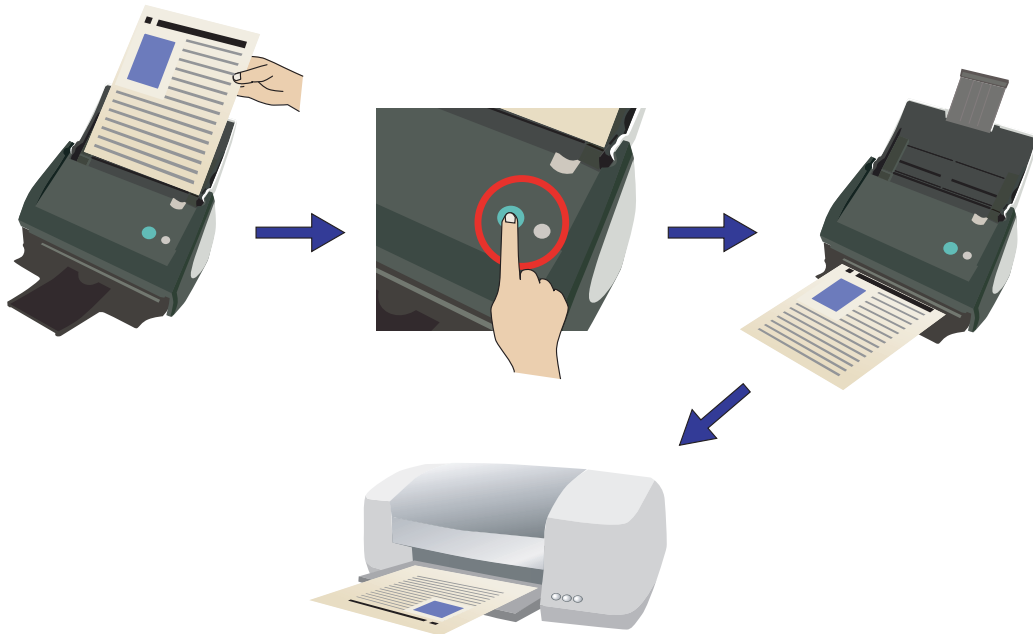

By default, a printer that is "Set as Default Printer" in Windows Control Panel is used. You might also change settings so that a printer can be selected after scanning.

■ Operations in Quick Menu Mode



1. Load the document on the ScanSnap.

For details, refer to sections "3.2 Paper Size of Documents to be Scanned" (page 46) and "3.3 Loading Documents" (page 49).

2. Press the [SCAN] button .

⇒ Scanning is started.

⇒ When scanning is complete, the ScanSnap Quick Menu is displayed.

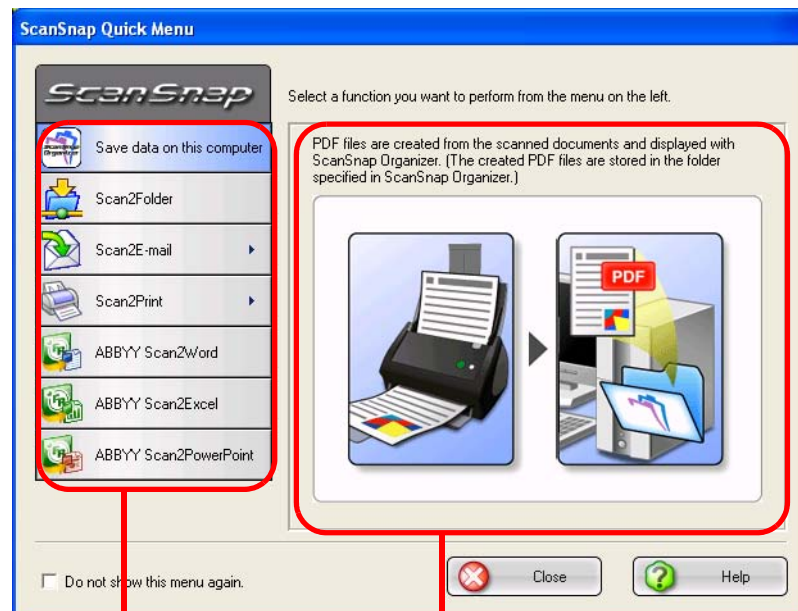

Action List

Descriptions of the selected action

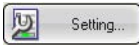

3. Place the mouse cursor on [Scan2Print].
⇒ A description of the [Scan2Print] action is displayed.
4. When you want to change settings on the [Scan2Print] action, place the mouse cursor on the (▶) mark, and then click the [Setting] button  .
(If you want to use default settings, go to step 5.)

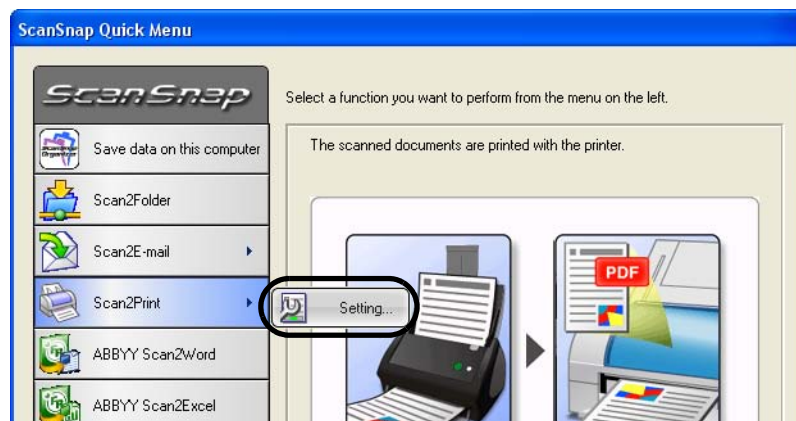

⇒ The following dialog box appears.

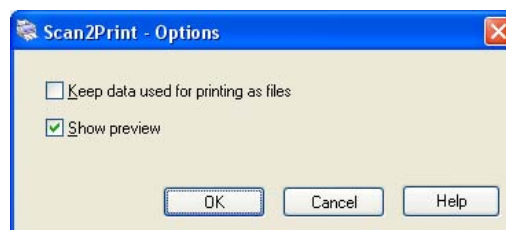

In this dialog box, you can change settings on the [Scan2Print] action as follows:

"Keep data used for printing as files" checkbox

Printed document images are saved in PDF format.

PDF files are saved in a folder specified in the "Image saving folder" drop-down list on the [Save] tab of the "ScanSnap Manager - Scan and Save Settings" dialog box (page 74).

(By default, this checkbox is not marked.)

"Show preview" checkbox

Before documents are printed, the print setup dialog box is displayed.

5. Click the [OK] button to close the "Scan2Print - Options" dialog box.



When the [Settings] buttons of a selected action is clicked, the selected action background color changes to yellow, and other actions become unselectable. To select another action, first close the "Scan2Print - Options" dialog box, and then click on any point in areas other than actions, or place the mouse cursor on the selected action.

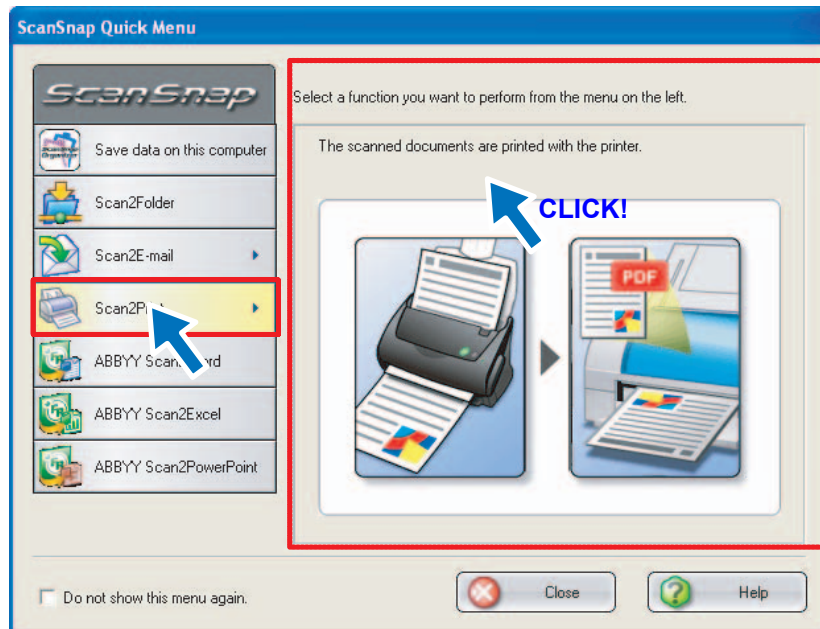

⇒ The selected action background color is changed to the original color (blue) and other actions become selectable.

6. Click [Scan2Print] in the Action List.

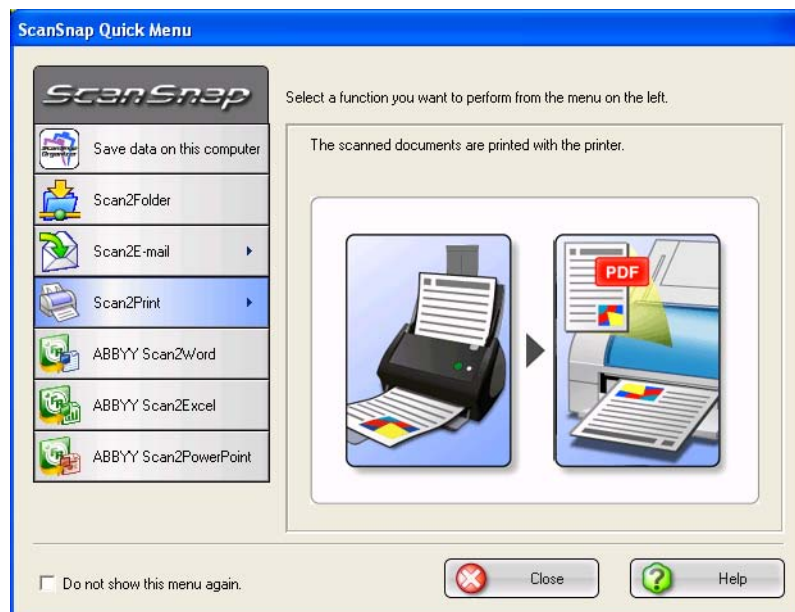

⇒ The "Scan2Print -Print" dialog box appears.
 (This dialog box will not appear unless the "Show preview" checkbox is marked in step 4, and printing is performed immediately after clicking this action.)

7. Change settings for printing, and then click the [OK] button.

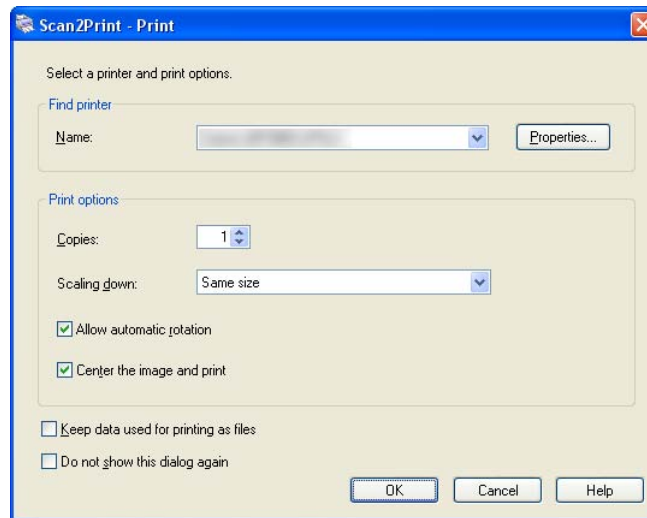

Find printer

Select a printer to use.

Name

The currently selected printer is displayed.

To change printers, click the down-arrow button , and then select a printer you want to use in the printer list.

[Properties] button

The print setup dialog box is displayed and you can change settings for the currently selected printer.

Print options

You can change settings as follows:

Copies

You can specify the number of copies you want to print.
 Select a number between 1 and 99.

Scaling down

You can select an output size of images; you can fit output images to paper size or print them in original size.

Same size:

Images are printed in their original sizes.

Scale down to paper size:

Images larger than a paper size are scaled down to the paper size so that the whole image can be printed on a sheet of paper.

"Allow automatic rotation" checkbox

Images are rotated according to the length-to-width ratio of images so that they can be printed in either portrait orientation or landscape orientation, whichever best fits.

"Center the image and print" checkbox

Images are centered and printed.

"Keep data used for printing as files" checkbox

PDF files are saved in a folder specified in the "Image saving folder" drop-down list on the [Save] tab of the "ScanSnap Manager - Scan and Save Settings" dialog box (page 74).

"Do not show this dialog again" checkbox

You will not see the preview window from the next time.
You can skip step 7.

[OK] button

Clicking this button prints images using settings configured in this dialog box.

[Cancel] button

Clicking this button cancels all changes made in this dialog box and returns you to the previous window (the ScanSnap Quick Menu Mode).

[Help] button

You can view Help topics related to the preview window.

⇒ Printing is performed.



- Once the ScanSnap Quick Menu is displayed, the ScanSnap does not work until the "Scan2Print - Print" dialog box is closed, even if you press the [SCAN] button. Complete the action before scanning another document.
- Do not move, delete, or rename files in other applications after the ScanSnap Quick Menu is displayed and before the "Scan2Print - Print" dialog box is closed.



■ Operations in Left-Click Menu Mode



1. Select [SCAN Button Settings] in the Right-Click Menu, which pops up when the ScanSnap Manager icon **S** is right-clicked.

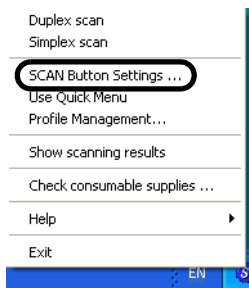

⇒ The "ScanSnap Manager - Scan and Save Settings" dialog box appears.

2. In the "Application" drop-down list on the [Application] tab, select "Scan2Print."

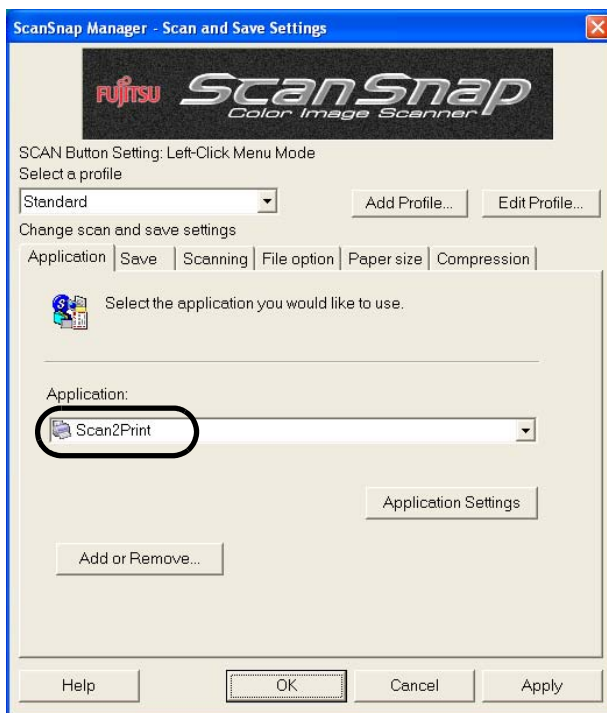

3. When you want to change settings on the [Scan2Print] action, click the [Application Settings] button, and then change settings.

(When you do not want to change settings, go to step 5.)

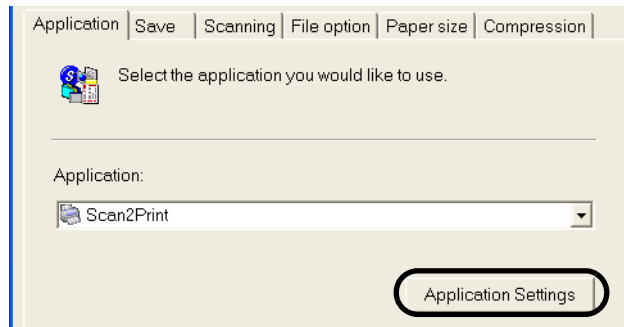

⇒ The following dialog box appears.

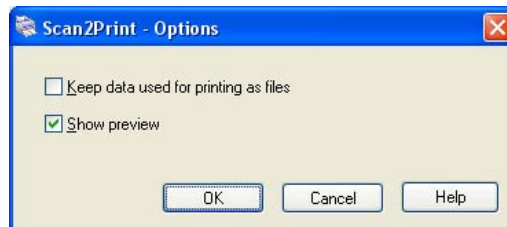

In this dialog box, you can change settings on the [Print with print] action as follows:

"Keep data used for printing as files" checkbox

Printed document images are saved in PDF format.

PDF files are saved in a folder specified in the "Image saving folder" drop-down list on the [Save] tab of the "ScanSnap Manager - Scan and Save Settings" dialog box (page 74).

(By default, this checkbox is not marked.)

"Show preview" checkbox

A preview window appears before printing images.

4. Click the [OK] button.

⇒ The "Scan2Print - Print" dialog box is closed.

5. Click the [OK] button.

⇒ The "ScanSnap Manager -Scan and Save Settings" dialog box is closed.

HINT  Changes you have made in the above procedure take effect from the next time you scan documents using the Left-Click Menu. For details on how to change settings, refer to section "4.3 Saving Scanning Settings" (page 92).



6. Load the document on the ScanSnap.

For details, refer to sections "3.2 Paper Size of Documents to be Scanned" (page 46) and "3.3 Loading Documents" (page 49).

7. Press the [SCAN] button .

⇒ Scanning is started.

⇒ When scanning is complete, the "Scan2Print - Print" dialog box appears.

(You can change settings not to display the "Scan2Print - Print" dialog box.)



8. Configure print setup options, and then click the [OK] button.

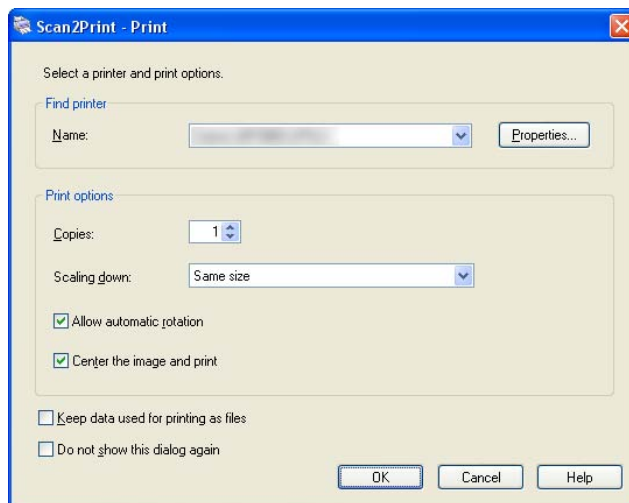

Find printer

Select a printer to use.

Name

The currently selected printer is displayed.

To change printers, click the down-arrow button , and then select a printer you want to use in the printer list.

[Properties] button

The print setup dialog box of the currently selected printer is displayed.

Print options

You can change settings as follows:

Copies

You can specify the number of copies you want to print.
Select a number between 1 and 99.

Scaling down

You can select an output size of images; you can fit output images to paper size or print them in original size.

Same size:

Images are printed in their original sizes.

Scale down to paper size:

Images larger than a paper size are scaled down to the paper size so that the whole image can be printed on a sheet of paper.

"Allow automatic rotation" checkbox

Images are rotated according to the length-to-width ratio of images so that they can be printed in either portrait orientation or landscape orientation, whichever best fits.

"Center the image and print" checkbox

Images are centered and printed.

"Keep data used for printing as files" checkbox

Printed document images are saved in PDF format.

PDF files are saved in a folder specified under the "Image saving folder" field on the [Save] tab of the "ScanSnap Manager - Scan and Save Settings" dialog box (page 74).

"Do not show this dialog again" checkbox

This dialog box does not appear again. Step 7 will be skipped.

[OK] button

Clicking this button prints images using settings configured in this dialog box.

[Cancel] button

Clicking this button cancels printing.

[Help] button

You can view Help topics related to the Print dialog box.

⇒ Printing is performed.

 • While the "Scan2Print - Print" dialog box is open, the ScanSnap does not work even if you press the [SCAN] button. Close the "Scan2Print - Print" dialog box before scanning another document.

• Do not move, delete, or rename files when the "Scan2Print - Print" dialog box is displayed.

5.5 Converting into Word / Excel / PowerPoint Files

This section describes how to convert documents scanned with the ScanSnap into Word/Excel/PowerPoint files through OCR (Optical Character Recognition). OCR refers to the process that involves scanning the text from paper form into images, then translating the information into a format that computers can recognize.

The OCR function of ABBYY FineReader for ScanSnap, which is application software supplied with the ScanSnap, allows you to convert scanned images into Word format, Excel format, or PowerPoint format.

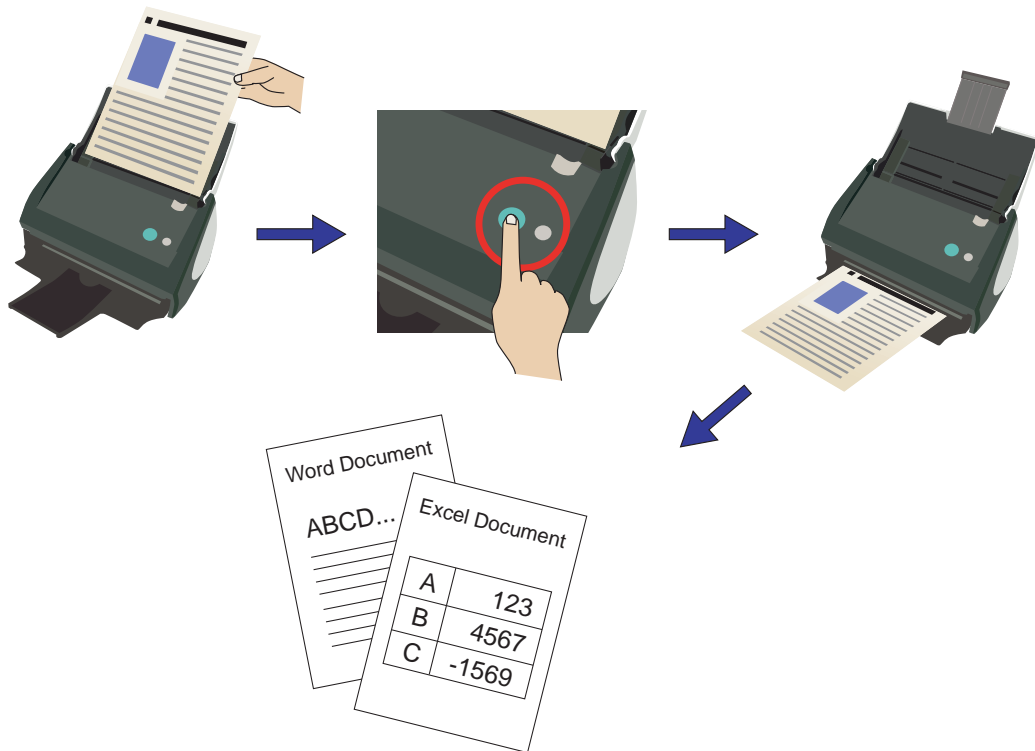



- To use the above OCR function, ABBYY FineReader for ScanSnap 3.0 must be installed on your computer.
- Scanned document images are opened with Microsoft® Word, Microsoft® Excel, or Microsoft® PowerPoint when Microsoft® Word, Microsoft® Excel and/or Microsoft® PowerPoint is installed. When any of them is not installed, scanned document images are simply saved to file.
 - * You cannot view the documents converted into Word/Excel/PowerPoint files unless Microsoft® Word/Microsoft® Excel/Microsoft® PowerPoint is installed or you have completed user registration to use these applications. Install the above applications and complete user registration to view the converted documents on your computer.
- ABBYY FineReader for ScanSnap can be used with the following versions of Microsoft® Word, Microsoft® Excel, and/or Microsoft® PowerPoint.
 - Microsoft® Word: 2000 / 2002 / 2003
 - Microsoft® Excel: 2000 / 2002 / 2003
 - Microsoft® PowerPoint: 2000 / 2002 / 2003
- If this action is executed while the Print or Search function is being performed in Microsoft® Word, Microsoft® Excel, or Microsoft® PowerPoint, an error message, for example, "Call is rejected by callee," is sent. Do not perform this action and the functions of Microsoft® Word, Microsoft® Excel, or Microsoft® PowerPoint at the same time.



For details on ABBYY FineReader for ScanSnap, refer to ABBYY FineReader for ScanSnap User's Guide.



About the OCR function of ABBYY FineReader for ScanSnap

- Some types of documents are occasionally misrecognized. Before recognition, check whether the documents you want to convert are suitable for conversion according to the following guidelines.
 - Suitable for conversion to Word
Documents created by using simple page layout with one or two columns
 - Suitable for conversion to Excel
Simple tables in which every border line connects to the outside borders
 - Not suitable for conversion to Word
Documents created by using complex page layout comprised of diagrams, tables, and letters, such as a brochure, magazine, and newspaper
 - Not suitable for conversion to Excel
Documents containing tables without borders, complex tables with too many borders, convoluted tables containing sub-tables, diagrams, graphs and charts, photographs, and/or characters written in vertical direction (Diagrams, graphs and charts, photographs, and characters written in vertical direction are not converted.)
- The following parameters may not be inherited from the originals during conversion. It is recommended that the converted documents be opened with Microsoft® Word or Microsoft® Excel to correct or edit misrecognized letters.
 - Font and size of characters
 - Character spacing and line spacing
 - Underline, bold, and Italic
 - Superscript and subscript

The following types of documents may be misrecognized. If so, change the "Color mode" to "Color" and/or increase the resolution (Image quality) to improve the results of conversion.

 - Documents containing handwritten characters
 - Text including small characters (smaller than 10 points)
 - Skewed documents
 - Documents in languages other than the specified language
 - Documents containing characters written in an unevenly-colored or patterned background
(Characters to which effects, such as Shadow, Outline, and Shading, are applied.)
 - Documents of complex layout and documents including unreadable characters
(It may take an extended period of time to convert these documents.)
- ABBYY FineReader for ScanSnap can text-recognize only PDF files that are created by using the ScanSnap, but it cannot text-recognize PDF files created by using Adobe Acrobat or other applications.
- A converted Excel worksheet can contain up to 65536 rows.
- If documents are scanned upside down or in landscape orientation, conversion will fail. Mark the "Allow automatic image rotation" checkbox (page 82), or load documents face down in portrait orientation.

- To use this function, more than the recommended memory is required. If a large number of pages are converted at one time, memory may become insufficient during conversion.

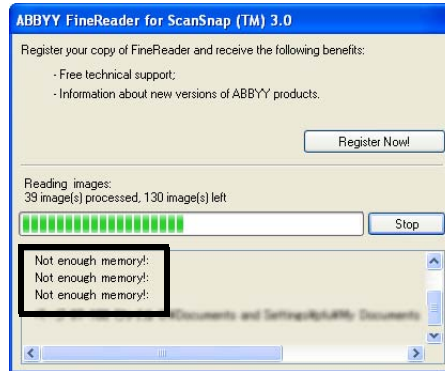

In this case, change settings for virtual memory configuration, following the procedure below.

Windows XP

1. Select [Start], right-click [My Computer], and then select [Properties] in the pop-up menu.
2. In the "System Properties" dialog box, select the [Advanced] tab, and then click the [Settings] button under "Performance."
3. In the "Performance Options" dialog box, select the [Advanced] tab, and then click the [Change] button under "Virtual memory."
4. In the "Virtual Memory" dialog box, select "Custom size," and then type in a rather large number in the "Maximum size (MB)" field.
5. Click the [Set] button.
6. Click the [OK] button to close all dialog boxes.

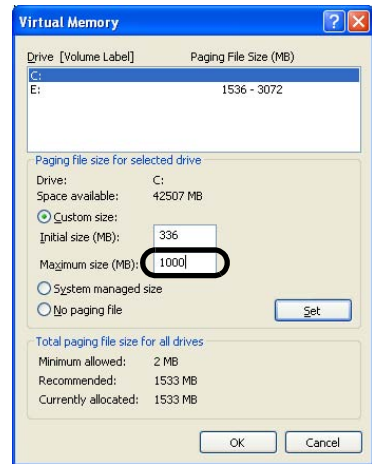

Windows 2000

1. Right-click the [My Computer] icon on the Desktop, and then select [Properties] in the pop-up menu.
2. In the "System Properties" dialog box, select the [Advanced] tab, and then click the [Performance Options] button under "Performance."
3. In the "Performance Options" dialog box, click the [Change] button under "Virtual memory."
4. In the "Virtual Memory" dialog box, type in a rather large number in the "Maximum size (MB)" field under "Paging file size for selected drive."
5. Click the [Set] button.
6. Click the [OK] button to close all dialog boxes.

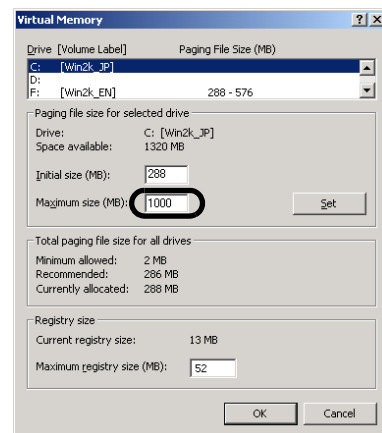

■ Operations in Quick Menu Mode



1. Load the document on the ScanSnap.

For details, refer to sections "3.2 Paper Size of Documents to be Scanned" (page 46) and "3.3 Loading Documents" (page 49).

2. Press the [SCAN] button .

⇒ Scanning is started.

⇒ When scanning is complete, the ScanSnap Quick Menu appears.

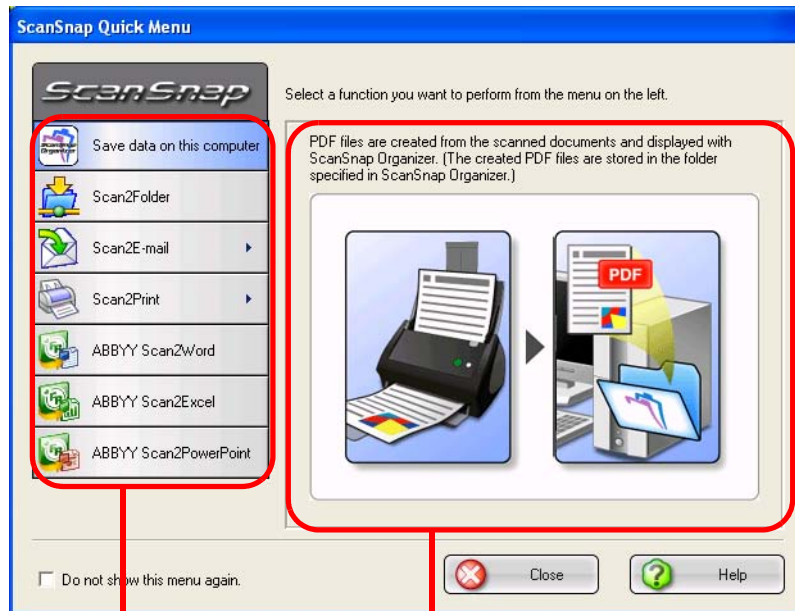

Action List

Descriptions of the selected action



3. Click [ABBYY Scan2Word], [ABBYY Scan2Excel], or [ABBYY Scan2PowerPoint].

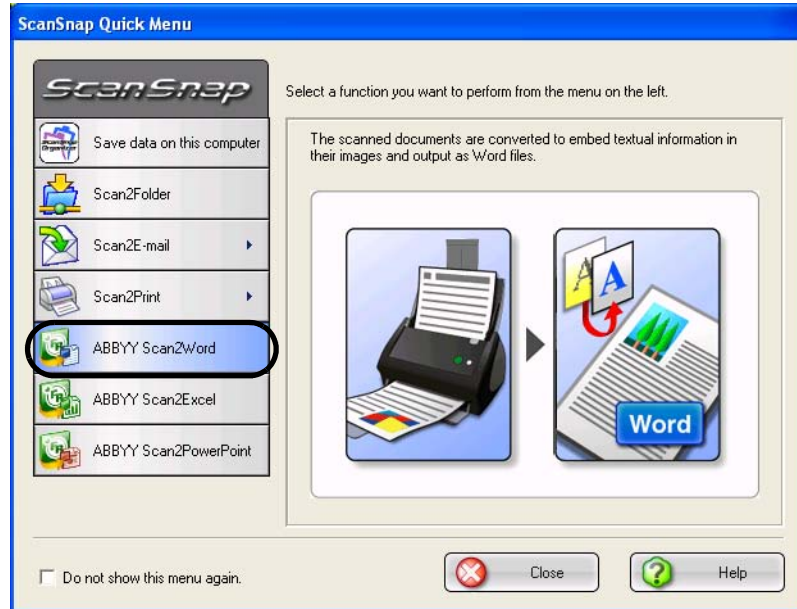

⇒ The following window appears and conversion is started.

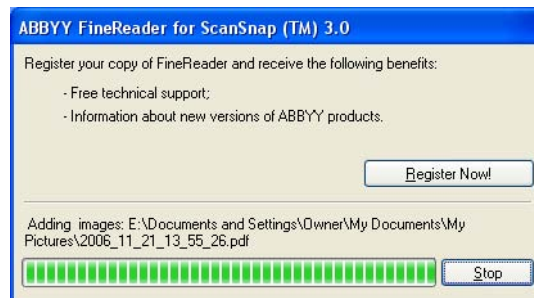

⇒ When the conversion is complete, Microsoft® Word, Microsoft® Excel, or Microsoft® PowerPoint starts running, and converted images are displayed in Word format, Excel format, or PowerPoint format.



When Microsoft® Word, Microsoft® Excel, and/or Microsoft® PowerPoint is not installed on your computer, scanned document images are simply saved to file. If you try to convert to Word documents, files are saved in RTF format (.rtf), and if you try to convert to Excel documents, they are saved in XLS format (.xls). A confirmation message will appear before the files are saved; specify a folder in which you want to save images.



- When the ScanSnap Quick Menu is displayed, the ScanSnap does not work even if you press the [SCAN] button. Close the ScanSnap Quick Menu before scanning another document.
- Do not move, delete, or rename files in other applications when the Scansnap Quick Menu is displayed.

■ Operations in Left-Click Menu Mode



1. Select [SCAN Button Settings] in the Right-Click Menu, which pops up when the ScanSnap Manager icon  is right-clicked.

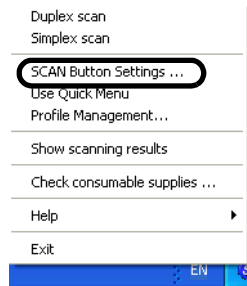

⇒ The "ScanSnap Manager -Scan and Save Settings" dialog box appear.

2. In the "Application" drop-down list on the [Application] tab, select "ABBYY Scan2Word" to convert documents into Word files.
"ABBYY Scan2Excel" to convert documents into Excel files.
"ABBYY Scan2PowerPoint" to convert documents into PowerPoint files.



3. Click the [OK] button.

⇒ The "ScanSnap Manager - Scan and Save Settings" dialog box closes.

 Changes you have made in the above procedure take effect from the next time you scan documents using the Left-Click Menu. For details on how to change settings, refer to section "4.3 Saving Scanning Settings" (page 92).



4. Load the document on the ScanSnap.

For details, refer to sections "3.2 Paper Size of Documents to be Scanned" (page 46) and "3.3 Loading Documents" (page 49).

5. Press the [SCAN] button .

⇒ Scanning is started.

⇒ When the scanning is complete, the window below appears and a conversion is started.

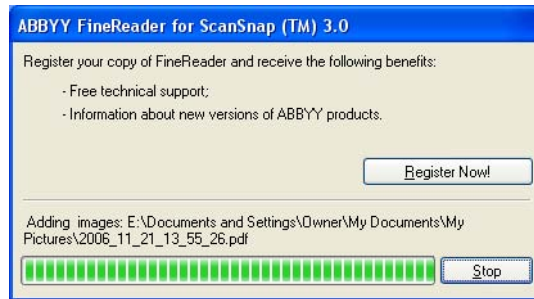

⇒ When the conversion is complete, Microsoft® Word, Microsoft® Excel, or Microsoft® PowerPoint starts running, and converted images are displayed in Word format, Excel format, or PowerPoint format.

 When Microsoft® Word, Microsoft® Excel, or Microsoft® PowerPoint is not installed on your computer, scanned document images are simply saved to file. Word documents are saved in RTF format (.rtf), Excel documents, in XLS format (.xls), and PowerPoint documents, in format PPT (.ppt). A confirmation message will appear before the files are saved; specify a folder in which you want to save images.

■ About Settings on ABBYY FineReader for ScanSnap

When you want to change settings on conversion to Word/Excel/PowerPoint file format, use the "ABBYY FineReader for ScanSnap" dialog box.

From the [Start] menu, select [All Programs] ⇒ [ABBYY FineReader for ScanSnap(TM) 3.0] and [ABBYY FineReader for ScanSnap(TM) 3.0]; the following dialog box appears.

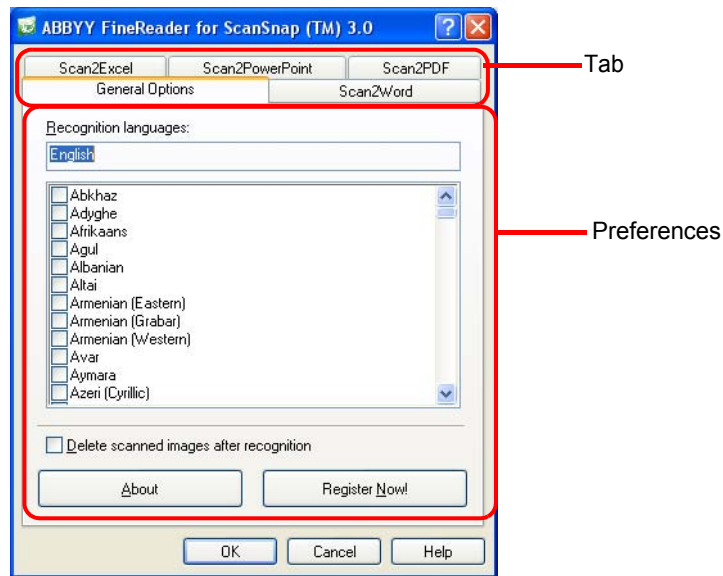

This dialog box contains the four tabs:

- [General Options] tab ⇒ page 165
- [Scan2Word] tab ⇒ page 166
- [Scan2Excel] tab ⇒ page 167
- [Scan2PowerPoint] tab ⇒ page 167

[About] button

Clicking this button displays the information about ABBYY FineReader for ScanSnap including the version number.

[Register Now!] button

A dialog box appears for you to fill out the registration form.

■ [Scan2Word] tab

You can configure advanced settings for converting to Word file format.

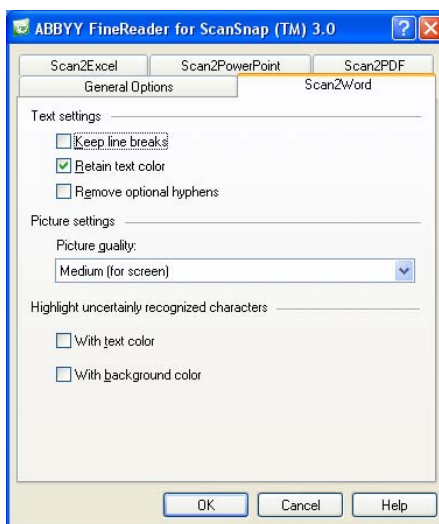

"Keep line breaks" checkbox

The text is converted to Word file format, keeping line brakes.

"Retain text color" checkbox

The text is output in original colors.

"Remove optional hyphens" checkbox

Optional hyphens used in the original text are replaced with ordinary hyphens (-). When Japanese is selected as the recognition language, this checkbox is not available.

Picture quality

Set the quality for saving pictures. Select one of the following values:

High (for printing): If you are planning to print the recognition results.

Medium (for screen): If the recognition results are intended for viewing on the screen.

Low (web): If you are planning to place the recognition results on the Web.

"With text color" checkbox

If marked, improperly-recognized characters are colored.

"With background color" checkbox

If marked, the background of improperly-recognized characters are colored.

■ [Scan2Excel] tab

You can configure advanced settings for converting to Excel file format.

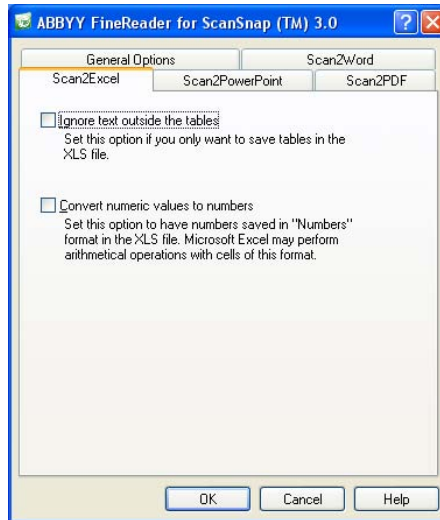

"Ignore text outside the tables" checkbox

The text outside the tables is removed and only tables are converted to Excel file format.

"Convert numeric values to numbers" checkbox

Numeric values in the text are converted to numbers in Excel sheets.

■ [Scan2PowerPoint] tab

You can configure advanced settings for converting to PowerPoint file format.

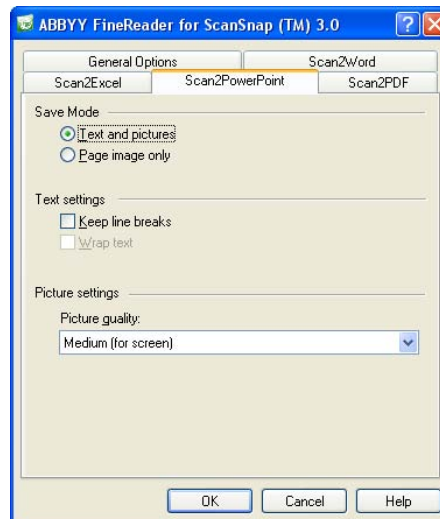

"Save Mode"

You can specify how scanned document files are converted into PowerPoint files.

Text and pictures only: The recognized text is saved as text, and the pictures, as pictures.

Page image only: Only the image is saved.

"Keep line breaks" checkbox

Set this option if you want the original arrangement into lines to be retained in the PowerPoint format, otherwise the text will be formatted in a single line in the PowerPoint file.

"Wrap text" checkbox

If line formatting is preserved (if the "Keep line breaks" checkbox is marked), the recognized text will fit the width of the text block of the slide.

"Picture quality"

Set the quality for saving pictures. Select one of the following values:

High (for printing): If you are planning to print the recognition results.

Medium (for screen): If the recognition results are intended for viewing on the screen (default).

Low (for web): If you are planning to place the recognition results on the Web.

Chapter 6



Using the ScanSnap in Various Ways

This chapter describes a variety of ways you can use the ScanSnap.

6.1 Using ScanSnap Manager	170
6.2 Using Adobe Acrobat	197
6.3 Scanning Business Cards	202
6.4 Using ScanSnap Organizer	208

6.1 Using ScanSnap Manager

In order for you to use the ScanSnap immediately after opening the package, factory default settings are optimized.

All you need to do is press the [SCAN] button  to scan documents.

You can also configure the settings as necessary.

This section describes how to scan documents using various settings and how to process scanned images.



<Quick Menu Mode>

The default settings of ScanSnap Manager are as follows:

- Application: To be specified after scanning
- Image saving folder: [My ScanSnap] folder under [My Documents]
- File name format: Date and time (Use operating system setting: yyyyMMddHHmmss (Year, Month, Day, hour, minute, second))
- Rename file after scanning: Disabled
- Image quality: Normal (Fastest)
- Color mode: Auto Color Detection (automatically determines whether the document is "color" or "black and white")
- Scanning side: Duplex Scan
- Continue scanning after current scan is finished: Disabled
- Scanning Option:
 - Brightness: Normal
 - Setting for text only document (in Color mode only): Disabled
 - Allow automatic blank page removal: Enabled
 - Correct skewed character strings automatically: Disabled
 - Allow automatic image rotation: Enabled
 - Set the documents with its face up: Disabled
- File format: PDF (*.pdf) only
- Searchable PDF (via OCRs): Disabled
- File format Option
 - PDF File Option: Multipage PDF (whole batch in one PDF)
 - Set a password for PDF file: Disabled
 - Use a fixed password: Disabled
- Paper size: Automatic detection
- Scan mixed paper size: Disabled
- Carrier Sheet settings:
 - Mode: Create facing pages in one image
 - Output image size: Automatic detection
- Compression
 - Compression rate: 3

The settings above can be changed in the "ScanSnap Manager Scan and Save Settings" dialog box.

For details, refer to the "4.2 Changing Scanning Settings" (page 67).





<Left-Click Menu>

The default settings of ScanSnap Manager are as follows:

- Application: ScanSnap Organizer
- Image saving folder: [My ScanSnap] folder under [My Documents]
- Filename format: Date and time (Use operating system setting: yyyyMMddHHmmss (Year, Month, Day, hour, minute, second))
- Rename file after scanning: Disabled
- Image quality: Normal (Fastest)
- Color mode: Auto Color Detection (automatically determines whether the document is "color" or "black and white")
- Scanning side: Duplex Scan
- Continue scanning after current scan is finished: Disabled
- Scanning Option:
 - Brightness: Normal
 - Setting for text only document (in Color mode only): Disabled
 - Allow automatic blank page removal: Enabled
 - Correct skewed character strings automatically: disabled
 - Allow automatic image rotation: Enabled
 - Set the documents with its face up: Disabled
- File format: PDF (*.pdf)
- Searchable PDF (via OCRs): Disabled
- File format Option
 - PDF File Option: Multipage PDF (whole batch in one PDF)
 - Set a password for PDF file: Disabled
 - Use a fixed password: Disabled
- Paper size: Automatic detection
- Scan mixed paper size: Disabled
- Carrier Sheet settings:
 - Mode: Create facing pages in one image
 - Output image size: Automatic detection
- Compression
 - Compression rate: 3

The settings above can be changed in the "ScanSnap Manager Scan and Save Settings" dialog box.

For details, refer to the "4.2 Changing Scanning Settings" (page 67).

■ Scanning only one side of a document

By default, pressing the [SCAN] button  on the ScanSnap starts scanning in "Duplex" mode. When you wish to use "Simplex scan," change the settings by following the procedure below.



1. Right-click the ScanSnap Manager icon  on the task bar, and then select "SCAN Button Settings" from the menu.

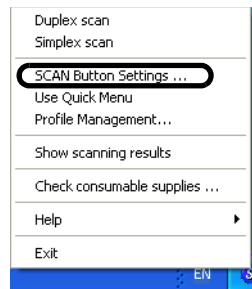

2. Click the [Scanning] tab and select "Simplex scan" from the "Scanning side:" drop-down menu.

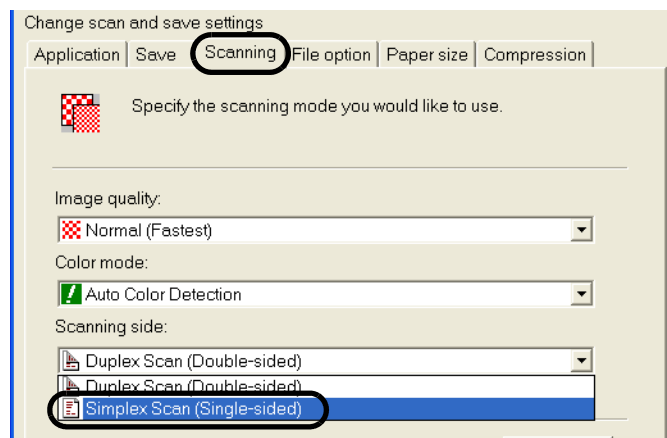

3. Click the [OK] button to save changes and close the window.



4. Load the document onto the ScanSnap.

5. Press the [SCAN] button .

⇒ The document is scanned in the "Simplex" mode.



To return the setting to the "Duplex" mode, select [Duplex scan] in Step 2. The selected setting is applied to further scans unless it is changed again.



■ Scanning color document in black and white

As the default, ScanSnap automatically recognizes whether a document is black & white or colored. Accordingly colored documents are scanned in the color mode, while black & white documents are scanned monochrome.

If you wish to scan colored document in black & white, change the settings by following the procedure below.



1. Right-click the ScanSnap Manager icon  on the task bar, and then select "SCAN Button Settings" from the menu.

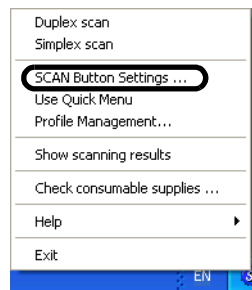

2. Click [Scanning] tab and select "B&W" at "Color mode."
If you scan color documents in color, select "Color."

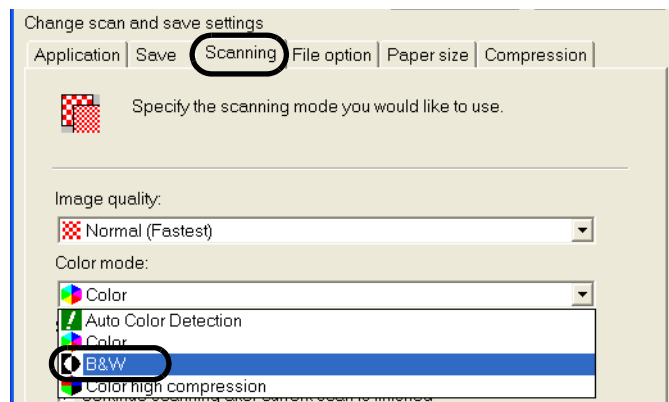

3. Click the [OK] button to close the dialog box.



4. Load the document onto the ScanSnap.
5. Press the [SCAN] button .
⇒ Scanned images will be output in black and white.

■ Scanning color documents in high compression mode

With ScanSnap, you can scan and save color documents in "Color high compression" mode so that the file size of data can be reduced.

If you scan the enormous quantity of documents in the "Color high compression" mode, for example, you can store colored documents as a space-saving PDF file.

In addition, you can increase the compression rate further by dragging the slider to the right on the [Compression] tab.

To scan color documents in high compression mode, perform the following steps to change settings.



1. Right-click the ScanSnap Manager icon **S** on the task bar, and then select "SCAN Button Settings" from the menu.

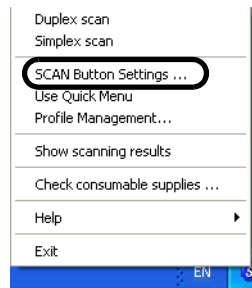

2. Click the [Scanning] tab and select "Color high compression" at "Color mode."

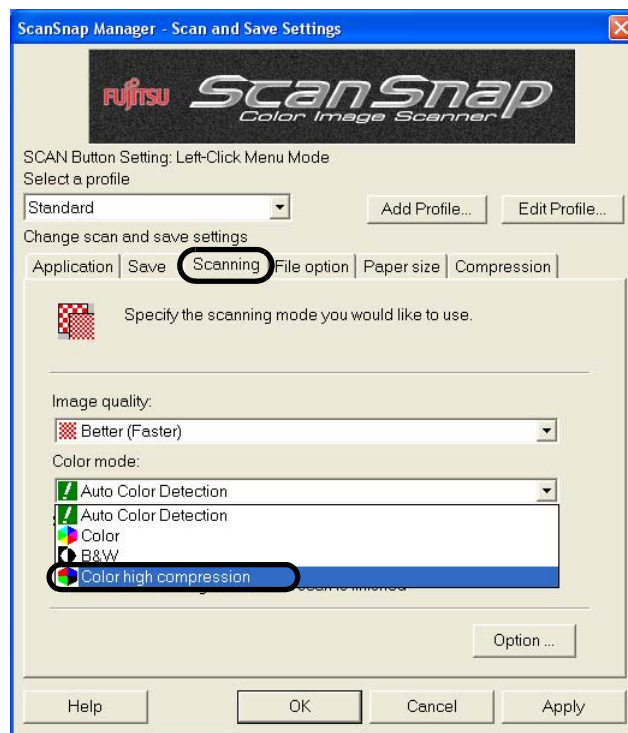

3. Click the [OK] button to close the dialog box.



4. Load the document onto the ScanSnap.

5. Press the [SCAN] button .

⇒ Scanned documents will be output as highly compressed color images.



In "Color high compression" mode, characters and backgrounds on the document are compressed separately, and thus, the file size of the document that mostly contains text characters becomes smaller while the quality of the characters is kept high. However, this mode is not appropriate for scanning photographs or figures because these graphical materials are recognized as background and compressed as such, causing degradation in images. If this setting is specified, the contrast of the image may become higher.



■ Skipping blank pages

ScanSnap is able to recognize blank pages and remove them from the output data. When scanning documents in "Duplex" mode, both sides of the documents are scanned regardless if their backsides are printed or not. Though the empty back sides are scanned, they are recognized as "blank" and automatically removed, so they will not appear on the output data.

To change the setting, follow the procedure below.



1. Right-click the ScanSnap Manager icon **S** on the task bar, and then select "SCAN Button Settings" from the menu.

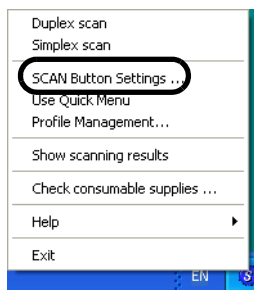

2. Select the [Scanning] tab and click the [Option] button.

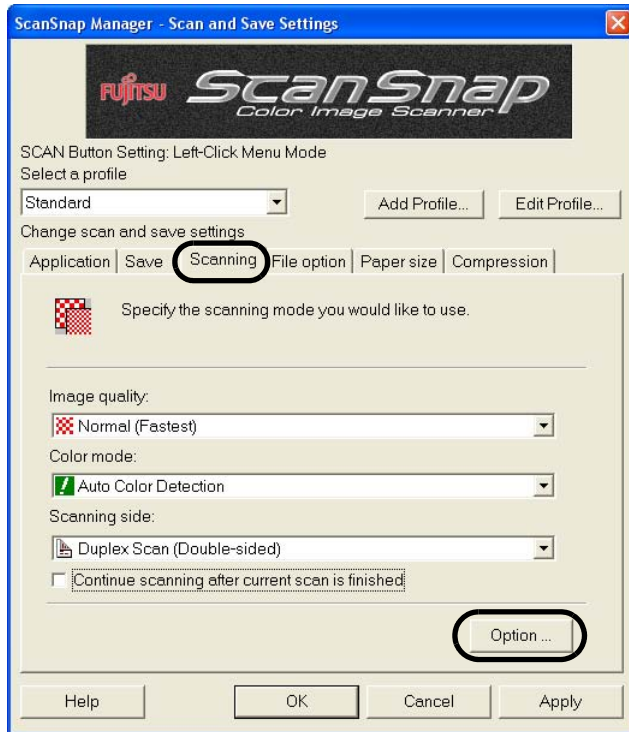

3. Select the "Allow automatic blank page removal" checkbox.

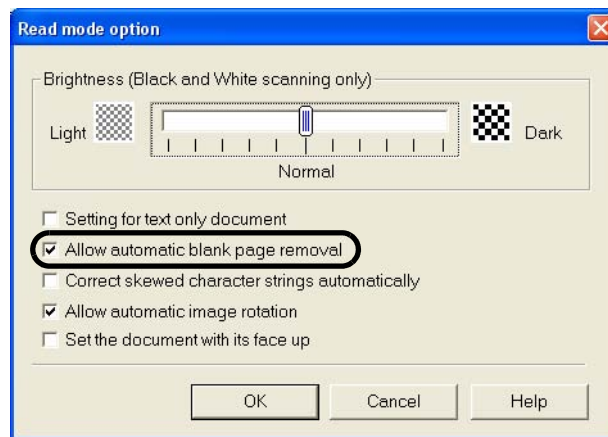

4. Click the [OK] button to close the window.
⇒ The setting is enabled from next scanning.



The following types of documents may be accidentally recognized as blank pages:

- Almost blank documents containing only a few characters
- Documents of only one color (including black) and without any patterns, lines, or characters

*When you scan such documents, clear the checkbox.



■ Correcting skewed documents

ScanSnap is able to automatically correct document skews. To change the setting, follow the procedure below.



1. Right-click the ScanSnap Manager icon **S** on the task bar, and then select "SCAN Button Settings" from the menu.

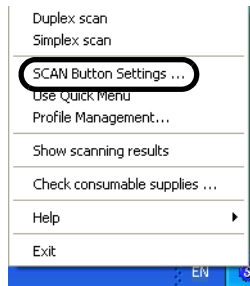

2. Select the [Scanning] tab and click the [Option] button.

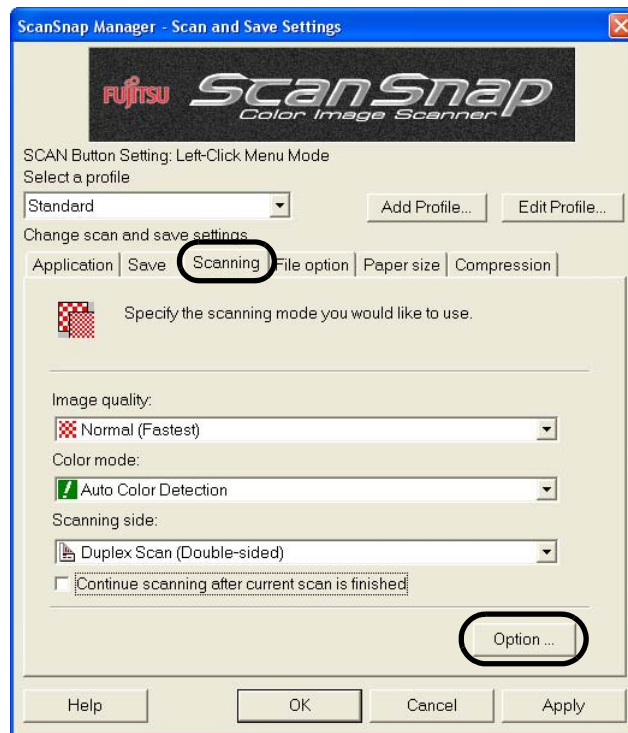

3. Select the "Correct skewed character strings automatically" checkbox.

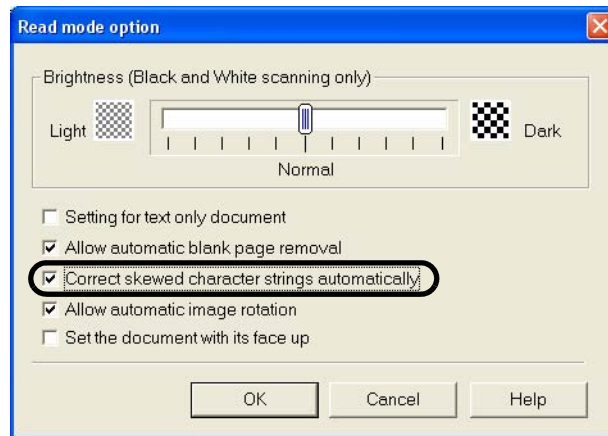

4. Click the [OK] button to close the window.
⇒ The setting is enabled from next scanning.



Up to +/-5 degrees of skews can be corrected.

This function determines a document skew based on the characters printed on the document, so it may not work properly for the following document:

- Documents on which the pitches of lines or characters are extremely narrow, or characters are overlapped
- Documents with many outline characters or using font styles like this
- Documents with many photographs or figures and only a few characters
- Documents with a background pattern behind characters
- Documents on which characters are printed in various direction (e.g. plans)
- Documents with long diagonal lines
- Documents with handwritten characters

*When you scan such documents, clear the checkbox.



■ Correcting the orientation of scanned images

When there are different types of page orientation in a document, ScanSnap is able to automatically correct the orientation of the scanned images for the document. For example, it is often seen that a document has portrait pages for text contents and landscape pages for tables. For the case of double-sided documents in calendar style, their rear sides are printed upside down. To change the setting, follow the procedure below.



1. Right-click the ScanSnap Manager icon **S** on the task bar, and then select "SCAN Button Settings" from the menu.

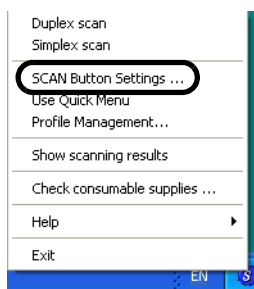

2. Select the [Scanning] tab and click the [Option] button.

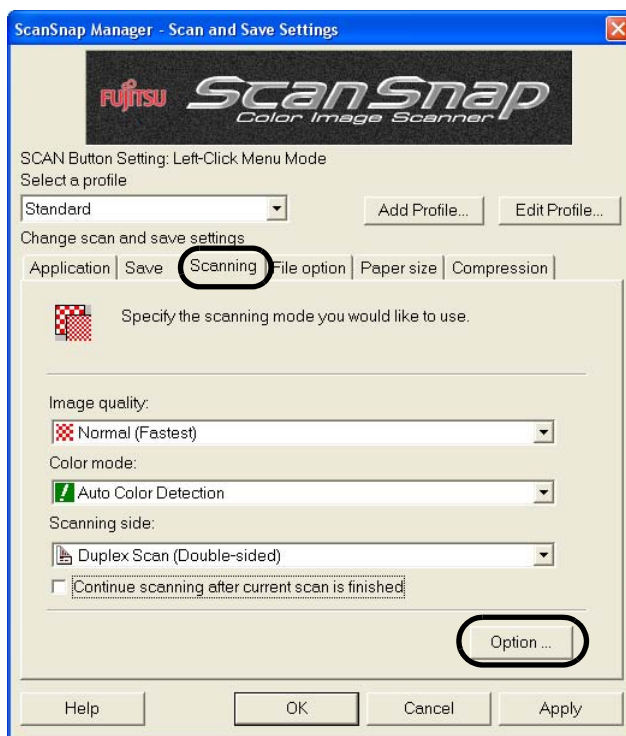

3. Select the "Allow automatic image rotation" checkbox.

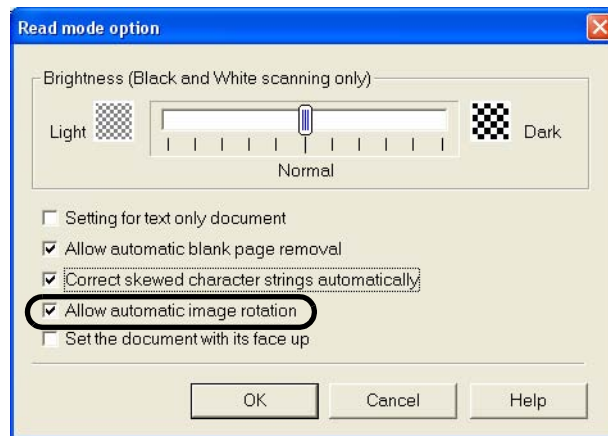

4. Click the [OK] button to close the window.

⇒ The setting is enabled from next scanning.



This function determines a document orientation based on the characters printed on the document. So it may not work properly for the following kinds of documents:

- Documents with many extremely large/small characters
- Documents on which the pitches of lines or characters are extremely narrow, or characters are overlapped
- Documents with many characters that contact underlines or ruled lines
- Documents with many photographs or figures and only a few characters
- Documents with a background pattern behind characters
- Documents on which characters are printed in various directions (e.g. plans)
- Documents with only capital letters
- Documents with handwritten characters

*When you scan such documents, clear the checkbox.



■ Scanning documents of different widths or sizes at a time

By marking the "Scan mixed paper size" checkbox, you can scan documents of different widths or sizes in one batch.

To scan documents of various sizes, do the following.



1. Right-click the ScanSnap Manager icon **S** on the task bar, and then select "SCAN Button Settings" from the menu.

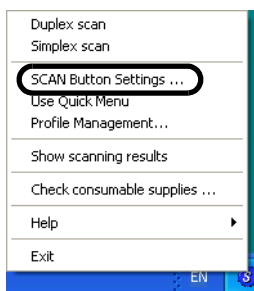

2. Select the [Paper size] tab.

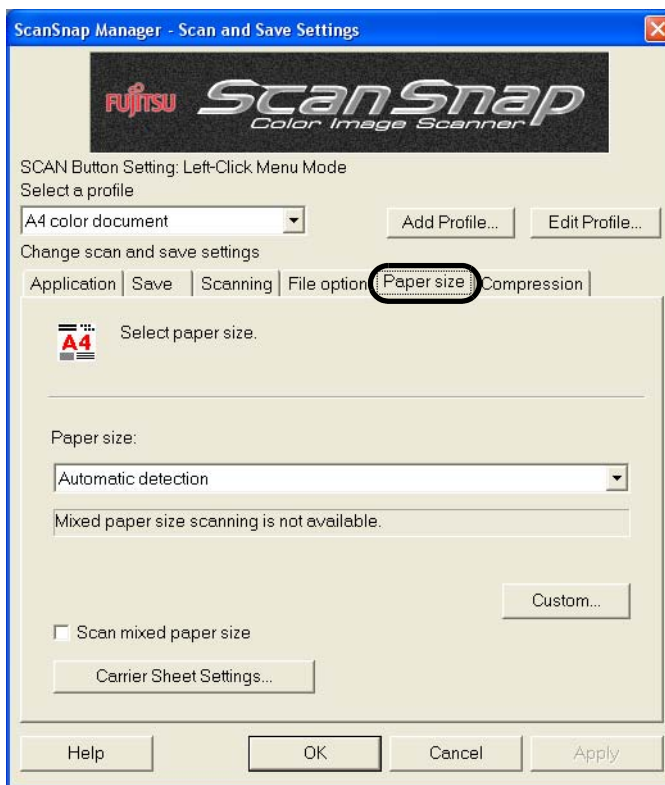

6 Using the ScanSnap in Various Ways

3. Mark the "Scan mixed paper size" checkbox.

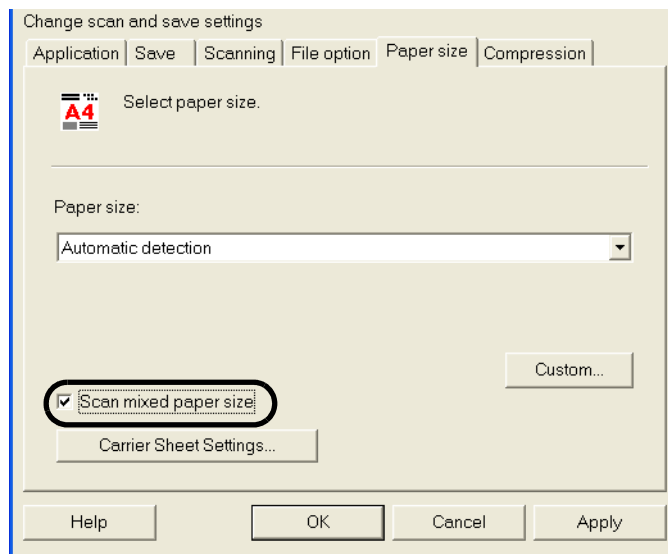

4. Click the [OK] button to close all the windows opened.



This function is available only when "Automatic detection" is selected from the "Paper size" drop-down menu.



5. Align the edge of all documents.

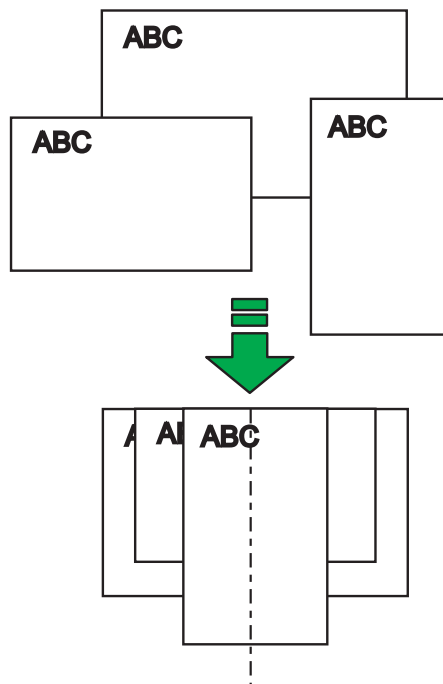

6. Load the document onto the paper chute.

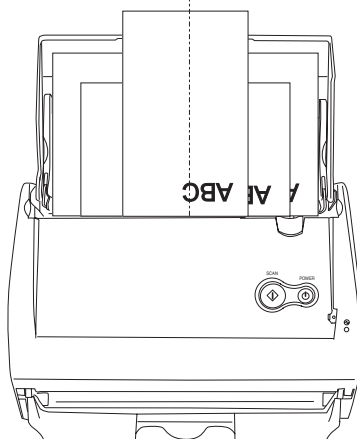

- Place all documents in the center under the pick roller. (Documents that are not under the pick roller cannot be fed.)

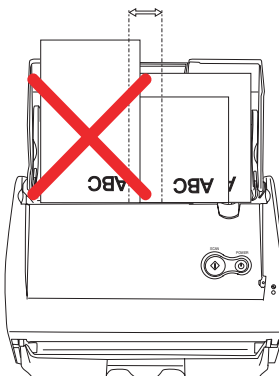

- Adjust the side guide to the widest document.
- Carefully load the smaller documents, which cannot contact the side guide, so that they can be fed straight. If the documents are skewed during a scan, the quality of scanned images may be degraded (chipped images/slant lines produced) or scanned images may be output in different size from the original. If you have difficulties feeding documents straight, it is recommended to scan documents in several batches; scan documents of about the same width in one batch.
Note that smaller documents that cannot be guided by the side guide may cause a jam.



7. Press the [SCAN] button  .

⇒ The size of all output images conforms to the respective documents.

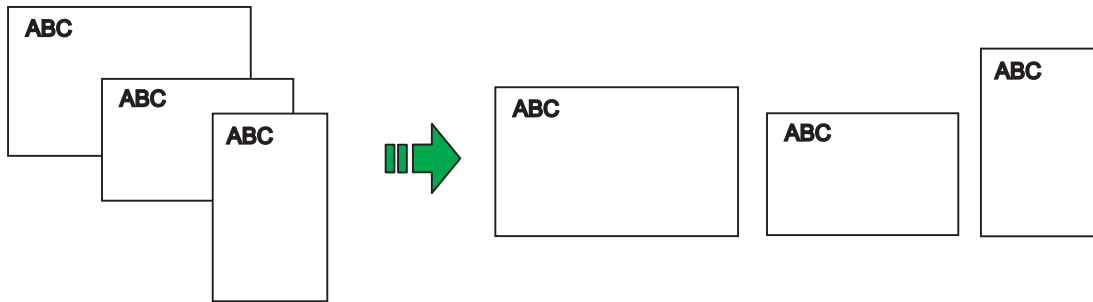

If the document was scanned as skewed, the output image size may be different from the document's size.



■ Saving scanned images in multiple files

ScanSnap can save scanned images in multiple files based on the specified number of pages. For example, you can scan a batch of documents and create files for every single page. To change the setting, follow the procedure below.



1. Right-click the ScanSnap Manager icon **S** on the task bar, and then select "SCAN Button Settings" from the menu.

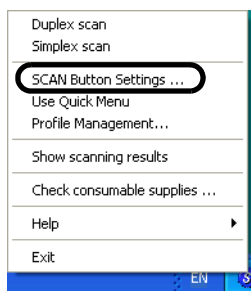

2. Select the [File option] tab and click the [Option] button.

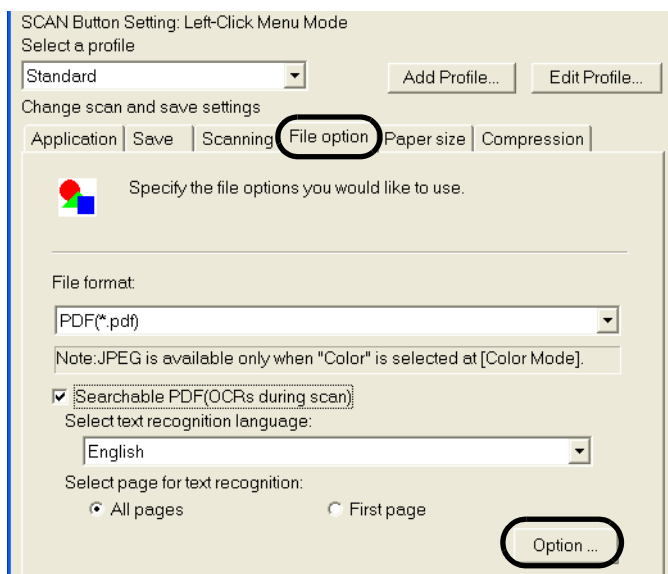

Make sure that "PDF(*.pdf)" is selected at "File format."



3. In the "PDF file format option" window, select "Generate one PDF file per x page(s)" and enter a number.

One PDF file is created every time when the specified number of pages have been scanned.

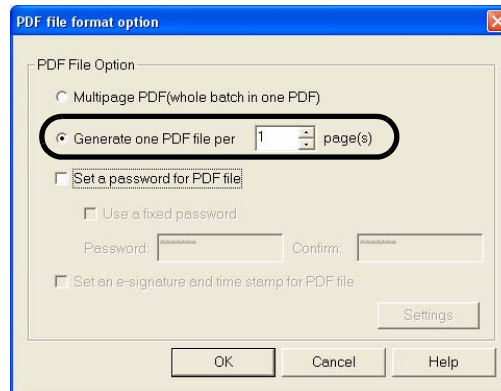

In "Duplex" mode, two pages (front/back) are created per document sheet. It is recommended that you clear "Allow automatic blank page removal"; select the [Scanning] tab ⇒ [Option] button to open the window. If this function is enabled, there may be a discrepancy between the page numbers of the original document and the resulting document in which blank pages may be deleted.

4. Click the [OK] button to close the window.
⇒ The setting is enabled from next scanning.

■ Merging scanned images divided by scanning errors into one PDF file

When you are scanning documents and saving them in PDF format, the following window appears if the scanning is interrupted by a paper jam or error.

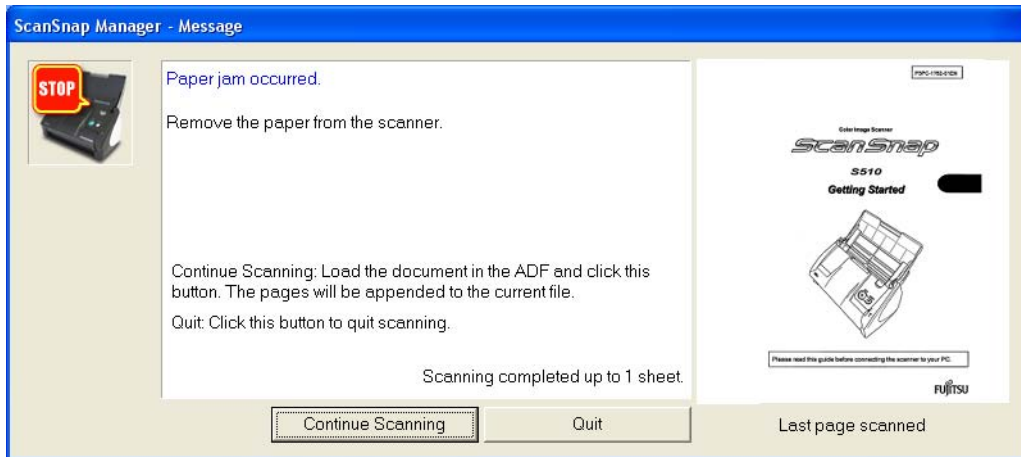

You can resume or abort the scanning by the following procedure.

<To resume scanning>



1. Check the last scanned page in the "Message" window.
2. Load the not-yet scanned pages on ADF.
3. Click the [Continue Scanning] button to restart the scanning.

<To quit scanning>



1. Click the [Quit] button.
⇒ The following window appears.

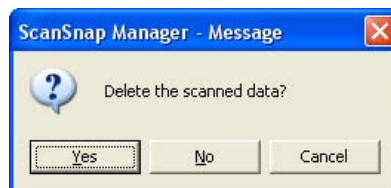

- Click the [Yes] button to delete the data that has been scanned up to the interruption, or click the [No] button to save the data that has been scanned up to the interruption.
*Click the [Cancel] button not to quit but to return to the previous window.



The [Continue Scanning] button may not be displayed on the window and an error message like the example below may appear. In this case, it is not possible to resume scanning. You will use Adobe Acrobat if you want to merge two divided image files; this operation is only available for files of PDF format.

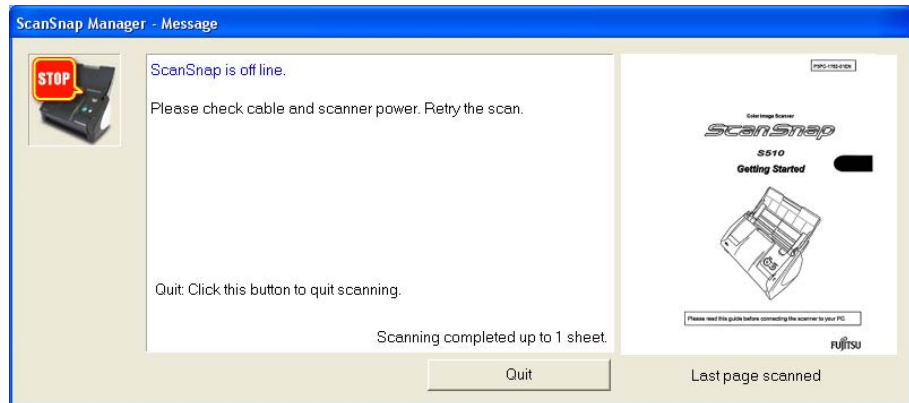

The following shows the procedures for this operation:

- Confirm the last page scanned on the "Message" window.
- Click the [Quit] button, then the following window appears.

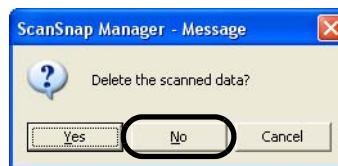

- Click the [No] button to save the image (PDF file) scanned before the interruption (this file is called "File A").
- Scan the remaining documents (this part is called "File B").
- Open "File A" with Adobe Acrobat.
- From the menu bar, select [Document] - [Insert Pages].

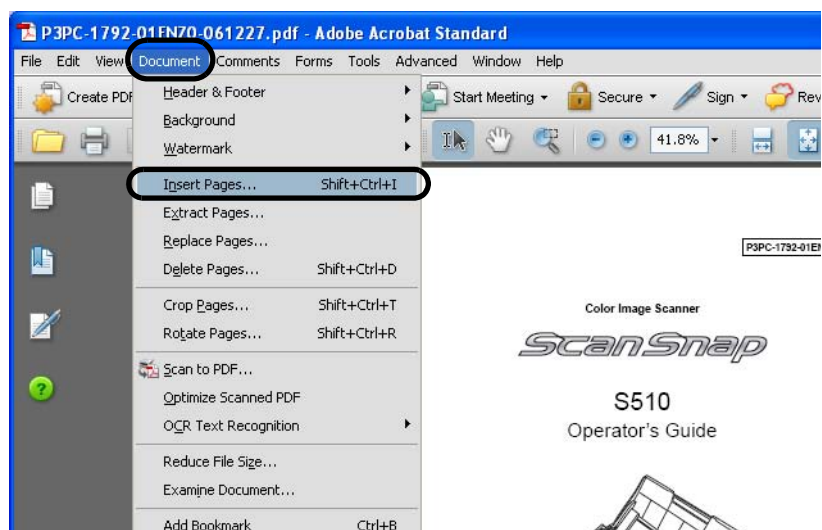

7. Select "File B" in the "Select File to Insert" window and click the [Select] button.

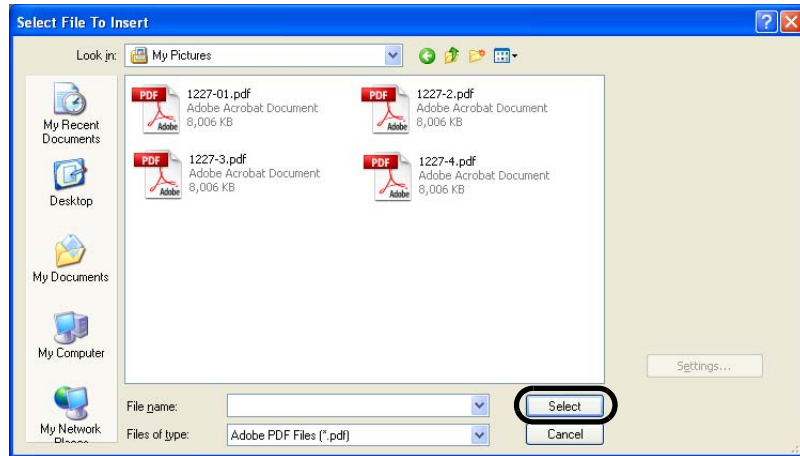

⇒ The "Insert Pages" window will appear.

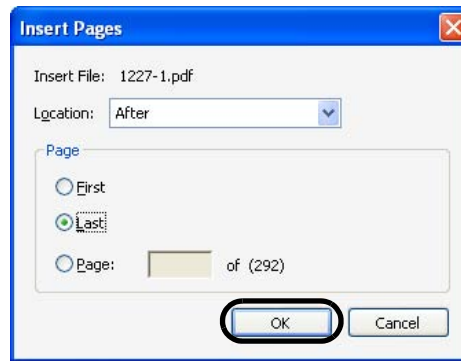

8. Select "After" from the Location menu and "Last" from Page radio buttons, then click [OK].



■ Setting Passwords for Scanned Documents

When saving document images scanned with the ScanSnap as PDF files, you can set passwords for the PDF files.

The password-protected PDF files cannot be opened unless a Document Open password is entered. If you set a password for sensitive documents or confidential documents, adequate security of information can be provided.

Passwords can be set only in Left-Click Menu Mode.

To use this function in Windows Vista, Adobe Acrobat must be installed.



1. Right-click the ScanSnap icon , and then select "SCAN Button Settings" in the pop-up menu.

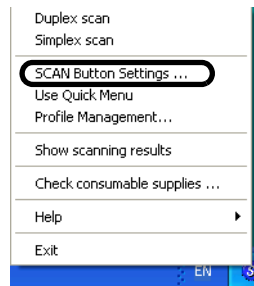

2. On the [File Option] tab, click the [Option] button.

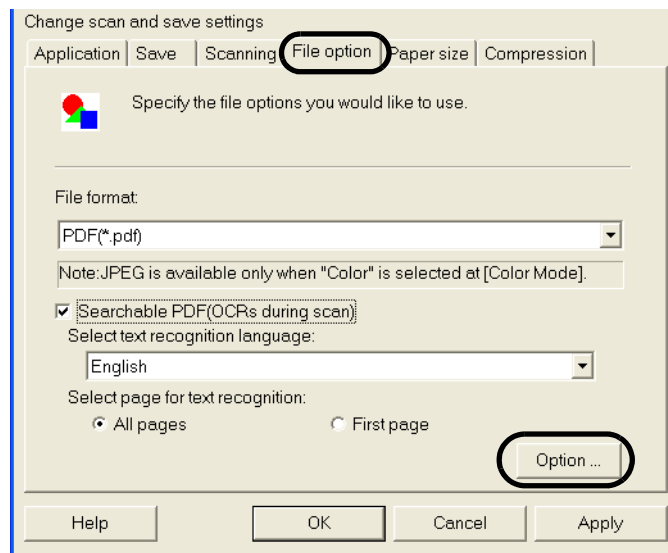

Check that "PDF (*.pdf)" is selected in the "File Format" drop-down list.

6. Press the [SCAN] button .

⇒ Scanning starts.

⇒ If the "Use a fixed password" is not marked in step 3, the following dialog box appears.



In the "Password" and "Confirm" fields, type in the same password, and then click the [OK] button.



- The following characters can be used to set passwords:

Number of characters: Up to 16 characters

Characters: A-Z, a-z, 0-9

Symbols: ! " # \$ % & ' () * + , - . / : ; < = > ? @ [\] ^ _ ` { | } ~

- If you click the [Cancel] button, the PDF file is saved without a password.

⇒ The scanned document is saved as a password-protected PDF file.



If you forget a password, there is no way to open the PDF file. It is a good idea to store passwords in another secure location in case you forget them.

■ Performing text recognition when scanning documents

Documents can be text-recognized while being scanned. If text-recognized, PDF files are searchable.



1. Right-click the ScanSnap icon **S**, and then select "SCAN Button Settings" in the pop-up menu.

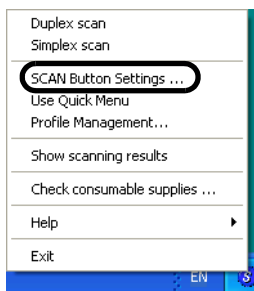

2. On the [File Option] tab, select "PDF" from the "File format" drop-down list.

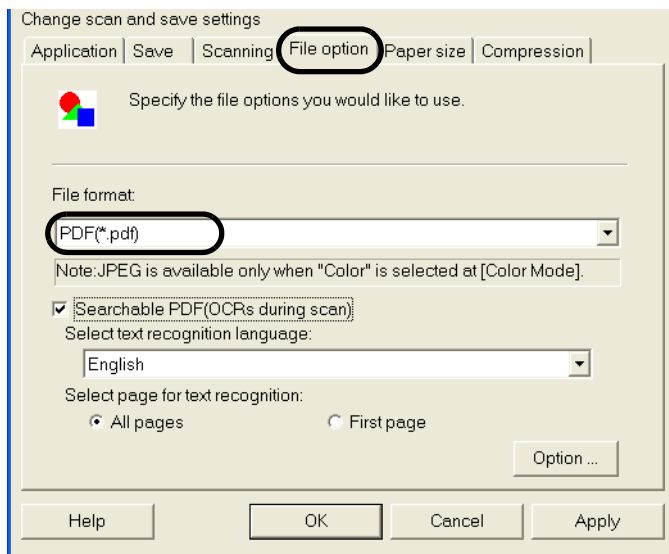

3. Mark the "Searchable PDF (OCRs during scan)" checkbox.
To perform text recognition for all pages, select "All pages"; for the first page, select "First page" on the tab.

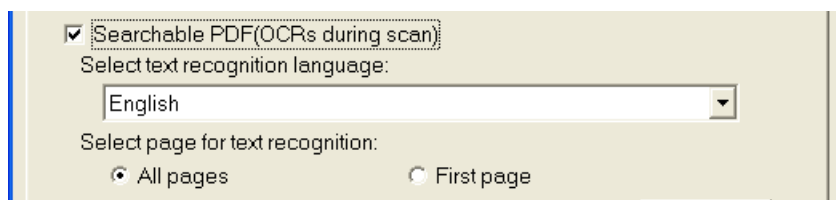

-
- Click the [OK] button to close all dialog boxes.



- Load the document onto the ScanSnap.

- Press the [SCAN] button .

⇒ Scanning starts.

The document is text-recognized, and a searchable PDF file is created from the scanned document and saved in a folder.



- It may take an extended period of processing depending on your personal computer's performance.
- The ScanSnap may fail to correctly recognize the following types of documents (characters) as text. However, by changing Color mode and/or improving Image quality for scanning, such documents may be successfully text-recognized.
 - Handwritten documents
 - Documents scanned in low quality, including smaller characters.
 - Skewed documents
 - Documents written in languages other than the specified language for text recognition
 - Documents including texts written in Italic characters
 - Superscript/subscript letters and complex mathematical formulas
 - Characters are written against an unevenly-colored or patterned background
 - Characters to which effects (Shadow, Outline, and the like) are applied
 - Shaded characters
 - Documents of complex layout as well as documents including unreadable characters (due to print-through and smudges)

(It may take an extended period of time to scan documents described above.)



6.2 Using Adobe Acrobat

You can modify created PDF files with Adobe Acrobat .

HINT  For detailed information about the Adobe Acrobat functions, refer to "Adobe Acrobat Help."

■ Rotating pages within a PDF file

If the "Allow automatic image rotation" function (page 181) fails to change the view of pages, or you want to rotate pages in a document, follow the procedure below.



- 1. With Adobe Acrobat, open the PDF file.

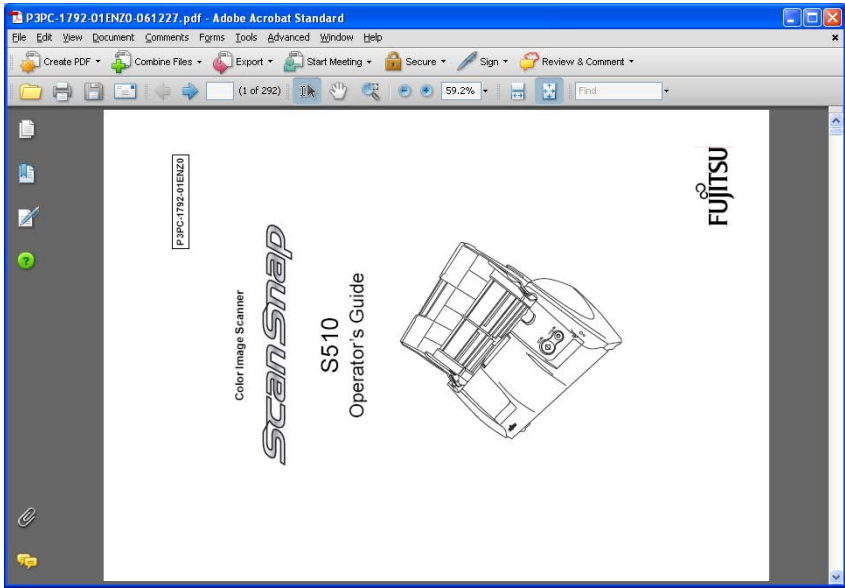

9 Using the ScanSnap in Various Ways

- From the menu bar, select [Document] ⇒ [Rotate Pages].

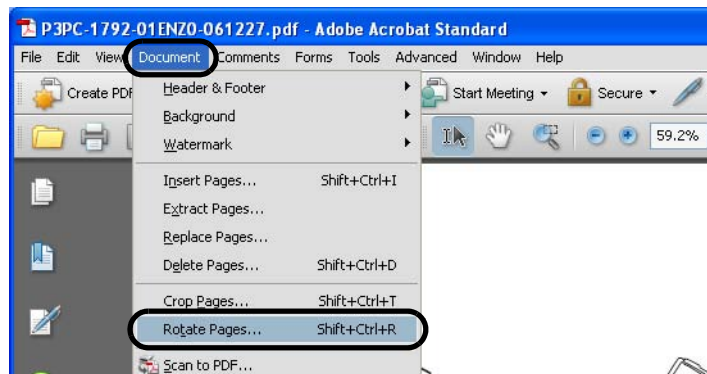

- Specify pages of which you want to change the view, and then click the [OK] button.
Direction: Select the amount and direction of the rotations.
Page Range: Specify whether all pages, a selection of pages, or a range of pages are to be rotated.

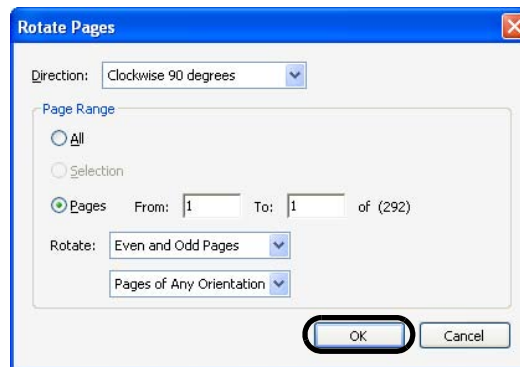

⇒ The view of the selected page is changed.

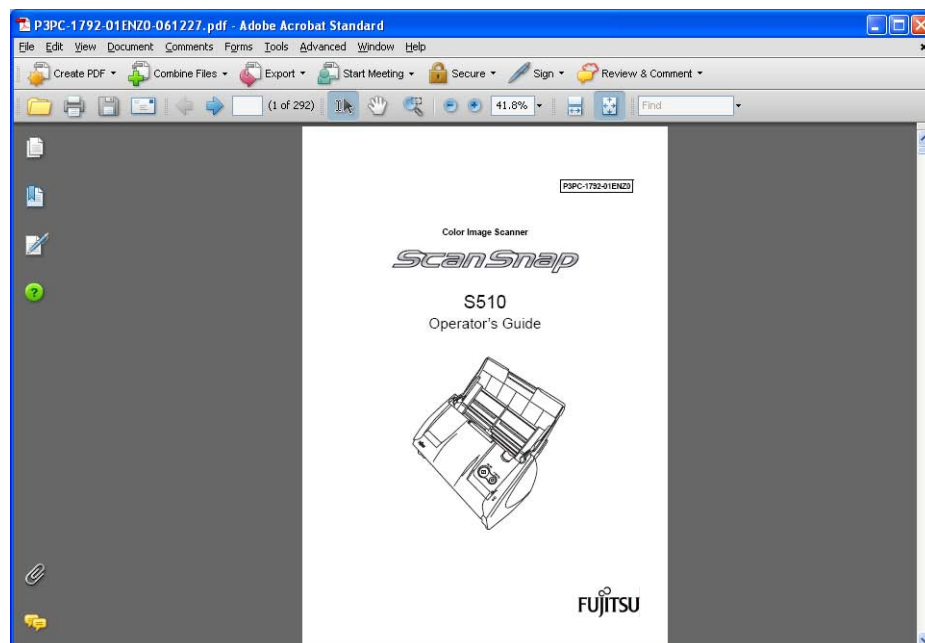

■ Deleting pages from a PDF file

If the "Allow automatic blank page removal" function (page 177) fails to remove blank pages from a PDF file, or you want to delete unwanted pages, follow the procedure below.



1. With Adobe Acrobat, open the PDF file.
2. From the menu bar, select [Document] ⇒ [Delete Pages].

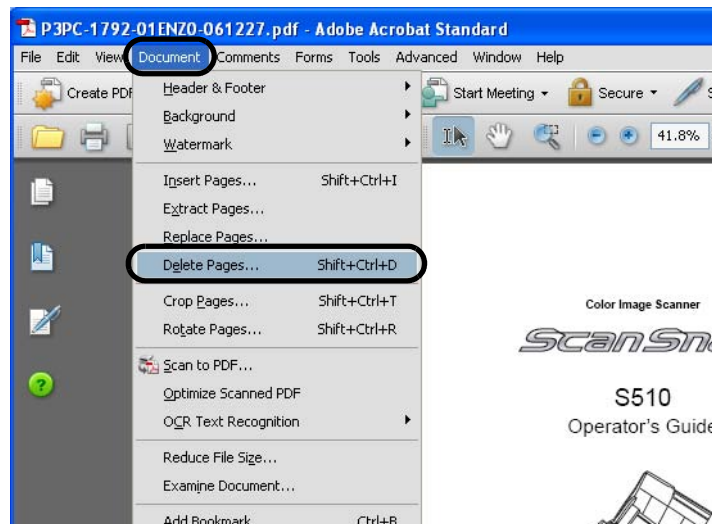

3. Specify a range, and then click the [OK] button.

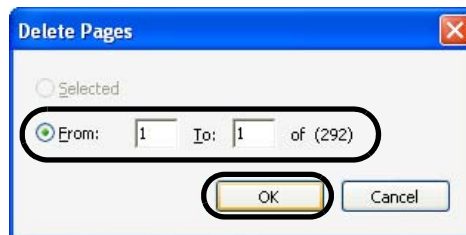

⇒ The pages within the specified range are deleted.

■ Converting scanned images to searchable text via OCR

All documents scanned with the ScanSnap are saved as image files, if not text-recognized. Symbols, characters, and numbers in scanned documents are only text images, and the personal computer cannot recognize the text images as normal text. This means that you are not able to search the text in a scanned PDF file.

By using OCR ("Recognize Text" of Adobe Acrobat), you can convert text images into searchable text.

Follow the procedure below.



1. With Adobe Acrobat, open the PDF file to be converted.
2. Select [Document] ⇒ [OCR Text Recognition] ⇒ [Recognize Text Using OCR] from the menu.

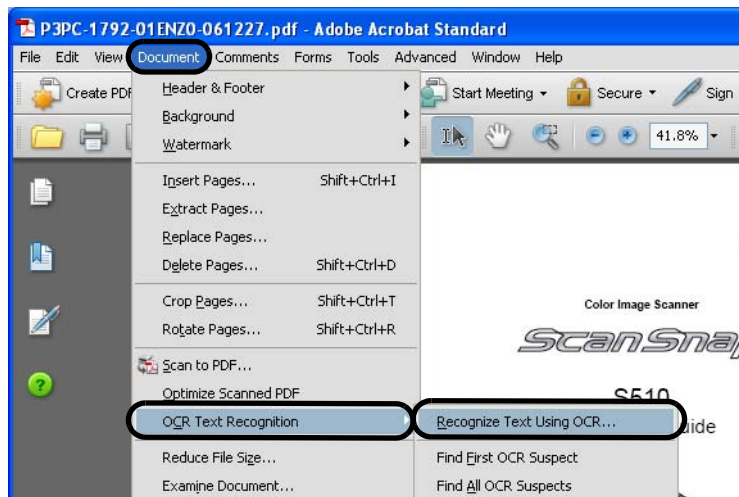

3. In the dialog box below, specify pages and edit settings, and then click the [OK] button.

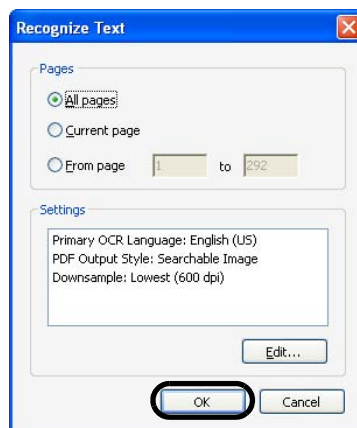

⇒ Textual information is added to the text images via OCR.



To text recognize the images of color documents, select "Better (Faster)" or "Best (Slow)" in the "Image quality" drop-down list on the [Scanning] tab of the "ScanSnap Manager - Scan and Save Settings" dialog box (page 78).

6.3 Scanning Business Cards

CardMinder, which is application software for managing business card images, comes with the ScanSnap.

By using CardMinder, you can convert business cards into image files, and create a database of business cards by recognizing their text images via OCR (Optical Character Recognition).

The following describes how to start CardMinder and scan business cards with the ScanSnap.



- For further details, refer to the "CardMinder User's Guide." If CardMinder is already installed on your personal computer, you can view the User's Guide by selecting [Start] ⇒ [All Programs] ⇒ [CardMinder] ⇒ [Manual]. (You can also view the User's Guide from the initial screen of the "Setup CD-ROM" supplied with the ScanSnap.)
- In Left-Click Menu Mode: When CardMinder is started and becomes active, "CardMinder" is automatically selected in the "Application" drop-down list on the [Application] tab. When CardMinder is closed or becomes inactive, the application selected in the "Application" drop-down list returns to the previously selected one.
- In Quick Menu Mode: When CardMinder is started and becomes active, the ScanSnap Quick Menu is not displayed and the ScanSnap interacts with CardMinder every time a document is scanned. If you want to use other applications or perform other actions, exit or deselect CardMinder to make it inactive.



■ Starting CardMinder

The following describes how to create scanned images of business cards on ScanSnap.

In this example, the [SCAN] button  on the ScanSnap is used to scan business cards.



Business cards can also be scanned by starting up CardMinder and clicking the [Scan] button at the upper left of the window. For details, refer to the "CardMinder User's Guide."

<Preparations>

Preparations are different depending on which mode (Quick Menu Mode or Left-Click Menu Mode) the ScanSnap is in.

In Quick Menu Mode, start CardMinder and scan documents using the Automatic Interaction function.

In Left-Click Menu Mode, start CardMinder and scan documents using the Automatic Interaction function or after selecting "CardMinder" in the "Application" drop-down list.

Scanning through Automatic Interaction



1. From the [Start] menu, select [All Programs] ⇒ [CardMinder] ⇒ [CardMinder].
⇒ CardMinder starts up.
2. Select "CardMinder" from the "Application" drop-down list on the [Application] tab to make it active.

⇒ The ScanSnap automatically interacts with CardMinder.



When another application is selected (becomes active), the ScanSnap no longer interacts with CardMinder. Depending on the setting you select, the application interacts with the ScanSnap differently. For details, refer to "About Automatic Interaction with Applications" on page 111.

Selecting another application



1. Right-click the ScanSnap Manager icon **S** on the task bar, and select [SCAN Button Settings] from the menu that is displayed.

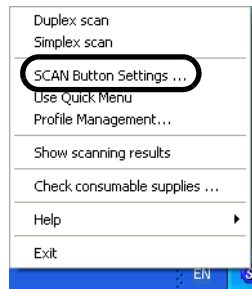

⇒ The "ScanSnap Manager - Scan and Save Settings" dialog box is displayed.

2. Select "CardMinder" from the "Application" drop-down list on the [Application] tab.

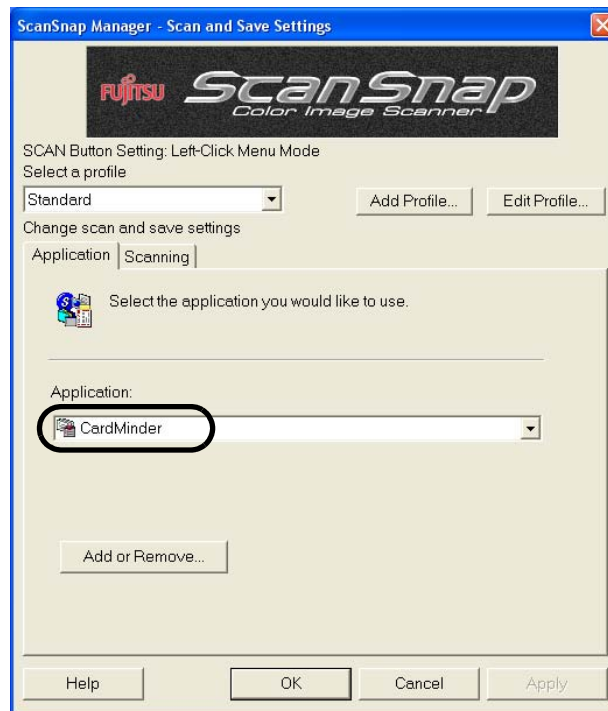

⇒ Two tabs, the [Application] and [Scanning] tabs, will be displayed.



"Image quality" and "Color mode" can be changed on the [Scanning] tab.
(Refer to "[Scanning] tab" on page 78.)
The defaults are "Best" and "Color" for the scan mode. (In this section, business cards are scanned using these default settings.)
When CardMinder is selected from the [Application:] drop-down list, the option "Excellent" in the [Image quality] field on the [Scanning] tab is not available.

3. Click the [OK] button.
⇒ This closes the "Scan and Save Settings" screen.

<Scanning procedure>



1. Load the business cards onto the ScanSnap.

- Load the business cards face down.
- When you scan more than one business card, set them together.
- Adjust the side guides so that they are touching the business card edges.

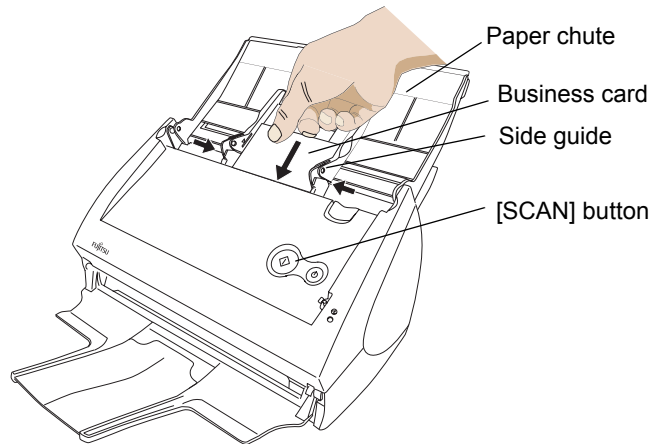

2. Press the [SCAN] button on the ScanSnap.

⇒ Scanning will be started. After the scanning has finished, the "CardMinder" screen is displayed.



- Do not connect or disconnect other USB devices during the scanning operation.
- Do not close the paper chute or press the [POWER] button on the ScanSnap during the scanning operation.
- Do not switch the user to log in during the scanning operation.



- As the default setting, documents are scanned at "Duplex" mode when you press the [SCAN] button. Using ScanSnap Manager, you can set the ScanSnap to scan documents in "Simplex" mode by pressing [SCAN] button.
- You can also start scanning with the ScanSnap Manager icon  on the task bar.

*For details, refer to "4.2 Changing Scanning Settings" (on page 67).

6.4 Using ScanSnap Organizer

ScanSnap Organizer is a software application for displaying and sorting image files such as the PDF and JPEG files.

Images scanned by ScanSnap can be displayed without opening, folders can be created for different purposes, and files can also be sorted.

This following explains how to use ScanSnap Organizer.

■ Starting ScanSnap Organizer



For details, refer to "ScanSnap Organizer User's Guide."

If ScanSnap Organizer has already been installed, you can refer to it by selecting [Start] ⇒ [All programs] ⇒ [ScanSnap Organizer] ⇒ [Manual]. (You can also access the manual from the initial screen of the provided software on the ScanSnap Setup CD-ROM.)



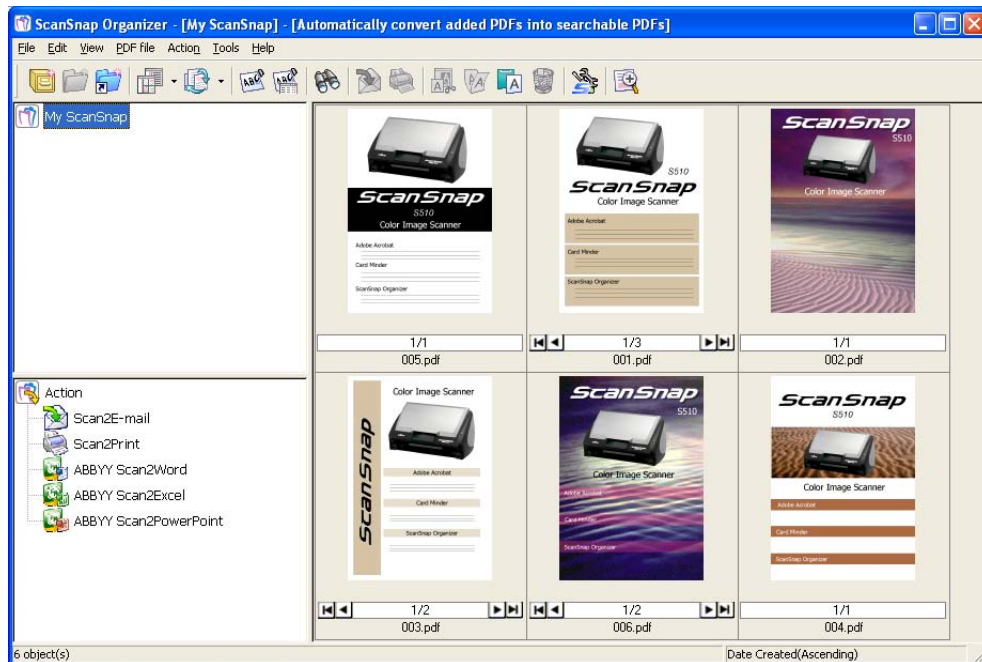

1. From the [Start] menu, select [All Programs] ⇒ [ScanSnap Organizer] ⇒ [ScanSnap Organizer].

⇒ The ScanSnap Organizer window appears.





- You can also double-click the ScanSnap Organizer icon  on the desktop.
- Password-protected PDF files are not thumbnailed because of security reasons.* These files are displayed in the form of the Adobe Acrobat icon along with the lock symbol  on the bottom left-hand corner.
 - * However, PDF files with the same password as the "fixed password" set on the "PDF file format option" window using ScanSnap Manager can be thumbnailed.
For details on how to set the fixed password, refer to "Set a password for PDF file" on page 85.
- If ScanSnap Manager is activated after ScanSanp Organizer is activated, [Application:] on the [Application] tab will automatically be switched to "ScanSnap Organizer," and if ScanSnap Manager is activated after ScanSnap Organizer is deactivated, [Application:] on the [Application] tab will be switched to the previously-selected application.

■ Interacting with the ScanSnap

This section describes how to scan documents with the ScanSnap to display images in ScanSnap Organizer.

<Preparation>



1. Right-click the ScanSnap Manager icon  on the task bar, and then select "SCAN Button Settings" from the menu.

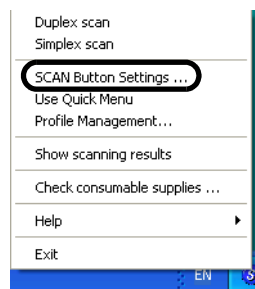

⇒ The "ScanSnap Manager - Scan and Save Settings" dialog box appears.

2. Select "ScanSnap Organizer" from the "Application" drop-down list on the [Application] tab.

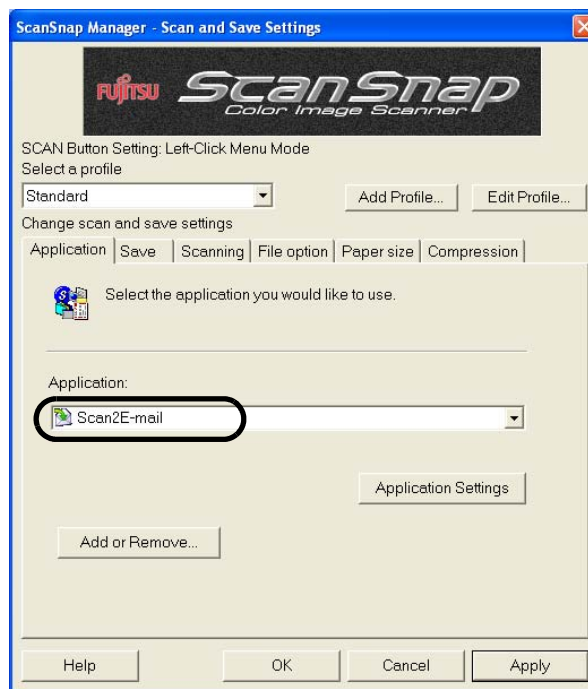

3. Click the [OK] button.

⇒ The "ScanSnap Manager - Scan and Save Settings" dialog box closes.

<Scanning>



1. Load the document onto the ScanSnap.

2. Press the [SCAN] button .

⇒ Scanning starts.

When scanning is complete, "ScanSnap Organizer" starts and displays the scanned image as a thumbnail.

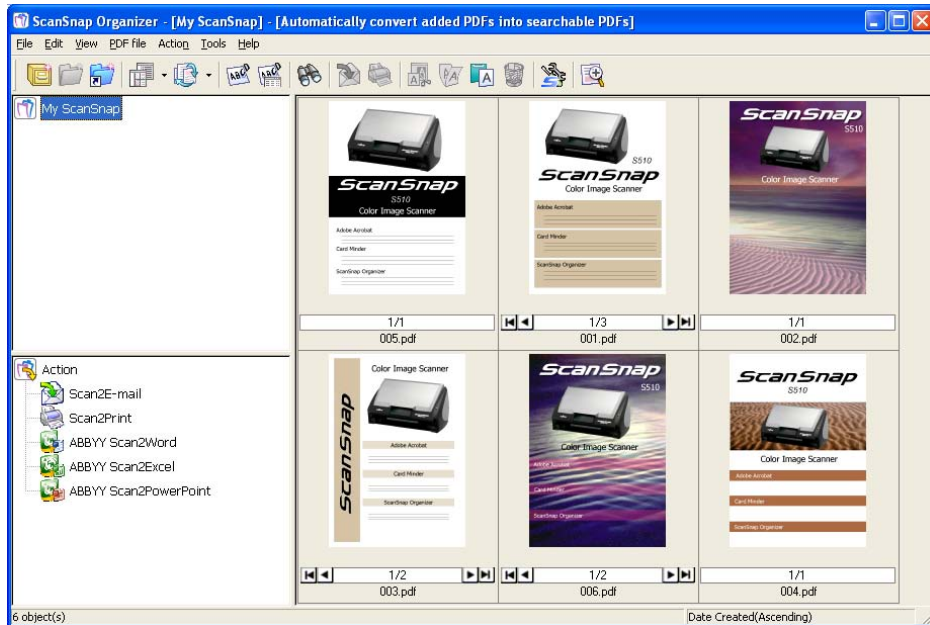

The scanned image is saved in the folder specified in [My ScanSnap Folder:] on the "Option Settings" window. (Refer to page 208)

*The initial setting is the [My ScanSnap] folder under [My Documents].

<Sorting Files>

How to create a new Cabinet and folder and how to move scanned files to the Cabinet and folder are explained here.



The idea is similar to arranging a big pile of documents (files) in the room ([My ScanSnap] folder), purchasing a new shelf (Cabinet) and a new document tray (folder), and classifying them according to subject to sort out the documents.



1. On the [File] menu, select [New] ⇒ [Cabinet].
⇒ Under [My ScanSnap] folder in Folder View, [New Cabinet] is created.



2. Enter a name for the Cabinet.
Enter the name "Investigation Report" here.
3. Select the Cabinet created in Step 1.



4. On the [File] menu, select [New] ⇒ [Folder].
⇒ Under the Cabinet created in **Step 1**, [New Folder] is created.



5. Enter a Folder name.
6. Repeat Steps 4, 5 to create folders as needed.
As an example, create two folders named [July 2007] and [August 2007].



7. Select the file.



You can select several files at one time when you press down and hold the [Ctrl] key.

8. Drag-and-drop the selected file to the destination folder.

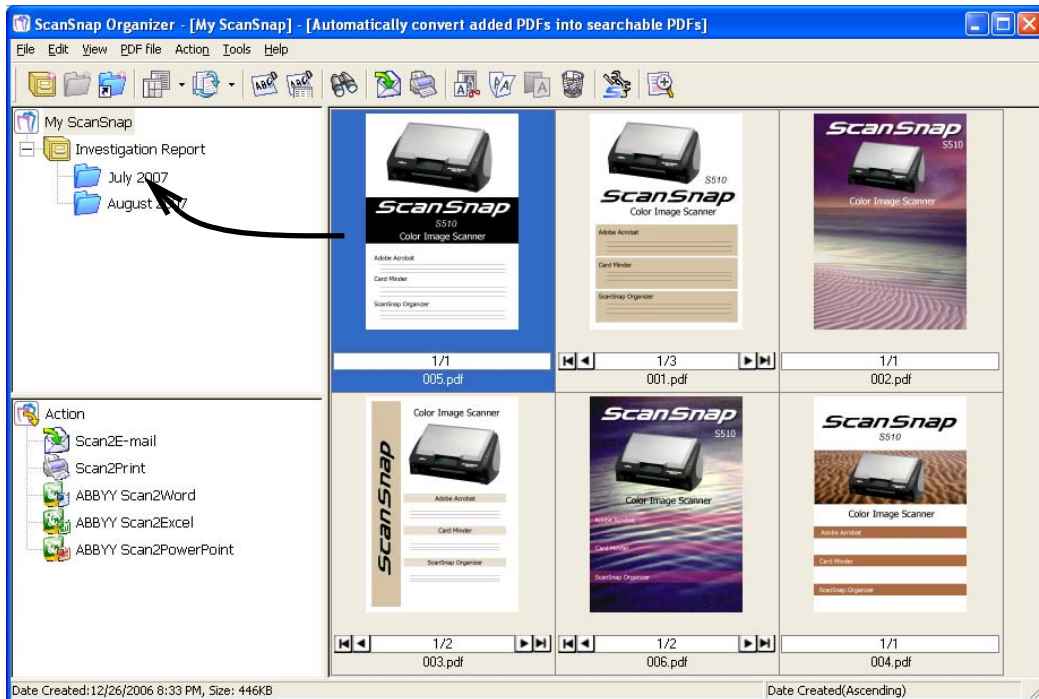

9. Repeat Steps 7, 8 to store files in the destination folders.

<Using the Action Menu>

You can use Actions in the Action menu by dragging thumbnails onto Actions. Using this Action menu is just like using Actions in the ScanSnap Quick Menu chapter 5 "About Actions" on page 115.



1. Select a file.



Hold down the Ctrl key to make multiple selections.



2. Drag the selected file onto an Action you want to use.

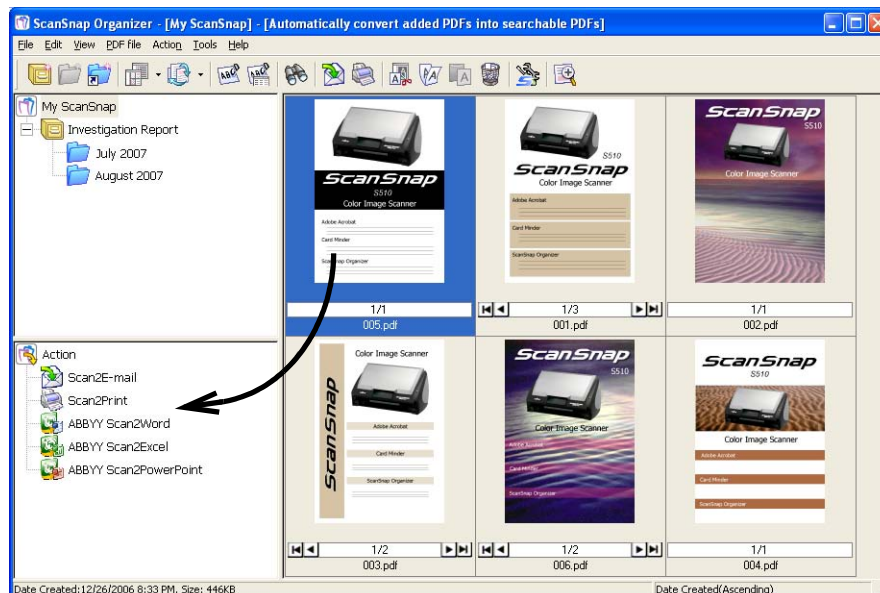

⇒ The Action is performed.

Actions you can select are:

Action	Description
Scan2E-mail	An e-mail program is started with selected files attached to an e-mail message.
Scan2Print	Selected files are printed with a printer.
ABBYY Scan2Word *1	Selected files are converted into Word file format through OCR.
ABBYY Scan2Excel *1	Selected files are converted into Excel file format through OCR.
ABBYY Scan2PowerPoint *1	Selected files are converted into PowerPoint file format through OCR.

Note 1: This Action does not appear unless ABBYY FineReader for ScanSnap 3.0 is installed.



For details about the Action menu of ScanSnap Organizer, refer to "ScanSnap Organizer User's Guide."



Chapter 7



Troubleshooting

This chapter describes how to remove jammed documents and resolve other problems.



7.1 Clearing Document Jams	218
---	------------

7.2 Troubleshooting Checklist.....	220
---	------------

7.1 Clearing Document Jams

If a paper jam occurs during scanning, follow the procedure below to remove the jammed document.



- Open the ADF before removing the jammed document.
- Be careful when removing the jammed document.
- When removing the jammed document, be careful not to get neckties or necklaces entangled in the ScanSnap.
- The surface of the ADF glass becomes hot during operation. Take care not to get burned.



Clean the ADF by following the guidelines in "8.3 Cleaning the Inside of the Scanner" (page 232).



1. Remove the document on the paper chute.
2. Open the ADF while pulling the cover open lever.

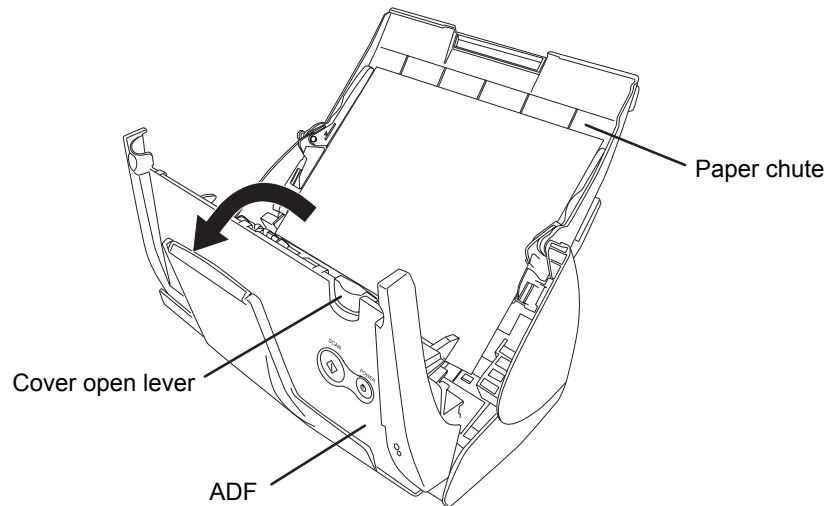

3. Remove the jammed document.

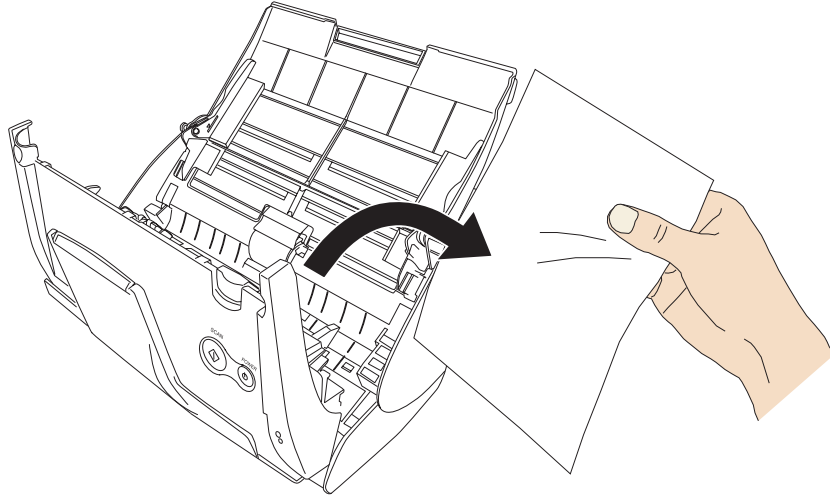

4. Close the ADF.

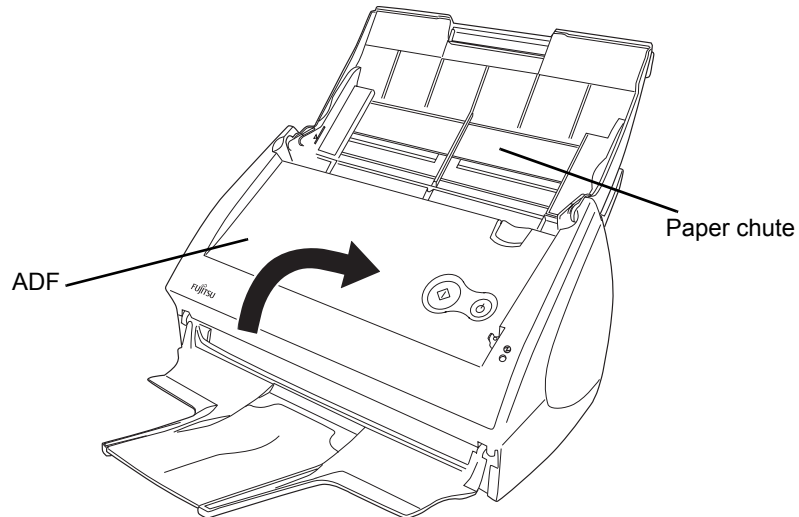

⇒ You should hear the ADF click when it returns to its original position.



Make sure that the ADF is completely closed. Otherwise, paper jams or other feeding errors may occur.



7.2 Troubleshooting Checklist

This section describes common problems that may occur during usage of the ScanSnap and how to solve the problems.

Before you call a repair service, perform simple troubleshooting steps in the table below.

If performing these troubleshooting steps does not resolve your problem, contact an authorized FUJITSU scanner service provider.

Symptom	Check This Item	Resolution
The scanner cannot be turned on.	Are the AC/USB cable and the AC adapter connected correctly?	Correctly connect the Power/USB cable.
		Disconnect and then re-connect the Power cable. (* Wait at least 5 seconds before reconnecting the Power cable)
	Is the paper chute closed? (The scanner's power is controlled by closing/opening the paper chute.)	Open the paper chute.
	Is Windows normally started up? (This scanner's power is controlled by turning on/off the computer.)	Wait until Windows has started up completely. ① LED will turn off when Windows is starting up or in the sleeping mode.
	Did you press the [POWER] button to turn off the ScanSnap? (The scanner can be turned off by pressing [POWER] button when the paper chute is opened.)	Press the [POWER] button.

Symptom	Check This Item	Resolution
Scanning does not start.	Is the USB cable connected correctly?	Connect the USB cable correctly. (When a hub is used, check the hub's power supply.)
	Does the  LED light blink continuously?	Disconnect and then re-connect the Power cable. (* Wait at least 5 seconds before reconnecting the Power cable)
	Is ScanSnap Manager started? (If ScanSnap Manager is started up successfully, the ScanSnap Manager icon  appears on the task bar.)	If the ScanSnap Manager icon is not displayed, select [Start] ⇨ [All Programs] ⇨ [ScanSnap Manager] ⇨ [ScanSnap Manager] to start ScanSnap Manager.
	Is ScanSnap Manager running properly? (If ScanSnap Manager is not running properly, the ScanSnap Manager icon in the task bar is displayed as  .)	Do the following: <ol style="list-style-type: none"> 1. Perform "Scan for hardware changes" or "Refresh" from Device Manager.(*1) If the situation does not improve, perform step 2. 2. Disconnect and re-connect the AC cable and AC adapter (Wait at least 5 seconds before turning on the power again). If this does not improve the situation, perform step 3. 3. If a USB hub is used, directly connect the ScanSnap to your PC. If this does not improve the situation, perform step 4. 4. If your PC has multiple USB ports, connect ScanSnap with another port. If this does not improve the situation, perform step 5. 5. Restart your PC. If none of the above operations resolves the problem, uninstall and re-install ScanSnap Manager.(*2)
	Is the "ScanSnap Manager - Scan and Save Settings" window still displayed?	Close the "ScanSnap Manager - Scan and Save Settings" window, and scan the document.
Vertical lines appear in the scanned image.	Is the inside of the ADF dirty?	Clean the inside of the ADF following the instructions in Chapter "8 Daily Care" (page 229).
The scanned image shifts or is distorted.	Is the document loaded correctly?	Load the document correctly following the instruction in "3.3 Loading Documents" (page 49)

Symptom	Check This Item	Resolution
The image scanned is too light or too dark.	Is the "Brightness (Black and White scanning only)" setting on [Option] of the [Scanning] tab set to extremely Light or Dark?	Adjust "Brightness" at [Scanning] - [Option] in the "ScanSnap Manager - Scan and Save Settings" dialog box.
Lines on the document are blurred. (Example: Ruled lines on a table cannot be seen.)	Are you scanning in color mode, documents including handwritten or typed text, tables or frames with ruled lines?	The color mode is used for capturing colored images like photos in high quality. For other documents including textual content, select the checkbox for [Setting for text only document] at [Scanning] – [Option] in the "Scan and Save Settings" window. If it does not improve even after you have tried this method, change "Image quality" setting.
The scanning speed is very slow.	Does your PC meet the recommended system requirements?	Confirm the system requirements in "Before Installing the Supplied Programs for the ScanSnap" (page 6). Scanning speed will be slower whenever the recommended CPU and memory requirements are not met. If this is the case, at [Scanning] - [Option] in the "ScanSnap Manager - Scan and Save Settings" dialog box, clear the checkboxes of the following to increase the scanning speed. <ul style="list-style-type: none"> • Correct skewed character strings automatically • Allow automatic image rotation
	Is the USB 1.1 connected? Note: When using an USB1.1 interface, the data transfer rate may be slower due to large data sizes.	If your PC has an USB 2.0 port, connect the ScanSnap to this port. (If using a USB hub, it must also support USB 2.0 interfaces.) (*3)
Multi-feed errors (*4) occur frequently.	Is the Pad ASSY dirty?	Replace the pad by following the instructions in "8.3 Cleaning the Inside of the Scanner" (page 232).
	Is the Pad ASSY worn?	Replace the Pad ASSY by following the instructions in "9.2 Replacing the Pad ASSY" (page 240).
	Is the document stack thicker than 5 mm?	Reduce the number of sheets in the document stack to 5 mm thickness or less.

Symptom	Check This Item	Resolution
Paper is not fed (stops midway).	Is the Pick roller dirty?	Clean the Pick roller by following the instructions in "8.3 Cleaning the Inside of the Scanner" (page 232).
	Is the Pick roller worn out?	Replace the Pick roller by following the instructions in "9.3 Replacing the Pick Roller" (page 243).
	Are there any debris on the document feeding path?	Remove any debris from the document feeding path. (Refer to "7.1 Clearing Document Jams" (page 218).
	Do the loaded documents satisfy the conditions described in section "3.2 Paper Size of Documents to be Scanned" (page 46)? If not, they might not pass smoothly through the ADF.	Try the following: <ul style="list-style-type: none"> Slightly push through with your finger the first sheet of the documents at the start of scanning. Change the insertion direction of the document.
The scanner is not recognized even if ScanSnap Manager is installed.	Did you connect the scanner to your PC before installing ScanSnap Manager? Is the scanner registered as "Other device" in the "Device Manager"?	On the [Start] menu, select [Control panel] ⇒ [System] ⇒ [Hardware] ⇒ [Device Manager]. Delete the device name such as USB device (differs with the OS) under "Other Device" selection in the [Device Manager] and restart your PC.
The file size of a scanned black & white image is the same as that of a scanned color document image.	Is the B&W document scanned in the color mode?	Select "B&W" from the [Color mode] drop-down list on the [Scanning] tab in the "ScanSnap Manager - Scan and Save Settings" dialog box.
Images on the back of pages, which are printed-through, are overlaid on the scanned image when scanning a two-sided document. (This is called "noise" of the back side image.)	Is the "Setting for text only document" checkbox cleared in the "Read mode option" dialog box ([Option] on the [Scanning] tab of the "ScanSnap Manager - Scan and Save Settings" dialog box)?	Mark the "Setting for text only document" checkbox. (Available only in color mode) Marking it makes characters, lines, and contrasts sharper and clearer, and removes the noise of the back side image. Note that you can also use this mode for documents including photos and illustrations. Even if this mode is used, the contrasts and colors might be affected.

Symptom	Check This Item	Resolution
Scanned images are not displayed on the screen (when "Allow automatic blank page removal" is enabled).	When "Allow automatic blank page removal" is enabled, almost blank documents with only a few characters may be accidentally recognized as blank pages and removed from scanned image data.	Right-click ScanSnap Manager icon on the task bar, select [Setting] ⇨ [Scanning] tab and click the [Option] button. Then clear the "Allow automatic blank page removal" checkbox.
Scanned images are skewed.	Are the documents fed into the ADF with a skew of more than +/-5 degrees?	The "Correct skewed character strings automatically" function can correct skewed images up to +/-5 degrees. Load the document onto the scanner so that the document skew does not exceed this limit.
	Depending on the contents of document, the automatic image deskew may not work properly.	Refer to "Correct skewed character strings automatically." (page 81)
The orientation of scanned images is not displayed correctly (when "Allow automatic image rotation" is enabled).	Depending on the contents of document, the automatic image rotation may not work properly.	Refer to "Allow automatic image rotation." (page 82)
The scanned images cannot be read.	Have you scanned documents written in small letters?	When small letters are squashed, right click ScanSnap Manager icon on the task bar and select "Best" or "Excellent" in the [Scanning] tab and scan them again.
A part of the document does not appear in the scanned image.	Is the "Allow automatic blank page removal" enabled?	Clear the check box for "Allow automatic blank page removal" on [Option] of the [Scanning] tab of [Scan and Save Settings]
A profile cannot be created with currently configured settings.	Is the ScanSnap in Quick Menu Mode?	To create a profile with settings you want to use, uncheck [Use ScanSnap Quick Menu] and switch to Left-Click Menu Mode. See section "4.3 Saving Scanning Settings" (page 92).
The document is not fed properly or gets jammed.	<ol style="list-style-type: none"> Is the inside of the scanner dirty? Are you scanning one of the following? Thin paper Torn paper Folded paper 	<ol style="list-style-type: none"> Clean the dirty locations. Use the Carrier Sheet for each page if you have difficulties feeding the document.

Symptom	Check This Item	Resolution
When the document is scanned with the Carrier Sheet, a message, "Document size incorrect," appears.	Did you put multiple small-size materials (pictures/post cards) in Carrier Sheet for scanning?	Put only one small-size material (photo/post card) into the Carrier Sheet per scan.
When the document is scanned with the Carrier Sheet, a paper jam occurs frequently.	----	Feed about 50 sheets of PPC paper or recycled paper, and then scan the document by using Carrier Sheet. * You can use either unused or used PPC/recycled paper.
Black lines are produced on the scanned document.	Is the scanned documents written with a pencil?	It is recommended the Carrier Sheet be used for scanning. If you are not using Carrier Sheet for scanning such documents, clean rollers as often as possible. For information about how to clean rollers, refer to "8.3 Cleaning the Inside of the Scanner" (page 232).
The scanned image is chipped/Slant lines are produced on the scanned image/The output image is wider than the original.	With "Automatic detection" being selected in the "Paper size" drop-down list, was the document skewed during a scan?	Neatly align the edges of paper sheets with Side Guide. * If you are scanning documents of mixed paper sizes, marking the "Scan mixed paper size" checkbox (page 89), carefully load smaller documents so that they can be fed straight. If those documents cannot be fed straight, it is recommended to scan only documents of about the same size at a time.
The ScanSnap Quick Menu is hidden.	Is the ScanSnap in Left-Click Menu Mode?	Mark [Use ScanSnap Quick Menu] on the Right-Click Menu.
	Is ScanSnap Organizer, CardMinder, or Rack2 Library running?	If these applications are running and one of them is active, the ScanSnap interacts with the active application and scanned images are opened with it. Therefore, the ScanSnap Quick Menu is not displayed. To display the ScanSnap Quick Menu, exit these applications or deselect them. See section "4.6 About Automatic Interaction with Applications" (page 111).
The Left-Click Menu is hidden.	Is the ScanSnap in Quick Menu Mode? (Is the ScanSnap Quick Menu displayed after scanning?)	On the Right-Click Menu, uncheck [Use ScanSnap Quick Menu].
	Is the "ScanSnap Manager - Scan and Save Settings" dialog box open?	Close the "ScanSnap Manager - Scan and Save Settings" dialog box.

Symptom	Check This Item	Resolution
Applications cannot be selected in the "ScanSnap Manager - Scan and Save Settings" dialog box.	Is the ScanSnap in Quick Menu Mode? In Quick Menu Mode, you do not have to select an application beforehand. You can select an application in the ScanSnap Quick Menu after scanning.	If you want to select an application in advance, use Left-Click Menu Mode. To use Left-Click Menu Mode, uncheck [Use ScanSnap Quick Menu] on the Right-Click Menu.
Business cards cannot be scanned when the ScanSnap Quick Menu is used.	In Quick Menu Mode, business cards cannot be scanned.	Start CardMinder, and then press the [SCAN] button with CardMinder being active. Scanned business card images are displayed in CardMinder.
Files created by using the ScanSnap cannot be opened with a specified application. (For example, an error occurs when you try to open a PDF file with Adobe Acrobat.)	Is a folder specified as the Image saving folder on another personal computer or a hard disk on the network? For those who answered "Yes" to the above question: did an error occur while files scanned with the ScanSnap were being saved (because, for example, a LAN cable came off)? If such network-related errors occur, files may not be saved properly, and corrupted files may exist in the folder.	Verify the location of the Image saving folder, and then delete corrupted files, if any. After that, retry scanning.

Symptom	Check This Item	Resolution
When you try to execute "Convert to Word/Excel," an error message "Insufficient memory" or "Not enough memory" is sent and conversion cannot be executed.	Is the installed memory size larger than the recommended size?	Install additional memory if the installed memory size is smaller than the recommended size.
	Are other applications running? Other applications consume memory resources, so that enough memory cannot be allocated for execution of this function.	Exit other applications, and then retry scanning.
	Did you scan a large number of pages at one time? This function, "Convert to Word/Excel," requires large memory. If a large number of pages are scanned at one time, memory may become insufficient.	Refer to a "Hint" in section "5.5 Converting into Word / Excel / PowerPoint Files" (page 155) and change settings for the virtual memory.
	Did the above methods improve the situation?	If the above three methods did not improve the situation, install additional memory.

Note 1: In Windows XP, open the "Device Manager" window. Right-click on a computer name and perform "Scan for hardware changes."

Note 2:

- Make sure the personal computer and ScanSnap are powered on and connected properly.
- In the "Device Manager" window, check if the ScanSnap is recognized as unknown device.
If so, go to [Control Panel] → [System] and delete it.
- Close ScanSnap Manager
- Go to [Control Panel], select [Add or Remove Programs], and uninstall ScanSnap Manager and ScanSnap Organizer. Refer to "Appendix B - Uninstalling Supplied Programs (page 253)."
- Before restarting the personal computer, remove the following folders:



After uninstalling ScanSnap Manager, delete the following folders and files, and then restart your computer.

Be careful not to remove any other folders or files; this will affect your system environment.



Windows 2000, Windows XP:

Delete the **ScanSnap** folder under:

⇒ c:\Documents and Settings\\Application Data\PFU\

Delete the **Driver** folder under:

⇒ c:\Program Files\PFU\ScanSnap\

Windows Vista:

Delete the **ScanSnap** folder under:

⇒ c:\User\\AppData\Roaming\PFU\

Delete the **Driver** folder under:

⇒ c:\Program Files\PFU\ScanSnap\

After you have removed the folders, check if the files

- S510.inf
- S510.pnf

in the folder C:\Windows\Inf have been deleted. If the files still exist, remove these two files.



Note: The folder C:\Windows\Inf may be hidden. To check these two files and remove them, select [Explorer] ⇒ [Tools] ⇒ [Folder Options]. In the [View] tab, check if the checkbox of [Show hidden files and folders] under [Hidden files and folders] is marked. After this checkbox is marked and the setting is applied, the hidden C:\Windows\Inf folder becomes visible. Check if the S510.inf and S510.pnf files exist. If they do, remove them.

- After the folders and files are removed, restart your computer with ScanSnap disconnected.
- Reinstall ScanSnap Manager and restart.

Note 3: If you are not sure about the USB port to which the ScanSnap is connected (USB1.1 or USB2.0), check the information about the USB port following the procedure below.

First, right-click the ScanSnap Manager icon to display the Right-Click Menu.

Next, on the Right-Click Menu, select [Help] ⇒ [About ScanSnap Manager].

Finally, in the "ScanSnap Manager - Version Information" window, click the [Detail] button. In the "ScanSnap Manager - Scanner and driver information" window, see "USB type."

Note 4: "Multi-feed" error is an error that occurs when two or more sheets are fed into the scanner simultaneously.

* Useful information will be provided on the FAQ Corner. For further information, please visit our website at: <http://scansnap.fujitsu.com>

Chapter 8

Daily Care

This chapter describes how to clean the ScanSnap.



Fire/Electric Shock



Before you clean the scanner, turn off the scanner and disconnect the AC adapter from the power outlet.

8.1 Cleaning Materials	230
8.2 Cleaning the Scanner Exterior.....	231
8.3 Cleaning the Inside of the Scanner	232
8.4 Cleaning Carrier Sheet	235

8.1 Cleaning Materials

Cleaning Materials	Parts No.	Remarks
Cleaner F1 	PA03950-0352	1 bottle (100ml) (*1)
Lint-free dry cloth	Commercially available. (*2)	



- Never use paint thinner and other organic solvents.
- During the cleaning, prevent water or moisture from getting inside the scanner.
- Do not use aerosol sprays to clean the scanner. Aerosol sprays cause dirt and dust to enter the scanner, resulting in scanner failure and malfunction.
- It may take long before the cleaner vaporizes if a large quantity is used. When cleaning the scanner parts, dampen a cloth with modest quantities of the cleaner. In addition, wipe off the cleaner completely with a soft lint-free cloth to leave no residue on the surface of the cleaned parts.

Note 1: To purchase cleaning materials, contact a FUJITSU scanner dealer where you purchased the scanner.

Note 2: Any lint-free cloth can be used.

8.2 Cleaning the Scanner Exterior

Clean the scanner exterior and the stacker with a cloth moistened with a small amount of Cleaner F1 or any neutral detergent.



- Never use paint thinner and other organic solvents.
- During the cleaning, prevent water or moisture from getting inside the scanner.
- Do not use aerosol sprays to clean the scanner. Aerosol sprays cause dirt and dust to enter the scanner, resulting scanner failure and malfunction.
- It may take long before the cleaner vaporizes if a large quantity is used. When cleaning the scanner parts, dampen a cloth with modest quantities of the cleaner. In addition, wipe off the cleaner completely with a soft lint-free cloth to leave no residue on the surface of the cleaned parts.

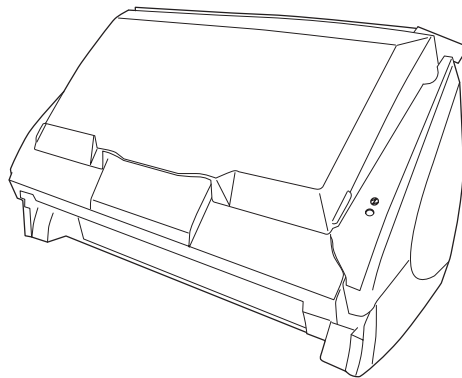

Cloth



Cleaner F1 or
neutral detergent



Paint thinner

8.3 Cleaning the Inside of the Scanner

Clean inside of the scanner with a cloth moistened with Cleaner F1.

In an alternating succession of scanning documents, the accumulated paper-powder and dust inside the scanner causes a scanning error.

As a guideline, clean the ADF every 1,000 scans. Note that this guideline varies according to the type of the documents you are scanning. For example, the ADF must be cleaned more frequently when scanning documents on that the toner has not been sufficiently fixed on.

Clean the ADF according to the following procedure and refer to the illustrations on the following page.



The glass surface inside the ADF becomes hot during the scanner operation.

Before you start to clean the inside of the scanner, disconnect the AC adapter from the outlet and wait at least 15 minutes to let the scanner cool down.



- Do not use water or neutral detergent to clean the inside of the scanner.
- Do not use aerosol sprays to clean the scanner. Aerosol sprays cause dirt and dust to enter the scanner, resulting scanner failure and malfunction.

1. Open the ADF while pulling the cover open lever.

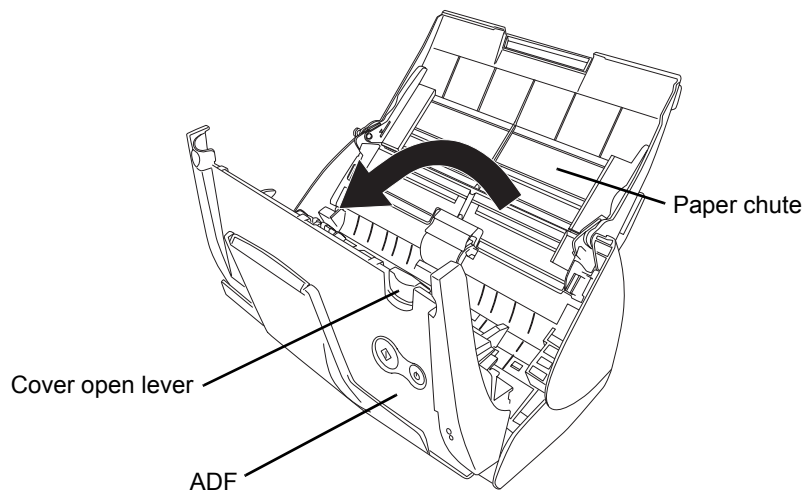

2. Clean the following locations with a cloth moistened with Cleaner F1.

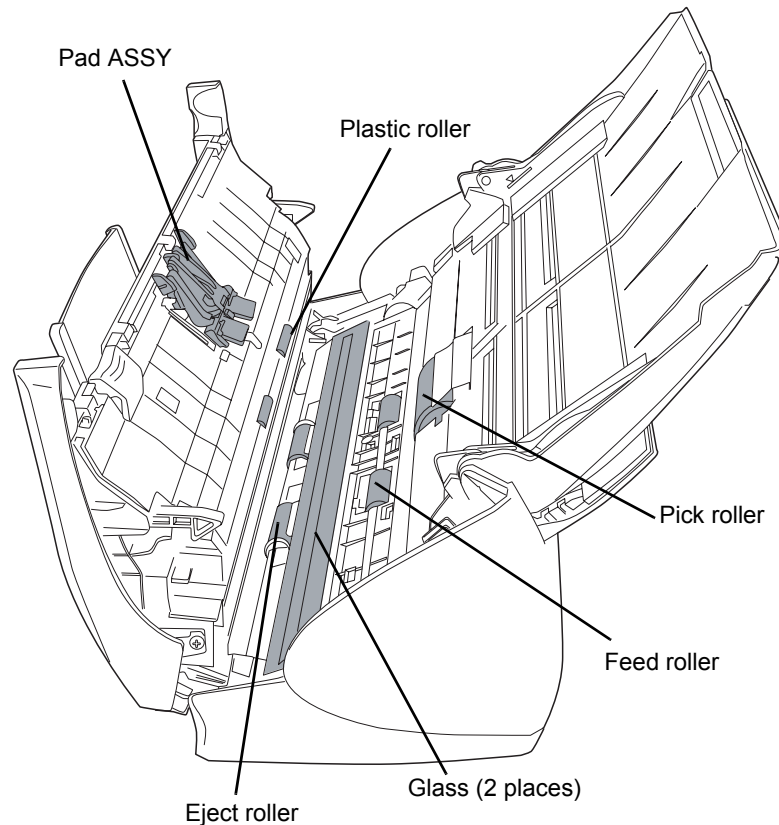

It may take long before the cleaner vaporizes if a large quantity is used. When cleaning the scanner parts, dampen a cloth with modest quantities of the cleaner. In addition, wipe off the cleaner completely with a soft lint-free cloth to leave no residue on the surface of the cleaned parts.

Turn off the scanner before cleaning the following locations.

- **Pad ASSY (1 piece)**
Wipe the Pad ASSY downwards. When cleaning the Pad ASSY, take care to prevent the cloth from catching on the metal parts.
- **ADF glass surfaces (2 pieces; located on the ADF and opposite side)**
Clean lightly.
- **Pick roller (1 piece)**
Clean lightly taking care not to scratch the surface of the roller. Take particular care in cleaning the Pick roller since black debris on the roller adversely affects the pickup performance.
- **Plastic rollers (4 pieces on the ADF)**
Clean them lightly while rotating the rollers with your finger. Be careful not to roughen the surface of the rollers. Take particular care in cleaning the plastic rollers since black debris on the rollers adversely affects the pickup performance.

Turn on the scanner before cleaning the following locations, and clean the following rollers while rotating them.

- **Feed rollers (2 pieces)**

Clean lightly taking care not to roughen the surface of the rollers. Take particular care in cleaning the feed rollers since black debris on the rollers adversely affect the pickup performance.

- **Eject rollers (2 pieces)**

Clean lightly taking care not to roughen the surface of the rollers.

Take particular care in cleaning the eject rollers since black debris on the rollers adversely affect the pickup performance.

To rotate the feed rollers and the eject rollers, press the [POWER] button while holding down the [SCAN] button.

As a guideline, six presses of the [POWER] button make the rollers to rotate one full turn.

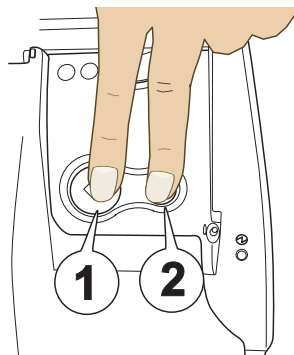

1. Hold down the [SCAN] button.

2. Press the [POWER] button while holding down the [SCAN] button.

⇒ The rollers rotate.



Connect the AC adapter and AC cable only when cleaning the feed rollers and eject rollers.

3. Close the ADF.

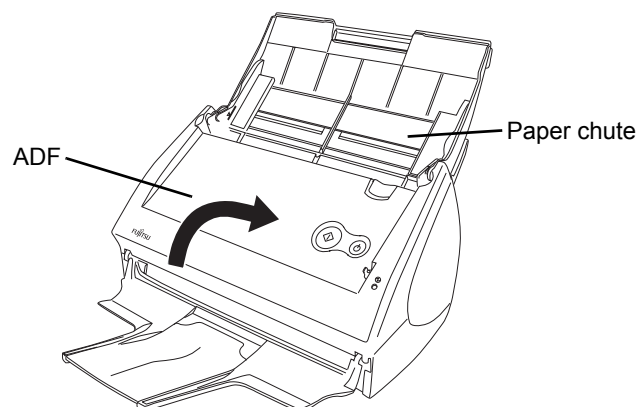

After closing the ADF, make sure that it is completely closed. Otherwise, paper jams or other feeding errors may occur.

8.4 Cleaning Carrier Sheet

If the Carrier Sheet is used extensively, dirt and dust may stick onto the surface or the interior and cause scanning errors. Clean it regularly to avoid errors.

Cleaning method

Use dry, soft cloth, or soft cloth slightly moistened with Cleaner F1 (sold separately) or a mild detergent to lightly clean off the dirt and dust from the surface and the interior of the Carrier Sheet.



- Never use paint thinner or other organic solvents.
- Do not rub the Carrier Sheet too hard. Otherwise, it may be scratched or be deformed.
- After cleaning the interior of the Carrier Sheet with Cleaner F1 or mild detergent, dry the Carrier Sheet completely before closing it.
- As a guideline, it is recommended to replace the Carrier Sheet with new one every 500 scans.
Refer to "9.4 Purchasing the Carrier Sheet" (page 250) for details on the purchase of a Carrier Sheet.



Chapter 9



Replacing Consumables and Carrier Sheet

This chapter describes how to replace consumables.



Fire/Electric Shock



Before you replace the consumables, turn off the scanner and disconnect the AC adapter from the power outlet.

9.1 Replacing Consumables	238
--	------------

9.2 Replacing the Pad ASSY	240
---	------------

9.3 Replacing the Pick Roller	243
--	------------

9.4 Purchasing the Carrier Sheet	250
---	------------

9.1 Replacing Consumables

This section describes how to replace consumables.

■ Part Nos. and Replacement Cycle of Consumables

The following tables list the part numbers of consumables and rough guidelines for replacing these parts.

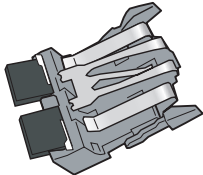
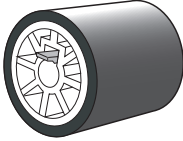
No.	Description	P/N	Standard Replacement Cycle
1	Pad ASSY 	PA03360-0002	50,000 sheets or one year
2	Pick roller 	PA03360-0001	100,000 sheets or one year

These replacement cycles are rough guidelines for the case of using A4/Letter wood-free paper 64 g/m² (17 lb). So it may differ according to the paper being used.

Use only the consumables specified by PFU LIMITED; do not use consumables made by other manufacturers.



By the following procedure, you can create a rough guideline for replacing consumables and for estimating how many sheets have been already scanned.

1. Right-click the ScanSnap Manager icon **S** on the task bar.
2. Click [Check consumable supplies] at the menu.

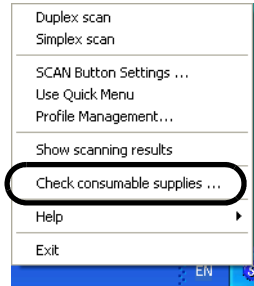

⇒ The window ("Check consumable status" screen) is displayed. This window indicates how many times consumables have been used.

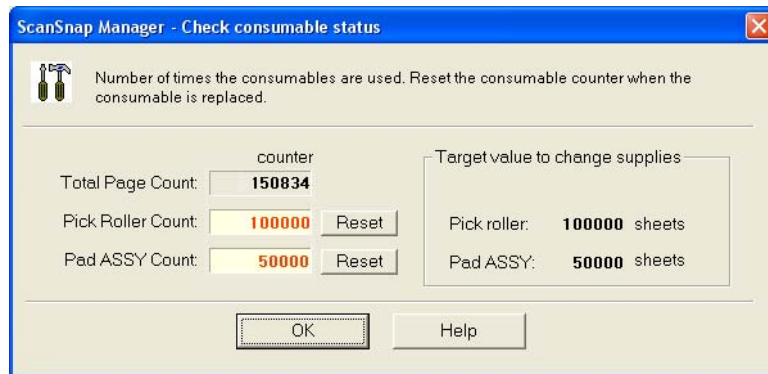

Replace consumables referring to "Target value to change supplies" as a rough guideline.

For details about purchasing consumables, visit the following website or contact the Fujitsu scanner dealer where you purchased your scanner.

[Website] <http://scansnap.fujitsu.com/>

9.2 Replacing the Pad ASSY

Replace the Pad ASSY following the procedure below.



1. Remove the documents on the paper chute.
2. Open the ADF while pulling the cover open lever.

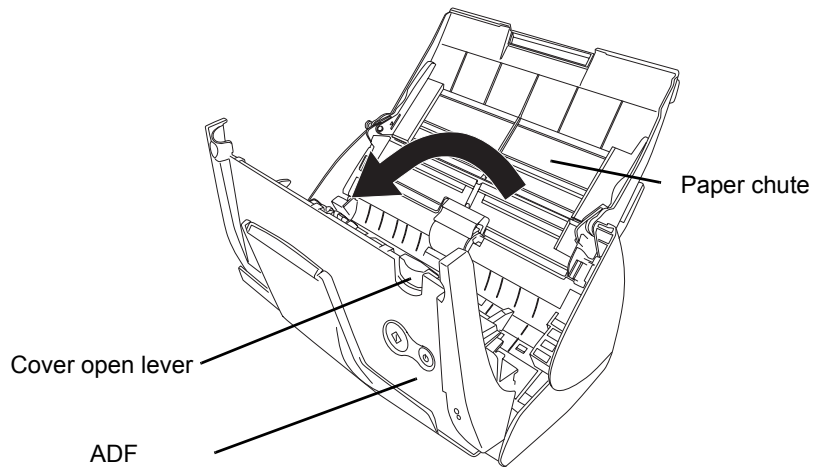

3. Remove the Pad ASSY.

Pull out the Pad ASSY in the direction of the arrow while pinching both ends of the Pad ASSY.

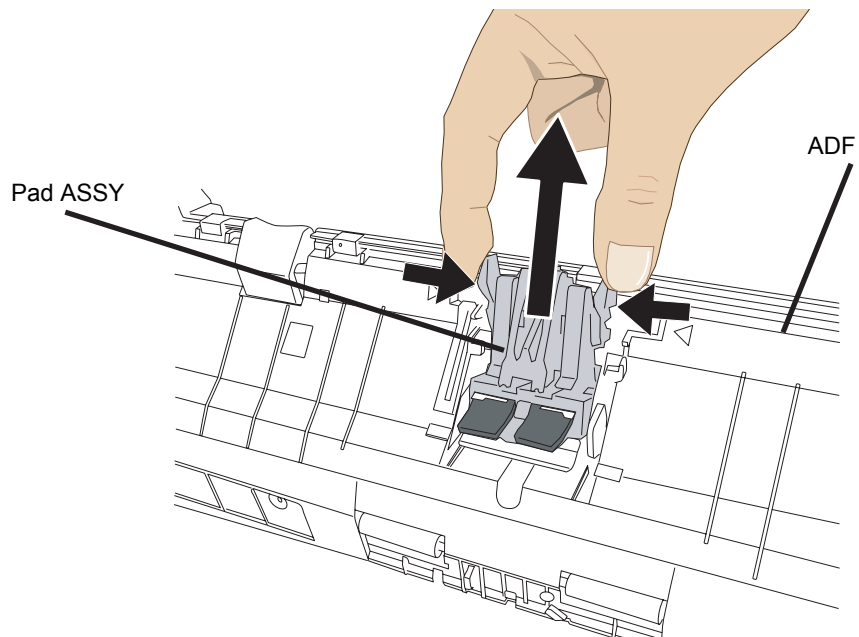

6. Turn on the scanner.
7. Right-click the ScanSnap Manager icon **S** on the task bar, and select [Check consumable supplies] from the menu.

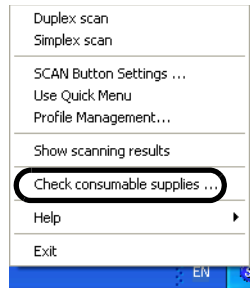

⇒ This displays the "Check consumable status" window.

8. In the "Check consumable status" window, click the [Reset] button of Pad ASSY Count.

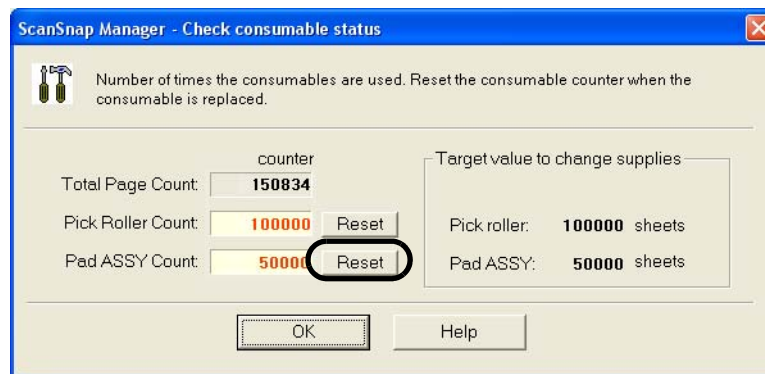

⇒ The counter is reset to "0."

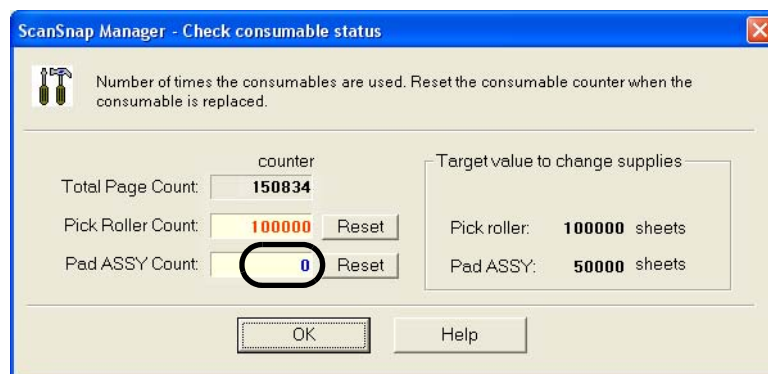

9.3 Replacing the Pick Roller

Replace the Pick roller following the procedure below.

1. Remove the documents on the paper chute.
2. Open the ADF while pulling the cover open lever.

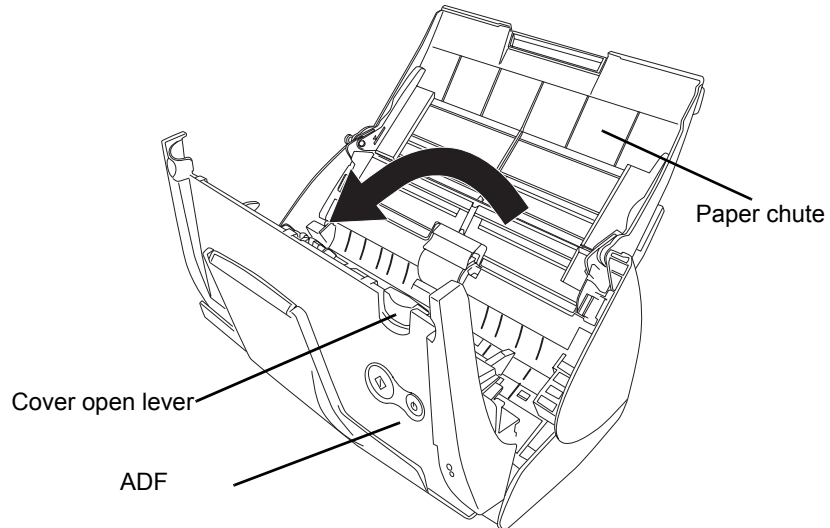

3. Adjust the Side guide to the "A5" size.

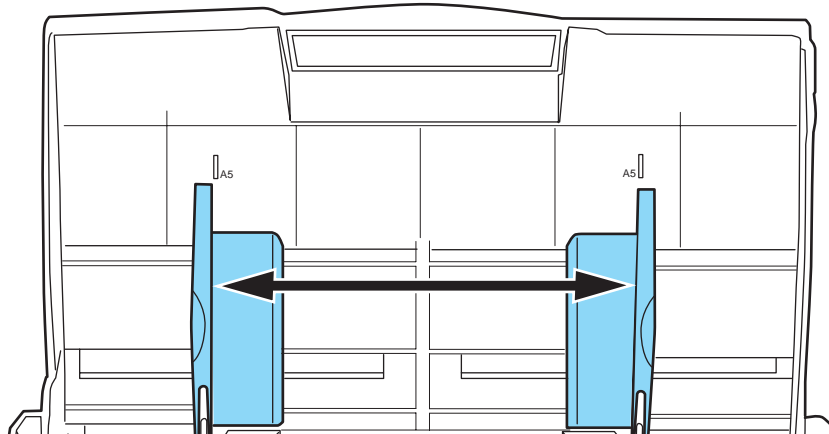

4. Remove the sheet guide.

Hold the pick-up tabs on the sheet guide between the thumb and index finger, and then pull up the sheet guide to remove.

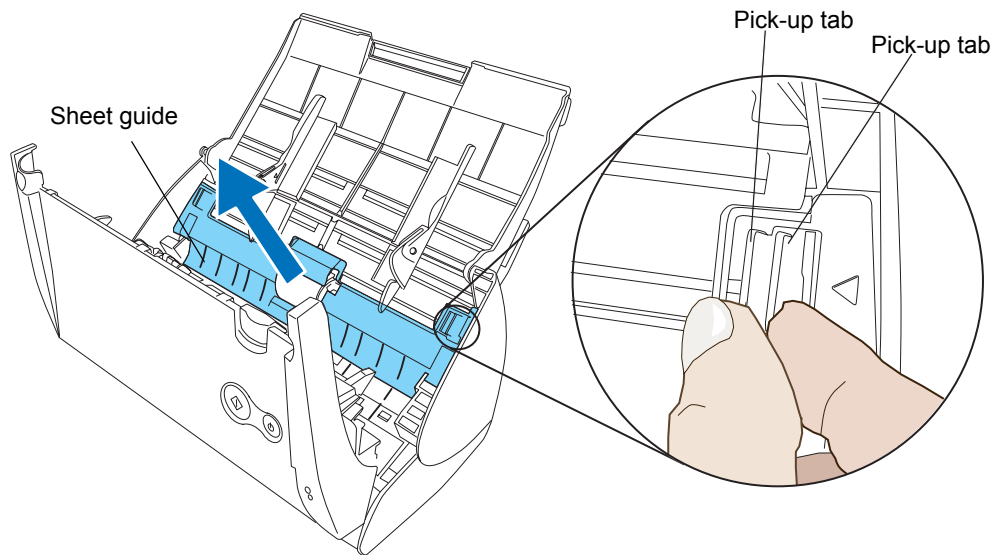

5. Rotate the pick roller bushing (left).

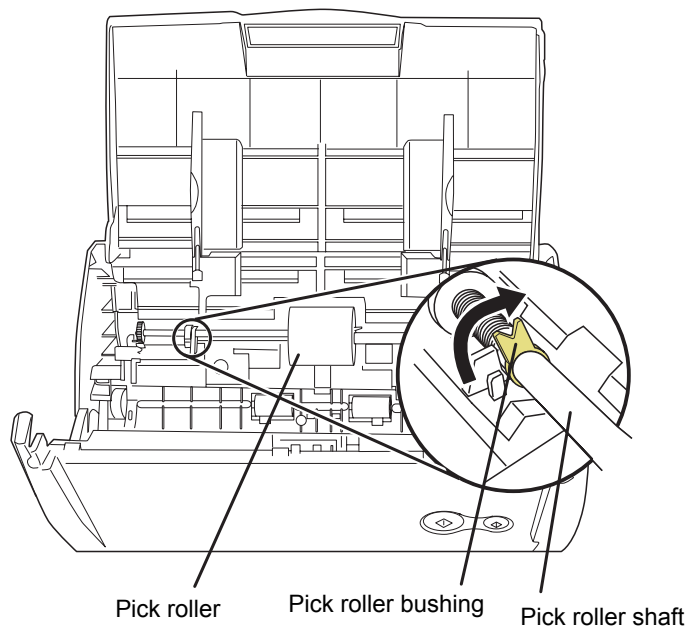

6. Remove the pick roller with its shaft.

Slightly pull up the left part of the Pick roller shaft (about 5mm), move it towards the left side, and then raise it to remove from the scanner.

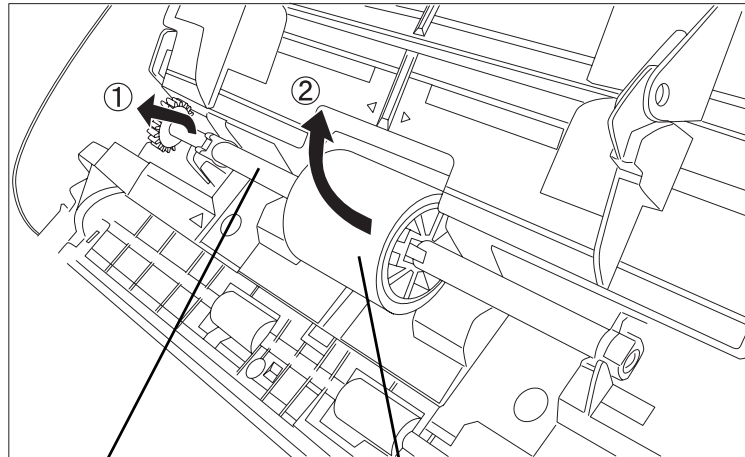

Pick roller shaft

Pick roller



If the around the pick roller is dirty by paper-powder, it may cause a scanning error. Remove the dirt using a dry cloth moistened with Cleaner F1.

* Don't use water, mild detergent or air-spray.

7. Remove the pick roller from its shaft.

Pull out the shaft from the pick roller while lifting up its tab.

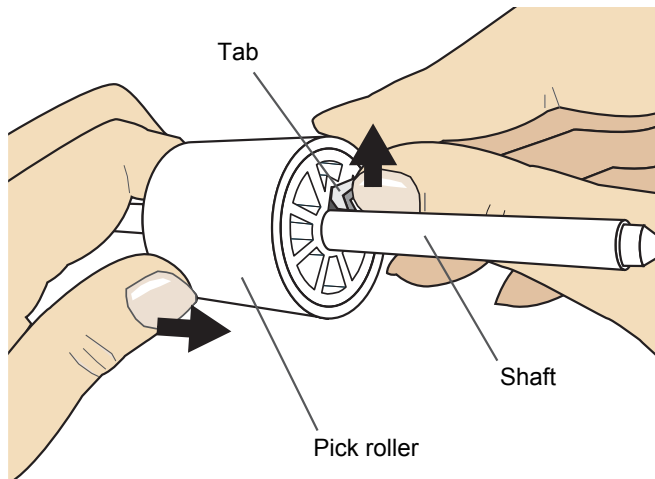



If you push up the pick roller tab using your fingernail, your fingernail may be hurt or get chipped. If you cannot push it up successfully with your fingernail, use a paper clip to push up the pick roller tab.

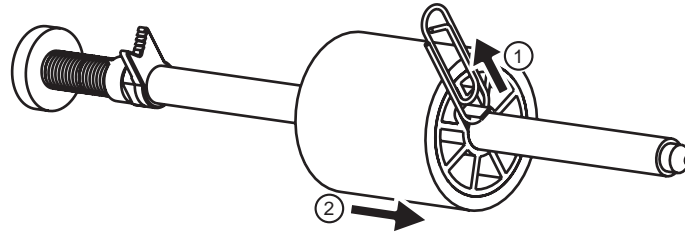

8. Attach the new pick roller to the shaft.

Insert the shaft aligning the protrusion with the slot on the new pick roller.

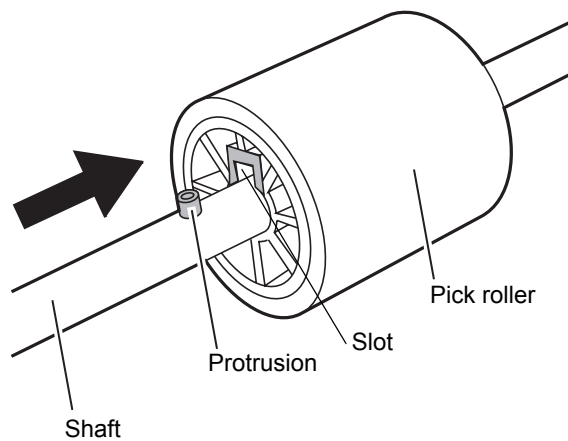

9. Install the pick roller with its shaft to the scanner.

Insert the right end of the shaft to the roller bushing (right), and set the shaft to the slot while lowering it.

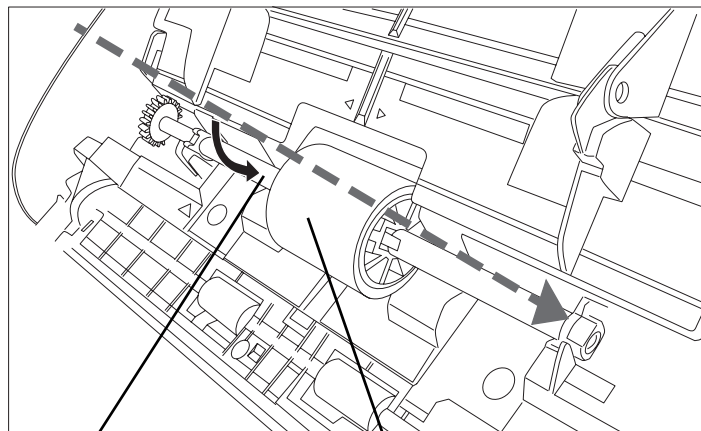

10. Rotate the roller bushing (left) by rotating it in the direction of the arrow.

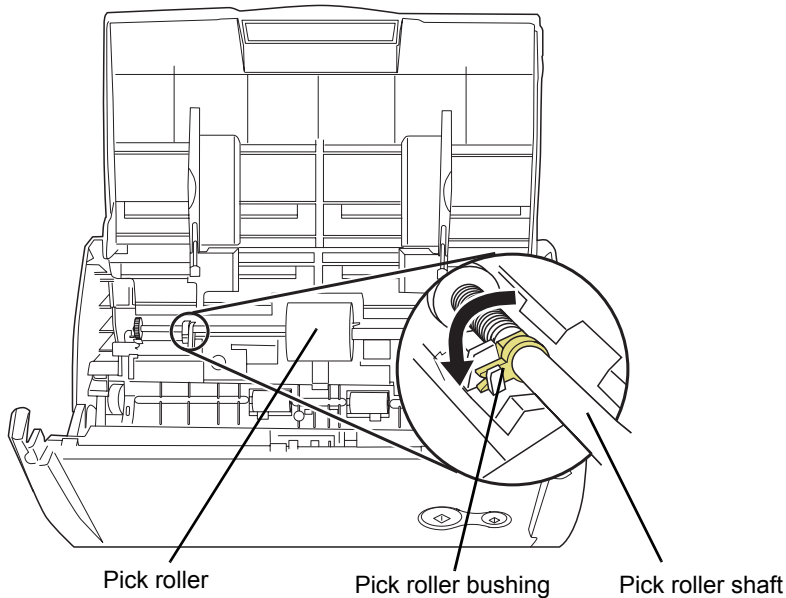

ATTENTION Make sure that the Pick roller is completely attached. Otherwise, document jams or other feeding errors may occur.

11. Attach the sheet guide to the scanner.
Hold the pickup tabs on the sheet guide between the thumb and index finger, and then attach the sheet guide to the scanner.

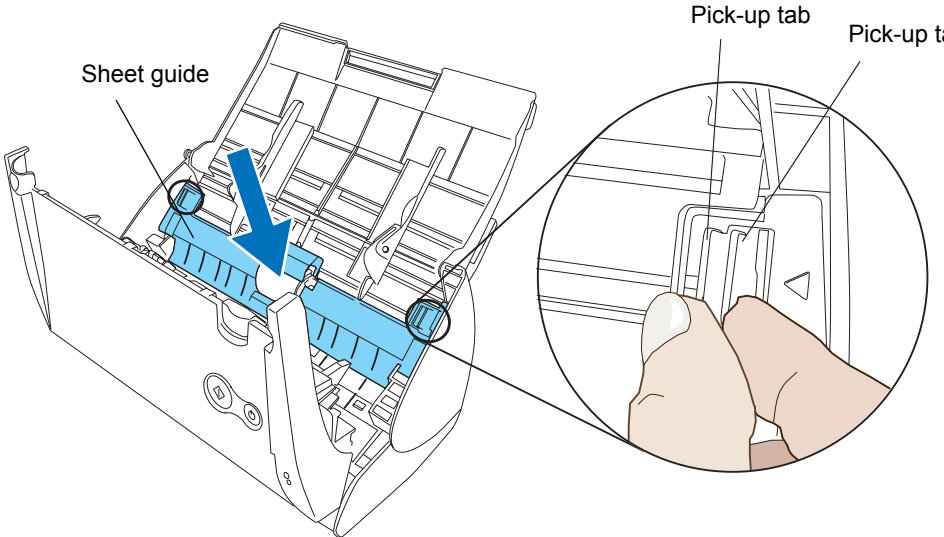

9

⇒ The sheet guide makes a clicking sound when the knobs fix into position.



Make sure that the sheet guide is completely attached. Otherwise, document jams or other feeding errors may occur.



12. Close the ADF.

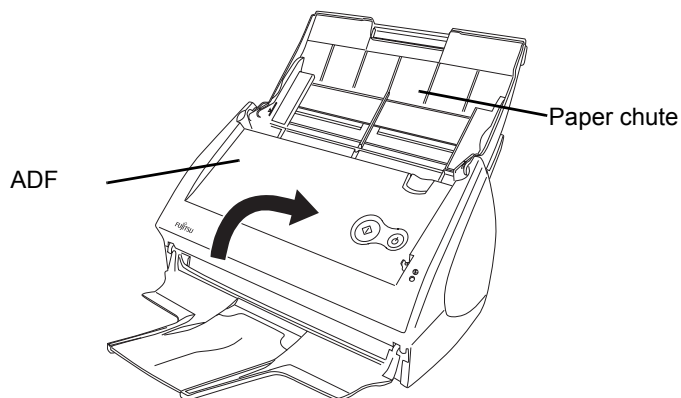

⇒ You should hear the ADF click when it returns to its original position.

13. Turn on the scanner.

14. Right-click the ScanSnap Manager icon **S** in the task bar, and select [Check consumable supplies] from the menu.

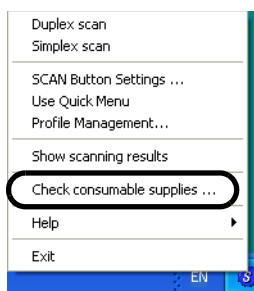

⇒ This displays the "Check consumable status" window.

15. In the "Check consumable status" window, click the [Reset] button of the consumable you replaced.

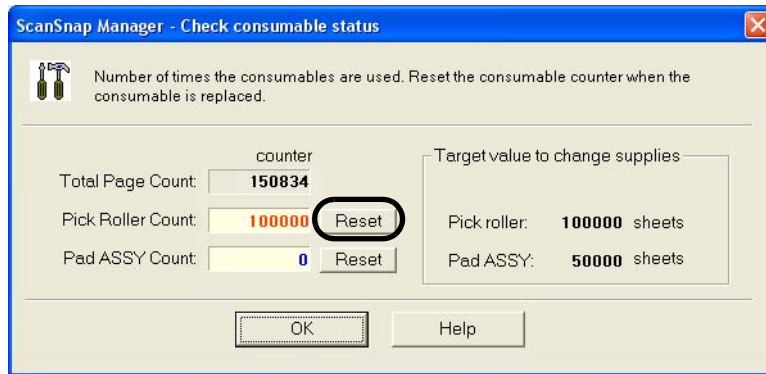

⇒ The counter is reset to "0."

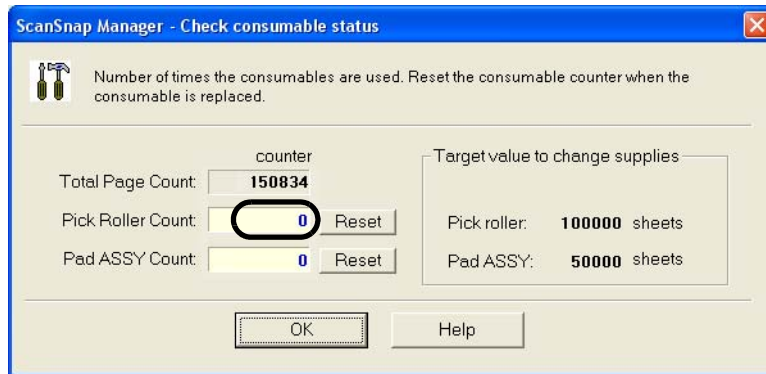

9.4 Purchasing the Carrier Sheet

If the “Carrier Sheet” bundled in this product cannot be used for scanning due to damage or wear-and-tear, you can purchase just the Carrier Sheet separately.

As a guideline, it is recommended to replace the Carrier Sheet every 500 scans. However, the number of times of use differs according to usage. If scratches and dirt are conspicuous, replace the Carrier Sheet accordingly.

The description of the Carrier Sheet and its part number are as follows:

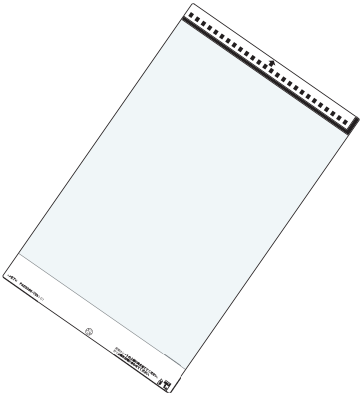
Description	Qty	P/N
<p data-bbox="373 730 671 763">ScanSnap Carrier Sheet</p> 	5 pcs	FI-511ES-WW

Appendix A

Updating ScanSnap Manager

In an effort to improve the usability and functionality of ScanSnap Manager, program updates are carried out timely.

ScanSnap Manager can automatically detect whether the latest program (Update Pack) is available and update the program.

 **HINT** Update Packs are made available without notice. We recommend that you update your program regularly.

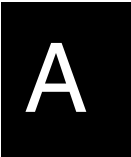

When updating ScanSnap Manager, follow the instructions below.

 **ATTENTION**

- When updating, it is essential that Internet Explorer is installed in a system which can access the Internet.
- For Windows XP or Windows 2000, you must log on as an administrator.



1. Right-click the ScanSnap Manager icon , and then select [Help] - [Online Update].

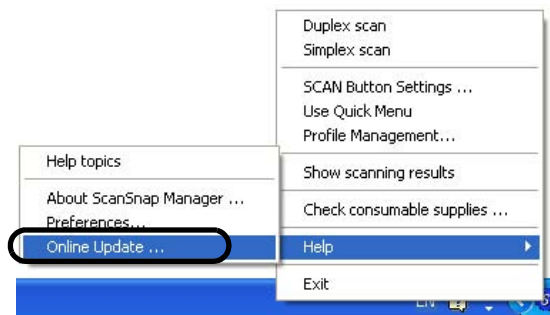

⇒ A confirmation message appears for the update.

2. Click the [Yes] button.



⇒ If the latest Update program is available, a message appears for the confirmation of the download and installation of the program.



If the latest update is already installed, an informational message appears.

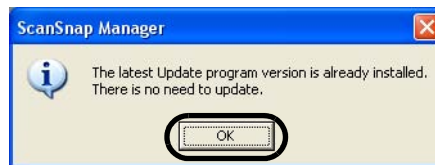

Click the [OK] button to close the message.



3. Click the [Yes] button.

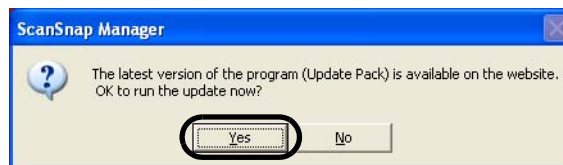

⇒ The program is downloaded, and a confirmation message to start installation appears.

4. Click the [Install] button.



When you click the [Information] button, Internet Explorer opens and information about the latest update for ScanSnap Manager appears.



⇒ Installation starts, and the "Welcome to InstallShield Wizard for ScanSnap Manager" window appears.

Follow the instructions on the screen to install.

Appendix B



Uninstalling ScanSnap

"Uninstallation" removes the ScanSnap program files that were copied during the installation from the hard disk and restores the system environment to its original state.

This chapter describes how to uninstall ScanSnap.

■ Uninstalling Supplied Programs

Follow the procedure below to uninstall programs (ScanSnap Manager, CardMinder, and ScanSnap Organizer) supplied with ScanSnap.

1. Start up your PC.

When using Windows 2000 or Windows XP, log in as a user with "Administrator" privileges (computer administrator privileges in the case of Microsoft Windows XP Home Edition operation system).

2. Exit all currently running programs.

3. Select [Control Panel] ⇒ [Add or Remove Programs] from the [Start] menu.

⇒ The "Add or Remove Programs" screen appears with a list of the currently installed applications.

4. Select the application to uninstall.

(1) When uninstalling ScanSnap Manager

Select "ScanSnap Manager."

(2) When uninstalling CardMinder

Select "CardMinder V3.0."

(3) When uninstalling ScanSnap Organizer

Select "ScanSnap Organizer."

5. Click the [Change/Remove] button.

⇒ The "Confirm Uninstall" window appears.

6. Click the [OK] button.

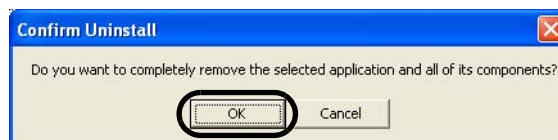

⇒ This executes the uninstallation.

7. After the uninstallation is completed, select "Yes, I want to restart my computer now!" and click the [Finish] button.



Screen displays may vary slightly depending on the operating system (OS) of your personal computer. Follow the on-screen instructions of the OS.

Example: When the OS is Windows 2000

- "Add or Remove Programs" ⇒ "Add/Remove Applications"
- [Change/Remove] button ⇒ [Add/Remove] button



Appendix C

Quick Menu Mode / Left-Click Menu Mode

Setting items you can configure in the "ScanSnap Manager - Scan and Save Settings" dialog box are different depending on which mode the ScanSnap is in.

Switch between Quick Menu Mode (page 35) and Left-Click Menu Mode (page 40) as necessary.

(OK: Selectable / NA: Not selectable)

Setting Items in Quick Menu Mode and Left-Click Menu Mode

Setting Items		Quick Menu Mode	Left-Click Menu Mode	Page
Profile	Select a profile	NA	OK	page 69
	Add Profile	NA	OK	page 70
	Edit Profile	NA	OK	page 70
Application	Application	NA *1	OK	page 71
	No application is started (Save To File)	NA	OK	
	ScanSnap Organizer	NA	OK	
	Adobe® Acrobat®	NA	OK	
	Adobe® Acrobat® Reader™ or Adobe® Reader®	NA	OK	
	CardMinder	NA	OK	
	ABBYY Scan2Excel	NA	OK	
	ABBYY Scan2Word	NA	OK	
	ABBYY Scan2PowerPoint	NA	OK	
	Save in the specified folder	NA	OK	
	Send by e-mail	NA	OK	
Scan2Print	NA	OK		
Save	Image saving folder	OK	OK	page 74
	File name format	OK	OK	page 74
	Rename after scanning	NA	OK	page 76
Scanning	Image quality	OK	OK	page 78
	Normal (Fastest)	OK	OK	
	Better (scanned high quality)	OK	OK	
	Best (scanned at higher quality)	OK	OK	
	Excellent (scanned at highest quality)	OK	OK	



Setting Items in Quick Menu Mode and Left-Click Menu Mode

Setting Items		Quick Menu Mode	Left-Click Menu Mode	Page
Scanning	Color mode	OK	OK	page 79
	Auto Color Detection	OK	OK	
	Color	OK	OK	
	B&W	OK	OK	
	Color high compression	NA	OK	
	Scanning side	OK	OK	page 80
	Continue scanning after current scan is finished	OK	OK	
	Option	OK	OK	page 80
	Brightness (Black and White scanning only)	OK	OK	
	Setting for text only document	OK	OK	
	Allow automatic blank page removal	OK	OK	
	Correct skewed character strings automatically	OK	OK	
	Allow automatic image rotation	OK	OK	
	Set the document with its face up	OK	OK	
File option	File format	NA	OK	page 83
	PDF (*.pdf)	OK	OK	
	JPEG (*.jpg)	NA	OK	
	Searchable PDF (OCRs during scan)	NA	OK	page 84
	All pages	NA	OK	
	First page	NA	OK	
	Option	OK	OK	page 85
	Multipage PDF (whole batch in one PDF)	OK	OK	
	Generate one PDF file per xx pages	OK	OK	
	Set a password for PDF file	NA	OK	

Setting Items in Quick Menu Mode and Left-Click Menu Mode

Setting Items		Quick Menu Mode	Left-Click Menu Mode	Page
Paper size	Paper size	OK	OK	page 87
	Automatic detection	OK	OK	
	A4 (210 mm x 297 mm)	OK	OK	
	A5 (148 mm x 210 mm)	OK	OK	
	A6 (105 mm x 148 mm)	OK	OK	
	B5 (182 mm x 257 mm)	OK	OK	
	B6 (128 mm x 182 mm)	OK	OK	
	Post card (100 mm x 148 mm)	OK	OK	
	Business card (90 mm x 55 mm, 55 mm x 90 mm)	OK	OK	
	Letter (8.5 in. x 11 in., 216 mm x 279.4 mm)	OK	OK	
	Legal (8.5 in. x 14 in., 216 mm x 355.6 mm)	OK	OK	
	Custom	OK	OK	page 88
Scan mixed paper size	OK	OK	page 89	
Carrier Sheet Settings	OK	OK		
Compression	Compression rate	OK	OK	page 90
	1	OK	OK	
	2	OK	OK	
	3	OK	OK	
	4	OK	OK	
	5	OK	OK	

Note 1: In Quick Menu Mode, you can start associated applications by selecting actions in the ScanSnap Quick Menu. Therefore, the [Application] tab is hidden.



Appendix D



Installation Specifications

The following table summarizes the installation specifications of this scanner.

Item		Specifications		
Dimensions (Note)		Width	Depth	Height
	Minimum	284 mm 11.18 in.	157 mm 6.18 in.	158 mm 6.22 in.
	Maximum	284 mm 11.18 in.	436.7 mm 17.19 in.	299.5 mm 11.79 in.
Weight		2.7 kg (approximately 5.95 lb)		
Input power supply	Voltage	100 - 240 V (varies regionally)		
	Number of phases	Single-phase		
	Frequency	50/60 Hz		
Power consumption	During operation	28 W or less		
	During standby	6 W or less		
Temperature/ Humidity Allowable Ranges	Scanner state	During operation	During standby	During storage/ transportation
	Temperature	5 to 35 (°C) 41 to 95 (°F)	-20 to 60(°C) -4 to 140 (°F)	-20 to 60(°C) -4 to 140 (°F)
	Humidity (%)	20-80	8-95	8-95



Note) Dimensions

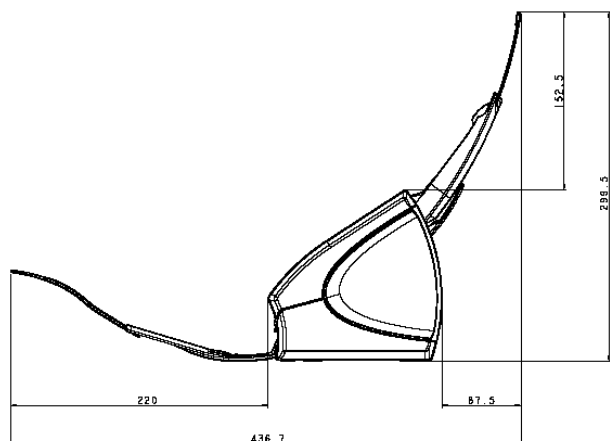
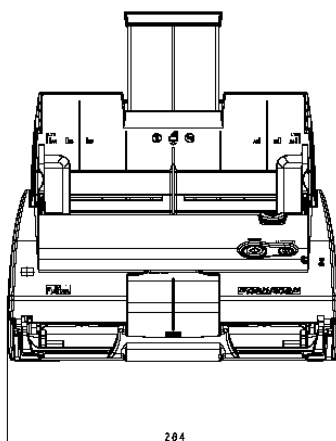

Repairs



Contact the store where you purchased your ScanSnap or an authorized service provider for performing repairs on this product.

- The user must not perform any repairs on the scanner.

Index

A

ABBYY FineReader for ScanSnap 164
ABBYY Scan2Excel 160, 162
ABBYY Scan2PowerPoint 160, 162
ABBYY Scan2Word 160, 162
About the size of image data 91
AC adapter connector 4
Actions in the Action List 116
Add custom size button 109
Add or Remove button 72
ADF 3
Allow automatic blank page removal 81
Allow automatic image rotation 82
Application 71
Application tab 71
Applications Settings button 72
Auto Color Detection 79
Automatic detection 87
Automatic Interaction with Applications 111

B

B&W scanning 79
Before Installing the Supplied Programs .. 6
Best quality 78
Better quality 78
Brightness 81
Business Cards 202

C

CardMinder 203, 204

Carrier Sheet 52, 250
Carrier Sheet Settings 106
Carrier Sheet Settings button 89
Changing Scanning Settings 67
Cleaner F1 230
Cleaning Carrier Sheet 235
Cleaning cycle 232
Cleaning Materials 230
Cleaning the ADF 232
Clearing Document Jams 218
Color high compression 79
Color mode 79
Color scanning 79
Compression rate 90
Compression tab 90
Connecting ScanSnap 21
Connecting the Power Cable 21
Connecting the USB Cable 23
Consumables 238
Continue scanning 80
Copy 145
Correct skewed character strings
automatically 81, 180
Correcting skewed documents 179
Correcting the orientation of
scanned images 181
Cover open lever 3
Create facing pages in one image 107
Create front and back images
separately 107
Custom button 88

Customized paper size 87

D

DAILY CARE 229

Deskew 81

E

Excel format 155

Excellent quality 78

F

factory default settings 170

File format 83

File option tab 83

Filename format button 75

fixed password 86

Flow of Operations 30

I

Image quality 78

image rotation 82

Image saving folder 74

Installation Specifications 259

Installing Adobe Acrobat 8, 10

Installing CardMinder 14

Installing PDF Thumbnail View 14

Installing ScanSnap Manager 14

L

Left-Click Menu 66

Loading Documents 49

Loading Documents with the
Carrier Sheet 52

M

Merging scanned images 189

N

Normal quality 78

O

Online Update 251

Operation Button 4

Option button 80, 85

Output Image Size 108

P

Package 2

Pad ASSY 238

Paper chute 3

Paper size 46, 87

Paper size tab 87

Paper type 46

password 85

Performing text recognition when
scanning documents 195

Pick roller 238

POWER button 4

Power indicator 4

PowerPoint format 155

Preview window 120, 125

preview window 134, 141

Printing 145

Profile 92

 Adding 93

 Changing Settings 97

 Renaming 99

 Scanning with an Added Profile 96

Purchasing the Carrier Sheet 250

Q	
Quick Menu	37

R	
Rear View	4
Recognize Text	200
Rename file after scanning	76
Repairs	261
Replacing the Pad ASSY	240
Replacing the Pick Roller	243
Right-Click Menu	65
Rotating pages within a PDF file	197

S	
Save tab	74
Saving Data in a Specified Folder	117
Saving Scan Settings	92
Saving scanned images in multiple files	187
SCAN button	4
Scan mixed paper size	89
Scan2E-mail	131
Scan2E-mail.	138
Scan2Folder	119, 124
Scan2Print	147, 151
Scanning color document in black and white	174
Scanning color documents in high compression mode	175
Scanning documents in Left-Click Menu Mode	40
Scanning documents in Quick Menu Mode	35
Scanning documents of different widths or sizes at a time	183
Scanning only one side of a document	172

Scanning side	80
Scanning tab	78
ScanSnap Carrier Sheet	52, 250
ScanSnap Manager - Scan and Save Settings	67, 68
ScanSnap Manager icon	64
ScanSnap Organizer	208
ScanSnap Quick Menu	37, 103
ScanSnap Setup	15
Security cable slot	4
Select a profile	69
Send by e-mail	129
Sending Files by E-Mail	129
Set the documents with its face up	82
Setting for text only document	81
Setting Items	255
Setting Passwords for Scanned Documents	192
Setup	15
Shared folder	117
Side guide	3, 51
Skipping blank pages	177
Stacker	3, 51

T	
Troubleshooting	217
Troubleshooting Checklist	220
Turning the ScanSnap On/Off	44

U	
Uninstalling ScanSnap	253
Uninstalling Supplied Programs	254
Update	251
USB connector	4
Use a fixed password	86

W

Weight	46
Word format	155

ScanSnap S510 Operator's Guide

P3PC-1792-01ENZ0

Date of issue: February, 2007

Issuance responsibility: PFU LIMITED

- The contents of this manual are subject to change without notice.
- PFU LIMITED assumes no liability for incidental or consequential damages arising from the use of this manual, and any claims by a third party.
- Copying of the contents of this manual in whole or in part and copying of the scanner applications are prohibited under the copyright law.