

**EMC Technologies Report Number: M070644\_Cert\_AR5BxB6\_DTS\_BT**

**APPENDIX I**  
**FUJITSU USER MANUAL**

# User's Guide

## Learn how to use your Fujitsu LifeBook U810\* notebook

\*Depending upon region, U810 may be identified as U1010. U810 and U1010 are identical models.

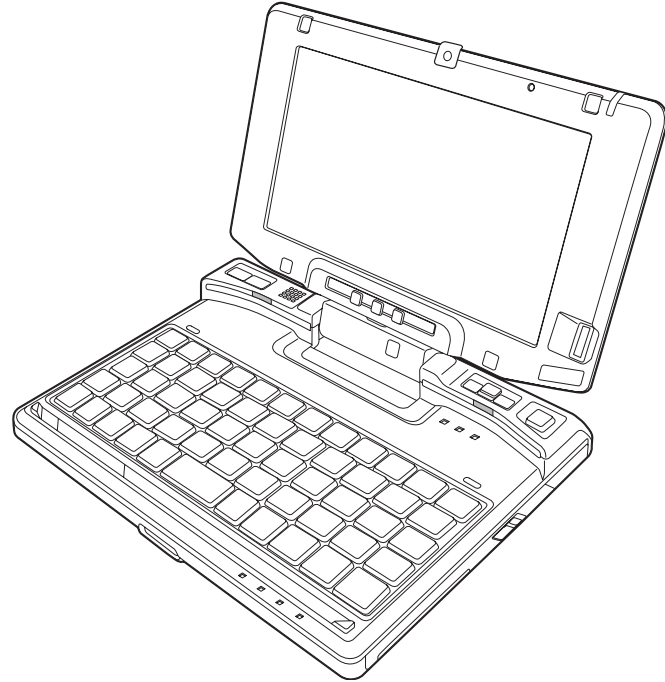

  
**FUJITSU**

THE POSSIBILITIES ARE INFINITE



# Copyright and Trademark Information



Fujitsu Computer Systems Corporation has made every effort to ensure the accuracy and completeness of this document; however, as ongoing development efforts are continually improving the capabilities of our products, we cannot guarantee the accuracy of the contents of this document. We disclaim liability for errors, omissions, or future changes.

Fujitsu, the Fujitsu logo, and LifeBook are registered trademarks of Fujitsu Limited.

Intel is a trademark or registered trademark of Intel Corporation or its subsidiaries in the United States and other countries.

Microsoft, Windows, Windows Vista, and OneNote are either registered trademarks or trademarks of Microsoft Corporation in the United States and/or other countries.

ArcSoft WebCam Companion is a trademark of ArcSoft, Inc.

Bluetooth is a trademark of Bluetooth SIG, Inc., USA.

OmniPass is a trademark of Softex, Inc.

Realtek is a trademark of Realtek Semiconductor Corporation.

Atheros and Super AG are registered trademarks of Atheros Communications.

Adobe, Acrobat, and Acrobat Reader are either a registered trademarks or trademarks of Adobe Systems Incorporated in the United States and/or other countries.

All other trademarks mentioned herein are the property of their respective owners.

## WARNING



HANDLING THE CORD ON THIS PRODUCT WILL EXPOSE YOU TO LEAD, A CHEMICAL KNOWN TO THE STATE OF CALIFORNIA TO CAUSE BIRTH DEFECTS OR OTHER REPRODUCTIVE HARM.

WASH HANDS AFTER HANDLING.

© Copyright 2007 Fujitsu Computer Systems Corporation. All rights reserved.

No part of this publication may be copied, reproduced, or translated, without prior written consent of Fujitsu. No part of this publication may be stored or transmitted in any electronic form without the written consent of Fujitsu. B5FJ-4211-01EN-00



## DECLARATION OF CONFORMITY

according to FCC Part 15

Responsible Party Name:	Fujitsu Computer Systems Corporation
Address:	1250 E. Arques Avenue, M/S 122 Sunnyvale, CA 94085
Telephone:	(408) 746-6000
Declares that product:	Base Model Configuration: LifeBook U810 / LifeBook U1010* notebook

Complies with Part 15 of the FCC Rules.

This device complies with Part 15 of the FCC rules. Operations are subject to the following two conditions: (1) This device may not cause harmful interference, (2) This device must accept any interference received, including interference that may cause undesired operation.

\*In certain regions, LifeBook U810 may be identified as LifeBook U1010. LifeBook U810 and LifeBook U1010 are identical models in every way.

## IMPORTANT SAFETY INSTRUCTIONS

This unit requires an AC adapter to operate. Use only UL Listed I.T.E. Class II Adapters with an output rating of 16 VDC, with a current of 2.5 A (40 W).

**AC adapter output polarity:**



When using your notebook equipment, basic safety precautions should always be followed to reduce the risk of fire, electric shock and injury to persons, including the following:

- Do not use this product near water for example, near a bathtub, washbowl, kitchen sink or laundry tub, in a wet basement or near a swimming pool.
- Avoid using a modem during an electrical storm. There may be a remote risk of electric shock from lightning.
- Do not use a modem to report a gas leak in the vicinity of the leak.
- Use only the power cord and batteries indicated in this manual. Do not dispose of batteries in a fire. They may explode. Check with local codes for possible special disposal instructions.
- To reduce the risk of fire, use only No. 26 AWG or larger UL Listed or CSA Certified Telecommunication Line Cord.
- For TV tuner use: To protect from overvoltages and transients on the Cable Distribution System, make sure that the outer shield of the coaxial cable is connected to earth (grounded) at the building premise as close to the point of cable entrance as practicable, as required per NEC Article 820.93, ANSI/NFPA 70: 2005. If you have questions about your CATV installation, contact your service provider.

### SAVE THESE INSTRUCTIONS

#### For Authorized Repair Technicians Only



DANGER OF EXPLOSION IF LITHIUM (CLOCK) BATTERY IS INCORRECTLY REPLACED. REPLACE ONLY WITH THE SAME OR EQUIVALENT TYPE RECOMMENDED BY THE MANUFACTURER. DISPOSE OF USED BATTERIES ACCORDING TO THE MANUFACTURER'S INSTRUCTION.



FOR CONTINUED PROTECTION AGAINST RISK OF FIRE, REPLACE ONLY WITH THE SAME TYPE AND RATING FUSE.

## Recycling your battery

Over time, the batteries that run your mobile computer will begin to hold a charge for a shorter amount of time; this is a natural occurrence for all batteries. When this occurs, you may want to replace the battery with a fresh one\*. If you replace it, it is important that you dispose of the old battery properly because batteries contain materials that could cause environmental damage if disposed of improperly.



Fujitsu is very concerned with environmental protection, and has enlisted the services of the Rechargeable Battery Recycling Corporation (RBRC)\*\*, a non-profit public service organization dedicated to protecting our environment by recycling old batteries at no cost to you.

RBRC has drop-off points at tens of thousands of locations throughout the United States and Canada. To find the location nearest you, go to [www.RBRC.org](http://www.RBRC.org) or call 1-800-822-8837.

If there are no convenient RBRC locations near you, you can also go to the EIA Consumer Education Initiative website (<http://EIAE.org/>) and search for a convenient disposal location.

Remember – protecting the environment is a cooperative effort, and you should make every effort to protect it for current and future generations.

- \* To order a new battery for your Fujitsu mobile computer, go to the Fujitsu shopping site at [www.shopfujitsu.com](http://www.shopfujitsu.com) in the US or [www.fujitsu.ca/products/notebooks](http://www.fujitsu.ca/products/notebooks) in Canada.
- \*\* RBRC is an independent third party to which Fujitsu provides funding for battery recycling; RBRC is in no way affiliated with Fujitsu.



# Contents

---

## Preface

<b>About This Guide</b> .....	<b>13</b>
Conventions Used in the Guide .....	13
Fujitsu Contact Information .....	14

## Chapter 1 Getting to Know Your LifeBook

<b>Overview</b> .....	<b>16</b>
<b>Locating the Controls and Connectors</b> .....	<b>17</b>
Top Components (notebook mode) .....	20
Top Components (tablet mode) .....	21
Left-Side Panel Components .....	24
Right-Side Panel Components .....	26
Bottom Components .....	28
<b>Status Indicator Panel</b> .....	<b>30</b>
<b>Display Panel</b> .....	<b>33</b>
Opening the Display Panel .....	34
Using the System as a Tablet .....	34
Adjusting Display Panel Brightness .....	35

<b>Handling the System</b> .....	<b>37</b>
Using in Notebook Configuration .....	37
Using in Tablet Configuration .....	37
<b>Keyboard</b> .....	<b>39</b>
Using the Keyboard .....	39
<b>Using the Cursor Buttons</b> .....	<b>41</b>
Button Control Adjustment .....	44
<b>Using the Touch Screen</b> .....	<b>45</b>
Clicking on Touch Screen .....	46
Right-Clicking on Touch Screen .....	46
Calibrating the Touch Screen .....	47
Double-Clicking .....	47
Dragging .....	47
<b>Volume Control</b> .....	<b>49</b>
Controlling the Volume .....	49
<b>LifeBook Application/Tablet PC Buttons</b> .....	<b>50</b>
Pre-logon button functions .....	50
Post-logon button functions .....	54
Changing Tablet PC Button Functions .....	55
Precautions .....	56



## Chapter 2 Getting Started with Your LifeBook

<b>Power Sources</b> .....	<b>60</b>
Connecting the Power Adapters .....	60
<b>Starting Your LifeBook Notebook</b> .....	<b>62</b>
Power On .....	62
Boot Sequence .....	63
Hard Disk Drive Passwords .....	63
BIOS Setup Utility .....	64
Booting the System .....	65
Starting Windows Vista the first time .....	66
Starting Windows XP the First Time .....	67
Registering Your LifeBook notebook with Fujitsu .....	68
Installing ClickMe! .....	68
Fujitsu Driver Update Utility .....	69
<b>Power Management</b> .....	<b>70</b>
Power/Suspend/Resume Button .....	70
Standby (Sleep) Mode .....	71
Hibernation (Save-to-Disk) Feature .....	72
Windows Power Management .....	72
Restarting the System .....	72
Powering Off .....	73

## Chapter 3 User-Installable Features

<b>Lithium ion Battery</b> .....	<b>74</b>
Recharging the Batteries.....	75
Replacing the Battery.....	77
<b>Secure Digital (SD) Cards</b> .....	<b>79</b>
Installing/Removing an SD Card.....	80
<b>Compact Flash (CF) Cards</b> .....	<b>81</b>
Inserting/Removing Compact Flash Cards.....	82
<b>Device Ports</b> .....	<b>84</b>
Universal Serial Bus Ports.....	84
Headphone Jack.....	85
Microphone Jack.....	86
External Video Port.....	86
LAN (RJ-45) Jack.....	88
Port Replicator Connector.....	89

## Chapter 4 Troubleshooting Your LifeBook

<b>Troubleshooting</b> .....	<b>90</b>
Identifying the Problem.....	90
Specific Problems.....	92
Power On Self Test Messages.....	102
<b>Restoring Your Pre-installed Software</b> .....	<b>107</b>
Re-installing Individual Drivers and Applications.....	107
Restoring the Operating System for Windows XP Systems.....	108
Restoring the Operating System for Windows Vista Systems.....	110
Automatically Downloading Driver Updates.....	114

## **Chapter 5 Care and Maintenance**

### **Caring for your LifeBook Notebook ..... 115**

Cleaning your LifeBook notebook .....	117
Storing your LifeBook notebook .....	117
Traveling with your LifeBook notebook .....	117
Batteries .....	118
Media Care .....	119

## **Chapter 6 System Specifications**

### **Specifications ..... 121**

Configuration Label .....	121
Microprocessor .....	122
Chipset .....	122
Memory .....	122
Video .....	122
Audio .....	123
Mass Storage Device Options .....	123
Features .....	123
Device Ports .....	124
Keyboard .....	125
Power .....	125
Dimensions and Weight .....	126
Environmental Requirements .....	126
Popular Accessories .....	126
Pre-Installed Software .....	127
Learning About Your Software .....	127

## **Glossary/Regulatory**

<b>Glossary</b> .....	<b>130</b>
<b>Regulatory Information</b> .....	<b>145</b>

## **Appendix A: WLAN User's Guide**

<b>Before Using the Optional Wireless LAN</b> .....	<b>153</b>
Wireless LAN Device Covered by this Document .....	153
Characteristics of the WLAN Device .....	153
Wireless LAN Modes Using this Device .....	154
Deactivating/Disconnecting the WLAN Device .....	156
Deactivation Using the Wireless On/Off Switch .....	157
Disconnection Using the Icon in the Taskbar .....	157
Activating the WLAN Device .....	157
<b>Configuring the Wireless LAN</b> .....	<b>158</b>
Configuring the WLAN Using Windows Vista .....	158
Configuring the WLAN Using Windows XP .....	159
Connection to the network .....	159
<b>Troubleshooting the WLAN</b> .....	<b>160</b>
Troubleshooting .....	160
<b>WLAN Specifications</b> .....	<b>162</b>
Specifications .....	162
<b>Using the Bluetooth Device</b> .....	<b>163</b>
What is Bluetooth .....	163
Where to Find Information About Bluetooth .....	163

## Appendix B: Fingerprint Sensor Device

<b>Introducing the Fingerprint Sensor Device</b> .....	<b>165</b>
Getting Started .....	166
Installing OmniPass .....	166
User Enrollment .....	169
Using OmniPass .....	171
Configuring OmniPass .....	177
OmniPass Control Center .....	179
Troubleshooting .....	181

## Index

<b>Index</b> .....	<b>183</b>
--------------------	------------



# Preface

---

## About This Guide

The LifeBook U810\* notebook from Fujitsu Computer Systems Corporation is an ultra-mobile convertible computer. It can be used either as a standard notebook using keyboard input, or in tablet configuration using pen input. It is powered by an Intel® A110 processor, has a built-in color display with a passive digitizer, and brings the computing power of desktop personal computers (PCs) to a handheld, versatile environment.

This manual explains how to operate your LifeBook U810 notebook's hardware and pre-installed system software. Your LifeBook U810 notebook comes with Windows® XP Tablet PC Edition 2005, Windows Vista® Business, or Windows Vista Home Premium pre-installed.

## Conventions Used in the Guide

Keyboard and on-screen keys appear in brackets. Example: [Fn], [F1], [ESC], [ENTER] and [CTRL].

Pages with additional information about a specific topic are cross-referenced within the text. For example: (“See [Installation Procedure](#) on page 43”). Note that all cross-references are linked to the referenced items, so by clicking the link, you will automatically go to the referenced item or page.

On-screen menu items appear in bold. Example: “Click **Fujitsu Menu**, and select your choice”.

\*Depending upon the region in which it is marketed, LifeBook U810 may be identified as LifeBook U1010. LifeBook U810 and U1010 are identical models in every way. For purposes of this document, the LifeBook U810 model name will be used.



THE INFORMATION ICON HIGHLIGHTS INFORMATION THAT WILL ENHANCE YOUR UNDERSTANDING OF THE SUBJECT MATERIAL.



THE CAUTION ICON HIGHLIGHTS INFORMATION THAT IS IMPORTANT TO THE SAFE OPERATION OF YOUR COMPUTER, OR TO THE INTEGRITY OF YOUR FILES. PLEASE READ ALL CAUTION INFORMATION CAREFULLY.



THE WARNING ICON HIGHLIGHTS INFORMATION THAT CAN BE HAZARDOUS TO EITHER YOU, YOUR LIFEBOOK NOTEBOOK, OR YOUR FILES. PLEASE READ ALL WARNING INFORMATION CAREFULLY.

## **Fujitsu Contact Information**

### **Service and Support**

You can contact Fujitsu Service and Support in the following ways:

- Toll free: 1-800-8Fujitsu (1-800-838-5487)
- E-mail: [8fujitsu@us.fujitsu.com](mailto:8fujitsu@us.fujitsu.com)
- Website: <http://www.computers.us.fujitsu.com/support>

Before you place the call, you should have the following information ready so that the customer support representative can provide you with the fastest possible solution:

- Product name
- Product configuration number

- Product serial number
- Purchase date
- Conditions under which the problem occurred
- Any error messages that have occurred
- Type of device connected, if any

### **Fujitsu Shopping Online**

You can go directly to the online by going to the website at: [www.shopfujitsu.com](http://www.shopfujitsu.com).



YOU MUST HAVE AN ACTIVE INTERNET CONNECTION TO USE THE ONLINE URL LINKS.

### **Limited Warranty**

Your LifeBook U810 ultra-mobile notebook is backed by a Fujitsu International Limited Warranty. Check the service kit that came with your notebook for the Limited Warranty period and terms and conditions.



## Chapter 1

# Getting to Know Your LifeBook

### Overview

This section describes the components of your Fujitsu LifeBook U810 notebook. We strongly recommend that you read it before using your notebook – even if you are already familiar with notebook computers.

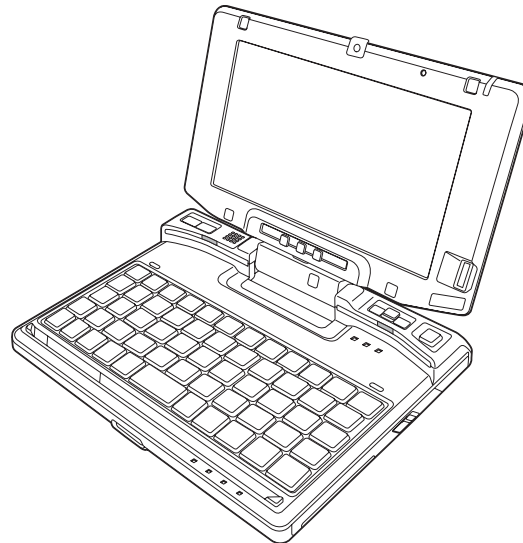











Figure 1. Fujitsu LifeBook U810 notebook

## Locating the Controls and Connectors

Connectors and peripheral interfaces on the LifeBook U810 notebook and the optional port replicator allow you to connect and control a variety of devices. Specific locations are illustrated in Figures 2 through 6. The table below provides a short description of each icon on the LifeBook U810 notebook and/or optional port replicator. Each of the icons is either molded into or printed on the notebook or port replicator chassis.

Connection	Notebook Icon	Purpose
DC in connector		Connect an external power source such as the AC adapter or auto/airline adapter.
Secure Digital (SD) Slot		Insert an SD flash memory card for data storage. Flash memory cards allow you to transfer data to and from a variety of different digital devices.
USB Port		Connect Universal Serial Bus 2.0 or 1.1 compliant devices to the notebook.
Microphone Jack		Connect an external microphone. The internal microphone is disabled when you plug in an external microphone.
Headphone Jack		Connect stereo headphones or powered external speakers. The internal speaker is disabled when you plug in external headphones or powered speakers.
Suspend/ Resume button		The Power/Suspend/Resume button allows you to suspend notebook activity without powering off, resume your notebook from suspend mode, and power on the system when it has been shut down from Windows.

Connection	Notebook Icon	Purpose
Local Area Network (LAN)		<p>(Available on optional port replicator only.)  The LAN (RJ-45) jack is used to connect the internal 10/100/1000* Base-T/Tx Ethernet to a Local Area Network (LAN) in your office or home, or broadband devices such as a cable modem, DSL, or satellite Internet.  <i>*1000 Mbps, commonly referred to as Gigabit Ethernet.</i></p>
Wireless LAN/Bluetooth On-Off Switch		<p>The wireless LAN/Bluetooth switch allows you to turn power to the wireless LAN device and Bluetooth devices on and off.</p>
External Video port		<p>(Available on optional port replicator only.)  The external video port allows you to connect an external monitor or LCD projector to your computer.</p>
Volume Control		<p>The volume control allows you to increase, decrease, or mute the system volume.</p>

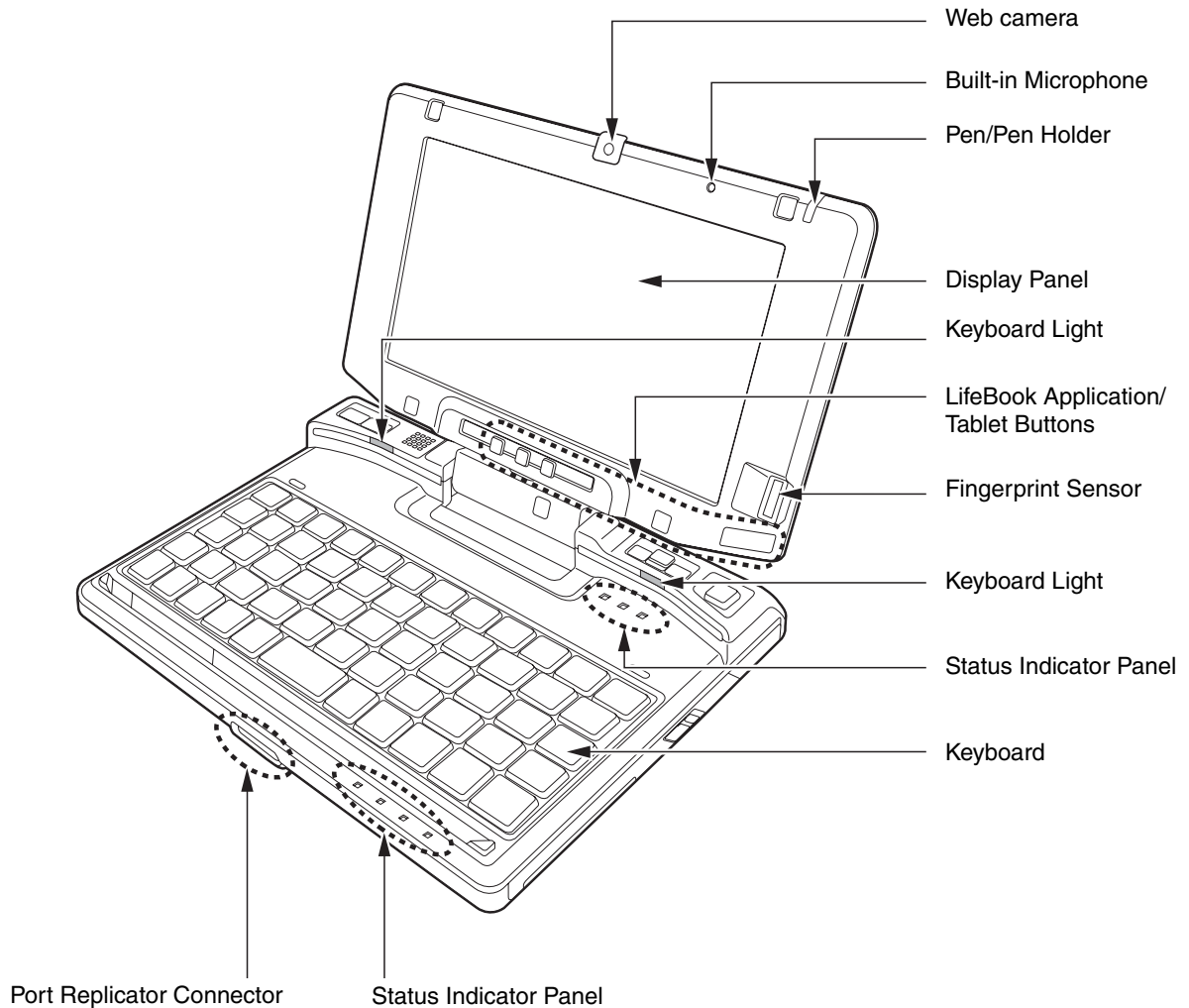

**Figure 2. LifeBook U810 notebook in notebook mode**

## **Top Components (notebook mode)**

The following is a brief description of your LifeBook notebook's top components when it is in notebook mode. (See Figure 2 on page 19 for location)

### **Web Camera**

The web camera allows you to take pictures of yourself to send over the internet.

### **Built-in Microphone**

The built-in microphone allows you to input audio.

### **Pen/Pen Holder**

The pen is used as the interface with the active digitizer display.

### **Display Panel**

The display panel is a color LCD panel with backlighting for the display of text and graphics and passive digitizer functionality.

### **Keyboard Lights**

The two keyboard lights allow you to illuminate the keyboard under low-light conditions.

### **LifeBook Application/Tablet Buttons**

The LifeBook Application/Tablet buttons provide one-touch application launch capability as well as tablet-specific functions. See "LifeBook Application/Tablet PC Buttons" on page 50

### **Fingerprint Sensor**

The fingerprint sensor device allows you to log onto your system and password-protected websites and applications by swiping your finger over the sensor. See "Introducing the Fingerprint Sensor Device" on page 165

## **Status Indicator Panels**

The Status Indicator Panels display symbols that correspond with a specific component of your LifeBook notebook. The indicators above the keyboard relate to the keyboard states, while the indicator panel below the keyboard are related to power and hard drive access. See “Status Indicator Panel” on page 30

## **Keyboard**

A full-size keyboard with dedicated Windows keys. See “Keyboard” on page 39

## **Port Replicator Connector**

This connector allows you to connect the optional Port Replicator to your notebook.

## **Top Components (tablet mode)**

The following is a brief description of your LifeBook notebook’s top components when it is in tablet mode. (See Figure 3 on page 22 for location)

### **Fingerprint Sensor**

The fingerprint sensor device allows you to log onto your system and password-protected websites and applications by swiping your finger over the sensor. See “Introducing the Fingerprint Sensor Device” on page 165

### **Ctrl-Alt-Del Button**

Holding the button down for approximately two seconds causes it to act as if Ctl-Alt-Del had actually been entered from a keyboard.

### **Left Button**

This button acts the same as the left button on a mouse.

### **Right Button**

This button acts the same as the right button on a mouse.

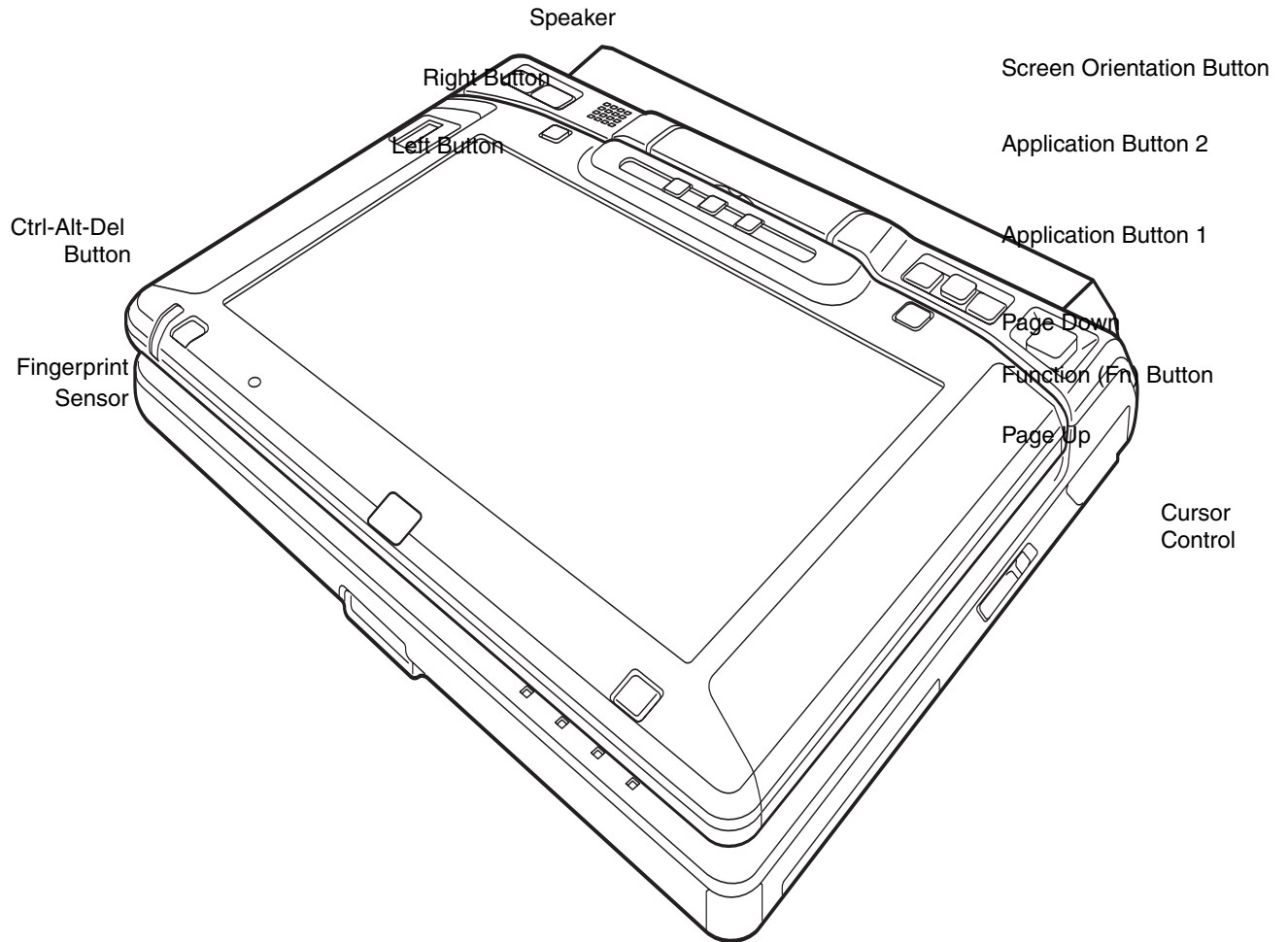

**Figure 3. LifeBook U810 notebook in tablet mode**

## **Speaker**

The built-in speaker allows for mono sound.

## **Screen Orientation Button**

When you press the Screen Orientation button, the system screen orientation changes from portrait (vertical) to landscape (horizontal) or from landscape to portrait. When you would like to use the Tablet PC as an eBook, for example, you would use the portrait orientation, when accessing spreadsheets, you would more typically use a landscape orientation.

## **Application Buttons 1 and 2**

The Application Buttons can be used to automatically open a pre-selected application. These buttons can also be used with the [Fn] button to perform additional tasks. See “LifeBook Application/Tablet PC Buttons” on page 50 for more information about using the Application Buttons.

## **Page Down and Page Up Buttons**

The Page Down and Page Up Buttons can be used to navigate through multiple pages. They can also be used to automatically open pre-selected applications. When used with the [Fn] button, they can also perform additional tasks. See “LifeBook Application/Tablet PC Buttons” on page 50 for more information about using these buttons.

## **Function Button**

The Function Button is used in conjunction with the other Application and Tablet Buttons to perform specified tasks such as opening applications or utilities. When pressed twice in succession, the [Fn] button will open the Fujitsu menu.

## **Cursor Control**

The cursor control is used to move the cursor around the screen.



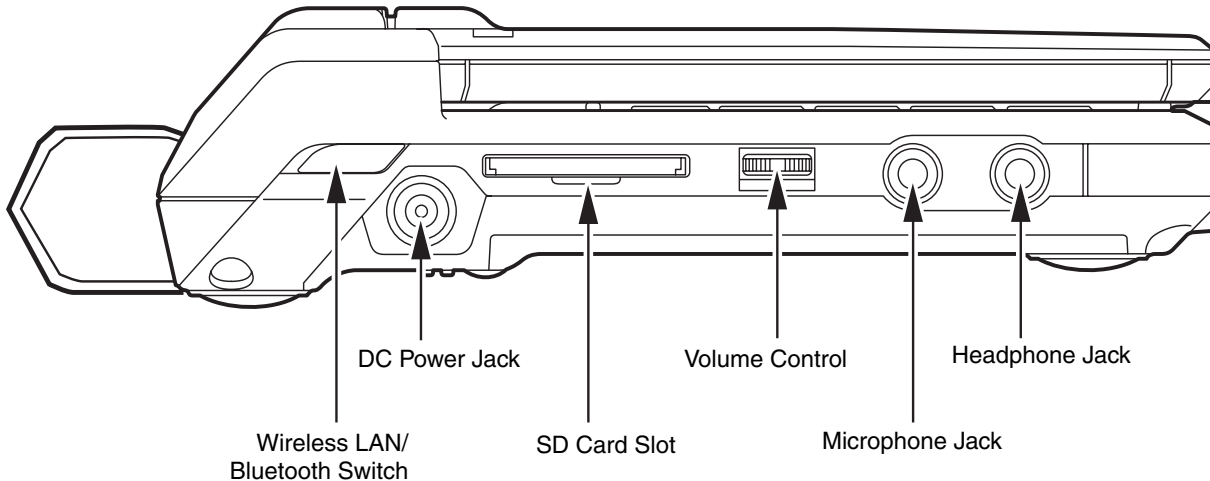

**Figure 4. LifeBook notebook left-side panel**

### **Left-Side Panel Components**

The following is a brief description of your LifeBook notebook's left-side components.

#### **Wireless LAN/Bluetooth Switch**

The wireless LAN/Bluetooth switch is used to turn on and off the WLAN and Bluetooth devices. Switching the device off when not in use will help to extend battery life. See “Activating the WLAN Device” on page 157

#### **DC Power Jack**

The DC power jack allows you to plug in the AC adapter to power your LifeBook notebook and charge the internal Lithium ion battery.

### **Secure Digital (SD) Card Slot**

The Secure Digital (SD) card slot allows you to install an SD card for data storage. This architecture allows you to transfer data from a variety of different digital devices. See “Inserting an SD Card” on page 80.

### **Volume Control**

The volume control allows you to increase, decrease, or mute the system volume. See “Controlling the Volume” on page 49.

### **Microphone Jack**

The microphone jack allows you to connect an external mono microphone. See “Microphone Jack” on page 86

### **Headphone Jack**

The headphone jack allows you to connect headphones. See “External Video Port” on page 86

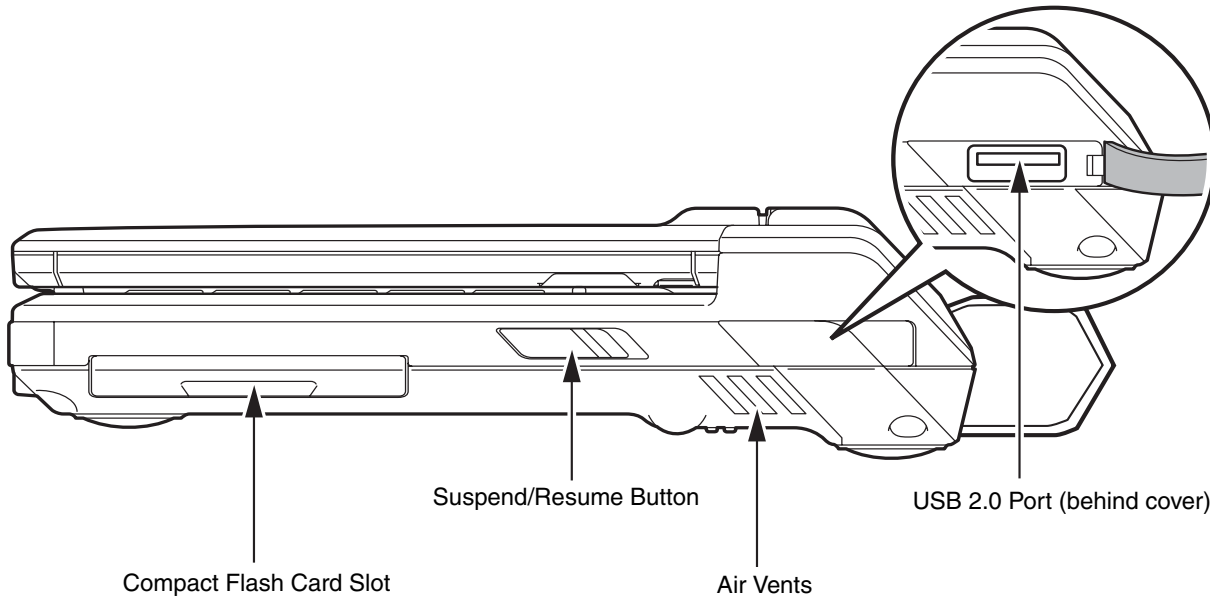

**Figure 5. LifeBook notebook right-side panel**

### **Right-Side Panel Components**

The following is a brief description of your LifeBook notebook's right-side components.

#### **Compact Flash (CF) Card Slot**

Allows you to insert a Compact Flash card. See "Compact Flash (CF) Cards" on page 81

#### **Suspend/Resume Button**

The Power/Suspend/Resume button allows you to suspend notebook activity without powering off, resume your LifeBook notebook from standby mode, and power on your notebook when it has been shut down from Windows. See "Suspend/Resume Button" on page 70

## Air Vents

The air vents are used to cool the system to prevent overheating.



TO PROTECT YOUR NOTEBOOK FROM DAMAGE AND TO OPTIMIZE PERFORMANCE, BE SURE TO **KEEP ALL AIR ALL VENTS UNOBSTRUCTED, CLEAN, AND CLEAR OF DEBRIS**. THIS MAY REQUIRE PERIODIC CLEANING, DEPENDING UPON THE ENVIRONMENT IN WHICH THE SYSTEM IS USED.

DO NOT OPERATE THE NOTEBOOK IN AREAS WHERE THE AIR VENTS CAN BE OBSTRUCTED, SUCH AS IN TIGHT ENCLOSURES OR ON SOFT SURFACES LIKE A BED OR CUSHION.

## USB 2.0 Port

The USB 2.0 port allows you to connect Universal Serial Bus devices. USB 2.0 transfers data at up to 480 Mbps and is backward-compatible with USB 1.1 devices, which transfer data at up to 12 Mbps. See “Universal Serial Bus Ports” on page 84

[TBD - VERIFY ALL XREFS](#)

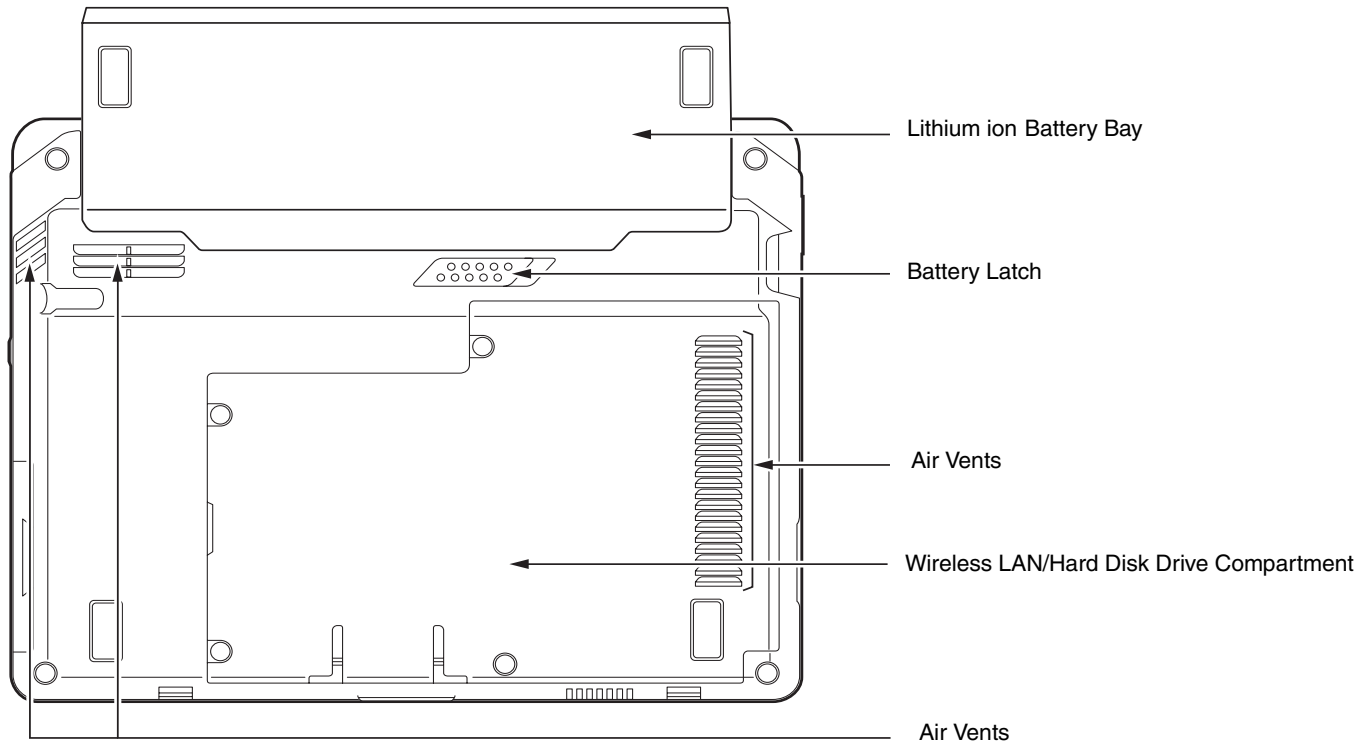

**Figure 6. LifeBook notebook bottom panel**

## **Bottom Components**

The following is a brief description of your LifeBook notebook's bottom panel components.

### **Lithium ion Battery Bay**

The battery bay contains the internal Lithium ion battery. It can be opened for the removal of the battery when stored over a long period of time or for swapping a discharged battery with a charged Lithium ion battery. See "Lithium ion Battery" on page 74

## Battery Latch

The battery latch is used to secure the Lithium ion battery in the battery bay.

## Air Vents

The air vents allow air to circulate through the system to cool down the components.



TO PROTECT YOUR NOTEBOOK FROM DAMAGE AND TO OPTIMIZE SYSTEM PERFORMANCE, BE SURE TO **KEEP ALL AIR ALL VENTS UNOBSTRUCTED, CLEAN, AND CLEAR OF DEBRIS.** THIS MAY REQUIRE PERIODIC CLEANING, DEPENDING UPON THE ENVIRONMENT IN WHICH THE SYSTEM IS USED.

DO NOT OPERATE THE NOTEBOOK IN AREAS WHERE THE AIR VENTS CAN BE OBSTRUCTED, SUCH AS IN TIGHT ENCLOSURES OR ON SOFT SURFACES LIKE A BED OR CUSHION.

## Wireless LAN/Hard Disk Drive Compartment

This compartment houses the wireless LAN device and the Hard Disk Drive. Typically, you should not open this compartment to avoid contamination and possible damage to the system.

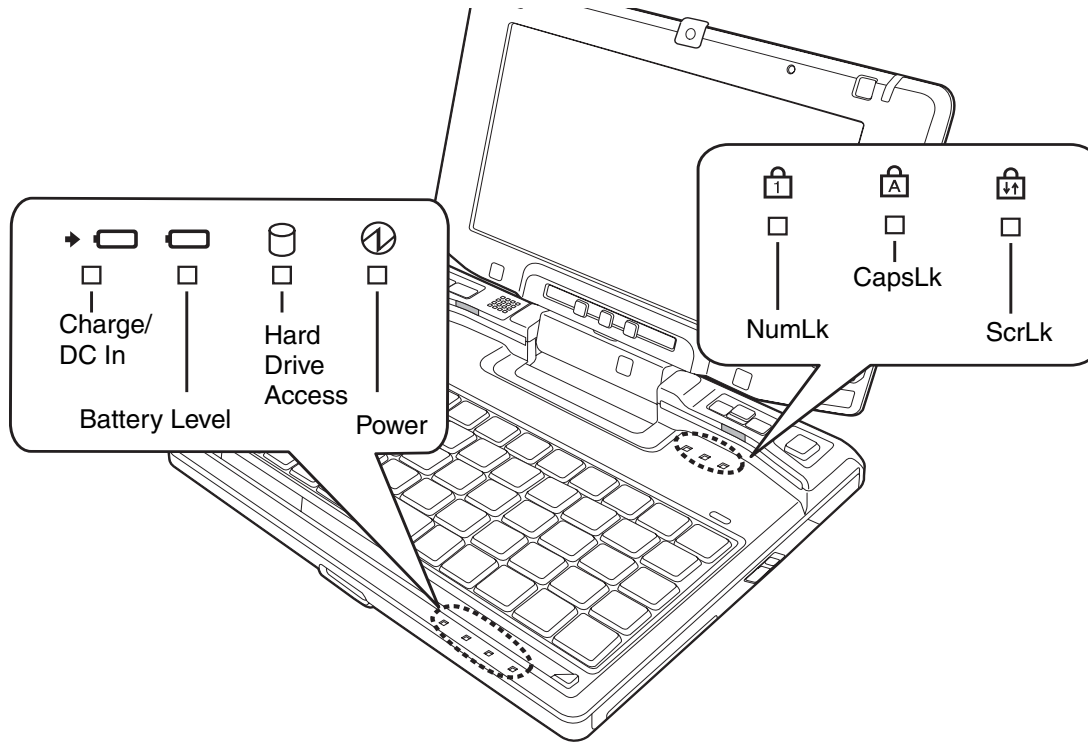

**Figure 7. Status Indicator Panel**

## Status Indicator Panel

The Status Indicators display symbols that correspond to specific components of your Fujitsu LifeBook notebook. The LEDs below each symbol tell you how each of those components is operating. The Status Indicators are located in two different areas (Figure 7). Keyboard-related indicators are above the keyboard on the right, and the remaining indicators are below the keyboard on the right. Note that when the system is in tablet mode, it is not possible to see the keyboard-related indicators; this is fine, since the keyboard is not accessible when the system is in tablet mode.



### Battery Charge/DC-In Indicator

- **Orange, solid:** AC adapter and battery are available and system is charging.
- **Green, solid:** AC adapter and battery are available and system is fully charged, or AC adapter is plugged in but battery is not installed.
- **Orange, blinking:** AC adapter and battery are available and waiting to charge battery (battery is out of thermal range).
- **Off:** AC adapter is not plugged in.



### Battery Level Indicator

The Battery Level indicators display the charge level of the indicated battery pack, as follows:

- **Green, solid:** Battery is between 51% and 100% charged.
- **Orange, solid:** Battery is between 13% and 50% charged.
- **Red, solid:** Battery is 12% or less charged.
- **Orange, blinking:** Blinks during battery status measurement (Four seconds after the battery is installed).
- **Red, blinking:** There is a problem with the battery.
- **Off:** There is no battery installed or the battery has no charge.



- If the battery pack is installed while the power is turned off, the battery level indicator will display the charge level for five seconds after it blinks orange.
- If the AC adapter is not connected or the battery pack is not fully charged when the computer is switched to standby mode, the indicator will blink. The LED blinks at the rate of one second on/six seconds off.





- Batteries subjected to shocks, vibration or extreme temperatures can be permanently damaged.
- A shorted battery is damaged and must be replaced.



### **Hard Drive Access Indicator**

The Hard Drive Access indicator glows green when your internal hard drive is being accessed. Note that flickering is normal.



### **Power Indicator**

The Power indicator glows blue when your system is turned on.



### **NumLk Indicator**

The NumLk indicator states that the integral keyboard is set in ten-key numeric keypad mode.



### **CapsLock Indicator**

The CapsLock indicator states that your keyboard is set to type in all capital letters.



### **ScrLk Indicator**

The ScrLk indicator states that your scroll lock is active.

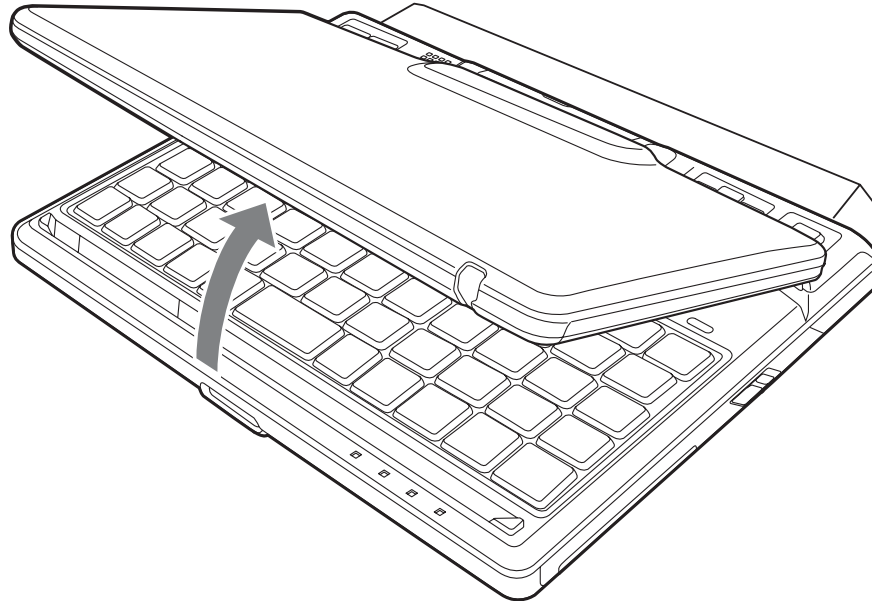

**Figure 8. Opening the Display Panel**

## **Display Panel**

Your LifeBook U810 notebook contains an LCD display panel that is backlit for easier viewing in bright environments. The convertible design of your notebook allows you to open the display fully, rotate it in a clockwise direction 180 degrees, and lay it face up on the keyboard. This allows you to use the system as a tablet, much as you would a pad of paper.

## Opening the Display Panel

Lift the display backwards, being careful not to touch the screen with your fingers, until it is at a comfortable viewing angle. (Figure 8)

## Using the System as a Tablet

If you would like to use the system as a tablet, perform the following steps.



- The display can be rotated in a clockwise direction only. Be sure to turn it counter-clockwise when returning the system to notebook mode (i.e., the reverse of how you turned it when you opened it.) Turning the display in the incorrect direction could cause hinge damage.
- In the following step, be sure to position the display perpendicular to the keyboard, otherwise the keyboard or display cover could get scratched.

- 1** Lift the display until it is perpendicular to the keyboard. (Figure 9).
- 2** When the display is perpendicular to the keyboard, rotate it 180 degrees in clockwise direction (Figure 10) so that it is facing backwards.
- 3** Holding the top edge of the display panel, pull it forward until it is lying flush against the system. You can now use your system as a tablet. (Figure 11)

To return the system to notebook configuration, repeat step 3 and 2.

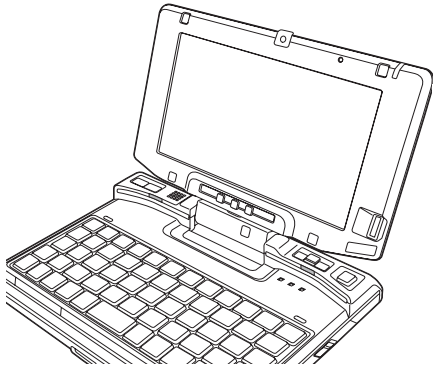

**Figure 9. Fully Open Display**

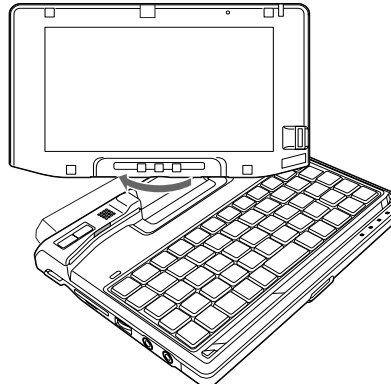

**Figure 10. Rotating Display**

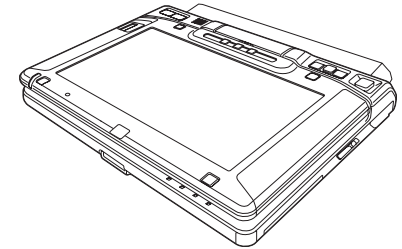

**Figure 11. Tablet Mode**

## **Adjusting Display Panel Brightness**

Once you have turned on your Tablet PC, you may want to adjust the brightness level of the screen to a more comfortable viewing level. There are three ways to adjust the brightness: keyboard, power management utility, and Fujitsu Menu.

### **Using Keyboard to Adjust Brightness**

Adjusting the brightness using the keyboard changes the system setting (i.e., the settings you make via the function keys automatically changes the brightness settings in the system's Pen and Tablet Settings).

- [Fn+F6]: Pressing repeatedly will lower the brightness of your display.
- [Fn+F7]: Pressing repeatedly will increase the brightness of the display.

## Using Power Management to Adjust Brightness

To adjust brightness with the power management utility,:

**Windows XP:** Click Start -> Control Panel. If you are not in Classic View, select it in the left panel. Double-click the Tablet and Pen Settings icon, then select the Display tab. Set the screen brightness slider for **When plugged in** and **Powered by batteries** scenarios.

**Windows Vista:** Click Start -> Control Panel. If you are not in Classic View, select it in the left panel. Double-click the Windows Mobility Center icon, then double-click the icon adjacent to **Display brightness**. Set the screen brightness sliders for **On battery** and **Plugged in** scenarios.

## Using the Fujitsu Menu to Adjust Brightness

**Windows XP:** To adjust brightness using the Fujitsu menu, click on the Fujitsu Menu icon in the system tray in the lower right corner of the screen or press the [Fn] button twice. From the menu that appears, select Brightness Control. The Tablet and Pen Settings window will open. Select the Display tab and set the screen brightness slider for battery and AC power scenarios.

**Windows Vista:** To adjust brightness using the Fujitsu menu, click on the Fujitsu Menu icon in the system tray in the lower right corner of the screen or press the [Fn] button twice. Double-click Windows Mobility Center, then double-click the icon adjacent to **Display brightness**. Set the screen brightness sliders for **On battery** and **Plugged in** scenarios.



IF USING AC POWER, YOUR BRIGHTNESS SETTING IS SET TO ITS HIGHEST LEVEL BY DEFAULT. IF USING BATTERY POWER, YOUR BRIGHTNESS SETTINGS IS SET TO APPROXIMATELY MID-LEVEL BY DEFAULT.

THE HIGHER THE BRIGHTNESS LEVEL, THE MORE POWER THE TABLET PC WILL CONSUME AND THE FASTER YOUR BATTERIES WILL DISCHARGE. FOR MAXIMUM BATTERY LIFE, MAKE SURE THAT THE BRIGHTNESS IS SET AS LOW AS POSSIBLE.

## Handling the System

Your LifeBook U810 notebook is designed to be handheld, used on a secure surface, or docked in the optional tablet dock. When holding the notebook, use the following methods for optimal results.



DO NOT USE THE NOTEBOOK ON YOUR LAP. USING IT ON YOUR LAP WILL BLOCK THE AIR VENTS, WHICH COULD RESULT IN DAMAGE TO THE SYSTEM AND ALSO CAN REDUCE THE RF EXPOSURE SAFETY DISTANCE DURING RADIO OPERATION.

### Using in Notebook Configuration

To use your LifeBook in notebook configuration, place it on a flat, secure surface or hold it as shown in Figure 12. Note that when holding the system, most of the keying will be done with the thumbs, since the fingers are used to hold the device.

If you hold the system with one hand, grasp it securely to prevent it from slipping .

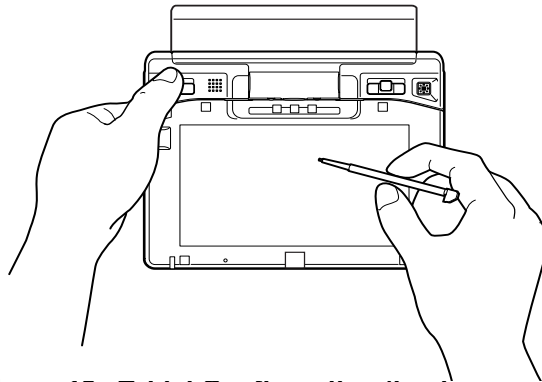

**Figure 13. Tablet Configuration (landscape mode)**

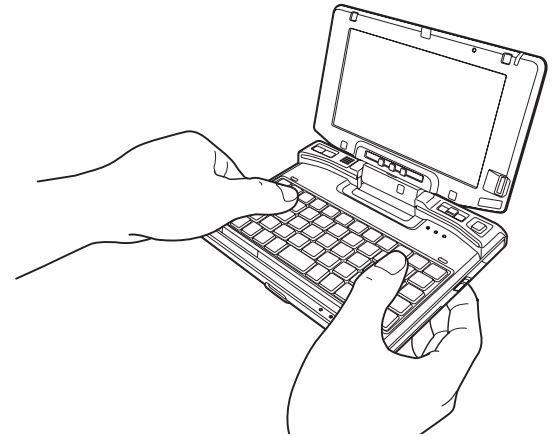
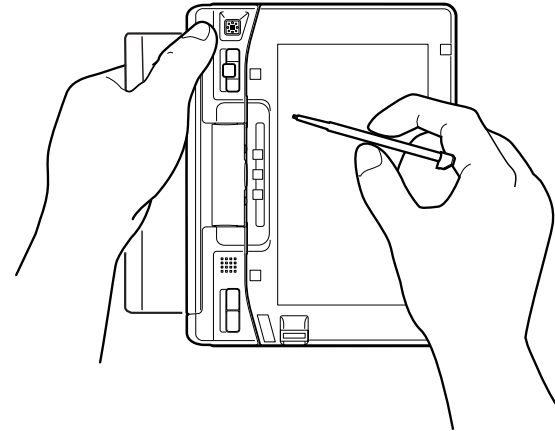

**Figure 12. Notebook Orientation**

### Using in Tablet Configuration

**Landscape Mode:** To use your LifeBook in tablet configuration in landscape (horizontal) mode, first convert it as directed in “Using the System as a Tablet” on page 34. Hold the system as shown in Figure 13, or place it on a flat, secure surface.

**Portrait Mode:** To use your LifeBook in tablet configuration in portrait (vertical) mode, first convert it as directed in “Using the System as a Tablet” on page 34. Hold the system as shown in Figure 13, or place it on a flat, secure surface



**Figure 14. Notebook Orientation (portrait mode)**

# Keyboard

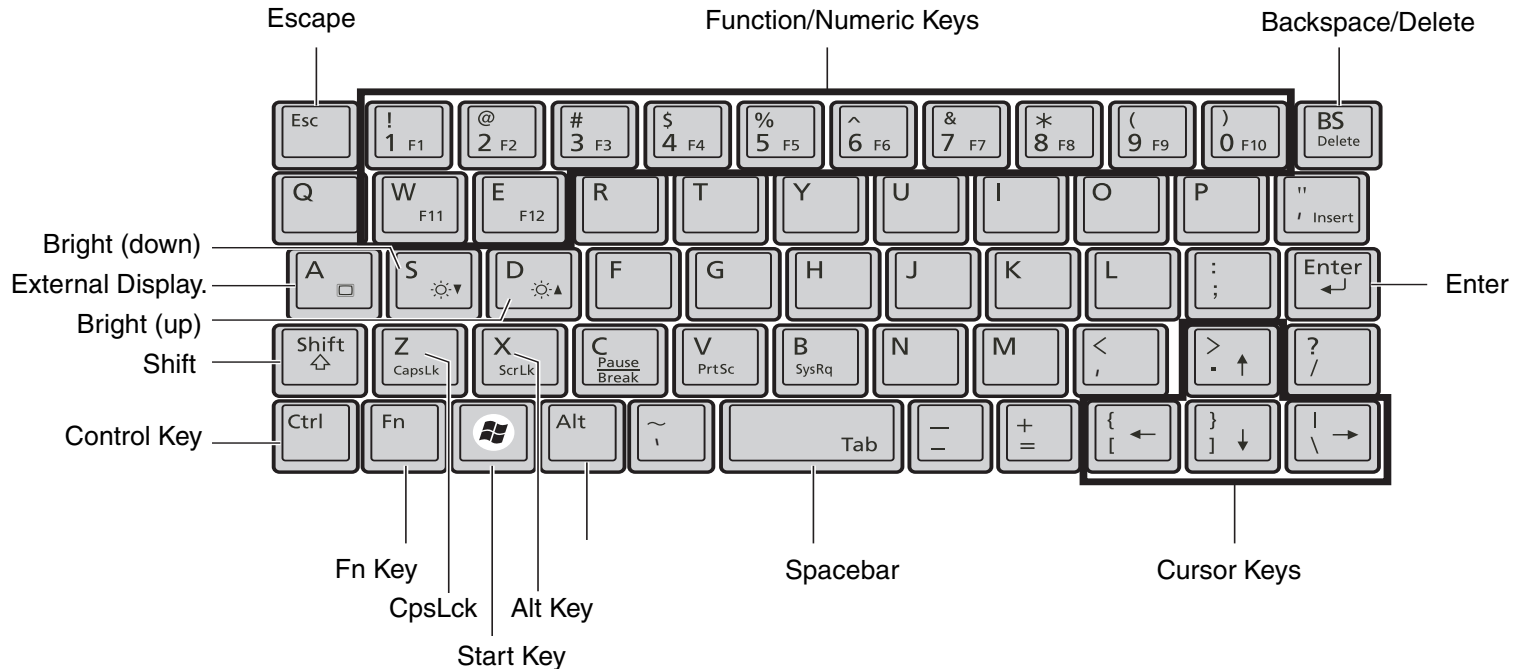

Figure 15. Keyboard

## Using the Keyboard

Your Fujitsu LifeBook notebook has an integral 56-key keyboard. The keys perform all the standard functions of a 101-key keyboard, including the special function keys. This section describes the special keys (Figure 15):

### Start Key

Your LifeBook notebook Start key displays the Start menu. This button functions the same as your onscreen Start menu button. (Please refer to your Windows documentation for additional information regarding the Windows keys.)



## Cursor Keys

The cursor keys are the four arrow keys on the keyboard which allow you to move the cursor up, down, left and right in applications. In programs such as Windows Explorer, it moves the “focus” (selects the next item up, down, left, or right).

## Function Keys

Your LifeBook notebook has 12 function keys, F1 through F12. The functions assigned to these keys differ for each application. You should refer to your software documentation to find out how these keys are used. Due to the ultra-mobile design of the system and keyboard, some of the functions that are normally assigned to function keys have been reassigned to other keys, as noted below:

- The [Fn] key provides extended functions for the notebook and is always used in conjunction with another key.
- [Fn+S]: Pressing [S] repeatedly while holding [Fn] will lower the brightness of your display.
- [Fn+D]: Pressing [D] repeatedly while holding [Fn] will increase the brightness of the display.
- [Fn+A]: Pressing [A] while holding [Fn] allows you to change your selection of where to send your display video. Each time you press the combination of keys you will step to the next choice. The choices, in order, are: built-in display panel only, external monitor only, and both built-in display panel and external monitor.

## Using the Cursor Buttons

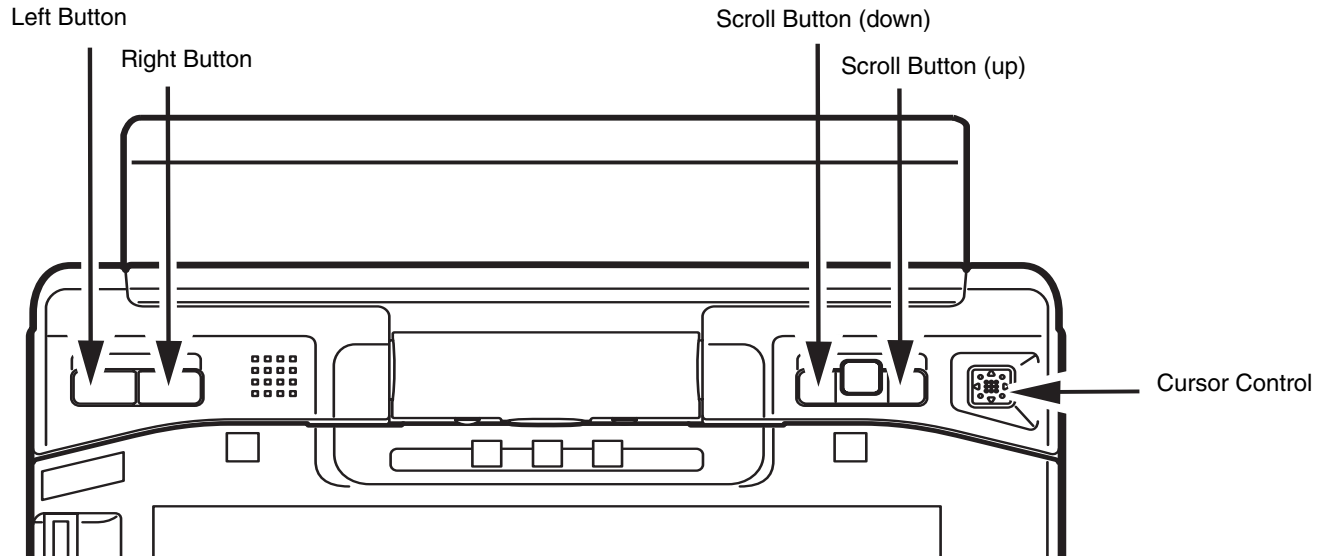

**Figure 16. Cursor Buttons**

The button array across the top of your LifeBook notebook is used to control the movement of the cursor and to select items on your display panel. The buttons consist of a cursor control at the top right, two left/right buttons on the top left, and scroll buttons adjacent to the cursor control.

The cursor control works the same way a mouse ball does by moving the cursor around the display. It only requires light pressure with the tip of your finger, and the more pressure you use, the faster the cursor will move. Note that the cursor control can be used in the same manner as the left button; first use it to position the cursor, then tap on it to activate your selection.

The left button functions the same as a left mouse button while the right button has the same function as a right mouse button. The scroll buttons allow you to scroll up and down a screen. The actual functionality of the buttons may vary depending on the application that is being used and how they are assigned in the Tablet PC Settings utility in the Control Panel.

## Clicking

Clicking means pushing and releasing a button. To left-click, move the cursor to the item you wish to select, press the Left button once, and then immediately release it. You can also left-click by moving the cursor to the item you wish to select, then tapping the cursor control once. To right-click, move the cursor to the item you wish to select, press the Right button once, and then immediately release it.

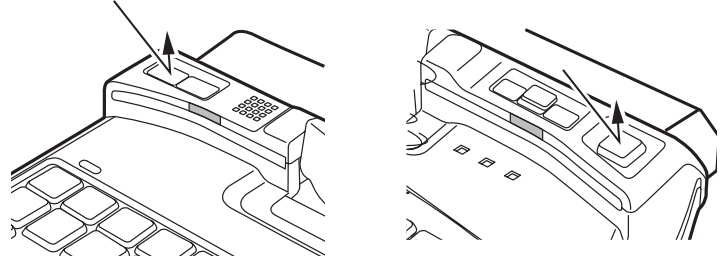

Figure 17. Clicking

## Double-Clicking

Double-clicking means quickly pushing and releasing the left button twice. This procedure does not function with the right button. To double-click, move the cursor to the item you wish to select, then press and release the left button twice. You can also left-click by moving the cursor to the item you wish to select, then double-tapping the cursor control.

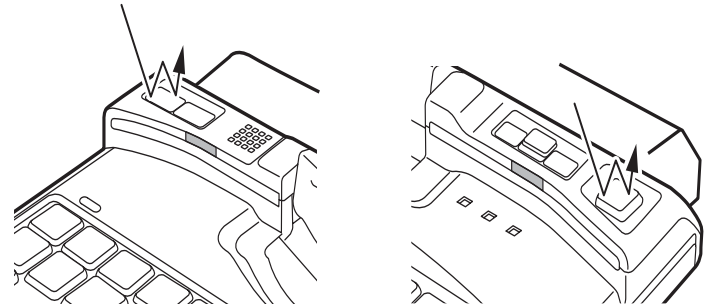

Figure 18. Double-clicking



- IF THE INTERVAL BETWEEN CLICKS IS TOO LONG, THE DOUBLE-CLICK WILL NOT BE EXECUTED.
- PARAMETERS FOR THE BUTTONS CAN BE ADJUSTED FROM THE MOUSE DIALOG BOX LOCATED IN THE WINDOWS CONTROL PANEL.

## Dragging

Dragging means pressing and holding the left button, while moving the cursor control. To drag, move the cursor to the item you wish to move. Press and hold the left button while moving the item to its new location and then release it.

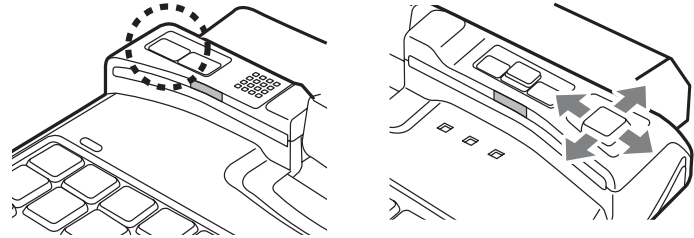

**Figure 19. Dragging**

## Scrolling

Using the Scrolling buttons allows you to navigate through a document quickly without using the window's scroll bars. This is particularly useful when you are navigating through on-line pages. To scroll, press and hold the scroll up or scroll down button, depending upon which direction you want to scroll.

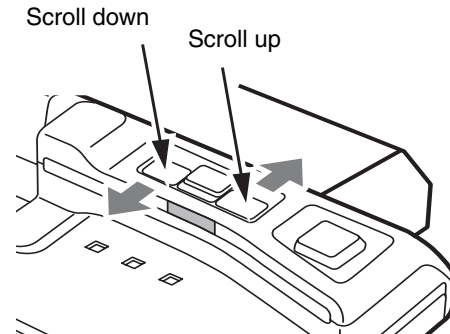

**Figure 20. Scrolling**

## Button Control Adjustment

The Windows Control Panel allows you to customize your cursor buttons with selections made from within the Mouse Properties dialog box. There are three aspects of button operation, which you can adjust:

- **Buttons:** This tab lets you set up the buttons for right or left handed operation, in addition to setting up the time interval allowed between clicks in double-clicking.
- **Pointers:** This tab lets you set up the scheme for the cursor depending on its functionality.
- **Pointer Options:** This tab lets you set up a relation between the speed of your finger motion and the speed of the cursor. It also allows you to enable a Pointer Trail for the cursor arrow.

## Using the Touch Screen

The integrated Touch Screen allows you to use the included stylus as a pointing device. You can use the stylus to click, double-click, drag items and icons, or to draw like a pen or pencil in applications that support this behavior, such as drawing or painting programs. See the documentation that came with your application for details.

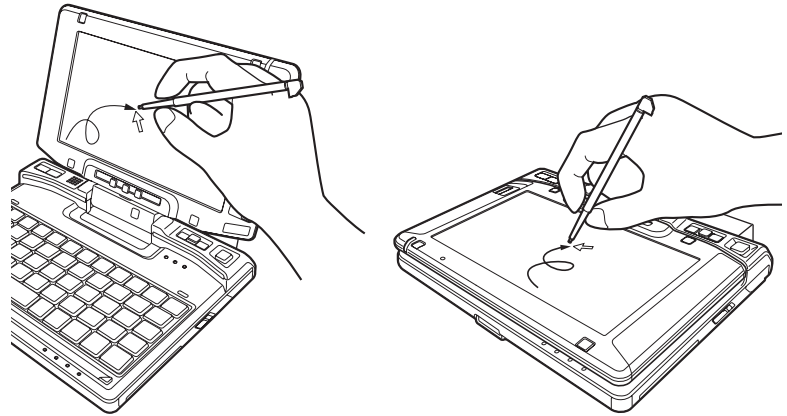

**Figure 21. Using the touch screen**



- **DO NOT USE EXCESSIVE FORCE** WHEN TAPPING OR WRITING ON THE SCREEN WITH THE STYLUS. EXCESSIVE FORCE COULD RESULT IN DAMAGE TO THE LED AND/OR TOUCH SCREEN.
- TO PURCHASE ADDITIONAL OR REPLACEMENT STYLUSES, VISIT FUJITSU'S ACCESSORIES WEBSITE AT: [WWW.SHOPFUJITSU.COM](http://WWW.SHOPFUJITSU.COM).

## Clicking on Touch Screen

To left-click, touch the object you wish to select and then lift the stylus tip immediately.

## Right-Clicking on Touch Screen

### Windows Vista

Right-click can be accomplished by holding the pen down until a circular icon appears. To change the settings for the right-click feature, go to Start -> Control Panel -> Pen and Input Devices. In the Pen Options tab, select “Press and Hold” then click the [Settings] button.

### Windows XP Tablet PC Edition:

Right-click can be accomplished by holding the pen down until a circular icon appears. To change the settings for the right-click feature, go to Start -> Control Panel -> Tablet and Pen Settings. In the Pen Options tab, select “Press and Hold” then click the [Settings] button.

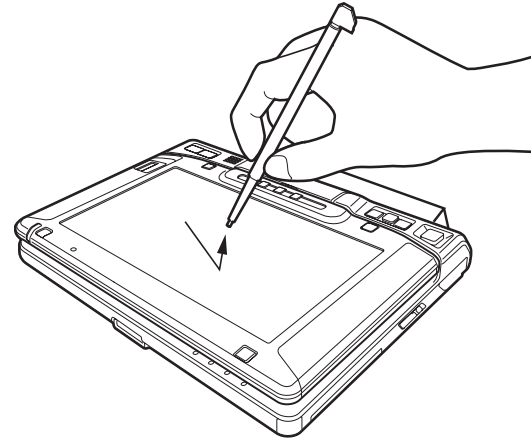

Figure 22. Clicking on the touch screen

## Double-Clicking

To double-click, touch the item twice, and then immediately remove the stylus tip.

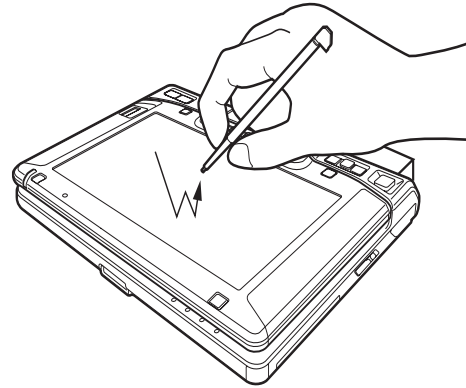

Figure 23. Double-clicking on the touch screen

## Dragging

Dragging means moving an item with the stylus by touching the screen, moving and then lifting the stylus. To drag, touch the Touch Screen with your stylus on the item you wish to move. While continuing to touch the screen with the stylus, drag the item to its new location by moving the stylus across the screen, and then lifting the stylus to release it. Dragging can also be done using your fingertip.

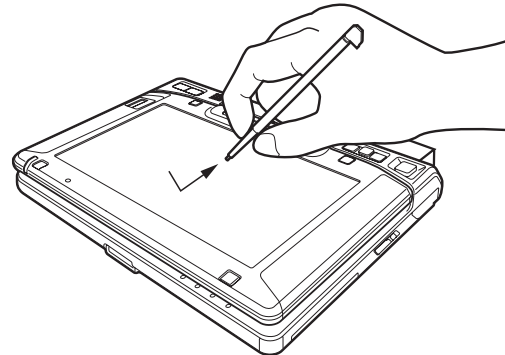

Figure 24. Dragging on the touch screen



## Calibrating the Touch Screen

In order to ensure accurate tracking between the stylus and cursor, you must run the Touch Screen Calibration Utility before you use the Touch Screen for the first time, or after you change the display resolution.

To run the calibration utility:

- 1** Go to Start -> Control Panel. If you are not in Classic View, select “Switch to Classic View” in the left panel.  
**Windows XP Tablet PC Edition:** Double-click the Tablet and Pen Settings icon and select the Settings tab.  
**Windows Vista:** Double-click the Tablet PC Settings icon and select the General tab
- 2** Click the [Calibrate] button.
- 3** Adjust the display of your notebook to a comfortable angle and find the (+) symbol in the upper-left corner of the display.



**DO NOT USE EXCESSIVE FORCE** WHEN TAPPING ON THE SCREEN DURING CALIBRATION. USE OF EXCESSIVE FORCE COULD RESULT IN DAMAGE TO THE LED AND/OR TOUCH PANEL.



WHEN USING THE STYLUS TO CALIBRATE THE SCREEN, BE SURE TO AVOID TOUCHING THE SCREEN WITH YOUR FINGERS; DOING SO COULD RESULT IN FAULTY CALIBRATION.

- 4** Using the stylus, firmly touch the screen directly on the (+) symbol. Lift the stylus from the screen and the target will move to a different location on the screen.
- 5** Repeat step 4 until you have selected all of the (+) symbols.
- 6** Once you have selected all the symbols, press the [OK] button.
- 7** Touch the stylus to various points on the screen to verify that the screen is correctly calibrated. If you are not satisfied with the screen’s calibration, press the [Calibrate] button to begin again.

# Volume Control

Your Fujitsu LifeBook notebook has multiple volume controls which interact with each other.



ANY SOFTWARE THAT CONTAINS AUDIO FILES WILL ALSO CONTAIN A VOLUME CONTROL OF ITS OWN. IF YOU INSTALL AN EXTERNAL AUDIO DEVICE THAT HAS AN INDEPENDENT VOLUME CONTROL, THE HARDWARE VOLUME CONTROL AND THE SOFTWARE VOLUME CONTROL WILL INTERACT WITH EACH OTHER. IT SHOULD BE NOTED THAT IF YOU SET YOUR SOFTWARE VOLUME TO OFF, YOU WILL OVERRIDE THE EXTERNAL VOLUME CONTROL SETTING.

## Controlling the Volume

The volume can be controlled in several different ways:

- Volume can be controlled using the volume dial on the left side of the system (Figure 21). To change the volume, simply rotate the dial. You can also mute the sound by pressing the dial towards the system.
  - Volume can be changed or muted from within the Volume Control in the system tray.
  - Volume can be controlled by many volume controls that are set within individual applications.
  - Certain external audio devices you connect to your system may have hardware volume controls.
- Each source discussed above puts an upper limit on the volume level that must then be followed by the other sources. We recommend that you experiment with the various volume controls to discover the optimal sound level.

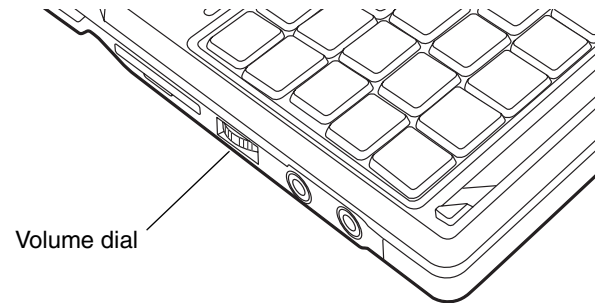

**Figure 21. Volume Dial**

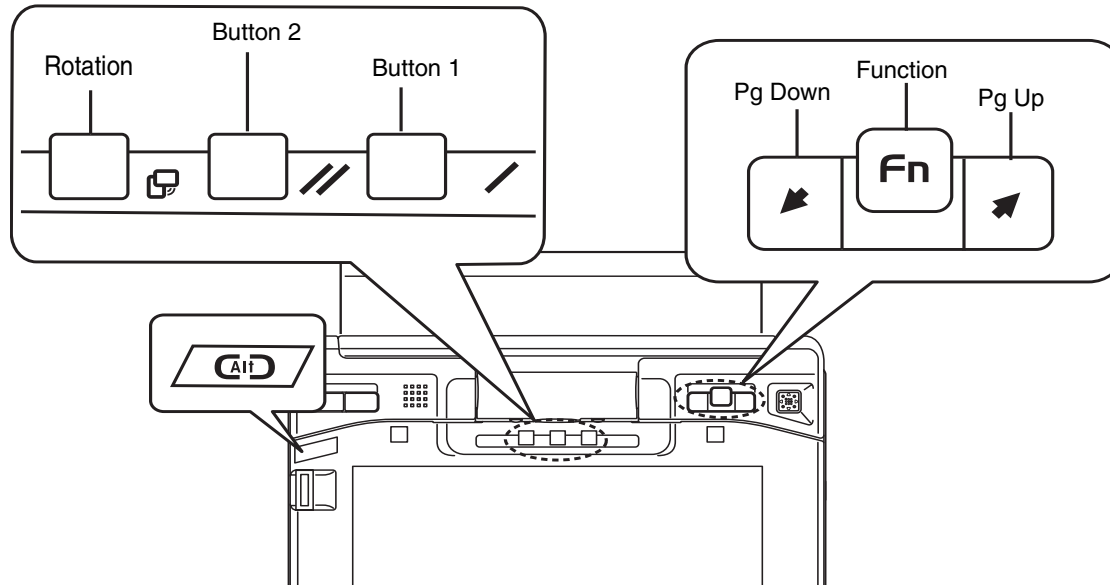

**Figure 22. LifeBook U810 Notebook Application/Tablet PC Buttons**

## LifeBook Application/Tablet PC Buttons

A unique feature of your LifeBook U810 notebook is the array of Application and Tablet PC buttons. These buttons allow you to launch specific applications and functions with the touch of a button.

### Pre-logout button functions

All TBD buttons can be used before logging on to Windows (i.e., the Windows logon screen is displayed). Three of the buttons have secondary functions. See Table 1 for information about the pre-logout functions.







#### <Tab>/<Shift><Tab>

When you press the [Page Down] button when the system is pre-logout, each press of the button will act as if you had pressed the [Tab] key.

When you press the [Fn] button then press and release the [Page Down] button, each press of the button will act as if you had pressed the [Shift]+[Tab] key combination.

**<Enter>/<Escape>**

When you press the [Page Up] button when the system is pre-logout, each press of the button will act as if you had pressed the [Enter] key.

Button Icon	System State	Notebook Function	Secondary Functions (Fn + Button)
	System is pre-logout (Windows logon screen is displayed)	Button 1	
		Button 2	
		<Tab>	<Shift><Tab>
		<Enter>	<Escape>
		Rotate screen	None
<b>Fn</b>		Used to invoke secondary function	None
		Ctl+Alt+Del Button	None

**Table 1. Pre-logout Tablet PC Button Functions**

When you press the [Fn] button then press and release the [Page Up] button, each press of the button will act as if you had pressed the [Escape] key.

### **Screen Rotation**







The screen rotation feature would normally be used when the system is configured as a tablet. When you would like to use the tablet as an eBook, for example, you would use the portrait orientation; when accessing spreadsheets or using the system as a notebook, you would more typically use landscape orientation.

When the system is changed to tablet configuration, the orientation automatically changes to portrait mode by default.



THE SCREEN ORIENTATION DEFAULT CAN BE CHANGED BY GOING TO THE CONTROL PANEL AND DOUBLE-CLICKING THE FUJITSU TABLET CONTROLS ICON AND SELECTING THE DESIRED SETTINGS IN THE DISPLAY PROPERTIES. AFTER CHANGING THE SETTINGS, SAVE THEM IN FUJITSU TABLET CONTROLS.

When you press the [Screen Rotation] button when the system is in pre-boot, the system screen orientation changes from portrait (vertical) to landscape (horizontal) or from landscape to portrait.

Button Icon	System State	Primary Notebook Function	Secondary Functions (Fn + Button)
	System is post-logout (Windows desktop is displayed)		
			
		Page Down	User-defined Application A (Default = Calculator)
		Page Up	User-Defined Application B (Default = MS Journal)
		Screen Rotation	Display Switching: 1. LED only 2. CRT only 3. Dual Display
<b>Fn</b>		Secondary Function Selection	Fujitsu Menu Utility
		Ctrl+Alt+Del Button	None

**Table 2. Post-logout Tablet PC Button Functions**

### **Function / Fujitsu Menu Utility Button**

The [Function] button works in conjunction with the other application buttons to provide additional functionality for the buttons. Refer to specific details above.

## **Post-logon button functions**

All five buttons can be used after logging on to Windows. Four of the buttons have secondary functions. See Table 2 for information about each of the post-logon functions.

### **Page Down / Application A Button**

When you press the [Page Down] button when the system is running, each press of the button will scroll the screen down one frame. This allows you to navigate quickly through large documents.

When you press the [Fn] button then press and release the [Page Down/Application A] button, you will automatically start whichever program is assigned to the button. The default application for this button is Calculator. See “Changing Tablet PC Button Functions” on page 55 to select a different application for this button.

### **Page Up / Application B Button**

When you press the [Page Up] button when the system is running, each press of the button will scroll the screen up one frame. This allows you to navigate quickly through large documents.

When you press the [Fn] button then press and release the [Page Up/Application B] button, you will automatically start whichever program is assigned to the button. The default application for this button is Microsoft Journal. See “Changing Tablet PC Button Functions” on page 55. to select a different application for this button.

### **Screen Rotation /Display Switching Button**

The screen rotation feature would normally be used only when the system is configured as a tablet. When you would like to use the tablet as an eBook, for example, you would use the portrait orientation; when accessing spreadsheets or using the system as a notebook, you would more typically use landscape orientation.

When the system is changed to tablet configuration, the orientation automatically changes to portrait mode by default.



THE SCREEN ORIENTATION DEFAULT CAN BE CHANGED BY GOING TO THE CONTROL PANEL AND DOUBLE-CLICKING ON THE FUJITSU TABLET CONTROLS ICON AND SELECTING THE DESIRED SETTINGS IN THE DISPLAY PROPERTIES. AFTER CHANGING THE SETTINGS, SAVE THEM IN FUJITSU TABLET CONTROLS.

When you press the [Screen Rotation /Display Switching] button, the system screen orientation changes from portrait (vertical) to landscape (horizontal) or from landscape to portrait.

Pressing the [Fn] button while pressing the [Screen Rotation] button will switch the display output in the following order: built-in display only, external display only, dual display.

### **Function / Fujitsu Menu Utility Button**

The [Function] button works in conjunction with the other application buttons to provide additional functionality for the buttons. Refer to specific details above.

Pressing the [Fn] button twice in succession causes the Fujitsu Menu Utility to appear on your screen, allowing you to modify certain system settings.

### **Ctl+Alt+Del Button**

Pressing and holding the [Ctl-Alt-Del] button for up to 750 milliseconds launches the Logon screen or the Windows Task Manager.

### **Changing Tablet PC Button Functions**

The Application A and B buttons can be changed to launch a program or perform an action you select. By default, the Application A button launches the Calculator, and the Application B button launches MS Journal.

To launch different applications or cause the Application A or B buttons to perform a specific action:



## Windows XP:

- 1 Double-click on the Tablet and Pen Settings icon in the Control Panel.
- 2 Select the **Tablet Buttons** tab and select the button you would like to change from the list.
- 3 Click [Change] and open the drop down list in the **Action:** field.
- 4 Select the action you would like the button to perform. If you want to launch a program, click on **Launch an Application** then browse to the location of the program.
- 5 Click [OK], then click [OK] again. The buttons will now perform the actions you have assigned to them.

## Windows Vista:

- 1 Double-click on the Tablet PC Settings icon in the Control Panel.
- 2 Select the **Buttons** tab and select the button you would like to change from the list.
- 3 Click [Change] and open the drop down list in the **Press:** field.
- 4 Select the action you would like the button to perform. If you want to launch a program, click on **Launch an Application** then browse to the location of the program.
- 5 Click [OK], then click [OK] again. The buttons will now perform the actions you have assigned to them.

## Precautions

### Opening and Closing the Cover

By default, closing the cover automatically places your system into Standby mode.

### Windows XP systems:

You can change the action the system takes when the cover is closed by opening the Power Options Properties icon in the Control Panel, and selecting the Advanced tab. Make a choice from the drop down menu for **When I close the lid of my portable computer** and click the [OK] button.) Opening the cover does not automatically place the notebook into normal operation. Instead, you must enter the proper security password after pushing the Power/Suspend/Resume button.

## Windows Vista systems:

To change the default for Windows Vista systems when the cover is closed:

- 1 Open the system Control Panel.
- 2 If the display is in Category view, click Change battery settings under the Mobile PC category. If it is in Classic view, click Power Options.
- 3 Click **Choose what closing the lid does** in the left pane.
- 4 Select the desired action for **When I close the lid**, then click the [Save changes] button.

## Low Battery Operations

If your notebook has a low battery, pushing the power/suspend/resume button only turns on the Security Indicator. Your notebook does not unlock, the Security Indicator turns off after one minute. To resume normal operation, first attach a power supply to the notebook. Then you may unlock the notebook.



## Chapter 2

# Getting Started with Your LifeBook

---

## Power Sources

Your Fujitsu LifeBook notebook has three possible power sources: a primary Lithium ion battery, an AC adapter or an optional Auto/Airline adapter.

### Connecting the Power Adapters

The AC adapter or optional Auto/Airline adapter provides power for operating your notebook and charging the batteries.

#### Connecting the AC Adapter

- 1 Plug the DC output cable into the DC power jack of your LifeBook notebook (Figure 23).
- 2 Plug the AC adapter into an AC electrical outlet.

#### Connecting the Optional Auto/Airline Adapter

- 1 Plug the DC output cable into the DC power jack on your notebook.
- 2 Plug the Auto/Airline adapter into the cigarette lighter of an automobile with the ignition key in the On or Access OR
- 3 Plug the Auto/Airline adapter into the DC power jack on an airplane seat.

## Switching from AC Adapter Power or the Auto/Airline Adapter to Battery Power

- 1 Be sure that you have at least one charged battery installed.
- 2 Remove the AC adapter or the Auto/Airline adapter.



THE LITHIUM ION BATTERY IS NOT CHARGED UPON PURCHASE. INITIALLY, YOU WILL NEED TO CONNECT EITHER THE AC ADAPTER OR THE AUTO/AIRLINE ADAPTER TO USE YOUR NOTEBOOK.

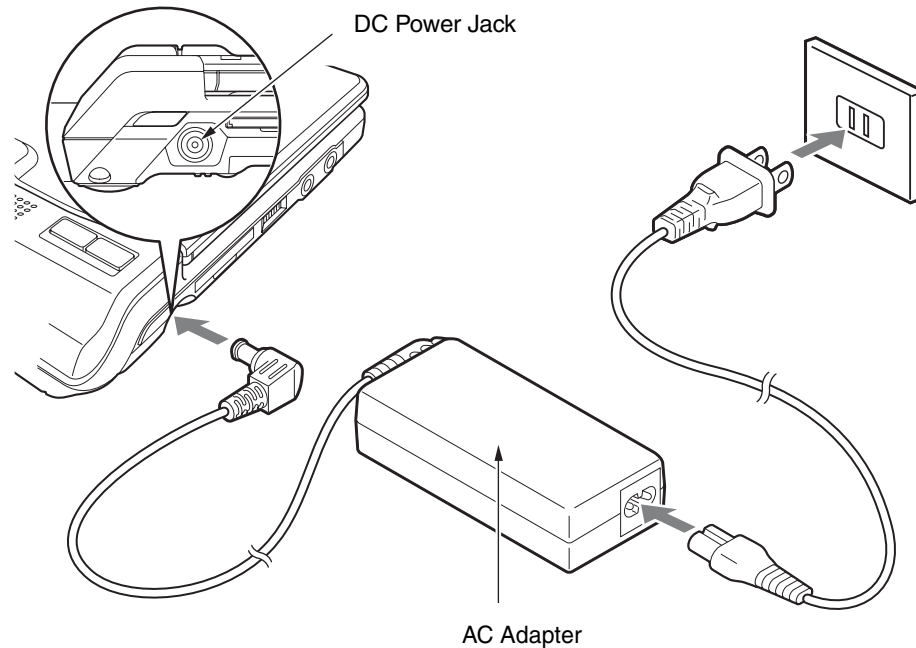

**Figure 23. Connecting the AC Adapter**

# Starting Your LifeBook Notebook

## Power On

### Power/Suspend/Resume Button

The Power/Suspend/Resume button allows you to suspend notebook activity without powering off, resume your LifeBook notebook from standby mode, and power on your notebook when it has been shut down from Windows.



WHEN YOU TURN ON YOUR LIFEBOOK NOTEBOOK, BE SURE YOU HAVE A POWER SOURCE. THIS MEANS THAT AT LEAST ONE BATTERY IS INSTALLED AND CHARGED, OR THAT THE AC OR AUTO/AIRLINE ADAPTER IS CONNECTED AND HAS POWER.

To turn on your LifeBook notebook from its off state, push the Power/Suspend/Resume button (located on the right side of the system) towards the back of the system (See Figure 5 on page 26 for location). When you are done working you can either leave your notebook in Suspend mode, See “Standby (Sleep) Mode” on page 71. or you can turn it off. See “Powering Off” on page 74.



DO NOT CARRY YOUR LIFEBOOK NOTEBOOK AROUND WITH THE POWER ON OR SUBJECT IT TO SHOCKS OR VIBRATION, AS YOU RISK DAMAGING YOUR NOTEBOOK.

When you power on your LifeBook, it will perform a Power On Self Test (POST) to check the internal parts and configuration for correct functionality. If a fault is found, your LifeBook notebook will emit an audio warning and/or an error message will be displayed. See “Power On Self Test Messages” on page 102. Depending on the nature of the problem, you may be able to continue by starting the operating system or by entering the BIOS setup utility and revising the settings.

After satisfactory completion of the POST, your notebook will load your operating system.



NEVER TURN OFF YOUR LIFEBOOK NOTEBOOK DURING THE POWER ON SELF TEST (POST) OR IT WILL CAUSE AN ERROR MESSAGE TO BE DISPLAYED WHEN YOU TURN YOUR LIFEBOOK NOTEBOOK ON THE NEXT TIME. See “Power On Self Test Messages” on page 102.

## Boot Sequence

The procedure for starting-up your notebook is termed the Bootup sequence and involves your notebook’s BIOS. When your LifeBook notebook is first turned on, the main system memory is empty, and it needs to find instructions to start up your notebook. This information is in the BIOS program. Each time you power up or restart your notebook, it goes through a boot sequence which displays a Fujitsu logo until your operating system is loaded. During booting, your notebook is performing a standard boot sequence including a Power On Self Test (POST). When the boot sequence is completed without a failure and without a request for the BIOS Setup Utility, the system displays the operating system’s opening screen.

The boot sequence is executed when:

- You turn on the power to your LifeBook notebook.
- You restart your notebook from the Windows Shut Down dialog box.
- The software initiates a system restart. Example: When you install a new application.

## Hard Disk Drive Passwords

To provide additional security for your data, you can assign passwords to your hard disk drive(s). This feature is managed in the system BIOS Setup Utility. See *BIOS Setup Utility* below for information about accessing the utility.



**REMEMBER YOUR PASSWORDS.** IF YOU SET AND FORGET YOUR USER AND SUPERVISOR HARD DISK PASSWORDS, FUJITSU COMPUTER SYSTEMS WILL NOT BE ABLE TO RESET IT. YOU MAY LOSE DATA AND HAVE TO REPLACE YOUR SYSTEM BOARD OR HARD DISK DRIVE.

## BIOS Setup Utility

The BIOS Setup Utility is a program that sets up the operating environment for your LifeBook notebook. Your BIOS is set at the factory for normal operating conditions, therefore there is no need to set or change the BIOS' environment to operate your notebook.

The BIOS Setup Utility configures:

- Device control feature parameters, such as changing I/O addresses and boot devices.
- System Data Security feature parameters, such as passwords.

## Entering the BIOS Setup Utility

To enter the BIOS Setup Utility do the following (or use the TrustedCore Menu, as detailed in the next section):

- 1** Turn on or restart your LifeBook notebook.
- 2** To enter the BIOS Setup Utility, press the [F2] key once the Fujitsu logo appears on the screen. This will open the main menu of the BIOS Setup Utility with the current settings displayed.
- 3** Press the [RIGHT ARROW] or [LEFT ARROW] key to scroll through the other setup menus to review or alter the current settings.

## Using the TrustedCore Menu

When the Fujitsu logo appears on the screen. press the [Enter] key or click on the left mouse or touchpad button; the TrustedCore Menu will appear.

The TrustedCore Menu provides shortcuts to the following menus and information screens:

- BIOS Setup
- Diagnostic Screen
- Boot Menu
- Diagnostic Program
- Patent Information
- System Information
- Continue Booting

Clicking on any of the fields will invoke the screen, information, or action described.

The Boot Menu can also be invoked by pressing the [F12] key when the Fujitsu logo appears on the screen.

## **BIOS Guide**

A guide to your notebook's BIOS is available online. Please visit our service and support website at <http://www.computers.us.fujitsu.com/support>, then select User's Guides under Online Support. Select your Product, Series, and Model, then click [Go]. Under the Manuals tab, select the BIOS Guide.

## **Booting the System**

We strongly recommend that you not attach any external devices until you have gone through the initial power on sequence.

When you turn on your notebook for the first time, it will display a Fujitsu logo on the screen. If you do nothing the system will load the operating system, and then the Windows Welcome will begin.

Depending upon your operating system (Windows Vista or XP edition), there is a different procedure for starting your system for the first time, as outlined below.



## Starting Windows Vista the first time



**THE FIRST TIME YOU INITIALIZE YOUR WINDOWS VISTA SYSTEM, THE SCREEN WILL BE BLANK FOR APPROXIMATELY TWO MINUTES.** THIS IS NORMAL. AFTER INITIALIZATION, A "SET UP WINDOWS" DIALOG BOX WILL APPEAR.

**IMPORTANT:** DURING THE SETUP PROCEDURE, DO NOT DISCONNECT THE POWER SUPPLY, PRESS ANY BUTTONS, OR USE ANY PERIPHERAL DEVICES SUCH AS A MOUSE, KEYBOARD, OR REMOTE CONTROL.

In order to ensure that you receive the most benefits from the Windows Vista operating system, it should be registered the first time you use it.

- 1 First of all, you will need to read and accept the End User License Agreements (EULAs).



- IF YOU REJECT THE TERMS OF THE LICENSE AGREEMENTS YOU WILL BE ASKED TO REVIEW THE LICENSE AGREEMENTS FOR INFORMATION ON RETURNING TO WINDOWS OR TO SHUT DOWN YOUR LIFEBOOK NOTEBOOK.
- YOU CANNOT USE YOUR NOTEBOOK UNTIL YOU HAVE ACCEPTED THE LICENSE AGREEMENTS. IF YOU STOP THE PROCESS YOUR NOTEBOOK WILL RETURN TO THE BEGINNING OF THE WINDOWS WELCOME PROCESS, EVEN IF YOU SHUT YOUR NOTEBOOK DOWN AND START IT UP AGAIN.

- 2 You will be prompted to enter your User Name and Password and you will be given a chance to select an icon for your account.
- 3 The next screen asks for a Computer Name and allows you to choose a desktop background.
- 4 You will next see a "Help protect Windows automatically" screen in which the default choice is "Use recommended settings". The other two choices are "Install important updates only" and "Ask me later". Select from the three choices.
- 5 On the next screen set your time and date settings.
- 6 You will next see the "Select your computer's current location" screen. Make your selection from Home, Work (Default), and Public location.
- 7 The "Thank you" screen follows and an offer for free Norton Internet Security is extended. Following are several screens while Windows checks the system performance.

- 8 Windows will then boot up for the first time. As noted above, the first time you initialize your Windows Vista system, the screen will be blank for approximately two minutes. This is normal. During this period, do not disconnect the power supply, press any buttons, or use any peripheral devices such as mouse, keyboard, or remote control.

### **Registering Windows Vista with Microsoft**

- 1 After Windows has booted up for the first time, the Control Panel Welcome Center will appear. If the Register Windows Online icon is not seen in the window, click on “Show all xx items” (where “xx” is the number of topics in the Welcome Center).
- 2 Click on Register Windows Online and follow the instructions that appear to register your copy of Windows.

### **Starting Windows XP the First Time**

#### **Registering Windows XP with Microsoft**

In order to ensure that you receive the most benefits from the Windows operating system, it should be registered the first time you use it.

After you receive the Windows Welcome screen, you will be prompted to enter registration information in the following order.

First of all, you will need to read and accept the End User License Agreements (EULAs). After accepting the EULAs, you will be asked if you want to enable the Automatic Updates feature. Acceptance of this feature is recommended because it allows your system to be updated automatically whenever an important change becomes available for your notebook.



- IF YOU REJECT THE TERMS OF THE LICENSE AGREEMENT YOU WILL BE ASKED TO REVIEW THE LICENSE AGREEMENT FOR INFORMATION ON RETURNING WINDOWS OR TO SHUT DOWN YOUR LIFEBOOK NOTEBOOK.
- YOU CANNOT USE YOUR LIFEBOOK NOTEBOOK UNTIL YOU HAVE ACCEPTED THE LICENSE AGREEMENT. IF YOU STOP THE PROCESS YOUR NOTEBOOK WILL RETURN TO THE BEGINNING OF THE WINDOWS WELCOME PROCESS, EVEN IF YOU SHUT YOUR NOTEBOOK DOWN AND START IT UP AGAIN.

Several additional windows will appear, prompting you to enter a name and description for your computer, an Administrator password, and a domain name. Read the instructions on the screens carefully and fill in the information as directed.

You will then be automatically connected to the Internet, if you have an appropriate connection available. If an automatic connection is not possible, you will be asked about how you dial out from where you will be using your LifeBook notebook. If you are not connected to a phone line and plan to register at a later time, you may click the **Skip** button.

Once you are connected to the Internet, you will be asked if you wish to continue with the registration. If you select **Yes** you will then enter your name and address, and email address if desired. Click **Next** to complete registration.

## Registering Your LifeBook notebook with Fujitsu

You will need to be set up with an Internet Service Provider (ISP) to register online. You can register your LifeBook by going to our website at: **[us.fujitsu.com/computers](http://us.fujitsu.com/computers)**



### Installing ClickMe!



BEFORE INSTALLING THE CLICKME! UTILITY, BE SURE THE WIRELESS LAN SWITCH IS TURNED ON.

## Windows Vista Systems

The first time you boot up your system, you will see a “Primary Settings for the PC” window. This window explains the installations which will be performed by the Click Me! utility. If you click [Execute], ClickMe! will begin installing. If after clicking the button you receive a “User Account Control” window, you will be asked for your permission to continue. Click [Continue] to continue. If you cancel the operation, the ClickMe! icon will appear on your desktop for later installation.

## Windows XP Systems

The first time you boot up your system, you will see an icon called Click Me! in the Start menu. **We highly recommend that you install the ClickMe! utility the first time you boot up.** When you click the Click Me! icon, your system will automatically create the related icons in the system tray in the bottom right of the screen. These icons provide links to utilities that you will frequently access, such as wireless LAN software provided by the wireless LAN manufacturer.



THERE MAY BE SOME THIRD-PARTY APPLICATIONS THAT DO NOT GET INSTALLED USING THE CLICKME! UTILITY. FOR MORE INFORMATION, REFER TO YOUR GETTING STARTED GUIDE.



### Fujitsu Driver Update Utility

Your system has a convenient tool called the Fujitsu Driver Update (FDU) utility. With FDU, you can choose to automatically or manually go to the Fujitsu site to check for new updates for your system. For more information about the FDU utility, refer to “Automatically Downloading Driver Updates” on page 83.

## Power Management

Your LifeBook notebook has many options and features for conserving battery power. Some of these features are automatic and need no user intervention. However, others depend on the parameters you set to best suit your operating conditions, such as those for the display brightness. Internal power management for your notebook may be controlled from settings made in your operating system, pre-bundled power management application, or from settings made in BIOS setup utility.



PLEASE NOTE THAT “STANDBY MODE” IN WINDOWS XP IS KNOWN AS “SLEEP MODE” IN WINDOWS VISTA. THE TWO TERMS ARE INTERCHANGEABLE. FOR PURPOSES OF THIS DOCUMENT, “STANDBY MODE” WILL BE USED.

Besides the options available for conserving battery power, there are also some things that you can do to prevent your battery from running down as quickly. For example, you can create an appropriate power saving profile, put your notebook into Standby (Sleep) mode when it is not performing an operation, and you can limit the use of high power devices. As with all mobile, battery powered computers, there is a trade-off between performance and power savings.

### Power/Suspend/Resume Button

When your notebook is active, the Power/Suspend/Resume button can be used to manually put the notebook into Standby mode. Push the Power/Suspend/Resume button when the notebook is active, but not actively accessing anything, and immediately release the button.

If your notebook is suspended, pushing the Power/Suspend/Resume button returns your notebook to active operation. You can tell whether the system is Suspended by looking at the Power indicator. If the indicator is visible and not flashing, your notebook is fully operational. If the indicator is visible *and* flashing, your notebook is in Standby mode. If the indicator is not visible, the power is off or your notebook is in Hibernation mode. (*See Hibernation Feature*)

## Standby (Sleep) Mode

Standby (Sleep) mode in Windows saves the contents of your system memory during periods of inactivity by maintaining power to critical parts. This mode turns off the CPU, display, hard drive, and all other internal components except those necessary to maintain system memory and for restarting.

Your notebook can be put in Standby mode by:

- Pressing the Power/Suspend/Resume button when your system is turned on.
- Selecting Standby (“Sleep” in Windows Vista) from the Windows Shut Down menu.
- Timing out from lack of activity.
- Allowing the battery to reach the Dead Battery Warning condition.

System memory typically stores the file on which you are working, open application information, and any other data required to support operations in progress. When you resume operation from Standby, your system will return to where it left off. You must use the Power/Suspend/Resume button to resume operation, and there must be an adequate power source available, or your notebook will not resume.



- IF RUNNING YOUR NOTEBOOK ON BATTERY POWER, BE AWARE THAT THE BATTERY CONTINUES TO DISCHARGE WHILE YOUR NOTEBOOK IS IN STANDBY MODE, THOUGH NOT AS FAST AS WHEN FULLY OPERATIONAL.
- DISABLING THE POWER/SUSPEND/RESUME BUTTON PREVENTS IT FROM BEING USED TO PUT THE NOTEBOOK INTO STANDBY OR HIBERNATION (SAVE-TO-DISK) MODE. THE BUTTON RESUME FUNCTION CAN'T BE DISABLED.
- THE STANDBY OR HIBERNATION (SAVE-TO-DISK) MODE SHOULD NOT BE USED WITH CERTAIN PC CARDS. CHECK YOUR PC CARD DOCUMENTATION FOR MORE INFORMATION. WHEN PC CARDS OR EXTERNAL DEVICES ARE IN USE, HIBERNATION (SAVE-TO-DISK) MODE CANNOT RETURN TO THE EXACT STATE PRIOR TO SUSPENSION, BECAUSE ALL OF THE PERIPHERAL DEVICES WILL BE RE-INITIALIZED WHEN THE SYSTEM RESTARTS.
- IF YOUR NOTEBOOK IS ACTIVELY ACCESSING INFORMATION WHEN YOU ENTER THE STANDBY OR HIBERNATION MODE, CHANGES TO OPEN FILES ARE NOT LOST. THE FILES ARE LEFT OPEN AND MEMORY IS KEPT ACTIVE DURING STANDBY MODE OR THE MEMORY IS TRANSFERRED TO THE INTERNAL HARD DRIVE DURING HIBERNATION MODE. THE MAIN ADVANTAGE OF USING HIBERNATION (SAVE-TO-DISK) IS THAT POWER IS NOT REQUIRED TO MAINTAIN YOUR DATA. THIS IS PARTICULARLY IMPORTANT IF YOU WILL BE LEAVING YOUR NOTEBOOK IN A SUSPENDED STATE FOR A PROLONGED PERIOD OF TIME. THE DRAWBACK OF USING HIBERNATION MODE IS THAT IT LENGTHENS THE POWER DOWN AND POWER UP SEQUENCES AND RESETS PERIPHERAL DEVICES.

## Hibernation (Save-to-Disk) Feature

The Hibernation feature saves the contents of your notebook's system memory to the hard drive as a part of the Power/Suspend/Resume mode. You can enable or disable this feature.

### Enable or Disable the Hibernation Feature

**Windows Vista:** The default settings are not enabled. To enable or disable the Hibernation feature follow these steps:

- 1 From the Start menu, select Control Panel, then select the Power Options icon.
- 2 Select "Choose what the power button does" or "Choose what closing the lid does", then make your selections (Do Nothing, Sleep, Hibernate, or Shut Down).

**Windows XP:** The default settings are not enabled. To enable or disable the Hibernation feature follow these steps:

- 1 From the Start menu, select Settings, and then select Control Panel.
- 2 From the Control Panel select Power Options.
- 3 Select the Hibernate tab. Select the box to enable or disable this feature.

## Windows Power Management

The Power Options icon in the Windows Control Panel allows you to configure some of the power management settings. For example, you can use Power Options to set the timeout values for turning off the display and hard disks whether you are running the notebook on battery or one of the adapters.

## Restarting the System

If your system is on and you need to restart it, be sure that you use the following procedure.

**Windows Vista:**

- 1 Click the [Start] button, and then move the mouse over the small arrow at the bottom right of the right-hand pane.
- 2 Select **Restart** from the list.

## Windows XP:

- 1 Click the [Start] button, and then click Turn Off Computer.
- 2 Select the **Restart** option. Your notebook will shut down and then reboot.



TURNING OFF YOUR LIFEBOOK NOTEBOOK WITHOUT EXITING WINDOWS OR TURNING ON YOUR NOTEBOOK WITHIN 10 SECONDS OF THE NOTEBOOK BEING SHUT OFF MAY CAUSE AN ERROR WHEN YOU START THE NEXT TIME.

## Powering Off

Before turning off the power, check that the hard drive/optical drive access indicator is off. If you turn off the power while accessing a disk there is a risk of data loss. To ensure that your notebook shuts down without error, use the Windows shut down procedure.



BE SURE TO CLOSE ALL FILES, EXIT ALL APPLICATIONS, AND SHUT DOWN YOUR OPERATING SYSTEM PRIOR TO TURNING OFF THE POWER. IF FILES ARE OPEN WHEN YOU TURN THE POWER OFF, YOU WILL LOSE ANY CHANGES THAT HAVE NOT BEEN SAVED, AND MAY CAUSE DISK ERRORS.

Using the correct procedure to shut down from Windows allows your notebook to complete its operations and turn off power in the proper sequence to avoid errors. The proper sequence is:

## Windows Vista:

- 1 Click the [Start] button, and then move the mouse over the small arrow at the bottom right of the right-hand pane. Select **Shut Down** from the list.

## Windows XP:

- 1 Click the [Start] button, click Turn Off Computer, and then Select the **Turn Off** option.  
If you are going to store your notebook for a month or more, see Care and Maintenance Section.



## Chapter 3

# User-Installable Features

---

## Lithium ion Battery

Your LifeBook notebook has a Lithium ion battery that provides power for operating your notebook when no external power source is available. The battery is durable and long lasting, but should not be exposed to extreme temperatures, high voltages, chemicals or other hazards.

The Lithium ion battery operating time may become shorter if it is used under the following conditions:

- When used at temperatures that exceed a low of 5°C or a high of 35°C. Extreme temperatures not only reduce charging efficiency, but can also cause battery deterioration. The Charging icon on the Status Indicator panel will flash when you try to charge a battery that is outside its operating temperature range.
- When using a high current device such as an external optical drive or the hard drive, using the AC adapter will conserve your battery life.



DO NOT LEAVE A FAULTY BATTERY IN YOUR NOTEBOOK. IT MAY DAMAGE YOUR AC ADAPTER, OPTIONAL AUTO/AIRLINE ADAPTER, ANOTHER BATTERY OR YOUR NOTEBOOK ITSELF. IT MAY ALSO PREVENT OPERATION OF YOUR NOTEBOOK BY DRAINING ALL AVAILABLE CURRENT INTO THE BAD BATTERY.



- BATTERY LIFE WILL VARY BASED ON SCREEN BRIGHTNESS, APPLICATIONS, FEATURES, POWER MANAGEMENT SETTINGS, BATTERY CONDITION AND OTHER CUSTOMER PREFERENCES. OPTICAL DRIVE OR HARD DRIVE USAGE MAY ALSO HAVE A SIGNIFICANT IMPACT ON BATTERY LIFE. THE BATTERY CHARGING CAPACITY IS REDUCED AS THE BATTERY AGES. IF YOUR BATTERY IS RUNNING LOW QUICKLY, YOU SHOULD REPLACE IT WITH A NEW ONE.
  - UNDER FEDERAL, STATE, OR LOCAL LAW IT MAY BE ILLEGAL TO DISPOSE OF BATTERIES BY PUTTING THEM IN THE TRASH. PLEASE TAKE CARE OF OUR ENVIRONMENT AND DISPOSE OF BATTERIES PROPERLY. CHECK WITH YOUR LOCAL GOVERNMENT AUTHORITY FOR DETAILS REGARDING RECYCLING OR DISPOSING OF OLD BATTERIES. IF YOU CANNOT FIND THIS INFORMATION ELSEWHERE, CONTACT YOUR SUPPORT REPRESENTATIVE AT 1-800-8FUJITSU (1-800-838-5487)
- 
- 

### Recharging the Batteries

If you want to know the condition of the Lithium ion battery, check the Battery Level indicator located on the Status Indicator panel. The indicator changes as the battery level changes.

The Lithium ion battery is recharged internally using the AC adapter or Auto/Airline adapter. To recharge the battery make sure the battery that needs to be charged is installed in your LifeBook notebook and connect the AC or Auto/Airline adapter.



MAKE SURE THAT THE PERCENTAGE CHARGE IS INDICATED BY THE BATTERY CHARGING INDICATOR ON THE STATUS INDICATOR PANEL.

There is no memory effect on the Lithium ion battery therefore you do not need to discharge the battery completely before recharging. The charge times will be significantly longer if your notebook is in use while the battery is charging. If you want to charge the battery more quickly, put your notebook into Standby mode, or turn it off while the adapter is charging the battery. (*See Power Management on page 70 for more information on Standby mode and shutdown procedure*)



USING HEAVY CURRENT DEVICES OR FREQUENT EXTERNAL OPTICAL DRIVE ACCESSES MAY PREVENT CHARGING COMPLETELY.

## Low Battery State

When the battery is running low, a low battery notification message will appear. If you do not respond to the low battery message, the batteries will continue to discharge until they are too low to operate. When this happens, your notebook will go into Standby mode. There is no guarantee that your data will be saved once the notebook reaches this point.



- ONCE THE LOW BATTERY NOTIFICATION MESSAGE APPEARS, YOU NEED TO SAVE ALL YOUR ACTIVE DATA AND PUT YOUR LIFEBOOK NOTEBOOK INTO STANDBY MODE UNTIL YOU CAN PROVIDE A NEW POWER SOURCE. YOU SHOULD PROVIDE A CHARGED BATTERY, AN AC POWER ADAPTER, OR AUTO/AIRLINE ADAPTER AS SOON AS POSSIBLE.
- WHEN YOU ARE IN STANDBY MODE THERE MUST ALWAYS BE AT LEAST ONE POWER SOURCE ACTIVE. IF YOU REMOVE ALL POWER SOURCES WHILE YOUR LIFEBOOK NOTEBOOK IS IN STANDBY MODE, ANY DATA THAT HAS NOT BEEN SAVED TO THE HARD DRIVE WILL BE LOST.

Dead Battery Suspend mode shows on the Status indicator just like the normal Standby mode. Once your notebook goes into Dead Battery Suspend mode you will be unable to resume operation until you provide a source of power either from an adapter, or a charged battery. Once you have provided power, you will need to press the Power/Suspend/Resume button to resume operation.

In Dead Battery Suspend mode, your data can be maintained for some time, but if a power source is not provided promptly, the Power indicator will stop flashing and go out, meaning you have lost the data that was not stored. Once you provide power, you can continue to use your notebook while an adapter is charging the battery.

## Shorted Batteries

The Status Indicator panel indicator associated with the Battery Level indicator displays the operating level available in that battery. If this display shows a flashing red LED, it means the battery is damaged and must be replaced so it does not damage other parts of your LifeBook notebook.

## Replacing the Battery

With the purchase of an additional battery, you can have a fully charged spare to swap with one that is not charged. There are two ways to swap batteries, cold-swapping and hot-swapping:

### Cold-swapping Batteries

To cold-swap batteries in your battery bay follow these easy steps (Figure 24):

- 1 Have a charged battery ready to install.
- 2 Shut down your notebook and disconnect the AC adapter.
- 3 While pushing the battery bay release latch, slide the battery out of the bay.
- 4 Insert a new battery into the bay, and press it in firmly so that the latch clicks into place.
- 5 Plug in the AC adapter and turn the power on.

### Hot-swapping Batteries

To hot-swap batteries in your battery bay follow these easy steps:



**BE SURE TO PLUG IN AN AC ADAPTER PRIOR TO REMOVING THE BATTERY.** THERE IS NO BRIDGE BATTERY PRESENT TO SUPPORT THE SYSTEM WHILE THE BATTERY IS BEING REPLACED. IF YOU DO NOT USE AN AC ADAPTER YOU WILL LOSE ANY UNSAVED FILES.

- 1 Plug an AC Adapter into the system and connect it to a power outlet.

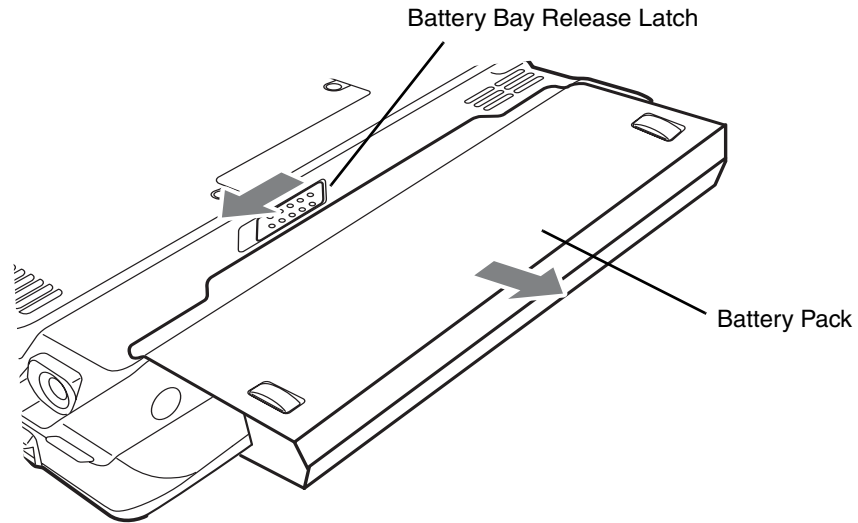
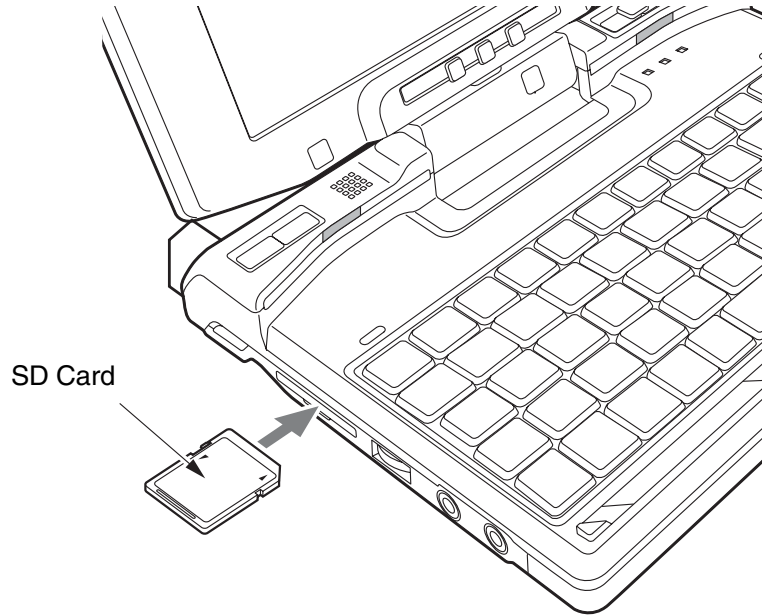

**Figure 24. Removing a Battery**

- 2** Follow steps 3 through 6 in “Cold Swapping Batteries”.



IF THE LITHIUM ION BATTERY CONNECTOR IS NOT FULLY SEATED, YOU MAY NOT BE ABLE TO USE YOUR NOTEBOOK OR CHARGE YOUR BATTERY.



**Figure 25. Installing a Secure Digital Card**

## **Secure Digital (SD) Cards**

Your LifeBook notebook supports Secure Digital (SD) cards, on which you can store and transfer data to and from a variety of digital devices. These cards use flash memory architecture, which means they don't need a power source to retain data.

Secure Digital is a flash memory technology that allows portable storage among a variety of devices, such as cell phones, GPS systems, digital cameras, and PDAs. SD Cards transfer data quickly, with low battery consumption.

## Inserting an SD Card

SD Cards are inserted in the SD Card slot. To install an SD Card, follow these steps:



INSTALLING OR REMOVING AN SD CARD DURING YOUR LIFEBOOK NOTEBOOK'S SHUTDOWN OR BOOTUP PROCESS MAY DAMAGE THE CARD AND/OR YOUR LIFEBOOK NOTEBOOK.

DO NOT INSERT A CARD INTO A SLOT IF THERE IS WATER OR ANY OTHER SUBSTANCE ON THE CARD AS YOU MAY PERMANENTLY DAMAGE THE CARD, YOUR LIFEBOOK NOTEBOOK, OR BOTH.

- 1** See your specific card manual for instructions on the installation of your card. Some cards may require that your notebook is off while installing them.
- 2** Make sure there is no card currently in the slot. If there is, see Removing an SD Card.
- 3** Insert your card into the slot with the product label facing up.
- 4** Push the card firmly into the slot until it is seated in the connector.

## Removing an SD Card

To remove an SD Card, follow these easy steps:



SEE YOUR CARD MANUAL FOR SPECIFIC INSTRUCTIONS ON THE REMOVAL OF YOUR CARD. SOME CARDS MAY REQUIRE YOUR LIFEBOOK NOTEBOOK TO BE IN STANDBY MODE OR OFF WHILE REMOVING THEM.

- 1** Select Safely Remove Hardware from the System Tray. Highlight the card in the list, then click [Stop].
- 2** Push the SD Card in until it unlatches. It will then eject from the slot for removal.

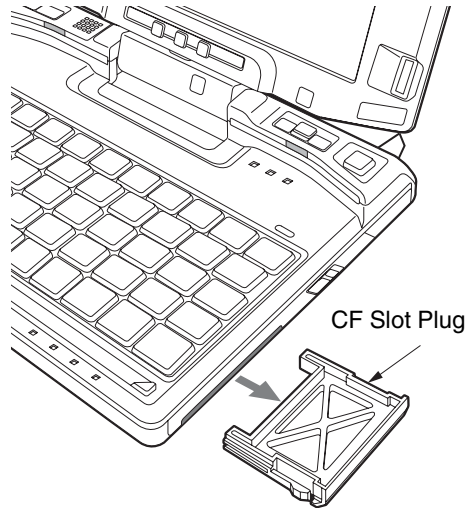

**Figure 26. Removing CF Card Slot Plug**

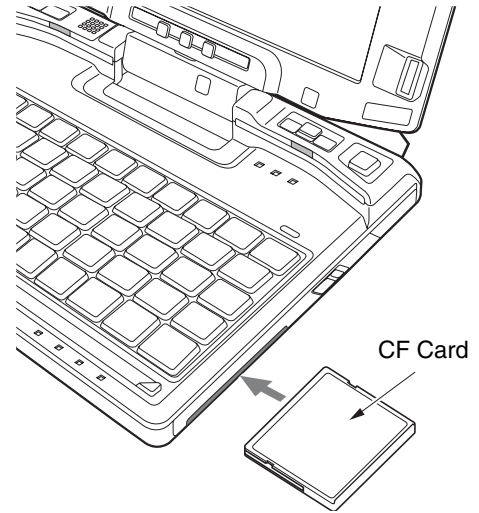

**Figure 27. Inserting CF Card**

## Compact Flash (CF) Cards

Your Fujitsu LifeBook notebook supports Compact Flash (CF) cards, which can perform a variety of functions.

Some available Compact Flash Cards include:

- Memory cards
- Fax/data modem cards
- Local area network (LAN) cards

For further information, refer to the instructions supplied with your PC Card.



## Inserting Compact Flash Cards

Compact Flash Cards are inserted in the Compact Flash Card slot. To insert a Compact Flash Card, follow these steps:



- INSERTING OR REMOVING A COMPACT FLASH CARD DURING YOUR LIFEBOOK NOTEBOOK'S SHUTDOWN OR BOOTUP PROCESS MAY DAMAGE THE CARD AND/OR YOUR NOTEBOOK.
- DO NOT INSERT A COMPACT FLASH CARD INTO A SLOT IF THERE IS WATER OR ANY OTHER SUBSTANCE ON THE CARD AS YOU MAY PERMANENTLY DAMAGE THE CARD, YOUR LIFEBOOK NOTEBOOK, OR BOTH.

- 1** See your Compact Flash Card manual for specific instructions on the insertion of your card. Some Compact Flash Cards may require your notebook to be Off while inserting them.
- 2** When you receive your LifeBook, there will be a protective plug inserted in the slot (Figure 26). Whenever you don't have a Compact Flash Card inserted, be sure to replace the plug to prevent system contamination. To remove the plug, simply pull it out from the slot.
- 3** Insert your Compact Flash Card into the slot, with the product label facing up (Figure 27).
- 4** Push the card into the slot firmly until it is seated in the opening.

## Removing Compact Flash Cards

To remove a Compact Flash Card, follow these easy steps:



WINDOWS HAS A SHUTDOWN PROCEDURE FOR COMPACT FLASH CARDS THAT MUST BE FOLLOWED BEFORE REMOVING A CARD. (PLEASE REVIEW YOUR OPERATING SYSTEM MANUAL FOR THE CORRECT PROCEDURE). IT IS GOOD PRACTICE TO REMOVE DEVICES USING THE SAFELY REMOVE HARDWARE ICON IN THE SYSTEM TRAY.

- 1** See your Compact Flash Card manual for specific instructions on removing your card. Some Compact Flash Cards may require your notebook to be in Standby Mode or Off while removing them.



IF THE DIALOG BOX STATES THAT THE DEVICE CANNOT BE REMOVED, YOU MUST SAVE ALL OF YOUR OPEN FILES, CLOSE ANY OPEN APPLICATIONS AND SHUT DOWN YOUR NOTEBOOK.

- 2** With a fingernail, pull the Compact Flash Card out of the slot using the lip on the bottom of the card.

## Device Ports

Your Fujitsu LifeBook notebook and the optional Port Replicator come equipped with multiple ports to which you can connect external devices including: disk drives, keyboards, printers, etc.

The following table indicates the ports on the system and/or the port replicator.

Port Type	Notebook Quantity	Port Replicator Quantity
USB 2.0	1	4
DC In	1	1
Headphone Jack	1	0
Microphone Jack	1	0
External Video Connector	1*	1
LAN connector (RJ-45)	1*	1
Port Replicator Connector	1	1

\* When used in conjunction with Port Replicator connector and included external monitor/LAN adapter cable.

### Universal Serial Bus Ports

The Universal Serial Bus 2.0 ports (USB) allow you to connect USB devices such as external game pads, pointing devices, keyboards and/or speakers. There is one USB 2.0 port on your notebook: four on the optional port replicator.

In order to connect a USB device follow these steps:

- 1 Open the USB cover on the right side of the system.

- 2 Align the connector with the port opening.
- 3 Push the connector into the port until it is seated..

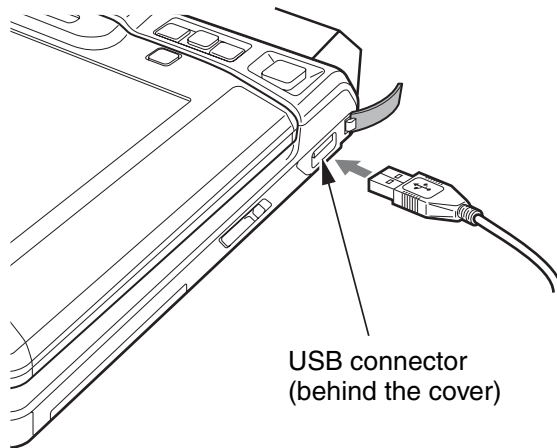

**Figure 28. Connecting USB to System**

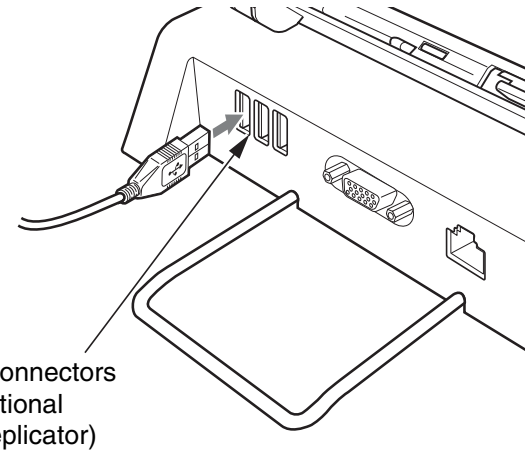

**Figure 29. Connecting USB to Port Replicator**



DUE TO ONGOING CHANGES IN USB TECHNOLOGY AND STANDARDS, NOT ALL USB DEVICES AND/OR DRIVERS ARE GUARANTEED TO WORK.

### **Headphone Jack**

The headphone jack allows you to connect headphones or powered external speakers to your notebook. Your headphones or speakers must be equipped with a 1/8" (3.5 mm) stereo mini-plug. In order to connect headphones or speakers follow these easy steps:

- 1 Align the connector with the port opening.
- 2 Push the connector into the port until it is seated.

## Microphone Jack

The microphone jack allows you to connect an external mono microphone. Your microphone must be equipped with a 1/8" (3.5 mm) mono mini-plug in order to fit into the microphone jack of your notebook. In order to connect a microphone follow these easy steps:

- 1 Align the connector with the port opening.
- 2 Push the connector into the port until it is seated.

## External Video Port

The external video port allows you to connect an external monitor or LCD projector. Note that in order to use an external video device directly with the system, you must first attach the included external video/LAN adapter cable. When connecting an external video device with the optional port replicator, it can be connected directly to the dedicated port on the port replicator.

In order to connect an external video device, follow these easy steps:

### Connecting external video to the system

- 1 If connecting directly to the system, first connect the external video/LAN adapter cable to the port replicator connector at the front of the system (Figure 30). Align the cable connector with the port replicator connector and push the connector into the port until it is seated.
- 2 Align the external video cable to the adapter cable. Tighten the two hold-down screws, located on each side of the connector.



PRESSING THE [FN] + [A] KEYS ALLOWS YOU TO CHANGE YOUR SELECTION OF WHERE TO SEND YOUR DISPLAY VIDEO. EACH TIME YOU PRESS THE KEY COMBINATION, YOU WILL STEP TO THE NEXT CHOICE, STARTING WITH THE BUILT-IN DISPLAY PANEL ONLY, MOVING TO THE EXTERNAL MONITOR ONLY, FINALLY MOVING TO BOTH THE BUILT-IN DISPLAY PANEL AND AN EXTERNAL MONITOR.

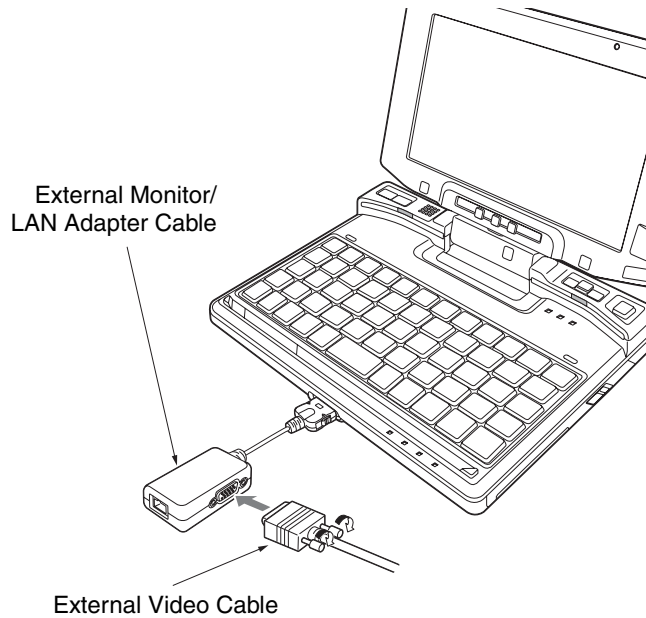

**Figure 30. Connecting External Video to System**

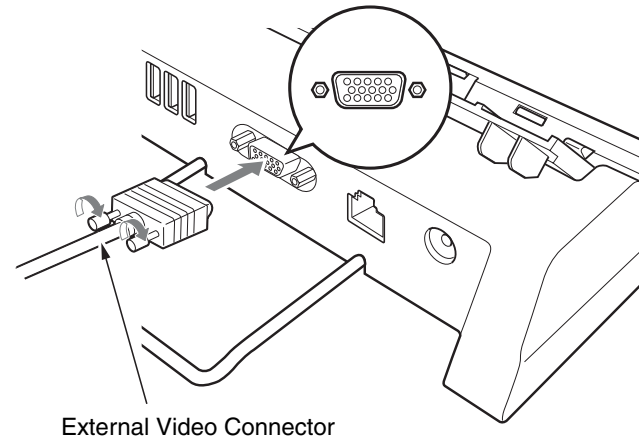

**Figure 31. Connecting to Port Replicator**

### Connecting external video to the optional port replicator

- 1** If connecting directly to the optional port replicator, align the external video cable to the connector on the port replicator (Figure 31).
- 2** Tighten the two hold-down screws, located on each side of the connector.

## LAN (RJ-45) Jack

Note that in order to use the internal LAN device directly with the system, you must first attach the included external video/LAN adapter cable. When connected with the optional port replicator, you can connect directly to the dedicated LAN port on the port replicator

The LAN (RJ-45) jack is used for a 10Base-T/100Base-Tx Ethernet LAN connection. You may need to configure your notebook to work with your particular network. (Please refer to your network administrator for information on your network configuration.)

To connect the LAN cable follow these easy steps:

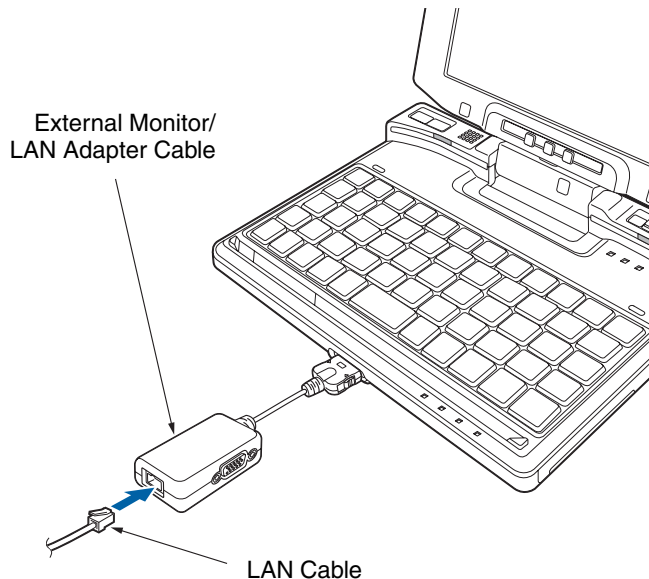

**Figure 32. Connecting the LAN and Adapter**

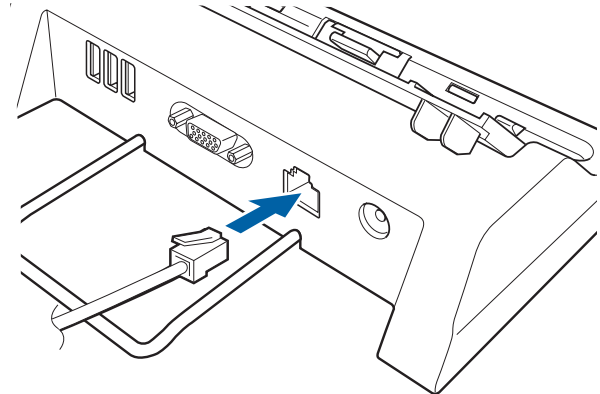

**Figure 33. Connecting the LAN/Port Replicator**

## Connecting directly to the internal LAN

- 1 If connecting directly to the system, first connect the external video/LAN adapter cable to the port replicator connector at the front of the system (Figure 32). Align the cable connector with the port replicator connector and push the connector into the port until it is seated.
- 2 Align the LAN connector with the port opening.
- 3 Push the connector into the port until it is seated.
- 4 Plug the other end of the cable into a LAN outlet.

## Connecting to the internal LAN via optional Port Replicator

- 1 Align the LAN connector with the port opening on the rear of the port replicator (Figure 33).
- 2 Push the connector into the port until it is seated.
- 3 Plug the other end of the cable into a LAN outlet.

## Port Replicator Connector

The port replicator connector is used for the connection of your notebook to an optional port replicator or for connection of the external video/LAN adapter cable. In order to connect your notebook to this device, follow the instructions that came with your port replicator.





## Chapter 4

# Troubleshooting Your LifeBook

---

## Troubleshooting

There may be occasions when you encounter simple setup or operating problems that you can solve on the spot, or problems with peripheral devices that can be solved by replacing the device. The information in this section helps you isolate and resolve some of these straightforward issues and identify failures that require service.

### Identifying the Problem

If you encounter a problem, go through the following procedure before pursuing complex troubleshooting:

- 1 Turn off your LifeBook notebook.
- 2 Make sure the AC adapter is plugged into your notebook and to an active AC power source.
- 3 Make sure that any card installed in the PC Card slot is seated properly. You can also remove the card from the slot, thus eliminating it as a possible cause of failure.
- 4 Make sure that any devices connected to the external connectors are plugged in properly. You can also disconnect such devices, thus eliminating them as possible causes of failure.
- 5 Turn on your notebook. Make sure it has been off at least 10 seconds before you turn it back on.
- 6 Go through the boot sequence.

- 7 If the problem has not been resolved, refer to the Troubleshooting Table that follows for more detailed troubleshooting information.



IF YOU KEEP NOTES ABOUT WHAT YOU HAVE TRIED, YOUR SUPPORT REPRESENTATIVE MAY BE ABLE TO HELP YOU MORE QUICKLY BY GIVING ADDITIONAL SUGGESTIONS OVER THE PHONE.

- 8 If you have tried the solutions suggested in the Troubleshooting Table without success, contact your support representative:

Toll free: 1-800-8Fujitsu (1-800-838-5487)

E-mail: [8fujitsu@us.fujitsu.com](mailto:8fujitsu@us.fujitsu.com)

Web site: <http://www.computers.us.fujitsu.com/support>.

Before you place the call, you should have the following information ready so that the customer support representative can provide you with the fastest possible solution:

- Product name
- Product configuration number
- Product serial number
- Purchase date
- Conditions under which the problem occurred
- Any error messages that have occurred
- Type of device connected, if any

See the Configuration Label on the bottom of your notebook for configuration and serial numbers.

## Specific Problems

### Using the Troubleshooting Table

When you have problems with your LifeBook notebook, try to find the symptoms under the Problem column of the troubleshooting table for the feature giving you difficulty. You will find a description of common causes for that symptom under the column Possible Cause and what, if anything, you can do to correct the condition under Possible Solutions. All possible causes or solutions may not apply to your notebook.

### Troubleshooting Table

<b>Problem</b>	<b>Page</b>	<b>Problem</b>	<b>Page</b>
Audio Problems . . . . .	page 93	Modem Problems	page 95
Optical Drive Problems . . . . .	page 93	USB Device Problems . . . . .	page 95
Port Replicator Problems . . . . .	page 94	Power Failures . . . . .	page 96
Hard Drive Problems . . . . .	page 94	Shutdown and Startup Problems . . . . .	page 98
Keyboard or Mouse Problems . . . . .	page 94	Video Problems . . . . .	page 99
Memory Problems . . . . .	page 95	Miscellaneous Problems . . . . .	page 101

Problem	Possible Cause	Possible Solutions
<b>Audio Problems</b>		
There is no sound coming from the built-in speaker.	The volume is turned too low.	Adjust the volume control on the left side of your notebook
	Headphones are plugged into your notebook.	Plugging in headphones disables the built-in speakers. Remove the headphones.
	BIOS audio settings are incorrect.	Set the BIOS setup utility to the desired level (Off, Minimum, Middle, or Maximum) within the Miscellaneous Configurations submenu of the Advanced menu. <i>See “BIOS Setup Utility” on page 64.</i>
	Software driver is not configured correctly.	The audio driver may be installed or reinstalled using the Drivers and Applications CD that came with your Fujitsu LifeBook. Refer to your application and operating system documentation for help.
	The speakers have been muted using the Volume icon in the system tray.	Click on the Volume icon in the system tray on the bottom right of the screen. (It looks like a speaker). If the Mute box is checked (Windows XP) or the Mute icon has a red circle on it (Windows Vista), click on it to unselect it.
<b>Optical Drive Problems (optional external device)</b>		
LifeBook notebook fails to recognize optical discs.	The disc is not pushed down onto raised center circle of the drive.	Open optical drive tray and re-install the disc properly.
	Optical drive tray is not latched shut.	Push on the front of the optical drive tray until it latches. If that doesn't work, pull out the modular drive latch to remove the device from the bay, then re-insert the drive until it latched; this ensures that the drive is properly seated.
	Incorrect DVD Player or no DVD Player software is installed.	Install DVD Player software.

<b>Problem</b>	<b>Possible Cause</b>	<b>Possible Solutions</b>
LifeBook notebook fails to recognize optical discs.  (continued)	Wrong drive designator was used for the disc in the application.	Verify the drive designator used by the application is the same as the one used by the operating system. When the operating system is booted from a DVD/CD, drive designations are automatically adjusted. Note that the drive designation can be changed with the Disk Management tool located at Administrative Tools -> Computer Management.
	DVD/CD-RW/CD-ROM is dirty or defective.	Wipe the disc with a non-abrasive CD cleaning cloth and reinsert. If it still will not work try another DVD/CD-RW/CD-ROM in the drive.
<b>Port Replicator Problems</b>		
Notebook does not turn on when installed in the optional Port Replicator	Port Replicator AC adapter is not plugged in.	Provide power to the Port Replicator.
	Notebook is not properly seated in the Port Replicator.	Remove and re-dock your LifeBook notebook.
<b>Hard Drive Problems</b>		
You cannot access your hard drive.	The wrong drive designator was used by an application when a bootable disc was used to start the notebook.	Verify drive designator used by application is in use by the operating system. When the operating system is booted from a CD, drive designations are automatically adjusted.
	Security is set so your operating system cannot be started without a password.	Verify your password and security settings.
<b>Keyboard or Mouse Problems</b>		
The built-in keyboard does not seem to work.	The notebook has gone into Standby mode.	Push the <b>Power/Suspend/Resume</b> button.
	Your application has locked out your keyboard.	Try to use your integrated pointing device to restart your system.

<b>Problem</b>	<b>Possible Cause</b>	<b>Possible Solutions</b>
You have installed an external keyboard or mouse, and it does not seem to work.	Your external device is not properly installed.	Re-install your device. See <i>“Device Ports” on page 84.</i>
	Your operating system is not set up with correct software driver for that device.	Check your device and operating system documentation and activate the proper driver.
You have connected an external keyboard or a mouse and it seems to be locking up the system.	Your operating system is not set up with correct software driver for that device.	Check your device and operating system documentation and activate the proper driver.
	Your system has crashed.	Try to restart your notebook. I
<b>Memory Problems</b>		
Your System screen in the Control Panel does not show the correct amount of installed memory.	You have a memory failure.	Check for Power On Self Test (POST) messages. See <i>“Power On Self Test Messages” on page 102.</i>
<b>Modem Problems (optional device)</b>		
Messages about modem operation.	Messages about modem operation are generated by whichever modem application is in use.	See your application software documentation for additional information.
<b>USB Device Problems</b>		
You have installed a USB device. Your LifeBook notebook does not recognize the device, or the device does not seem to work properly.	The device is not properly installed.	Remove and re-install the device. See <i>“Device Ports” on page 84.</i>

Problem	Possible Cause	Possible Solutions
<p>You have installed a USB device. Your LifeBook notebook does not recognize the device, or the device does not seem to work properly.</p> <p>(continued)</p>	<p>The device may have been installed while an application was running, so your notebook is not aware of its installation.</p>	<p>Close the application and restart your notebook.</p>
	<p>Your device may not have the correct software driver active.</p>	<p>See your software documentation and activate the correct driver.</p>
	<p>You may have the wrong I/O address selected for your device.</p>	<p>See your device and software documentation to determine the required I/O address. Change the settings in the BIOS setup utility. See <i>"BIOS Setup Utility"</i> on page 64.</p>
	<p>Your device and another device are assigned the same I/O address.</p>	<p>Check all I/O addresses located within the BIOS setup utility and any other installed hardware or software to make sure there are no duplications.</p>
<p><b>Power Failures</b></p>		
<p>You turn on your LifeBook notebook and nothing seems to happen.</p>	<p>The installed battery is completely discharged or there is no Power adapter (AC or Auto/Airline) installed.</p>	<p>Check the Status Indicator Panel to determine the presence and condition of the battery. See <i>"Status Indicator Panel"</i> on page 30. Install a charged battery or a Power adapter.</p>
	<p>The battery is installed but is faulty.</p>	<p>Use the Status Indicator panel to verify the presence and condition of the battery. See <i>"Status Indicator Panel"</i> on page 30. If the battery indicates a short, remove it and operate from another power source or replace that battery.</p>
	<p>The battery is low.</p>	<p>Check the Status Indicator Panel to determine the presence and condition of the battery. See <i>"Status Indicator Panel"</i> on page 30. Use a Power adapter to operate until a battery is charged or install a charged battery.</p>
	<p>The power adapter (AC or auto/airline) is not plugged in properly.</p>	<p>Verify that your adapter is connected correctly. See <i>"Power Sources"</i> on page 60.</p>

<b>Problem</b>	<b>Possible Cause</b>	<b>Possible Solutions</b>
You turn on your LifeBook notebook and nothing seems to happen. (continued)	The power adapter (AC or auto/airline) has no power from the AC outlet, airplane jack, or car cigarette lighter.	Move the AC cord to a different outlet, check for a line switch or tripped circuit breaker for the AC outlet. If you are using an auto/airline adapter in a car make sure the ignition switch is in the On or Accessories position.
	The power adapter (AC or auto/airline) is faulty.	Try a different power adapter.
Your LifeBook notebook turns off all by itself.	The power management parameters are set for auto timeouts which are too short for your operating needs.	Press any button on the keyboard, or move the mouse to restore operation. If that fails, push the Power/ Suspend/ Resume button. Check your power management settings, or close your applications and go to the Power Options located in the Control Panel to adjust the timeout values to better suit your needs.
	You are operating on battery power and ignored a low battery alarm until the battery was at the dead battery state and the system has entered Dead Battery Suspend mode.	Install a power adapter, then push the Power/Suspend/Resume button. <i>See "Power Sources" on page 60.</i>
	You have a battery failure.	Verify the condition of the battery using the Status Indicator panel. If the battery is shorted, replace or remove it. <i>See "Status Indicator Panel" on page 30.</i>
	Your power adapter has failed or lost its power source.	Make sure the adapter is plugged in and the outlet has power.
Your LifeBook notebook will not work on battery alone.	The installed battery is dead.	Replace the battery with a charged one or install a power adapter.
	No battery is installed.	Install a charged battery.
	The battery is improperly installed.	Verify that the battery is properly connected by re-installing it.



<b>Problem</b>	<b>Possible Cause</b>	<b>Possible Solutions</b>
Your LifeBook notebook will not work on battery alone.  (continued)	Your installed battery is faulty.	Verify the condition of the battery using the Status Indicator panel and replace or remove any batteries that are shorted. <i>See "Status Indicator Panel" on page 30.</i>
The battery seems to discharge too quickly.	You are running an application that uses a lot of power due to frequent hard drive access or optical drive access, or use of a modem, LAN PC card, Wireless LAN, or Bluetooth device.	Use a power adapter for this application when at all possible.
	The power savings features may be disabled.	Check the Power Options menu settings and adjust according to your operating needs.
	The brightness is turned all the way up.	Turn down the brightness adjustment. The higher the brightness the more power your display uses.
	The battery is very old.	Replace the battery.
	The battery has been exposed to high temperatures.	Replace the battery.
	The battery is too hot or too cold.	Restore the notebook to normal operating temperature. Charging icon on the Status Indicator panel will flash when battery is outside of operating range.
<b>Shutdown and Startup Problems</b>		
The Power/Suspend/Resume button does not work.	Power/Suspend/Resume button is disabled.	In Windows XP, enable the button by going to the Control Panel -> Power Options Properties and clicking on the Advanced tab. In the Power buttons area, select the option that best suits your needs. In Windows Vista, select the "Change what the power button does" option.

Problem	Possible Cause	Possible Solutions
<p>The Power/Suspend/Resume button does not work.</p> <p>(continued)</p>	<p>There may be application software conflict</p>	<p>Close all applications and try the button again.</p>
<p>The system powers up, and displays power on information, but fails to load the operating system.</p>	<p>The boot sequence settings of the setup utility are not compatible with your configuration.</p>	<p>Set the operating source by pressing the [ESC] key while the Fujitsu logo is on screen or use the [F2] key and enter the setup utility and adjust the source settings from the Boot menu. See <i>“BIOS Setup Utility” on page 64.</i></p>
	<p>You have a secured system requiring a password to load your operating system.</p>	<p>Make sure you have the right password. Enter the setup utility and verify the Security settings and modify them as accordingly. See <i>“BIOS Setup Utility” on page 64.</i></p>
<p>An error message is displayed on the screen during the notebook (boot) sequence.</p>	<p>Power On Self Test (POST) has detected a problem.</p>	<p>See the Power On Self Test (POST) messages to determine the meaning and severity of the problem. Not all messages are errors; some are simply status indicators. See <i>“Power On Self Test Messages” on page 102.</i></p>
<p>Your notebook appears to change setup parameters when you start it.</p>	<p>BIOS setup changes were not saved when made and you exited the setup utility.</p>	<p>Make sure you select <b>Save Changes And Exit</b> when exiting the BIOS setup utility.</p>
	<p>The BIOS CMOS hold-up battery has failed.</p>	<p>Contact your support representative for repairs. This is not a user serviceable part but has a normal life of 3 to 5 years.</p>
<p><b>Video Problems</b></p>		

<b>Problem</b>	<b>Possible Cause</b>	<b>Possible Solutions</b>
The built-in display is blank when you turn on your LifeBook notebook.	The notebook is set for an external monitor only.	Pressing [A] while holding down the [Fn] key allows you to change your selection of where to send your display video. Each time you press the keys you will step to the next choice. The choices, in order are: built-in display only, external monitor only, both built-in display and external monitor.
	Display angle and brightness settings are not adequate for your lighting conditions.	Move the display and the brightness control until you have adequate visibility.
The built-in display is blank when you turn on your LifeBook notebook. (continued)	Power management timeouts are set for short intervals and you didn't see the display go on and off again.	Press a keyboard button or move the mouse to restore operation. If that fails, push the Power/Suspend/Resume button. (The display may be shut off by Standby mode, Auto Suspend or Video Timeout)
The notebook turned on with a series of beeps and the built-in display is blank.	Power On Self Test (POST) has detected a failure which does not allow the display to operate.	Contact your support representative.
The display goes blank by itself after you have been using it.	The notebook has gone into Video timeout, Standby mode, or Save-to-Disk mode because you have not used it for a period of time.	Press any button on the keyboard, or move the mouse to restore operation. If that fails, push the Power/Suspend/Resume button. Check your power management settings, or close your applications and go to the Power Savings menu of the setup utility to adjust the timeout values to better suit your operation needs. See "BIOS Setup Utility" on page 64.
	The power management timeouts may be set for very short intervals and you failed to notice the display come on and go off again.	Press any button on the keyboard, or move the mouse to restore operation. If that fails, push the Power/Suspend/Resume button. (The display may be shut off by Standby Mode, Auto Suspend or Video Timeout)

<b>Problem</b>	<b>Possible Cause</b>	<b>Possible Solutions</b>
The display has bright or dark spots.	If the spots are very tiny and few in number, this is normal for a large LCD display.	This is normal; do nothing.
	If the spots are numerous or large enough to interfere with your operation needs.	Display is faulty; contact your support representative.
The Display is dark when on battery power.	The Power Management utility default is set on low brightness to conserve power.	Press [Fn] + [D] to increase brightness or double-click on the battery gauge and adjust Power Control under battery settings.
You have connected an external monitor and it does not display any information.	Your BIOS setup is not set to enable your external monitor.	Toggle the video destination by pressing [Fn]+ [A] together, or check your BIOS setup and enable your external monitor. (See the Video Features submenu, located within the Advanced Menu of the BIOS. See <i>“BIOS Setup Utility”</i> on page 64.
	Your external monitor is not properly installed.	Reinstall your device. See <i>“External Video Port”</i> on page 86.
	Your operating system is not setup with the correct software driver for that device.	Check your device and operating system documentation and activate the proper driver.
You have connected an external monitor and it does not come on.	Your external monitor is not compatible with your LifeBook notebook.	See your monitor documentation and the External Monitor Support portions of the Specifications section. See <i>“Specifications”</i> on page 121.
<b>Miscellaneous Problems</b>		
Error message is displayed on the screen during the operation of an application.	Application software often has its own set of error message displays.	See your application manual and help displays screens for more information. Not all messages are errors some may simply be status.

## Power On Self Test Messages

The following is an alphabetic list of error-and-status messages that Phoenix BIOS and/or your operating system can generate and an explanation of each message. Error messages are marked with an \*. If an error message is displayed that is not in this list, write it down and check your operating system documentation both on screen and in the manual. If you can find no reference to the message and its meaning is not clear, contact your support representative for assistance.

### **nnnn Memory Cache Passed**

Where nnnn is the amount of system cache in kilobytes successfully tested by the Power On Self Test. (This can only appear if you have an SRAM PC Card installed.)

### **Floppy Disk drive A error or Floppy Disk drive B error**

Drive A: or B: is present but fails the BIOS Power On Self Test diskette tests. Check to see that the drive is defined with the proper diskette type in the Setup Utility, See “BIOS Setup Utility” on page 64. and that the diskette drive is installed correctly. If the disk drive is properly defined and installed, avoid using it and contact your support representative.

### **\*Extended Memory Failed at address line: xx**

Extended memory not working or not configured properly. If you have an installed memory upgrade module, verify that the module is properly installed. If it is properly installed, you may want to check your Windows Setup to be sure it is not using unavailable memory until you can contact your support representative.

### **nnnn Extended RAM Passed**

Where nnnn is the amount of memory in kilobytes successfully tested.

#### **\*Failure Fixed Disk n (where x=1-4)**

The fixed disk is not working or not configured properly. This may mean that the hard drive type identified in your setup utility does not agree with the type detected by the Power On Self Test. Run the setup utility to check for the hard drive type settings and correct them if necessary. If the settings are OK and the message appears when you restart the system, there may be a serious fault which might cause you to lose data if you continue. Contact your support representative.

#### **\*Incorrect Drive A type – run SETUP**

Type of floppy drive A: not correctly identified in Setup. This means that the floppy disk drive type identified in your setup utility does not agree with the type detected by the Power On Self Test. Run the setup utility to correct the inconsistency.

#### **\*Incorrect Drive B type – run SETUP**

Type of floppy drive B: not correctly identified in Setup. This means that the floppy disk drive type identified in your setup utility does not agree with the type detected by the Power On Self Test. Run the setup utility to correct the inconsistency.

#### **\*Invalid NVRAM Data**

Problem with NVRAM access. In the unlikely case that you see this message you may have some display problems. You can continue operating but should contact your support representative for more information.

#### **\*Keyboard controller error**

The keyboard controller test failed. You may have to replace your keyboard or keyboard controller but may be able to use an external keyboard until then. Contact your support representative.

#### **\*Keyboard error**

Keyboard not working. You may have to replace your keyboard or keyboard controller but may be able to use an external keyboard until then. Contact your support representative.

### **\*Stuck Key**

BIOS discovered a stuck key and displays the scan code for the stuck key. You may have to replace your keyboard but may be able to use an external keyboard until then. Contact your support representative.

### **\*Monitor type does not match CMOS – Run SETUP**

Monitor type not correctly identified in Setup. This error probably means your BIOS is corrupted, run the setup utility and set all settings to the default conditions. If you still get this error, contact your support representative.

### **\*Operating system not found**

Operating system cannot be located on either drive A: or drive C: Enter the setup utility and see if both the fixed disk, and drive A: are properly identified and that the boot sequence is set correctly. Unless you have changed your installation greatly, the operating system should be on drive C:. If the setup utility is correctly set, your hard drive may be corrupted.

### **\*Parity Check 1 nnnn**

Parity error found in the system bus. BIOS attempts to locate the address and display it on the screen. If it cannot locate the address, it displays ?????. This is a potentially data destroying failure. Contact your support representative.

### **\*Parity Check 2 nnnn**

Parity error found in the I/O bus. BIOS attempts to locate the address and display it on the screen. If it cannot locate the address, it displays ?????. This is a potentially data-destroying failure. Contact your support representative.

**\*Press <F1> to resume, <F2> to SETUP**

Displayed after any recoverable error message. Press the [F1] key to continue the boot process or the [F2] key to enter Setup and change any settings.

**\*Previous boot incomplete – Default configuration used**

Previous Power On Self Test did not complete successfully. The Power On Self Test will load default values and offer to run Setup. If the previous failure was caused by incorrect values and they are not corrected, the next boot will likely fail also. If using the default settings does not allow you to complete a successful boot sequence, you should turn off the power and contact your support representative.

**\*Real time clock error**

Real-time clock fails BIOS test. May require board repair. Contact your support representative.

**\*Shadow RAM Failed at offset: nnnn**

Shadow RAM failed at offset nnnn of the 64k block at which the error was detected. You are risking data corruption if you continue. Contact your support representative.

**nnnn Shadow RAM Passed**

Where nnnn is the amount of shadow RAM in kilobytes successfully tested.

**\*System battery is dead – Replace and run SETUP**

The BIOS CMOS RAM memory hold up battery is dead. This is part of your BIOS and is a board mounted battery which requires a support representative to change. You can continue operating but you will have to use setup utility default values or reconfigure your setup utility every time you turn off your notebook. This battery has an expected life of 2 to 3 years.

**System BIOS shadowed**

System BIOS copied to shadow RAM.



**\*System CMOS checksum bad – Default Configuration Used**

BIOS CMOS RAM has been corrupted or modified incorrectly, perhaps by an application program that changes data stored in BIOS memory. Run Setup and reconfigure the system.

**\*System RAM Failed at offset: nnnn**

System memory failed at offset nnnn of in the 64k block at which the error was detected. This means that there is a fault in your built-in memory. If you continue to operate, you risk corrupting your data. Contact your support representative for repairs.

**nnnn System Memory Passed**

Where nnnn is the amount of system memory in kilobytes successfully tested.

**\*System timer error**

The timer test failed. The main clock that operates the computer is faulty. Requires repair of system board. Contact your support representative for repairs.

**Video BIOS shadowed**

Video BIOS successfully copied to shadow RAM.

.

## Restoring Your Pre-installed Software

The Drivers and Applications Restore (DAR) DVD contains sets of device drivers and Fujitsu utilities (in specific directories) that are unique to your computer configuration for use as documented below.



IN ORDER TO INSTALL APPLICATIONS AND/OR DRIVERS FROM THE DAR DVD, YOU WILL NEED TO USE A DVD DRIVE ATTACHED EXTERNALLY.



IF YOU HAVE ACCESS TO THE INTERNET, VISIT THE FUJITSU SUPPORT WEBSITE AT [HTTP://WWW.COMPUTERS.US.FUJITSU.COM/SUPPORT](http://www.computers.us.fujitsu.com/support) TO CHECK FOR THE MOST CURRENT INFORMATION, DRIVERS AND HINTS ON HOW TO PERFORM RECOVERY AND SYSTEM UPDATES.

### Re-installing Individual Drivers and Applications

The Drivers and Applications CD can be used to selectively re-install drivers and/or applications that may have been un-installed or corrupted.



THERE MAY BE CERTAIN FREE THIRD-PARTY APPLICATIONS PRE-INSTALLED ON YOUR SYSTEM THAT ARE NOT ON THE DAR CD. THE LATEST VERSIONS OF THE APPLICATIONS CAN BE DOWNLOADED FROM THE THIRD-PARTY'S WEBSITE.

To re-install drivers and/or applications:

- 1** Boot up the system and insert the DAR CD after Windows has started. A Fujitsu Installer screen is displayed after the CD is inserted.
- 2** After reading the License Agreement, click [I agree].
- 3** A window will appear containing a list of applications, drivers, and utilities that you can install from the Drivers and Applications CD.



THE COMPONENTS LISTED ARE COLOR-CODED IN TERMS OF THEIR INSTALL STATUS. BLUE INDICATES THAT THE COMPONENT CAN BE INSTALLED. GREEN INDICATES THAT THE COMPONENT NEEDS TO BE INSTALLED SEPARATELY. GREY INDICATES A COMPONENT THAT IS ALREADY INSTALLED; GREY ITEMS CAN BE REINSTALLED, BUT PRIOR TO INSTALLATION YOU WILL RECEIVE A REMINDER THAT THE COMPONENT IS ALREADY INSTALLED.

- 4 In the list, check off all the components you want to install. If you want to install all components, click [Select All]. Clicking [Select All] will select all of the blue-coded components; you must select grey and green components separately.
- 5 Once you have selected the components you wish to install, click [Install Selected Subsystems]; the components will be installed.
- 6 After the components are installed, click [OK], then click [Yes] when asked if you want to reboot the system.

## Restoring the Operating System for Windows XP Systems

The Recovery and Utility disc contains three utilities:

- The **Recovery** utility allows you to restore the system operating system (OS). The restored OS is the same one that was originally installed on the hard disk drive. After the OS is restored, you will need to reinstall the drivers and applications from the Drivers and Applications Restore disc and from any application discs that were bundled with the system when you purchased it.
- The **Hard Disk Data Delete** utility on this disc is used to delete all data on your hard disk and prevent it from being reused. Do not use the Hard Disk Data Delete utility unless you are absolutely certain that you want to erase your entire hard disk, including all partitions.
- The **Partition Creation** utility allows you to create or resize partitions on your hard disk. **NOTE: Creating or resizing partitions with this utility will cause all data on the hard disk to be completely erased.**



- THE USE OF THIS DISC REQUIRES THAT YOU HAVE A DEVICE CAPABLE OF READING DVDs ATTACHED TO YOUR SYSTEM. YOU WILL NEED TO ATTACH AN EXTERNAL PLAYER. FOR MORE INFORMATION ON AVAILABLE EXTERNAL DEVICES, VISIT OUR WEB SITE AT: [US.FUJITSU.COM/COMPUTERS](http://US.FUJITSU.COM/COMPUTERS).
- THIS DISC CAN ONLY BE USED WITH THE SYSTEM WITH WHICH IT WAS PURCHASED.

## BOOT Priority Change

Before restoring an image, you must first verify that the system is set up to boot from the DVD drive. To verify/change the boot-up priority (rather than booting-up from the hard drive or an external floppy disk drive), perform the following steps:

- 1 Start your system and press the [F2] key when the Fujitsu logo appears. You will enter the BIOS Setup Utility.
- 2 Using the arrow keys, go to the Boot menu.
- 3 Arrow down to the Boot Device Priority submenu. Press [Enter].
- 4 If “Optical Media Drive” or “CD-ROM Drive” is not at the top of the list, arrow down to the drive in the list, and press the space bar (or the + key) to move it to the top of the list. (The system attempts to boot from the devices in the order in which they are listed.). Note that the BIOS for some systems will indicate “CD-ROM Drive”, even when a DVD drive is connected.
- 5 If you have an *external* DVD drive connected, proceed to the next step; otherwise, proceed to step 7.
- 6 If you have an external DVD drive connected:
  - Select the Advanced menu in the BIOS window.
  - Scroll down to the USB Features submenu and press the Enter key to open it.
  - If Legacy USB Support is disabled, press the space bar to enable it.
  - Scroll down to SCSI SubClass Support and press the space bar to enable it.
- 7 Press [F10], then click on [Yes] to exit the BIOS Setup Utility and return to the boot process.

After you have changed the boot priority, you can restore a backup image when you are booting up.

## Procedure

- 1 Turn on the power to your system.
- 2 Ensure that you have a device that can read DVDs either installed in your system or attached externally to it.
- 3 Insert the Restore Disc into the drive tray.
- 4 Reboot your system.

After the system reboots, follow the instructions that appear to restore your operating system, erase all data from your hard disk, or create or resize partitions on the hard disk.

## Restoring the Operating System for Windows Vista Systems

The Recovery and Utility disc contains four utilities:

- The **Recovery** utility allows you to restore the system operating system (OS). The restored OS is the same one that was originally installed on the hard disk drive. After the OS is restored, you will need to reinstall the drivers and applications from the Drivers and Applications Restore disc and from any application discs that were bundled with the system when you purchased it.
- The **Hard Disk Data Delete** utility on this disc is used to delete all data on your hard disk and prevent it from being reused. Do not use the Hard Disk Data Delete utility unless you are absolutely certain that you want to erase your entire hard disk, including all partitions.
- The **Partition Creation** utility allows you to create a new D: partition or resize existing partitions on your hard disk. **NOTE: Creating or resizing partitions with this utility will cause all data on the hard disk to be completely erased.**
- The **Diagnostics** utility allows the IT professional to determine device status/condition by executing diagnostics tests on selected system components.

## Methods for accessing the utilities

Certain LifeBook models have the Recovery and Utility applets pre-installed on a hidden drive. Other systems require that the Recovery and Utility disc be used (or in the event the hard disk has been reformatted).

In order to determine the method for accessing the Recovery and Utility applet, perform the following procedures in order.

### **Determining whether Recovery and Utility is pre-loaded**

- 1** Turn on or reboot your system. When the Fujitsu logo appears, press [F12] key.
- 2** From the Boot Menu that appears, check whether the <Recovery and Utility> option is present. If it is not present, it means that the utility must be used from the disc. Proceed to “Running Recovery and Utility from the disc” if <Recovery and Utility> is unavailable.

### **Running Recovery and Utility from hard disk**

- 1** Cursor down to <Recovery and Utility> and press the [Enter] key.
- 2** While the files are being loaded from the disc, a progress bar will appear at the bottom of the screen.
- 3** When the System Recovery Options dialog opens, select a new keyboard layout, if necessary, then click [Next].
- 4** When the Operating System dialog appears, click [Next].
- 5** If necessary, enter your password, then click [OK].
- 6** When System Recovery Options window appears, click on Recovery and Utility.
- 7** The Recovery and Utility screen appears on the screen with three tabs: Diagnostics, Recovery and Utility. Please note that Diagnostics tab is not supported on certain LifeBook/Stylistic models when running Recovery and Utility from the hard disk. In order to restore the operating system, please insert the “Recovery and Utility” disc in the CD/DVD drive and use the Start Recovery function under the Recovery tab. For more information about the tabs, go to “Recovery and Utility tabs” on page 113.

### **Running Recovery and Utility from the disc**



- THE USE OF THIS DISC REQUIRES THAT YOU HAVE A DEVICE CAPABLE OF READING DVDs ATTACHED TO YOUR SYSTEM. YOU WILL NEED TO ATTACH AN EXTERNAL PLAYER. FOR MORE INFORMATION ON AVAILABLE EXTERNAL DEVICES, VISIT OUR WEB SITE AT: [US.FUJITSU.COM/COMPUTERS](http://US.FUJITSU.COM/COMPUTERS).
- THIS DISC CAN ONLY BE USED WITH THE SYSTEM WITH WHICH IT WAS PURCHASED.

## BOOT Priority Change

Before restoring an image, you must first verify that the system is set up to boot from the DVD drive. To verify/change the boot-up priority (rather than booting-up from the hard drive or an external floppy disk drive), perform the following steps:

- 1** Start your system and press the [F2] key when the Fujitsu logo appears. (Alternately, you can press the [F12] key when the logo appears, then select <Enter BIOS Setup>.) You will enter the BIOS Setup Utility.
  - 2** Using the arrow keys, go to the Boot menu.
  - 3** Arrow down to the Boot Device Priority submenu. Press [Enter].
  - 4** If “Optical Media Drive”, “CD-ROM Drive”, or “CD/DVD Drive” is not at the top of the list, arrow down to the drive in the list, and press the space bar (or the + key) to move it to the top of the list. (The system attempts to boot from the devices in the order in which they are listed.). Note that the BIOS for some systems will indicate “CD-ROM Drive”, even when a DVD drive is connected.
  - 5** If you have an *external* DVD drive connected, proceed to the next step; otherwise, proceed to step 7.
  - 6** If you have an external DVD drive connected:
    - Select the Advanced menu in the BIOS window.
    - Scroll down to the USB Features submenu and press the Enter key to open it.
    - If Legacy USB Support is disabled, press the space bar to enable it.
    - Scroll down to SCSI SubClass Support and press the space bar to enable it.
  - 7** Press [F10], then click [Yes] to exit the BIOS Setup Utility and return to the boot process.
- After you have changed the boot priority, you can restore a backup image when booting up.

## Procedure for using Recovery and Utility disc

- 1** Turn on the power to your system.
- 2** Ensure that you have a device that can read DVDs either installed in your system or attached externally to it, and that it has been set up as the Boot device (in accordance with “BOOT Priority Change” on page 112).

- 3 Insert the Recovery and Utility disc into the drive tray. With the boot priority set in the procedure above, the system will boot from the Recovery and Utility disc.
- 4 Reboot your system. After the system reboots, the Recovery and Utility screen appears. On the screen are three tabs: Diagnostics, Recovery, and Utility.

### Recovery and Utility tabs

**Diagnostics tab:** The Diagnostics tool is designed for use by IT professionals. It is not likely you will need to use this tool. When you select devices from the Diagnosis window then click [Execute], several tests are performed on the selected components.

**Recovery tab:** The Recovery tab contains the Start Recovery tool. Note that the recovery process erases all data from the C: drive. If you decide to use the recovery tool, be sure to back up all data that you don't want to lose. Also note that you must run the system using your AC adapter while running the recovery tool. To use the Recovery tool, select the Start Recovery function, click on the [Execute] button, then follow the instructions on the screen.

**Utility tab:** The Utility tab contains three tools: System Restore, Hard Disk Data Delete and Partition Creation.

- **System Restore** can help fix problems that might be making your computer run slowly or stop responding. System Restore enables you in rolling back the system to an earlier restore point, and does not affect any of your documents, pictures, or other personal data.
- The **Hard Disk Data Delete** utility is used to delete all data on the hard disk and prevent the data from being reused. **NOTE: Do not use the Hard Disk Data Delete utility unless you are absolutely certain that you want to erase your entire hard disk, including all partitions.**
- The **Partition Creation** utility allows you to create a D: partition or resize existing partitions on your hard disk. **NOTE: Creating or resizing partitions with this utility will cause all data on the hard disk to be completely erased.**



## **Automatically Downloading Driver Updates**

Your system has a convenient tool called the Fujitsu Driver Update (FDU) utility. With FDU, you can choose to automatically or manually go to the Fujitsu site to check for new updates for your system.

The FDU icon should appear in the system tray at the bottom right of your screen (roll the cursor over the icons to find the correct one). If the icon does not appear in the system tray, go to [Start] -> All Programs, and click on Fujitsu Driver Update; this will create the icon automatically.

To invoke the FDU menu, you can either right-click on the FDU icon or hold the pen on the icon for a couple of seconds until the menu appears. The menu contains the following items:

### **Check for updates now**

Allows for manual driver update search. The first time it is used, you are prompted to agree to a user agreement. After clicking on the icon, the FDU automatically connects with the Fujitsu site to check for updates and downloads them. While downloading, the icon has a red bar through it, indicating that it cannot be used while the download is in process. When the update is complete, a message appears informing you of the fact.

### **Enable Automatic Update Notifications**

Automatically searches for new updates on a regular basis (approximately every 3 days).

### **Show update history**

Brings up a screen that displays a history of updates that have been made via the FDU.

### **About Fujitsu Driver Update**

Displays the FDU version number and copyright information

### **Fujitsu Driver Update Readme**

Displays the FDU readme.

## Chapter 5

# Care and Maintenance

### Caring for your LifeBook Notebook

If you use your Fujitsu LifeBook notebook carefully, you will increase its life and reliability. This section provides some tips for looking after the notebook and its devices.



- THE SYSTEM CONTAINS COMPONENTS THAT CAN BE SEVERELY DAMAGED BY ELECTROSTATIC DISCHARGE (ESD). TO MINIMIZE RISK TO THE COMPONENTS, OBSERVE THE FOLLOWING PRECAUTIONS:
  - BEFORE DOCKING OR UNDOCKING YOUR LIFEBOOK NOTEBOOK (WHEN USING A PORT REPLICATOR), IT IS A GOOD PRACTICE TO ALWAYS TOUCH A GROUNDED METAL OBJECT TO DISCHARGE STATIC ELECTRICITY BUILT UP IN YOUR BODY.
  - BE SURE TO POWER DOWN YOUR SYSTEM BEFORE ADDING OR REMOVING SYSTEM COMPONENTS. EVEN IF THE SYSTEM IS IN HIBERNATE OR STANDBY STATES, DATA COULD BE LOST OR MEMORY COULD BE DAMAGED IF POWER IS STILL AVAILABLE TO THE SYSTEM.
  - WHEN INSTALLING OR REMOVING A MEMORY MODULE, HOLD IT BY THE EDGE SO AS NOT TO TOUCH ANY CONTACTS OR CHIPS. BE CAREFUL NOT TO TOUCH ANY INTERNAL COMPUTER TERMINALS OR COMPONENTS; THE OIL FROM YOUR FINGERS COULD CAUSE A SHORT TO THE COMPONENTS.
- ELECTRICAL EQUIPMENT MAY BE HAZARDOUS IF MISUSED. OPERATIONS OF THIS PRODUCT OR SIMILAR PRODUCTS, MUST ALWAYS BE SUPERVISED BY AN ADULT. DO NOT ALLOW CHILDREN ACCESS TO THE INTERIOR OF ANY ELECTRICAL PRODUCTS AND DO NOT PERMIT THEM TO HANDLE ANY CABLES.

- Your LifeBook notebook is a durable but sensitive electronic device. Treat it with respect and care.
- Make a habit of transporting it in a suitable carrying case.
- Do not attempt to service the computer yourself. Always follow installation instructions closely.
- Keep it away from food and beverages.
- To protect your notebook from damage and to optimize system performance, be sure to **keep all air all vents unobstructed, clean, and clear of debris**. This may require periodic cleaning, depending upon the environment in which the system is used.
- Do not operate the notebook in areas where the air vents can be obstructed, such as in tight enclosures or on soft surfaces like a bed or cushion.
- If you accidentally spill liquid on your LifeBook notebook:
  - 1 Turn it off immediately.
  - 2 Position it so that the liquid can run out.
  - 3 Let it dry out for 24 hours, or longer if needed.
  - 4 If your notebook will not boot after it has dried out, call your support representative.
- Do not use your LifeBook notebook in a wet environment (near a bathtub, swimming pool).
- Always use the AC adapter and batteries that are approved for your notebook.
- Avoid exposure to sand, dust and other environmental hazards.
- Do not expose your notebook to direct sunlight for long periods of time as temperatures above 140° F (60° C) may damage your notebook.
- Keep the covers closed on the connectors and slots when they are not in use.
- Do not put heavy or sharp objects on the computer.
- If you are carrying your notebook in a briefcase, or any other carrying case, make sure that there are no objects in the case pressing on the lid.

## **Cleaning your LifeBook notebook**

- Always disconnect the power plug. (Pull the plug, not the cord.)
- Clean your LifeBook notebook with a damp, lint-free cloth. Do not use abrasives or solvents.
- Use a soft cloth to remove dust from the screen. Never use glass cleaners.

## **Storing your LifeBook notebook**

- If storing your notebook for a month or longer, turn your LifeBook notebook off, fully charge the battery(s), then remove and store all Lithium ion batteries.
- Store your notebook and batteries separately. If you store your LifeBook with a battery installed, the battery will discharge, and battery life will be reduced. In addition, a faulty battery might damage your LifeBook.
- Store your Fujitsu LifeBook in a cool, dry location. Temperatures should remain between 13°F (-25°C) and 140°F (60°C).

## **Traveling with your LifeBook notebook**

- Do not transport your notebook while it is turned on.
- Always bring your System Recovery CD that came with your notebook when you travel. If you experience system software problems while traveling, you may need it to correct any problems.
- Never put your notebook through a metal detector. Have your notebook hand-inspected by security personnel. You can however, put your notebook through a properly tuned X-ray machine. To avoid problems, place your notebook close to the entrance of the machine and remove it as soon as possible or have your notebook hand-inspected by security personnel. Security officials may require you to turn your notebook o, so make sure you have a charged battery on hand.
- When traveling with the hard drive removed, wrap the drive in a non-conducting materials (cloth or paper). If you have the drive checked by hand, be ready to install the drive if needed. Never put your hard drive through a metal detector. Have your hard drive hand-inspected by security personnel. You can however, put your hard drive through a properly tuned X-ray machine.

- Take the necessary plug adapters if you're traveling overseas. Check the following diagram to determine which plug adapter you'll need or ask your travel agent.

Outlet Type	Location
	United States, Canada, parts of Latin America, Mexico, Japan, Korea, the Philippines, Taiwan
	Russia and the Commonwealth of Independent States (CIS), most of Europe, parts of Latin America, the Middle East, parts of Africa, Hong Kong, India, most of South Asia
	United Kingdom, Ireland, Malaysia, Singapore, parts of Africa
	China, Australia, New Zealand

- It is recommended that you carry your notebook with you while traveling, rather than checking it in as baggage.

## Batteries

### Caring for your Batteries

- Always handle batteries carefully.
- Do not short-circuit the battery terminals (that is, do not touch both terminals with a metal object). Do not carry loose batteries in a pocket or purse where they may mix with coins, keys, or other metal objects. Doing so may cause an explosion or fire.

- Do not drop, puncture, disassemble, mutilate or incinerate the battery.
- Recharge batteries only as described in this manual and only in ventilated areas.
- Do not leave batteries in hot locations for more than a day or two. Intense heat can shorten the life of your battery.
- Do not leave a battery in storage for longer than 6 months without recharging it.

### **Increasing Battery Life**

- Power your LifeBook notebook through the AC or optional auto/airline adapter whenever possible.
- If your notebook is running on battery power all day, connect it to the AC adapter overnight to recharge the battery.
- Keep brightness to the lowest level comfortable.
- Set the power management for maximum battery life.
- Put your notebook in Standby mode when it is turned on and you are not actually using it.
- Disable the Media Player auto insert notification function.
- Always use fully charged batteries.

### **Media Care**

#### **Caring for your Media (DVD/CD/CD-R)**

If you have an optional external optical drive connected to your system, be sure to handle the media discs carefully. Media discs are precision devices and will function reliably if given reasonable care.

- Always store your media disc in its case when it is not in use.
- Always handle discs by the edges and avoid touching the surface.
- Avoid storing any media discs in extreme temperatures.
- Do not bend media discs or set heavy objects on them.

- Do not spill liquids on media discs.
- Do not scratch media discs.
- Do not get dust on media discs.
- Never write on the label surface with a ballpoint pen or pencil. Always use a felt pen.
- If a media disc is subjected to a sudden change in temperature, cold to warm condensation may form on the surface. Wipe the moisture off with a clean, soft, lint free cloth and let it dry at room temperature. DO NOT use a hair dryer or heater to dry media discs.
- If a disc is dirty, use only a DVD/CD cleaner or wipe it with a clean, soft, lint free cloth starting from the inner edge and wiping to the outer edge.

### **Caring for your Optical Drive**

Your optional external optical drive is durable but you must treat it with care. Please pay attention to the following points:

- The drive rotates the compact disc at a very high speed. Do not carry it around or subject it to shock or vibration with the power on.
- Avoid using or storing the drive where it will be exposed to extreme temperatures.
- Avoid using or storing the drive where it is damp or dusty.
- Avoid using or storing the drive near magnets or devices that generate strong magnetic fields.
- Avoid using or storing the drive where it will be subjected to shock or vibration.
- Do not disassemble or dismantle the optical drive.
- Use of a commercially available lens cleaner is recommended for regular maintenance of your drive.

## Chapter 6

# System Specifications

## Specifications

This section provides the hardware and environmental specifications for your Fujitsu LifeBook notebook. Specifications of particular configurations will vary.

### Configuration Label

The configuration label located on the bottom of your notebook contains specific information regarding the options you've chosen for your notebook. Following is an example configuration label.

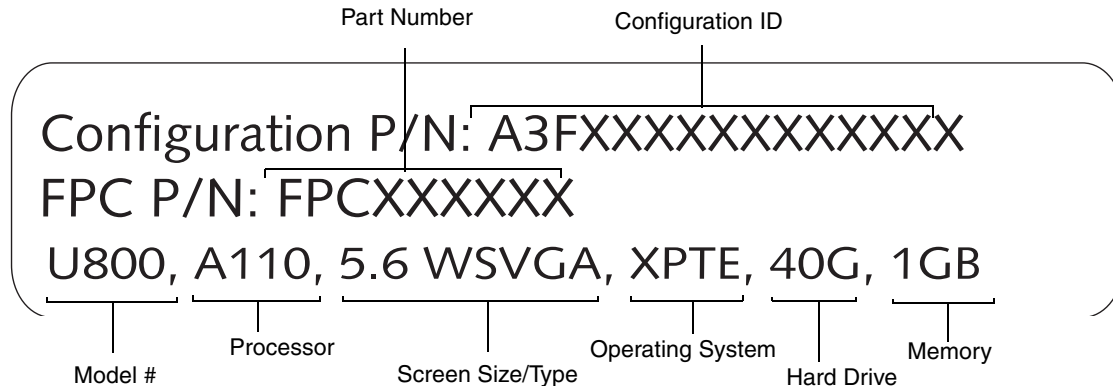



## Microprocessor

Intel® A110 processor (Refer to the system label to determine the speed of your processor).

## Chipset

- Intel 945GU Express
- Intel ICH7-U Controller Hub

## Memory

### System Memory

- DDR2-400 MHz SDRAM dual-channel memory module.
- Total of 1 GB pre-installed. No DIMM slots for expansion.

### Cache Memory

512 KB L2 cache on-die

## Video

Built-in color flat-panel TFT active matrix LCD display with simultaneous display capability.

### Video Color and Resolution

#### 5.6" Crystal View Wide SVGA display

- Internal: 1024 x 600 pixel resolution, 16M colors
- External: 1280 x 1024 pixel resolution, 16M colors
- Simultaneous: TBD

## Video RAM

Intel® TBD video graphics. Up to TBD MB shared video memory using Dynamic Video Memory Technology (DVMT)

## Audio

- Audio Realtek Codec ALC262 with High Definition (HD) audio.
- **Headphones:** Stereo headphone jack, 3.5 mm, 1 V<sub>rms</sub> or less, minimum impedance 32 Ohms
- **Microphone:** Stereo microphone jack, 3.5 mm, 100 mV<sub>p-p</sub> or less, minimum impedance 10K Ohms
- One built-in speaker, 20 mm diameter
- One built-in digital microphone

## Mass Storage Device Options

### Hard Drive

- Parallel ATA, Ultra DMA 100, 4200 rpm, 1.8", 5 mm
- Shock-mounted

## Features

### Integrated Pointing Device

Cursor control button

### Communications

- **Internal LAN:** Internal wired 10/100 Ethernet LAN
- **WLAN:** Integrated Atheros Super AG (802.11a/b/g)
- **Bluetooth:** Optional Bluetooth device for wireless personal area network communication

## Trusted Platform Module

The LifeBook U810 has a Trusted Platform Module (TPM) installed for added system security.

## Programmable LifeBook Application/Tablet PC Buttons .

Button	Button Function	Default Application	Default Application with Fn Button
/	Application A	Keyboard "headlights" on/off	Journal
//	Application B	On-screen Keyboard/Writing Pad	Power Saving Mode
<b>Fn</b>	Function	Used in conjunction with Application Buttons to change functions.	Press Fn twice for Fujitsu Menu
↵	Scroll Down	Scroll Down	Page Down
⤴	Scroll Up	Scroll Up	Page Up

**Figure 34. Application Launcher Defaults**

## Device Ports

### On the LifeBook notebook:

- Secure Digital (SD) Card slot
- One Compact Flash (CF) slot
- One USB 2.0 (Universal Serial Bus) connector for input/output devices
- One DC In connector
- Port Replicator connector (also accommodates external video/LAN cable adapter)
- One stereo headphone jack
- One stereo microphone jack
- Wireless LAN antenna with pre-installed on/off switch

### **On the Optional Port Replicator:**

- One 15-pin D-SUB connector for VGA external monitor
- Four USB 2.0 connectors for input/output devices
- One LAN (RJ-45) connector
- One DC-in connector

### **Keyboard**

#### Built-in keyboard

- Total number of keys: 56
- Function keys: [F1] through [F12] when used in conjunction with [Fn] key
- Two Windows keys: one Start key, one application key
- Key pitch: 14 mm; key stroke: 13.0 mm
- Built-in cursor control button with left and right buttons and scroll buttons.
- External USB keyboard/mouse support

### **Power**

#### **Batteries**

Standard Lithium ion battery, rechargeable, 4-cell 7.2V, 5200 mAh, or,

#### **AC Adapter**

Autosensing 100-240V AC, supplying 16V DC, 2.5A, 40W to the LifeBook; includes an AC cable

#### **Power Management**

Conforms to ACPI (Advanced Configuration and Power Interface).

## **Dimensions and Weight**

### **Overall Dimensions**

TBD - The following are not correct for system with 4-cell battery

Approximately 6.73"(w) x 5.23"(d) x 1.04"/1.26"(h) (171.0 mm x 133.0 mm x 26.5/32.0 mm)

### **Weight**

Approximately 1.56 lbs. (708 g) with battery

## **Environmental Requirements**

### **Temperature**

Operating: 41° to 95° F (5° to 35° C). Non-operating: 5° to 140° F (-15° to 60° C)

### **Humidity**

Operating: 20% to 85%, relative, non-condensing. Non-operating: 8% to 85%, relative, non-condensing

### **Altitude**

Operating: 10,000 feet (3,048 m) maximum

## **Popular Accessories**

For ordering or additional information on Fujitsu accessories please visit our Web site at [www.shopfujitsu.com](http://www.shopfujitsu.com) or call 1-800-FUJITSU.

## Pre-Installed Software

Depending on your operating system, your notebook comes with pre-installed software for playing audio and video files of various formats. In addition there is file transfer software, virus protection software and Power Management software. The following list indicates the pre-installed software on your system.

- Adobe Acrobat Reader
- ArcSoft WebCam Companion
- Microsoft Origami for Vista (Windows Vista models only)
- Microsoft Tablet PC Experience Pack (Windows Tablet PC only)
- OmniPass Fingerprint application
- Fujitsu Driver Update utility
- Microsoft Works with Office 2007 Student and Home Trial Edition (Windows Vista Home Premium only)
- Microsoft Office OneNote 2007
- **Operating System:** Microsoft Windows Vista Home Premium, Windows Vista Business, or Windows XP Tablet

## Learning About Your Software

### Tutorials

All operating systems and most application software have tutorials built into them upon installation. We highly recommend that you step through the tutorial before you use an application.

### Manuals

Included with your notebook you will find manuals for your installed operating system and other pre-installed software. If any manuals are not included, information about the application is available online or through the help system of the software. We recommend that you review these manuals for general information on the use of these applications.

### **Adobe Acrobat Reader**

The Adobe Acrobat Reader allows you to view, navigate, and print PDF files from across all of the major computing platforms.

### **ArcSoft WebCam Companion**

WebCam Companion offers a variety of webcam-optimized functions such as automatically recording movement detected by the cam, launching video chat sessions, capturing still and video images, and editing photos.

### **OmniPass Fingerprint application**

The fingerprint sensor uses Softex OmniPass which provides password management capabilities to Microsoft Windows operating systems. OmniPass lets you use a "master password" for all Windows, applications, and on-line passwords, and presents a convenient user interface through which you can securely manage passwords, users, and multiple identities for each user.

### **Fujitsu Driver Update Utility**

The Fujitsu Driver Update (FDU) utility is pre-installed on your system. With FDU, you can choose to automatically or manually go to the Fujitsu site to check for new updates for your system. See “Automatically Downloading Driver Updates” on page 114.

### **Operating System Options**

Depending upon your system, one of the following operating system configurations will be installed:

- **Microsoft Windows XP Tablet PC Edition**
- **Windows Vista Business Edition**
- **Microsoft Windows Vista Home Premium Edition**  
With Microsoft Works and Office 2007 Student and Home Trial Edition

### **Microsoft Works with Office 2007 Student and Home Trial Edition (Windows Vista Home Premium only)**

Microsoft Works 9.0 is a software suite containing the basic tools to write letters and reports, track family and friends with address books, manage home finances, and create a home inventory.

### **Microsoft Origami for Vista (Windows Vista only)**

Origami contains three applications: Origami Experience helps you easilt acces your programs and muic/photo/video files. Sudoku is a touch screen version of the popular game. Touch Settings lets you customize how you interact with the touch screen.

### **Microsoft Tablet PC Experienece Pack (Windows XP Tablet PC only)**

Tablet PC Experience Pack contains a number of different tools and games. The Experience Pack lets you take notes directly to your desktop, paint on-screen, snip and capture sections from the screen, organize your media files, and play word games.





# Glossary

## **AC Adapter**

A device which converts the AC voltage from a wall outlet to the DC voltage needed to power your LifeBook notebook.

## **Access point**

Wireless network device used to bridge wireless and wired network traffic.

## **ACPI**

Advanced Configuration and Power Interface

## **Active-Matrix Display**

A type of technology for making flat-panel displays which has a transistor or similar device for every pixel on the screen.

## **Ad Hoc Mode**

Ad Hoc Mode refers to a wireless network architecture where wireless network connectivity between multiple computers is established without a central wireless network device, typically known as Access Points. Connectivity is accomplished using only client devices in a peer-to-peer fashion.

**Auto/Airline Adapter**

A device which converts the DC voltage from an automobile cigarette lighter or aircraft DC power outlet to the DC voltage needed to power your LifeBook notebook.

**BIOS**

Basic Input-Output System. A program and set of default parameters stored in ROM which tests and operates your LifeBook notebook when you turn it on until it loads your installed operating system from disk. Information from the BIOS is transferred to the installed operating system to provide it with information on the configuration and status of the hardware.

**Bit**

An abbreviation for binary digit. A single piece of information which is either a one (1) or a zero (0).

**bps**

An abbreviation for bits per second. Used to describe data transfer rates.

**Boot**

To start-up a computer and load its operating system from disk, ROM or other storage media into RAM.

**Bus**

An electrical circuit which passes data between the CPU and the sub-assemblies inside your LifeBook notebook.

**Byte**

8 bits of parallel binary information.

**Cache Memory**

A block of memory built into the micro-processor which is much faster to access than your system RAM and used in specially structured ways to make your overall data handling time faster.

**CardBus**

A faster, 32-bit version of the PC Card interface which offers performance similar to the 32-bit PCI architecture.

**CD-ROM**

Compact disk read only memory. This is a form of digital data storage which is read optically with a laser rather than a magnetic head. A typical CD-ROM can contain about 600MB of data and is not subject to heads crashing into the surface and destroying the data when there is a failure nor to wear from reading.

**Channel**

Range of narrow-band frequencies used by the WLAN device to transmit data. IEEE802.11b/g - 11 channels, 22 MHz wide channels.

**Command**

An instruction which you give your operating system. Example: run a particular application or format a floppy disk.

**Configuration**

The combination of hardware and software that makes up your system and how it is allocated for use.

**CRT**

Cathode Ray Tube. A display device which uses a beam of electronic particles striking a luminescent screen. It produces a visual image by varying the position and intensity of the beam.

**Data**

The information a system stores and processes.

**DC**

Direct current. A voltage or current that does not fluctuate periodically with time.

**Default Value**

A pre-programmed value to be used if you fail to set your own.

**DHCP**

Dynamic Host Configuration Protocol. A protocol used to automatically acquire parameters required for the communication, such as IP address. The sender of IP address is called a DHCP server, and the receiver is called a DHCP client.

**DIMM**

Dual-in-line memory module.

**Disk**

A spinning platter of magnetic data storage media. If the platter is very stiff it is a hard drive, if it is highly flexible it is a floppy disk, if it is a floppy disk in a hard housing with a shutter it is commonly called a diskette.

**Disk Drive**

The hardware which spins the disk and has the heads and control circuitry for reading and writing the data on the disk.

**DMA**

Direct Memory Access. Special circuitry for memory to memory transfers of data which do not require CPU action.

**DMI**

Desktop Management Interface. A standard that provides PC management applications with a common method of locally or remotely querying and configuring PC computer systems, hardware and software components, and peripherals.

## **DNS**

Domain Name System. A function to control the association between the IP address and the name assigned to the computer. If you do not know the IP address but if you know the computer name, you can still communicate to that computer.

## **DOS**

Disk Operating System (MS-DOS is a Microsoft Disk Operating System).

## **Driver**

A computer program which converts application and operating system commands to external devices into the exact form required by a specific brand and model of device in order to produce the desired results from that particular equipment.

## **DVMT**

Dynamic Video Memory Technology. A video memory architecture that increases the efficiency of the motherboard by using innovative memory utilization and direct AGP.

## **ECP**

Extended Capability Port. A set of standards for high speed data communication and interconnection between electronic devices.

## **Encryption Key (Network Key)**

Data encryption key used to encrypt message text and for computing message integrity checks. Data encryption protects data from unauthorized viewing.

This device uses the same encryption key to encode and decode the data, and the identical encryption key is required between the sender and receiver.

**ESD**

Electrostatic Discharge. The sudden discharge of electricity from a static charge which has built-up slowly. Example: the shock you get from a doorknob on a dry day or the sparks you get from brushing hair on a dry day.

**FCC**

Federal Communication Commission.

**GB**

Gigabyte. One billion bytes.

**Hard drive**

A spinning platter of magnetic data storage media where the platter is very stiff.

**I/O**

Input/Output. Data entering and leaving your notebook in electronic form.

**I/O Port**

The connector and associated control circuits for data entering and leaving your notebook in electronic form.

**IDE**

Intelligent Drive Electronics. A type of control interface for a hard drive which is inside the hard drive unit.

**IEEE802.11a**

Wireless LAN standard that supports a maximum data rate of 54 Mbps. 802.11a devices operate in the 5 GHz lower and middle UNII bands.

## **IEEE802.11b**

Wireless LAN standard that supports a maximum data rate of 11 Mbps. 802.11b devices operate in the 2.4 GHz ISM band.

## **IEEE802.11g**

Wireless LAN standard that supports a maximum data rate of 54 Mbps. 802.11g devices operate in the 2.4 GHz ISM band.

## **Infrared**

Light just beyond the red portion of the visible light spectrum which is invisible to humans.

## **Infrastructure**

A name of a wireless LAN configuration. This type of communication uses an access point. Another type of communication is called Ad Hoc.

## **IP Address**

An identifier for a computer or device on a TCP/IP network. Networks using the TCP/IP protocol route messages based on the IP address of the destination. The format of an IP address is a 32-bit numeric address written as four numbers separated by periods. Each number can be zero to 255. For example, 1.160.10.240 could be an IP address.

Within an isolated network, you can assign IP addresses at random as long as each one is unique. However, connecting a private network to the Internet requires using registered IP addresses (called Internet addresses) to avoid duplicates.

The four numbers in an IP address are used in different ways to identify a particular network and a host on that network. Three regional Internet registries -- ARIN, RIPE NCC and APNIC -- assign Internet addresses from the following three classes.

Class A - supports 16 million hosts on each of 126 networks

Class B - supports 65,000 hosts on each of 16,000 networks

Class C - supports 254 hosts on each of 2 million networks

The number of unassigned Internet addresses is running out, so a new classless scheme called CIDR is gradually replacing the system based on classes A, B, and C and is tied to adoption of IPv6.

## **IR**

An abbreviation for infrared.

## **IrDA**

Infrared Data Association. An organization which produces standards for communication using infrared as the carrier.

## **IRQ**

Interrupt Request. An acronym for the hardware signal to the CPU that an external event has occurred which needs to be processed.

## **KB**

Kilobyte. One thousand bytes.

## **LAN**

Local Area Network. An interconnection of computers and peripherals within a single limited geographic location which can pass programs and data amongst themselves.

## **LCD**

Liquid Crystal Display. A type of display which makes images by controlling the orientation of crystals in a crystalline liquid.

## **Lithium ion Battery**

A type of rechargeable battery which has a high power-time life for its size and is not subject to the memory effect as Nickel Cadmium batteries.



**MAC Address**

Media Access Control Address. A unique physical address of a network card. For Ethernet, the first three bytes are used as the vendor code, controlled and assigned by IEEE. The remaining three bytes are controlled by each vendor (preventing overlap), therefore, every Ethernet card is given a unique physical address in the world, being assigned with a different address from other cards. For Ethernet, frames are sent and received based on this address.

**MB**

Megabyte. One million bytes.

**Megahertz**

1,000,000 cycles per second.

**Memory**

A repository for data and applications which is readily accessible to your LifeBook notebook's CPU.

**MHz**

Megahertz.

**MIDI**

Musical Instrument Digital Interface. A standard communication protocol for exchange of information between computers and sound producers such as synthesizers.

**Modem**

A contraction for MODulator-DEModulator. The equipment which connects a computer or other data terminal to a communication line.

**Monaural**

A system using one channel to process sound from all sources.

## **MTU**

Maximum Transmission Unit

The maximum data size that can be transferred at a time through the Internet or other networks. You can set a smaller MTU size to obtain successful communication, if you have difficulty transferring data due to the fact that the maximum size is too large.

## **Network key**

Data that is used for encrypting data in data communication. The personal computer uses the same network key both for data encryption and decryption, therefore, it is necessary to set the same network key as the other side of communication.

## **Network name (SSID: Service Set Identifier)**

When a wireless LAN network is configured, grouping is performed to avoid interference or data theft. This grouping is performed with “Network name (SSID)”. In order to improve security, the network key is set allowing no communication unless “Network name (SSID)” coincides with the network key.

## **NTSC**

National TV Standards Commission. The standard for TV broadcast and reception for the USA.

## **Open system authentication**

Null authentication method specified in the 802.11 standard that performs no authentication checks on a wireless client before allowing it to associate.

## **Operating System**

A group of control programs that convert application commands, including driver programs, into the exact form required by a specific brand and model of microprocessor in order to produce the desired results from that particular equipment.

**Partition**

A block of space on a hard drive which is set aside and made to appear to the operating system as if it were a separate disk, and addressed by the operating system accordingly.

**Peripheral Device**

A piece of equipment which performs a specific function associated with but not integral to a computer. Examples: a printer, a modem, a CD-ROM.

**Pitch (keyboard)**

The distance between the centers of the letter keys of a keyboard.

**Pixel**

The smallest element of a display, a dot of color on your display screen. The more pixels per area the clearer your image will appear.

**POST**

Power On Self Test. A program which is part of the BIOS which checks the configuration and operating condition of your hardware whenever power is applied to your notebook. Status and error messages may be displayed before the operating system is loaded. If the self test detects failures that are so serious that operation can not continue, the operating system will not be loaded.

**PPPoE**

Point to Point Protocol over Ethernet. A protocol for Ethernet, using a Point-to-Point Protocol (PPP), which is used for connection on the phone line.

**Program**

An integrated set of coded commands to your computers telling your hardware what to do and how and when to do it.

## **Protocol**

Procedures and rules use to send and receive data between computers.

- Method of sending and receiving data
- Process used to handle communication errors

Conditions required for communication are organized in procedures for correct transfer of information.

## **RAM**

Random Access Memory. A hardware component of your LifeBook notebook that holds binary information (both program and data) as long as it has the proper power applied to it.

## **RAM Module**

A printed circuit card with memory and associated circuitry which allows the user to add additional memory to the computer without special tools.

## **Reset**

The act of reloading the operating system. A reset erases all information stored in RAM.

## **Restart**

See Reset.

## **Resume**

To proceed after interruption. In your notebook this refers to returning to active operation after having been in one of the suspension states.

## **ROM**

Read Only Memory. A form of memory in which information is stored by physically altering the material. Data stored in this way can not be changed by your notebook and does not require power to maintain it.

## **SDRAM**

Synchronous Dynamic Random Access Memory.

## **Serial Port**

A connection to another device through which data is transferred one bit at a time on a single wire with any other wires only for control of the device not for transfer of data.

## **Shared key authentication**

802.11 network authentication method in which the AP sends the client device a challenge text packet that the client must then encrypt with the correct WEP key and return to the AP. If the client has the wrong key or no key, authentication will fail and the client will not be allowed to associate with the AP. Shared key authentication is not considered secure, because a hacker who detects both the clear-text challenge and the same challenge encrypted with a WEP key can decipher the key.

## **SSID**

Service Set Identifier, a 32-character unique identifier attached to the header of packets sent over a WLAN that acts as a password when a mobile device tries to connect to the BSS. The SSID differentiates one WLAN from another, so all access points and all devices attempting to connect to a specific WLAN must use the same SSID. A device will not be permitted to join the BSS unless it can provide the unique SSID. Because the SSID is broadcast in plain text, it does not supply any security to the network.

## **Standby**

To make inoperative for a period of time. Your LifeBook notebook uses various suspension states to reduce power consumption and prolong the charge of your battery.

## **Status Indicator**

A display which reports the condition of some portion of your hardware.

**Subnet mask**

TCP-IP network is controlled by being divided into multiple smaller networks (subnets). IP address consists of the subnet address and the address of each computer. Subnet mask defines how many bits of IP address comprise the subnet address. The same value shall be set among computers communicating with each other.

**SVGA**

Super VGA.

**S-Video**

Super Video. A component video system for driving a TV or computer monitor.

**System Clock**

An oscillator of fixed precise frequency which synchronizes the operation of the system and is counted to provide time of day and date.

**TCP/IP**

Transmission Control Protocol/Internet Protocol. A standard Internet protocol that is most widely used.

**TFT**

Thin Film Transistor – A technology for flat display panels which uses a thin film matrix of transistors to control each pixel of the display screen individually.

**UL**

Underwriters Laboratories – An independent organization that tests and certifies the electrical safety of devices.

**USB**

Universal Serial Bus. Standard that allows you to simultaneously connect up to 127 USB devices such as game pads, pointing devices, printers, and keyboards to your computer.

**VRAM**

Video Random Access Memory. A memory dedicated to video display data and control.

**WFM**

Wired for Management is Intel's broad-based initiative to reduce the total cost of ownership (TCO) of business computing without sacrificing power and flexibility.

**Wi-Fi Compatible**

Wi-Fi (Wireless Fidelity) Identifies that the product has passed the interoperability test, supplied by the WECA (Wireless Ethernet Compatibility Alliance), which guarantees the interoperability of wireless IEEE 802.11 LAN products. For more information on the Wi-Fi standard, go to the WECA Web site at: [www.wirelessethernet.com](http://www.wirelessethernet.com).

**WLAN**

Wireless Local Area Network. A wireless interconnection of computers and peripherals within a single limited geographic location which can pass programs and data amongst themselves.

# Regulatory Information

## Notice

Changes or modifications not expressly approved by Fujitsu could void this user's authority to operate the equipment.

## FCC NOTICES

### Notice to Users of Radios and Television

This equipment has been tested and found to comply with the limit for class B digital devices, pursuant to parts 15 of the FCC Rules.

These limits are designed to provide reasonable protection against harmful interference in a residential installation. This equipment generates, uses, and can radiate radio frequency energy and, if not installed and used in accordance with the instructions, may cause harmful interference to radio communications. However, there is no guarantee that interference will not occur in a particular installation. If this equipment does cause harmful interference to radio or television reception, which can be determined by turning the equipment off and on, the user is encouraged to try to correct the interference by one or more of the following measures:

- Reorient or relocate the receiving antenna.
- Increase the separation between the equipment and receiver.
- Connect the equipment into an outlet that is on a different circuit than the receiver.
- Consult the dealer or an experienced radio/TV technician for help.

Shielded interconnect cables must be employed with this equipment to ensure compliance with the pertinent RF emission limits governing this device.



## Notice to Users of the US Telephone Network

This equipment complies with Part 68 of the FCC rules, and the requirements adopted by ACTA. On the bottom of this equipment is a label that contains, among other information, the FCC registration number and ringer equivalence number (REN) for this equipment; or a product identifier in the format US:AAAEQ##TXXXX. If requested, this information or number must be provided to the telephone company.

This equipment is designed to be connected to the telephone network or premises wiring using a standard jack type USOC RJ11C. A plug and jack used to connect this equipment to the premises wiring and telephone network must comply with the applicable FCC Part 68 rules and requirements adopted by the ACTA. A compliant telephone cord and modular plug is provided with this product. It is designed to be connected to a compatible modular jack that is also compliant.

The ringer equivalent number (REN) of this equipment is 0.1B as shown on the label. The REN is used to determine the number of devices that may be connected to a telephone line. Excessive RENs on a telephone may result in the devices not ringing in response to an incoming call. In most but not all areas, the sum of RENs should not exceed five (5.0). To be certain of the number of devices that may be connected to a line, as determined by the total RENs, contact the local telephone company.

If this equipment causes harm to the telephone network, the telephone company will notify you in advance that temporary discontinuance of service may be required. But if advance notice isn't practical, the telephone company will notify the customer as soon as possible. Also, you will be advised of your right to file a complaint with the FCC if you believe it is necessary.

The telephone company may make changes in its facilities, equipment, operations or procedures that could effect the operation of the equipment. If this happens the telephone company will provide advance notice in order for you to make necessary modifications to maintain uninterrupted service.

If trouble is experienced with this equipment, for repair or warranty information, please refer to the manual or contact Fujitsu Computer Systems Corporation, Customer Service. If the equipment is causing harm to the telephone network, the telephone company may request that you disconnect the equipment until the problem is resolved.

The equipment cannot be used on public coin service provided by the telephone company. Connection to party line service is subject to state tariffs. (Contact the state public utility commission, public service commission or corporation commission for information).

If your home has specially wired alarm equipment connected to the telephone line, ensure the installation of this computer does not disable your alarm equipment. If you have any questions about what will disable alarm equipment, consult your telephone company or a qualified installer.

The Telephone Consumer Protection Act of 1991 makes it unlawful for any person to use a computer or other electronic device to send any message via a telephone fax machine unless such message clearly contains in a margin at the top or bottom of each transmitted page or on the first page of the transmission, the date and time it is sent and an identification of the business or other entity, or other individual sending the message and the telephone number of the sending machine or such business, other entity, or individual.

## **DOC (INDUSTRY CANADA) NOTICES**

### **Notice to Users of Radios and Television**

This Class B digital apparatus meets all requirements of Canadian Interference-Causing Equipment Regulations.

CET appareil numérique de la class B respecte toutes les exigences du Règlement sur le matériel brouilleur du Canada.

### **Notice to Users of the Canadian Telephone Network**

**NOTICE:** This equipment meets the applicable Industry Canada Terminal Equipment Technical Specifications. This is confirmed by the registration number. The abbreviation, IC, before the registration number signifies that registration was performed based on a Declaration of Conformity indicating that Industry Canada technical specifications were met. It does not imply that Industry Canada approved the equipment.

Before connecting this equipment to a telephone line the user should ensure that it is permissible to connect this equipment to the local telecommunication facilities. The user should be aware that compliance with the certification standards does not prevent service degradation in some situations.

Repairs to telecommunication equipment should be made by a Canadian authorized maintenance facility. Any repairs or alterations not expressly approved by Fujitsu or any equipment failures may give the telecommunication company cause to request the user to disconnect the equipment from the telephone line.

**NOTICE:** The Ringer Equivalence Number (REN) for this terminal equipment is 0.1B. The REN assigned to each terminal equipment provides an indication of the maximum number of terminals allowed to be connected to a telephone interface. The termination on an interface may consist of any combination of devices subject only to the requirement that the sum of the Ringer Equivalence Numbers of all the devices does not exceed five.



FOR SAFETY, USERS SHOULD ENSURE THAT THE ELECTRICAL GROUND OF THE POWER UTILITY, THE TELEPHONE LINES AND THE METALLIC WATER PIPES ARE CONNECTED TOGETHER. USERS SHOULD **NOT** ATTEMPT TO MAKE SUCH CONNECTIONS THEMSELVES BUT SHOULD CONTACT THE APPROPRIATE ELECTRIC INSPECTION AUTHORITY OR ELECTRICIAN. THIS MAY BE PARTICULARLY IMPORTANT IN RURAL AREAS.

### **Avis Aux Utilisateurs Du Réseau Téléphonique Canadien**

**AVIS:** Le présent matériel est conforme aux spécifications techniques d'Industrie Canada applicables au matériel terminal. Cette conformité est confirmée par le numéro d'enregistrement. Le sigle IC, placé devant le numéro d'enregistrement, signifie que l'enregistrement s'est effectué conformément à une déclaration de conformité et indique que les spécifications techniques d'Industrie Canada ont été respectées. Il n'implique pas qu'Industrie Canada a approuvé le matériel.

Avant de connecter cet équipement à une ligne téléphonique, l'utilisateur doit vérifier s'il est permis de connecter cet équipement aux installations de télécommunications locales. L'utilisateur est averti que même la conformité aux normes de certification ne peut dans certains cas empêcher la dégradation du service.

Les réparations de l'équipement de télécommunications doivent être effectuées par un service de maintenance agréé au Canada. Toute réparation ou modification, qui n'est pas expressément approuvée par Fujitsu, ou toute défaillance de l'équipement peut entraîner la compagnie de télécommunications à exiger que l'utilisateur déconnecte l'équipement de la ligne téléphonique.

**AVIS:** L'indice d'équivalence de la sonnerie (IES) du présent matériel est de 0.1B. L'IES assigné à chaque dispositif terminal indique le nombre maximal de terminaux qui peuvent être raccordés à une interface téléphonique. La terminaison d'une interface peut consister en une combinaison quelconque de dispositifs, à la seule condition que la somme d'indices d'équivalence de la sonnerie de tous les dispositifs n'excède pas 5.



**POUR ASSURER LA SÉCURITÉ, LES UTILISATEURS DOIVENT VÉRIFIER QUE LA PRISE DE TERRE DU SERVICE D'ÉLECTRICITÉ, LES LIGNES TÉLPHONIQUES ET LES CONDUITES D'EAU MÉTALLIQUES SONT CONNECTÉES ENSEMBLE. LES UTILISATEURS NE DOIVENT PAS TENTER D'ÉTABLIR CES CONNEXIONS EUX-MÊMES, MAIS DOIVENT CONTACTER LES SERVICES D'INSPECTION D'INSTALLATIONS ÉLECTRIQUES APPROPRIÉS OU UN ÉLECTRICIEN. CECI PEUT ÊTRE PARTICULIÈREMENT IMPORTANT EN RÉGIONS RURALES.**



# Appendix A: WLAN User's Guide

## **FC** FCC Regulatory Information

Please note the following regulatory information related to the optional wireless LAN device.

### **Regulatory Notes and Statements**

#### **Wireless LAN, Health and Authorization for use**

Radio frequency electromagnetic energy is emitted from Wireless LAN devices. The energy levels of these emissions, however, are far much less than the electromagnetic energy emissions from wireless devices such as mobile phones. Wireless LAN devices are safe for use by consumers because they operate within the guidelines found in radio frequency safety standards and recommendations. The use of Wireless LAN devices may be restricted in some situations or environments, such as:

- On board an airplane, or
- In an explosive environment, or
- In situations where the interference risk to other devices or services is perceived or identified as harmful.

In cases in which the policy regarding use of Wireless LAN devices in specific environments is not clear (e.g., airports, hospitals, chemical/oil/gas industrial plants, private buildings), obtain authorization to use these devices prior to operating the equipment.

#### **Regulatory Information/Disclaimers**

Installation and use of this Wireless LAN device must be in strict accordance with the instructions included in the user documentation provided with the product. Any changes or modifications made to this device that are not expressly approved by the manufacturer may void the user's authority to operate the equipment. The manufacturer is not responsible for any radio or television interference caused by unauthorized modification of this device, or the substitution or attachment of connecting

cables and equipment other than those specified by the manufacturer. It is the responsibility of the user to correct any interference caused by such unauthorized modification, substitution or attachment. The manufacturer and its authorized resellers or distributors will assume no liability for any damage or violation of government regulations arising from failure to comply with these guidelines.

This device must not be co-located or operated in conjunction with any other antenna or transmitter.

**For IEEE 802.11a Wireless LAN:** For operation within 5.15~5.25 GHz frequency range, it is restricted to indoor environments, and the antenna of this device must be integral.

### **Federal Communications Commission statement**

This device complies with Part 15 of FCC Rules.

Operation is subject to the following two conditions: (1) This device may not cause interference, and, (2) This device must accept any interference, including interference that may cause undesired operation of this device.

### **FCC Interference Statement**

This equipment has been tested and found to comply with the limits for a Class B digital device, pursuant to Part 15 of the FCC Rules. These limits are designed to provide reasonable protection against harmful interference in a residential installation. This equipment generates, uses, and can radiate radio frequency energy. If not installed and used in accordance with the instructions, it may cause harmful interference to radio communications. However, there is no guarantee that interference will not occur in a particular installation.

If this equipment does cause harmful interference to radio or television reception, which can be determined by turning the equipment off and on, the user is encouraged to try and correct the interference by one or more of the following measures:

- 1** Reorient or relocate the receiving antenna.
- 2** Increase the distance between the equipment and the receiver.
- 3** Connect the equipment to an outlet on a circuit different from the one the receiver is connected to.
- 4** Consult the dealer or an experienced radio/TV technician for help.

### **FCC Radio Frequency Exposure statement**

The available scientific evidence does not show that any health problems are associated with using low power wireless devices. There is no proof, however, that these low power wireless devices are absolutely safe. Low power wireless devices emit low levels of radio frequency energy (RF) in the microwave range while being used. Whereas high levels of RF can produce health effects (by heating tissue), exposure to low-level RF that does not produce heating effects causes no known adverse health effects. Many studies of low-level RF exposure have not

found any biological effects. Some studies have suggested that some biological effects might occur, but such findings have not been confirmed by additional research. The wireless LAN radio device has been tested and found to comply with FCC radiation exposure limits set forth for an uncontrolled equipment and meets the FCC radio frequency (RF) Exposure Guidelines in Supplement C to OET65.



**DO NOT USE THE NOTEBOOK ON YOUR LAP. USING IT ON YOUR LAP WILL BLOCK THE AIR VENTS, WHICH COULD RESULT IN DAMAGE TO THE SYSTEM AND ALSO CAN REDUCE THE RF EXPOSURE SAFETY DISTANCE DURING RADIO OPERATION.**

### **Minimum Separation Distance from Transmitting Antennas**

The actual RF exposure from the Radio antenna largely depends on the distance between the antenna and the user. For mobile applications where antenna is at least 20cms away from the user body, SAR (Specific Absorption Rate) tests are exempt and RF evaluation or Maximum Permissible Exposure (MPE) applies.

This equipment has been evaluated for “Mobile Devices” RF safety and COMPLIES with International Guidelines for Electromagnetic Radiation — Human Exposure standards: USA FCC OET 65 supplement C / IEEE C95.1 / European EN50371 / Australian RF Human exposure standard 2003.

RF safety standard for most other countries are derived from one of the standards stated above.

### **Export restrictions**

This product or software contains encryption code which may not be exported or transferred from the US or Canada without an approved US Department of Commerce export license. This device complies with Part 15 of FCC Rules., as well as ICES 003 B / NMB 003 B. Operation is subject to the following two conditions: (1) this device may not cause harmful interference, and (2) this device must accept any interference received, including interference that may cause undesirable operation. Modifications not expressly authorized by Fujitsu Computer Systems Corp. may invalidate the user's right to operate this equipment.

### **Canadian Notice**

The device for the 5150 - 5250 MHz band is only for indoor usage to reduce the potential for harmful interference to co-channel mobile satellite systems.

The maximum antenna gain of 6 dBi permitted (for devices in the 5250 - 5350 MHz, 5470 - 5725 MHz and 5725 - 5825 MHz bands) to comply with the e.i.r.p. limit as stated in A9.2 of RSS210.

In addition, users are cautioned to take note that high power radars are allocated as primary users (meaning they have priority) of 5250 - 5350 MHz and 5650 - 5850 MHz and these radars could cause interference and/or damage to LE-LAN devices.

## Before Using the Optional Wireless LAN

This manual describes the procedures required to properly set up and configure the optional integrated Wireless LAN Mini-PCI device (referred to as "WLAN device" in the rest of the manual). Before using the WLAN device, read this manual carefully to ensure it's correct operation. Keep this manual in a safe place for future reference.

### Wireless LAN Device Covered by this Document

This document is applicable to systems containing Atheros® AR5006EXS (AR5BXB6) Mini-Card Wireless network card (802.11a+b/g)

### Characteristics of the WLAN Device

- The WLAN device is a Mini-PCI card attached to the main board of the mobile computer.
- The WLAN device operates in license-free RF bands, eliminating the need to procure an FCC operating license. The WLAN operates in the 2.4GHz Industrial, Scientific, and Medical (ISM) RF band and the lower, middle, and upper bands of the 5GHz Unlicensed National Information Infrastructure (UNII) bands.
- The WLAN device is capable of three operating modes, IEEE802.11a, IEEE802.11b, and IEEE802.11g.
- The WLAN device is Wi-Fi certified and operate (as applicable) at a the maximum data rate of 540 Mbps (theoretical) in IEEE802.11n (draft) mode; 54 Mbps in IEEE802.11a or IEEE802.11g mode; and 11 Mbps in IEEE802.11b mode.
- The WLAN device supports the following encryption methods - WEP, TKIP, CKIP, and AES encryption.
- The Wireless LAN device is compliant with the following standards: WPA, WPA2, CCX1.0, CCX2.0, CCX3.0, and CCX4.0.



## Wireless LAN Modes Using this Device

### Ad Hoc Mode

"Ad Hoc Mode" refers to a wireless network architecture where wireless network connectivity between multiple computers is established without a central wireless network device, typically known as Access Point(s). Connectivity is accomplished using only client devices in a peer-to-peer fashion. That is why Ad Hoc networks are also known as peer-to-peer networks. Ad Hoc networks are an easy and inexpensive method for establishing network connectivity between multiple computers. Ad Hoc mode requires that the SSID, network authentication, and encryption key settings are identically configured on all computers in the Ad Hoc network.

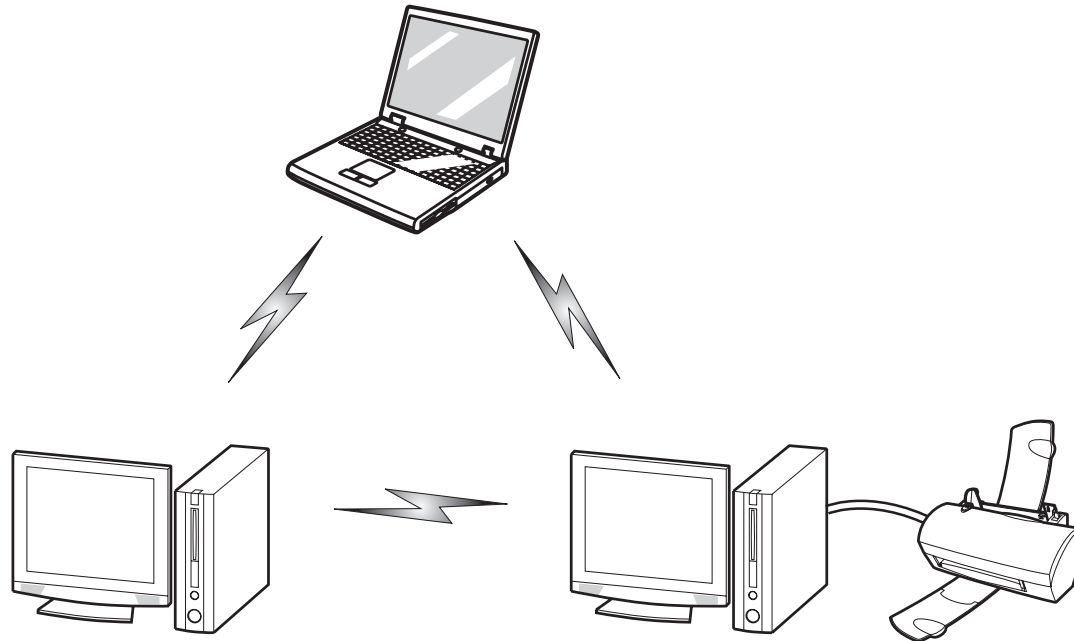

**Figure 35. Ad Hoc Mode Network**

## Access Point (Infrastructure) Mode

Infrastructure mode refers to a wireless network architecture in which devices communicate with wireless or wired network devices by communicating through an Access Point. In infrastructure mode, wireless devices can communicate with each other or with a wired network. Corporate wireless networks operate in infrastructure mode because they require access to the WLAN in order to access services, devices, and computers (e.g., file servers, printers, databases).

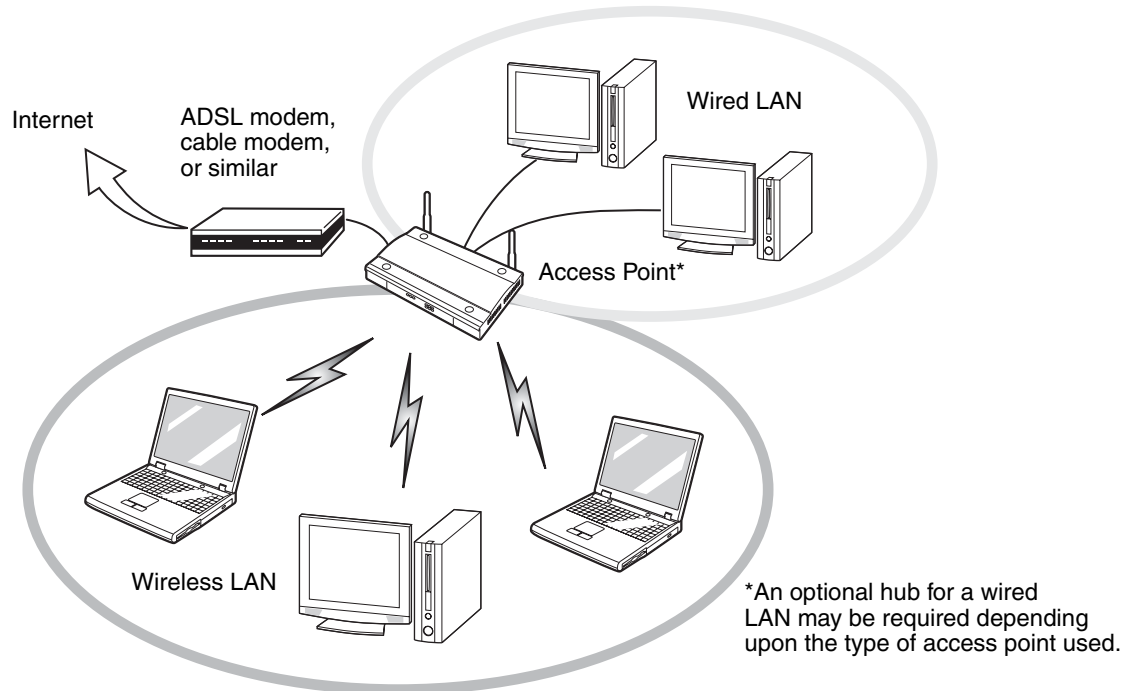

**Figure 36. Access Point (Infrastructure) Mode Network**

## How to Handle This Device

The WLAN device is a device that comes pre-installed in your mobile computer. Under normal circumstances, it should not be necessary for you to remove or re-install it. The operating system that your mobile computer comes with has been pre-configured to support the WLAN device.

- The Atheros WLAN device supports IEEE802.11a, IEEE802.11b, and IEEE802.11g.
- The WLAN device operates in the 2.4 GHz ISM band and the 5 GHz lower, middle, and upper UNII bands.
- Microwave ovens may interfere with the operation of WLAN devices since they operate in the same 2.4 GHz frequency range as IEEE802.11b/g devices. Interference by microwaves does not occur with IEEE802.11a radio which operates in the 5 GHz RF band.
- Wireless devices that transmit in the 2.4 GHz range may interfere with operation of WLAN devices in IEEE802.11b/g modes. Symptoms of interference include reduced throughput, intermittent disconnects, and many frame errors. It is HIGHLY recommended that these interfering devices be powered off to ensure proper operation of the WLAN device.

## Deactivating/Disconnecting the WLAN Device

Disconnecting the WLAN device may be desired in certain circumstances (to extend battery life) or where certain environments require it (i.e. hospitals, clinics, airplanes, etc.). The WLAN device can be deactivated by using the Wireless On/Off Switch, and it can be disconnected in Windows using the WLAN icon in the system tray (Note that disconnecting via the icon in the system tray does not turn off the radio; it continues to transmit and receive even though it's not connected.).



BEFORE USING THE WIRELESS LAN DEVICE, YOU MUST FIRST INSTALL CLICKME! TO ENSURE THAT THE CORRECT SOFTWARE FOR YOUR DEVICE IS INSTALLED. SEE "INSTALLING CLICKME!" ON PAGE 68.

## Deactivation Using the Wireless On/Off Switch

The WLAN device can be deactivated quickly and efficiently by toggling the Wireless LAN/Bluetooth On/Off Switch to the Off position. The switch has no effect on non-Wireless LAN models. The switch is located on the left side of the system (Figure 37)

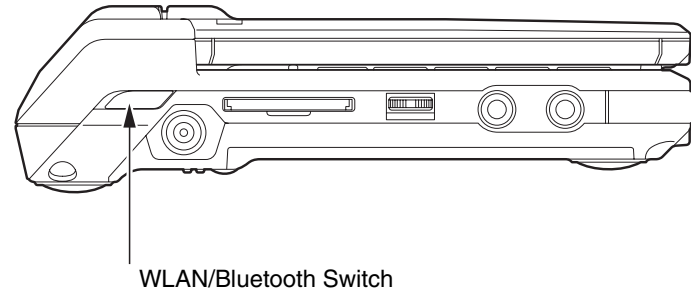

**Figure 37. Wireless LAN/Bluetooth On/Off Switch Location**

## Disconnection Using the Icon in the Taskbar

Note that disconnecting via the icon in the system tray does not turn off the radio; it continues to transmit and receive even though it's not connected.

- 1** Right-click the WLAN icon in the taskbar at the bottom right of your screen.
- 2** Choose Disconnect from a network.

## Activating the WLAN Device

Activation of the WLAN device can be accomplished using the same methods as the deactivation process

- Using the Wireless On/Off Switch
- In Windows, by right-clicking the WLAN icon then clicking "Connect to a network"

# Configuring the Wireless LAN

The optional WLAN device can be configured to establish wireless network connectivity using the software that is built into Windows Vista. Support for most industry standard security solutions is contained in this software.

Pre-defined parameters will be required for this procedure. Please consult with your network administrator for these parameters:

## Configuring the WLAN Using Windows Vista

- 1** Click the Start button, then select Control Panel.
- 2** If the Control Panel is not in Classic View, select Classic View from the left panel. Double-click the Network and Sharing Center icon.
- 3** Select “Manage wireless networks” from the left panel.
- 4** Click on the [Add] button.
- 5** Depending upon what type of connection you would like to make, make a selection. For an infrastructure network, select “Manually create a network profile. For ad hoc network, select “Create an ad hoc network”.
- 6** Enter the required information. It may be necessary to consult with your network administrator for some of the information.
- 7** In the event you require assistance, go to the Network and Sharing Center window (Start -> Control Panel -> Network and Sharing Center), and type in relevant keywords in the Search box.

## Connecting to a Network

After you have configured your computer, you can connect to an active network by performing the following steps:

- 1** Click on the WLAN icon in the system tray.
- 2** Select “Connect to a network”.
- 3** Select a network from the list that appears, and click the [Connect] button.

## Configuring the WLAN Using Windows XP

### Procedure

- 1 Click the Start button, then select Control Panel.
- 2 If the Control Panel is not in Classic View, select Classic View from the left panel. Double-click the Network Connections icon.
- 3 Select “New Connection” wizard.
- 4 Click the [Next] button.
- 5 Select “Connect to the Internet”, then click [Next].
- 6 Depending upon what type of connection you would like to make, make a selection. For an infrastructure network, select “Manually create a network profile. For ad hoc network, select “Choose from a list of Internet service providers”.
- 7 Enter any required information. It may be necessary to consult with your network administrator for some of the information.
- 8 In the event you require assistance, go to [Start] -> Help and Support -> Networking and the Web. Select the main topic in which you are interested, then type in relevant keywords in the Search box.

### Connection to the network

After you have configured your computer, you can connect to an active network by clicking on the Wireless Network icon in the system tray:

# Troubleshooting the WLAN

## Troubleshooting

Causes and countermeasures for troubles you may encounter while using your wireless LAN are described in the following table. If you are unfamiliar with the steps required, consult your System Administrator or go to [Start] -> Help and Support -> Networking and the Web

Problem	Possible Cause	Possible Solution
Unavailable network connection	Incorrect network name (SSID) or network key	<p><b>Ad hoc connection:</b> verify that the network names (SSID's) and network keys (WEP) of all computers to be connected have been configured correctly. SSID's and WEP key values must be identical on each machine.</p> <p><b>Access Point (Infrastructure) connection:</b> set network name (SSID) and network key to the same values as those of the access point.</p> <p>Set the Network Authentication value identically to that of the Access Point. Consult your network administrator for this value, if necessary.</p>
	Weak received signal strength and/or link quality	<p>Ad hoc connection: Retry connection after shortening the distance to the destination computer or removing any obstacles for better sight.</p> <p>Access Point (Infrastructure) connection: Retry connection after shortening the distance to the access point or removing any obstacles for better sight.</p>
	The WLAN device has been deactivated or disabled	<p>Check if the wireless switch is turned On. In Windows XP, go to Start -&gt; Control Panel-&gt; Network Connections and right-click on Wireless Network Connection. If Enable appears at the top of the menu, click it to enable the device. In Windows Vista, go to Start -&gt; Control Panel, and double-click on Windows Mobility Center. If the wireless network is off, click the [Turn wireless on] button..</p>

<b>Problem</b>	<b>Possible Cause</b>	<b>Possible Solution</b>
Unavailable network connection	The computer to be connected is turned off	Check if the computer to be connected is turned ON.
(continued)	RF interference from Access Points or other wireless networks	The use of identical or overlapping RF channels can cause interference with the operation of the WLAN device. Change the channel of your Access Point to a channel that does not overlap with the interfering device.
	Wireless network authentication has failed	Re-check your Network Authentication, Encryption, and Security settings. Incorrectly configured security settings such as an incorrectly typed WEP key, a mis-configured LEAP username, or an incorrectly chosen authentication method will cause the LAN device to associate but not authenticate to the wireless network.
	Incorrectly configured network settings	Recheck the configuration of your network settings.
	Incorrect IP address configuration	This only applies to networks using static IP addresses. Please contact your network administrator for the correct settings.



# WLAN Specifications

## Specifications

Item	Specification
Type of network	The Atheros AR5006EXS (AR5BXB6) Mini-Card Wireless network card conforms to IEEE802.11a, IEEE802.11b, and IEEE802.11g, Wi-Fi based*
Transfer rate	(Automatic switching) 54 Mbps maximum data rate
Active frequency	<ul style="list-style-type: none"><li>• 802.11n (draft): 2.4 GHz or 5 GHz</li><li>• 802.11b/g: 2400~2473 MHz</li><li>• 802.11a: 4900 ~ 5850 MHz</li></ul>
Typical operating distances**	<ul style="list-style-type: none"><li>• 802.11a: 40 ft. (12 m) @ 54 Mbps; 300 ft. (91 m) @ 6 Mbps</li><li>• 802.11b: 100 ft. (30 m) @ 11 Mbps; 300 ft. (91 m) @ 1 Mbps</li><li>• 802.11g: 100 ft. (30 m) @ 54 Mbps; 300 ft. (91 m) @ 1 Mbps</li></ul>
Number of channels	<ul style="list-style-type: none"><li>• 802.11a: 8 independent channels</li><li>• 802.11b/g: 11 channels, 3 non-overlapping channels</li></ul>
Security	Encryption Types - WEP, TKIP, AES***, WPA 1.0 compliant Encryption Key lengths Supported: 64 bits and 128 bits 802.1x/EAP
Maximum recommended number of computers to be connected over wireless LAN (during ad hoc connection)	10 units or less ****

\* “Wi-Fi based” indicates that the interconnectivity test of the organization which guarantees the interconnectivity of wireless LAN (Wi-Fi Alliance) has been passed.

\*\* The communication ranges shown above will increase or decrease depending on factors such as number of walls, reflective material, or interference from external RF sources.

\*\*\* Encryption with network key (WEP) is performed using the above number of bits, however, users can set 40 bits/ 104 bits after subtracting the fixed length of 24 bits.

\*\*\*\* Depending on practical environments, the allowable number of computers to be connected may be decreased.

## Using the Bluetooth Device

The Integrated Bluetooth module (EYTF3CSFT) is an optional device available for Fujitsu mobile computers.

### What is Bluetooth

Bluetooth technology is designed as a short-range wireless link between mobile devices, such as laptop computers, phones, printers, and cameras. Bluetooth technology is used to create Personal Area Networks (PANs) between devices in short-range of each other.



THE WIRELESS LAN/BLUETOOTH ON/OFF SWITCH WILL POWER OFF BOTH THE OPTIONAL WIRELESS LAN AND BLUETOOTH DEVICES AT THE SAME TIME. TO ENABLE OR DISABLE EITHER ONE OF THE DEVICES INDIVIDUALLY, PERFORM THE FOLLOWING STEPS:

- 1** Slide the Wireless LAN/Bluetooth on/off switch to On position.
- 2** In the Control Panel, click the button associated with Bluetooth and/or Wireless LAN Status to enable or disable the individual devices.
- 3** Click [OK].

### Where to Find Information About Bluetooth

The Bluetooth module contains a robust Help user's guide to assist you in learning about operation of the Bluetooth device.

Windows XP: To access the Help file, click [Start] -> All Programs, and click on Toshiba. Select Bluetooth, then select User's Guide.

Windows Vista: o access the Help file, click [Start] -> All Programs, and click on Bluetooth, then select User's Guide.

For additional information about Bluetooth Technology, visit the Bluetooth Web site at: [www.bluetooth.com](http://www.bluetooth.com).

## **FCC Radiation Exposure Statement**

This equipment complies with FCC radiation exposure limits set forth for an uncontrolled environment. The Bluetooth antenna is located above the [Backspace/Delete] key and is exempt from minimum distance criteria due to its low power.

The transmitters in this device must not be co-located or operated in conjunction with any other antenna or transmitter.

## **Canadian Notice**

To prevent radio interference to the licensed service, this device is intended to be operated indoors and away from windows to provide maximum shielding. Equipment (or its transmit antenna) that is installed outdoors is subject to licensing.

## **Warranty**

Users are not authorized to modify this product. Any modifications invalidate the warranty.

This equipment may not be modified, altered, or changed in any way without signed written permission from Fujitsu. Unauthorized modification will void the equipment authorization from the FCC and Industry Canada and the warranty.

# Appendix B: Fingerprint Sensor Device

## Introducing the Fingerprint Sensor Device

Your system has a fingerprint sensor device at the bottom left below the display screen.

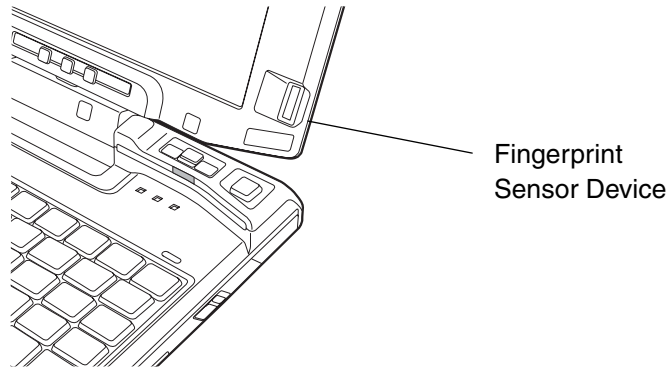

**Figure 38. Fingerprint sensor**

With a fingerprint sensor, you can avoid having to enter a username and password every time you want to:

- Log onto Windows
- Resume from standby mode
- Cancel a password-protected screen saver
- Log into homepages that require a username and password

After you have “enrolled” - or registered - your fingerprint, you can simply swipe your fingertip over the sensor for the system recognize you.

The fingerprint sensor uses Softex OmniPass which provides password management capabilities to Microsoft Windows operating systems. OmniPass enables you to use a "master password" for all Windows, applications, and on-line passwords.

OmniPass requires users to authenticate themselves using the fingerprint sensor before granting access to the Windows desktop. This device results in a secure authentication system for restricting access to your computer, applications, web sites, and other password-protected resources.

OmniPass presents a convenient graphical user interface, through which you can securely manage passwords, users, and multiple identities for each user.

## Getting Started

This section guides you through the preparation of your system for the OmniPass fingerprint recognition application. You will be led through the OmniPass installation process. You will also be led through the procedure of enrolling your first user into OmniPass.

## Installing OmniPass

If OmniPass has already been installed on your system, skip this section and go directly to “User Enrollment” on page 169. You can determine whether OmniPass has already been installed by checking to see if the following are present:

- The gold key-shaped OmniPass icon in the system tray at the bottom right of the screen.
- The Softex program group in the **Programs** group of the **Start** menu

## System Requirements

The OmniPass application requires space on your hard drive; it also requires specific Operating Systems (OS’s). The minimum requirements are as follows:

- Windows XP Professional operating system
- At least 35 MB available hard disk space

## Installing the OmniPass Application

If OmniPass is already installed on your system, go to “User Enrollment” on page 169. Otherwise continue with this section on software installation.



- INSTALLATION OF THE APPLICATION REQUIRES THAT YOU HAVE AN EXTERNAL OPTICAL DRIVE ATTACHED TO YOUR SYSTEM.
- FOR INSTALLATION, OMNIPASS REQUIRES THAT THE USER INSTALLING OMNIPASS HAVE ADMINISTRATIVE PRIVILEGES TO THE SYSTEM. IF YOUR CURRENT USER DOES NOT HAVE ADMINISTRATIVE PRIVILEGES, LOG OUT AND THEN LOG IN WITH AN ADMINISTRATOR USER BEFORE PROCEEDING WITH OMNIPASS INSTALLATION.

To install OmniPass on your system you must:

- 1** Insert the installation media for the OmniPass application into the appropriate drive. If you are installing from CD-ROM or DVD-ROM, you must find and launch the OmniPass installation program (setup.exe) from the media.
- 2** Follow the directions provided in the OmniPass installation program. Specify a location to which you would like OmniPass installed. It is recommended that you NOT install OmniPass in the root directory (e.g. C:\).
- 3** Once OmniPass has completed installation you will be prompted to restart you system. Once your system has rebooted you will be able to use OmniPass. If you choose not to restart immediately after installation, OmniPass will not be available for use until the next reboot.
- 4** The installation program automatically places an icon (Softex OmniPass) in the Windows Control Panel as well as a golden key shaped icon in the taskbar.

## Verifying Information about OmniPass

After you have completed installing OmniPass and restarted your system, you may wish to check the version of OmniPass on your system.

To check the version information of OmniPass:

- 1** From the Windows Desktop, double-click the key-shaped OmniPass icon in the taskbar (usually located in the lower right corner of the screen),  
or,  
Click the **Start** button, select **Settings**, and click **Control Panel** (if you are using Windows XP you will see the Control Panel directly in the Start menu; click it, then click **Switch to Classic View**). Double-click **Softex OmniPass** in the Control Panel, and the OmniPass Control Center will appear. If it does not appear, then the program is not properly installed,  
or,  
Click the **Start** button, select **Programs**, and from the submenu select the **Softex** program group, from that submenu click **OmniPass Control Center**.
- 2** Select the **About** tab at the top of the OmniPass Control Panel. The About tab window appears with version information about OmniPass.

## Uninstalling OmniPass



FOR UNINSTALLATION, OMNIPASS REQUIRES THAT THE USER UNINSTALLING OMNIPASS HAVE ADMINISTRATIVE PRIVILEGES TO THE SYSTEM. IF YOUR CURRENT USER DOES NOT HAVE ADMINISTRATIVE PRIVILEGES, LOG OUT AND THEN LOG IN WITH AN ADMINISTRATOR USER BEFORE PROCEEDING WITH OMNIPASS UNINSTALLATION.

To remove the OmniPass application from your system:

- 1** Click **Start** on the Windows taskbar. Select **Settings**, and then **Control Panel**.
- 2** Double-click **Add/Remove Programs**.
- 3** Select **OmniPass**, and then click **Change/Remove**.
- 4** Follow the directions to uninstall the OmniPass application.
- 5** Once OmniPass has finished uninstalling, reboot your system when prompted.

## User Enrollment

Before you can use any OmniPass features you must first enroll a user into OmniPass.

### Master Password Concept

Computer resources are often protected with passwords. Whether you are logging into your computer, accessing email, e-banking, paying bills online, or accessing network resources, you often have to supply credentials to gain access. This can result in dozens of sets of credentials that you have to remember.

During user enrollment a "master password" is created for the enrolled user. This master password "replaces" all other passwords for sites you register with OmniPass.

**Example:** A user, John, installs OmniPass on his system (his home computer) and enrolls an OmniPass user with username "John\_01" and password "freq14". He then goes to his webmail site to log onto his account. He inputs his webmail credentials as usual (username "John\_02" and password "lifebook"), but instead of clicking [Submit], he directs OmniPass to **Remember Password**. Now whenever he returns to that site, OmniPass will prompt him to supply access credentials.

John enters his OmniPass user credentials ("John\_01" and "freq14") in the OmniPass authentication prompt, and he is allowed into his webmail account. He can do this with as many web sites or password protected resources he likes, and he will gain access to all those sites with his OmniPass user credentials ("John\_01" and "freq14"). This is assuming he is accessing those sites with the system onto which he enrolled his OmniPass user. OmniPass does not actually change the credentials of the password protected resource. If John were to go to another computer without he OmniPass account to access his webmail, he would need to enter his original webmail credentials ("John\_02" and "lifebook") to gain access. If he attempts his OmniPass credentials on a system other than a system he's enrolled on, he won't gain access.



THE ENROLLMENT PROCEDURE ASSUMES YOU HAVE NO HARDWARE AUTHENTICATION DEVICES OR ALTERNATE STORAGE LOCATIONS THAT YOU WISH TO INTEGRATE WITH OMNIPASS. IF YOU DESIRE SUCH FUNCTIONALITY, CONSULT THE APPROPRIATE SECTIONS OF THIS DOCUMENT.



## Basic Enrollment

The Enrollment Wizard will guide you through the process of enrolling a user. Unless you specified otherwise, after OmniPass installation the Enrollment Wizard will launch on Windows login. If you do not see the Enrollment Wizard, you can bring it up by clicking **Start** on the Windows taskbar; select **Programs**; select **Softex**; click **OmniPass Enrollment Wizard**.

- 1** Click **Enroll** to proceed to username and password verification. By default, the OmniPass Enrollment Wizard enters the credentials of the currently logged in Windows user.
- 2** Enter the password you use to log in to Windows. This will become the “master password” for this OmniPass user. In most cases, the **Domain:** value will be your Windows computer name. In a corporate environment, or when accessing corporate resources, the **Domain:** may not be your Windows computer name. Click [Next] to continue.
- 3** In this step OmniPass captures your fingerprint. Refer to “Enrolling a Fingerprint” on page 170 for additional information.
- 4** Next, choose how OmniPass notifies you of various events. We recommend you keep **Taskbar Tips** on **Beginner mode taskbar tips** and **Audio Tips** on at least **Prompt with system beeps only** until you get accustomed to how OmniPass operates. Click [Next] to proceed with user enrollment. You will then see a Congratulations screen indicating your completion of user enrollment.
- 5** Click [Done] to exit the OmniPass Enrollment Wizard. You will be asked if you’d like to log in to OmniPass with your newly enrolled user; click [Yes].

## Enrolling a Fingerprint

Enrolling a fingerprint will increase the security of your system and streamline the authentication procedure.

You enroll fingerprints in the OmniPass Control Center. With an OmniPass user logged in, double-click the system tray OmniPass icon. Select the **User Settings** tab and click **Enrollment** under the **User Settings** area. Click **Enroll Authentication Device** and authenticate at the authentication prompt to start device enrollment.

1. During initial user enrollment, you will be prompted to select the finger you wish to enroll. Fingers that have already been enrolled will be marked by a green check. The finger you select to enroll at this time will be marked by a red arrow. OmniPass will allow you re-enroll a finger. If you choose a finger that has already been enrolled and continue enrollment, OmniPass will enroll the fingerprint, overwriting the old fingerprint. Select a finger to enroll and click [Next].
2. It is now time for OmniPass to capture your selected fingerprint. It may take a several capture attempts before OmniPass acquires your fingerprint. Should OmniPass fail to acquire your fingerprint, or if the capture screen times out, click [Back] to restart the fingerprint enrollment process.

Your system has a “swipe” fingerprint sensor. A swipe sensor is small and resembles a skinny elongated rectangle. To capture a fingerprint, gently swipe or pull your fingertip over the sensor (starting at the second knuckle) **towards yourself**. Swiping too fast or too slow will result in a failed capture. The **Choose Finger** screen has a [Practice] button; click it to practice capturing your fingerprint. When you are comfortable with how your fingerprint is captured, proceed to enroll a finger.

3. Once OmniPass has successfully acquired the fingerprint, the **Verify Fingerprint** screen will automatically appear. To verify your enrolled fingerprint, place your fingertip on the sensor and hold it there as if you were having a fingerprint captured. Successful fingerprint verification will show a green fingerprint in the capture window and the text **Verification Successful** under the capture window.

## Using OmniPass

You are now ready to begin using OmniPass. Used regularly, OmniPass will streamline your authentications.

### Password Replacement

You will often use the password replacement function. When you go to a restricted access website (e.g., your bank, your web-based email, online auction or payment sites), you are always prompted to enter your login credentials. OmniPass can detect these prompts and you can teach OmniPass your login credentials. The next time you go to that website, you can authenticate with your fingerprint to gain access.

## OmniPass Authentication Toolbar

After installing OmniPass and restarting, you will notice a dialog you have not seen before at Windows Logon. This is the OmniPass Authentication Toolbar, and it is displayed whenever the OmniPass authentication system is invoked. The OmniPass authentication system may be invoked frequently: during Windows Logon, during OmniPass Logon, when unlocking your workstation, when resuming from standby or hibernate, when unlocking a password-enabled screensaver, during password replacement for remembered site or application logins, and more. When you see this toolbar, OmniPass is prompting you to authenticate.

The **Logon Authentication** window indicates what OmniPass-restricted function you are attempting. The icons in the lower left (fingerprint and key) show what authentication methods are available to you. Selected authentication methods are highlighted while unselected methods are not. When you click the icon for an unselected authentication method, the authentication prompt associated with that method is displayed.

When prompted to authenticate, you must supply the appropriate credentials: an enrolled finger for the fingerprint capture window or your master password for the master password prompt (the key icon).

## Remembering a Password

OmniPass can remember any application, GUI, or password protected resource that has a password prompt.

Using the following procedure, you can store a set of credentials into OmniPass. These credentials will then be linked to your “master password” or fingerprint.

Go to a site that requires a login (username and password), but *do not log in yet*. At the site login prompt, enter your username and password in the prompted fields, but *do not enter the site* (do not hit [Enter], [Submit], [OK], or Login). Right-click the OmniPass system tray icon and select **Remember Password** from the submenu. The Windows arrow cursor will change to a golden key OmniPass cursor. Click the OmniPass cursor in the login prompt area, but don't click [Login] or [Submit].

## Associating a Friendly Name

After clicking the OmniPass key cursor near the login prompt, OmniPass will prompt you to enter a “friendly name” for this site. You should enter something that reminds you of the website, the company, or the service you are logging into. In its secure database, OmniPass associates this friendly name with this website.

## Additional Settings for Remembering a Site

When OmniPass prompts you to enter a “friendly name” you also have the opportunity to set how OmniPass authenticates you to this site. There are three effective settings for how OmniPass handles a remembered site.

The default setting is **Automatically click the “OK” or “Submit” button for this password protected site once the user is authenticated.** With this setting, each time you navigate to this site OmniPass will prompt you for your master password or fingerprint authentication device. Once you have authenticated with OmniPass, you will automatically be logged into the site.

Less secure is the option to **Automatically enter this password protected site when it is activated. Do not prompt for authentication.** Check the upper box to get this setting, and each time you navigate to this site OmniPass will log you into the site without prompting you to authenticate.



THIS SETTING IS MORE CONVENIENT IN THAT WHENEVER YOU GO TO A SITE REMEMBERED WITH THIS SETTING, YOU WILL BYPASS ANY AUTHENTICATION PROCEDURE AND GAIN INSTANT ACCESS TO THE SITE. BUT SHOULD YOU LEAVE YOUR SYSTEM UNATTENDED WITH YOUR OMNIPASS USER LOGGED IN, ANYONE USING YOUR SYSTEM CAN BROWSE TO YOUR PASSWORD PROTECTED SITES AND GAIN AUTOMATIC ACCESS.

If you uncheck both boxes in **Settings for this Password Site**, OmniPass will prompt you for your master password or fingerprint authentication device. Once you have authenticated with OmniPass your credentials will be filled in to the site login prompt, but you will have to click the website [OK], [Submit], or [Login] button to gain access to the site.

Click **Finish** to complete the remember password procedure. The site location, the credentials to access the site, and the OmniPass authentication settings for the site are now stored in the OmniPass secure database. The OmniPass authentication settings (**Settings for this Password Site**) can always be changed in **Vault Management**.

### **Logging in to a Remembered Site**

Whether or not OmniPass prompts you to authenticate when you return to a remembered site is determined by **Settings for this Password Site** and can be changed in **Vault Management**.

The following cases are applicable to using OmniPass to login to: Windows, remembered web sites, and all other password protected resources.

#### **With Master Password**

Once you return to a site you have remembered with OmniPass, you may be presented with a master password prompt. Enter your master password and you will be allowed into the site.

#### **Logging into Windows with a Fingerprint Device**

When logging into Windows with a fingerprint device, the fingerprint capture window will now appear next to the Windows Login screen. Place your enrolled fingertip on the sensor to authenticate. You will be simultaneously logged into Windows and OmniPass. The capture window will also appear if you have used **Ctrl-Alt-Del** to lock a system, and the fingerprint device can be used to log back in as stated above.



IF A MACHINE IS LOCKED AND OMNIPASS DETECTS A DIFFERENT USER LOGGING BACK IN WITH A FINGERPRINT, THE FIRST USER WILL BE LOGGED OUT AND THE SECOND USER LOGGED IN.

In Windows XP, your login options must be set either for classic login, or for fast user switching and logon screen to be enabled to use your fingerprint to log on to Windows. To change this go to **Control Panel**, select **User Accounts** and then click **Change the way users log on or off**. If your Windows screensaver

is password protected, the fingerprint capture window will now appear next to screensaver password dialog during resume. You can authenticate to your screensaver password prompt with your enrolled finger.

## **Password Management**

OmniPass provides an interface that lets you manage your passwords. To access this GUI, double-click the OmniPass key in the system tray. Click **Vault Management**; you will be prompted to authenticate. Once you gain access to **Vault Management**, click **Manage Passwords** under **Vault Settings**. You will see the **Manage Passwords** interface, with a list of friendly names.

You can view the credentials stored for any remembered website by highlighting the desired resource under **Password Protected Dialog** and clicking **Unmask Values**. Should a password be reset, or an account expire, you can remove stored credentials from OmniPass. Highlight the desired resource under **Password Protected Dialog** and click **Delete Page**. You will be prompted to confirm the password deletion.

The two check boxes in **Manage Passwords** govern whether OmniPass prompts you to authenticate or directly logs you into the remembered site.

OmniPass will overwrite an old set of credentials for a website if you attempt to use **Remember Password** on an already remembered site.

The exception to the above rule is when resetting the Windows password. If your password is reset in Windows, the next time you login to Windows, OmniPass will detect the password change and prompt you to “Update” or “Reconfirm” the password with OmniPass. Enter your new Windows password in the prompt and click **OK**. Your OmniPass "master password" will still be your Windows password.

## **OmniPass User Identities**

Identities allow OmniPass users to have multiple accounts to the same site (e.g., *bob@biblomail.com* and *boballen@biblomail.com*). If OmniPass did not provide you identities, you would be limited to remembering one account per site.

To create and manage identities, double-click the OmniPass key in the system tray. Click **Vault Management**; OmniPass will prompt you to authenticate. Once you gain access to **Vault Management**, click **Manage Identities** under **Vault Settings**. You can only manage the identities of the currently logged in OmniPass user

To add a new identity, click **New Identity** or double-click **Click here to add a new identity**. Name the new identity and click [OK], then click [Apply]. You can now switch to the new identity and start remembering passwords.

To delete an identity, highlight the identity you want to delete and click [Delete Identity], then click [Apply].



WHEN YOU DELETE AN IDENTITY, ALL OF ITS ASSOCIATED REMEMBERED SITES AND PASSWORD PROTECTED DIALOGS ARE LOST.

To set the default identity, highlight the identity you want as default and click [Set as Default]; click [Apply] to ensure the settings are saved. If you log in to OmniPass with a fingerprint device, you will automatically be logged in to the default identity for that OmniPass user. You can choose the identity with which you are logging in if you login using "master password".

### **Choosing User Identity during Login**

To choose your identity during login, type your username in the **User Name:** field. Press [Tab] and see that the **Domain:** field self-populates. Click the **Password:** field to bring the cursor to it, and you will see the pull-down menu in the **Identity:** field. Select the identity to login as, then click **OK**.

### **Switch User Identity**

To switch identities at any time, right-click the OmniPass system tray icon and click **Switch User Identity** from the submenu. The **Switch Identity** dialog will appear. Select the desired identity and then click **OK**.

## Identities and Password Management

On the **Manage Passwords** interface of the **Vault Management** tab of the OmniPass Control Center, there is a pull-down selection box labeled, **Identity**. This field lets you choose which identity you are managing passwords for. When you select an identity here, only those password protected dialogs that are associated with that identity are shown. You can perform all the functions explained in “Password Management” on page 175.

## Configuring OmniPass

This section gives an overview of both the Export/Import function and the OmniPass Control Center.

### Exporting and Importing Users



YOU CANNOT IMPORT A USER INTO OMNIPASS IF THERE ALREADY IS A USER WITH THE SAME NAME ENROLLED IN OMNIPASS.

Using OmniPass Control Center, you can export and import users in and out of OmniPass. The export process backs up all remembered sites, credentials, and enrolled fingerprints for an OmniPass user. All OmniPass data for a user is backed up to a single encrypted database file. During the import process, the Windows login of the exported user is required. If the proper credentials cannot be supplied, the user profile will not be imported.



- YOU SHOULD PERIODICALLY EXPORT YOUR USER PROFILE AND STORE IT IN A SAFE PLACE. IF ANYTHING HAPPENS TO YOUR SYSTEM, YOU CAN IMPORT YOUR OMNIPASS PROFILE TO A NEW SYSTEM AND HAVE ALL YOUR REMEMBERED SETTINGS AND FINGERPRINTS INSTANTLY.
- YOU DON'T FORGET THE WINDOWS LOGIN CREDENTIALS WHEN EXPORTING. WHEN YOU EXAMINE THE IMPORTATION, YOU ARE PROMPTED FOR AUTHENTICATION. THE CREDENTIALS THAT WILL ALLOW A USER PROFILE TO BE IMPORTED ARE THE WINDOWS LOGIN CREDENTIALS OF THE EXPORTED USER. THEY ARE THE CREDENTIALS THAT HAD TO BE SUBMITTED WHEN THE USER PROFILE WAS EXPORTED. YOU WILL NEED USER NAME, PASSWORD, AND DOMAIN.



## Exporting an OmniPass User Profile

To export a user, open the OmniPass Control Center, and click **Import/Export User** under **Manage Users**.

Click **Exports an OmniPass user profile**. OmniPass will prompt you to authenticate. Upon successfully authentication, you must name the OmniPass user profile and decide where to save it. An .opi file is generated, and you should store a copy of it in a safe place.

This .opi file contains all your user specific OmniPass data, and it is both encrypted and password protected. This user profile does NOT contain any of your encrypted data files.

## Importing an OmniPass User Profile

To import an OmniPass user open the OmniPass Control Center, and click Import/Export User under Manage Users. Click Imports a new user into OmniPass and then select OmniPass Import/Export File (\*.opi) and click Next. OmniPass will then prompt you to browse for the file you had previously exported (.opi file). When you select the .opi file for importation, OmniPass will prompt you for authentication. The credentials that will allow a user profile to be imported are the Windows login credentials of the exported user. They are the credentials that had to be submitted when the user profile was exported. You will need User Name, Password, and Domain. If you don't remember the value for Domain, in a PC or SOHO environment Domain should be your computer name.

OmniPass will notify you if the user was successfully imported.

## Things to Know Regarding Import/Export

- Assume you export a local Windows User profile from OmniPass. You want to import that profile to another machine that has OmniPass. Before you can import the profile, a Windows user with the same login credentials must be created on the machine importing the profile.

**Example:** I have a Windows user with the username “Tom” and the password “Sunshine” on my system. I have enrolled Tom into OmniPass and remembered passwords. I want to take all my

passwords to new system. I export Tom's OmniPass user profile. I go to my new system and using the Control Panel I create a user with the username "Tom" and the password "Sunshine". I can now successfully import the OmniPass user data to the new system.

- If you export an OmniPass-only user, you can import that user to any computer running OmniPass, provided that a user with that name is not already enrolled in OmniPass.
- If you attempt to import a user profile who has the same name as a user already enrolled in OmniPass, the OmniPass import function will fail.

## OmniPass Control Center

This section will serve to explain functions within the OmniPass Control Center that weren't explained earlier.

You can access the OmniPass Control Center any of three ways:

- Double-click the golden OmniPass key shaped icon in the Windows taskbar (typically in the lower-right corner of the desktop)
- Click the **Start** button; select the **Programs** group; select the **Softex** program group; and click the **OmniPass Control Center** selection.
- Open the Windows **Control Panel** (accessible via **Start** button --> **Settings** --> **Control Panel**) and double-click the **Softex OmniPass** icon.

## User Management

The User Management tab has two major interfaces: **Add/Remove User** and **Import/Export User**. Import/Export User functionality is documented in "Exporting and Importing Users" on page 177. Add/Remove User functionality is straightforward.

If you click **Adds a new user to OmniPass** you will start the OmniPass Enrollment Wizard. The Enrollment Wizard is documented in "User Enrollment" on page 169.

If you click **Removes a user from OmniPass**, OmniPass will prompt you to authenticate. Authenticate with the credentials (or enrolled fingerprint) of the user you wish to remove. OmniPass will prompt you to confirm user removal. Click **OK** to complete user removal.



REMOVING A USER WILL AUTOMATICALLY DESTROY ALL OMNIPASS DATA ASSOCIATED WITH THAT USER. ALL IDENTITIES AND CREDENTIALS ASSOCIATED WITH THE USER WILL BE LOST.

IF YOU'RE SURE YOU WANT TO REMOVE THE USER, WE RECOMMEND YOU EXPORT THE USER PROFILE.

## User Settings

The User Settings tab has four interfaces: **Audio Settings**, **Taskbar Tips**, and **Enrollment**. User settings allow users to customize OmniPass to suit their individual preferences. Under **User Settings (Audio Settings and Taskbar Tips)** you can set how OmniPass notifies the user of OmniPass events (e.g., successful login, access denied, etc.). The details of each setting under the **Audio Settings** and **Taskbar Tips** interfaces are self-explanatory.

The **Enrollment** interface allows you to enroll fingerprints. For the procedure to enroll and authentication device refer to *Chapter 2.3*. To enroll additional fingerprints, click **Enroll Authentication Device**, and authenticate with OmniPass. Select the fingerprint recognition device in the **Select Authentication Device** screen (it should already be marked by a green check if you have a finger enrolled) and click **Next**.

## System Settings

The OmniPass **Startup Options** interface can be found in the System Settings tab. With these options you can specify how your OmniPass Logon is tied to your Windows Logon.

The first option, **Automatically log on to OmniPass as the current user**, will do just as it says; during Windows login, you will be logged on to OmniPass using your Windows login credentials. If the user logging into Windows was never enrolled into OmniPass, upon login no one will be logged on to OmniPass. This setting is appropriate for an office setting or any setting where users must enter a username and password to log into a computer. This is the default setting.

With the second option, **Manually log on to OmniPass at startup**, OmniPass will prompt you to login once you have logged on to Windows.

With the third option, **Do not log on to OmniPass at startup**, OmniPass will not prompt for a user to be logged on.

You can manually log on to OmniPass by right-clicking the OmniPass taskbar icon and clicking **Log in User** from the right-click menu.

## Troubleshooting

You cannot use OmniPass to create Windows users. You must first create the Windows user, and you will need administrative privileges to do that. Once the Windows user is created, you can add that user to OmniPass using the same username and password

### Cannot add Windows users to OmniPass

If you experience difficulties adding a Windows user to OmniPass, you may need to adjust your local security settings. You can do this by going to **Start, Control Panel, Administrative Tools, and Local Security Settings**. Expand **Local Policies**, expand **Security Options**, and double-click **Network Access: Sharing and Security Model for Local Accounts**. The correct setting should be *Classic - Local Users Authenticate as Themselves*.

### Cannot add a User with a Blank Password to OmniPas

If you experience difficulties adding a user with a blank password to OmniPass, you may need to adjust your local security settings. First attempt the procedure explained in the *Cannot add Windows user to OmniPass* section. If the difficulties persist, then try the following procedure.

Click **Start, Control Panel, Administrative Tools, and Local Security Settings**. Expand **Local Policies**, expand **Security Options**, and double-click **Accounts: Limit local account use of blank passwords to console login only**. This setting should be set to Disabled.

## Dialog appears after OmniPass authentication during Windows Logon

After installing OmniPass on your system, you can choose to logon to Windows using OmniPass. You authenticate with OmniPass (via master password, or an enrolled security device) and OmniPass logs you into Windows. You may, during this OmniPass authentication, see a **Login Error** dialog box.

This dialog box occurs when OmniPass was unable to log you into Windows with the credentials supplied (username and password). This could happen for any of the following reasons:

- Your Windows password has changed
- Your Windows account has been disabled

If you are having difficulties due to the first reason, you will need to update OmniPass with your changed Windows account password. Click **Update Password** and you will be prompted with a dialog to reconfirm your password.

Enter the new password to your Windows user account and click **OK**. If the error persists, then it is unlikely the problem is due to your Windows user account password changing.

# Index

---

## A

- About This Guide 1, 13
- AC
  - adapter 60
  - plug adapters 118
- Air Vents 29
- Auto/Airline Adapter 60, 61
- Automatically Downloading Driver Updates 114

## B

- Battery 74
  - care 118
  - cold-swapping 77
  - conserving power 70
  - dead 97
  - faulty 98
  - hot-swapping 77
  - increasing life 119
  - level indicator 31
  - lithium ion battery 74
  - low 76
  - problems 97, 98
  - recharging 75
  - replacing 77
  - shorted 77
  - Standby mode 76
- Battery Latches 29

## BIOS

- guide 65
  - setup utility 64
- ## Bluetooth
- Where to Find Information 163
- ## Boot Sequence 63
- ## Booting the System 65
- ## Built-in Speakers 93
- ## Button Icons 53

## C

- CapsLock 32
- Click Me! 68
- Clicking 42
- Configuration Label 121
- Contact Information 14
- Controls and Connectors 17
- Conventions Used in the Guide 13
- Cursor Keys 40

## D

- DC in connector 17
- DC Output Cable 60
- DC Power Jack 24, 60
- Device Ports 84
- Display Panel 20, 33
  - brightness 35
  - opening 34

- problems 99, 100
- Docking Port 89
- Double-Clicking 42
- Dragging 43
- Drivers and Application Restore CD 107
- Dual Built-in Microphones 20
- DVD drive
  - problems 93, 94
- E**
- Error Messages 102
- External Monitor Port 86
- External Video port 18
- F**
- FDU 69, 114, 128
- Fingerprint Sensor 20
- Fingerprint Sensor Device 165
  - enrolling a fingerprint 170
  - getting started 166
  - installing OmniPass 166
  - logging into a remembered site 174
  - OmniPass authentication toolbar 172
  - password replacement 171
  - remembering a password 172
  - uninstalling OmniPass 168
  - user enrollment 169
  - using OmniPass 171
- Fujitsu Contact Information 14
- Fujitsu Driver Update utility 69, 114, 128
- Fujitsu LifeBook
  - cleaning 117
  - storing 117
  - traveling 117
- Fujitsu Shopping Online 15

- Function Key
  - F10 40
  - F6 40
  - F7 40
  - FN 40

## **G**

- Glossary 130

## **H**

- Hard Disk Drive
  - access indicator 32
  - problems 94
- Hard Disk Drive Passwords 63
- Headphone Jack 17, 25, 85
- Hibernation Feature 72
  - disable/enable 72

## **I**

- IEEE 1394 (4-pin) Jack 27
- Internal LAN Jack 88

## **K**

- Keyboard 21, 39
  - problems 94

## **L**

- Left Button 21
- LifeBook Security/Tablet PC Buttons 50
- LifeBook Security Tablet PC Buttons 20
- Lithium ion Battery Bay 29
- Local Area Network (LAN) 18

## **M**

- Media Player

- care 120
- Memory
  - compartment 29
- Microphone Jack 17, 86
- Microsoft Works 129
- Modem
  - problems 95
- Mouse
  - problems 94
- N**
- NumLk 32
- O**
- ot 67
- P**
- PC Card
  - care 120
  - installing 82
  - removing 82
- Pen 20
- Pen/Pen Holder 28
- Pointing Device 41
- Port Replicator
  - connector 29
  - problems 94
- Post-logon button functions 54
- Power
  - AC adapter 60
  - Auto/Airline adapter 60
  - failure 96, 97
  - management 70
  - off 73

- on 62
- problems 98, 99
- sources 60
- Power Management 70
- Power On Self Test 62, 102
- Pre-Installed Software 127
  - Adobe Acrobat Reader 128
  - Google Toolbar 128
  - manuals 127
- Pre-logon button functions 50

## **Q**

- Quick Point
  - clicking 42
- Quick Point Cursor Control 25
- Quick Point Pointing Device 41

## **R**

- Registrations 68
- Regulatory Information 145
- Restarting 72
- Restoring Your Pre-installed Software 107
- Right Button 22
- RJ-45 88

## **S**

- ScrLk 32
- Scroll Button 23
- Scrolling 43
- SD Card
  - installing 80
  - removing 80, 83
- SD Card Slot 25
- SD/Memory Stick Slot 17



- Secure Digital Card
  - removing 80
- Secure Digital Cards 79
- Security Buttons
  - Functions 50
- Security lock slot 17
- Sleep Mode 70
- Speaker 22
- Specifications 121
  - Audio 123
  - Chipset 122
  - Device Ports 124
  - Dimensions and Weight 126
  - Environmental Requirements 126
  - Keyboard 125
  - mass storage device options 123
  - Memory 122
  - Microprocessor 122
  - Power 125
  - Video 122
- Standby Mode 71
- Status Indicator Panel 21, 30
- Suspend/ Resume button 17

## T

- Tablet Configuration 34
- Tablet PC Button Functions
  - changing 55
- Touch Screen
  - calibrating 47
  - clicking 46
  - dragging 47
- Troubleshooting 90

## U

- Universal Serial Bus Ports 84
- USB 84, 95
  - problems 95, 96
- USB 2.0 Ports 27, 28
- USB Port 17

## V

- Volume control 49

## W

- Warranty 15
- Windows Power Management 72
- Windows Vista
  - configuring the WLAN 158
  - restoring the Operating System 110
  - starting the first time 66
- Windows XP
  - configuring the Wireless LAN 159
  - restoring the Operating System 108
  - starting the first time 67
- Wireless LAN
  - Before Using the Wireless LAN 153
  - configuring 153
  - connection to the network 159
  - deactivating/disconnecting 156
  - modes 154
  - Specifications 162
  - Troubleshooting 160
- Wireless LAN On-Off Switch 18
- Wireless LAN/Bluetooth On/Off Switch 24