

LX-8000 series

ECG & Respiration Transmitter

LX-8100

Ver. 01

Operation Manual



- * Before using the product, please read this manual thoroughly.
- * Store this manual where it can be always referred to.

 **FUKUDA**

This manual is for the LX-8100 Version 01.

 **CAUTION**

Federal Law restricts this device to sale by or on the order of a physician.

CAUTION

- Only physician or persons instructed by physicians are allowed to use the equipment.
- The information contained in this document is subject to change without notice due to improvement in the equipment.

© 2017 Fukuda Denshi Co., Ltd.



No part of this document may be reproduced or transmitted in any form without the prior written permission of Fukuda Denshi Co., Ltd.

If this manual has pages missing or out of order, contact Fukuda Denshi for replacement.

Thank you for purchasing our product.
Before using this product, read this operation manual thoroughly for correct handling and operation.

Safety Precautions

Read the “Safety Precautions” thoroughly before use to ensure correct and safe use of the product. Make sure to follow the precautions indicated below, as these are important messages related to safety.

 DANGER	Failure to follow this message may cause immediate threat of death or serious injury, or complete failure of the equipment.
 WARNING	Failure to follow this message may result in death or serious injury, or complete failure of the equipment.
 CAUTION	Failure to follow this message may cause injury or failure of the equipment.
NOTE	A note is not related to product safety, but provides information about the correct use and operating procedures to prevent incorrect operation and malfunction of the equipment.

Precaution from Fukuda Denshi

Fukuda Denshi is responsible for the safety, reliability, and performance of its equipment only if;
Maintenance, modifications, and repairs are carried out by authorized personnel. Components are used in accordance with Fukuda Denshi operating instructions.
If the equipment is used incorrectly and become unusable, Fukuda Denshi is not liable for the malfunction. Use the equipment only for the purpose specified in this manual.

Intended Use of this Equipment

This equipment is designed for the following <Intended Use>.

<Intended Use>

This equipment is intended for measuring parameters of ECG, respiration in surgery room, ICU, ward, emergency room in the medical facility and transmitting the measured data by wireless network to the central monitor continuously.

This equipment is intended for monitoring one patient. It is not intended for monitoring multiple patients.

For specification of this equipment, refer to "Chapter 14 Specification" of this manual.









This equipment is intended to be used by healthcare professionals. Users should have a thorough knowledge of the function and operation before using this equipment. The maintenance of this equipment should be performed by skilled personnel who received a training of possible hazards and measures to avoid those hazards. Also, your local regulation must be followed. If this equipment is used for the purpose other than intended, or if the user does not follow the safety instructions, the following hazard may result.

- Hazard to the Life and Health of the Patient or the User
- A Problem Related to Medical Practice
- Damage to the Equipment

Graphic Symbol

The following symbols are used for this equipment.

LX-8100 Symbols indicated on the main unit

Symbol	Description
	Warning (indicated in yellow)
	<u>Follow operating instructions (Warning)</u> ; (indicated in blue) Indicates that the failure to follow operating instructions could place the patient or operator at risk.
	Type CF Applied Part with Defibrillation-Proof Indicates that the degree of protection against electric shock is Type CF Applied Part with defibrillation-proof.
ON  / OFF 	Indicates the power ON/OFF status.
PUSH 	Indicates the point to close the battery compartment lid.
	Indicates the battery type and direction
	Name and Address of Manufacturer Date of Manufacture Indicates the name and address of manufacturer, and date of manufacture.
	Non-ionizing electromagnetic radiation Indicates the radio transmitting device.

LX-8100 Symbols displayed on the display screen

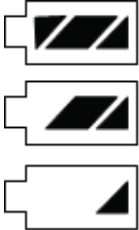
Symbol	Description
	Synchronized Mark This mark flashes synchronizing to the heartbeat.
	Indicates the remaining battery level.

Precautions for Safe Operation of Medical Electrical Equipment

Cautions described here are regarding the general instructions for safety use to the patient and the users. As for cautions about the LX-8100, please refer to the following pages.

CAUTION

1. Users should have a thorough knowledge of the operation before using this equipment.
2. Pay attention to the following when installing or storing the equipment.
 - Do not install or store in a place where the equipment will be subjected to splashing water.
 - Do not install or store in an area where the environmental conditions, such as atmospheric pressure, temperature, humidity, ventilation, sunlight, dust, sodium, sulfur, will adversely affect the system.
 - Place the equipment on a stable surface where there is no inclination, vibration, or shock (including during transportation).
 - Do not install or store in an area where chemicals are stored or gas may generate.
3. Before operating the equipment, verify the following items.
 - Check the cable connection and polarity to ensure proper operation of the equipment.
 - Ensure that all cables are firmly and safely connected. Especially, recheck the attachment and connection condition of electrodes and transducers.
 - Pay special attention when the equipment is used in conjunction with other equipment as it may cause erroneous diagnosis and danger.
 - Check the remaining battery level.
 - When replacing the battery, make sure that the battery polarity is correct. Do not charge the battery.
4. During operation of the equipment, verify the following items.
 - Do not operate the equipment beyond the time period required for diagnosis and medical care.
 - Do not pick up and/or swing the equipment pulling/grabbing the probe (sensor) or cable part. It may damage the equipment and lead to measurement error.
 - Always observe the equipment and patient to ensure safe operation of the equipment.
 - If any abnormality is found on the equipment or patient, take appropriate measures such as ceasing operation of the equipment and/or detaching the probe (sensor) and/or electrode, in the safest way for the patient.
 - Do not allow the patient to come in contact with other equipment.

CAUTION

5. After using the equipment, verify the following items.
 - Return all operating switches, knobs etc to the position before using the equipment, and then switch off the power.
 - When unplugging the cables, do not apply excessive force on the cable and pull from its connector.
 - Clean the accessories and cables, and keep them together in one place.
 - Keep the equipment clean to ensure proper operation for the next use.
 - Make sure to remove the battery if the equipment is not used for a long time. The leakage from the battery may damage the equipment or an explosion from the battery may occur.
6. If the equipment is damaged and in need of repair, ensure patient safety by immediately turning the equipment off and remove the electrodes and/or probe from the patient. Users should not attempt service. Label the unit “OUT OF ORDER” and contact Fukuda Denshi representative.
7. Do not disassemble or remodel the equipment.
8. Maintenance
 - Make sure to periodically check the equipment and accessories.
 - Before reusing the equipment that has been left unused for a while, make sure that the equipment works normally and safely.
9. When using electrosurgical knives or defibrillator with this equipment, take care of the following.
 - To prevent burn injury to the patient, verify proper attachment of the patient ground plate, the ECG electrode type for the electrosurgical knives, and the quantity of gel, output energy for the defibrillator. Also, verify that a proper ground is selected.
 - Some types of equipment other than above may cause accidental hazards to the patient and operator due to the conditions of the equipment. Read the operation manual attached to each equipment and understand the precautionary instructions prior to use.

Non-Explosion Proof

DANGER

- Never operate the equipment in the presence of flammable anesthetics, high concentration of oxygen. It may cause an explosion or fire.
- Never operate the equipment inside a hyperbaric chamber. It may cause an explosion or fire.
- Never operate the equipment where flammable gas or fluid such as anesthetic, oxygen, and hydrogen are used. It may cause an explosion or fire.

Precautions about Magnetic Resonance Imaging (MRI)

WARNING

- Do not operate this equipment in magnetic resonance imaging (MRI) environments.
- When conducting MRI test, remove the electrodes and sensors connected to the patient (test subject).
The local heating caused by the induced electromotive force may cause burn injury to the patient (subject). For details, refer to the operation manual for the MRI testing device.

Electrosurgery Safety

WARNING

The monitoring system contains protection against interference generated by electrosurgical instruments. However, depending on the operating conditions, surgery site with respect to the location of ECG electrodes, ground plate attachment condition, or the type of instrument used, it may cause burn injury at the electrode site or noise on the ECG. The noise is generated at the tip of the electrosurgical knife and is difficult to completely eliminate because of the frequency components of the ECG. To reduce electrosurgical interference, take the following precautions:

Location:

Locate the electrosurgical unit as far as possible from this equipment and the patient cable. This will help reduce interference on the ECG through the monitor or cables.

Electrode Placement:

The amount of noise interference is considerably different depending on the electrode position and surgery site. Place the ECG electrodes as far away as possible from the surgery site and the ground plate. Do not place electrodes in the path between the surgery site and the ground plate. If the electrodes are placed in this path, the amount of interference will be quite large. Position (+) and (–) electrodes as close as possible to each other.

Ground Plate:

When using electrosurgical instruments, make sure the contact between the patient and the ground plate is secure. If the connection is incomplete, the patient may suffer from burn at the electrode site.

Defibrillation Safety

WARNING

- Use only the lead cable specified by Fukuda Denshi when defibrillating. If used by unspecified lead cable, the equipment may be damaged, resulting in a safety hazard.
- When using the defibrillator, keep away from the electrodes or medicament applied to the patient chest. If this is not possible, remove the electrodes or medicament before using it.
If the defibrillator paddles are directly in contact with the electrodes or medicament, an electrical shock may result from the discharged energy.
- When using the defibrillator, do not touch the patient and the metal part of the equipment or cables. Electric shock may result from the discharged energy.

Precautions about the Pacemaker

WARNING

- Minute ventilation rate-adaptive implantable pacemakers can occasionally interact with certain cardiac monitoring and diagnostic equipment, causing the pacemakers to pace at their maximum programmed rate. The cardiac monitoring and diagnostic equipment may possibly send wrong information.
If such event occurs, disconnect the cardiac monitoring and diagnostic equipment, or follow the procedures described in the operation manual of the pacemaker.
(For more details, contact FUKUDA DENSHI personnel, your institution's professionals, or your pacemaker distributors.)
- Rate meters may continue to count the pacemaker rate during occurrences of cardiac arrest or some arrhythmias. Do not rely entirely upon rate meter alarms. Keep pacemaker patients under close surveillance.
 - ➡ Reference
"Minute Ventilation Rate-Adaptive Pacemakers"
FDA alerts health professionals that minute ventilation rate-adaptive implantable pacemakers can occasionally interact with certain cardiac monitoring and diagnostic equipment, causing pacemakers to pace at their maximum programmed rate.
[October 14, 1998 – FDA]

Precautions about the LX-8100

WARNING

- Do not connect cables not authorized by Fukuda Denshi to any I/O connector. If done so by mistake, the LX-8100 cannot deliver its maximum performance and may be damaged, resulting in a safety hazard.
- Do not use this equipment with multiple patients simultaneously.
- This equipment itself has no alarm function. Do not use it if an alarm function is necessary. The alarm function with the receiving monitor, refer to the operation manual of the receiving monitor.

CAUTION

Do not pick up and/or swing the LX-8100 pulling/grabbing the probe (sensor) or cord part. The cable could break or get disconnected from the LX-8100. And it may hit people or damage other equipment around.

Precautions about Waterproof

CAUTION

- Replace the “Battery Compartment Lid” of the LX-8100 regularly to keep the performance of waterproof. If not regularly replaced, the quality of the lid will deteriorate and cannot keep the waterproof performance. For details about the regular replacement, contact your local Fukuda Denshi service representative.
- The lid may be damaged from high impact. If the LX-8100 is dropped or is subjected to a high impact, make sure that the lid is not damaged.
- Do not use the LX-8100 wet. Always wipe the LX-8100 with a soft cloth and dry it thoroughly before use.

Precautions about ECG

CAUTION

- When removing electrodes from the patient, remove them carefully and slowly. Do not apply excessive force to remove them. Otherwise, it may damage the skin.
- If any electrodes get detached from the patient after being connected to the lead cable and the patient monitor, pay attention that the metal part of the electrode does not get in touch with any metal parts of the bed or any conductive parts. Also, the operator should not touch any conductive parts with bare hands. Otherwise, it may cause electric shock to the patient and/or operator due to excessive leakage current.
- The indication for continuous use of the electrode is about one day.
- Replace the electrode if the skin contact gets loosen due to perspiration, etc.
- When an electrode is attached to the same location for a long period, some patients may develop skin irritation. Check the patient's skin condition periodically and change the electrode site as required.
- For stable ECG monitoring, verify proper electrode placement, lead, and waveform size. If not properly selected, it may cause erroneous detection.
- There are some cases when the pacemaker pulse cannot be detected depending on the pacemaker type, pulse voltage, pulse width, electrode lead type (unipolar, bipolar), or electrode placement which causes the pacemaker pulse amplitude to decrease, and disables the pacemaker pulse detection.
- If signals similar to a pacemaker pulse are present, such as electric blanket noise or excessive AC frequency noise, these may be erroneously detected and displayed as a pacemaker pulse. In this case, check the condition of the electrodes and ECG lead cable to resolve the cause or turn off the pacemaker detection setting on the receiving monitor.
- If a pacemaker pulse is continuously detected due to AC frequency interference, QRS detection will be suspended and the heart rate will be reduced.

Precautions about Output Signal

WARNING

Do not use the output signal of the monitor that receives radio wave signal from the LX-8100 as the trigger signal for IABP, MRI echocardiographic, or defibrillator for the following reasons.

It may lead to a delay of operating timing due to the delay time of waveform transmission.

A trigger signal unrelated to the heart rate may be generated due to the interfusion of spike noise at weak electric field.

Precautions about Accessories and Optional Accessories

WARNING

Use only the accessories such as disposable electrodes and electrode codes specified by Fukuda Denshi. Otherwise, this equipment cannot deliver its maximum performance and may be damaged, resulting in a safety hazard.

CAUTION

- Do not reuse disposable products.
- Store the disposable products properly as mentioned in their user manuals.

Precautions about Battery

WARNING

- Use new "AA" size ("LR6" size) alkaline cell.
- Install the battery with the correct polarity.
- Do not charge the battery. Any attempt to charge the battery may cause it to leak or break.
- Do not short the (+) and (-) terminals. It may result in exothermic heat and fire.
- Do not throw the battery into fire. It may explode.

Precautions about Disposing of Equipment, Accessories, or Components

CAUTION

- When disposing of equipment, accessories, or components, use an industrial waste distributor. Do not dispose of as ordinary waste.
- Used disposal items (ECG electrodes, etc.) shall be discarded as medical waste.

Precautions about Disposing of Battery

CAUTION

Follow the local municipal rule to dispose the used dry cell batteries.

Precautions for Use of Medical Telemeter

WARNING

- The LX-8100 transmitter must not be co-located or operated in conjunction with any other antenna or transmitter.
- This equipment complies with FCC/IC radiation exposure limits set forth for an uncontrolled environment and meets the FCC radio frequency (RF) Exposure Guidelines and RSS-102 of the IC radio frequency (RF) Exposure rules. This equipment has very low levels of RF energy that are deemed to comply without testing of specific absorption rate (SAR).
- Operation of LX-8100 requires the prior coordination with a frequency coordinator designated by the FCC for the Wireless Medical Telemetry Service.
- This radio frequency device is susceptible to interference from outside sources. Interference may prevent the monitoring of patients connected to this equipment. If a problem exists, contact your local service representative.
- The LX-8100 transmits vital signs to the receiving monitor using radio wave signal. Under unstable radio wave signals, the receiving monitor will not generate any alarms. This situation may miss sudden change in the patient's condition and may cause a serious accident. Under unstable radio wave signals, check the patient status consistently under this situation. To get stable radio wave signals, make sure to have a proper telemetry installation.

CAUTION

For installation, make sure of the following.

- The medical institution (hereinafter referred to as the “Institution”) must decide the telemetry installation plan for the medical department in order to prevent interference and interference between transmitters (telemetry based on destination country’s radio law). When telemetry has already been installed and been used, radio format, frequency, and antenna power are required to be examined to prevent interference.
- When laying receiver antenna for each transmitter, the Institution has to examine the installation so that electronic interference does not occur.
- Based on the above examination result, the Institution should install each receiver antenna as required.

CAUTION

For management, make sure to follow the precautions below.

- The Institution should appoint a person (hereinafter referred to as the “Coordinator”) to manage the wireless channels for the whole Institution.
- The Coordinator must be selected from people who understand the characteristics and functionality of telemetry systems, and are skilled in operating telemetry.
- When installing telemetry, the Coordinator has to understand the precautions for use of telemetry in advance.
- The Coordinator is responsible for maintenance of wireless channels and storage and maintenance of telemeter in the overall medical facilities to give proper instructions to the telemetry users.
- The Coordinator should create a management log (hereinafter referred to as the “log”), which contains a list of the management status of the wireless channels for the whole Institution. When changing a wireless channel, register it in the log and give proper instructions to the user.
- The telemetry user verifies operation of the transmitter/receiver before use.
- When interference or breakdown occurs in telemetry communication, the user is required to inform the Coordinator of the problems. The Coordinator is to deal with the problem properly and/or contact their nearest Fukuda Denshi representative for service.

Electromagnetic Compatibility

This equipment complies with IEC 60601-1-2 (2014), safety standard regarding the electromagnetic disturbances of medical electrical equipment. To ensure maximum performance against the electromagnetic disturbances, make sure to follow the precautions for installation and usage described in this manual.

- This equipment is intended for use in the medical facility (except inside the shield room of MRI device), and satisfies the immunity level for professional healthcare facility environment stipulated in IEC 60601-1-2.
- An excessive magnetic disturbance may degrade the HR measurement accuracy (refer to 14. Specification, ECG, HR measurement detection), which is the essential performance of this equipment, and may cause delay in treatment or inaccurate diagnosis.
- When using this equipment, interference with other medical electrical equipments or non-medical electrical equipments may occur. Make sure that no interference is present before usage.
- To ensure basic safety and essential performance related to electromagnetic disturbances during the expected service life of this equipment, “Daily Check” and “Periodic Check” must be performed. (refer to 12.Maintenance and Inspection)

Precautions for Safe Operation under Electromagnetic Influence

CAUTION

If any sorts of electromagnetic wave, magnetic field, or static electricity exist around the equipment, noise interference or malfunction of the equipment may occur. If any unintended malfunction or noise occurs during monitoring, check the magnetic influence and take appropriate countermeasures.

The followings are examples of the common cause and countermeasures.

● Mobile Phone

The radio wave may cause malfunction to the equipment.
Mobile phones and radio sets should be turned off in the room (building) where medical device is located.

● Static Electricity

In a dry environment (room), static electricity is likely to occur. Take the following countermeasures.

- Both operator and patient should remove any static electricity before entering the room.
- Humidify the room.

CAUTION

- If this equipment is installed close to, or stacked with other equipment, malfunction may occur. Make sure to verify that the equipments operate properly in a used location.
- Use of accessories, probes, or cables other than specified may cause increase in electromagnetic emission or decrease in electromagnetic immunity resulting in malfunction of the equipment.
- The portable RF communications equipment (including antenna cable and peripheral equipment such as external antenna) with the specified cable should be used in a location at least 30 cm apart from any part of this equipment. Otherwise, it may result in performance degradation of this equipment.

EMC Guidance

This equipment complies with IEC 60601-1-2 (2014). However, if portable transmitter or wireless LAN equipment is used extremely nearby, the electromagnetic influence may largely exceed the compliance level and may cause unexpected phenomenon such as noise interference on the waveform, etc.

Therefore, this equipment should be used in a location specified by each medical institution. If any unexpected noise interference on the waveform or failure to the peripheral device occurs, stop using the equipment and follow the instruction of the technician.

The following is the information relating to EMC (Electromagnetic Compatibility).

(When using this equipment, verify that it is used within the environment specified below.)

● Compliance to the Electromagnetic Emissions

This equipment complies with the following emission standard.

Emission test	Compliance
RF Emission CISPR 11	Group 1 Class A

CAUTION

The emission performance of this equipment is suitable for use in industrial environment and hospital environment (CISPR 11 Class A). To use in home environment (generally, CISPR 11 Class B is required), this equipment may not be properly protected from wireless frequency communication service. It may be necessary to take measures such as changing the installation location or equipment orientation.

● Compliance to the Electromagnetic Immunity

The LX-8100 is intended for use in the electromagnetic environment specified below. The customer or the user of the LX-8100 should assure that it is used in such an environment.

Basic EMC standard or test method	Immunity test levels
Electrostatic discharge IEC 61000-4-2	±8kV contact ±2kV, ±4kV, ±8kV, ±15kV air
Radiated RF EM fields IEC 61000-4-3	10V/m 80MHz to 2.7GHz 1kHz 80%AM
Proximity fields from RF wireless communications equipment IEC 61000-4-3	Refer to the following table.
Conducted disturbances induced by RF fields IEC 61000-4-6	3V 0.15MHz to 80MHz 1kHz 80%AM 6V 0.15MHz to 80MHz (in ISM bands between 0.15 MHz and 80MHz) 1kHz 80%AM
Rated power frequency magnetic fields IEC 61000-4-8	30A/m 50Hz

Immunity test specifications for RF wireless communications equipment.

Test frequency (MHz)	Modulation	Maximum power (W)	Distance (m)	Immunity test level (V/m)
710, 745, 780	PM, 217Hz	0.2	0.3	9
810, 870, 930	PM, 18Hz	2	0.3	28
1720, 1845, 1970	PM, 217Hz	2	0.3	28
2450	PM, 217Hz	2	0.3	28
5240, 5500, 5785	PM, 217Hz	0.2	0.3	9

Contact

If you need more information, please contact the following.

(1) Fukuda Denshi Co., Ltd., Head Office

3-39-4 Hongo, Bunkyo-ku, Tokyo, Japan

Tel: +81-3-5684-1455 Fax: +81-3-3814-1222

E-mail: info@fukuda.co.jp

Home Page: <http://www.fukuda.com>

(2) Sales Representative

Write the name, address, phone, fax number of your local sales representative.

(Name of Sales Representative, Address, Phone/Fax)

Contents

Safety Precautions.....	i
Precaution from Fukuda Denshi.....	i
Intended Use of this Equipment.....	ii
Graphic Symbol.....	iii
Precautions for Safe Operation of Medical Electrical Equipment.....	v
Non-Explosion Proof.....	vi
Precautions about Magnetic Resonance Imaging (MRI).....	vii
Electrosurgery Safety.....	vii
Defibrillation Safety.....	viii
Precautions about the Pacemaker.....	viii
Precautions about the LX-8100.....	ix
Precautions about Waterproof.....	ix
Precautions about ECG.....	x
Precautions about Output Signal.....	x
Precautions about Accessories and Optional Accessories.....	xi
Precautions about Battery.....	xi
Precautions about Disposing of Equipment, Accessories, or Components.....	xi
Precautions about Disposing of Battery.....	xi
Precautions for Use of Medical Telemeter.....	xii
Electromagnetic Compatibility.....	xiv
Precautions for Safe Operation under Electromagnetic Influence.....	xiv
EMC Guidance.....	xvi
Contact.....	xviii
1. General Description.....	1
2. Names of Parts and Their Functions.....	3
3. Preparation.....	5
(1) Installing the Battery.....	5
(2) Operating Power Switch.....	9
4. ECG Monitoring.....	11
■ Connecting the ECG Lead Cable and Electrodes.....	11
■ Attaching the Electrodes.....	14
■ Connecting the ECG Lead Cable to the LX-8100.....	15
5. Respiration Monitoring.....	17
6. Measurement.....	19
■ Starting Screen.....	19
■ Waveform Display Screen.....	19
■ Battery Level Check.....	21
■ Waveform Display.....	22
7. Operation.....	31
■ Changing Setup.....	31
■ Restarting the display.....	37

■ Pressing the EVENT button.....	37
8. Other Setting Items	39
■ Changing the Time Constant.....	40
■ Changing the Detection Sensitivity of the Pacemaker Pulse	40
■ Changing QRS Detection	41
■ Changing the Respiration Detection Signal ON/OFF	42
■ Changing the display Brightness	42
■ Changing Display Timeout Duration.....	42
■ Changing Sound ON/OFF	43
9. Changing the Transmitter Channel and Group ID.....	45
■ Changing the Transmitter Channel.....	45
■ Changing the Group ID	45
10. Troubleshooting	47
■ List of Displayed messages.....	47
■ In Case of Dropping the LX-8100 into Water.....	51
11. Cleaning and Disinfection	53
■ Cleaning	53
■ Disinfection.....	53
■ Cleaning the ECG lead cable	54
12. Maintenance and Inspection	55
■ Repairing the Equipment.....	63
■ Replacing the Battery Compartment Lid Unit	63
13 . Standard and Optional Accessories	67
■ Standard Accessories	67
■ Optional Accessories.....	68
14. Specification.....	69
■ Specification	69
■ Displays.....	73
■ Details of the “Electrode” Message	75
■ List of Setup Items.....	76

1. General Description

The LX-8100 is a telemetry transmitter designed to measure the ECG and respiration waveform with a “AA” size (“LR6” size) alkaline battery. Information such as ECG measurements, respiration waveform, battery level, and the conditions of the ECG electrodes are displayed on the front panel. ECG lead selection is available using the two buttons (ENTER and ▽) on the front panel (In case of using a 3-electrode lead cable or a 5-electrode chest lead cable).

Before using the LX-8100, read also the operation manual of the patient monitor at the receiving side thoroughly.

External Appearance

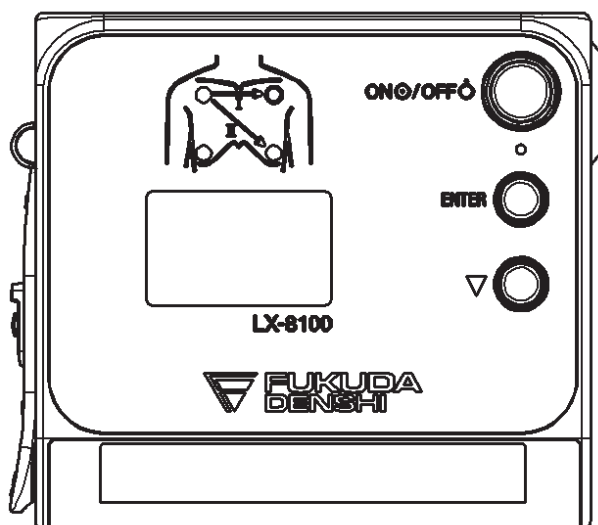

1. General Description

2. Names of Parts and Their Functions

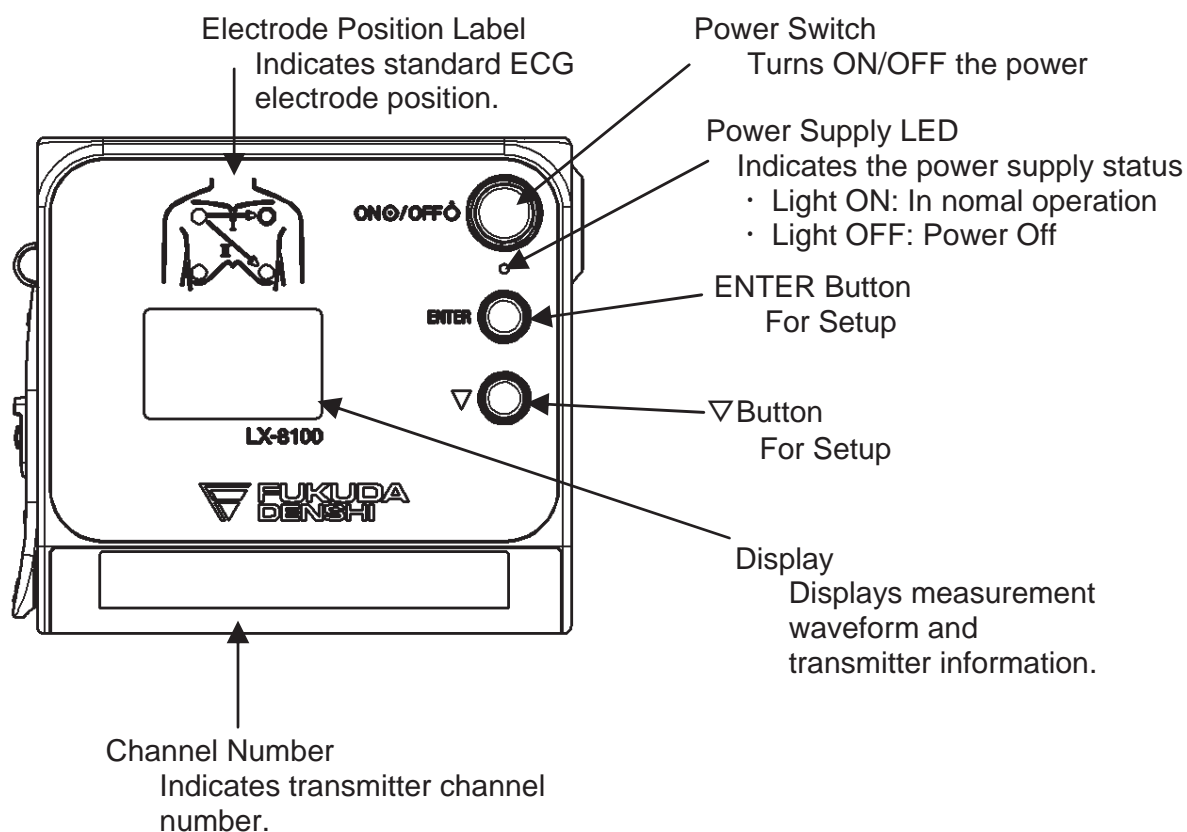
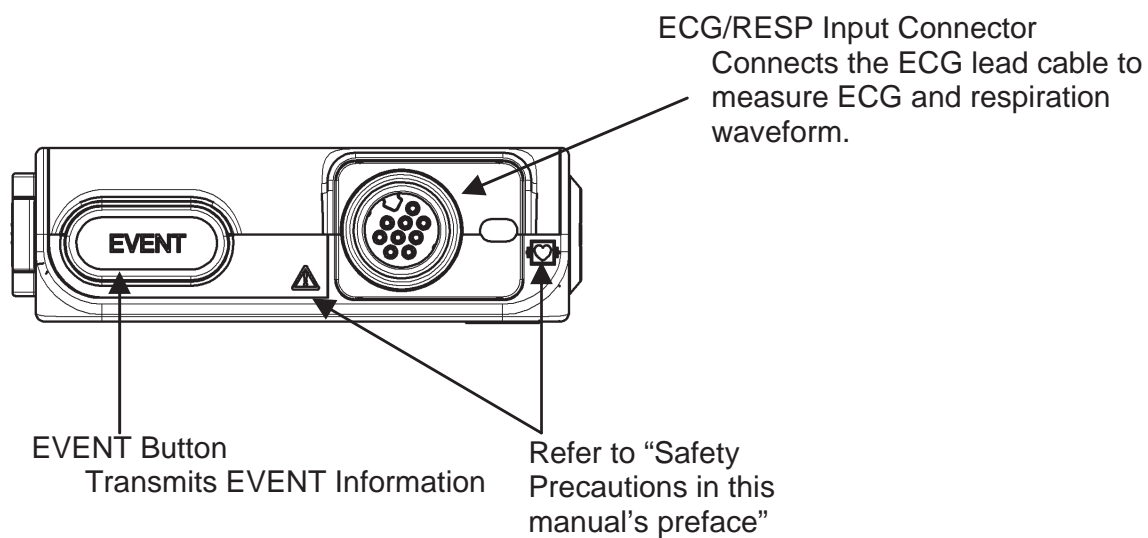

2. Names of Parts and Their Functions

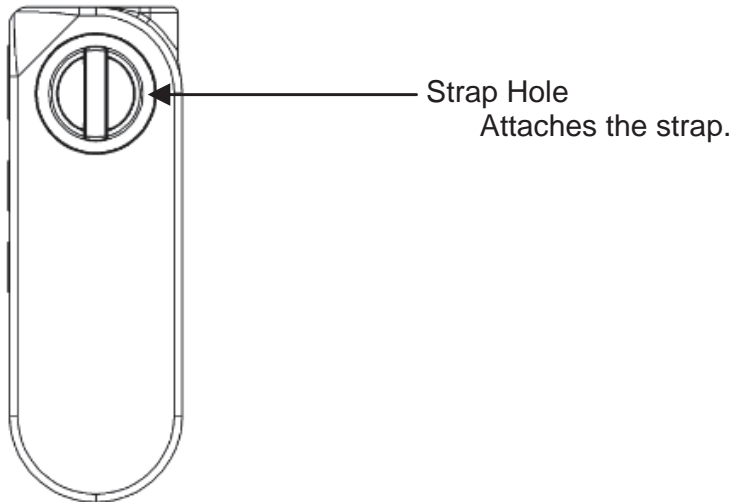
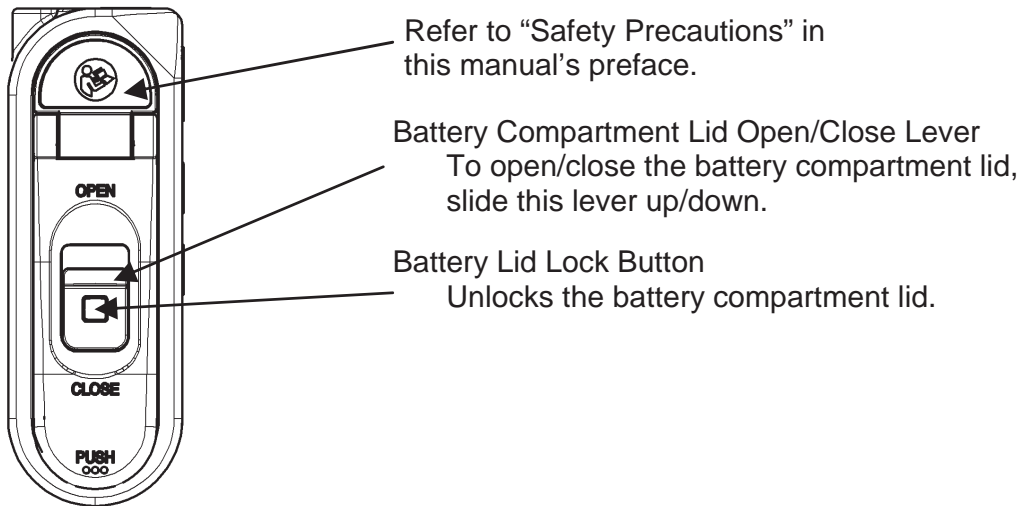

3. Preparation

(1) Installing the Battery

The LX-8100 functions with an “AA” size (“LR6” size) alkaline battery. Use the battery specified by Fukuda Denshi.

Use a new “AA” size (“LR6” size) alkaline battery.

Specified types of batteries

Type	Product	Manufacturer	Operation time
“AA” size (“LR6” size) alkaline battery	MX1500	DURACELL	Approximately 6 days ^{*1}

*1: When using a new battery.

(ECG measurement, RESP measurement, Default setting, Operating environments in 23°C)

*The operation times are estimated for operations with specified types of batteries by Fukuda Denshi.

WARNING

- Unplug the ECG lead cable when the battery compartment lid is opened. Otherwise, patient leakage current beyond the allowable value may occur.
- Use a new “AA” size (“LR6” size) alkaline battery.
- Do not short out the (+) and (-) terminals. It may result in exothermic heat and fire, the leakage from the batteries may damage the equipment, or an explosion from the batteries may occur.
- Install the batteries with the correct polarity.
- Do not charge alkaline batteries. Any attempt to charge the batteries may cause them to leak or break.
- Do not use disassembled or damaged batteries due to drop or shock. The leakage from the batteries may damage the equipment, or an explosion from the batteries may occur.

3. Preparation

WARNING

- Remove the exhausted batteries immediately. The leakage from the batteries may damage the equipment, or an explosion from the batteries may occur.
- If the equipment is not in use for a long period of time, remove the batteries and store the equipment in an appropriate place. If the batteries are left in the equipment for a long period of time, the leakage from the batteries may damage the equipment or an explosion from the batteries may occur.

CAUTION

- Use alkaline battery (AA) specified by Fukuda Denshi.
- Do not replace the batteries with wet hands.
- In case of storing the used or unused batteries, make sure that the terminals are not touching other batteries or metal parts.
- Use the same type of battery as its setting otherwise the accurate battery level cannot be displayed.

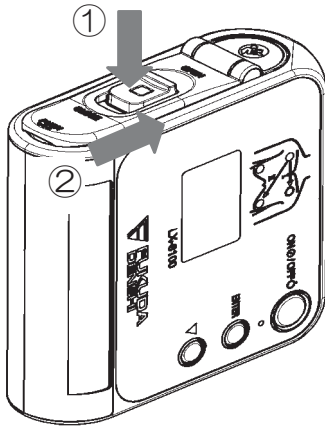

Unlock and open the battery compartment lid by sliding the open/close lever towards OPEN while pressing the lock button.

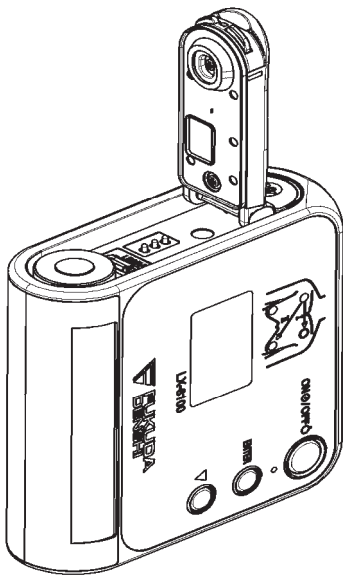

Install a new battery according to the polarity indication inside the battery compartment.

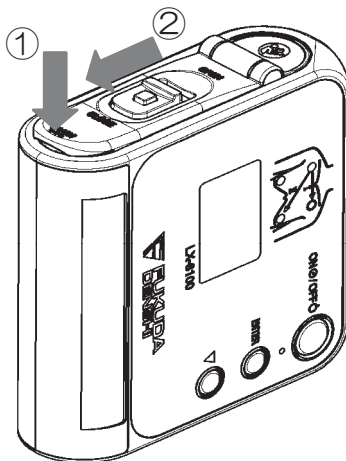

After installing the battery, lock the battery compartment lid by sliding the open/close lever towards CLOSE while pressing over "PUSH" on the lid.

3. Preparation

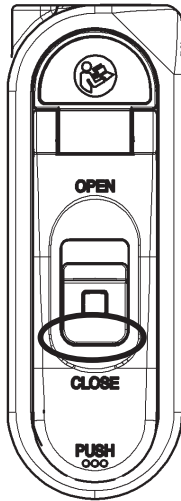

Make sure that the battery compartment lid is locked. (If you can still see red, then it is not locked properly.)

CAUTION

- Make sure that any foreign particles, such as hairs, are not held on the battery compartment lid and dust is not adhered to the edge of the lid to prevent water entering into the battery compartment area.
- Do not keep the compartment lid unlocked as the battery may unexpectedly get out from the compartment.

(2) Operating Power Switch

Turning the power switch to “ON”

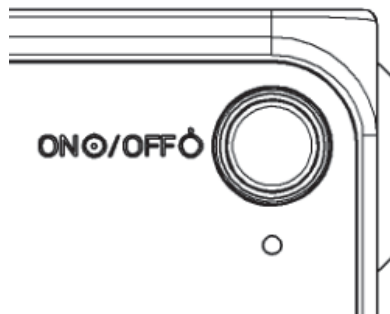

Press the power switch.

Display screen turns ON and measurement starts.

Regarding the display screen, refer to page 19.

The display screen automatically turns itself OFF by following the setting.

After the power is turned ON, make sure to check the remaining battery level on the display screen.

Refer to the following symbol about the remaining battery level.

Battery Symbol	Remaining Battery Level
	Full
	Getting low but still available
	Nearly empty; Replace the battery

Turning the power switch to “OFF”

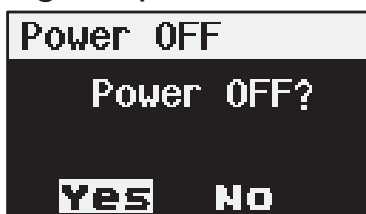

Press the power switch for two seconds, then display screen displays as the left illustration to confirm. Choose “Yes” and press the **ENTER** button.

3. Preparation

4. ECG Monitoring

■ Connecting the ECG Lead Cable and Electrodes

The optional ECG lead cables for LX-8100 are as follows.

ECG Lead Cables

Item No.	Applicable Lead	Remark
CMT-01CTH-0.8DA	Limb Lead (1CH)	3-electrode Clip Type
CMT-02CTH-0.8DA	Limb Lead (2CH)	4-electrode Clip Type
CMT-03CTH-0.8DA	Limb Lead (1CH) +Chest (1CH)	5-electrode Clip Type
CMT-01HTH-0.8DA	Limb Lead (1CH)	3-electrode Hook Type
CMT-02HTH-0.8DA	Limb Lead (2CH)	4-electrode Hook Type
CMT-03HTH-0.8DA	Limb Lead (1CH) +Chest (1CH)	5-electrode Hook Type

WARNING

Use only the specified lead cable by Fukuda Denshi. Otherwise, proper monitoring may not be performed, and also it may fail defibrillation or cause a malfunction of the equipment when the equipment is used with a defibrillator.

4. ECG Monitoring

The relations between the attached electrode positions and lead method are as follows. Attach the electrodes to monitor proper waveform.

For 3-electrode lead cable

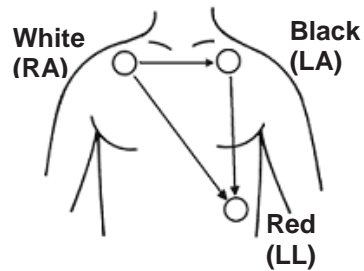

Limb leads

Standard Limb leads can be selected from lead I, lead II, or lead III under the setting of the equipment.

Refer to “7. Operation ■ Changing Setup ● ECG Display Screen (1) <<Switching Lead>>” .

For 4-electrode lead cable

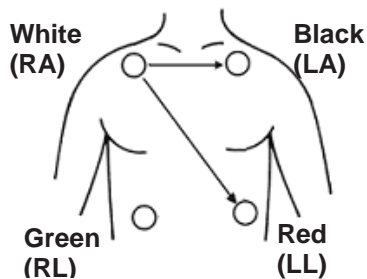

Limb leads

Two leads such as lead I and II can be measured. Lead III, aVR, aVL, and aVF can be also displayed from the setting on the receiving monitor. For details, refer to the operation manual of the receiving monitor

For 5-electrode (Chest) lead cable

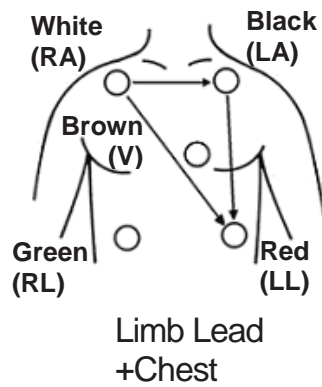

One limb lead and one chest lead (Brown) measurements are available. Standard Limb leads can be selected from lead I, lead II, or lead III under the setting of the equipment.

Refer to "8. Operation ■ Changing Setup ● ECG Display Screen (1) <<Switching Lead>>" .

The chest lead waveform is measured from the chest lead (Brown) positioned on the chest.

■ Attaching the Electrodes

⚠ CAUTION

- Always use the same type of electrodes. If different types of electrodes are used at the same time, the difference between the polarization potential from each electrode may interfere with monitoring.
- Do not reuse the disposable electrodes. It is intended for single patient use only.



Clean the electrode sites with alcohol wipes or other skin preparation. If necessary, shave the electrode sites to remove excessive hair.

Peel off the disposable electrode

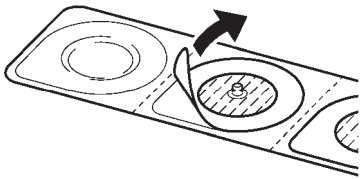

Pay attention not to touch the electrode gel.

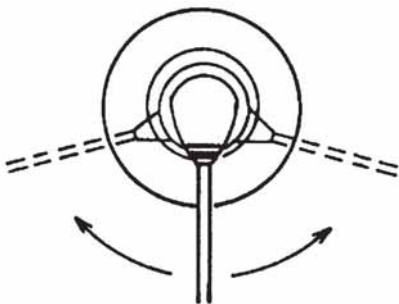

Attach the lead cable end to the electrode (convex part).
Turn right and left to verify that it is securely attached.

■ Connecting the ECG Lead Cable to the LX-8100

Insert the ECG lead cable firmly into the ECG/RESP input connector matching the transmitter's connector guide and the direction of the notched part on the connector.

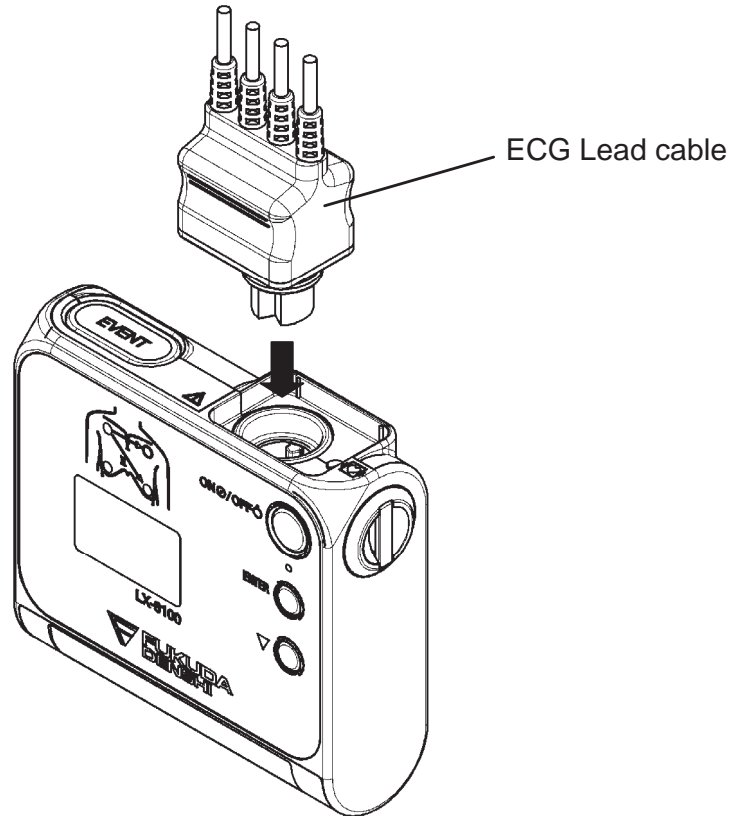

CAUTION

- There are some cases when pacemaker pulse cannot be detected depending on the pacemaker type, pulse voltage, pulse width, electrode lead type (unipolar, bipolar), electrode placement, or lead method which causes the pacemaker pulse amplitude to decrease and disables pacemaker pulse detection.
- If signals similar to a pacemaker pulse are present, such as electric blanket noise or excessive AC frequency noise, these may be erroneously detected and displayed as a pacemaker pulse. In this case, check the condition of the electrodes and ECG lead cable to resolve the cause or turn off the pacemaker detection setting on the receiving monitor.
- Time constant of this equipment is shorter than Fukuda Denshi monitors (direct ECG connection). Therefore, there is a difference in the ST measurement value between them. Pay attention to the difference when monitoring a patient from a transmitter or a monitor.
- When an electrode is attached on the same location for a long time, some patients may develop skin irritation. Check the patient's skin condition periodically and change the electrode position as required.
- The indication for continuous use of an electrode is about one day.
- Replace the electrode if the skin contact gets loosen due to perspiring, etc.
- Make sure to use new disposable electrodes. Otherwise, the waveform quality may become poor and it may fail to perform correct monitoring
- When "Check Electrode" message is displayed on the screen of the receiving monitor or the display of this equipment, check the condition of the electrodes and ECG lead cable to resolve the cause.
- When removing electrodes from the patient, remove them carefully and slowly. Do not apply excessive force to remove them. Otherwise, it may damage the skin.
- It may not perform a correct measurement due to the attached position of the electrodes. Attach the electrodes on the patient referring to page 12 and 13 and make sure that the correct waveform is measured on the display.

5. Respiration Monitoring

Follow the preparation of “4. ECG Monitoring” to allow the respiration monitoring.

This respiration monitoring is performed with impedance method. The ECG electrodes are also used for detecting the respiration. Each lead cable specifies the electrodes to detect the respiration. For 3-electrode and 5-electrode (chest) lead cable, the electrodes to detect the respiration are fixed as follows. Even if lead method is switched, they are no changes.

Lead Cable	Color of Electrode
3-electrode	White (RA) and Red (LL)
4-electrode	White (RA) and Red (LL)
5-electrode (Chest)	White (RA) and Red (LL)

WARNING

Minute ventilation rate-adaptive implantable pacemakers can occasionally interact with certain cardiac monitoring and diagnostic equipment, causing the pacemakers to pace at their maximum programmed rate. The cardiac monitoring and diagnostic equipment may possibly send wrong information.

If such event occurs, please disconnect the cardiac monitoring and diagnostic equipment, or follow the procedures described in the operation manual of the pacemaker.

(For more details, contact FUKUDA DENSHI personnel, your institution's professionals, or your pacemaker distributors.)

Reference

“Minute Ventilation Rate-Adaptive Pacemakers”

FDA alerts health professionals that minute ventilation rate-adaptive implantable pacemakers can occasionally interact with certain cardiac monitoring and diagnostic equipment, causing pacemakers to pace at their maximum programmed rate.

[October 14, 1998 – FDA]

CAUTION

- Even if the electrodes are attached on the proper positions for ECG monitoring, it may not be always the proper ones for respiration monitoring as well.
- When a defibrillator is used during respiration monitoring, a large offset voltage will be placed on the ECG electrodes, which may cause interruption of monitoring for a few seconds.

5. Respiration Monitoring

6. Measurement

Turn ON the power and the measurement starts.

■ Starting Screen

When the power is turned ON, the channel number configured on the LX-8100 is displayed at the top of the display.



Make sure whether the channel number on the display matches the channel number indicated on the label of the LX-8100 and the channel number configured on the receiving monitor.

■ Waveform Display Screen

ECG waveform (1CH when using 3-electrode lead cable, 2CH when using other lead cable), heart rate, pacemaker marker, respirogram, respiration rate, remaining battery level, and various messages are displayed.

⚠ CAUTION

- The LX-8100 does not have a diagnostic function. Check the diagnostic function on the receiving monitor.
- The LX-8100 does not have an alarm function. Check the alarm function on the receiving monitor.
- The ECG waveform size and sweep speed settings displayed on the display of the LX-8100 do not interface with the ones displayed on the screen of the receiving monitor.
- The heart rate and respiration rate displayed on the display of the LX-8100 may be different from the ones displayed on the receiving monitor because the algorithm of the ECG and respiration rate is different.

● Display Switch

The screen can be switched to the other selected screen such as to ECG/RESP. The screen automatically turns itself OFF by following the setting if no operation is done. To restart the display, refer to “7. Operation

■ Restarting the display”.

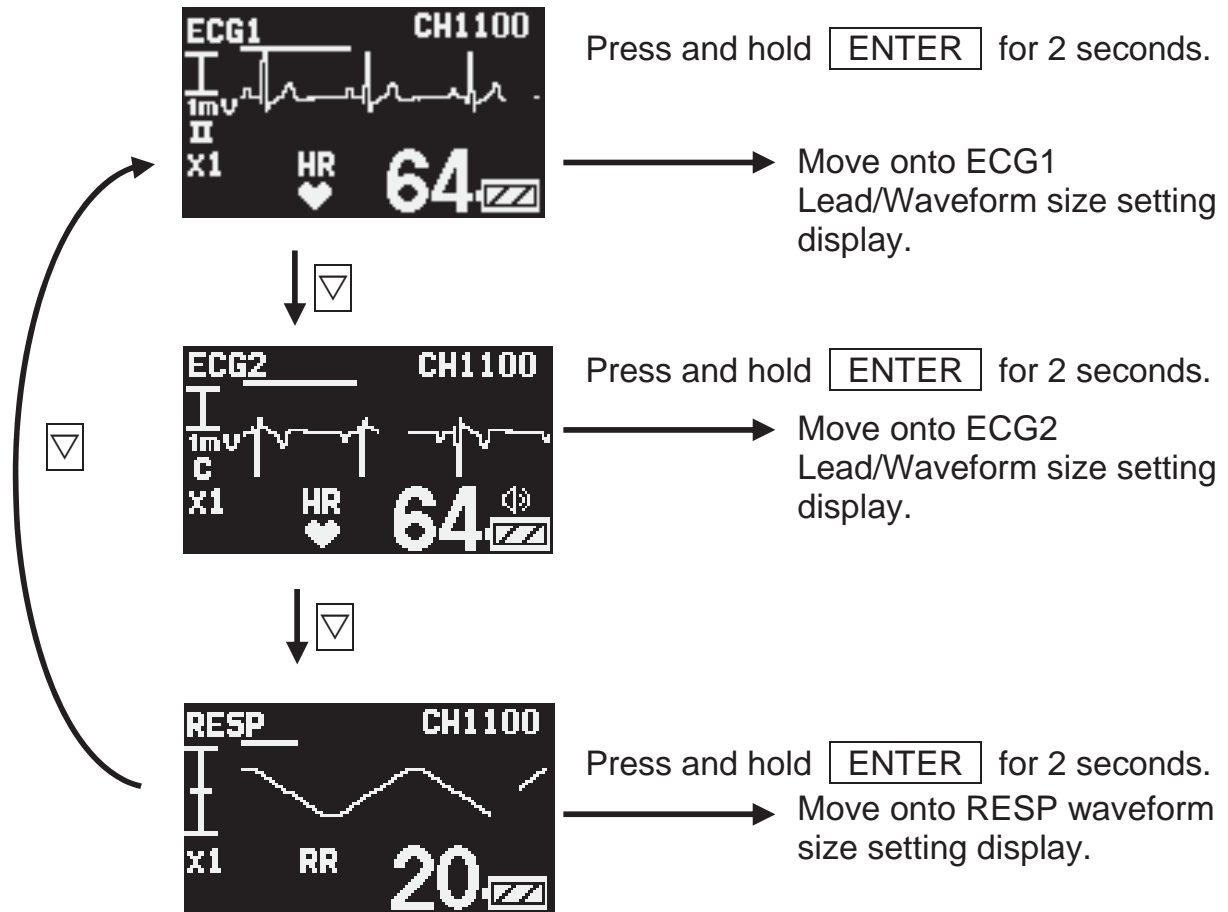

When the display is active, press the  button to move onto the next screen. The screen will be switched in the following order.



■ Battery Level Check

Check the battery level on the waveform display screen.



Battery Symbol	Remaining Battery Level
	Full
	Getting low, but still available
	Nearly empty Replace the battery. A message that prompts the battery check appears on the screen of the receiving monitor.

■ Waveform Display

● ECG Display Screen (1)

ECG1 waveform, heart rate, pacemaker marker, remaining battery level, and electrode check message are displayed.

The screen automatically turns itself OFF by following the setting if no operation is done. To restart the display, refer to “7. Operation

■ Restarting the display”.

When the display is active, press the  button to move onto the next waveform display screen.

【Descriptions of the Screen】

The descriptions of contents displayed on the display are as follows



Indicates ECG 1.



Indicates the vertical scale of the displayed ECG waveform. One scale corresponds to 1mV. In the left illustration, it can display ECG waveform between -1mV and +1mV.

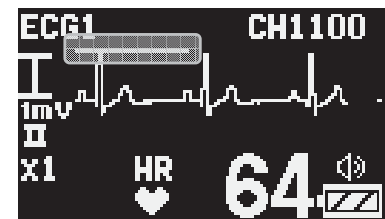

Indicates the horizontal scale of the displayed ECG waveform. One scale corresponds to one second.

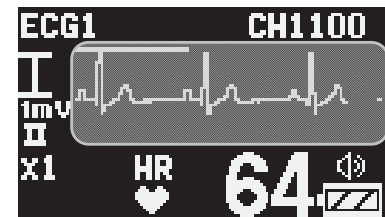

Displays the ECG waveform.

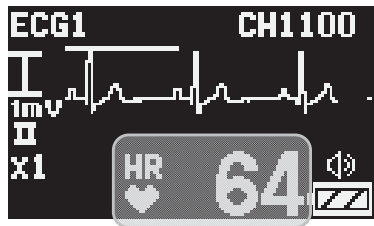

Displays the heart rate.
♥ is displayed in synchronization with the heart rate.

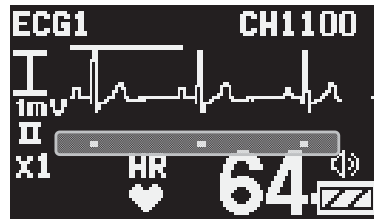

Displays the detection marker when a pacemaker pulse is detected.



Indicates the measuring lead.

⚠ CAUTION

- The ECG waveform size setting displayed on the display does not interact with the one displayed on the screen of the receiving monitor. If the ECG waveform size displayed on the screen of the receiving monitor is changed, follow the instruction in the operation manual of the receiving monitor.
- When Wide is selected in the QRS Detection and in case it is outside of the heart rate range (12 bpm to 300 bpm), 0 bpm will be displayed if 11 bpm and below is measured and 300bpm will be displayed if 300 bpm and above is measured.
- When Narrow is selected in the QRS Detection and in case it is outside of the heart rate range (30 bpm to 300bpm), 0bpm will be displayed if 29 bpm and below is measured and 300 bpm will be displayed if 300 bpm and above is measured.

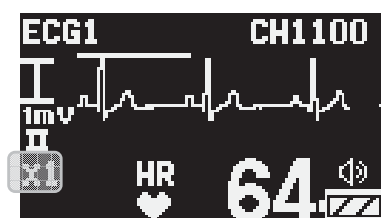

Indicates the ECG waveform size displayed on the display.

6. Measurement

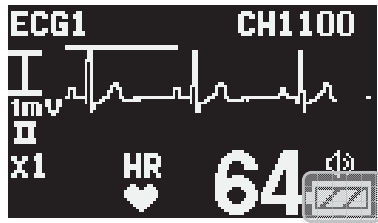

Indicates the remaining battery level.
For details of the battery level, refer to page 21.

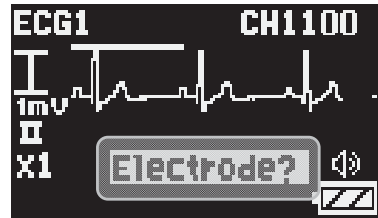

Displays the electrode check.
“Electrode?” message appears when
an ECG electrode is detached.



Displays the speaker mark when
Sync. Tone setting is active.
For details, refer to “7. Operation
■ Changing Setup”.

● ECG Display Screen (2)

ECG2 waveform, heart rate, pacemaker marker, remaining battery level, and electrode check message are displayed.

NOTE

If a 3-electrode lead cable is used, this screen will not appear.

The screen automatically turns itself OFF by following the setting if no operation is done. To restart the display, refer to “7. Operation ■ Restarting the display”.

When the display is active, press the  button to move onto the next waveform display screen.

【Descriptions of the Screen】

The descriptions of contents displayed on the display are as follows.



Indicates ECG 2.



Indicates the vertical scale of the displayed ECG waveform. One scale corresponds to 1mV. In the left illustration, it can display ECG waveform between -1mV and +1 mV.

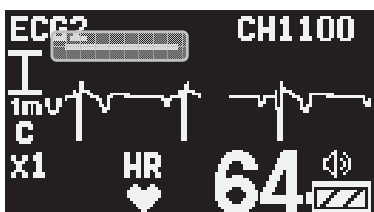

Indicates the horizontal scale of the displayed ECG waveform. One scale corresponds to one second.

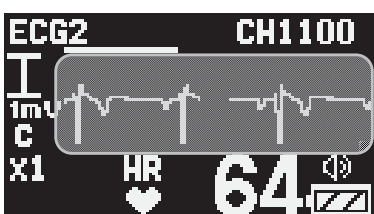

Displays the ECG waveform.

6. Measurement

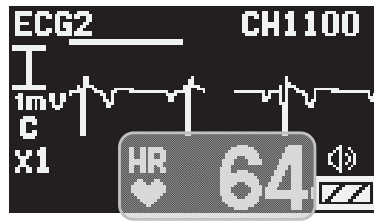

Displays the heart rate.

♥ is displayed in synchronization with the heart rate.

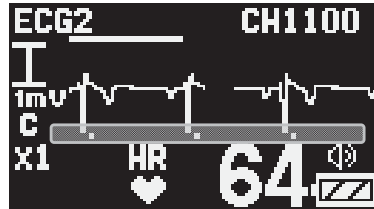

Displays the detection marker when a pacemaker pulse is detected.

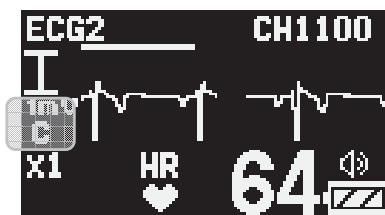

Indicates the measuring lead.

⚠ CAUTION

- The ECG waveform size setting displayed on the display does not interact with the one displayed on the screen of the receiving monitor.
- If the ECG waveform size displayed on the screen of the receiving monitor is changed, follow the instruction in the operation manual of the receiving monitor.
- When Wide is selected in the QRS Detection and in case it is outside of the heart rate range (12 bpm to 300 bpm), 0 bpm will be displayed if 11 bpm and below is measured and 300 bpm will be displayed if 300 bpm and above is measured.
- When Narrow is selected in the QRS Detection and in case it is outside of the heart rate range (30 bpm to 300 bpm), 0bpm will be displayed if 29 bpm and below is measured and 300 bpm will be displayed if 300 bpm and above is measured.

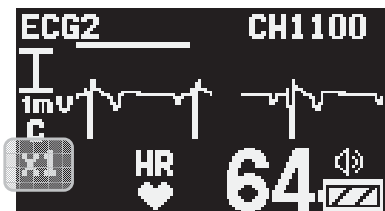

Indicates the ECG waveform size displayed on the display.



Indicates the remaining battery level. For details of the battery level, refer to page 21.

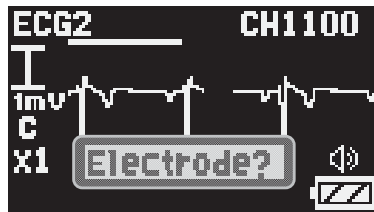

Displays the electrode check. "Electrode?" message appears when an ECG electrode is detached.

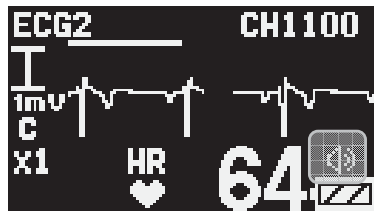

Displays the speaker mark when Sync. Tone setting is active. For details, refer to "7. Operation ■ Changing Setup".

6. Measurement

● Respiration Display Screen

Respiration waveform, respiration rate, remaining battery level, and electrode check message are displayed.

The screen automatically turns itself OFF by following the setting if no operation is done. To restart the display, refer to “7. Operation ■ Restarting the display”.

When the display is active, press the  button to move onto the next waveform display screen.

【Descriptions of the Screen】

The descriptions of contents displayed on the display are as follows.



Indicates the respiration waveform display screen.



Indicates the vertical scale of the displayed respiration waveform. One scale corresponds to 1Ω. In the left illustration, it can display the change of respiration waveform between -1Ω and +1Ω.

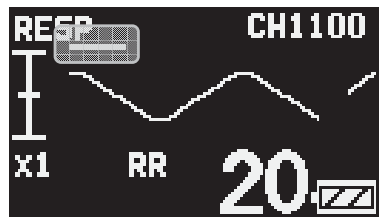

Indicates the horizontal scale of the displayed respiration waveform. One scale corresponds to one second.

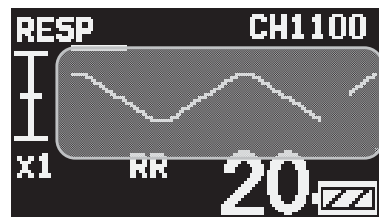

Displays the respiration waveform.

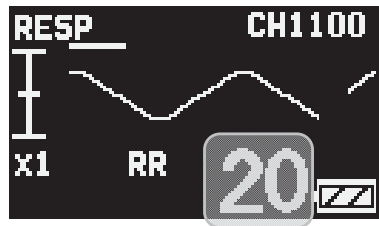

Displays the respiration rate.

⚠ CAUTION

- The ECG waveform size setting displayed on the display does not interact with the one displayed on the screen of the receiving monitor.
- If the ECG waveform size displayed on the screen of the receiving monitor is changed, follow the instruction in the operation manual of the receiving monitor.
- In case it is outside of the respiration rate range (4 Bpm to 150 Bpm), 0 Bpm will be displayed if 3 Bpm and below is measured and 150 Bpm will be displayed if 150 Bpm and above is measured.

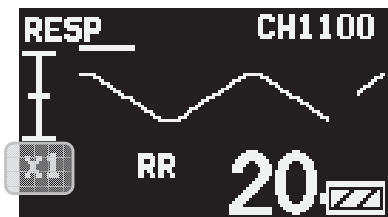

Indicates the respiration waveform size displayed on the display.



Indicates the remaining battery level. For details of the battery level, refer to "6. Measurement ■ Battery Level Check".

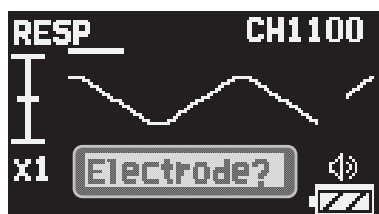

Displays the electrode check "Electrode?" message appears when an ECG electrode is detached.

6. Measurement

7. Operation

■ Changing Setup

● ECG Display Screen (1)

In the ECG display screen (1), the ECG waveform size and lead displayed on the display of the LX-8100 can be changed and the Synchronized Tone can be set up.

【Setting Method】

How to enter the setup mode:

Press and hold the **ENTER** button for 2 seconds in the ECG display screen (1).

« Switching Lead »

Lead of ECG 1 can be switched when 3-electrode lead cable or 5-electrode (Chest) lead cable is used.

Select an appropriate lead by checking the ECG waveform on the display.



The lead indication of ECG 1 is highlighted.

Pressing the **ENTER** button will sequentially change the lead of ECG 1.

Lead I → II → III → I

« Changing ECG1 Waveform Size on display »

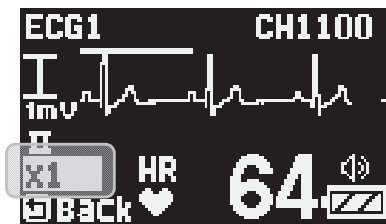

Press the **▽** button to highlight the size indication of ECG 1.

Pressing the **ENTER** button will sequentially change the size of ECG 1.

Size x1 → x1/2 → x1



When changing the size of the ECG waveform on the display, the ECG scale will also change.

In the left illustration, it can display the ECG waveform between -2mV and +2mV.

⚠ CAUTION

The ECG waveform size setting displayed on the display of the LX-8100 does not interact with the one displayed on the screen of the receiving monitor. To change the waveform size of the receiving monitor, follow the instruction in the operation manual of the receiving monitor.

«Returning to ECG Display Screen (1)»

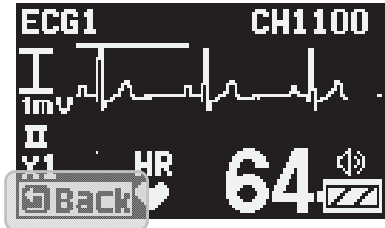

Press the button to highlight the “Back”.

Press the button to return to the ECG display screen (1).

⚠ CAUTION

Do not operate the LX-8100 with the setup screen open because it may lead to an unintended operation and cause setting changes. Make sure to press the “Back” to terminate the setup screen. The display will automatically turn itself OFF by following the setting if the “Back” is not pressed.

【Setting the Synchronized Tone】

Press and hold the button and button for 2 seconds in the ECG display screen (1).

The speaker symbol can be switched to display ON/OFF.

«Generate a Synchronized Tone»

When the speaker symbol is displayed, a Synchronized Tone will generate along with the Synchronized mark. The Synchronized Tone will generate only in the ECG screen.



Press and hold the button and button for 2 seconds then the speaker symbol will be displayed.

Press and hold the button and the button again for 2 seconds, then the speaker mark will disappear and the synchronized tone will stop. The setting synchronizes the ECG screen (2) so this setting is also reflected in the ECG screen (2).

● ECG Display Screen (2)

In the ECG display screen (2), the ECG waveform size displayed on the display of the LX-8100 can be changed and the synchronized tone can be set up.

【Setting Method】

How to enter the setup mode.

Press and hold the **ENTER** button for 2 seconds in the ECG display screen (2).

« Changing ECG2 Waveform Size on display »

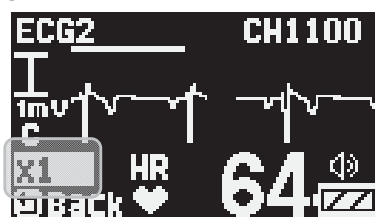

The size indication of ECG 2 is highlighted.

Pressing the **ENTER** button will sequentially change the size of ECG 2.

Size $x1 \rightarrow x1/2 \rightarrow x1$

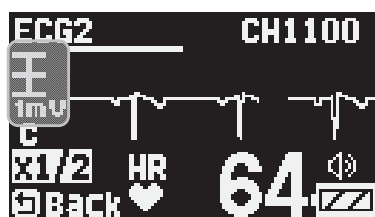

When changing the size of the ECG waveform on the display, the ECG scale will also change. In the left illustration, it can display ECG waveform between -2mV and +2mV.

⚠ CAUTION

The ECG waveform size setting displayed on the display of the LX-8100 does not interact with the one displayed on the screen of the receiving monitor. To change the waveform size of the receiving monitor, follow the instruction in the operation manual of the receiving monitor.

«Returning to ECG display screen (2)»

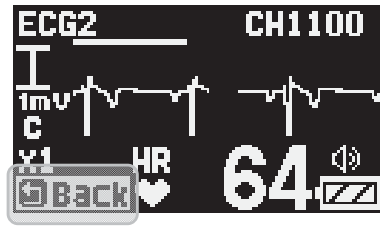

Press the button to highlight the "Back".
Press the button to return to the ECG display screen (2).

⚠ CAUTION

Do not operate the LX-8100 with the setup screen open because it may lead to an unintended operation and cause setting changes. Make sure to press the "Back" to terminate the setup screen. The display will automatically turn itself OFF by following the setting if the "Back" is not pressed.

【Setting Method】

Press and hold button and button for 2 seconds in the ECG display screen (2).

«Generate a Synchronized Tone»

When the speaker symbol is displayed, a Synchronized Tone will generate along with the Synchronized mark. The Synchronized Tone will generate only in the ECG screen.



Press and hold the button and button for 2 seconds then the speaker symbol will be displayed.
Press and hold the button and the button again for 2 seconds, then the speaker mark will disappear and the synchronized tone will stop. The setting synchronizes the ECG screen (1) so this setting is also reflected in the ECG screen (1).

● Respiration Display Screen

In the respiration display screen, the respiration waveform size displayed on the display of the LX-8100 can be changed.

【Setting Method】

How to enter the setup mode:

Press and hold the button for 2 seconds in the respiration display screen.

«Changing Respiration Waveform Size on display»



The size indication of the respiration is highlighted.

Pressing the button will sequentially change the size of respiration.

Size $x1 \rightarrow x1/2 \rightarrow x1$



When changing the size of the respiration waveform on the display, the respiration scale will also change.

In the left illustration, it can display the respiration waveform until 4Ω of change.

⚠ CAUTION

The ECG waveform size setting displayed on the display of the LX-8100 does not interact with the one displayed on the screen of the receiving monitor. To change the waveform size of the receiving monitor, follow the instruction in the operation manual of the receiving monitor.

7. Operation

«Returning to the Respiration Display Screen»

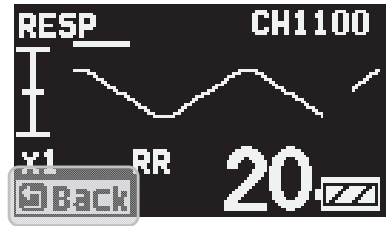

Press the  button to highlight the “Back”.

Press the “Back” to return to the Respiration Display Screen.

CAUTION

Do not operate the LX-8100 with the setup screen open because it may lead to an unintended operation and cause setting changes. Make sure to press the “Back” to terminate the setup screen. The display will automatically turn itself OFF by following the setting even though the “Back” is not pressed.

■ Restarting the display

The display automatically turns itself OFF after the preprogrammed duration if no operation is done.

Press the **ENTER** button or press and hold the  button to restart the display.

The starting screen with the telemetry channel number appears, and then the waveform display screen appears.

The setting for the timeout duration of the display screen can be changed. For details, refer to page 50.

⚠ CAUTION

- The heart rates and respiration rates are not measured during display OFF. Therefore, the display screen may not accurately display heart rates and respiration rates right after restarting.
- If battery level 1  is displayed, the display will not automatically turn OFF. In such case, replace the battery.

■ Pressing the EVENT button

Press and hold the **EVENT** button for 2 seconds to activate the function assigned on the receiving monitor. The following message appears on the display while the “EVENT” is transmitted.

After the transmission is completed, the waveform display screen appears.

“EVENT” operation is available as a remote recording.

For details of the receiving monitor operation and settings related to the “EVENT” function, refer to the operation manual of the receiving monitor.



7. Operation

8. Other Setting Items

The following settings are available for the LX-8100 depending on the use and condition of the patient. For details of the settings, contact our service representative.

Items	Selection	Default	Backup
Time Constant	0.4 sec, 0.1 sec	0.4 sec	<input type="radio"/>
Detection Sensitivity of Pacemaker Pulse (Pace Sens.)	Low, Mid, High	Mid	<input type="radio"/>
QRS Detection (QRS Width)	Wide, Narrow	Wide	<input type="radio"/>
Respiration Detection Signal (Display)	ON, OFF	ON	<input type="radio"/>
Display Brightness (Brightness)	8 levels	5	<input type="radio"/>
Turn Off Display Time (Display OFF)	1 min, 3 min, 10 min, OFF	3 min	<input type="radio"/>
Sound (Sound)	ON, OFF	ON	<input type="radio"/>
Transmitter Channel (CH)	One from following channels. 0801 to 0879 0900 to 0979 1000 to 1079 1100 to 1179 1200 to 1279 1300 to 1379	—	<input type="radio"/>
Group ID	One from 00 to 63,	00	<input type="radio"/>

■ Changing the Time Constant

The default setting of the time constant is “0.4 seconds”.

If a stable monitoring is difficult with excessive change in the baseline due to excessive body motion of the patient or an interference noise, such as AC frequency, by changing the time constant to “0.1 second” the monitoring may become relatively stable.

For details of the setting, contact your local Fukuda Denshi service representative.

CAUTION

- When changing the time constant to “0.1 seconds”, the lower frequency characteristic becomes $1.6 \text{ Hz} \pm 25\%$. This setup does not meet IEC 60601-2-27 standard. It may lead to a change in the ECG waveform and the ST measurement value may be especially affected. Fukuda Denshi recommends “0.4 seconds” setting in normal use.
- The display screen in normal use does not indicate the selection of time constant. Make sure to take measures, such as marking on the LX-8100, to distinguish whether the selection of time constant has changed.

■ Changing the Detection Sensitivity of the Pacemaker Pulse

The default setting of pacemaker pulse detection sensitivity is “Mid”. The “Mid” setting can detect and reject the following pacemaker pulse specified in IEC 60601-2-27 standard.

Detection/Rejection of Pacemaker Pulse:

- a) Pacemaker Pulse without Over/Undershoot:
Capable to detect pulses of pulse width 0.1 ms to 2 ms, amplitude $\pm 2 \text{ mV}$ to $\pm 700 \text{ mV}$.
- b) Pacemaker Pulse with Over/Undershoot:
Rejection is not possible.

Fukuda Denshi recommends the “Mid” setting in normal use.

There may be some cases when the pacemaker pulse cannot be detected depending on the pacemaker type, pulse voltage, pulse width, electrode lead type (unipolar, bipolar). In this case, change the lead or the position of the electrodes to be able to detect the pacemaker pulse.

Nonetheless, if the detection is still undetectable, change the setting to “High” in order to increase the detection sensitivity. So that smaller pacemaker pulse can be detected. However, the “High” setting may lead to erroneous detection due to interference noise, such as AC frequency.

If erroneous detections occur due to interference noise, such as AC frequency, turn OFF the setting of the pacemaker pulse detection in the receiving monitor. If erroneous detections occur due to interference noise, such as AC frequency, while monitoring a patient with a pacemaker and the setting of the pacemaker pulse detection cannot be turned OFF, replace the electrodes or change the lead to remove the interference noise, such as AC frequency.

Nonetheless, if erroneous detections still occur, change the setting to “Low” in order to decrease the detection sensitivity. It makes the LX-8100 less likely to be interfered by noise, such as AC frequency.

The “Low” setting decreases the detection sensitivity. Therefore, it cannot detect the pacemaker pulse specified in IEC 60601-2-27 standard.

For details of the setting, contact your local Fukuda Denshi service representative.

CAUTION

The display screen in normal use does not indicate the setting status of the pacemaker pulse detection. Make sure to take measures, such as marking on the LX-8100, to distinguish whether the setting of the pacemaker pulse detection has changed.

■ Changing QRS Detection

The QRS detection mode of the LX-8100 is initially set as “Wide”. The setting can be changed to “Narrow” if it cannot detect the heart rates due to narrow QRS amplitude.

For details of the setting, contact your local Fukuda Denshi service representative.

CAUTION

- This setting is effective only for the display screen of the LX-8100 and it is not reflected in the QRS detection setting of the receiving monitor. To change the QRS detection in the receiving monitor, refer to the operation manual of the receiving monitor.
- The display screen in normal use does not indicate the setting status of the QRS detection mode such as “Wide/Narrow”. Make sure to take measures, such as marking on the LX-8100, to distinguish whether the setting of the QRS detection mode has changed.

■ Changing the Respiration Detection Signal ON/OFF

The default setting of the respiration detection signal is “ON”.

The respiration waveform can be detected when the setting of the respiration detection signal is turned “ON”.

WARNING

If the LX-8100 is used with minute ventilation rate-adaptive implantable pacemaker, the respiration detection signal may cause the pacemaker to pace at its maximum programmed rate. If such event occurs, change the setting to “OFF” to prevent an occurrence of erroneous pacing rate.

For details of the setting, contact your local Fukuda Denshi service representative.

CAUTION

- The respiration waveform cannot be measured if the setting of the respiration detection signal is turned “OFF”.
- Make sure to turn OFF the respiration measurement function on the receiving monitor to prevent an erroneous detection of the respiration alarm (on the receiving monitor side)
- The display screen in normal use does not indicate the setting status of the respiration detection signal ON/OFF. Make sure to take measures, such as marking on the LX-8100, to distinguish whether the setting of the respiration detection signal ON/OFF has changed.

■ Changing the Display Brightness

The display brightness of the LX-8100 can be changed in 8 levels.

For details of the setting, contact your local Fukuda Denshi service representative.

■ Changing the Display Timeout Duration

The time to automatically turn OFF the display while not in operation can be selected from 1 min, 3 min, 10 min or OFF (The display will not turn off). The default setting is “3 min”.

For details of the setting, contact your local Fukuda Denshi service representative.

CAUTION

If battery level 1  is displayed, the display will not automatically turn OFF. In such case, replace the battery.

■ Changing Sound ON/OFF

When the sound setting is “ON”, Alarm will generate in the following situation.

- ECG Lead Off

The default setting is “ON”.

Alarm will not generate with Display OFF status.

For details of the setting, contact your local Fukuda Denshi service representative.

8. Other Setting Items

9. Changing the Transmitter Channel and Group ID

■ Changing the Transmitter Channel

The LX-8100 is a transmitter of PLL synthesizer type, and its transmitter channel can be programmed. It can be set up with an arbitrary channel among the channels assigned by the Telemetry Laws (according to each country).

For details of the setting, contact your local Fukuda Denshi service representative.

WARNING

- If the transmitter channel is changed, follow the instruction by the person in charge of the radio telemetry channel in your facility. Mismanagement may result in a serious accident, such as interference and mixing up patients.
- Replace promptly with new channel label if the transmitter channel has been changed.

■ Changing the Group ID

The LX-8100 transmits its group ID, which it belongs to, to prevent interference with neighboring hospital's transmitter.

The receiving monitor checks whether the incoming group ID is the same as the programmed one that the receiving monitor has. There are 64 group codes available. The default setting is "00".

The transmitter group ID can be changed if there is interference with a neighboring hospital's transmitter.

For details of the setting, contact your local Fukuda Denshi service representative.

CAUTION

Possible causes of interference other than radio telemetry from neighboring hospital's transmitter, are the proximity of mobile phone, amateur radio station, radio taxi, and illegal citizens band, which may be a cause of interference. In such a case, the situation should be carefully observed to find the cause of interference.

9. Changing the Transmitter Channel and Group ID

10. Troubleshooting

■ List of Displayed messages

Transmitter (Main Unit)

Message	Cause	Solution
System Error Error: R01 Telemeter Comm. Error	Failed to transmit waveform and value.	Contact your local Fukuda Denshi service representative.
System Error Error: R03 EEPROM Read Error	Faulty EEPROM.	
System Error Error: P01 CPU Error	Failed to initialize CPU.	
System Error Error: P02 Speaker Error	Faulty Speaker.	

ECG

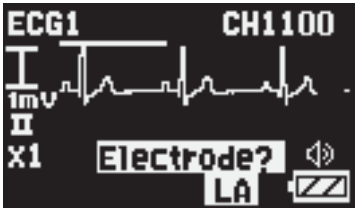
Message	Cause	Solution
 <p>Character string displayed, such as LA, depends on the detached electrode position.</p>	<p>Electrode is off.</p>	<p>Check the electrode condition.</p>

■ Troubleshooting

Make sure of the following. However, if there is no improvement in the phenomenon, contact your local Fukuda Denshi service representative.

Transmitter (main unit)

Phenomenon	Cause	Solution
Nothing is displayed on the display when the power switch is turned ON.	No battery or wrong polarity.	Install the battery correctly.
	Battery level is empty.	Replace the battery with a new one.
Restart	Battery level is empty.	Replace the battery with a new one.
Nothing is displayed on the display even though LED is on when the power switch is turned ON.	Battery level is empty.	Replace the battery with a new one.
Nothing is displayed on the receiving screen.	The channel number between the transmitter and the receiving monitor do not match up.	Set the same channel number for the transmitter and the receiving monitor.
Transmission problem.	Same channel number is already used.	Make sure to not duplicate channel numbers. Follow the instruction by the person in charge of radio telemetry channel in your facility and use the LX-8100 with the correct channel setting.
	Channel interference.	Follow the instruction by the person in charge of radio telemetry channel in your facility and use the LX-8100 with the correct channel setting.
	Transmitter failure.	Contact your local Fukuda Denshi service representative.

ECG

Phenomenon	Cause	Solution
“ELECTRODE?” message is displayed.	Lead cable is off.	Check the connection between the lead cable and the LX-8100.
		Check the connection between the lead cable and the electrode.
	Faulty Lead cable.	Replace the ECG cable with a new one.
	Electrode is peeling off.	Replace the electrode with a new one.
	Polarization potential of the electrode is too high.	
ECG waveform contains noise.	Electrode gel is dry	Replace the electrode with a new one.
	Electrode is peeling off.	
	Electric blanket is used.	Cover the electric blanket with a shield cover.
	AC filter setting of the receiving monitor is OFF.	Set the AC filter up as ON.
Respiration waveform cannot be measured.	Electrode gel is dry	Replace the electrode with a new one.
	Electrode is peeling off.	
	The positions of the electrodes are improper.	Attach the electrodes where the respiration waveform can be measured appropriately.

■ In Case of Dropping the LX-8100 into Water

In case of dropping the LX-8100 into water containing disinfectant, pick up the LX-8100 quickly from it. Rinse it well with running water, and dry it thoroughly with a soft cloth

 CAUTION

- Do not use a dryer. The LX-8100 shape may change or be broken.
- When the LX-8100 is rinsed with running water, make sure to close the battery compartment lid.

10. Troubleshooting

11. Cleaning and Disinfection

The cleaning and disinfection of the LX-8100 and ECG lead cable shall be performed as follows.

CAUTION

Do not sterilize the LX-8100 and ECG lead cable in any manners, such as radioactive rays, steam, or ethylene oxide.

■ Cleaning

Clean the LX-8100 using a squeezed gauze or an absorbent cotton cloth dampened with alcohol or a neutral cleanser.

CAUTION

- Clean the equipment frequently so stains can be removed easily.
- To prevent injury, it is recommended to wear gloves when cleaning the equipment.
- Do not allow any chemical solution to enter the inside of LX-8100 or connectors
- The LX-8100 cannot be sterilized.
- Do not use organic solvents, thinner, toluene and benzene to avoid damaging the resin case.
- Do not polish the housing with abrasive or chemical cleaner.
- Use only neutral detergent to clean the housing. Do not use chemical cloth, scrub brush, abrasive, polishing powder, hot water, volatile solvent and chemicals (cleanser, thinner, benzene, benzol, and synthetic detergent for house and furniture), or sharp-edged tools. The surface resin coating may be damaged, resulting in discoloration, scratches, and other problems.

■ Disinfection

If there is a possibility of being infected, clean the LX-8100 using a squeezed gauze or an absorbent cotton cloth dampened with alcohol or invert soap.

CAUTION

- Do not immerse the connector parts of the LX-8100 in any chemical solution to prevent connection failure.
- When disinfecting the entire room using a spray solution, pay close attention not to have liquids get into the LX-8100 or connectors.

■ Cleaning the ECG lead cable

After using the cable, clean it with neutral detergent or 70% isopropyl alcohol.

CAUTION

- Do not use thinner, toluene, or other organic solvents to clean the cables.
- Do not pull the cable and do not hold the connector part when cleaning.
(It may degrade the cable coating and result in damage. Particularly organic solvents and antiseptic solution such as cresol soap solution will degrade the cable coating.)
- After cleaning, dry it completely before usage.
- Do not use high temperature sterilization such as steam or EOG method.

12. Maintenance and Inspection

This section explains the daily checks and periodic checks of the LX-8100. To ensure safety, reliability, and high performance, a “Daily Check” and “Periodic Check” must be performed. We are not liable for any accident arising from lack of maintenance. A full technical description of the LX-8100 is available from your local Fukuda Denshi representative.

CAUTION

- Do not open the housing
- Do not allow excessive moisture or cleaning agents into the connectors or inside the equipment.

■ Daily Check

Perform daily checks using the “Daily Check List” on the next page.

■ Periodic Check

Periodic check of medical electronic equipment is mandatory to prevent failures and accidents, and to ensure safety and reliability.

Periodic maintenance may be performed by the medical institution or by a third party by concluding a “Maintenance Contract”.

For more details, contact your local Fukuda Denshi service representative.

Perform Periodic check using the “Periodic Check List”.

The periodic check should be performed once a year.

If there is an item with “Fail” judgement, the overall judgement will be “Fail”.

Make sure to take countermeasures for the “Fail” item.

Use the equipment only if the judgements of all the items are “Pass”.

■ Periodic Replacement Parts

The “Battery Compartment Lid (Waterproof)” is the only periodic replacement part.

To ensure the reliability of waterproof (IPX8) performance of the LX-8100, replace it once a year.

Contact your local Fukuda Denshi service representative for replacement. The reliability of water resistance (IPX8) performance will not be ensured without yearly replacement.

CAUTION

The periodic replacement parts must be replaced at specified period.

Daily Check List

No. _____

Inspected Date _____ Inspected by _____ Location _____

Device Type LX-8100 _____ S/No. _____ Date of Purchase _____

Items	Details	Criteria	Judgment
Appearance	Visually check for any damage, cracks, chip, peeled label, and loosen screw on the housing.	No abnormality should be found.	<input type="checkbox"/> OK/ <input type="checkbox"/> NG
Battery Compartment	Visually check for the ring condition of the battery compartment lid.	No damage, kink, floating, and adhesion of dust should be found.	<input type="checkbox"/> OK/ <input type="checkbox"/> NG
	Visually check for the contact springs, inside the LX-8100, to the battery and the lock lever of the battery compartment lid.	No deformation, cracks, and rust should be found.	<input type="checkbox"/> OK/ <input type="checkbox"/> NG
Power Supply	Turn the power ON/OFF to verify proper switch operation.	With batteries installed, the display should turn ON.	<input type="checkbox"/> OK/ <input type="checkbox"/> NG
ECG Connectors	Visually check the connectors of the cable and the LX-8100.	No damage, chip, and adhesion of dust should be found.	<input type="checkbox"/> OK/ <input type="checkbox"/> NG
ECG Lead cable	Visually check each lead for damages.	No crack and damage should be found.	<input type="checkbox"/> OK/ <input type="checkbox"/> NG
Wireless Channel	Verify whether the transmitting channel and group ID are the same with the receiving monitor.	Must match the wireless channel check list.	<input type="checkbox"/> OK/ <input type="checkbox"/> NG
Transmission Function	Turn the power ON and make sure the information is displayed on the receiving monitor.	Waveforms and values should be received without any problem.	<input type="checkbox"/> OK/ <input type="checkbox"/> NG
Display Function	Turn the power ON and verify each display condition.	All data should be properly displayed.	<input type="checkbox"/> OK/ <input type="checkbox"/> NG
Periodic Check	Check the date of the previous periodic check.	Should be within one year.	<input type="checkbox"/> OK/ <input type="checkbox"/> NG

Comment

■ Periodic Check

The periodic maintenance check is intended to check the medical equipment used daily in a medical institution to prevent failures and accidents and to ensure safety and reliability.

The check procedures are described for daily and periodic checks. Each check item must be performed according to the described check procedure.

The consignee can select the check items according to the product quality, frequency of usage, and maintenance check period. However, electrical safety items must also be performed.

For details of the electrical safety check procedure, refer to IEC 60601-1.

● Periodic Check Items

The periodic check items are as follows.

No.	Check Item
1	External Appearance
2	Power Supply Switch
3	Display / Operation / Record
4	ECG
5	Respiration
6	Speaker
7	Electrical Safety

No.	Check Item	Check Procedure	Criteria
1. External Appearance, Accessories			
01	Appearance	Visually check the exterior for scratches, cracks, deformation, and rust.	No abnormality should be found.
02	Cables	Visually check all cables for any damage or being disconnected.	No damage should be found.
03	Operation Manual	Check if the operation manual and other accompanying documents are stored in the specified places.	Should be stored in the specified place.

No	Check Item	Check Procedure	Criteria
2 Power Supply Switch			
01	Power Supply Switch	Turn ON/OFF the power switch.	Should turn ON/OFF the power switch properly.

12. Maintenance and Inspection

No	Check Item	Check Procedure	Criteria
3 Display, Operation, Record			
01	Labels	Visually check the labels, caution labels, etc.	Should be clean, clear and firmly attached.
02	Operation, Switches and keys	Check by operating the switches and keys.	Should operate properly.
03	Display	Check that the characters and waveforms appear on the display.	The characters and waveforms should be clearly displayed. The brightness should be sufficient.

No	Check Item	Check Procedure	Criteria
4 ECG			
01	Input Impedance*	According to test procedure of IEC 60601-2-27:2011 201.12.1.101.3	Should be 2.5MΩ or above.
02	Suppression Characteristic of Common-Mode Signal*	According to test procedure of IEC 60601-2-27:2011 201.12.1.101.10	Should be 10mmp-p or below for standard sensitivity (sensitivity 1).
03	Transient Characteristic*	With comprehensive tester, apply standard voltage of 1mV, and check the time the amplitude natural logarithmically drops and becomes 37% of the waveform of 0.04 sec. after the application of standard voltage.	Should be 0.4 ± 0.1 seconds. (When the time constant is set to 0.4seconds.)
04	Frequency Characteristic*	With comprehensive tester, apply sinusoidal voltage. Measure the frequency characteristic at test voltage of 40Hz. According to test procedure of IEC 60601-2-27:2011 201.12.1.101.8	Should be 40Hz (-3dB) or above.
05	Heart Rhythm Detection*	With comprehensive tester, input both positive and negative polarity of 0.3mV and 3mV with sensitivity 1. According to test procedure of IEC 60601-2-27:2011 201.12.101.15	The heart beat rhythm should be detected with sensitivity 1 according to the peak-to-peak signal of 0.3mV and 3mV.

06	ECG Sensitivity	With comprehensive tester, apply 1mV voltage and measure the displayed amplitude. According to test procedure of IEC 60601-2-27:2011 201.12.1.101.1	Wave form size on the receiving monitor should be within 0mm $\pm 10\%$ at sensitivity1.
07	Heart Rate Accuracy*	With ECG simulator, test heartbeat 60, 180 beats/min., and check the displayed HR value. According to test procedure of IEC 60601-2-27:2011 201.12.101.15	For reference heartbeat signal of 60, 180 beats/min., error of the displayed HR value should be within ± 3 beats/min.
08	ECG Lead Switch	With ECG simulator, check that each lead is displayed properly. (Check for 3-electrode, and 4-electrode, 5-electrode.)	For each lead cable, lead should be correctly switched, and waveform should be correctly displayed.
09	Lead-Off Indication	Remove each electrode, and check that lead-off message is displayed.	Lead-Off message for the corresponded lead should be displayed.
10	ECG Lead Cable Recognition	Switch the ECG lead cable or switch the setup of lead cable.	Should correctly recognize the connected lead cable.

* As these functions are dependent on the design or software, these items are not mandatory for periodic checks. Perform the test as necessary.

12. Maintenance and Inspection

No	Check Item	Check Procedure	Criteria
5 Respiration			
01	Respiration Waveform Sensitivity	With comprehensive tester or reference respiration signal generator, input sinusoidal waveform of 0.5Hz with base resistance of 1.5k Ω /1 Ω change.	The amplitude displayed on the receiving monitor screen should be within 10 mm \pm 2 mm.
02	Respiration Rate Accuracy*	Input reference respiration signal to comprehensive tester or respiration simulator, and check the respiration rate display. Test with the respiration reference load signal of 60, 120/min.	Error should be within \pm 5 Bpm.
03	Frequency Characteristic*	With comprehensive tester or reference respiration signal generator, input 0.5Hz and 1.5Hz or 2.5Hz, and measure the frequency characteristic.	The crest value at 1.5 Hz should be more than 70% of the crest value at 0.5 Hz input.

* As these functions are dependent on the design or software, these items are not mandatory for periodic checks. Perform the test as necessary.

No	Check Item	Check Procedure	Criteria
6 Speaker			
01	Generation	Generate synchronized tone and check the sound.	Generating synchronized tone.

No	Check Item	Check Procedure	Criteria
7 Electrical Safety			
01	Contact current	Measure the leakage current that runs through the ground from the enclosure of the device under normal condition using a leak measurement safety tester. According to test procedure of IEC 60601-1 8.7.4	From the enclosure to the ground (NC) \leq 0.1mA.
02	Patient leakage current that runs through the ground from the patient connecting part (NC)	Measure the patient leakage current that runs through the ground from the patient connecting part using a leak measurement safety tester. According to test procedure of IEC 60601-1 8.7.4	【AC/DC】 From the patient connecting part to the ground (NC) \leq 0.01mA.

No	Check Item	Check Procedure	Criteria
03	Leakage current when external voltage is applied to the patient connection in the Type F attaching part (SFC)	Measure the leakage current when external voltage is applied to the patient connection in the Type F attaching part using a leak measurement safety tester. According to test procedure of IEC 60601-1 8.7.4	Leakage current when external voltage is applied to the patient connection in the Type F attaching part. (SFC) $\leq 0.05\text{mA}$.
04	Total patient leakage current that runs through the ground from the total patient connecting part. (NC)	Measure the total patient leakage current that runs through the ground from the patient. According to test procedure of IEC 60601-1 8.7.4	【AC/DC】 From the patient connecting part to the ground (NC) $\leq 0.05\text{mA}$.
05	Leakage current when external voltage is applied to the patient connection in the Type F attaching part (SFC)	Measure the leakage current when external voltage is applied to the patient connection in the Type F attaching part using a leak measurement safety tester According to test procedure of IEC 60601-1 8.7.4	Leakage current when external voltage is applied to the patient connection in the Type F attaching part. (SFC) $\leq 0.01\text{mA}$.
06	Patient auxiliary current (NC)	Measure the patient auxiliary current (NC) using a leak measurement safety tester According to test procedure of IEC 60601-1 8.7.4	Patient auxiliary current (NC) $\leq 0.01\text{mA}$.

No	Check Item	Check Procedure	Criteria
7	Electrical Safety (*) Perform the following check item as appropriate. Check these items when you have disassembled the equipment to check/ replace the boards or units.		
07	Withstand Voltage Test (the enclosure – isolated connecting part)	Apply AC1500V for 1 minute between the enclosure and a connecting part. Note: The voltage differs depending on the internal protective circuit composition of the equipment. According to test procedure of IEC 60601-1 8.8.3	Should withstand applied voltage.

12. Maintenance and Inspection

Periodic Check List

Telemetry Transmitter Periodic Check Report

Check Date

Location		Delivery Date		Periodic Check Contract <input type="checkbox"/> Yes <input type="checkbox"/> No Month Check
		Customer Code		
Model Name	Serial No.:	Product Code		Next Check Date
Requested Item			Acceptance Date	

No.	Check Item	Judge	Check
1 Exterior, Accessories			
01	Exterior	OK NG	
02	Cabels	OK NG	
03	Operation Manuals	OK NG	
2 Power Supply Switch			
01	Power Supply Switch	OK NG	
3 Display, Operation, Record			
01	Labels	OK NG	
02	Operation Switch/Key	OK NG	
03	LCD	OK NG	
4 ECG			
01	Input Impedance	OK NG	
02	Suppression Characteristic of Common-Mode Signal	OK NG	
03	Transient Characteristic	OK NG	
04	Frequency Characteristic	OK NG	
05	Heart Rhythm Detection	OK NG	
06	ECG Sensitivity	OK NG	
07	Heart Rate Accuracy	OK NG	
08	ECG Lead Switch	OK NG	
09	Lead-Off indication	OK NG	
10	ECG Lead Cable Recognition	OK NG	

No.	Check Item	Judge	Check
5 Respiration			
01	Respiration Waveform Sensitivity	OK NG	
02	RR Accuracy	OK NG	
03	Frequency Characteristic	OK NG	
6 Speaker			
01	Synchronized Tone	OK NG	

No.	Check Item	Judge	Check
7 Electrical Safety			
01	From the patient connecting part to the ground NC ()mA	OK NG	
02	Patient leakage current that runs through the ground from the patient connecting part NC ()mA	OK NG	
03	Leakage current when external voltage is applied to the patient connection in the Type F attaching part. SFC ()mA	OK NG	
04	Total patient leakage current that runs through the ground from the total patient connecting part. NC ()mA	OK NG	
05	Leakage current when external voltage is applied to the patient connection in the Type F attaching part. SFC ()mA	OK NG	
06	Patient auxiliary current NC ()mA	OK NG	
07	Withstand Voltage Test	OK NG	

Description			
✓	Check	A	Adjustment
x	Replacement part	C	Cleaning
/	Not covered	R	Repair

The check result is as follows:
Normal Operation Malfunctioning. Needs to be repaired.
 (Details of malfunction and repair)

Company
 Inspector
 Person in charge

Replacement parts

Classification
On-site Taking-over
Holiday Night

■ Repairing the Equipment

This equipment is basically repaired at Fukuda Denshi factory.
If detailed information about the repair is needed, contact Fukuda Denshi.

On-site repair is possible for the following parts.

- Replacing the battery compartment Lid Unit

⚠ CAUTION

Make sure to replace the parts correctly. Otherwise, it may cause damage and heat generation of the equipment.

■ Replacing the Battery Compartment Lid Unit

● Life of the Battery Compartment Lid Unit

Life of the waterproof battery compartment lid unit is one year. If this unit is used for more than a year, the waterproof (IPX8) performance cannot be guaranteed. Replace the battery compartment lid unit to maintain its waterproof performance.

Battery Compartment Lid Unit

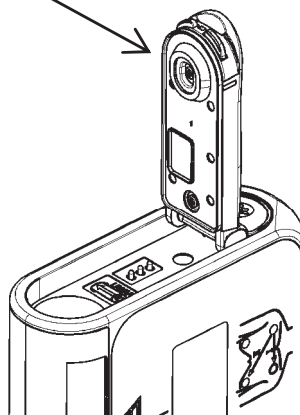

⚠ CAUTION

- The battery unit must be replaced at specified period.
- Even if the LX-8100 is used less than one (1) year, the unit may be damaged from high impact. If the LX-8100 is dropped or is subjected to a high impact, make sure that the unit is not damaged.

12. Maintenance and Inspection

● Tools

- Phillips screwdriver (#0)

● Assembly and Disassembly

Follow the procedure below to remove the battery compartment lid unit.

1. Remove the label.

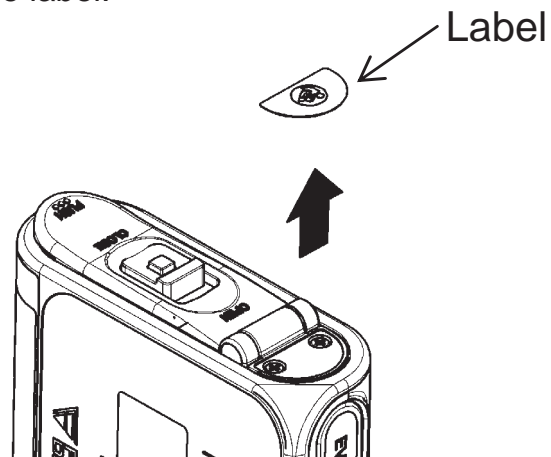

2. Remove the 2 installation screws then remove the battery compartment lid unit.

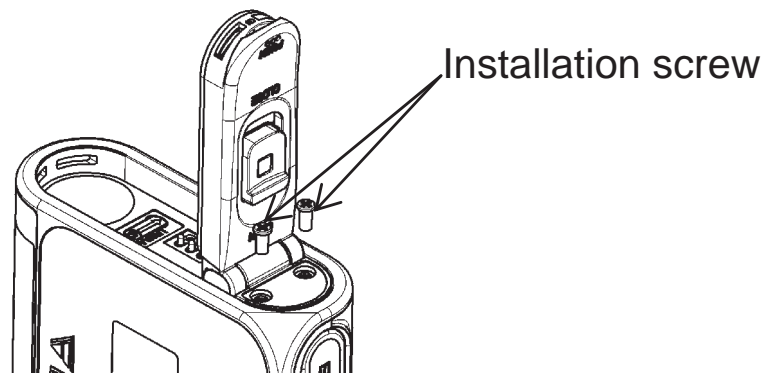

Follow the procedure below to attach the battery compartment lid unit.

1. Set the battery compartment lid unit adjusting to the front case.

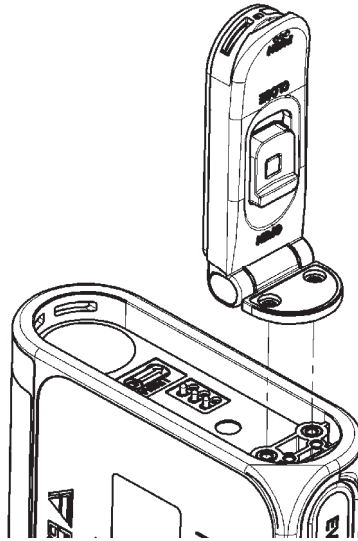

2. Secure the battery compartment lid unit with new 2 installation screws. Make sure that the screws are securely tightened.

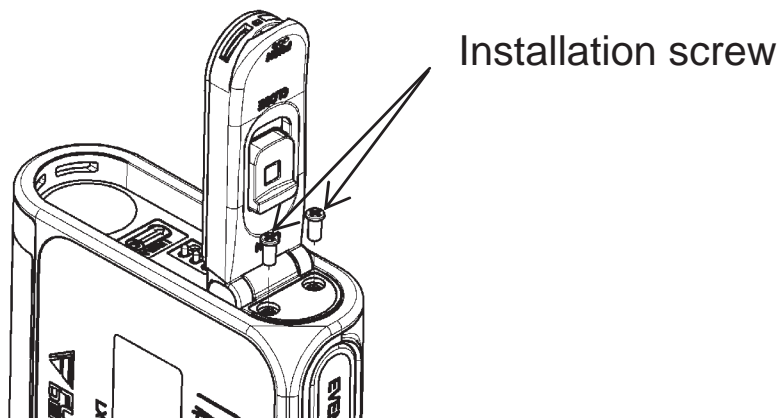

12. Maintenance and Inspection

3. Make sure that the battery compartment lid unit opens/closes smoothly.

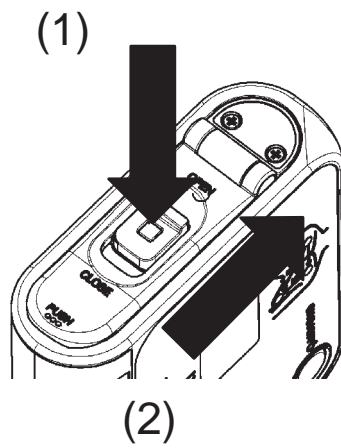

4. Attach the label firmly aligning with the groove of the battery compartment lid unit.

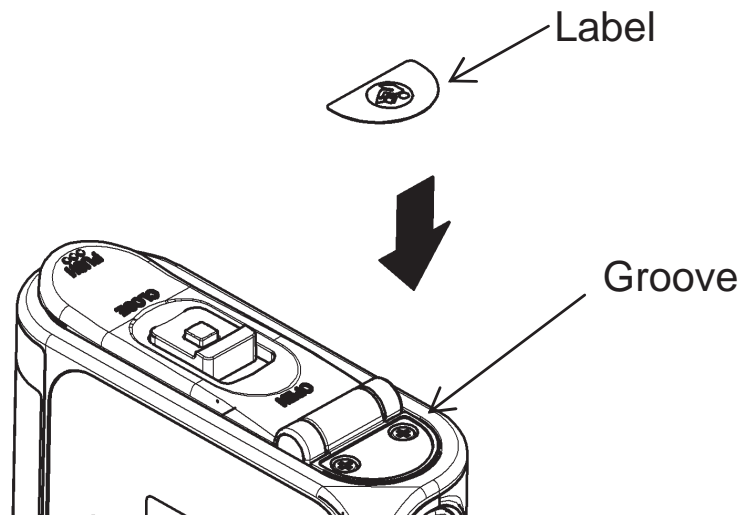

13 . Standard and Optional Accessories

⚠ WARNING

Use only the accessories specified by Fukuda Denshi for the LX-8100. Otherwise, the LX-8100 cannot deliver its maximum performance and may be damaged, resulting in a safety hazard.

⚠ CAUTION

For quality improvement, specifications are subject to change without prior notice.

■ Standard Accessories

No.	Item	Model Type	Q'ty	Remarks
1	Neck Strap	OAT-03A	1	
2	4-electrode ECG lead cable	CMT-02HTH-0.8DA	1	AHA color code, Hook Type, Limb Lead (2CH)
3	Disposable portable case	ABT-810D	1	
4	Operation Manual		1	

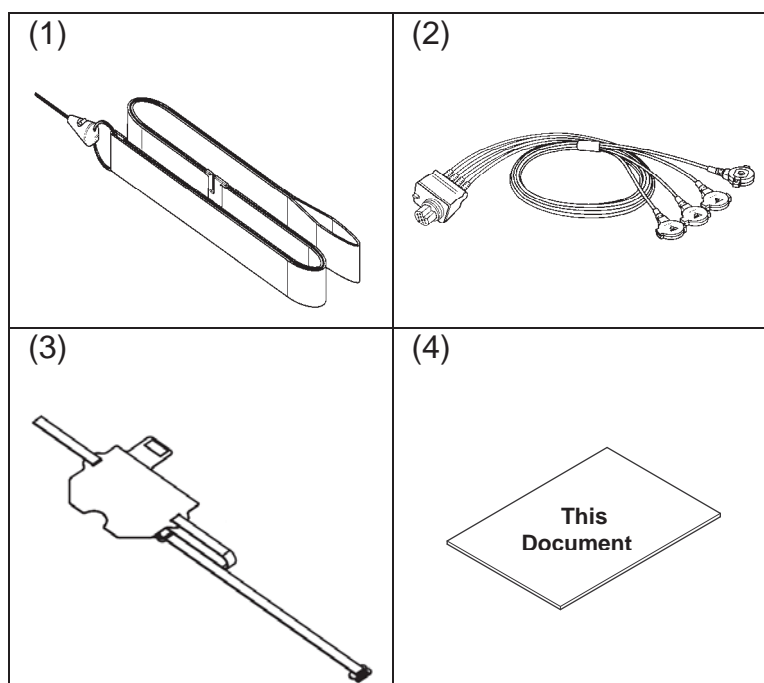

13. Standard and Optional Accessories

■ Optional Accessories

The following optional accessories are available for the LX-8100.
Purchase them as required.

● LX-8100

Lead cables

Item	Model Type	Remarks
ECG Clip Type Lead Cable	CMT-01CTH-0.8DA	3-electrode (White, Black, Red)
ECG Clip Type Lead Cable	CMT-02CTH-0.8DA	4-electrode (White, Black, Green, Red)
ECG Clip Type Lead Cable	CMT-03CTH-0.8DA	5-electrode (Chest) (White, Black, Green, Red, Brown)
ECG Hook Type Lead Cable	CMT-01HTH-0.8DA	3-electrode (White, Black, Red)
ECG Hook Type Lead Cable	CMT-02HTH-0.8DA	4-electrode (White, Black, Green, Red)
ECG Hook Type Lead Cable	CMT-03HTH-0.8DA	5-electrode (Chest) (White, Black, Green, Red, Brown)

Pochette

Item	Model Type	Remarks
Disposable Portable Case	ABT-810D	5 pieces /pack

14. Specification

■ Specification

⚠ CAUTION

For quality improvement, specifications are subject to change without prior notice.

Standard Specification

Size:	72.0(W) mm x 67.0(H) mm x 23.4(D) mm (not including the protrusion)
Weight:	Approximately 100 grams (with battery)
Transmitting Waveform:	ECG 1CH or 2CH (selectable from the ECG lead cables), Respiration waveform.
ECG Lead cable Type:	3-electrode, 4-electrode, or 5-electrode (Limb+Chest) lead cable. Automatically detect the type by inserting the lead cable.
Transmitting Status Data:	Electrode Off, Low Battery, Event Switch, Pacemaker
OLED:	Built-in
Waterproof:	IPX8 (If periodic replacements are performed) / IPX5 IPX5: Protection from water. IPX8: Protection from submerge
Power Supply:	DC: One "AA" size ("LR6" size) alkaline battery.
Continuous Operating Time:	"AA" size ("LR6" size) alkaline battery Approximately 6 days with MX1500 (DURACELL) Conditions: ECG measurement, RESP measurement, Set as Initial setting, operating temperature 23°C
Operation mode:	Continuous operation
*Continuous operating time is assumed when using a new "AA" size ("LR6"size) Alkaline battery specified by Fukuda Denshi.	

14. Specification

ECG

Particular Standard:	IEC 60601-2-27:2011 (Medical electrical equipment - Part 2-27: Particular requirements for the basic safety and essential performance of electrocardiographic monitoring equipment) *Suitable when using DS-8900 System (Central Monitor) and LW-7080(Central Telemetry Receiver).
Numbers of Lead Electrode:	3-electrode, 4-electrode, or 5-electrode (Limb+Chest) lead cable
Numbers of Input Channel:	1CH (3-electrode) or 2CH
Accuracy of Sensitivity:	Complies with IEC 60601-2-27:2011 and 201.12.1.101.1 ($\pm 20\%$ or 100 μ V, whichever is greater.)
ECG Input Impedance:	Complies with IEC 60601-2-27:2011 and 201.12.1.101.3 (2.5M Ω and above)
Input dynamic range and Offset voltage:	Complies with IEC 60601-2-27:2011 and 201.12.1.101.2 (Input dynamic range: ± 5 mV Offset voltage: ± 300 mV Change of amplitude caused by offset voltage: Within $\pm 10\%$)
Common Mode Rejection Ratio:	Complies with IEC 60601-2-27:2011 and 201.12.1.101.10 (Less than 1mVp-p (RTI))
HR measurement detection:	Complies with IEC 60601-2-27:2011 and 201.12.1.101.15 (HR Measurement Accuracy: Less than $\pm 10\%$ or ± 5 bpm, whichever is greater HR measurement range and accuracy are as follows.
HR Display Range:	HR measurement range: 0, 12 bpm to 300 bpm) QRS Detection Wide 0, 12 bpm to 300 bpm (1bpm increment) QRS Detection Narrow 0, 30 bpm to 300 bpm (1 bpm increment)
Frequency Characteristic:	0.5 Hz to 40 Hz (within -3dB)
Time Constant:	0.4 sec $\pm 25\%$ Switching and available to set 0.1 sec $\pm 25\%$
Rejection of Pacemaker Pulse:	a) Pacemaker Pulse without Over/Undershoot Capable to reject pulses of pulse width 0.1 ms to 2 ms, amplitude ± 2 mV to ± 700 mV b) Pacemaker Pulse with Over/Undershoot Rejection is not possible.
Protection to Defibrillation:	Meets the requirement of IEC 60601-2-27

Lead-off Detection Current:	100 nA and below
Tall T-wave Rejection Capability:	1.2 mV T-wave can be removed when tested according to IEC 60601-2-27
Average of Heart Rate:	HR measured from 6 seconds of heartbeat for setting QRS width: wide, and 4 seconds of heartbeat for setting QRS width: narrow.
Response time of heart rate meter to change in heart rate:	HR change from 80 bpm to 120 bpm: Range 6 sec. to 8 sec., Average 7 sec. HR change from 80 bpm to 40 bpm: Range 6 sec. to 8 sec., Average 7 sec.
Sweep speed	9.0 mm/s

Heart rate meter accuracy and response to irregular rhythm:

80 bpm Ventricular Bigeminy: 80 bpm



60 bpm Ventricular Bigeminy: 60 bpm



120 bpm Ventricular Bigeminy: 120 bpm



90 bpm Bidirectional Systoles: 90 bpm



14. Specification

Respiration (Impedance Method)

Accuracy of Sensitivity:	10 mm/1 Ω \pm 2 mm (When standard Impedance is 480 Ω .)
Resp. Display Range:	0, 4 Bpm to 150 Bpm
Display Error of Respiration Rate:	\pm 3 Bpm
Measured Current of Respiration:	Below 100 μ A (42kHz)

Transmission Method

Modulation Mode:	Digital, Frequency shift keying
Frequency:	608 MHz to 614 MHz
Oscillation Method:	PLL Synthesizer method by crystal control
Channel Spacing:	12.5 kHz
Occupied Frequency Bandwidth:	Within 8.5 kHz
RF Output Power:	1 mW \pm 2 dB
Transmitting Antenna:	Dielectric Antenna

Safety

General Standard:	AAMI / ANSI ES 60601-1:2005(R)2012 and A1:2012, C1:2009(r)2012 and A2:2010(r)2012 (Medical electrical equipment - Part 1: General requirements for basic safety and essential performance)
EMC Standard:	IEC 60601-1-2: 2014 (Medical electrical equipment – Part 1-2: General requirements for basic safety and essential performance – Collateral standard: Electromagnetic disturbances – Requirements and tests)
The class of protection against electric shock:	Internally Powered Equipment
The type of protection against electric shock:	Type CF Applied Part

Operating Environment



Temperature:	10 $^{\circ}$ C to 40 $^{\circ}$ C
Humidity:	30% RH to 85% RH (non-condensing)
Atmospheric Pressure:	70 kPa to 106 kPa

Transport / Storage Environment

Temperature:	-10 $^{\circ}$ C to 60 $^{\circ}$ C
Humidity:	10% RH to 95% RH (non-condensing)
Atmospheric Pressure:	70 kPa to 106 kPa

■ Displays

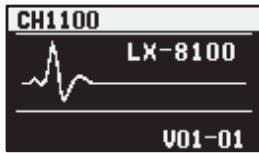
The following displays are shown on the display of the LX-8100.

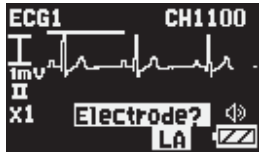
	Display	Description
Starting Screen		Displayed after turning on the power. Automatically moves onto the channel display screen.
Channel Display Screen		Displays the transmitter channel after turning on the power and also when refreshing the screen. Automatically moves onto the waveform display screen.
Event		Displayed when the EVENT button is pressed.
Electrode?		Displayed when the ECG electrode is disconnected or the ECG/RESP waveform cannot be measured normally. For details about electrode check message, refer to “14. Specification ■ Details of the “Electrode” Message”.

14. Specification

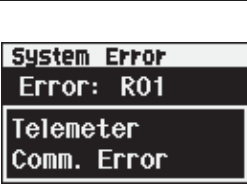
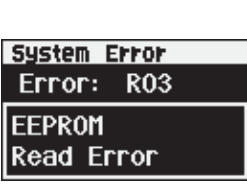
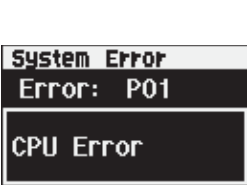
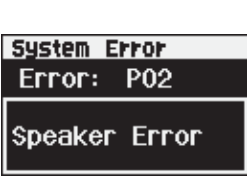
	Display	Description
Error Message: If messages are not cleared, contact your local Fukuda Denshi service representative.		
Telemeter Error		Displayed when the transmitter is faulty
EEPROM Error		Displayed when the EEPROM is faulty
CPU Error		Displayed when the CPU is faulty
Speaker Error		Displayed when the speaker is faulty.

■ Details of the “Electrode” Message

The following “Electrode?” messages are displayed on the display depending on the selected lead cable and lead.

Check Position	3-electrode lead cable Lead I display	3-electrode lead cable Lead II display	3-electrode lead cable Lead III display
LL	Electrode? LL	Electrode? LL	Electrode? LL
RA	Electrode? RA	Electrode? RA	Electrode?
LA	Electrode? LA	Electrode?	Electrode? LA
Several Position Simultaneously	Electrode?	Electrode?	Electrode?

Check Position	4-electrode lead cable	5-electrode (Chest) lead cable
LL	Electrode? LL	Electrode? LL
RA	Electrode? RA	Electrode? RA
LA	Electrode? LA	Electrode? LA
RL	Electrode?	Electrode?
V		Electrode? V
ECG1+		
ECG1-		
ECG2+		
ECG2-		
Several Position Simultaneously	Electrode?	Electrode?

■ List of Setup Items

Followings are the items that can be set up in the LX-8100.

Items	Selection	Default	Backup
ECG Lead	I, II, III	II	○
Display Size of ECG (1)	×1, ×1/2	×1	○
Display Size of ECG (2)	×1, ×1/2	×1	○
Display Size of Respiration Waveform	×1, ×1/2	×1	○
Synchronized Tone	ON, OFF	OFF	×

Items	Selection	Default	Backup
Time Constant	0.4 sec, 0.1 sec	0.4 sec	○
Detection Sensitivity of Pacemaker Pulse (Pace Sens.)	Low, Mid, High	Mid	○
QRS Detection (QRS Width)	Wide, Narrow	Wide	○
Respiration Detection Signal (DISPLAY)	ON, OFF	ON	○
Display Brightness (Brightness)	8 levels	5	○
Turn Off Display Time (Display OFF)	1 min, 3 min, 10 min, OFF	3 min	○
Sound (Sound)	ON, OFF	ON	○
Transmitter Channel (CH)	One from the following channels. 0801 to 0879 0900 to 0979 1000 to 1079 1100 to 1179 1200 to 1279 1300 to 1379	1100	○
Group ID	One from 00 to 63	00	○

eneloop is a trademark of Panasonic Group.

Other company and product names used in this manual are trademarks or registered trademarks of respective companies.

FUKUDA DENSHI CO.,LTD.

3-39-4 Hongo, Bunkyo-ku, Tokyo, Japan

Tel: +81-3-5684-1455 Fax: +81-3-3814-1222

<http://www.fukuda.com>

Printed in Japan 4L0114970 201710