

# FURUNO

## OPERATOR'S MANUAL

UAIS TRANSPONDER

---

MODEL FA-100

---



**FURUNO ELECTRIC CO., LTD.**  
NISHINOMIYA, JAPAN

© **FURUNO ELECTRIC CO., LTD.**

9-52 Ashihara-cho,  
Nishinomiya, Japan

Telephone : 0798-65-2111

Telefax : 0798-65-4200

Your Local Agent/Dealer

All rights reserved.

Printed in Japan

PUB.No. OME-44170

( DAMI ) FA-100

FIRST EDITION : SEP. 2002

B : SEP. 25,2002



\* 0 0 0 8 0 9 3 2 3 0 0 \*



\* O M E 4 4 1 7 0 B 0 0 \*



# SAFETY INSTRUCTIONS



## WARNING



### ELECTRICAL SHOCK HAZARD Do not open the equipment.

Only qualified personnel should work inside the equipment.

**Immediately turn off the power at the switchboard if water leaks into the equipment or something is dropped in the equipment.**

Continued use of the equipment can cause fire or electrical shock. Contact a FURUNO agent for service.

**Do not disassemble or modify the equipment.**

Fire, electrical shock or serious injury can result.

**Do not place liquid-filled containers on the top of the equipment.**

Fire or electrical shock can result if a liquid spills into the equipment.

**Immediately turn off the power at the switchboard if the equipment is emitting smoke or fire.**

Continued use of the equipment can cause fire or electrical shock. Contact a FURUNO agent for service.

**Make sure no rain or water splash leaks into the equipment.**

Fire or electrical shock can result if water leaks in the equipment.

**Do not operate the equipment with wet hands.**

Electrical shock can result.

### WARNING LABEL

A warning label is attached to the AC-DC power supply. Do not remove the label. If the label is missing or damaged, contact a FURUNO agent or dealer about replacement.

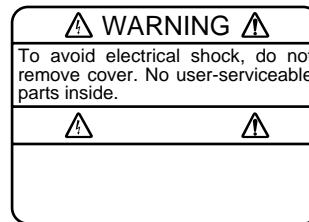

Name: Warning Label (1)  
Type: 86-003-1011-1  
Code No.: 100-236-231

# TABLE OF CONTENTS

---

<b>FOREWORD</b> .....	<b>iii</b>
<b>SYSTEM CONFIGURATION</b> .....	<b>v</b>
<b>PROGRAM NUMBER</b> .....	<b>vi</b>
<b>SYSTEM OVERVIEW</b> .....	<b>vii</b>
<b>1 OPERATION</b> .....	<b>1</b>
1.1 Description of Controls .....	1
1.2 Turning On and Off .....	2
1.3 Adjusting Display Brilliance and Contrast .....	3
1.4 Menu Overview .....	4
1.4.1 Menu operating procedure .....	4
1.4.2 Remarks on menu operation .....	5
1.5 Setting Up for a Voyage.....	7
1.6 Setting CPA/TCPA .....	10
1.7 Plotter Display.....	11
1.8 Target Data Display .....	12
1.8.1 Normal target data.....	12
1.8.2 Finding dangerous ship's data..	14
1.9 Own Ship's Information.....	15
1.9.1 Own static data.....	15
1.9.2 Own dynamic data.....	17
1.10 Messages.....	18
1.10.1 Sending a message.....	18
1.10.2 Receiving messages .....	18
1.10.3 Message logs .....	20
1.11 Regional Operating Channels .....	22
1.11.1 Viewing channels, Tx power.....	22
1.11.2 Displaying, editing regional operating area status .....	23
1.12 Enabling/Disabling the Buzzer.....	25
1.13 Long Range Mode .....	26

<b>2 MAINTENANCE, TROUBLESHOOTING</b> .....	<b>27</b>
2.1 Maintenance.....	27
2.2 Resetting the Breaker .....	28
2.3 Replacement of Battery.....	28
2.4 Troubleshooting.....	29
2.5 Diagnostics.....	30
2.5.1 Displaying program number.....	30
2.5.2 Memory test .....	31
2.5.3 Keyboard test.....	31
2.5.4 LCD test .....	32
2.5.5 On/off history.....	32
2.5.6 GPS test.....	33
2.6 Alarm Status .....	34
2.7 Error Messages.....	35
2.8 GPS Monitor.....	36
2.9 Displaying Sensor Status .....	37
2.10 Restoring Default Settings .....	38

<b>APPENDIX</b> .....	<b>AP-1</b>
Menu Tree .....	AP-1
Parts List.....	AP-3
Parts Location.....	AP-4
Digital Interface (IEC 61162-2) .....	AP-7

<b>SPECIFICATIONS</b> .....	<b>SP-1</b>
-----------------------------	-------------

<b>INDEX</b> .....	<b>IN-1</b>
--------------------	-------------

**Declaration of conformity**

# FOREWORD

---

## A Word to the Owner of the FA-100

FURUNO Electric Company thanks you for purchasing the FA-100 UAIS Transponder. We are confident you will discover why the FURUNO name has become synonymous with quality and reliability.

For over 50 years FURUNO Electric Company has enjoyed an enviable reputation for quality and reliability throughout the world. This dedication to excellence is furthered by our extensive global network of agents and dealers.

Your equipment is designed and constructed to meet the rigorous demands of the marine environment. However, no machine can perform its intended function unless properly operated and maintained. Please carefully read and follow the operation and maintenance procedures set forth in this manual.

We would appreciate feedback from you, the end-user, about whether we are achieving our purposes.

Thank you for considering and purchasing FURUNO.

**Note:** *The example screens shown in this manual may not match the screens you see on your display. The screen you see depends on your system configuration and equipment settings.*

## Features

The FA-100 is a universal shipborne AIS (Automatic Identification System) capable of exchanging navigation and ship data between own ship and other ships or coastal stations. It complies with IMO MSC.74(69) Annex 3, A.694, ITU-R M.1371-1 and DSC ITU-R M.825. It also complies with IEC 61993-2 (Type testing standard), IEC 60945 (EMC and environmental conditions).

The FA-100 consists of VHF/GPS antennas, a transponder unit and several associated units. The transponder contains a VHF transmitter, two TDMA receivers on two parallel VHF channels, a DSC channel 70 receiver, interface, communication processor, LCD display, and internal GPS receiver. The internal GPS is a 12-channel all-in-view receiver with a differential capability, and provides UTC reference for system synchronization to eliminate clash among multiple users. It also gives position, COG and SOG when the external GPS fails.

The LCD panel displays all required information about static data, dynamic data, voyage-related data and short safety-related messages. The information and messages are automatically updated according to the ITU-R M.1371-1, e.g., static information every 6 min and on request, dynamic information every 10 s on ship faster than 3 kt and 3.3 s when changing course at 0-14 kt, etc.

The main features are

- Safety of navigation by automatically exchanging navigational data between ships and between ship and coast.
- Static data:
  - MMSI (Maritime Mobile Service Identity)
  - IMO number (where available)
  - Call sign & name
  - Length and beam
  - Type of ship
  - Location of position-fixing antenna on the ship
- Dynamic data:
  - Ship's position with accuracy indication and integrity status
  - UTC
  - Course over ground (COG)
  - Speed over ground (SOG)
  - Heading
  - Navigation status (manual input)
  - Rate of turn (where available)
- Voyage-related data
  - Ship's draught
  - Hazardous cargo (type)
  - Destination and ETA (at master's discretion)
- Short safety-related messages, Free messages
- LCD panel satisfying the IMO minimum requirements plus simple plotting modes
- Interfaces for radar, ECDIS, PC, LAN for future networking expansion
- GPS/VHF combined antenna for easy installation available
- CPA/TCPA alarm
- Built-in GPS receiver for UTC synchronization and backup position fixing

# SYSTEM CONFIGURATION

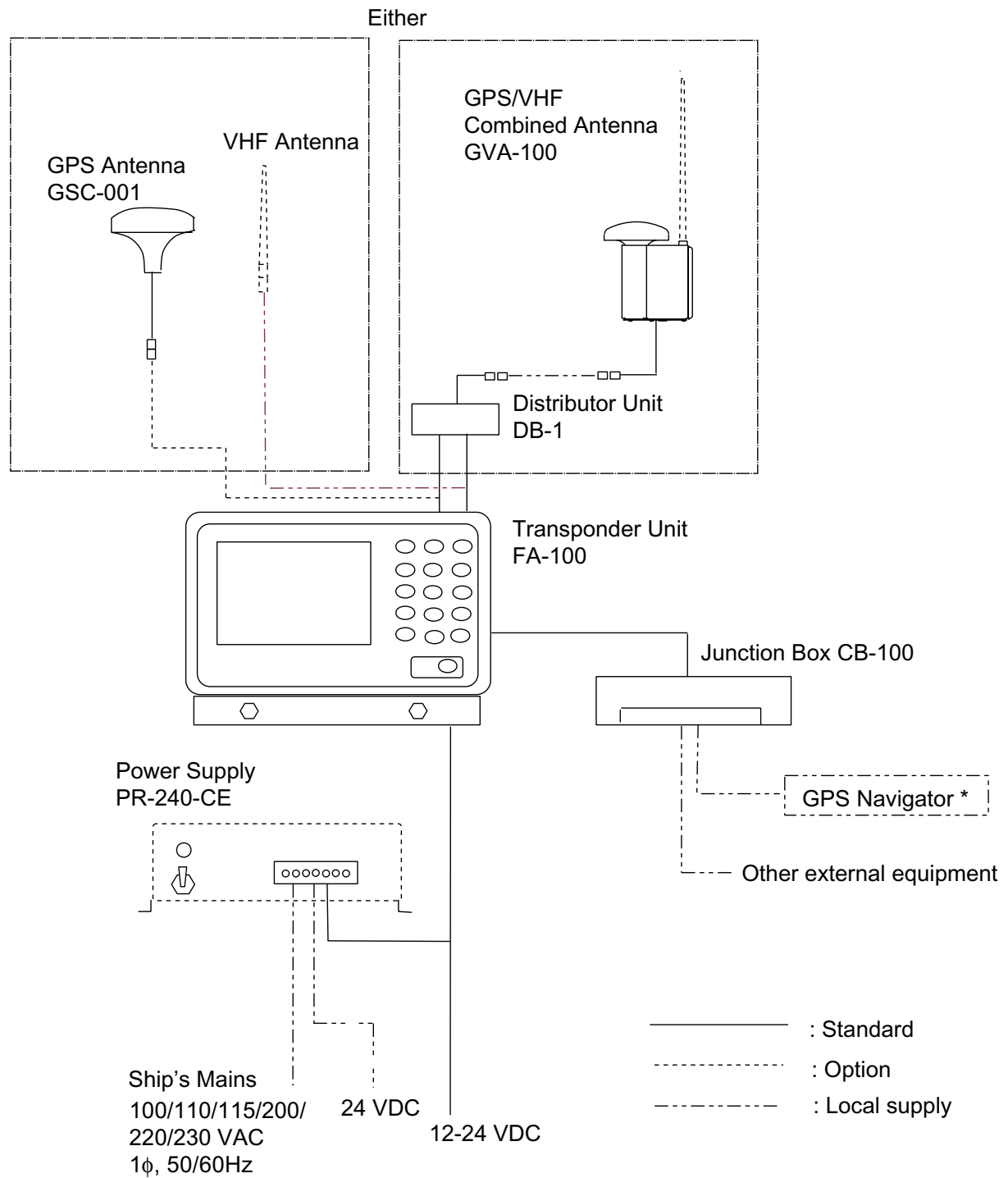

# PROGRAM NUMBER

---

PCB	Version No.	Date	Reason for Modification
MAIN	245-0001-001	09/2002	
SUB	245-0002-001	09/2002	
H8S1	245-0003-001	09/2002	
H8S2	245-0004-001	09/2002	
H8S3	245-0005-001	09/2002	



# SYSTEM OVERVIEW

## System overview

The Automatic Identification System (AIS) was originally developed to aid the Vessel Traffic Services (VTS) by use of a VHF transponder working on Digital Selective Call (DSC) at VHF CH70, and is still in use along the UK coastal areas and others. Some time later the IMO developed a Universal AIS using the new sophisticated technology called Self-Organized Time Division Multiple Access (SOTDMA) based on a VHF Data Link (VDL).

The system operates in three modes – autonomous (continuous operation in all areas), assigned (data transmission interval remotely controlled by authority in traffic monitoring service) and polled (in response to interrogation from a ship or authority). It is synchronized with GPS time to avoid conflict among multiple users (IMO minimum 2000 reports per minute and IEC requires 4500 reports on two channels). The VHF channels 87B and 88B are commonly used and in addition there are local AIS frequencies. Shipborne AIS transponders exchange various data as specified by the IMO and ITU on either frequency automatically set up by the frequency management telecommand received by the DSC receiver on ship. VHF transmit power is also set up for 12.5 W or 2 W automatically.

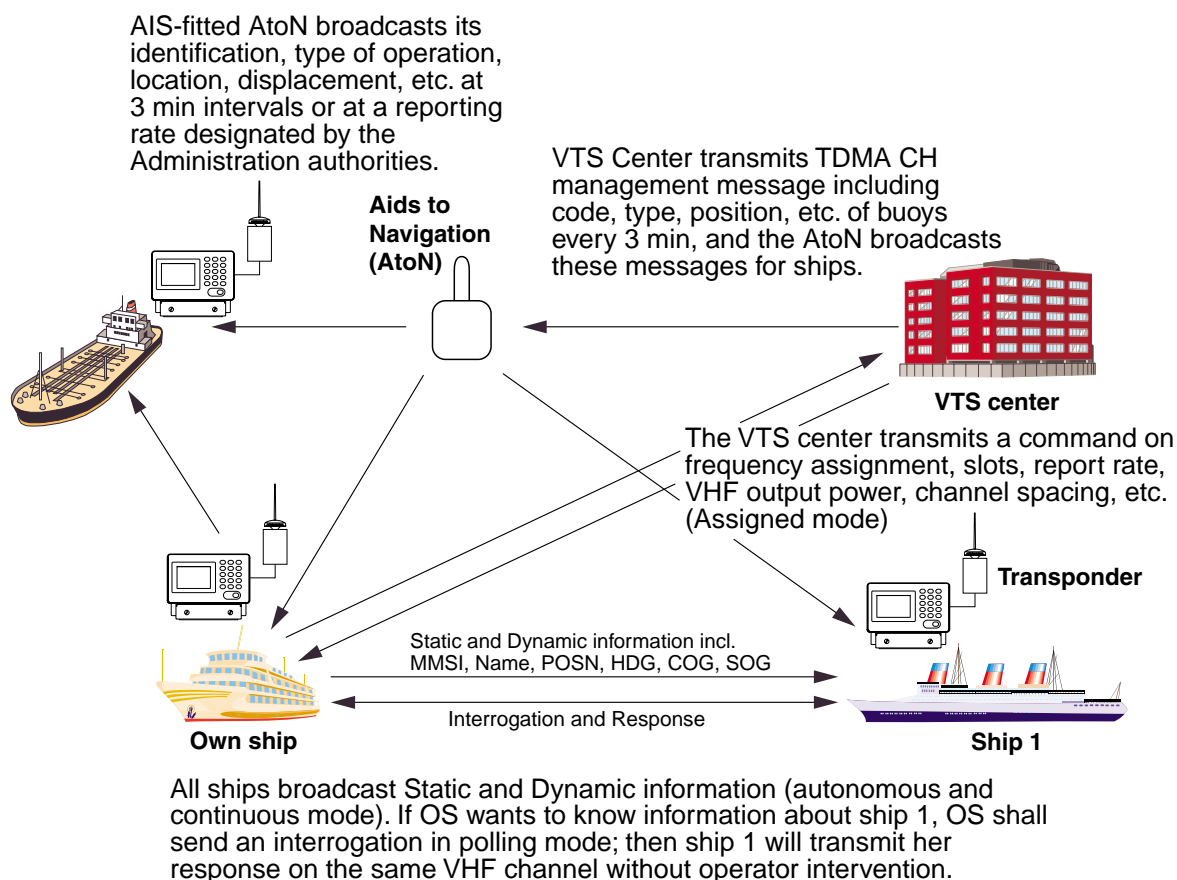

AIS system

## **Not all ships carry AIS**

The Officer of the Watch (OOW) should always be aware that other ships, and in particular leisure craft, fishing boats and warships, and some coastal shore stations including Vessel Traffic Service centers might not be fitted with AIS.

The OOW should also be aware that AIS fitted on other ships as a mandatory carriage requirement might be switched off by professional judgment of the master. Thus, users are therefore cautioned to always bear in mind that information provided by AIS may not be giving a complete or correct “picture” of shipping traffic in their vicinity.

## **Use of AIS in collision avoidance**

As an anti-collision aid the AIS has the following advantages over radar:

- Information provided in near real-time
- Capable of instant presentation of target course alterations
- Not subject to target swap
- Not subject to target loss in clutter
- Not subject to target loss due to fast maneuvers
- Able to detect ships within VHF/FM coverage, including in some circumstances, around bends and behind islands.

When using the AIS for anti-collision purposes it is important to remember that the AIS is an additional source of navigation information. It does not replace other navigational systems. Once again, remember that the AIS may not be giving a complete or correct “picture” of shipping traffic in their vicinity.

The use of the AIS does not negate the responsibility of the OOW to comply with all collision regulation requirements, especially the maintaining of a proper look-out. The prudent navigator uses all aids available to navigate the ship.

## **Erroneous information**

Erroneous information implies a risk to other ships as well as your own. Poorly configured or calibrated sensors might lead to incorrect information being transmitted. It is the user’s responsibility to ensure that all information entered into the system is correct and up to date.

# 1 OPERATION

## 1.1 Description of Controls

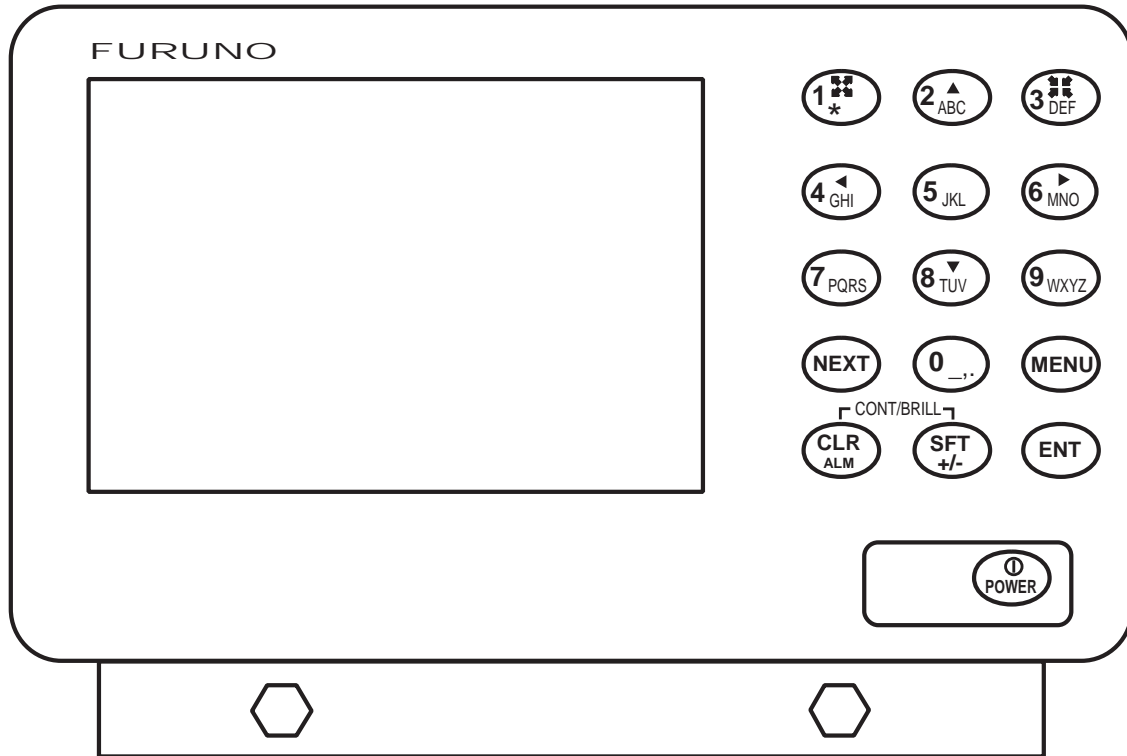

*FA-100 Transponder unit*

### Description of controls

Control	Description
0 - 9	Alphanumeric, symbol input keys
2(▲) and 8(▼)	Adjust display brilliance and keyboard backlighting; scroll display.
4(◀) and 6(▶)	Shift the cursor left and right (pressed with [SFT/ +/-]), respectively; adjust contrast.
CLR/ALM	Clears an entry; silences the audio alarm.
SFT/ +/-	Selects numeric or alphabet entry mode alternately; selects options on menus.
CLR/ALM + SFT/ +/-	Change the contrast and brilliance.
ENT	Concludes an entry.
NEXT	Chooses next line. Press together with [SFT/ +/-] to shift cursor in reverse direction.
MENU	Displays menu. Also used to perform "escape".
POWER	Turns the power on and off.

## 1.2 Turning On and Off

Press the [POWER] key to turn the equipment on and off. The startup screen appears. Showing FURUNO logo along with the date and time of last power-off.

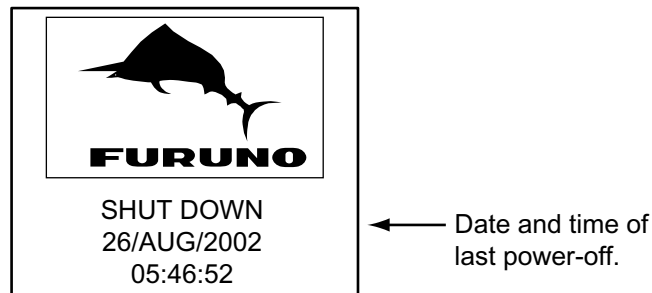

*Startup screen*

After the FURUNO logo disappears, the screen displays “NOW STARTING...CHECKING MEMORY. At this time the BIIT (built-in integrity test facility) checks the major circuits including RAM, ROM, interface, etc. The plotter display appears, showing the message “NOW SORTING.” This means the equipment is sorting targets by distance, from closest to furthest. This takes several seconds to complete.

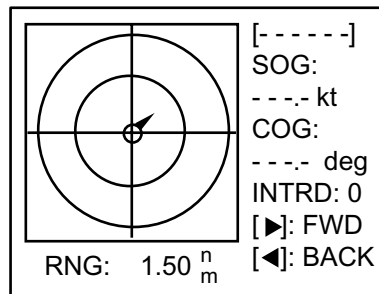

"Please Wait!" is shown when no data is being received.

*PLOTTER display*

The FA-100 should be powered while underway or at anchor. The master may switch off the AIS if he believes that the continual operation of the AIS might compromise the safety or security of his ship. The AIS should be restarted once the source of danger has disappeared.

The equipment transmits own ship static data within two minutes of start-up and it is transmitted at six-minute intervals. Static data includes MMSI number, IMO number, call sign, ship name, ship length and width, ship type and GPS antenna position.

In addition to static data, ship's dynamic data is also transmitted. This data includes position with accuracy, SOG, COG, rate of turn, heading, etc. Dynamic data is transmitted ever 2 s to 3 min depending on ship's speed and course change, voyage-related data, such as ship draft, hazardous cargo, destination and estimated time of arrival, are transmitted at six-minute intervals.

The FA-100 starts receiving data from AIS-equipped ships as soon as it is turned on, and the ships' location on the plotter display is shown with the AIS symbol. (To learn more about the plotter display, see paragraph 1.7.) With connection of a radar or ECDIS, the AIS target symbols may be overlaid on the radar or ECDIS.

**Note 1:** If no navigation sensor is installed or a sensor such as a gyrocompass has failed, the AIS automatically transmits "not available" data.

**Note 2:** The reporting intervals are as follows

*Ship's navigation status and reporting interval*

Ship's navigation status	Reporting interval
Moored	3 min
0-14 kt speed	10 s
0-14 kt speed with course change	3+1/3 s
14-23 kt speed	6 s
14-23 kt speed with course change	2 s
Speed higher than 23 kt	2 s
Speed higher than 23 kt with course change	2 s

## 1.3 Adjusting Display Brilliance and Contrast

1. Press the [CLR/ALM]+[SFT/ +/-] keys together to show the dialog box below.

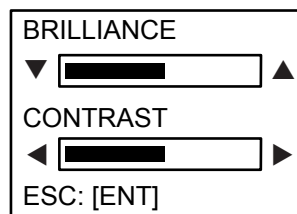

*Dialog box for adjustment of brilliance and contrast*

2. Use the [▲] or [▼] key to adjust brilliance; [◀] or [▶] key to adjust contrast.
3. Press the [ENT] key to close the dialog box.

**Note:** If you turn off the equipment with minimum contrast, the startup screen is displayed in high contrast at the next power-on. However, the plotter display, which appears after the startup screen, will be shown in minimum contrast. Therefore, adjust the contrast as described above.

## 1.4 Menu Overview

You can choose the functionality of the equipment through the menu. If you get lost in operation, press the [MENU] key until you return to the main menu. The complete menu tree is provided in the Appendix.

### 1.4.1 Menu operating procedure

1. Press the [MENU] key to display the main menu.

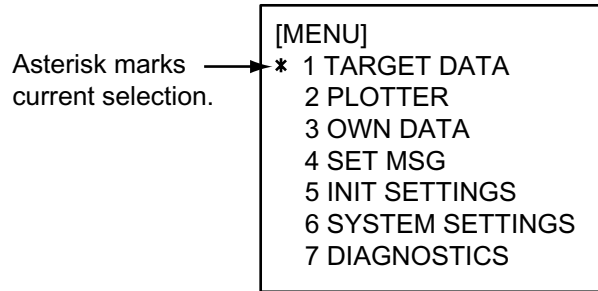

*Main menu*

2. Press appropriate numeric key to choose a wanted sub-menu. For example, press the [6] key to choose the SYSTEM SETTINGS sub-menu. (You may also choose a sub-menu by pressing the [NEXT] key to choose it and then pressing the [ENT] key.)

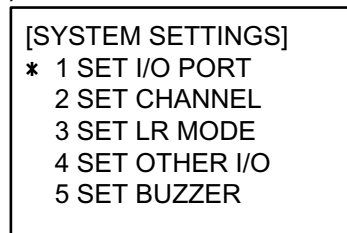

*SYSTEM SETTINGS sub-menu*

3. Press appropriate numeric key to choose sub-menu desired. For example, press the [5] key to show the SET BUZZER sub-menu.

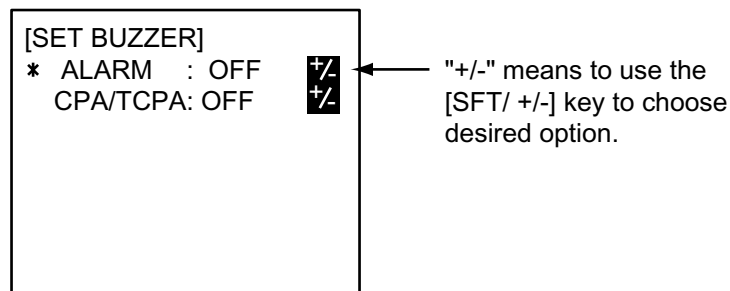

*SET BUZZER sub-menu*

4. Choose item with the [NEXT] key. The asterisk shows current selection.
5. Depending on the sub-menu shown, use the alphanumeric keys to enter data, or use the [SFT/ +/-], [▲], [▼], [◀] or [▶] key to choose data.
6. Press the [ENT] key to register data.
7. Press the [MENU] key several times to return to the main menu.

## 1.4.2 Remarks on menu operation

### Confirming entry

If, after you have changed data, you pressed the [MENU] key without pressing the [ENT] key, the message shown below appears. If you want to cancel the data, press the [ENT] key. If you wish to save, use the [▼] key to choose NO, press the [ENT] key and then press the [ENT] key again.

CANCEL?  * YES NO
----------------------------

*“Are you sure” confirmation dialog*

### Choosing data input mode

To enter a specific numeric, alphabet or symbol, choose the appropriate data input mode, numeric or alphabet. The active data input mode is shown at the bottom left-hand corner of the screen. Use the [SFT/ +/-] key to select desired mode. To enter a numeric, simply press appropriate numeric key. For alphabet or symbol, press appropriate key until desired character or symbol appears.

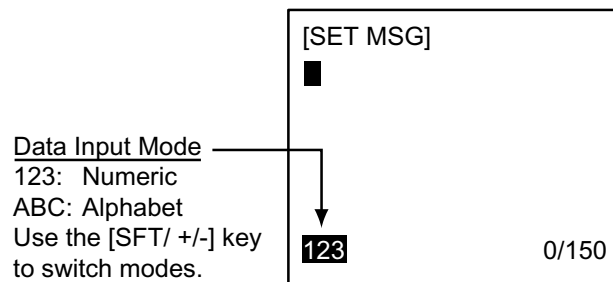

*SET MSG screen*

**Shifting the cursor**

To shift the cursor backward or forward, press [SFT/ +/-] + [◀] together to shift it backward; [SFT/ +/-] + [▶] together to shift it forward. This is convenient for creating a space or using the same key consecutively.

**Multiple page sub-menus**

Some sub-menus have more than one page. In this case, an arrow(s) appears at the top of the display to show which arrow key(s) to press to change the page.

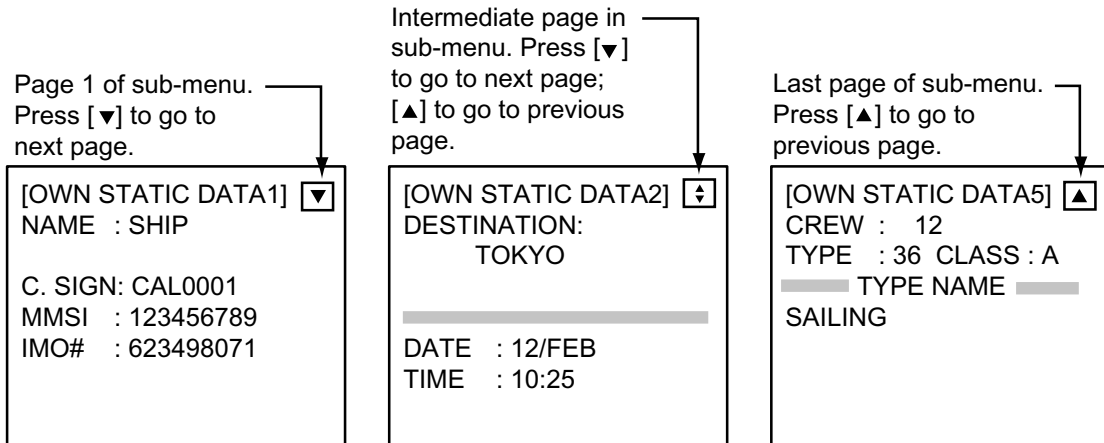

*OWN STATIC DATA displays 1, 2 and 5*

**Choosing options**

Menu options may be chosen with the [▲], [▼], [◀] or [▶] key or [SFT/ +/-] key depending on the sub-menu. In the examples below, you may choose NAV STATUS option with the [▲], [▼], [◀] or [▶] key and ALARM option with the [SFT/ +/-] key.

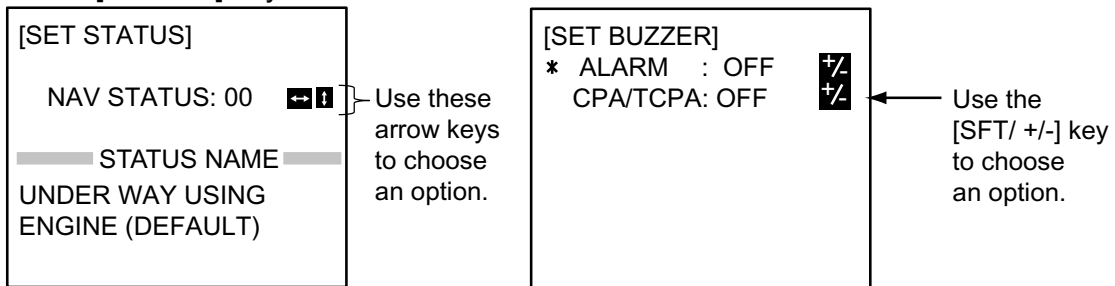

*SET STATUS sub-menu*

**Saving settings**

When the [MENU] key is pressed after changing an option (to register setting), you are asked if you want to save the setting. To save the setting, press the [ENT] key. To retain the previous setting, select NO and press the [ENT] key. To escape, choose [CANCEL] and press the [ENT] key.

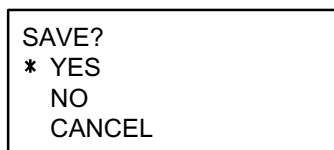

*Save confirmation dialog*



## 1.5 Setting Up for a Voyage

There are five items on the INIT SETTINGS menu (Menu #5) you will need to enter at the start of a voyage: draught, destination, navigation status, ship type and number of crew.

1. Press the [MENU] key to open the main menu.
2. Press the [5] key to open the INIT SETTINGS menu.

```
[INIT SETTINGS]
* 1 SET SHIP DATA
  2 SET DESTINATION
  3 SET NAV STATUS
  4 SET TYPE&CREW
  5 SET CPA/TCPA
  6 SET ANTENNA POS
```

*INIT SETTING sub-menu*

3. Press the [1] key to choose SET SHIP DATA. The ship's name and call sign have been entered at installation. Confirm that they are correct.

```
[SET SHIP DATA]
* NAME : EURUNO
      C. SIGN : 6LCZ43B
      DRUGHT : 12.3 m
      DTE : DEFAULT 7
123
```

*SET SHIP DATA sub-menu*

4. Press the [NEXT] key to choose DRUGHT (draught).
5. Use the numeric keys to enter ship's current draught for the voyage. (Be sure to amend it if it changes during the voyage.)

**Note:** DTE should not be changed from "DEFAULT."

6. Press the [ENT] key to register data and return to the INIT SETTINGS menu.
7. Press the [2] key to choose SET DESTINATION.

```
[SET DESTINATION]
* DATE: 00/00 (DD/MM)
  TIME: 00:00
  DESTINATION:
  _____
  _____
```

*Dialog box for entry of destination*

8. DATE is selected; enter estimated day and month of arrival at destination and then press the [NEXT] key to choose TIME.
9. Enter estimated time of arrival at destination and then press the [NEXT] key to choose DESTINATION.

10. Enter name of destination and then press the [ENT] key to register data and return to the INIT SETTINGS menu.

**Note:** Be sure to change destination information when it changes.

11. Press the [3] key to choose SET NAV STATUS.

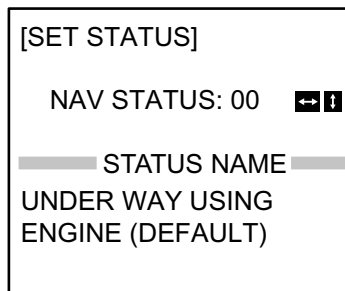

*SET STATUS sub-menu*

12. Use the [▲], [▼], [◀] or [▶] key to choose appropriate navigation status referring to the list below.

[▲], [▼]: Increment, decrement selection number by 1.

[◀], [▶]: Increment, decrement selection number by 10.

- 00: Underway using engine (default)
- 01: At anchor
- 02: Not under command
- 03: Restricted maneuverability
- 04: Constrained by draught
- 05: Moored
- 06: Aground
- 07: Engaged in fishing
- 08: Underway by sailing
- 09: Reserved for high speed craft (HSC)
- 10: Reserved for wing in ground (WIG, for example, hydrofoil)
- 11-15: Reserved for future use

13. Press the [ENT] key to register data and return to the INIT SETTINGS menu.

14. Press the [4] key to choose SET TYPE&CREW.

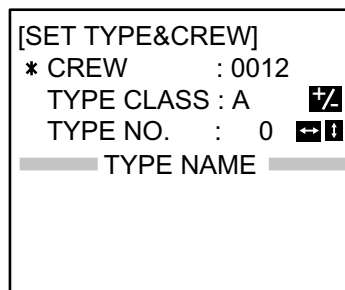

*SET TYPE&CREW sub-menu*

15. CREW is selected; enter number of crew with the numeric keys.

**Note:** TYPE CLASS is entered at installation. Do not change the setting from "A."

16. Press the [NEXT] key to choose TYPE NO.

**Note:** TYPE NO. is entered at installation. However, if the ship carries hazardous cargo, dangerous goods, harmful substances or marine pollutants it should be entered.

17. Use [▲], [▼], [◀], [▶] to choose appropriate type number.

[▲], [▼]: Increment, decrement selection number by 1.

[◀], [▶]: Increment, decrement selection number by 10.

10	FUTURE USE ALL SHIPS OF THIS TYPE	60	PASSENGER SHIPS ALL SHIPS OF THIS TYPE
11	FUTURE USE CARRYING DG, HS, OR, MP(A)	61	PASSENGER SHIPS CARRYING DG, HS, OR, MP(A)
12	FUTURE USE CARRYING DG, HS, OR, MP(B)	62	PASSENGER SHIPS CARRYING DG, HS, OR, MP(B)
13	FUTURE USE CARRYING DG, HS, OR MP(C)	63	PASSENGER SHIPS CARRYING DG, HS, OR MP(C)
14	FUTURE USE CARRYING DG, HS, OR, MP(D)	64	PASSENGER SHIPS CARRYING DG, HS, OR, MP(D)
15	FUTURE USE FUTURE USE	65	PASSENGER SHIPS FUTURE USE
16	FUTURE USE FUTURE USE	66	PASSENGER SHIPS FUTURE USE
17	FUTURE USE FUTURE USE	67	PASSENGER SHIPS FUTURE USE
18	FUTURE USE FUTURE USE	68	PASSENGER SHIPS FUTURE USE
19	FUTURE USE NONE	69	PASSENGER SHIPS NONE
20	WIG ALL SHIPS OF THIS TYPE	70	CARGO SHIP ALL SHIPS OF THIS TYPE
21	WIG CARRYING DG, HS, OR, MP(A)	71	CARGO SHIP CARRYING DG, HS, OR, MP(A)
22	WIG CARRYING DG, HS, OR, MP(B)	72	CARGO SHIP CARRYING DG, HS, OR, MP(B)
23	WIG CARRYING DG, HS, OR MP(C)	73	CARGO SHIP CARRYING DG, HS, OR MP(C)
24	WIG CARRYING DG, HS, OR, MP(D)	74	CARGO SHIP CARRYING DG, HS, OR, MP(D)
25	WIG FUTURE USE	75	CARGO SHIP FUTURE USE
26	WIG FUTURE USE	76	CARGO SHIP FUTURE USE
27	WIG FUTURE USE	77	CARGO SHIP FUTURE USE
28	WIG FUTURE USE	78	CARGO SHIP FUTURE USE
29	WIG NONE	79	CARGO SHIP NONE
30	FISHING	80	TANKER ALL SHIPS OF THIS TYPE
31	TOWING	81	TANKER CARRYING DG, HS, OR, MP(A)
32	LENGTH OF THE TOW EXCEEDS 200M OR BREADTH EXCEEDS 25M	82	TANKER CARRYING DG, HS, OR, MP(B)
33	ENGAGED IN DREDGING OR UNDERWATER OPERATIONS	83	TANKER CARRYING DG, HS, OR MP(C)
34	ENGAGED IN DIVING OPEARATIONS	84	TANKER CARRYING DG, HS, OR, MP(D)
35	ENGAGED IN MILITARY OPEARATIONS	85	TANKER FUTURE USE
36	SAILING	86	TANKER FUTURE USE
37	PLEAURE CRAFT	87	TANKER FUTURE USE
38	FUTURE USE	88	TANKER FUTURE USE
39	FUTURE USE	89	TANKER NONE
40	HSC ALL SHIPS OF THIS TYPE	90	OTHER TYPE OF SHI ALL SHIPS OF THIS TYPE
41	HSC CARRYING DG, HS, OR, MP(A)	91	OTHER TYPE OF SHI CARRYING DG, HS, OR, MP(A)
42	HSC CARRYING DG, HS, OR, MP(B)	92	OTHER TYPE OF SHI CARRYING DG, HS, OR, MP(B)
43	HSC CARRYING DG, HS, OR MP(C)	93	OTHER TYPE OF SHI CARRYING DG, HS, OR MP(C)
44	HSC CARRYING DG, HS, OR, MP(D)	94	OTHER TYPE OF SHI CARRYING DG, HS, OR, MP(D)
45	HSC FUTURE USE	95	OTHER TYPE OF SHI FUTURE USE
46	HSC FUTURE USE	96	OTHER TYPE OF SHI FUTURE USE
47	HSC FUTURE USE	97	OTHER TYPE OF SHI FUTURE USE
48	HSC FUTURE USE	98	OTHER TYPE OF SHI FUTURE USE
49	HSC NONE	99	OTHER TYPE OF SHI NONE
50	PILOT		
51	SEACH AND RESCURE VESSELS		WIG: Wing in ground
52	TUGS		HSC: High speed craft
53	PORT TENDERS		DG: Dangerous goods
54	VESSELS WITH ANTI-POLUUTION FACILITIES OR EQUIPMENT		HS: Harmful substances
55	LAW ENFOREMENT VESSELS		MP: Marine pollutants
56	SPARE-FOR ASSIGNMENTS TO LOCAL VESSELS		0-9: Undefined
57	SPARE-FOR ASSIGNMENTS TO LOCAL VESSELS		
58	MEDICAL TRANSPORTS		
59	SHIPS ACCORDING TO RESOLUTION NO 18		

18. Press the [ENT] key to register settings and return to the INIT SETTINGS menu.

19. Press the [MENU] key. You are asked if you are sure to save settings.

```

SAVE ?
* YES
NO
CANCEL

```

20. Press the [ENT] key to save settings.

## 1.6 Setting CPA/TCPA

Set the CPA (Closest Point of Approach) and TCPA (Time to Closest Point of Approach) of AIS targets for which you want to be alerted to targets close to own ship. When a ship whose CPA and TCPA are lower than set here the audio alarm sounds (if active). (The audio alarm may be activated or deactivated through the menu. See paragraph 1.12.)

1. Press the [MENU] key to open the main menu.
2. Press the [5] key to open the INIT SETTINGS menu.
3. Press the [5] key to choose SET CPA/TCPA.

```

[SET CPA/TCPA]
* CPA:      0.90 nm
TCPA:      01 min
ACTV:      DSBL  +/-

```

*Dialog box for entry of CPA/TCPA*

4. Enter desired CPA (setting range: 0-6.00 nm) with the numeric keys and then press the [NEXT] key to choose TCPA.
5. Enter desired TCPA (setting range: 0-60 min) with the numeric keys and then press the [NEXT] key to choose ACTV.
6. Press the [SFT/ +/-] key to choose ENBL to activate the CPA/TCPA alarm; DSBL to disable it.
7. Press the [ENT] key to return to the INIT SETTINGS menu.
8. Press the [MENU] key. You are asked if you are sure to save settings.

```

SAVE ?
* YES
NO
CANCEL

```

*SAVE confirmation screen*

9. Press the [ENT] key to save settings.

If, when ACTV is set to ENBL, a target whose CPA and TCPA are lower than set here is detected, the message WNG COLLISION appears and the audio alarm sounds (if active). Press the [CLR/ALM] key to erase the message and silence the alarm.

## 1.7 Plotter Display

The plotter display automatically appears at each power on. You may also display it as below. AIS targets are displayed automatically.

A target (target marker is hollow) indicates the presence of a vessel equipped with AIS in a certain location and course. If you desire to know more about a vessel's data, select as in step 4 below.

1. Press the [MENU] key to open the menu.
2. Press the [2] key to show the PLOTTER display.
3. Use the [1] or [3] key to choose the range: [1] key to lower it; [3] key to raise it. The available ranges are (in nm) 0.125, 0.25, 0.5, 0.75, 1.5, 3, 6, 12, and 24.
4. To find a target's data, do the following:
  - a) Use the [◀] or [▶] key to fill a wanted target marker in black; namely, activate the target.
  - b) Press the [SFT/ +/-] key to display SOG/COG and CPA/TCPA alternately.
  - c) Press the [ENT] key to display other data. Use the [▼] or [▲] key to scroll the data. The data is the same as that shown on the TARGET DATA sub-menu. For details, see paragraph 1.8.

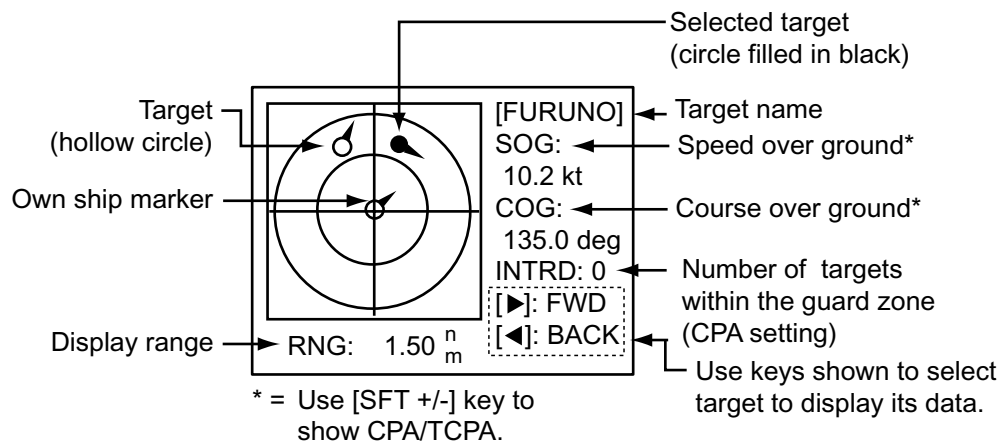

*Plotter display*

**Note 1:** If no signal is received from an AIS target for one minute and thirty seconds it is declared a lost target. Three minutes later it is erased from the screen.

**Note 2:** When a target's CPA and TCPA are lower than set in paragraph 1.6, the target flashes and the audio alarm sounds (if active). Press the [CLR/ALM] key to stop the flashing and silence the audio alarm. Take suitable measures to avoid collision.

## 1.8 Target Data Display

If you desire detailed information about a target, do the following:

### 1.8.1 Normal target data

1. Press the [MENU] key to open the menu.
2. Press the [1] key to choose TARGET DATA. (To show the DANGEROUS SHIPS display at this time, press the [SFT/ +/-] key. For further details about the DANGEROUS SHIPS display see paragraph 1.8.2.)

Targets listed in order of range from own ship	▼ NAME	RNG( <sup>n</sup> <sub>m</sub> )	BRG(°)	
	* FURUNO	2.9	276.1	
	VOYAGE	3.1	292.9	
	QUEST	4.3	279.5	
Target's name, and range and bearing from own ship to target	SEADOG	15.6	82.0	
	INTREP	21.1	123.1	
	GLOBER	28.8	246.3	
	DTLS: [ENT]	1/	6	← Target no. selected, no. of targets

*Target list*

3. Use the [▼] or [▲] key to choose the target whose data you wish to view, and then press [ENT] key.
4. Use the [▼] or [▲] key to scroll the display.
5. Press the [MENU] key twice to return to the main menu.

See the illustration on the next page for target data display examples.

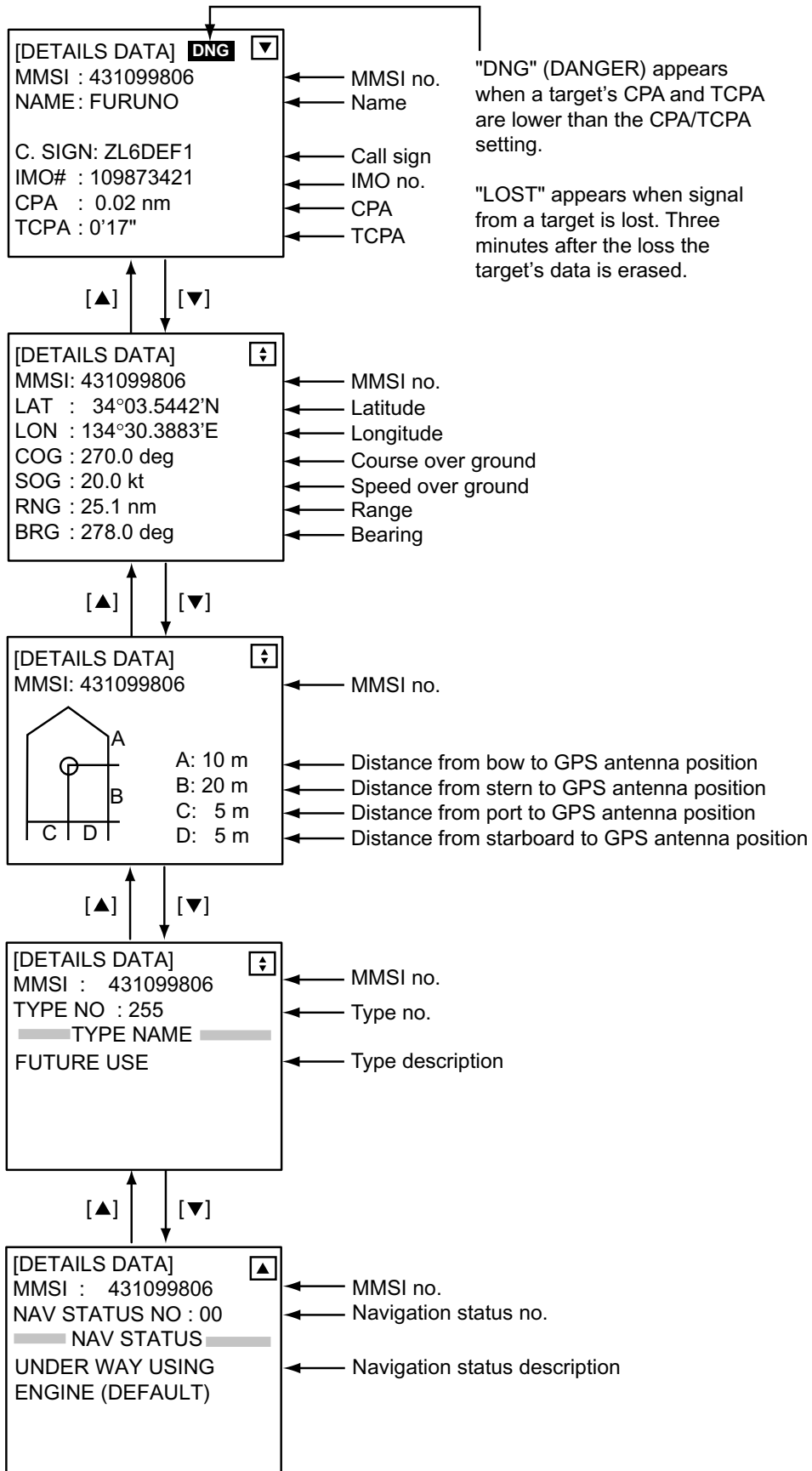

Target data displays

### 1.8.2 Finding dangerous ship's data

You can easily find dangerous ships whose CPA and TCPA are lower than the preset CPA and TCPA values set on the INIT SETTINGS menu.

1. Press the [MENU] key to open the menu.
2. Press the [1] key to choose TARGET DATA.
3. Press the [SFT/ +/-] key to show the DANGEROUS SHIPS display.

[DANGEROUS SHIPS]			
NAME	CPA( <sup>n</sup> / <sub>m</sub> )	TCPA	
* BOUNTY	0.2	2:00	
SEADOG	1.0	2:30	
DTLS: [ENT]		1/	2

Target's name, and CPA and TCPA →

← Target no. selected, no. of dangerous targets

#### *Dangerous ships display*

4. To find a dangerous target's details, choose it using the [▲] or [▼] key and then press the [ENT] key. The data format is the same as that shown on the previous page.
5. Press the [MENU] key several times to return to the main menu.

**Note:** The message "LOST" appears at the top of the DANGEROUS SHIPS display when no AIS signal is received from the selected target.



## 1.9 Own Ship's Information

The OWN DATA menu (Menu #3) shows your ship's information and status (set on the INIT SETTING menu) and navigation data.

### 1.9.1 Own static data

The OWN STATIC DATA display shows your ship's static data, which includes MMSI, call sign and name, IMO number, length and beam, type of ship and location of position fixing antenna. This data should be checked once per voyage or once per month whichever is shorter. Data may be changed only on the authority of the master.

1. Press the [MENU] key to show the menu.
2. Press the [3] key to open the OWN DATA sub-menu.

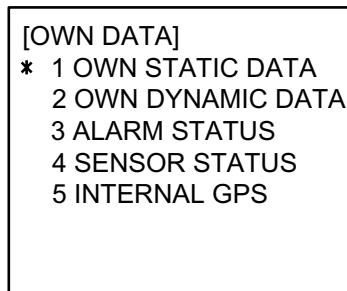

*OWN DATA sub-menu*

3. Press the [1] key to choose OWN STATIC DATA.
4. Use the [▼] or [▲] key to view other pages.
5. Press the [MENU] key twice to return to the main menu.

See the illustration on the next page for own static data examples.

# 1 OPERATION

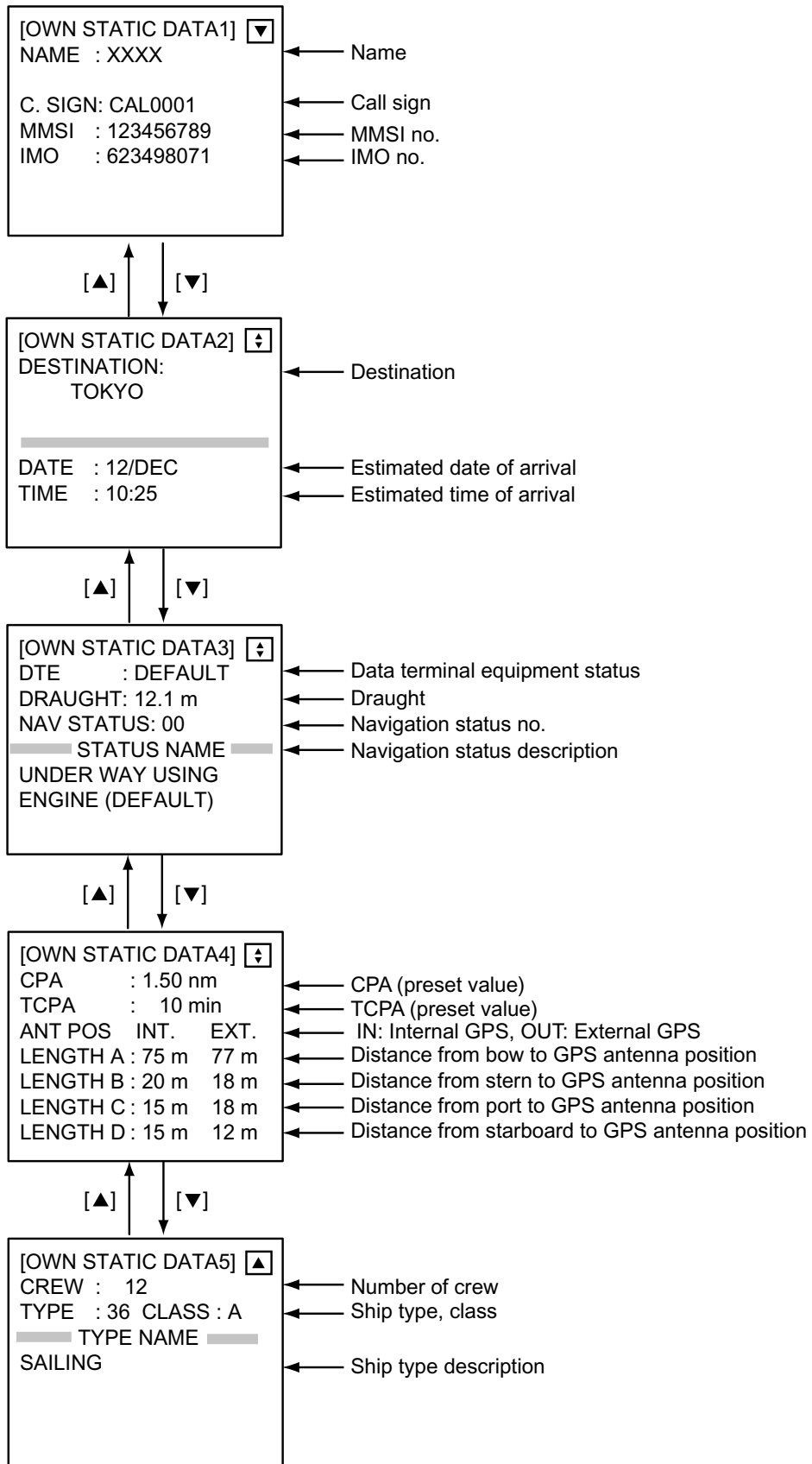

*OWN STATIC DATA displays*

## 1.9.2 Own dynamic data

The OWN DYNAMIC DATA display shows your ship's dynamic data, which includes time, date, ship's position, course over ground (COG), speed over ground (SOG), rate of turn (ROT), and heading.

The OOW should periodically check position, speed over ground and sensor information.

1. Press the [MENU] key to open the menu.
2. Press the [3] key to choose OWN DATA.
3. Press the [2] key to choose OWN DYNAMIC DATA.

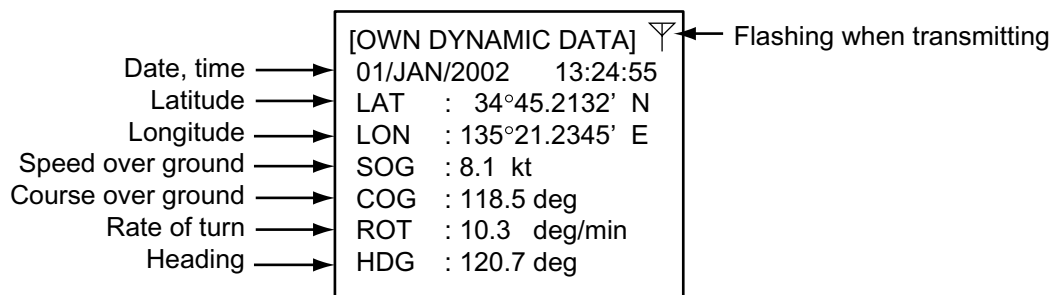

*OWN DYNAMIC DATA display*

4. Press the [MENU] key to close the display.

## 1.10 Messages

You may send and receive messages via the VHF link, to a specified destination (MMSI) or all ships in the area. Messages can be sent to warn of safety of navigation, for example, an iceberg sighted. Routine messages are also permitted.

Short safety related messages are only an additional means to broadcast safety information. They do not remove the requirements of the GMDSS.

When a message is received, the equipment beeps and the indication "MESSAGE" appears. The contents of the message may be viewed on the receive message log.

### 1.10.1 Sending a message

1. Press the [MENU] key to open the main menu.
2. Press the [4] key to open the SET MSG sub-menu.

```
[SET MSG]
* 1 CREATE MSG
  2 XMIT MSG(S)
  3 RCVD MSG(S)
```

*SET MSG sub-menu*

3. Press the [1] key to open the CREATE MSG sub-menu.

```
[CREATE MSG]
* 1 SET MSG TYPE
  2 SET MSG
  3 SEND MSG
```

*CREATE MSG sub-menu*

4. Press the [1] key to choose SET MSG TYPE.

```
[SET MSG TYPE]
* ADDRESS TYPE: [7/2]
  BROAD-CAST
  MMSI: 000000000
  MSG TYPE: NORMAL [7/2]
  CHANNEL#: A OR B [7/2]
```

*SET MSG TYPE sub-menu*

5. ADDRESS TYPE is selected; use the [SFT/ +/-] key to choose address type: ADDRESS-CAST for a specific ship, or BROAD-CAST for all ships. For BROAD-CAST go to step 7.
6. For ADDRESS-CAST, press the [NEXT] key to choose "MMSI," and then enter the MMSI of the receiving ship.
7. Press the [NEXT] key to choose MSG TYPE.
8. Use the [SFT/ +/-] key to choose message type: NORMAL (message other than safety) or SAFETY (important navigational or meteorological warning).
9. Press the [NEXT] key to choose CHANNEL#.
10. Use the [SFT/ +/-] key to choose which channel to transmit your message over; CH-A, CH-B, BOTH (CH-A and CH-B), or "A OR B" (either channel).
11. Press the [ENT] key to register settings and return to the CREATE MSG sub-menu.
12. Press the [2] key to choose SET MSG.

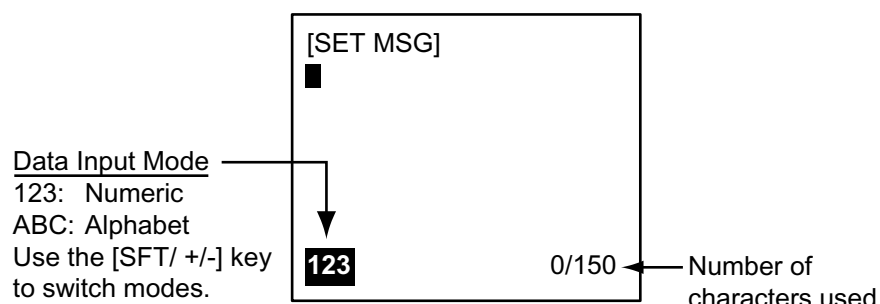

*SET MSG screen*

13. Key in your message, using up to 150 alphanumeric characters. Use the [SFT/ +/-] key to switch between numeric and alphabet input. If you enter a wrong character, use the [CLR/ALM] key to erase it.
14. Press the [ENT] key to save the message and return to the CREATE MSG sub-menu.
15. Press the [3] key (SEND MSG) to send your message.

The screen displays "NOW SENDING" during transmission and "SEND COMPLETED!" when transmission has been completed. (MMSI no. is shown along with "SEND COMPLETED" if the message was transmitted to a specific ship.) If the message could not be sent, "SEND FAILED" appears. And if you did not receive acknowledgement of a message, despite successful transmission, "UNSUCCESSFUL" appears.

### 1.10.2 Receiving messages

When a message is received the window below appears on the display. To view the contents of the message do the following:

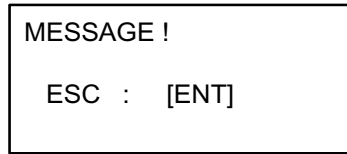

*Message received*

1. Press the [ENT] key to erase the “message received” window.
2. Press the [MENU] key to show the main menu.
3. Press the [4] key to choose SET MSG.
4. Press the [3] key to choose RCVD MSG(S).

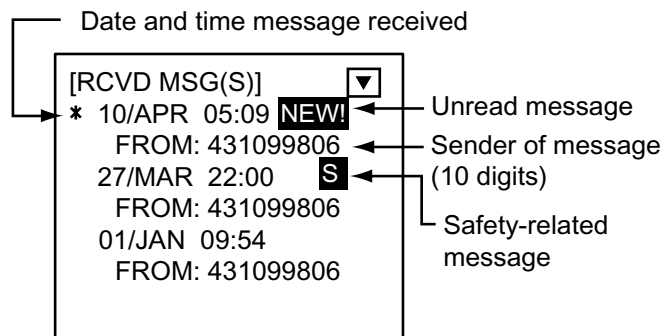

*Sample received message*

5. Press the [NEXT] key to choose message marked with “NEW” and press the [ENT] key to view the contents of the message.

### 1.10.3 Message logs

The FA-100 automatically saves five each of transmitted and received messages to their respective message logs. When a log becomes full, the oldest message in the log is automatically deleted to make room for the latest.

To display a message log, do the following:

1. Press the [MENU] key to open the menu.
2. Press the [4] key to choose SET MSG.
3. Press the [2] key to display the XMIT message log, or the [3] key to display the RCVD message log.

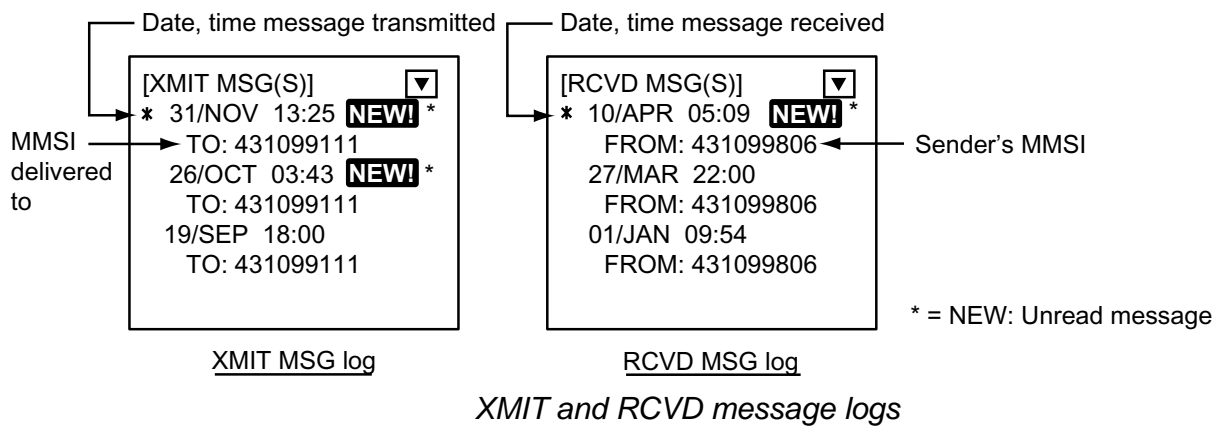

4. To view a message, choose it with the [▼] or [▲] key and then press the [ENT] key.
5. Press the [MENU] key twice to close the log and return to the main menu.

## 1.11 Regional Operating Channels

AIS operates primarily on two dedicated VHF channels, CH 2087 and CH2088. Where these channels are not available regionally, the AIS is capable of being automatically switching to designated alternate channels by means of a message from a shore facility. Where no shore based AIS or GMDSS sea area A1 station is in place, the AIS should be switched manually as in paragraph 1.11.2.

A regional operating area is set with the procedure below. The most recent eight areas are memorized.

- Automatic setting of VHF DSC (channel 70) from shore-based AIS
- Automatic setting by AIS message from shore-based AIS
- Setting by shipboard system such as ECDIS
- Manual setting

The default area is as follows:

- Tx power: 12.5 W
- Channel no. 2087, 2088
- Frequency bandwidth: 25 kHz
- Tx/Rx mode: Tx/Rx

### 1.11.1 Viewing channels, Tx power

Do the following to view current channels.

1. Press the [MENU] key to open the menu.
2. Press the [6] key to open the SYSTEM SETTINGS sub-menu.
3. Press the [2] key to choose SET CHANNEL.

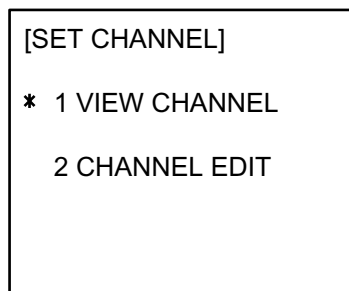

*SET CHANNEL menu*



4. Press the [1] key to show the VIEW CHANNEL display.

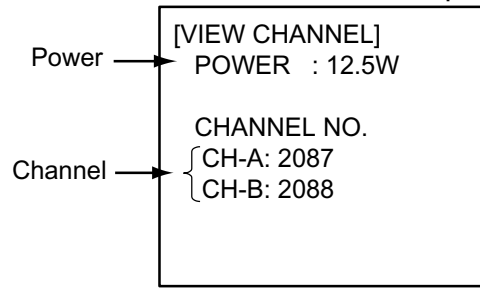

*VIEW CHANNEL display*

5. Press the [MENU] key to close the display.

## 1.11.2 Displaying, editing regional operating area status

You may display the status of regional operating areas currently memorized in the equipment. Nine of any combination of AIS message from shore-based AIS, DSC message, manual settings and commands from ECDIS or a PC may be registered and one will be a default value.

### About registering areas

- AIS and DSC messages registered within last two hours cannot be edited.
- An item labeled DEFAULT cannot be registered. (“DEFAULT” are data used for international waters not controlled by shore-based AIS.)
- If two areas overlap one another the oldest data is deleted.
- Data older than five weeks is deleted.
- Area data is deleted when it is more than 500 miles from the area for which it was registered.

1. Press the [MENU] key to open the menu.
2. Press the [6] key to open the SYSTEM SETTINGS sub-menu.
3. Press the [2] key to choose SET CHANNEL.
4. Press the [2] key to open the CHANNEL EDIT sub-menu.

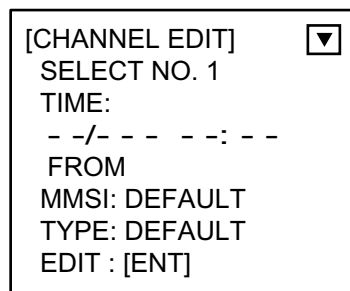

*CHANNEL EDIT sub-menu, page 1*

SELECT NO.: File number, 1-9. In order of distance from own ship, from closest to furthest.

TIME: Data and time equipment controlled by external source.

MMSI: MMSI displayed for control by DSC or shore-based AIS. Dashes or “EMPTY” (no data) otherwise.

TYPE: How channel is controlled:  
AIS, AIS message; PI, ECDIS or PC; DSC, DSC, MANUAL,  
manual control

**Note:** MMSI and TYPE must be set to other DEFAULT to edit.

5. Use the [▲] or [▼] key to choose file number from SELECT NO.
6. Press the [ENT] key to show details.

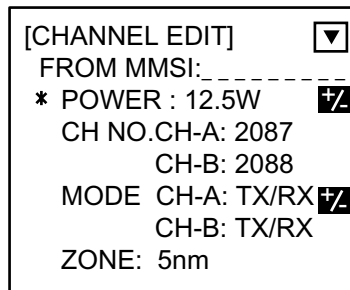

*CHANNEL EDIT sub-menu, page 2*

7. POWER is selected; press the [SFT/ +/-] key to choose power: 12.5 W or 2 W.
8. Press the [NEXT] key to choose CH NO.
9. Key in channel number for channel A and B with the numeric keys.
10. Press the [NEXT] key to choose MODE.
11. Press the [SFT/ +/-] key to assign mode for channel A and B. Each time the key is pressed the selection changes in the sequence of TX/RX, TX/RX; TX/RX, RX; RX, TX/RX; RX, RX; RX, UNUSED; UNUSED, RX.
12. Press the [NEXT] key to choose ZONE. In this zone, the #1 channel in selected area and the #1 channel in the adjacent zone are used for communications.
13. Key in the zone distance. The setting range is 0 to 8 (nm), and the default setting is 5 nm.
14. Press the [NEXT] key to go to the next page.

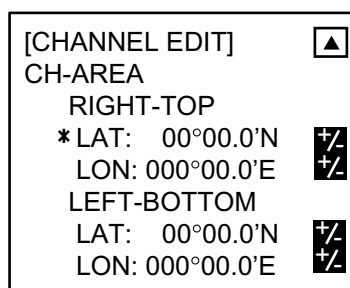

*CHANNEL EDIT sub-menu, page 3*

15. Key in the latitude and longitude for the right-top position (northeast point) of the AIS operating area. Use the [SFT/ +/-] key to switch coordinate, if necessary.
16. Press the [NEXT] key to choose LEFT-BOTTOM.
17. Key in the latitude and longitude for the left-bottom position (southwest position) of the AIS operating area. Use the [SFT/ +/-] key to switch coordinate, if necessary.

**Note:** The available range is 20-200 nm. If the area contains overlapping data the older data will be erased.

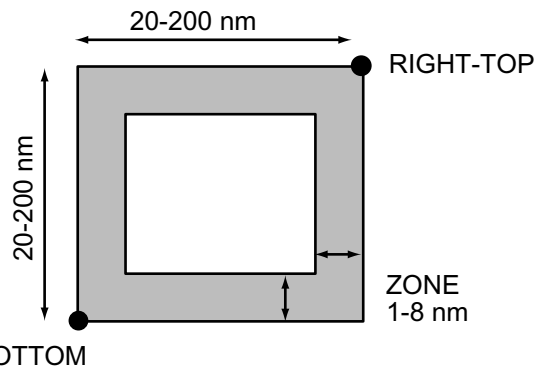

*Description of RIGHT-TOP, LEFT-BOTTOM, ZONE*

**Note:** To check or edit settings on previous page, press the [NEXT] key while pressing the [SFT +/-] key.

18. Press the [ENT] key.
19. YES is selected; press the [ENT] key to register settings. (If the password entry screen is displayed, MMSI is set to DEFAULT. This cannot be changed.)
20. Press the [MENU] key several times to close the menu.

**Note:** If you enter invalid data an appropriate error message appears. Press the [ENT] key and then reenter data.

## 1.12 Enabling/Disabling the Buzzer

The buzzer that sounds against CPA or TCPA violation and system trouble may be enabled or disabled as below. Note that this buzzer is not related to a radar or ECDIS alarm.

1. Press the [MENU] key to open the menu.
2. Press the [6] key to open the SYSTEM SETTINGS menu.
3. Press the [5] key to choose SET BUZZER.

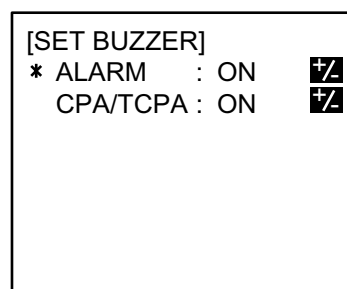

*SET BUZZER menu*

4. ALARM is selected; press the [SFT/ +/-] key to choose ON or OFF as appropriate. This alarm is given to system trouble.
5. Press the [NEXT] key to choose CPA/TCPA, and then press the [SFT/ +/-] key to choose ON or OFF as appropriate.
6. Press the [ENT] key to register settings.
7. Press the [MENU] key several times to close the menu.

## 1.13 Long Range Mode

The long range mode sets how to reply to a request for own ship data from a distant station, for example, Inmarsat C station. You may reply automatically or manually.

1. Press the [MENU] key to open the menu.
2. Press the [6] key to open the SYSTEM SETTINGS menu.
3. Press the [3] key to choose SET LR MODE.

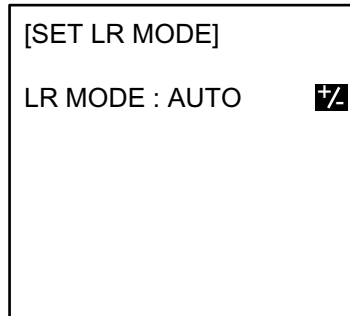

*SET LR MODE menu*

4. Press the [SFT/ +/-] key to choose AUTO or MANUAL as appropriate.  
AUTO for automatic replay, MANUAL for manual reply.
5. Press the [ENT] key to register setting.
6. Press the [MENU] key several times to close the menu.

### **Manual reply**

For manual reply, the message below appears when a request for own ship data arrives from a distant station. Press the [ENT] key to send the data, or choose NO and press the [ENT] key to send no data.

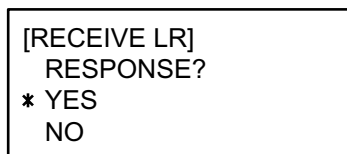

### **Automatic reply**

For automatic reply, the message below appears when a request for own ship data arrives from a distant station and its data is automatically transmitted. Press the [ENT] key to erase the message.

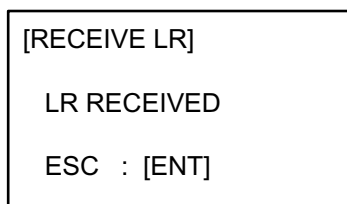

# 2 MAINTENANCE, TROUBLESHOOTING

---

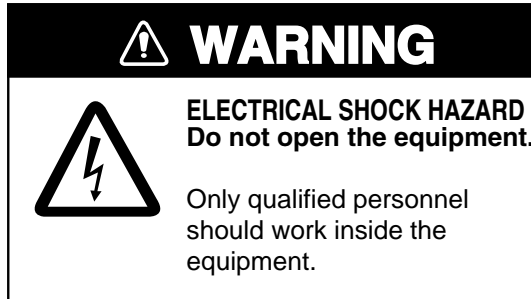

## 2.1 Maintenance

Regular maintenance is necessary to maintain performance. A monthly maintenance program should be established and should at least include the items in the table below.

### Maintenance items

Item	Check point
Connectors	Check that all connectors on the rear panel of the transponder unit are firmly connected.
Cabling	Check cabling for damage. Replace if damaged.
Ground terminal	Check the ground terminal for rust. Clean if necessary.
Ground wire	Confirm that the ground wire is firmly fastened.
Transponder unit cleaning	Dirt and dust should be removed from the transponder unit with a soft, dry cloth. Wipe the LCD carefully to prevent scratching, using tissue paper and an LCD cleaner. To remove dirt or salt deposits, use an LCD cleaner, wiping slowly with tissue paper so as to dissolve the dirt or salt. Change paper frequently so the salt or dirt will not scratch the LCD. Do not use solvents such as thinner, acetone or benzene for cleaning; they can remove paint and marks and deform the equipment.

## 2.2 Resetting the Breaker

The BREAKER button on the rear panel pops out when internal fault or overcurrent is detected. Find the cause before pushing in the breaker to restore normal operation.

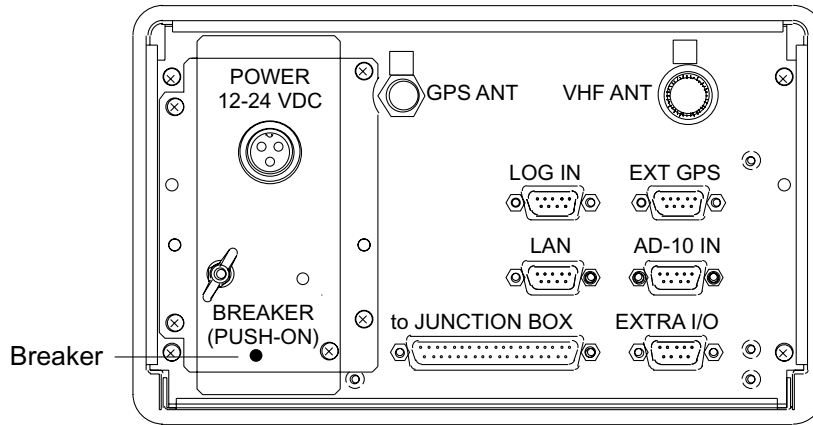

*FA-100 Transponder unit, rear view*

## 2.3 Replacement of Battery

The lithium battery on the MPB Board (24P0015) stores data while the power is turned off, and its life is about five years. When the voltage of the battery goes below a certain level, the message BACKUP ERROR appears when turning on the power. When this occurs, turn off the power and contact a FURUNO agent or dealer to request replacement of the battery, at your earliest convenience.

The battery stores own ship's static data: MMSI no., IMO no., ship name, call sign, ship's length and width and GPS antenna position. After the battery has been replaced, reenter own ship's static data.

Battery Type	Code No.
CR2/3-8LF1ST1SN	000-145-543

## 2.4 Troubleshooting

The troubleshooting table below provides common symptoms of trouble and the means to rectify them. If you cannot restore normal operation, do not attempt to check inside the equipment. Refer any repair work to a qualified technician.

### Troubleshooting

Symptom	Remedy
<b>Power</b>	
Cannot turn on the power.	<ul style="list-style-type: none"> <li>• Check that the power connector is firmly fastened.</li> <li>• Check if the breaker (red button) on the rear panel of the transponder unit has popped out. Find out the cause before pushing in the breaker to restore normal operation.</li> <li>• Check the power supply.</li> </ul>
<b>Transmitting, receiving messages</b>	
Cannot transmit or receive.	<ul style="list-style-type: none"> <li>• Check that the VHF antenna cable is firmly fastened.</li> <li>• Check the VHF antenna.</li> <li>• For TX message, try different TX channel (operating sequence: [MENU], [4], [1], [1]).</li> </ul>
Can transmit but message is sent to wrong party.	<ul style="list-style-type: none"> <li>• On the SET MSG TYPE sub-menu, check that ADDRESS TYPE is selected to ADDRESS-CAST and MMSI is correct, before sending a message. (operating sequence: [MENU], [4], [1], [1])</li> </ul>
<b>Position data</b>	
No position data	<ul style="list-style-type: none"> <li>• Check the GPS antenna for damage.</li> <li>• Check the GPS antenna cable and its connectors.</li> </ul>

## 2.5 Diagnostics

The FA-100 provides diagnostic tests to check program no., memory, keyboard, LCD and built-in GPS receiver.

### 2.5.1 Displaying program number

1. Press the [MENU] key to open the main menu.
2. Press the [7] key to open the DIAGNOSTICS sub-menu.

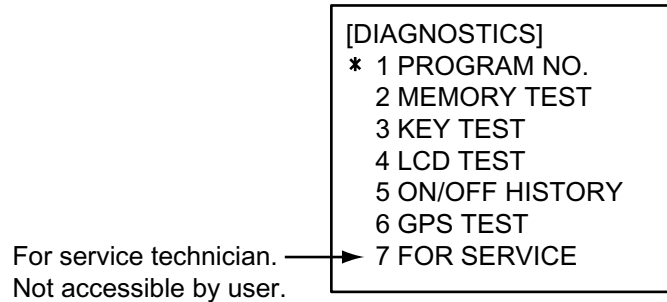

*DIAGNOSTICS sub-menu*

3. Press the [1] key to choose PROGRAM NO.

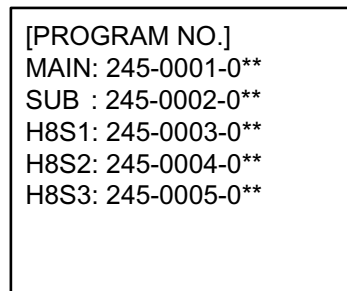

\*\* = Program version no.

*PROGRAM NO. display*

4. Press the [MENU] key to return to the DIAGNOSTICS sub-menu.



## 2.5.2 Memory test

The memory can be checked for proper operation as follows:

1. Press the [MENU] key to open the main menu.
2. Press the [7] key to open the DIAGNOSTICS sub-menu.
3. Press the [2] key to choose MEMORY TEST to test the memory. The results are shown as OK or NG (No Good). For any NG, contact your dealer for advice.

[MEMORY TEST]		
	ROM	RAM
MAIN	: OK	OK
SUB	: OK	OK
H8S1	: OK	OK
H8S2	: OK	OK
H8S3	: OK	OK

*MEMORY TEST display*

4. Press the [MENU] key to return to the DIAGNOSTICS sub-menu.

## 2.5.3 Keyboard test

The keyboard can be checked for proper operation as follows:

1. Press the [MENU] key to open the main menu.
2. Press the [7] key to open the DIAGNOSTICS sub-menu.
3. Press the [3] key to choose KEY TEST.

[KEY TEST]					
1	<input type="checkbox"/>	2	<input type="checkbox"/>	3	<input type="checkbox"/>
4	<input type="checkbox"/>	5	<input type="checkbox"/>	6	<input type="checkbox"/>
7	<input type="checkbox"/>	8	<input type="checkbox"/>	9	<input type="checkbox"/>
NXT	<input type="checkbox"/>	0	<input type="checkbox"/>	MEN	<input type="checkbox"/>
CLR	<input type="checkbox"/>	SFT	<input type="checkbox"/>	ENT	<input type="checkbox"/>
ESC : [MENU]x3					

*KEY TEST display*

4. Press each key (except the [POWER] key) one by one. A key's on-screen location fills in black while the key is pressed, if the key is functioning properly.
5. To escape from the keyboard test, press the [MENU] key three times.

### 2.5.4 LCD test

The LCD can be checked for proper display as follows:

1. Press the [MENU] key to open the main menu.
2. Press the [7] key to open the DIAGNOSTICS sub-menu.
3. Press the [4] key to choose LCD TEST. The screen color automatically changes from yellowish-green to black alternately if the LCD is normal.

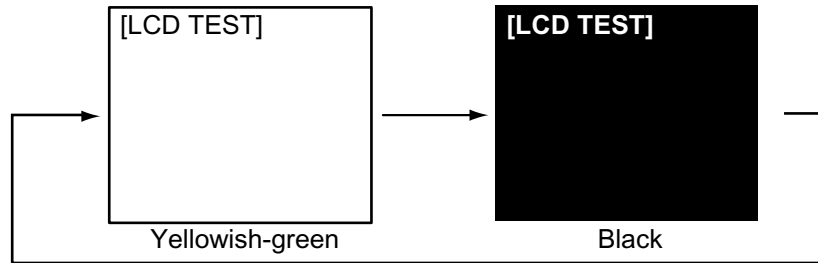

*LCD TEST display*

4. Press the [MENU] key to return to the DIAGNOSTICS sub-menu.

### 2.5.5 On/off history

The ON/OFF HISTORY log shows the date and time of the latest 30 power-ons and power-offs. In special cases, on and off times of 0 W transmission may also be shown.

1. Press the [MENU] key to open the main menu.
2. Press the [7] key to open the DIAGNOSTICS sub-menu.
3. Press the [5] key to choose ON/OFF HISTORY.

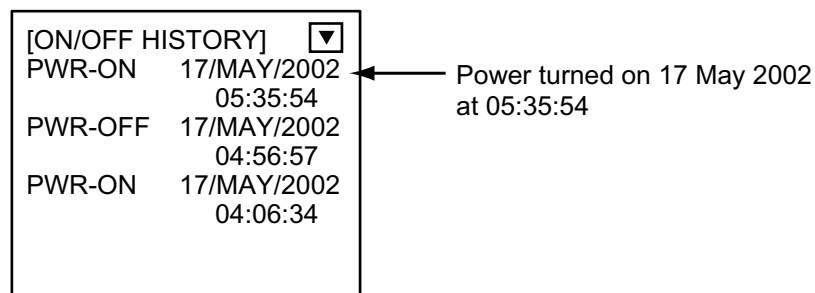

*ON/OFF HISTORY log*

4. Use the [▼] or [▲] key to scroll the log.
5. Press the [MENU] key to return to the DIAGNOSTICS sub-menu.

## 2.5.6 GPS test

The GPS test checks the built-in GPS receiver for proper operation.

1. Press the [MENU] key to open the main menu.
2. Press the [7] key to open the DIAGNOSTICS sub-menu.
3. Press the [6] key to choose GPS TEST.

[GPS TEST]

START OF TEST

PUSH [ENT]

*GPS TEST display*

4. Press the [ENT] key to start the test. "NOW TESTING..." is displayed during the testing and the results are displayed as shown in the illustration below. SELF TEST1 shows OK for normal operation; NG (No Good) for abnormal operation. SELF TEST shows "0" for normal operation; other numeric for abnormal operation.

[GPS TEST]

PROGRAM No. : 4850218

PROGRAM Ver. : 0\*\*

SELF TEST1 : OK

SELF TEST2 : 0

■ ERROR CONTENTS ■

\*\* = Program Version No.

*GPS test results*

5. Press the [MENU] key to return to the DIAGNOSTICS sub-menu.

## 2.6 Alarm Status

The alarm status log shows the date and time alarms were violated.

1. Press the [MENU] key to open the main menu.
2. Press the [3] key to choose OWN DATA.
3. Press the [3] key to choose ALARM STATUS.

Alarm name, date and time of alarm	[ALARM STATUS]		
EPFS	7/MAR	4:32:16	
L/L	7/MAR	4:02:01	
SOG	7/MAR	2:34:54	
COG	6/MAR	7:09:32	
HDG	3/MAR	8:00:21	
ROT	19/FEB	9:05:22	

*ALARM STATUS display*

4. Use the [▼] or [▲] key to scroll the log.
5. Press the [MENU] key to close the log.

### Alarm statuses and their meanings

Alarm Status Indication	Alarm Message	Meaning
TX	Tx malfunction	TX malfunction
ANT	Antenna VSWR exceed limit	Antenna VSWR trouble. Continued operation possible.
CH1	Rx channel 1 malfunction	TDMA RX 1 Board trouble. TX stopped on corresponding TX channel.
CH2	Rx channel 2 malfunction	TDMA RX2 Board trouble. TX stopped on corresponding TX channel.
CH70	Rx channel 70 malfunction	DSC RX Board trouble, transmission stopped on CH70.
EPFS	External EPFS lost	No data from external navigator. Continued operation possible.
L/L	No sensor positioning in use	No L/L data
SOG	No valid SOG information	Invalid SOG data
COG	No valid COG information	Invalid COG data
HDG	Heading lost/invalid	Invalid/nonexistent HDG data
ROT	No valid ROT information	Invalid ROT data

## 2.7 Error Messages

The FA-100 displays the following error messages to alert you to invalid data, etc..

### Error messages

Message	Meaning
BATTERY ERROR!	Voltage of backup battery is getting low.
BACKUP ERROR	ROM contents erased because voltage of backup battery is too low.
ENTER MMSI	Your MMSI was not found when turning on the power.
NO SEL. RENEW AGAIN	No data found for target selected (target data, dangerous ship).
CAN'T DISPLAY OVER LAT85°	Own ship's latitude is higher than 85°.
INVALID DATA	Invalid own ship position.
NO MMSI	MMSI not entered when SEND MSG is set for ADDRESS-CAST.
SYNCHRONISM CAN'T TAKEN	Slot synchronization not yet performed when you attempted to send a message.
NO MESSAGE!	No TX message when you attempted to send a message.
SEND FAILED!	Transmission failed.
UNSUCCESSFUL!	Message sent did not reach specified station. (Not receiving ACK.)
NO MESSAGE	No TX or RX message.
OUT OF RANGE!: DRAUGHT:0-25.5	Invalid draught entered in SET SHIP DATA.
OUT OF RANGE!: YEAR	Invalid year entered in SET DESTINATION.
OUT OF RANGE!: MONTH:1-12	Invalid month entered in SET DESTINATION.
OUT OF RANGE!: DAY:1-29/30/31	Invalid day entered in SET DESTINATION.
OUT OF RANGE!: HOUR:0-23	Invalid hour entered in SET DESTINATION.
OUT OF RANGE!: MINUTE:0-59	Invalid minute entered in SET DESTINATION.
OUT OF RANGE!: CREW:0-8191	Invalid crew no. entered in SET CREW&TYPE.
OUT OF RANGE!: CPA:0-6.00	Invalid CPA range entered.
OUT OF RANGE!: TCPA:0-60	Invalid TCPA entered.
OUT OF RANGE!: CH-A:IT DOESN'T EXIST	Invalid CH-NO. A entered on the CHANNEL EDIT sub-menu.
OUT OF RANGE!: CH-A:IT DOESN'T EXIST	Invalid CH-NO. A entered on the CHANNEL EDIT sub-menu.
OUT OF RANGE!: ZONE:1-8	Invalid ZONE entered on the CHANNEL EDIT sub-menu.
ERROR REGIST	Duplicate data in overlapping sea areas.
OUT OF RANGE!: ROT CYCLE:1-10	Invalid ROT entered in SET I/O menu.

**Note:** Detection of RX Malfunction

**1) Detection of TDMA RX malfunction**

Frequency error

PLL chip on receiver board generates lock or unlock signal for synthesizer.

MPU watches and sets status flag which reflects data of ALR sentence.

ID 003 for RX1, ID 004 for RX2

**2) Detection of DSC RX malfunction**

General error

DSC Error (ID: 005) will happen in case of DSC MPU could not receive format specifier of the data from DSC amplifier unless RSSI exists more than four seconds.

## 2.8 GPS Monitor

The GPS monitor display shows information about the built-in GPS receiver, including position, speed over ground, course over ground, date, time, mode and status.

1. Press the [MENU] key to open the menu.
2. Press the [3] key to choose OWN DATA.
3. Press the [5] key to choose INTERNAL GPS.

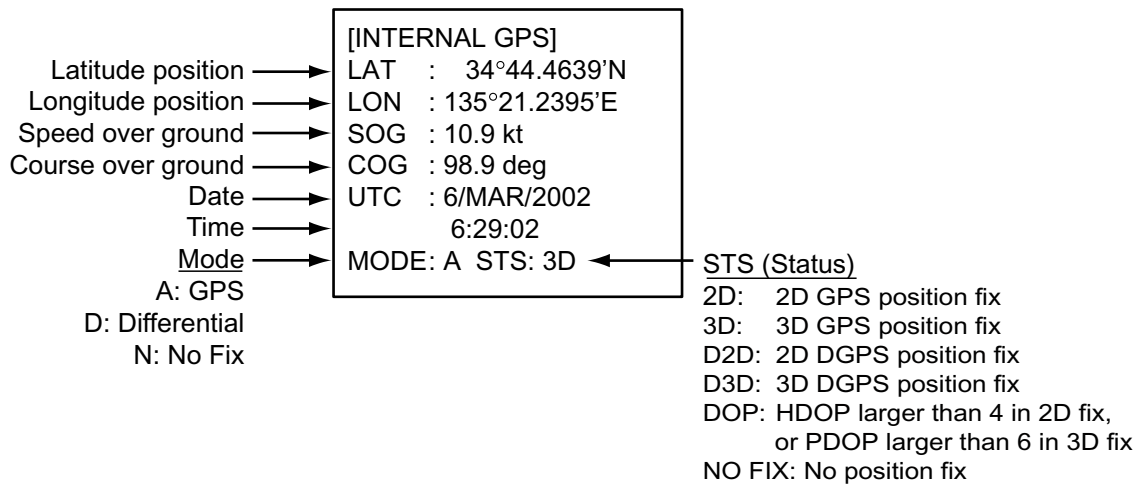

*Internal GPS monitor*

5. Press the [MENU] key to close the display.

## 2.9 Displaying Sensor Status

The SENSOR STATUS display monitors sensor status.

1. Press the [MENU] key.
2. Press the [3] key to choose OWN DATA.
3. Press the [4] key to choose SENSOR STATUS.

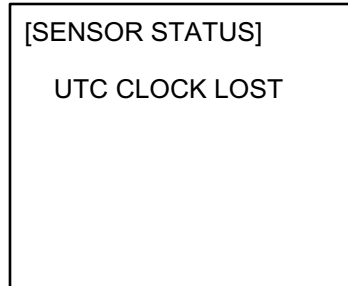

*Sensor status display*

4. Press the [MENU] key to close the menu.

## 2.10 Restoring Default Settings

You may clear all settings to start afresh with default settings. When this is done, the default options for all items in the INIT SETTING and SYSTEM SETTINGS sub-menus are restored. GPS data is also cleared; however, MMSI and IMO numbers are not cleared.

1. Turn on the power while pressing and holding down the [CLR/ALM] key. Hold down the [CLR/ALM] key until the “SHUT DOWN” screen below appears.

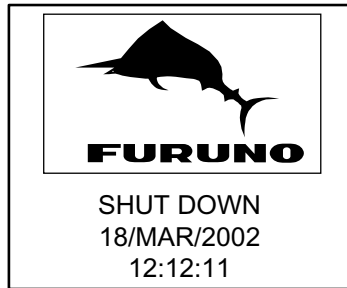

*Shut down screen*

2. The equipment then starts restoring default settings, showing “COMPLETE” when finished.

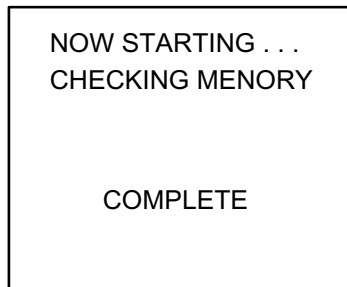

*Screen after memory has been cleared*

3. Press the [CLR/ALM] key. The plotter display appears.
4. Set items in INIT SETTINGS and SYSTEM SETTINGS, referring to Chapter 1.



# APPENDIX

## Menu Tree

Default settings in bold italics.

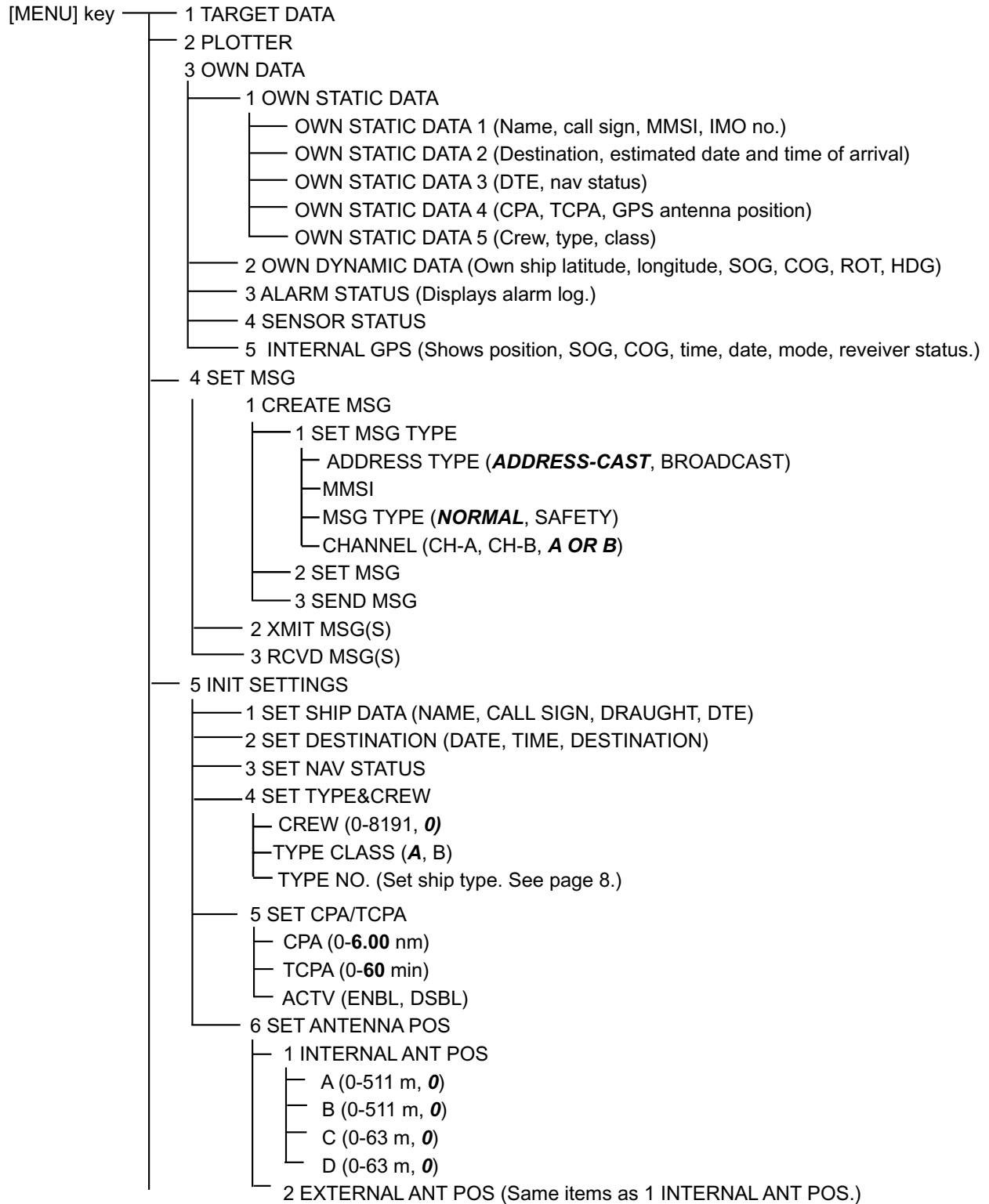

(Continued on next page.)

(A)

6 SYSTEM SETTINGS

- 1 SET I/O PORT
  - 1 I/O SPEED (PCI/I/O, SNSR1, SNSR2, SNSR3, L/R, BCON, EXTRA1 I/O, XTRA I/O. Setting: 38.4k, 4800)
  - 2 I/O FUNCTION (**EXT DISP**, LR)
  - 3 I/O PRIORITY
    - 1 L/L, COG, SOG (SN1, 1; SN2, 2; SN3, 3; EX1, 4; LR, 5; PC, 6, LAN, 7)
    - 2 HDG (Same as 1 above)
    - 3 ROT (Same as 1 above)
    - 4 AIS
      - RESPONSE (**PC**, LAN, NONE, EX1, LR)
      - EX1 (**ENBL**, DSBL)
      - LR (**ENBL**, DSBL)
      - PC (**ENBL**, DSBL)
      - LAN (**ENBL**, DSBL)
  - 4 SET LAN (IP ADRS) (IP ADDRESS **000-000-000-000**, SUB) NET MASK **000-000-000-000**, PORT No. 10000)
- 2 SET CHANNEL
  - 1 VIEW CHANNEL
    - POWER (0, 2, 12.5 W)
    - CHANNEL NO. (CH-A, **2087**, CH-B, **2088**)
  - 2 CHANNEL EDIT
    - SELECT (1-9)
    - TIME
    - MMSI
    - TYPE
    - POWER (12.5W, 2 W)
    - CH-NO. CH-A (0000)  
CH-B (0000)
    - MODE CH-A (TX/RX, RX UNUSED)  
CH-B (TX/RX, RX UNUSED)
    - ZONE: 0 nm (1-8)
    - CH AREA RIGHT-TOP (LAT, LON)  
LEFT-BOTTOM (LAT, LON)
- 3 SET L/R MODE (**AUTO**, MANUAL)
- 4 SET OTHER I/O
  - AD-10 (ENBL, **DSBL**)
  - LOG (ENBL, **DSBL**)
  - ROT (1-10 s, 1.)
- 5 SET BUZZER
  - ALARM (**ON**, OFF)
  - CPA/TCPA (**ON**, OFF)

7 DIAGNOSTICS

- 1 PROGRAM NO.
- 2 MEMORY STATUS
- 3 KEY TEST
- 4 LCD TEST
- 5 ON/OFF HISTORY
- 6 GPS TEST
- 7 FOR SERVICE

## Parts List

This equipment contains complex modules in which fault diagnosis and repair down to component level are not practical (IMO A.694(17)/8.3.1. Only some discrete components are used. FURUNO Electric Co., Ltd. believes identifying these components is of no value for shipboard maintenance; therefore, they are not listed in the manual. Major modules can be located on the parts location photo on page AP-4.

### FURUNO

#### ELECTRICAL PARTS LIST

2002-June

Model	FA-100	
Unit	TRANSPONDER UNIT	
Blk.No.		

SYMBOL	TYPE	CODE No.	REMARKS	SHIPPABLE ASSEMBLY
<b>PRINTED CIRCUIT BOARD</b>				
	24P0026, LKY2	005-950-780		X
	24P0025, OCN2	005-950-790		X
	24P0024, MOT2	005-950-800		X
	24P0015, MPB	005-950-880		X
<b>ASSEMBLY</b>				
	RX1	005-952-240	24P0010A	X
	RX2	005-952-250	24P0010B	X
	EXCT	005-952-260	24P0012	X
	DSC	005-952-270	24P0013	X
	PA	005-952-280	24P0014	X
	PWX	005-952-290	24P0016	X
<b>FRONT PANEL ASSEMBLY</b>				
	FA-100	005-952-310		X
<b>FILTER ASSEMBLY</b>				
	FA-100	005-952-230		X
<b>BREAKER</b>				
BK1	TBC5101-01-1211	000-119-400		
<b>GPS ASSEMBLY</b>				
	GN-7N5A-N	005-952-860		

# Parts Location

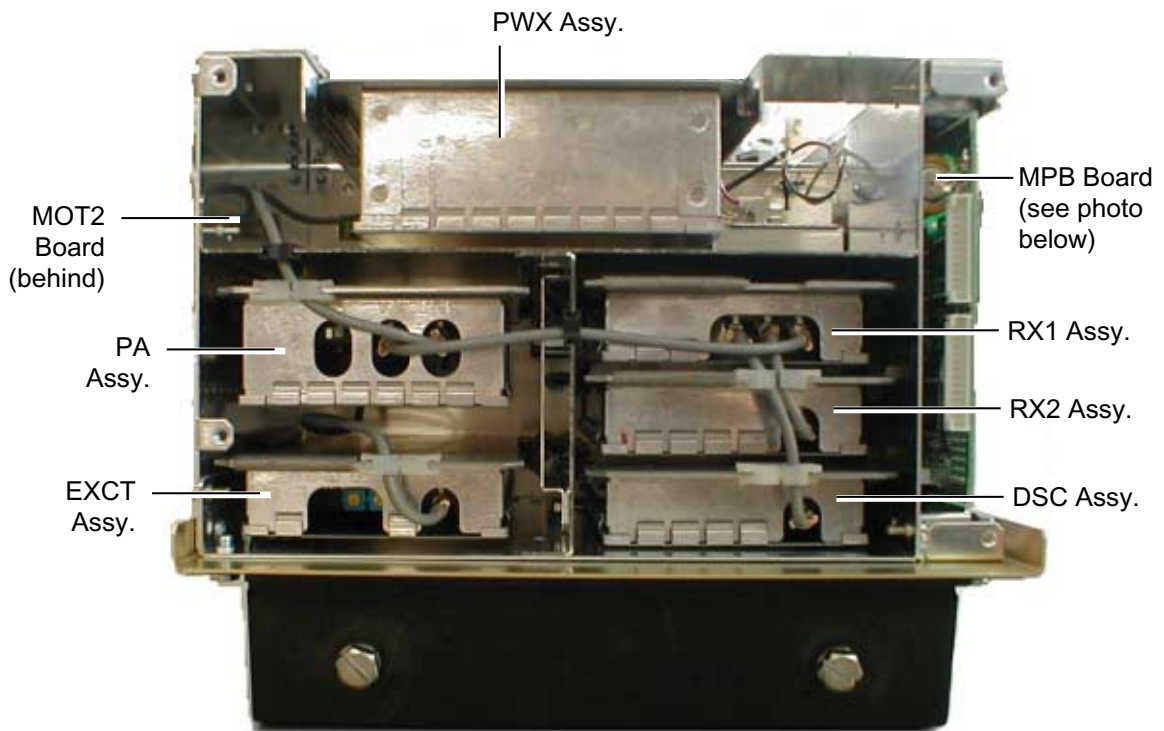

*Transponder unit, front view, front panel removed*

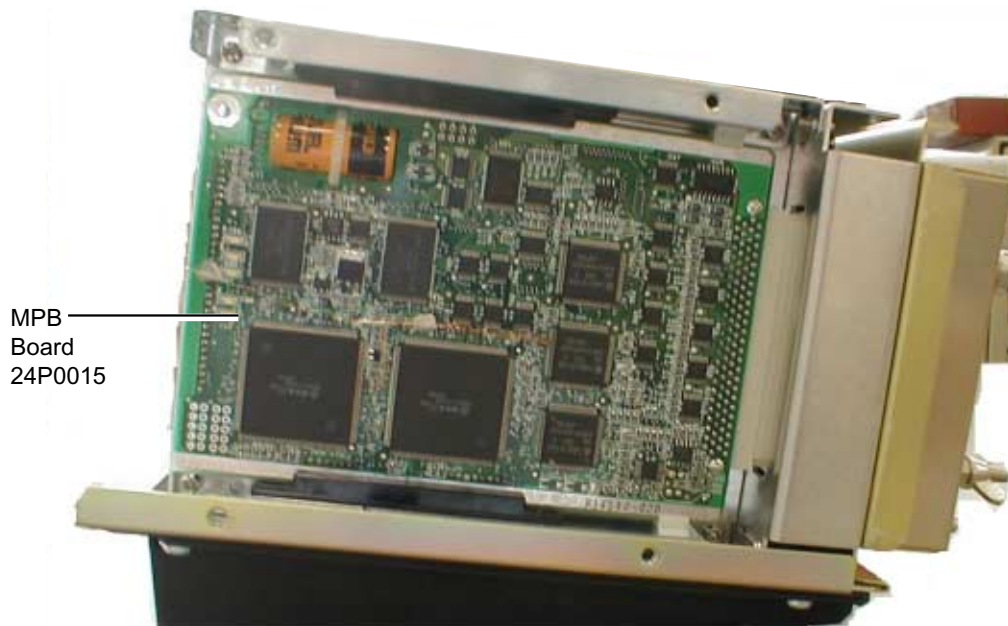

*Transponder unit, right side view, cover removed*

GPS Receiver  
GN-79N5A-N

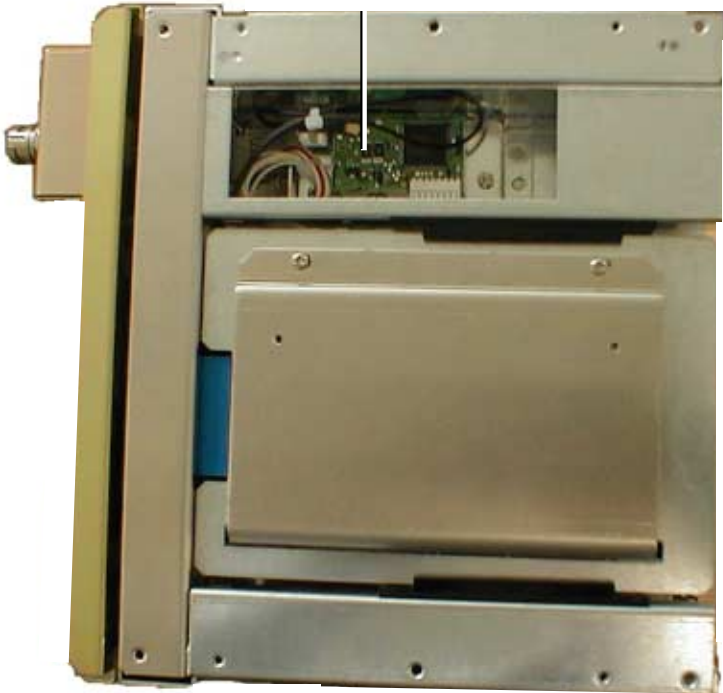

*Transponder unit, top view, cover removed*

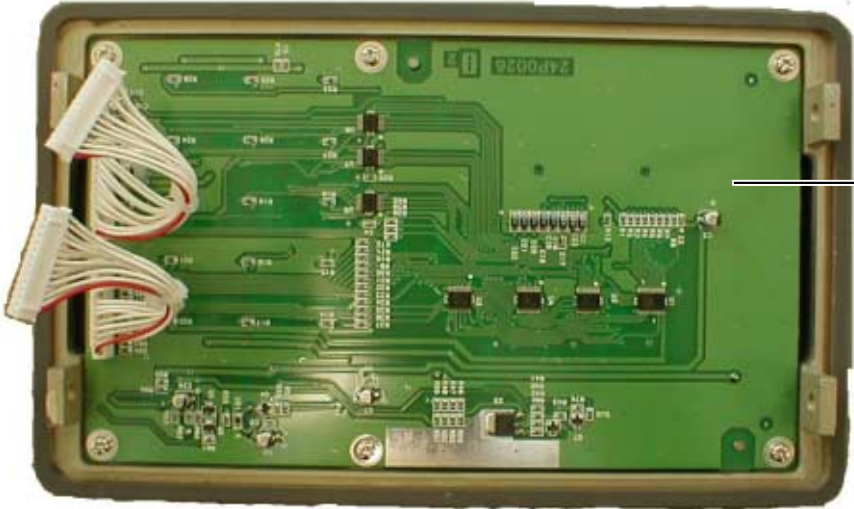

*Front panel of transponder unit*



FA-100, front view

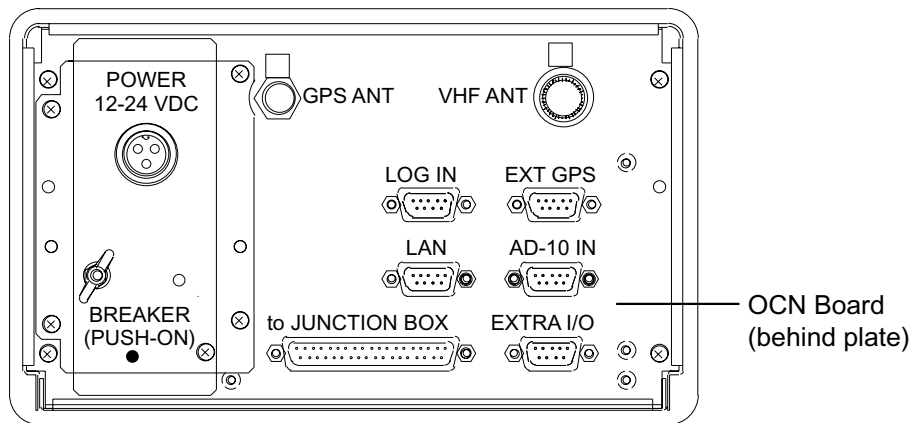

FA-100, rear view

## Digital Interface (IEC 61162-2)

### Sentence data

#### Input sentences

ABM, ACA, ACK, AIR, BBM, DTM, GBS, GGA, GLL, GNS, HDT, LRF, LRI, OSD, RMC, ROT, SSD, VBW, VSD, VTG

#### Output sentences

ABK, ACA, ALR, LRF, LR1, LR2, LR3, TXT, VDM, VDO

### Transmission interval

ABK: With each event

ACA: At RX

ALR: 30 s during alarm, 2 min normally no alarm

LRF, LR1, LR2, LR3: At RX

TXT: Each update

VDM: At RX

VDO: 1 s

### Load requirements as listener

Isolation: None

Input Impedance: 6.3 k ohms

Max. Voltage:  $\pm 15$  V

Threshold:  $\pm 0.2$  V (A-B)

### Data transmission

Data is transmitted in serial asynchronous form in accordance with the standard referenced in 2.1 of IEC 61162-2. The first bit is a start bit and is followed by data bits, least-significant-bit as illustrated below.

The following parameters are used:

Baud rate: 38.4 Kbps /4800 bps

Data bits: 8 (D7 = 0), parity none

Stop bits: 1

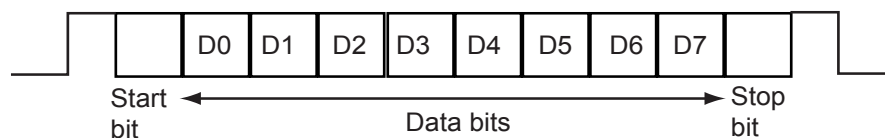

**Serial interface I/O circuit**

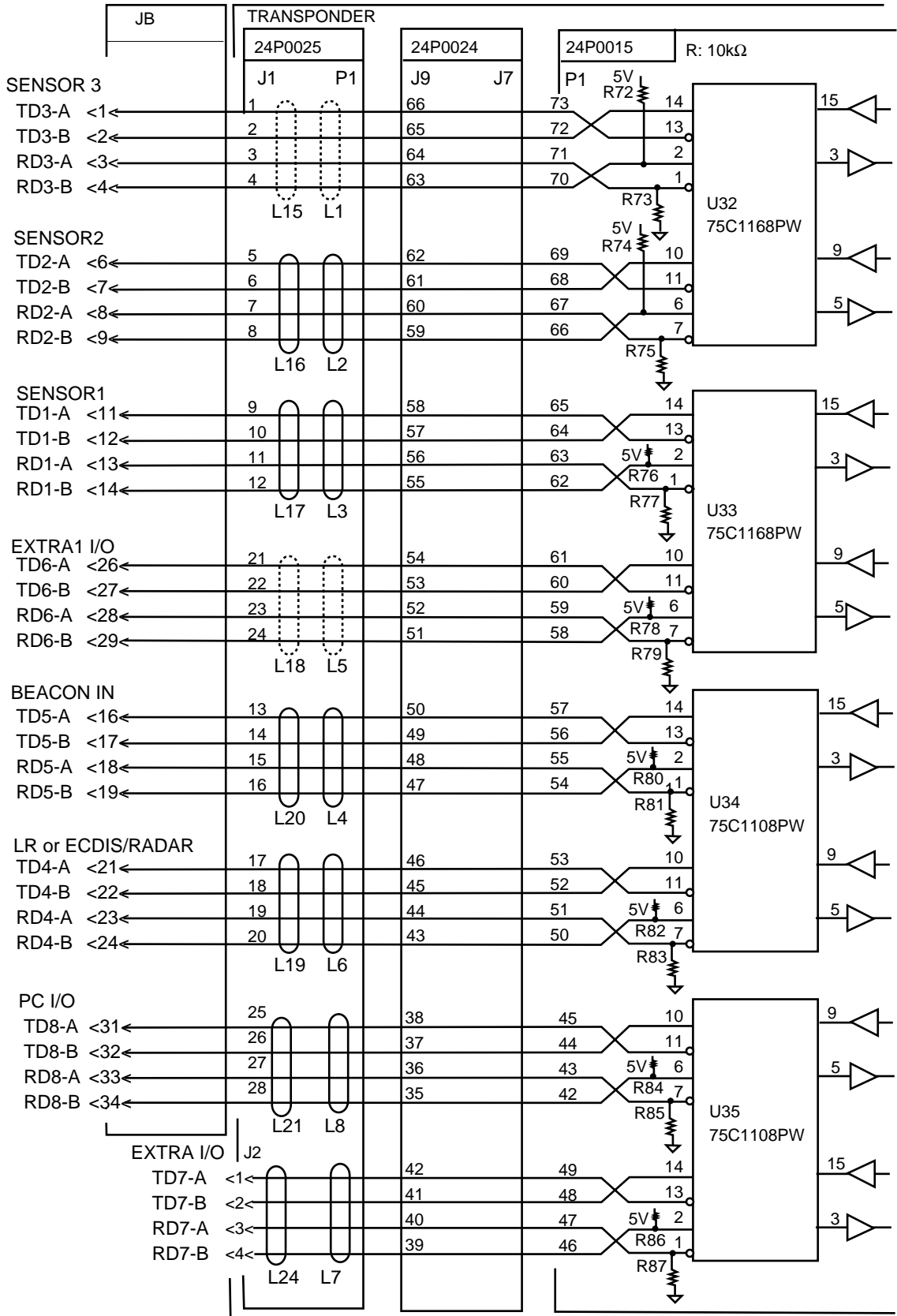



## Sentence description

### Input

#### **ABM - Addressed binary and safety related message**

This sentence provides an external application with a means to exchange data using an AIS.

!-ABM,x,x,x,xxxxxxxx,x,xx,s--s,x\*hh<CR><LF>

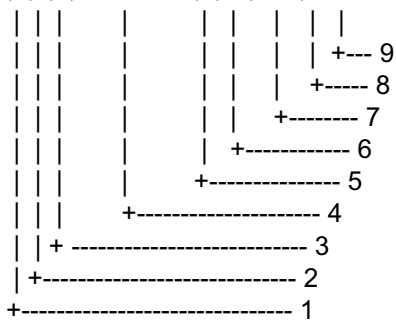

1. Total number of sentences needed to transfer the message, 1 to 9
2. Message sentence number, 1 to 9
3. Message sequence identifier, 0 to 3
4. The MMSI of destination AIS unit for the ITU-R M.1371 message 6 or 12
5. AIS channel for broadcast of the radio message
6. VDL message number(6 or 12), see ITU-R M.1371
7. Encapsulated data
8. Number of fill-bits, 0 to 5
9. Checksum

**ACA - AIS regional channel assignment message**

This sentence is used to both enter and obtain channel management information.

\$--ACA,x,IIII.I, a,yyyyy.yy,a,IIII.II,a,yyyyy.yy,a,x,xxxx,x,xxxx,x,x,x,a,x,hhmmss.ss\*hh<CR><LF>

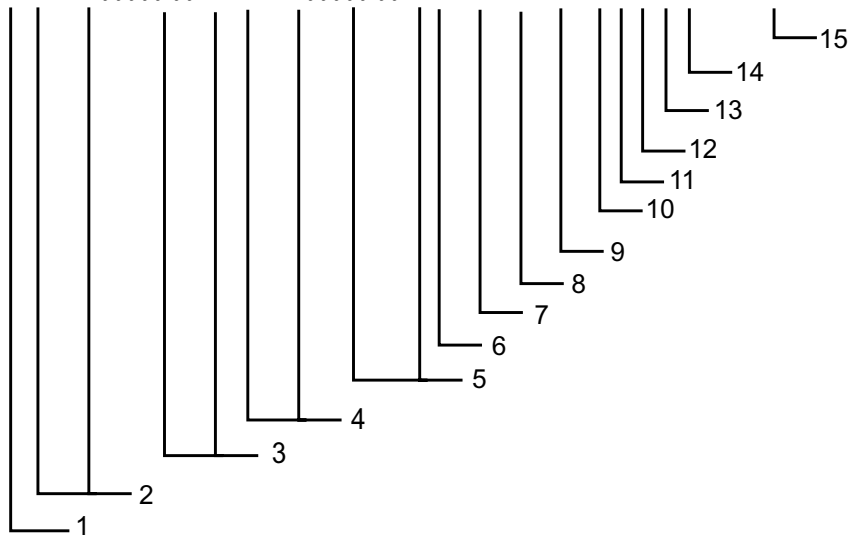

1. Sequence number, 0 to 9
2. Region Northeast corner latitude - N/S
3. Region Northeast corner longitude - E/W
4. Region Southwest corner latitude - N/S
5. Region Southwest corner longitude - E/W
6. Transition Zone Size
7. Channel A
8. Channel A bandwidth
9. Channel B
10. Channel B bandwidth
11. Tx/Rx mode control
12. Power level control
13. Information source
14. In-use flag
15. Time of in-used change

**ACK- Acknowledge alarm**

\$--ACK,xxx\*hh<CR><LF>

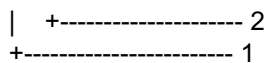

1. Local alarm number(identifier)
2. Checksum

## AIR - AIS interrogation request

This sentence provides an external application with the means to initiate a request for specific ITU-R M.1371 message from distant mobile or base AIS stations.

```
$--AIR,xxxxxxxx,x.x,x.x,x.x,xxxxxxxx,x.x,x*hh<CR><LF>
```

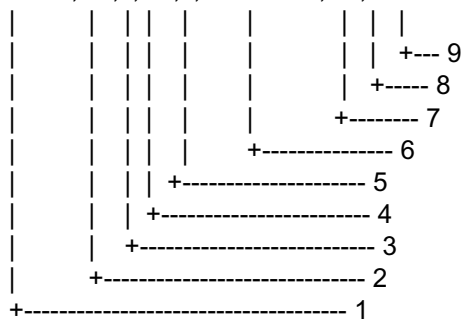

1. MMSI of interrogated station 1
2. ITU-R M.1371 message requested from station 1
3. Message 5 data set indicator
4. Number of second message requested from station 1
5. Message 5 data set indicator
6. MMSI of interrogated station 2
7. Number of message requested from station 2
8. Message 5 data set indicator
9. Checksum

## BBM - UAIS broadcast binary message

This sentence provides an external application with a means to broadcast data, as defined by the application only – not the AIS.

```
!--BBM,x,x,x,x,xx,s--s,x*hh<CR><LF>
```

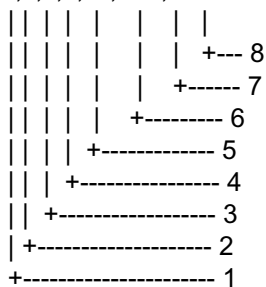

1. Total number of sentences needed to transfer the message, 1 to 9
2. Message sentence number, 1 to 9
3. Sequential Message identifier, 0 to 9
4. AIS channel for broadcast of the radio message
5. VDL message number(8,14,19 or 21), see ITU-R M.1371
6. Binary data
7. Number of fill-bits, 0 to 5
8. Checksum

### DTM - Datum reference

Local geodetic datum to which a position location is referenced.

\$--DTM,ccc,a,x.x,a,x.x,a,x.x,ccc\*hh<CR><LF>

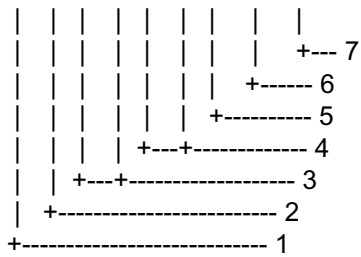

1. Local datum W84 - WGS84  
W72 - WGS72  
S85 - SGS85  
P90 - PE90  
999 - User defined  
IHO datum code
2. Local datum subdivision code
3. Lat offset, min, N/S
4. Lon offset, min, E/W
5. Altitude offset, m (Not used.)
6. Reference dattum W84 - WGS84  
W72 - WGS72  
S85 - SGS85  
P90 - PE90
7. Checksum

## GBS - GNSS satellite fault detection

This message is used to support receiver autonomous integrity monitoring (RAIM). Given that a GPS receiver is tracking enough satellites to perform integrity checks of the positioning quality of the position solution, a message is needed to report the output of this process to other systems to advise the system user. With the RAIM in the GPS receiver, the receiver can isolate faults to individual satellites and not use them in its position and velocity calculations. Also, the GPS receiver can still track the satellite and easily judge when it is back within tolerance.

This message shall be used for reporting this RAIM information. To perform these integrity functions, six channels of satellite tracking are a minimum while all-in-view tracking is most desirable.

\$--GBS,hhmmss.ss,x.x,x.x,x.x,xx,x.x,x.x,x.x\*hh<CR><LF>

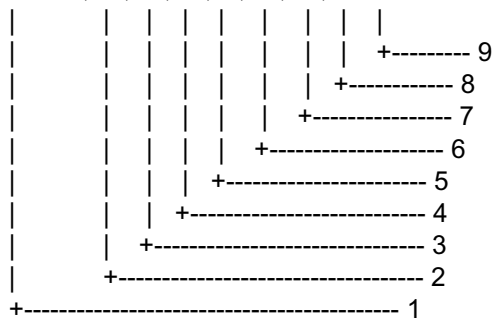

1. UTC time of the GGA or GNS fix associated with this sentence
2. Expected error in latitude
3. Expected error in longitude
4. Expected error in altitude
5. ID number of most likely failed satellite
6. Probability of missed detection for most likely failed satellite
7. Estimate of bias on most likely failed satellite
8. Standard deviation of bias estimate
9. Checksum

### GGA - Global positioning system (GPS) fix data

Time, position and fix related data for a GPS receiver.

\$--GGA,hhmmss.ss,llll.lll,a,yyyyy.yyy,a,x,xx,x.x,x.x,M,x.x,M,x.x,xxxx\*hh<CR><LF>

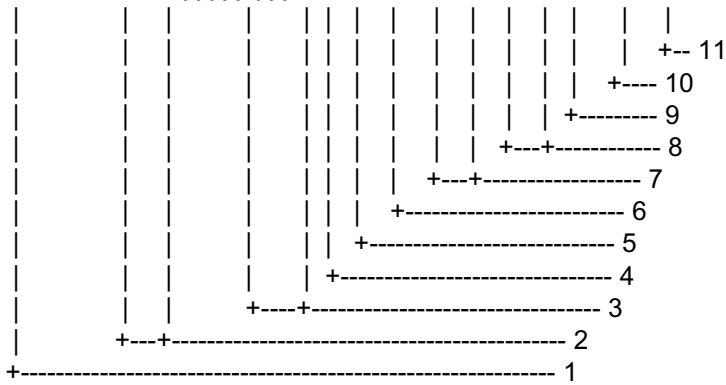

1. UTC of position (Not used.)
2. Latitude, N/S
3. Longitude, E/W
4. GPS quality indicator
5. Number of satellite in use,00-12, may be different from the number in view (Not used.)
6. Horizontal dilution of precision (Not used.)
7. Antenna altitude above/below mean sealevel, m (Not used.)
8. Geoidal separation, m (Not used.)
9. Age of differential GPS data (Not used.)
10. Differential reference station ID, 0000-1023 (Not used.)
11. Checksum

## GLL - Geographic position - latitude/longitude

Latitude and longitude of present vessel position, time of position fix and status.

\$--GLL,IIII.III,a,yyyyy.yyy,a,hhmmss.ss,A,a\*hh<CR><LF>

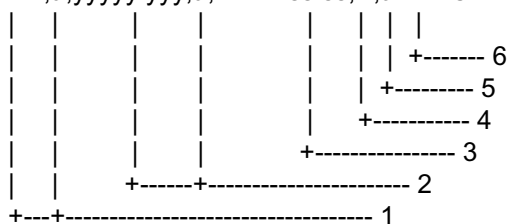

1. Latitude, N/S
2. Longitude, E/W
3. UTC of position (Not used.)
4. Status: A=data valid, V=data invalid
5. Mode indicator(see note)
6. Checksum

NOTE Positioning system Mode indicator:

- A = Autonomous
- D = Differential
- E = estimated(dead reckoning)
- M = Manual input
- S = Simulator
- N = Data not valid

The Mode indicator field supplements the Status field. The Status field shall be set to V=invalid for all values of Operating Mode except for A=Autonomous and D=Differential. The positioning system Mode indicator and Status field shall not be null fields.

**GNS - GNSS fixed data**

\$--GNS,hhmmss.ss,llll.lll,a,yyyyy.yyy,a,c--c,xx,x.x,x.x,x.x,x.x,x.x\*x\*hh<CR><LF>

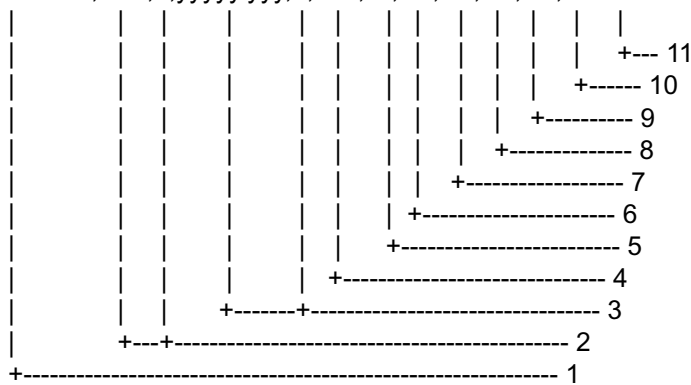

- 1. UTC of position (Not used.)
- 2. Latitude, N/S
- 3. Longitude, E/W
- 4. Mode indicator
- 5. Total number of satellite in use,00-99 (Not used.)
- 6. HDOP (Not used.)
- 7. Antenna altitude, metres, re:mean-sea-level(geoid) (Not used.)
- 8. Geoidal separation (Not used.)
- 9. Age of differential data (Not used.)
- 10. Differential reference station ID (Not used.)
- 11. Checksum

**HDT - Heading - true**

Actual vessel heading in degrees true produced by any device or system producing true bearing.

\$--HDT,x.x,T\*hh<CR><LF>

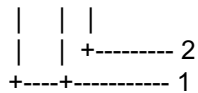

- 1. Heading, degrees true
- 2. Checksum



## LRF – Long-range function

This sentence is used in both long-range interrogation and long-range interrogation replies. The LRF-sentence is the second sentence of the long-range range interrogation request pair, LRI and LRF.

\$-LRF,x,xxxxxxxx,c--c,c--c\*hh<CR><LF>

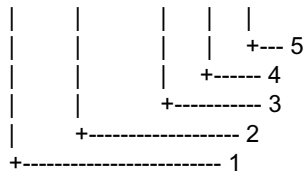

1. Sequence number, 0 to 9
2. MMSI of requestor
3. Name of requestor, 1 to 20 characters
4. Function, 1 to 26 characters
5. Checksum

## LRI – Long-range interrogation

The LRI-sentence contains the information that the AIS needs in order to determine if the reply sentences need to be constructed.

\$-LRI,x,a,xxxxxxxx,xxxxxxxx,IIII.II,a,yyyyy.yy,a,IIII.II,a,yyyyy.yy,a\*hh<CR><LF>

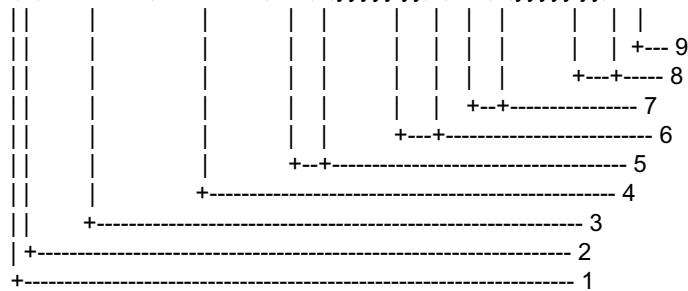

1. Sequence number, 0 to 9
2. Control Flag
3. MMSI of requestor
4. MMSI of destination
5. Latitude - N/S (north-east coordinate)
6. Longitude - E/W (north-east coordinate)
7. Latitude - N/S (south-west coordinate)
8. Longitude - E/W (south-west coordinate)
9. Checksum

## OSD - Own ship data

Heading, course, speed, set and drift summary. Useful for, but not limited to radar/ARPA application.

\$--OSD,x.x,A,x.x,a,x.x,a,x.x,x.x,a\*hh<CR><LF>

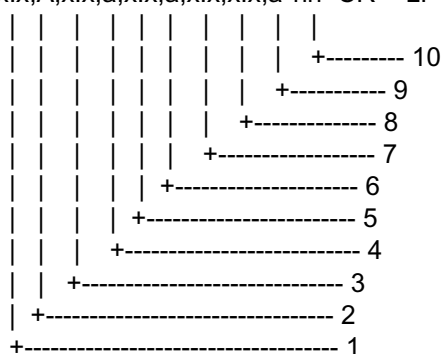

1. Heading, degrees true
2. Heading status: A=data valid, V=data invalid
3. Vessel course, degrees true
4. Course reference, B/M/W/R/P(see note)
5. Vessel speed
6. Speed reference, B/M/W/R/P(see note)
7. Vessel set, degrees true---Manually entered (Not used.)
8. Vessel drift(speed) ---Manually entered (Not used.)
9. Speed units, K(km/h) / N(Knots) / S(statute miles/h)
10. Checksum

NOTES - Reference systems(speed/course):

- B = bottom tracking log
- M = manually entered
- W = water referenced
- R = radar tracking(of fixed target)
- P = positioning system ground reference

### RMC - Recommended minimum specific GPS/TRANSIT data

Time, date, position, course and speed data provided by a GPS or TRANSIT navigation receiver. Checksum is mandatory in this sentence. This sentence is transmitted at intervals not exceeding 2 s and is always accompanied by RMB when a destination waypoint is active. RMC and RMB are the recommended minimum data to be provided by a GPS or TRANSIT receiver. All data fields must be provided, null fields used only when data is temporarily unavailable.

\$--RMC,hhmmss.ss,A,lll.lll,a,yyyy.yy,a,x.x,x.x,xxxxx,x.x,a\*hh<CR><LF>

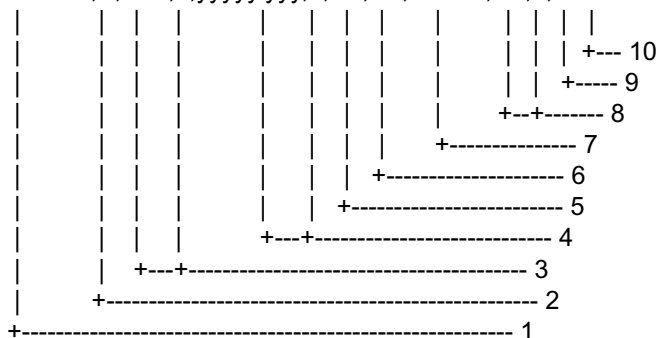

1. UTC of position fix (Not used.)
2. Status: A=data valid, V=navigation receiver warning
3. Latitude, N/S
4. Longitude, E/W
5. Speed over ground, knots
6. Course over ground, degrees true
7. Date: dd/mm/yy (Not used.)
8. Magnetic variation, degrees E/W (Not used.)
9. Mode indicator(see note)
10. Checksum

NOTE Positioning system Mode indicator:

- A = Autonomous
- D = Differential
- E = estimated(dead reckoning)
- M = Manual input
- S = Simulator
- N = Data not valid

The Mode indicator field supplements the Status field. The Status field shall be set to V=invalid for all values of Operating Mode except for A=Autonomous and D=Differential. The positioning system Mode indicator and Status field shall not be null fields.

### ROT - Rate of turn

Rate of turn and direction of turn.

\$--ROT,x.x,A\*hh<CR><LF>

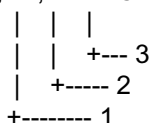

1. Rate of turn, deg/min, "-"=bow turns to port
2. Status: A=data valid, V=data invalid
3. Checksum

### SSD - UAIS ship static data

This sentence is used to enter static parameters into a shipboard AIS. The parameters in this sentence support a number of ITU-R M.1371 messages.

\$--SSD,c--c,c--c,xxx,xxx,xx,xx,c\*hh<CR><LF>

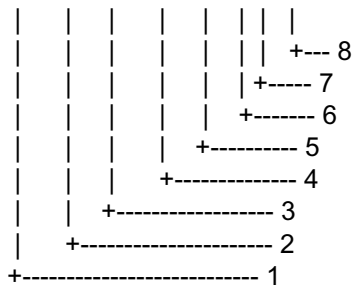

1. Ship's Call Sign, 1 to 7 characters
2. Ship'S Name, 1 to 20 characters
3. Pos. ref. point distance, "A," from bow, 0 to 511 Meters
4. Pos. ref. point distance, "B," from stern, 0 to 511 Meters
5. Pos. ref. point distance, "C," from port beam, 0 to 63 Meters
6. Pos. ref. point distance, "D," from starboard beam, 0 to 63 Meters
7. DTE indicator flag
8. Checksum

### VBW - Dual ground/water speed

\$--VBW,x.x,x.x,A,x.x,x.x,A,x.x,A,x.x,A\*hh<CR><LF>

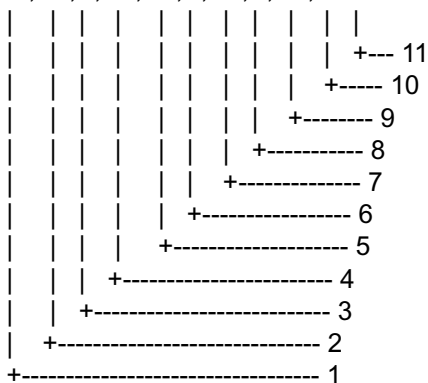

1. Longitudial water speed, knots
2. Transverse water speed, knots
3. Status: water speed, A=data valid V=data invalid
4. Longitudial ground speed, knots
5. Transverse ground speed, knots
6. Status: ground speed, A=data valid V=data invalid
7. Stern transverse water speed, knots
8. Status: stern water speed, A=data valid V=data invalid
9. Stern transverse ground speed, knots
10. Status: stern ground speed, A=data valid V=data invalid
11. Checksum

**VSD - UAIS voyage static data**

\$--VSD,x.x,x.x,x.x,c--c,hhmmss.ss,xx,xx,x.x,x.x\*hh<CR><LF>

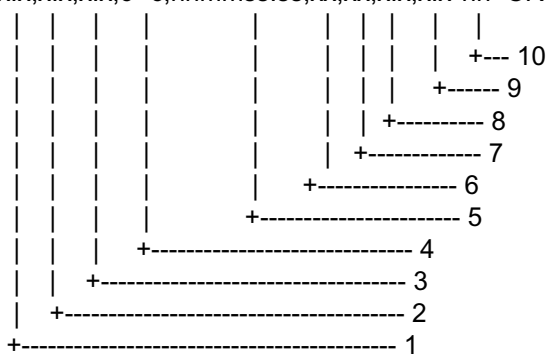

1. Type of ship and cargo category, 0 to 255
2. Maximum present static draught, 0 to 25.5 Meters
3. Persons on-board, 0 to 8191
4. Destination, 1-20 characters
5. Estimated UTC of arrival at destination
6. Estimated day of arrival at destination, 00 to 31(UTC)
7. Estimated month of arrival at destination, 00 to 12(UTC)
8. Navigational status, 0 to 15
9. Regional application flags, 0 to 15
10. Checksum

**VTG - Course over ground and ground speed**

The actual course and speed relative to the ground.

\$--VTG,x.x,T,x.x,M,x.x,N,x.x,K,a\*hh<CR><LF>

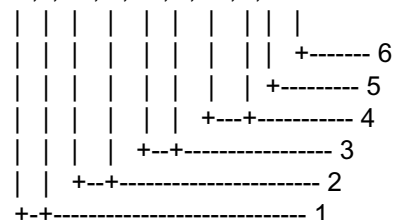

1. Course over ground, degrees true
2. Course over ground, degrees magnetic (Not used.)
3. Speed over ground, knots
4. Speed over ground, km/h
5. Mode indicator(see note)
6. CChecksum

NOTE Positioning system Mode indicator:

- A = Autonomous
- D = Differential
- E = estimated(dead reckoning)
- M = Manual input
- S = Simulator
- N = Data not valid

The positioning system Mode indicator field shall not be a null field.

**Output**

**ABK - UAIS addressed and binary broadcast acknowledgement**

The ABK-sentence is generated when a transaction, initiated by reception of an ABM, AIR or BBM sentence, is completed or terminated.

\$--ABK,xxxxxxxx,x,x.x,x,x\*hh<CR><LF>

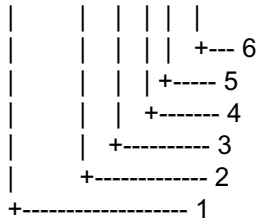

1. MMSI of the addressed AIS unit
2. AIS channel of reception
3. Message type
4. Message sequence number
5. Type of acknowledgement
6. Checksum

**ACA-** See “Input” section.

**ALR –Set alarm state**

\$--ALR,hhmmss.ss,xxx,A,A,c--c\*hh<CR><LF>

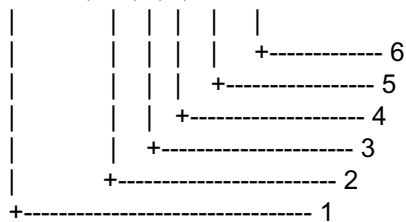

1. Time of alarm condition change, UTC
2. Local alarm number(identifier)
3. Alarm condition(A=threshold exceeded, V=not exceeded)
4. Alarm’s acknowledge state, A=acknowledged V=unacknowledged
5. Alarm’s description text
6. Checksum

**LRF – Long-range function**

See input section.

### LR1 - Long-range reply with destination for function request “A”

The LRI sentence identifies the destination for the reply and contains the information requested by the “A” function identification character.

\$--LR1,x,xxxxxxxx,xxxxxxxx,c--c,c--c,xxxxxxxx\*hh<CR><LF>

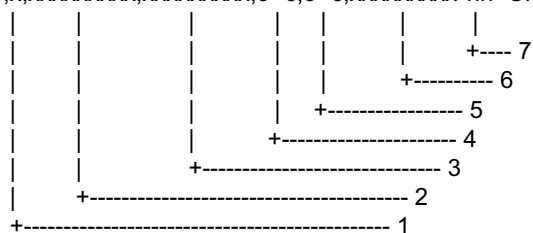

1. Sequence Number
2. MMSI of responder
3. MMSI of requestor(reply destination)
4. Ship's name, 1 to 20 characters
5. Call Sign, 1 to 7 characters
6. IMO Number, 9-digit number
7. Checksum

### LR2 - Long-range reply for function requests “B, C, E, and F”

The LR2-sentence contains the information requested by the “B, C, E and F” function identification characters.

\$--LR2,x,xxxxxxxx,xxxxxx,hhmmss.ss,lll.ll,a,yyyy.yy,a,x.x,T,x.x,N\*hh<CR><LF>

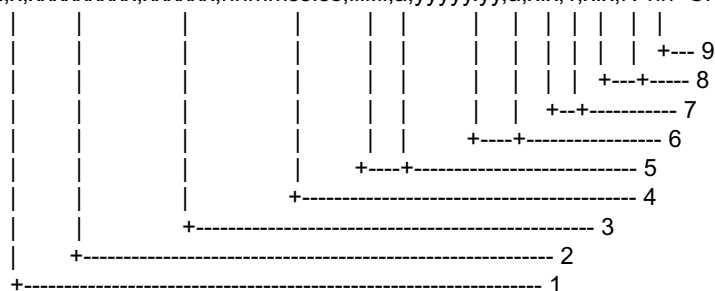

1. Sequence Number
2. MMSI of responder
3. Date: ddmmyy
4. UTC of Position
5. Latitude - N/S
6. Longitude - E/W
7. Course over ground, degrees True
8. Speed over ground, Knots
9. Checksum

**LR3- - Long-range reply for function requests “I, O, P, U and W”**

The LR3-sentence contains the information requested by the “I, O, P, U and W” function identification characters.

\$--LR3,x,xxxxxxxx,c--c,xxxxxx,hhmmss.ss,x.x,cc,x.x,x.x,cc,x.x\*hh<CR><LF>

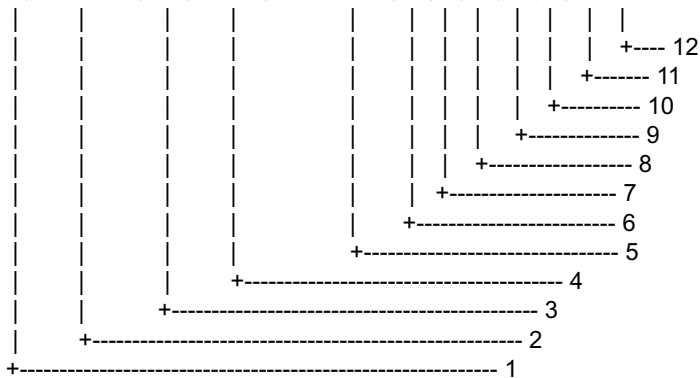

1. Sequence Number
2. MMSI of responder
3. Voyage destination, 1 to 20 characters
4. ETA Date: ddmmyy
5. ETA Time
6. Draught
7. Ship/cargo(ITU-R M.1371, Table 18)
8. Ship length
9. Ship breadth
10. Ship type(ITU-R M.1371, Table 18)
11. Persons, 0 to 8191
12. Checksum

**TXT - Text transmission**

\$--TXT,xx,xx,xx,c--c\*hh<CR><LF>

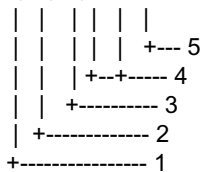

1. Total number of message, 01 to 99
2. Message number, 01 to 99
3. Text identifier
4. Text Message
5. Checksum



## VDM – VHF data-link message

This sentence is used to transfer the entire contents of a received AIS message packet, as defined in ITU-R M.1371 and as received on the VHF Data Link (VDL), using the “6-bit” field type.

```
!--VDM,x,x,x,x,s--s,x*hh<CR><LF>
```

```

| | | | | | |
| | | | | | | +--- 7
| | | | | | | +---- 6
| | | | | | | +----- 5
| | | | | | | +----- 4
| | | | | | | +----- 3
| | | | | | | +----- 2
| | | | | | | +----- 1

```

1. Total number of sentences needed to transfer the message, 1 to 9
2. Message sentence number, 1 to 9
3. Sequential message identifier, 0 to 9
4. AIS channel Number
5. Encapsulated ITU-R M.1371 radio message
6. Number of fill-bits, 0 to 5
7. Checksum

## VDO - UAIS VHF data-link own-vessel report

```
!--VDO,x,x,x,x,s--s,x*hh<CR><LF>
```

```

| | | | | | |
| | | | | | | +--- 7
| | | | | | | +---- 6
| | | | | | | +----- 5
| | | | | | | +----- 4
| | | | | | | +----- 3
| | | | | | | +----- 2
| | | | | | | +----- 1

```

1. Total number of sentences needed to transfer the message, 1 to 9
2. Message sentence number, 1 to 9
3. Sequential message identifier, 0 to 9
4. AIS channel Number
5. Encapsulated ITU-R M.1371 radio message
6. Number of fill-bits, 0 to 5
7. Checksum

# SPECIFICATIONS OF THE U-AIS TRANSPONDER FA-100

The AIS shall improve the safety of navigation by assisting in the efficient navigation of ship's, protection of the environment, and operation of Vessel Traffic Services (VTS), by the functions of collision avoidance, ships' and cargo's information obtaining, and traffic management.

## 1 GENERAL

- |     |                 |   |
|-----|-----------------|---|
| 1.1 | Display         | Monochrome STN-LCD, 60 (H) x 95 (W) mm, 120 x 64 dots |
| 1.2 | TX/RX Frequency | 156.025 MHz to 162.025 MHz                            |
| 1.3 | Output Power    | 2 W/ 12.5 W or 0W exchangeable                        |
| 1.4 | Impedance       | 50 ohms   |
| 1.5 | DSC Receiver    | CH70 fixed, 156.525 MHz, G2B, 1200 bps                |
| 1.6 | Band Width      | 25 kHz/ 12.5 kHz                                      |

## 2 TRANSPONDER UNIT

- |     |      |   |
|-----|------|---|
| 2.1 | CPU  | SH7709A, 76.0 MHz   |
| 2.2 | ROM  | Flash ROM 1 MW  |
| 2.3 | Menu | Target data/ Plotter/ Own data/ Set MSG/ Init Settings/<br>System Settings/ Diagnostics |

## 3 GPS RECEIVER

- |     |                          |   |
|-----|--------------------------|---|
| 3.1 | Receiving Channels       | 12 channels parallel, 12 satellites tracking  |
| 3.2 | Rx Frequency/ Rx Code    | 1575.42 MHz, C/A code   |
| 3.3 | Position Fixing System   | All in view, 8-state Kalman filter  |
| 3.4 | Position Accuracy        | Approx. 10 m, 95% of the time, (HDOP 4)<br>DGPS: approx. less than 5 m, 95% of the time |
| 3.5 | Tracking Velocity        | 900 kts   |
| 3.6 | Position-fixing Time     | Warm start: 12 seconds, Cold start: 90 seconds  |
| 3.7 | Position Update Interval | 1 second  |
| 3.8 | DGPS Data Receiving      | RTCM SC-104 Ver 2.1 formatted   |

## 4 INTERFACES

- |     |  |   |
|-----|--|---|
| 4.1 | Sensor 1/ 2/ 3 (IEC61162-1/2)                    |   |
|     | Input:   | DTM, GNS, GLL, GGA, RMC, VBW, VTG, OSD, HDT, GBS,<br>ROT (GN>GP>GL>LC)                                |
| 4.2 | PC I/O, EXTRA1, LR or ECDIS/RADAR (IEC61162-1/2) |   |
|     | Input:   | VSD, SSD, ABM, BBM, ACA, ACK, AIR, DTM, GBS, GGA, GLL,<br>GNS, HDT, LRF, LRI, OSD, RMC, ROT, VBW, VTG |
|     | Output:  | VDM, VDO, ABK, ACA, ALR, TXT, LR1, LR2, LR3, LRF, LRI   |
| 4.3 | Alarm  | Contact Closure   |
| 4.4 | LAN (10base-T)                                   | IEC61162-4  |
| 4.5 | AD-10  | AD-10 format  |

## **5 POWER SUPPLY**

- 5.1 Transponder Unit            12-24 VDC: 7-3.5 A
- 5.2 AC/DC Power Supply Unit (PR-240, option)    100-115/200-230 VAC, 1 phase, 50/60 Hz

## **6 ENVIRONMENTAL CONDITION**

- 6.1 Ambient Temperature
  - GPS Antenna Unit:    -25°C to +70°C
  - Other units:            -15°C to +55°C
- 6.2 Relative Humidity        95% at 40°C
- 6.3 Waterproof (IEC 61529)
  - Antenna Unit:            IPX6
  - Other units:            IPX0
- 6.4 Vibration                 IEC 60945 ed.3

## **7 COATING COLOR**

- 7.1 GPS Antenna Unit:        N9.5
- 7.2 Other units:              2.5GY5/1.5

# INDEX

---

<b>A</b>		
Alarm status .....	34	
<b>B</b>		
Battery replacement.....	28	
Brilliance .....	3	
Buzzer .....	25	
<b>C</b>		
Channels		
setting .....	23	
viewing.....	22	
Contrast .....	3	
Controls.....	1	
CPA/TCPA range .....	7	
<b>D</b>		
Dangerous targets .....	14	
Destination.....	7	
Diagnostics		
GPS test.....	33	
keyboard test .....	31	
LCD test.....	32	
memory test .....	31	
on/off history .....	32	
program no.....	30	
Digital interface .....	AP-7	
Draught .....	7	
Dynamic data .....	17	
<b>G</b>		
GPS monitor .....	36	
GPS test.....	33	
<b>K</b>		
Keyboard test.....	31	
<b>L</b>		
LCD test.....	32	
Long range mode .....	26	
<b>M</b>		
Maintenance.....	27	
Memory clear.....	38	
Memory test.....	31	
Menu tree .....	AP-1	
Messages		
logs .....	21	
sending .....	18	
<b>N</b>		
Navigation status.....	7	
<b>O</b>		
On/off history .....	32	
<b>P</b>		
Parts location.....	AP-4	
Plotter display.....	11	
POWER key .....	2	
Program no.....	30	
Program number record .....	vi	
<b>S</b>		
Sensor status.....	37	
Ship type and crew.....	7	
Static data.....	15	
System configuration.....	v	
System overview .....	vii	
<b>T</b>		
Target data.....	12	
Troubleshooting.....	28	

# FURUNO®

**FURUNO ELECTRIC CO., LTD.**9-52 Ashihara-Cho, Nishinomiya City, 662-8580, Hyogo, Japan  
Tel: +81 798-65-2111 Fax: +81 798-65-4200

Pub NO. DOC-481

## Declaration of Conformity

We FURUNO ELECTRIC CO., LTD.

(Manufacturer)

9-52 Ashihara-Cho, Nishinomiya City, 662-8580, Hyogo, Japan

(Address)

declare under our sole responsibility that the product

Universal Automatic Identification System (U-AIS) transponder Model FA-100

(Model name, serial number)

is in conformity with the essential requirements as described in the Directive 1999/5/EC of the European Parliament and of the Council of 9 March 1999 on radio equipment and telecommunications terminal equipment (R&TTE Directive) and satisfies all the technical regulations applicable to the product within this Directive

EN 60945: 1997-01 (IEC 60945 Third edition: 1996-11)

EN 61993-2: 2002-03 (IEC 61993-2: 2001-12)

EN 60950: 2000 (IEC 60950 Third edition: 1999-04)

(title and/or number and date of issue of the standard(s) or other normative document(s))

For assessment, see

- Statement of Opinion N° 02214129/AA/00 of 2 July 2002 issued by Telefication, The Netherlands
- Maritime test report 99321030 of 29 April 2002 prepared by Telefication, The Netherlands
- Test Report FLI 12-02-001 of 10 May 2002 and Safety Test Report FLI 12-02-009 of 10 May 2002 prepared by Furuno Labotech International Co., Ltd.

On behalf of Furuno Electric Co., Ltd.

Hiroaki Komatsu

Manager,

International Rules and Regulations

Nishinomiya City, Japan

July 26, 2002

(Place and date of issue)

(name and signature or equivalent marking of authorized person)