

FURUNO

FA-50

CLASS B AIS TRANSPONDER



OPERATOR'S MANUAL



FURUNO ELECTRIC CO., LTD.

www.furuno.co.jp

ECF

(Elemental Chlorine Free)

The paper used in this manual
is elemental chlorine free.

FURUNO ELECTRIC CO., LTD.

9-52 Ashihara-cho,
Nishinomiya, 662-8580, JAPAN

Telephone : +81-(0)798-65-2111

Fax : +81-(0)798-65-4200

• FURUNO Authorized Distributor/Dealer

All rights reserved.

Printed in Japan

Pub. No. OME-44420-B

(TATA) FA-50

A : MAR . 2008

B : JUN . 18, 2008



* 0 0 0 1 6 8 4 1 4 1 1 *



IMPORTANT NOTICES



- The descriptions in this manual are intended for readers with a solid knowledge of English.
- No part of this manual may be copied or reproduced without written permission.
- If this manual is lost or worn, contact your dealer about replacement.
- The contents of this manual and equipment specifications are subject to change without notice.
- The example screens (or illustrations) shown in this manual may not match the screens you see on your display. The screen you see depends on your system configuration and equipment settings.
- Store this manual in a convenient place for future reference.
- FURUNO will assume no responsibility for the damage caused by improper use or modification of the equipment (including software) by an unauthorized agent or a third party.
- When it is time to discard this product it must be done according to local regulations for disposal of industrial waste. For disposal in the USA, refer to the Electronics Industries Alliance (<http://www.eiae.org/>).









SAFETY INSTRUCTIONS



The operator and installer must read the applicable safety instructions before attempting to install or operate the equipment.

 WARNING	Indicates a potentially hazardous situation which, if not avoided, could result in death or serious injury.
 CAUTION	Indicates a potentially hazardous situation which, if not avoided, can result in minor or moderate injury.





 Warning, Caution	 Prohibitive Action	 Mandatory Action
----------------------------------------------------------------------------------------------------	------------------------------------------------------------------------------------------------------	------------------------------------------------------------------------------------------------------

Safety instructions for the operator



 WARNING	
	Do not open the shield cover. Only qualified personnel should work inside the equipment.
	Do not disassemble or modify the equipment. Fire, electrical shock or serious injury can result.
	Immediately turn off the power at the power source if <ul style="list-style-type: none"> • water leaks into the equipment • something is dropped into the equipment • the equipment is emitting smoke or is on fire • the equipment is emitting strange noises <p>Continued use of the equipment can cause fire or electrical shock. Contact a FURUNO dealer or agent for service.</p>
	Do not operate the equipment with wet hands. Electrical shock can result.
	Use the proper fuse. Use of the wrong fuse can cause fire or electrical shock.

 WARNING	
	Do not place liquid-filled containers on the top of the equipment. Fire or electrical shock can result if a liquid spills into the equipment.
	Make sure no rain or water splash leaks into the equipment. Fire or electrical shock can result if water leaks into the equipment.

Warning labels are attached to the equipment. Do not remove these labels. If a label is missing or illegible, contact a FURUNO agent or dealer replacement.





 WARNING 
To avoid electrical shock, do not remove cover. No user-serviceable parts inside.
 

Name: Warning Label (1)
Type: 86-003-1011-1
Code No.: 100-236-232-10

 WARNING 
To avoid electrical shock, do not remove cover. No user-serviceable parts inside.

Name: Warning Label (2)
Type: 86-129-1001-1
Code No.: 100-236-742-10

Safety instructions for the installer

 WARNING	
	<p>ELECTRICAL SHOCK HAZARD Do not open the equipment unless totally familiar with electrical circuits and service manual.</p> <p>Only qualified personnel should work inside the equipment.</p>
	<p>Turn off the power at the switchboard before beginning the installation.</p> <p>Fire or electrical shock can result if the power is left on.</p>
	<p>Do not install the equipment where it may get wet from rain or water splash.</p> <p>Water in the equipment can result in fire, electrical shock or damage to the equipment.</p>
	<p>Be sure that the power supply is compatible with the voltage rating of the equipment.</p> <p>Connecting an incompatible power supply can cause fire or damage the equipment. The voltage rating appears on the inlet of power.</p>



 CAUTION		
	<p>Observe the following compass safe distances to prevent interference to a magnetic compass:</p>	
	Standard compass	Steering compass
FA-50	0.30 m	0.30 m
PR-240	0.90 m	0.60 m
GVA-100-T	0.30 m	0.30 m
DB-1	0.30 m	0.30 m

TABLE OF CONTENTS

FOREWORD	v
SYSTEM CONFIGURATIONS	vii
1. INSTALLATION	1-1
1.1 Equipment List	1-1
1.2 AIS Transponder FA-50	1-3
1.3 VHF Antenna.....	1-3
1.4 GPS Antenna	1-5
1.5 GPS/VHF Combined Antenna.....	1-7
1.6 AC-DC Power Supply (option)	1-9
1.7 Wiring.....	1-10
1.8 Setting and Adjustments	1-12
1.8.1 COM PORT setup, Network setup	1-12
1.8.2 Ship static.....	1-15
2. OPERATION	2-1
2.1 AIS Transponder FA-50	2-1
2.2 Messages.....	2-2
2.2.1 Sending a message	2-2
2.2.2 Confirming receiving messages	2-3
2.3 Own Vessel Data Display.....	2-4
2.4 Alarm Status.....	2-7
2.5 Sensor Status.....	2-8
3. MAINTENANCE, TROUBLESHOOTING3-1	
3.1 Maintenance.....	3-1
3.2 Replacing the Fuse	3-2
3.3 Troubleshooting	3-2
3.4 Diagnostics.....	3-3
APPENDIX 1 MENU TREE	AP-1
APPENDIX 2 VHF CHANNEL LISTS.....	AP-2
APPENDIX 3 PARTS LIST, LOCATIONS	AP-4
APPENDIX 4 DIGITAL INTERFACE.....	AP-6
PACKING LISTS.....	A-1
SPECIFICATIONS	SP-1
OUTLINE DRAWINGS.....	D-1
INTERCONNECTION DIAGRAM	S-1
INDEX.....	IN-1

FOREWORD

A Word to the Owner of the FA-50

Congratulations on your choice of the FURUNO FA-50 AIS Transponder. We are confident you will see why the FURUNO name has become synonymous with quality and reliability.

For 60 years FURUNO Electric Company has enjoyed an enviable reputation for quality marine electronics equipment. This dedication to excellence is furthered by our extensive global network of agents and dealers.

This equipment is designed and constructed to meet the rigorous demands of the marine environment. However, no machine can perform its intended function unless operated and maintained properly. Please carefully read and follow the recommended procedures for operation and maintenance.

Thank you for considering and purchasing FURUNO equipment.

Features

The FA-50 is a Class B AIS (Automatic Identification System) capable of exchanging navigation and ship data between own ship and other ships or coastal stations. It complies with IMO MSC. 140(76) Annex 3, A.694, ITU-R M.1371-2 and DSC ITU-R M.825-3 It also complies with IEC 60945 (EMC and environmental conditions).

FA-50 consists of VHF and GPS antennas, a transponder unit and several associated units. The transponder contains a VHF transmitter, two TDMA receivers on two parallel VHF channels, interface, communication processor, and internal GPS receiver. The internal GPS is a 12-channel all-in-view receiver with a differential capability. It also gives position, COG and SOG when the external GPS. FA-50 receives DSC, time-sharing with TDMA receiver.

The main features are:

- Safety of navigation by automatically exchanging navigational data
- Static data
 - MMSI (Maritime Mobile Service Identity)
 - Call sign & Ship's name
 - Type of ship
 - Location of position-fixing antenna on the ship
- Dynamic data
 - Ship's position with accuracy indication and integrity status
 - Universal Time Coordinated (UTC)
 - Course over ground (COG)
 - Speed over ground (SOG)
 - Heading
- Voyage-related data
 - Hazardous cargo (type)
- Short safety-related messages, pre-set messages

FOREWORD

- Interfaces for radar, PC for future networking expansion
- GPS/VHF combined antenna for easy installation available
- Built-in GPS receiver for position-fixing device

Program Version

Item	Program No.	Version No.	Date
FA-50 AIS Transponder Main Program	0550233	01.**	July 2007

** : Minor change

SYSTEM CONFIGURATIONS

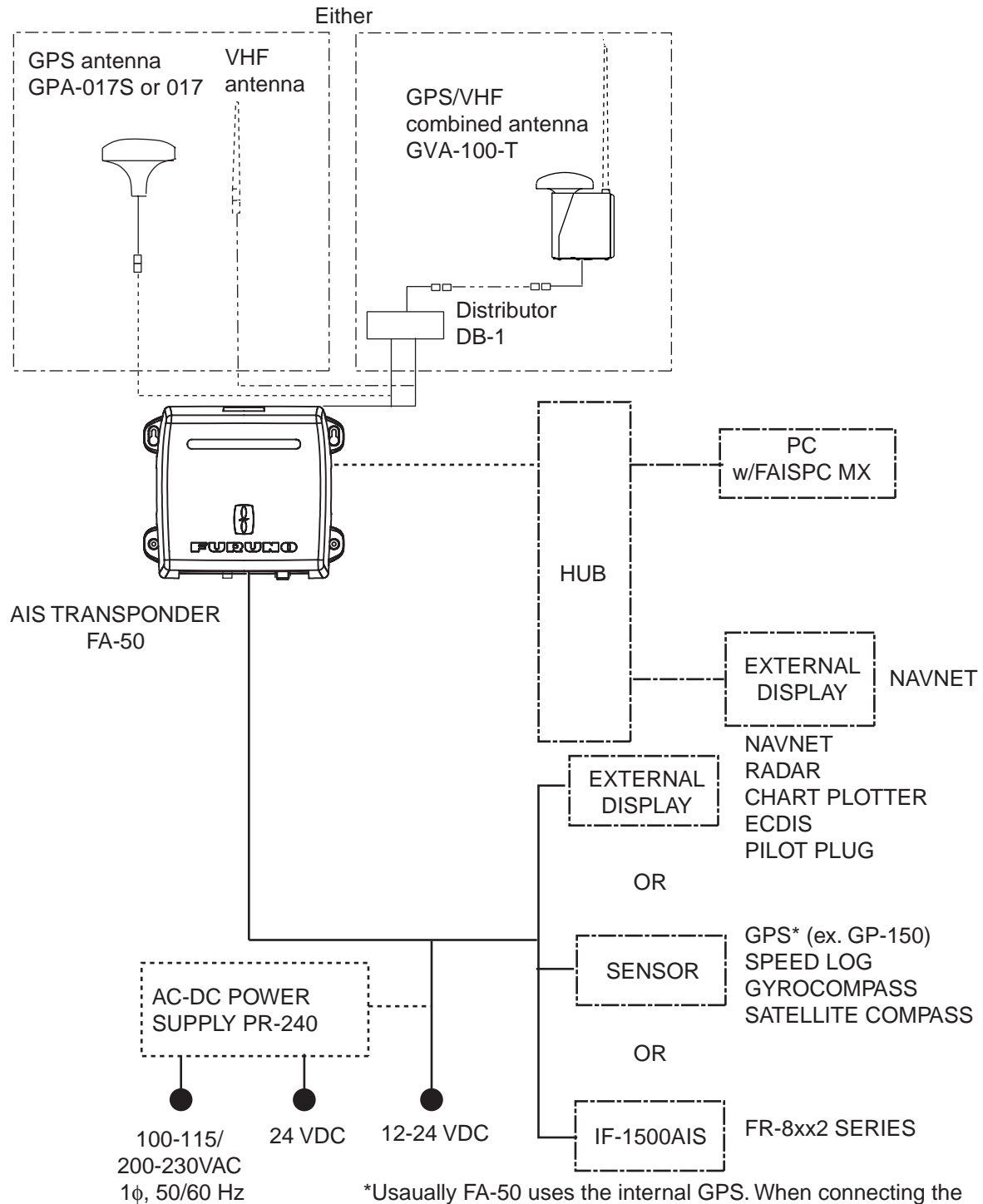

- : Standard supply
- : Optional supply
- - - - - : Local supply

*Usually FA-50 uses the internal GPS. When connecting the external GPS, use one which satisfies the following points.

- 1) Outputs DTM sentence (WGS-84 can be chosen.)
- 2) Outputs GBS sentence.
- 3) Outputs sentences with the mode indicator;

GNS: Ver.3.0 and later

GLL: Ver.2.0 and later

GGA: Ver.2.0 and later

RMC: Ver.1.5 and later

GPS navigator GP-150 meets with requirements shown above.

This page is intentionally left blank.

1. INSTALLATION

1.1 Equipment List

Standard supply

Name	Type	Code No.	Qty	Remarks
AIS transponder	FA-50	-	1	
Antenna unit	GVA-100	-	1	GPS/VHF combined
	GPA-017S	-	1 set	GPS antenna
	GPA-017	-	1 set	GPS antenna w/10 m cable
Distributor	DB-1	-	1	For GVA-100
Spare parts	SP05-05801	001-031-960	1 set	4A fuses (Type: FGMB 125V 4A, Code No.: 000-157-482-10)
Accessories	FP05-06110	000-166-648	1 set	FAISPC-MX for PC
Installation materials	CP24-00502	005-955-560	1 set	For GPA-017S
	CP05-11401	001-031-970	1 set	For FA-50, self-tapping screws (Type: 4x20, Code No.: 000-158-850-10)
	TNC-PS/PS-3D-L15M-R	000-133-670-11	1	For GPA-017S, 15 m cable
	CP24-00101	005-950-730	1 set	For DB-1, self-tapping screws (Type: 4x30, Code No.: 000-162-659-10)

1. INSTALLATION

Optional supply

Name	Type	Code No.	Qty	Remarks
AC-DC power supply	PR-240-CE	-	1	
Whip antenna	CP05-11001	001-034-670	1	For outside Japan
Antenna cable set	CP20-02700	004-381-160	1	For GPA-017S
	CP20-02710	004-381-170	1	For GPA-017S
	CP24-00300	000-041-938	1	For GVA-100
	CP24-00310	000-041-939	1	For GVA-100
Coaxial cable	TNC-PS/PS-3D-L15M-R	000-133-670-11	1	TNC-TNC, 15 m
Right-angle antenna base	No.13-QA330	000-803-239	1	For GPA-017/S
L-angle antenna base	No.13-QA310	000-803-240	1	For GPA-017/S
Antenna base for rail mount	No.13-RC5160	000-806-114	1	For GPA-017/S
Mast mount fixture	CP20-01111	004-365-780	1	For GPA-017/S
AIS viewer	FAISPC-MX50	000-160-966	1	
LAN cable	P5E-4PTX-BL L=2M	000-164-634-10	1	2 m
	P5E-4PTX-BL L=10M	000-164-637-10	1	10 m
Cable assy	MJ-A6SPF0017-010C	000-159-704-11	1	For NavNet VX2, 1 m
	MJ-A6SPF0017-050C	000-159-705-11	1	For NavNet VX2, 5 m
	MJ-A6SPF0017-100C	000-159-706-11	1	For NavNet VX2, 10 m
	MJ-A6SPF0017-200C	000-159-707-11	1	For NavNet VX2, 20 m
	MJ-A6SPF0017-300C	000-159-708-11	1	For NavNet VX2, 30 m

Note: One FA-50 can be installed on a network.

1.2 AIS Transponder FA-50

Mounting considerations, mounting

The FA-50 can be mounted on a desktop, deck or on a bulkhead. When selecting a mounting location, keep the following points in mind:

- The temperature and humidity should be moderate and stable.
- Locate the unit away from exhaust pipes and vents.
- The mounting location should be well ventilated.
- Mount the unit where shock and vibration are minimal.
- Keep the unit away from electromagnetic field-generating equipment such as motors and generators.
- A magnetic compass will be affected if the FA-50 is placed too close to it. Observe the compass safe distances noted in the safety instructions to prevent disturbance to the magnetic compass.

Fix the unit to the mounting location with 4x20 self-tapping screws (supplied).

1.3 VHF Antenna

Location

The location of the AIS VHF-antenna should be carefully considered. Digital communication is more sensitive than analog/voice communication to interference created by reflections in obstructions like masts and booms. It may be necessary to relocate the VHF radiotelephone antenna to minimize interference effects. To minimize interference effects, the following guidelines apply:

- The AIS VHF antenna should be placed in an elevated position that is as free as possible with a minimum of 0.5 meters in the horizontal direction from constructions made of conductive materials. The antenna should not be installed close to any large vertical obstruction. The objective for the AIS VHF antenna is to see the horizon freely through 360 degrees.
- There should not be more than one antenna on the same plane. The AIS VHF antenna should be mounted directly above or below the ship's primary VHF radiotelephone antenna, with no horizontal separation and with a minimum of 2.8 meters vertical separation. If it is located on the same plane as other antennas, the distance apart should be at least 10 meters.
- Install the VHF whip antenna (option) referring to the outline drawing at the back of this manual. Separate this antenna from other VHF radiotelephone antennas as shown below to prevent interference to the FA-50.

1. INSTALLATION

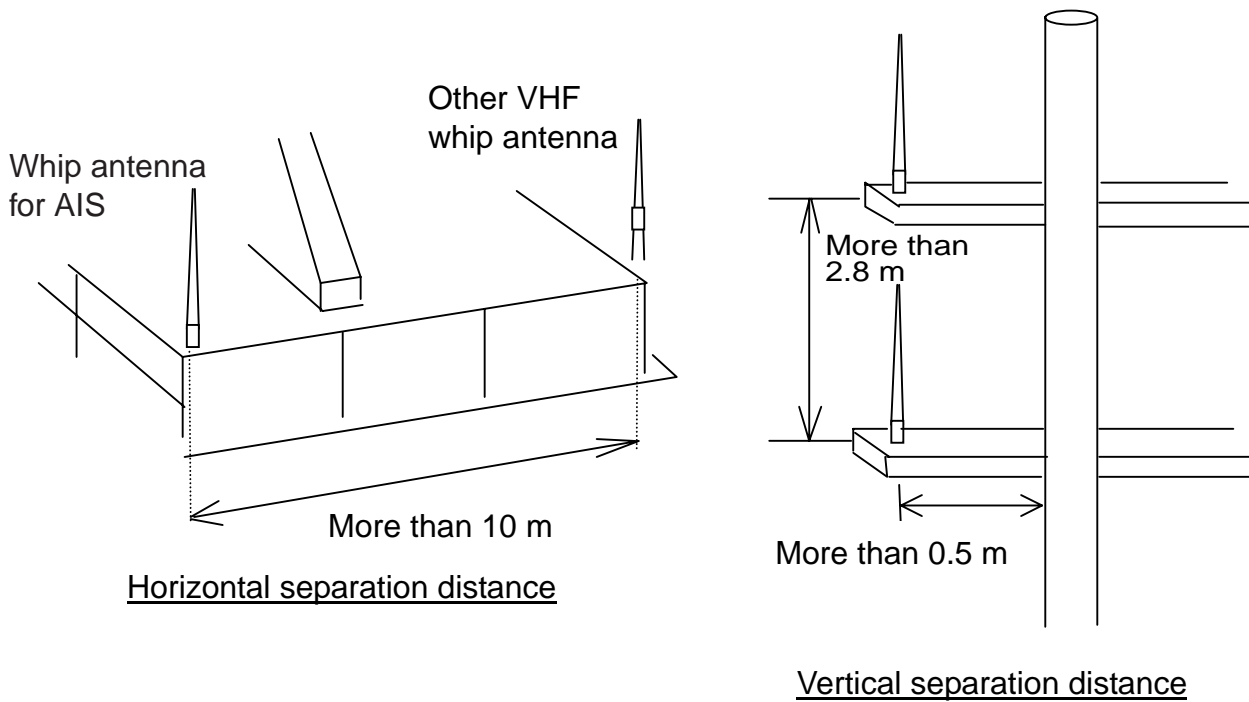

Cabling

- Use coaxial cable type 5D-2V or the equivalent.
- The cable should be kept as short as possible to minimize signal attenuation, and the maximum length is 50 meters.
- All outdoor-installed connectors on coaxial cables should be fitted with preventive isolation such as vulcanizing tape to protect against water penetration into the antenna cable.
- Coaxial cables should be installed in separate signal cable channels/tubes and at least 10 cm away from power supply cables. Crossing of cables should be done at right angles (90 degrees). The minimum bend radius of the coaxial cable should be 5 times the cable's outer diameter.

1.4 GPS Antenna

Install the GPS antenna unit referring to the outline drawing at the back of this manual. When selecting a mounting location for the antenna, keep in mind the following points.

- Select a location out of the radar beam. The radar beam will obstruct or prevent reception of the GPS satellite signal.
- There should be no interfering object within the line-of-sight to the satellites. Objects within line-of-sight to a satellite, for example, a mast, may block reception or prolong acquisition time.
- Mount the antenna unit as high as possible to keep it free of interfering objects and water spray, which can interrupt reception of GPS satellite signal if the water freezes.

Extending antenna cable

Three types of antenna cable extensions are optionally available.

- Antenna cable set CP20-02700

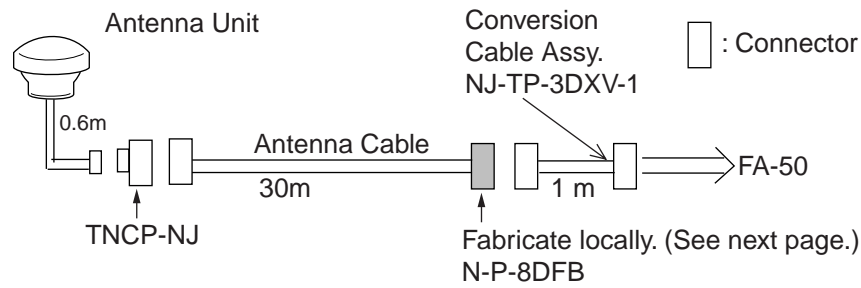

Waterproofing connector

Wrap connector with vulcanizing tape and then vinyl tape. Bind the tape end with a cable-tie.

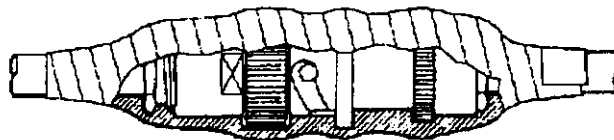

- Antenna cable set CP20-02710 (8D-FB-CV, 50 m)
- Connect the cable the same as 1) above.

Note: The length of this cable should be less than 20 m to prevent signal loss. The coax. coupling cable assy.(type: NJ-TP-3DXV-1, code no. 000-123-809), coaxial connector (N-P-8DFB; supplied), vulcanizing tape and vinyl tape are required. Fabricate both ends of the cable as shown in the figure on the next page.

1. INSTALLATION

How to attach the connector N-P-8DFB for cable 8D-FB-CV

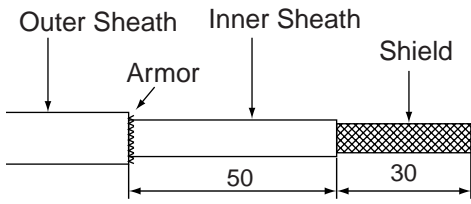

Remove outer sheath and armor by the dimensions shown left.
Expose inner sheath and shield by the dimensions shown left.

Cover with heat-shrink tubing and heat.

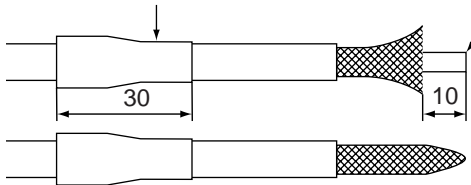

Cut off insulator and core by 10mm from its end.

Twist shield end.

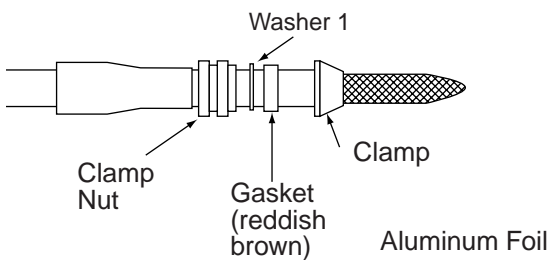

Slip on clamp nut, washer 1, gasket and clamp as shown left. If it is difficult to slip the clamp onto the cable, use a file to enlarge the inner diameter of the clamp.

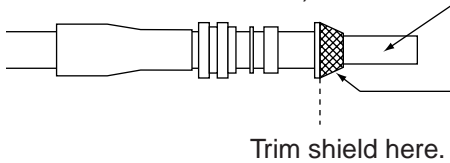

Fold back shield over clamp and trim.

Trim shield here.

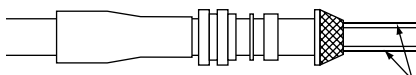

Cut aluminum foil at four places, 90° from one another.

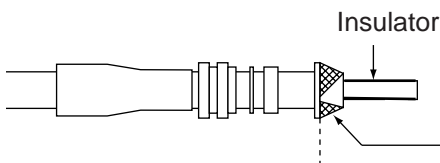

Fold back aluminum foil onto shield and trim.

Trim aluminum tape foil here.

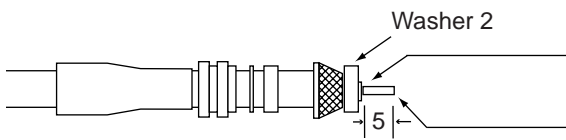

Slit the washer 2, and trim insulator at the end of the washer 2.

Expose the core by 5mm.

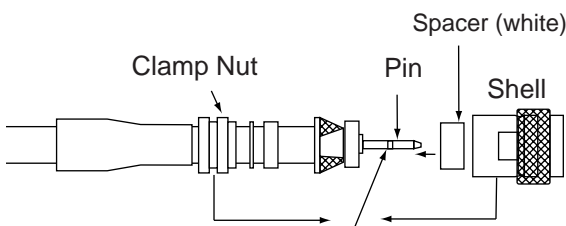

Slip the pin onto the conductor. Solder them together through the hole on the pin.

Insert the pin into the spacer (white) and shell. Screw the clamp nut into the shell. (Tighten by turning the clamp nut. Do not tighten by turning the shell.)

Solder through the hole.

1.5 GPS/VHF Combined Antenna

Install the combined antenna unit referring to the outline drawing. When selecting a mounting location for the antenna, keep in mind the following points.

- Select a location out of the radar beam. The radar beam will obstruct or prevent reception of the GPS satellite signal.
- There should be no interfering object within the line-of-sight to the satellites. Objects within line-of-sight to a satellite, for example, a mast, may block reception or prolong acquisition time.
- Mount the antenna unit as high as possible. Mounting it this way keeps it free of interfering objects and water spray, which can interrupt reception of GPS satellite signal if the water freezes.

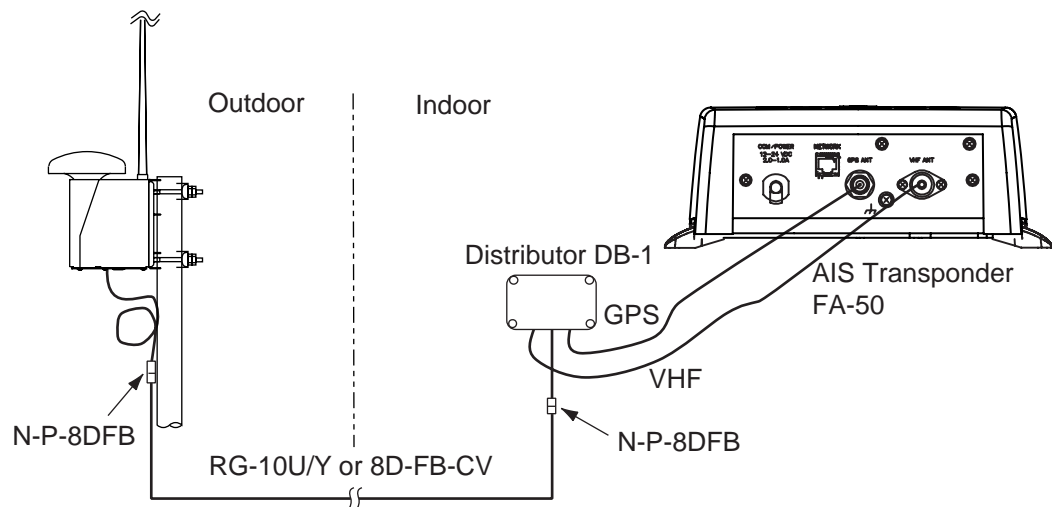

Installation overview of GPS/VHF combined antenna

Mounting procedure

1. Dismount the bottom cover, cut the cable-tie inside the unit and take out the coaxial connector attached to the combined box.
2. Loosen four screws to loosen whip antenna fixture and pull out the coaxial connector coming from the combined box through the hole in the whip antenna fixture.
3. Connect the coaxial connector to the whip antenna base and wrap the junction part of the whip antenna with vulcanizing tape and then vinyl tape for waterproofing.
4. Insert the whip antenna from the top of the combined antenna.
5. Secure the whip antenna with whip antenna fixture.
6. Using a new plastic band (supplied), secure the cables and coaxial connector inside the antenna case.
7. Mount the bottom cover.
8. Fix the GPS/VHF combined antenna to the ship's stanchion (40 to 50 mm diameter) with antenna fixing brackets, flat washers and hex. nuts. For 60 to 80 mm diameter stanchion, the mast fixing kit (Type: OP24-5, Code No.: 005-954-510) is necessary.

Note: Coat the exposed parts of bolts and nuts with silicon sealant.

1. INSTALLATION

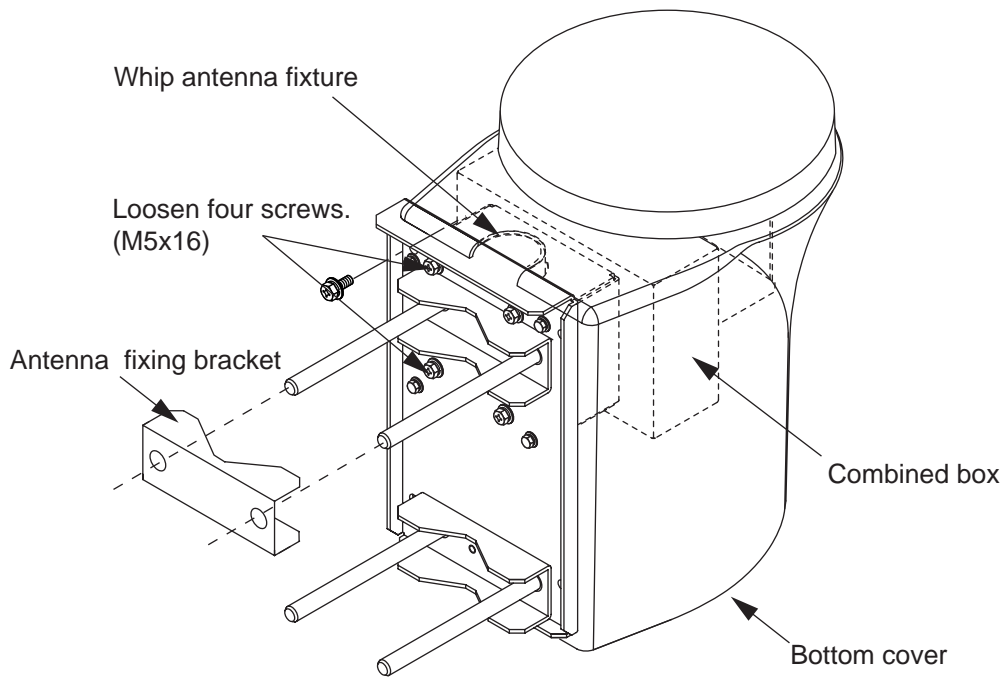

GPS/VHF combined antenna

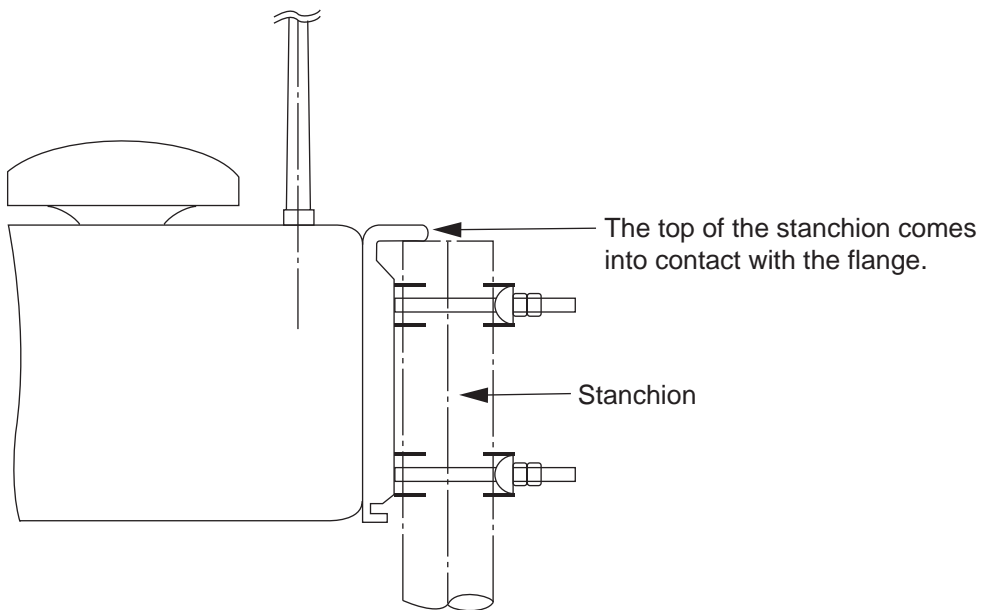

Installing distributor DB-1

The length of the cable between the distributor and transponder is 1 m so locate the distributor within 1 m from the transponder. Fix the distributor on the bulkhead, facing the cable entrance downward. Remove the lid of the distributor and secure the distributor with two self-tapping screws.

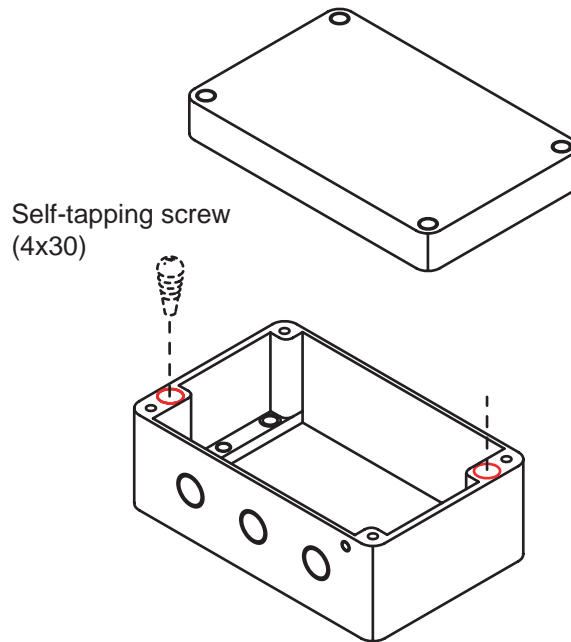

Note: Be sure no foreign material or water enters the distributor.

1.6 AC-DC Power Supply (option)

When selecting a mounting location for the unit, keep the following in mind:

- Keep the unit out away from areas subject to water splash.
- Locate the unit away from exhaust pipes and vents.
- The mounting location should be well ventilated.
- Mount the unit where shock and vibration are minimal.
- A magnetic compass will be affected if the unit is placed too close to it. Observe the following compass safe distances to prevent disturbance to the magnetic compass:
 - Steering compass: 0.6 m
 - Standard compass: 0.9 m

Fix the unit with four self-tapping screws (4x16) to a desktop or the deck. It is not necessary to open the cover.

1. INSTALLATION

1.7 Wiring

Connect power source, LAN cable, VHF antenna and ground wire as shown below.

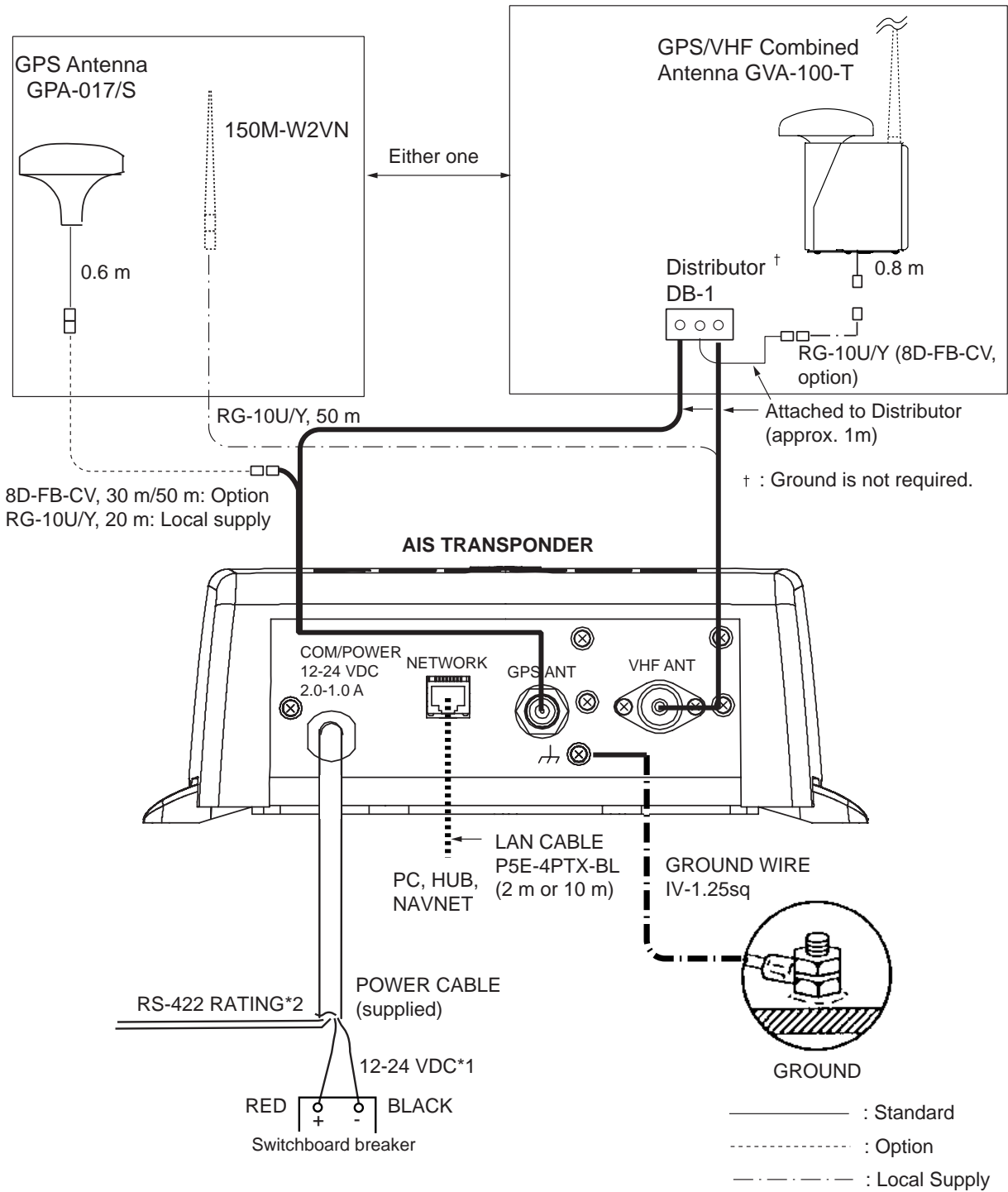

*1: Supply from breaker on switchboard.

*2: If COM lines (connection for NavNet, sensor) are not used, tape them to prevent short circuit.

Connection of AIS viewer (FAISPC-MX)

The AIS viewer may be connected to the FA-50 directly, or to both FA-50 and NavNet VX2/3D. See the figure below for connection examples.



DIRECT CONNECTION

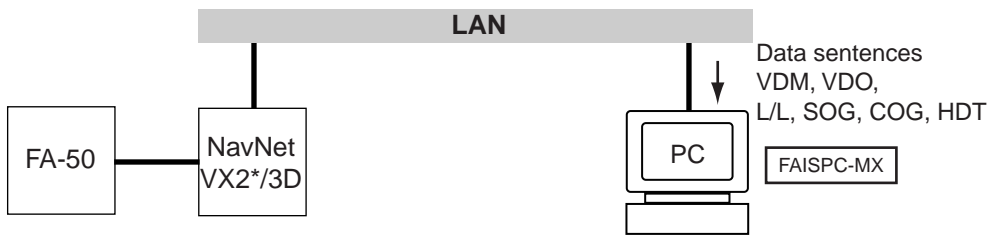

NavNet VX2/3D CONNECTION

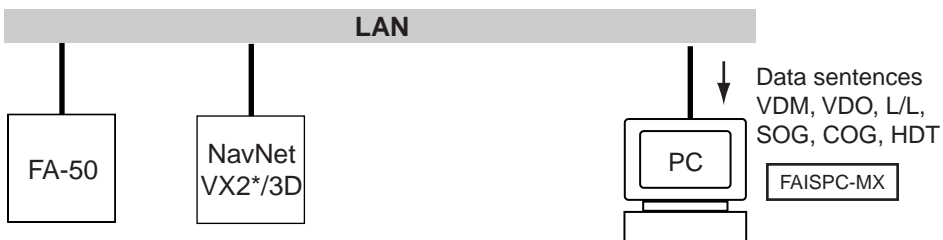

NavNet VX2/3D CONNECTION

*Required updating software.

1.8 Setting and Adjustments

After installing the equipment, set up the COM port, Network and own ship's static information (MMSI, ship's name, call sign, antenna position and type of ship). The FA-50 is set up from the PC or external display. The procedure below shows how to set up from a PC.

Note: Click Tools>Internet Options>Connections>LAN settings, and uncheck the "Use a proxy server for your LAN" before the setting.

1.8.1 COM PORT setup, Network setup

Note: Only one FA-50 may be connected to the network.

Start up

1. Start up the PC and enter IP address and subnet mask.
(Windows 2000/XP)
 - 1) Right-click My Network and left-click Properties.
 - 2) Right-click Local Area Network and left-click Properties.
 - 3) Select Internet Protocol and Properties.
 - 4) Enter IP address 172.31.24.xxx (xxx=any three digits from 1 to 254, except 3).
 - 5) Enter subnet mask 255.255.0.0.
(Windows Vista)
 - 1) Right-click Network.
 - 2) Left-click Properties.
 - 3) Right-click Manage network connections.
 - 4) Right-click Local Area Connection, and left-click Properties.
 - 5) Choose Internet Protocol Version 4 (TCP/IPv4), and left-click Properties button.
 - 6) Choose Use the following IP address.
 - 7) Enter "172.31.24.xxx" in IP address. "xxx" should be 0 to 254 other than 3.
 - 8) Enter subnet mask 255.255.0.0.
 - 9) Left-click OK button.
2. Open Internet Explorer and do the following:
 - 1) Click Tools on the menu bar.
 - 2) Click Internet Options.
 - 3) The General tab is selected. Click Settings at Temporary Internet Files.
 - 4) Click the radio button "Every visit to the page" at "Check for newer versions of stored page".
 - 5) Click the OK button.
 - 6) Click the OK button again.

3. Enter URL as http://172.31.24.3 and press the Enter key. This number is the default value of FA-50.

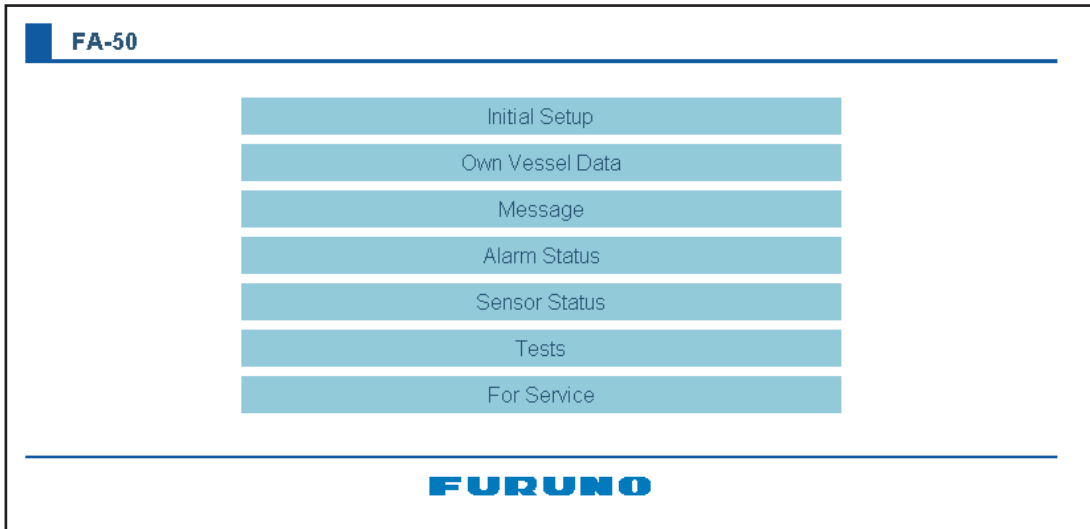

4. Click Initial Setup to show the Initial Setup screen.

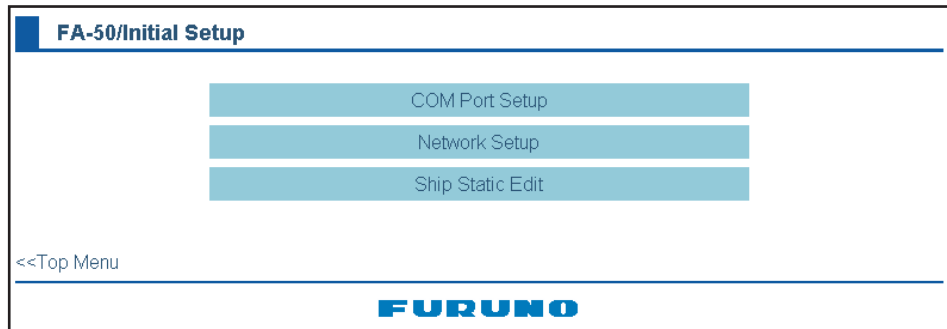

COM PORT setup

1. Click COM Port Setup to show the COM Port Setup screen.

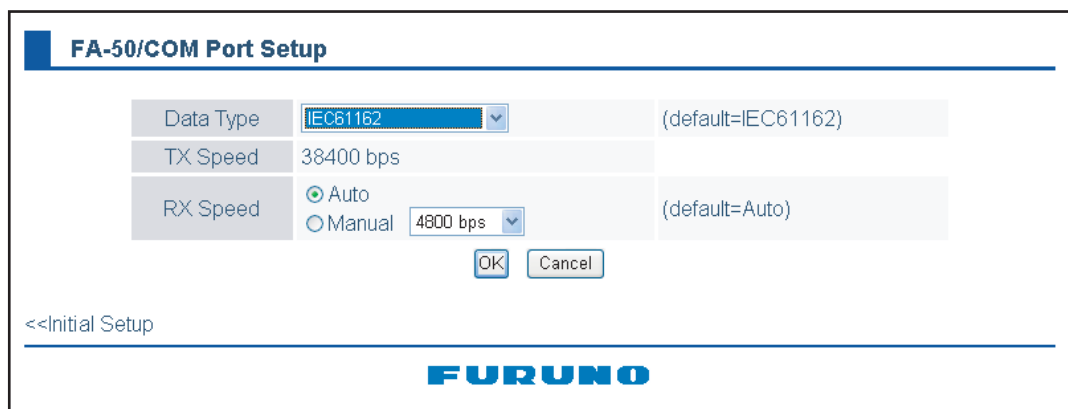

2. The default setting for Data Type is IEC61162, which is suitable for most installations. If change is necessary, click the Data Type drop-down list and choose data type as applicable, among the following choices.

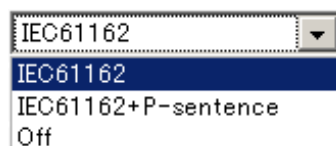

1. INSTALLATION

IEC61162: Transmit and receive IEC61162 format data via COM port. (P-sentences are received but not transmitted. P-sentence is FURUNO's original sentence.)

IEC61162+P-sentence: Transmit and receive IEC61162+P sentences format data via COM port.

Off: FA-50 transmits no data from COM port.

With the radio buttons at RX Speed, choose how RX speed is regulated, Auto or Manual. For manual, choose speed from the drop-down list.

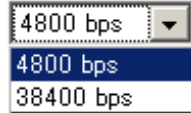

Note: Tx speed is fixed at 38400 bps.

3. Click OK to confirm setting.

NETWORK setup

If connected to a LAN (via NETWORK port), set the IP address for FA-50 as shown below.

1. Click Network Setup to show the Network Setup screen.

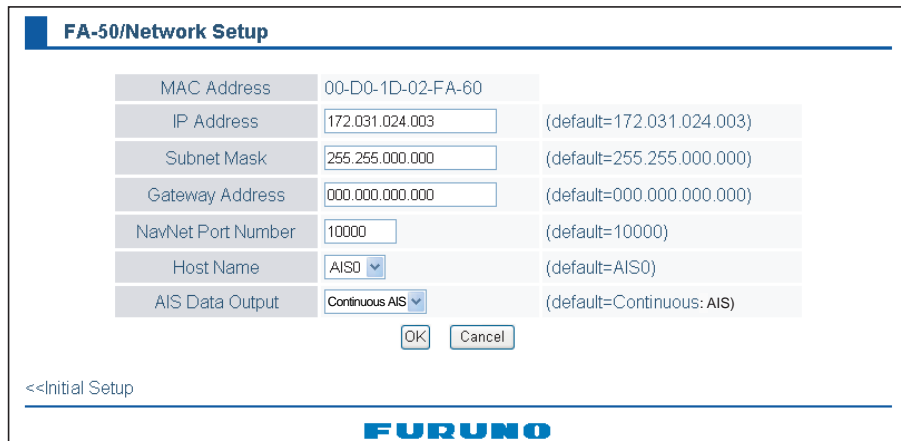

FA-50/Network Setup		
MAC Address	00-D0-1D-02-FA-60	
IP Address	<input type="text" value="172.031.024.003"/>	(default=172.031.024.003)
Subnet Mask	<input type="text" value="255.255.000.000"/>	(default=255.255.000.000)
Gateway Address	<input type="text" value="000.000.000.000"/>	(default=000.000.000.000)
NavNet Port Number	<input type="text" value="10000"/>	(default=10000)
Host Name	<input type="text" value="AIS0"/>	(default=AIS0)
AIS Data Output	<input type="text" value="Continuous AIS"/>	(default=Continuous: AIS)

OK Cancel

<<Initial Setup

FURUNO

2. Enter the IP address assigned to the FA-50.
3. Enter subnet mask for the network.
4. Enter gateway address.
5. For NavNet connection, enter NavNet port number at NavNet Port Number. Enter ten-thousandths and one-thousandths places.
6. At Host Name, select host name to be used in NavNet, AIS0 - AIS9, from the window.
7. At AIS Data Output, set output condition.
 - Auto:** Auto-detect of where to output AIS data.
 - Continuous AIS:** Output AIS data continuously. Select if interfaced with FAISPC_MX.
 - Continuous GPS:** Output GPS data (L/L, SOG, COG) continuously. Select if interfaced with FAISPC_MX.
 - Continuous ZDA:** Output time data continuously. Select if interfaced with FAISPC_MX.

Continuous AIS/GPS: Output AIS/GPS data continuously. Select if interfaced with FAISPC_MX.

Continuous AIS/ZDA: Output AIS/time data continuously. Select if interfaced with FAISPC_MX.

Continuous GPS/ZDA: Output GPS/time data continuously. Select if interfaced with FAISPC_MX.

Continuous AIS/GPS/ZDA: Output AIS/GPS/time data continuously. Select if interfaced with FAISPC_MX.

Note: It is not necessary to change the settings of NavNet Port Number, Host Name and AIS Data Output. Connection is available without adjusting them.

8. Click the OK button to finish.
If you changed a setting, the message below appears.

You must restart your FA-50
before the new settings will take effect.
Do you want to restart your FA-50 now?
(It will take about 1 minute to restart your FA-50)

9. Click the Yes button to restart. ER LED on the FA-50 lights. After the LED goes off access is given.
10. The message "Please close the window." appears. Close the browser.

After restart is completed, it is necessary to access the FA-50 using new values. For example, if you changed the IP address, use the new address to access the FA-50.

1.8.2 Ship static

Set the static data as below to use the transponder function.

1. On the Initial Setup menu, click Ship Static Edit to show the Ship Static Edit menu.

FA-50/Ship Static Edit

Login Name

Password

<<Initial Setup

FURUNO

1. INSTALLATION

- Enter the Login Name and Password. The Ship Static Edit screen appears. Note that the password is known by only the FURUNO dealer.

FA-50/Ship Static Edit

MMSI	000005044							
Ship Name								
Call Sign								
Internal Antenna Position	A	0 m	B	0 m	C	0 m	D	0 m
External Antenna Position	A	0 m	B	0 m	C	0 m	D	0 m
Ship Type	3 Vessel							

OK Cancel

<<Initial Setup

FURUNO

- Enter ship's MMSI (Maritime Mobile Service Identity) in nine digits.
- Enter ship's name, using up to 20 alphanumeric characters.
- Enter call sign, using seven alphanumeric characters.
- Set Internal/External antenna positions as follows:
 - Enter distance for location "A" of FA-50 GPS antenna.
A: Distance from bow to GPS antenna position, setting range: 0-511 m
 - Enter distance for location B, C and D similar to how you did for "A" above.
B: Distance from stern to GPS antenna position, setting range: 0-511 m
C: Distance from port to GPS antenna position, setting range: 0-63 m
D: Distance from starboard to GPS antenna position, setting range: 0-63 m

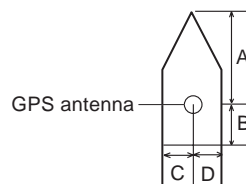

- Enter distance for location of an external GPS antenna (if connected) similar to how you did for the internal GPS antenna.
- Click the down-arrow button for Ship Type to show the operation window, and then choose a ship type. (WIG: Wing in ground, HSC: High speed craft)

1 reserved for future use
2 WIG
3 Vessel
4 HSC
5 Special craft
6 Passenger ships
7 Cargo ships
8 Tanker(s)
9 Other types of ship
10 Reserved for regional use
11 Reserved for regional use
12 Reserved for regional use
13 Reserved for regional use
14 Reserved for regional use
15 Reserved for regional use
16 Reserved for regional use
17 Reserved for regional use
18 Reserved for regional use
19 Reserved for regional use
20 Reserved for future use
21 Reserved for future use
22 Reserved for future use
23 Reserved for future use
24 Reserved for future use
25 Reserved for future use

10 to 19: Reserved for regional use
1, 20 to 25: Reserved for future use

- After finishing all settings, click the OK button.

2. OPERATION

2.1 AIS Transponder FA-50

The FA-50 has no power switch. Power is fed from the ship's switchboard, and a power switch on the switchboard turns the FA-50 on or off. When powered, the PWR LED (green) on the cover lights. The three other LEDs on the cover blink or light with equipment state. The ER LED (red) lights while the equipment is being initialized, and blinks when equipment error is found. The RX LED (orange) lights when receiving. The TX LED lights in blue when transmitting, and blinks in orange when TX time out occurs.

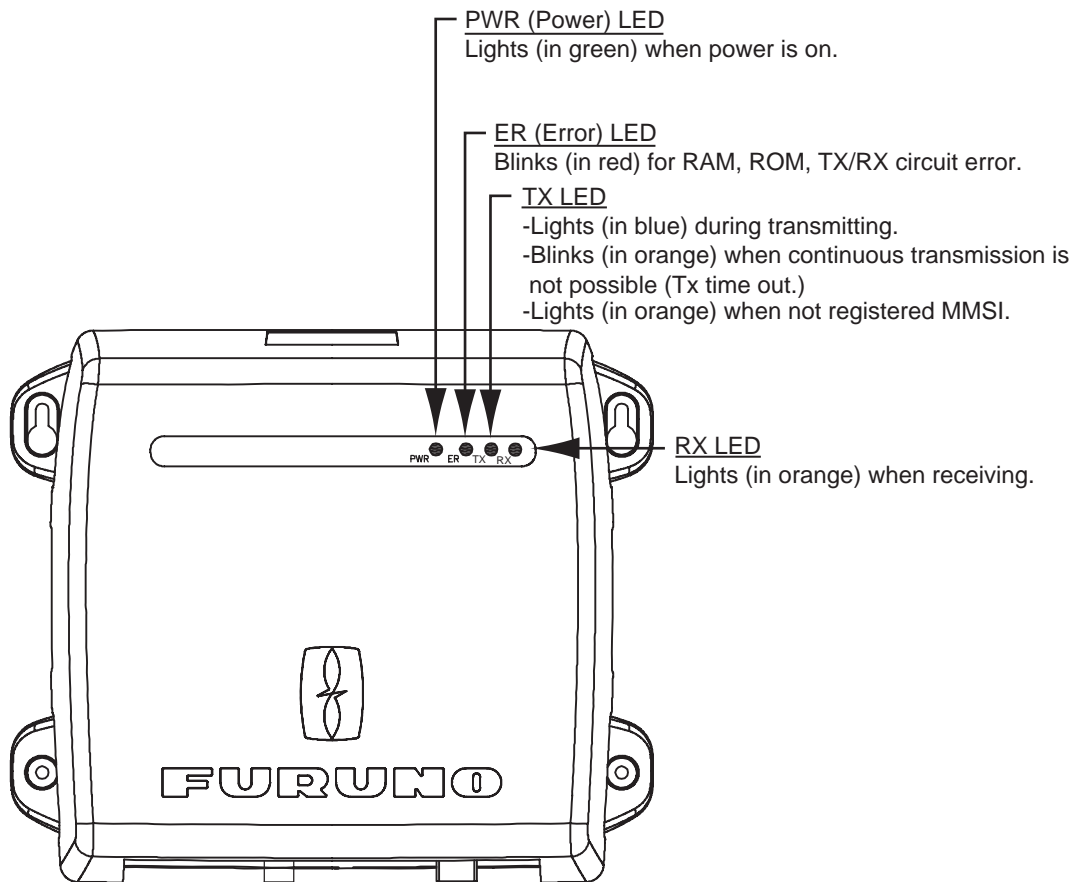

Sending/receiving messages

You may send and receive messages via the VHF link to a specified destination (MMSI) or all ships in the area.

The contents of the message may be viewed on the received message log.

2.2 Messages

2.2.1 Sending a message

Pre-defined messages (maximum 16 characters for each message) are stored in the Send Message screen. You can send a message among them once in a minute.

1. Click Message on the main menu.

FA-50/Message

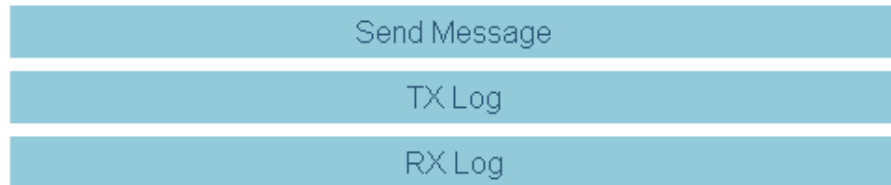

<<Top Menu

2. Click Send Message.

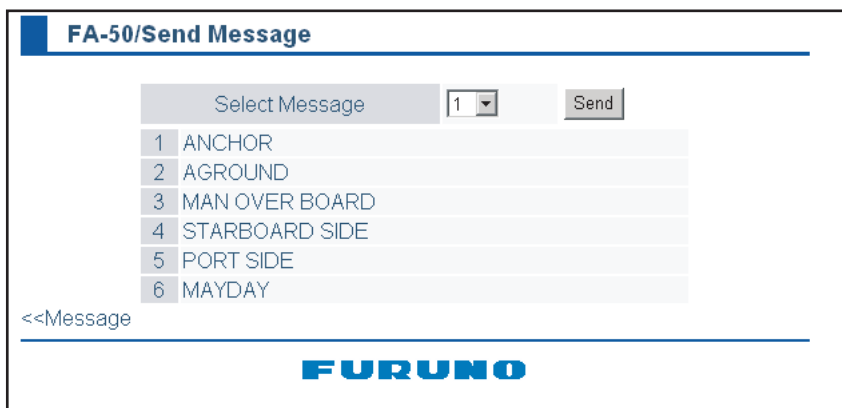

3. Choose the message. Message 1 through 6 are fixed and are not able to change.
4. Click the Send button, and the following message appears.



5. Click the Yes button.

Click the TX Log on the Message menu to show the TX Log to show messages sent. Each page shows ten messages. When changing the page, click "<Page (x/x)". Flag shows OK or NG to inform you the sending status. " _ _ " appears for one minute after sending a message to check it.

FA-50/TX Log							
page(1/1)							
No	Date	Time	CH	Message			Flag
1	07/DEC/2007	07:30	A	MAYDAY			OK
2	07/DEC/2007	07:28	B	STARBOARD SIDE			OK
3	07/DEC/2007	07:27	B	MAN OVER BOARD			NG
4	07/DEC/2007	07:26	A	AGROUND			OK
5	07/DEC/2007	07:24	B	ANCHOR			OK
6	06/DEC/2007	06:03	A	ANCHOR			OK
7							
8							
9							
10							

<<Message

FURUNO

2.2.2 Confirming receiving messages

You can confirm the received messages on the RX Log screen. Click RX Log on the Message menu.

Click Detail to show the full message.

FA-50/RX Log									
page(1/1)									
No	Date	Time	MSG	CH	MMSI	Text		Flag	
1	07/DEC/2007	07:27	14	A	431099808	SOUSIN TEST 4	Detail	Not Read	
2	07/DEC/2007	07:27	8	B	431099808	SOUSIN TEST 3	Detail	Read	
3	07/DEC/2007	07:26	12	A	431099808	SOUSIN TEST 2	Detail	Not Read	
4	07/DEC/2007	07:25	8	A	431099808	SOUSIN TEST	Detail	Read	
5							Detail		
6							Detail		
7							Detail		
8							Detail		
9							Detail		
10							Detail		

Message
 8 = Broadcast Normal
 12 = Addressed Safety
 14 = Broadcast Safety

<<Message

FURUNO

To change the page, click <<Page (x/x). Flag field shows Read or "Not Read" for each message received.

Message category:

- Message 8: Received routine messages
- Message 12: Received safety messages from specific party
- Message 14: Received safety messages

2.3 Own Vessel Data Display

The Own Vessel Data display shows your ship's various data.

1. Show the main menu.
2. Click Own Vessel Data.

FA-50/Own Vessel Data

Own Static		View Channel	
MMSI	123456789	RX1	CH.2087(International)
Ship Name	TAKA MARU	RX2	CH.2088(International)
Call Sign	GH1234	Power	0W(Manual)
Internal Antenna Position	A 100 m B 25 m C 15 m D 20 m	<input type="button" value="Region List"/>	
External Antenna Position	A 100 m B 25 m C 25 m D 10 m	<input type="button" value="Group Assignment"/>	
Ship Type	6 Passenger ships		
Cargo Type	4 Carrying DG, HS, or MP, IMO hazard or pollutant category OS		
<input type="button" value="Cargo Type Edit"/>			

<<Top Menu

FURUNO

MMSI: Nine-digit number

Ship Name: 20 characters, max

Call sign: 7 characters, max.

Internal/External Antenna Position: Shows GPS and external GPS antenna positions.

Ship Type

Cargo Type

RX1: Channel (four digits) received over RX1. Channel type (International, Local) is shown in parentheses.

RX2: Channel (four digits) received over RX2. Channel type (International, Local) is shown in parentheses.

Power: Shows the power (2W)

3. Cargo Type can be selected as below.

- Choose a type, and then click the OK button.

FA-50/Cargo Type

<<Own Vessel Data

Cargo Type

7	Reserved for future use
0	All ships of this type
1	Carrying DG, HS, or MP, IMO hazard or pollutant category X
2	Carrying DG, HS, or MP, IMO hazard or pollutant category Y
3	Carrying DG, HS, or MP, IMO hazard or pollutant category Z
4	Carrying DG, HS, or MP, IMO hazard or pollutant category OS
5	Reserved for future use
6	Reserved for future use
7	Reserved for future use
8	Reserved for future use
9	No additional information

- Click the Cargo Type Edit button to show the Cargo Type screen.
- Select a Cargo Type from the drop down list and click OK.
- Click Region List button to show the local sea area. Clicking the Detail button shows the detailed information of the region.

FA-50/Region Detail

No	1
Time	15/NOV/2007 04:32
Lat NE	35-00.0',N
Lon NE	136-00.0',E
Lat SW	34-00.0',N
Lon SW	135-00.0',E
Ch.A/Band	2088 / Default
Ch.B/Band	2087 / Default
TRX Mode	TxA / TxB , RxA / RxB
Zone / Power	6 nm/ 2W
Enter	MSG22

<<Region List

FURUNO

- Click <<Region List, <<Own Vessel Data in order to return to Own Vessel Data window.

2. OPERATION

- Click the Group Assignment button to show the Group Assignment window. This window shows the following list when receiving a group assignment message via VHF, own ship is cruising in the area specified on the message.

FA-50/Group Assignment			
Assigned Mode		Quiet Mode	
Last Time	7 min	Last Time	3 min
Lat NE	35-00.0000',N	Lat NE	35-00.0000',N
Lon NE	136-00.0000',E	Lon NE	136-00.0000',E
Lat SW	34-00.0000',N	Lat SW	34-00.0000',N
Lon SW	135-00.0000',E	Lon SW	135-00.0000',E
Report Interval	5 sec		
TRX Mode	TxA / TxB , RxA / RxB		

:Own Vessel Data

FURUNO

Assigned mode: Own ship's data is sent automatically with the designated interval in the specified area.

Quiet mode: Transmission is not available in the specified area.

- Click <<Own Vessel Data, <<Top Menu to go back to the top menu.

2.4 Alarm Status

The alarm status log shows alarms violated. Click “Alarm Status” on the top menu to show the alarm status log.

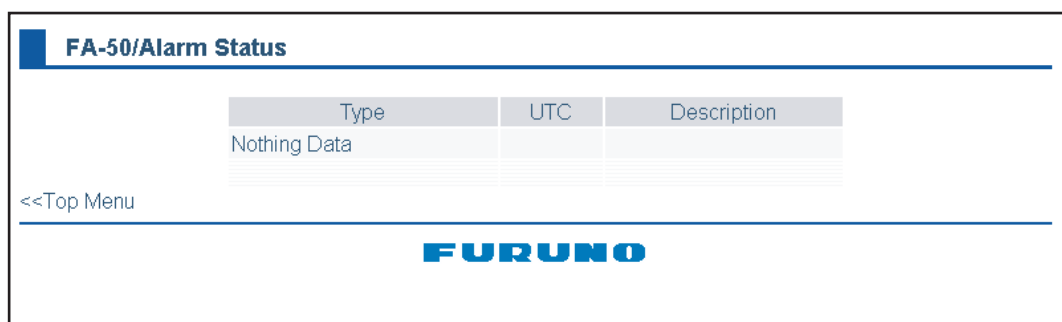

Alarm Status Indication	Meaning
TX	TX malfunction (and Error LED lights.)
RX1	TDMA RX1 Board trouble. TX stopped on corresponding TX channel.
RX2	TDMA RX2 Board trouble. TX stopped on corresponding TX channel.
COG	Invalid COG data.
EPFS	No data from external navigator. Continued operation possible.
HDG	Invalid/nonexistent HDG data
L/L	No L/L data
SOG	Invalid SOG data

2.5 Sensor Status

The sensor status display provides information about sensors connected to the FA-50.

1. Show Top Menu.
2. Click Sensor Status.

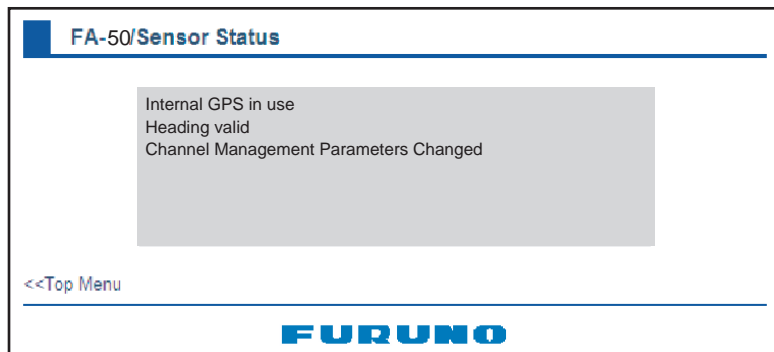

Indication	Meaning	Remarks
DGPS in use (Internal/External)	DGPS currently in use	See *1.
GPS in use (Internal/External)	GPS currently in use	.
SOG/COG in use (Internal/External)	SOG/COG currently in use	
Heading valid	Valid heading data	
Channel Management Parameters Changed	Channel parameters have been changed.	See *2.

*1: Whichever navigator is in use.

*2: Displayed for 30 seconds after changing channel parameters.

3. MAINTENANCE, TROUBLESHOOTING

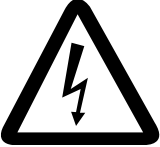
 WARNING	
	<p>Do not open the shield cover unless totally familiar with electrical circuits and service manual.</p> <p>Only qualified personnel should work inside the equipment.</p>

NOTICE
<p>Do not apply paint, anti-corrosive sealant or contact spray to coating or plastic parts of the equipment.</p> <p>Those items contain organic solvents that can damage coating and plastic parts, especially plastic connectors.</p>

3.1 Maintenance

Regular maintenance helps good performance. Check the items listed below monthly to keep your equipment in good working order.

Item	Check point, remedy
Wiring	Check that each cable and wire are securely fastened. Refasten if necessary.
Ground	Check grounding for rust. Clean if necessary.
Antenna	Check antenna and its cabling for damage. Replace if necessary.
Cabinet	Dust and dirt should be removed from the cabinet with a soft, dry cloth. Do not use chemical-based cleaners; they can remove paint and markings.

3.2 Replacing the Fuse

The fuse (4A) inside the FA-50 protects it from overcurrent and equipment fault. If the unit cannot be powered, that is, the PWR (power) LED is off, the fuse may have blown. If this happens, turn off the power to the FA-50, open the body cover and check the fuse. If the fuse has blown, find out the reason before replacing it. If it blows again after replacement, contact a FURUNO agent or dealer for advice.

Part	Type	Code No.
Fuse (4A)	FGMB 125V 4A PBF	000-157-482-10

WARNING

Use the proper fuse.

Use of a wrong fuse can result in damage to the equipment and cause fire.

3.3 Troubleshooting

The troubleshooting table below provides typical operating problems and the means to restore normal operation. If you cannot restore normal operation, do not open the shield cover; there are no user serviceable parts inside the transponder.

Symptom	Problem	Remedy
Transponder cannot be powered.	Fuse inside the transponder may have blown.	Replace the fuse.
Cannot transmit/receive	<ul style="list-style-type: none"> • VHF antenna cable connection may have loosened. • Antenna or its cabling may be damaged. • Rx channel setting is wrong. 	<ul style="list-style-type: none"> • Check if the cable is firmly connected. • Check the antenna and its cabling for damage. • Confirm the channel setting.
The message is sent to wrong ship.	Setting of transmission is not correct.	Confirm MMSI.
No position data	<ul style="list-style-type: none"> • GPS antenna may be damaged. • GPS antenna cable may be damaged. 	<ul style="list-style-type: none"> • Change the GPS antenna. • Check if the cable is firmly fastened. If the cable has damage, change it.

3.4 Diagnostics

The built-in diagnostic facility displays program version no. and TX text, then checks RAM, ROM, RX channels and GPS antenna for proper operation.

1. Open Internet Explorer and display the main menu.
2. Click Tests to show the Tests display.

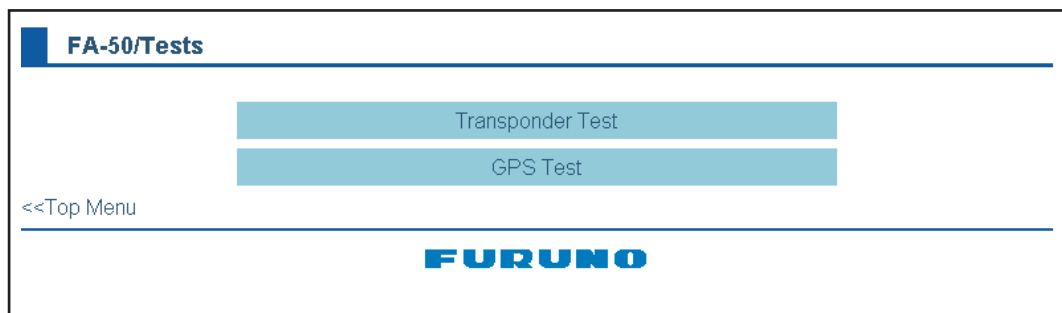

3. Click "Transponder Test" or "GPS Test" to show the appropriate test screen.
Transponder Test: The program version number appears on the first line. The CPU1 RAM and CPU2 RAM, ROM and the two RX channels and TX are checked for proper operation, and the results are displayed as OK or NG (No Good). For any NG, try resetting the power and checking connections. If NG persists, contact your dealer for advice.
GPS Test: The program version number appears on the first line. The ROM, RAM and connection with antenna (including power line), and the results are displayed as OK or NG (No Good). For any NG, try resetting the power and checking connections. If NG persists, contact your dealer for advice.

Version	0550233-01 01
CPU1 RAM	OK
CPU2 RAM	OK
ROM	OK
RX1	OK
RX2	OK
TX	OK

Transponder test

Version	4850264005
ROM	OK
RAM	OK
Antenna	OK

GPS test

3. MAINTENANCE, TROUBLESHOOTING

This page is intentionally left blank.

APPENDIX 1 MENU TREE

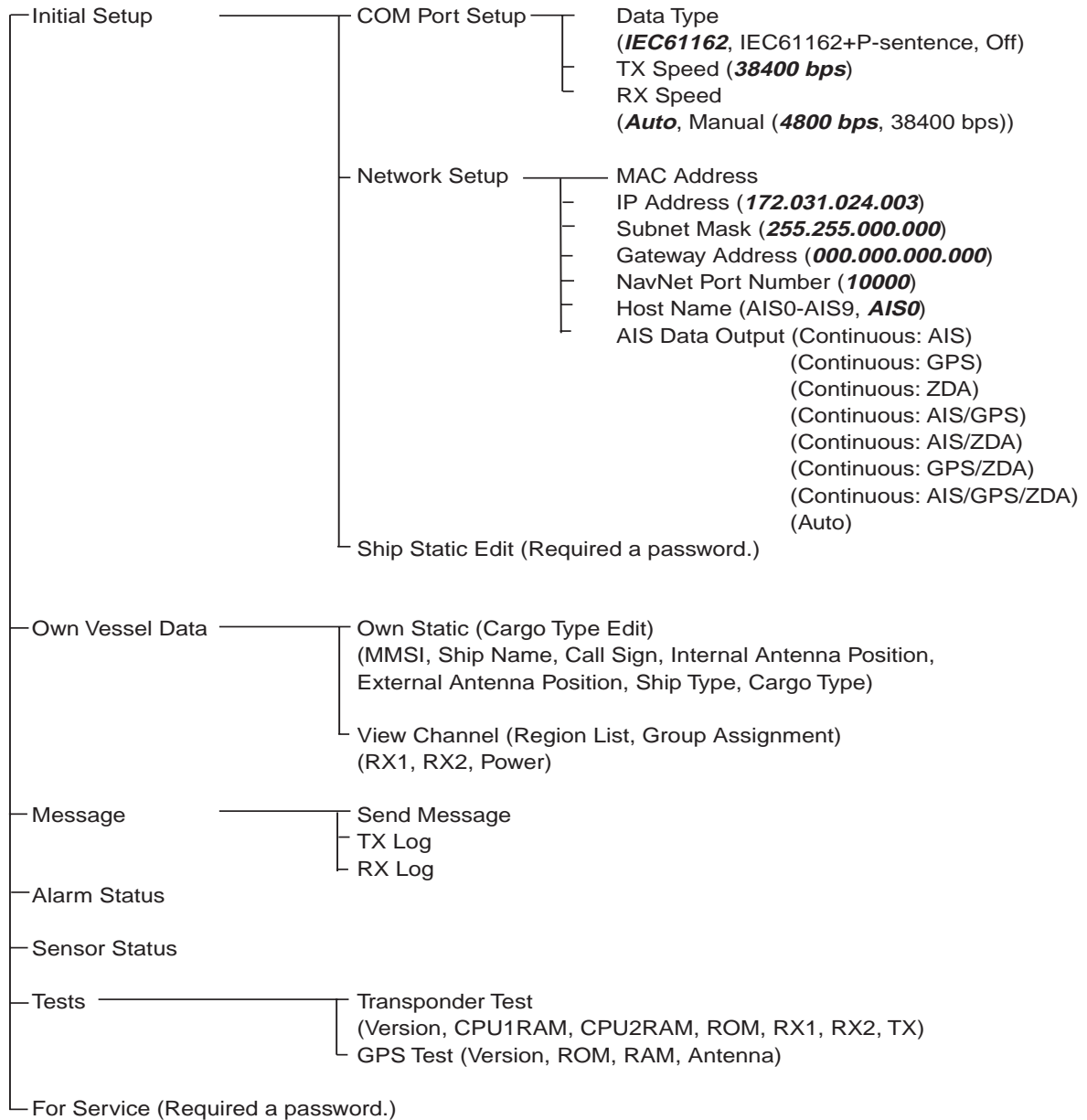

bold: default

APPENDIX 2 VHF CHANNEL LISTS

USA mode

Ch No.	Frequency (MHz)	Ch No.	Frequency (MHz)
1001	156.05	1088	157.425
-	-	2001	160.65
1003	156.15	2002	160.7
-	-	2003	160.75
1005	156.25	2004	160.8
6	156.3	2005	160.85
1007	156.35	2007	160.95
1018	156.9	8	156.4
1019	156.95	9	156.45
1020	157	10	156.5
1021	157.05	11	156.6
1022	157.1	12	156.6
1023	157.15	13	156.65
1024	157.2	14	156.7
1025	157.25	15	156.75
1026	157.3	16	156.8
1027	157.35	17	156.85
1028	157.4	2018	161.5
-	-	2019	161.55
1061	156.07	2020	161.6
-	-	2021	161.65
1063	156.175	2022	161.7
1064	156.225	2023	161.75
1065	156.275	2024	161.8
1066	156.325	2025	161.85
67	156.375	2026	161.9
68	156.425	2027	161.95
69	156.475	2028	162
70	156.525	2060	160.625
71	156.575	2061	160.675
72	156.625	2062	160.725
73	156.675	2063	160.775
74	156.725	2064	160.825
75	156.775	2065	160.875
76	156.825	2066	160.925
77	156.875	2078	161.525
1078	156.925	2079	161.575
1079	156.975	2080	161.625
1080	157.025	2081	161.675
1081	157.075	2082	161.725
1082	157.125	2083	161.775
1083	157.175	2084	161.825
1084	157.225	2085	161.875

International mode

Ch No.	Frequency (MHz)	Ch No.	Frequency (MHz)
1001	156.05	1088	157.425
1002	156.1	2001	160.65
1003	156.15	2002	160.7
1004	156.2	2003	160.75
1005	156.25	2004	160.8
6	156.3	2005	160.85
1007	156.35	2007	160.95
1018	156.9	8	156.4
1019	156.95	9	156.45
1020	157	10	156.5
1021	157.05	11	156.55
1022	157.1	12	156.6
1023	157.15	13	156.65
1024	157.2	14	156.7
1025	157.25	15	156.75
1026	157.3	16	156.8
1027	157.35	17	156.85
1028	157.4	2018	161.5
1060	156.025	2019	161.55
1061	156.075	2020	161.6
1062	156.125	2021	161.65
1063	156.175	2022	161.7
1064	156.225	2023	161.75
1065	156.275	2024	161.8
1066	156.325	2025	161.85
67	156.375	2026	161.9
68	156.425	2027	161.95
69	156.475	2028	162
70	156.525	2060	160.625
71	156.575	2061	160.675
72	156.625	2062	160.675
73	156.675	2063	160.775
74	156.725	2064	160.825
75	156.775	2065	160.875
76	156.825	2066	160.925
77	156.875	2078	161.525
1078	156.925	2079	161.575
1079	156.975	2080	161.625
1080	157.025	2081	161.675
1081	157.075	2082	161.725
1082	157.125	2083	161.775
1083	157.175	2084	161.825
1084	157.225	2085	161.875
1085	157.275	2086	161.925
1086	157.325	2087	161.975
1087	157.375	2088	162.025

CH13, 67: operate on 1W.

APPENDIX 3 PARTS LIST, LOCATIONS

Parts lists

FURUNO	Model	FA-50	
	Unit	Tranponder	
	ELECTRICAL PARTS LIST		
	Blk.No.		
NAME	TYPE	CODE NO.	
PRINTED CIRCUIT BOARD			
MAIN&TX	05P0814	001-034-470	
POWER	05P0809	001-034-460	
RX1	05P0808A	001-015-620	
RX2	05P0808B	001-015-630	
GPS TB	24P0043	005-955-290	

Parts location

Transponder

MAIN&TX Board
05P0814



RX1 Board
05P0808A

RX2 Board
05P0808B

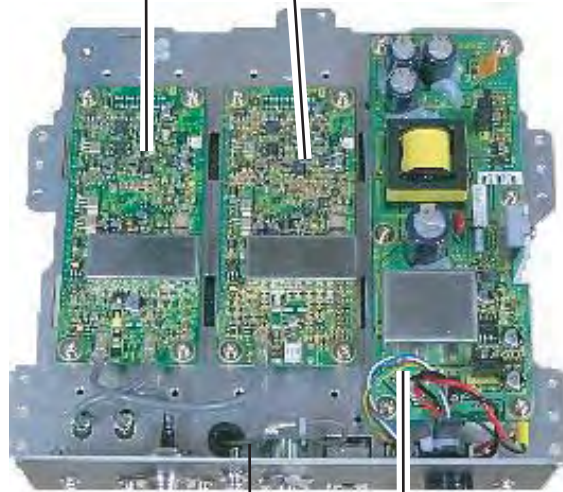

GPS TB
24P0043

POWER Board
05P0809

APPENDIX 4 DIGITAL INTERFACE

Sentence data

Input sentences ACK, AIQ, BBM, DSC, DSE, DTM, GBS, GGA, GLL, GNS, HDT, OSD, RMC, SSD, VBW, VSD, VTG

Output sentences

ABK, ACA, ACS, ALR, TXT, VDM, VDO

Transmission interval ABK: With each event

ACA, ACS: At RX/Switch information the region

ALR: 25 s during alarm, 2 min normally no alarm

TXT: Status is changed. VDM: At RX VHF VDO: 1 s

Load requirements as listener

Isolation: opto coupler

Input Impedance: 470 ohms

Max. Voltage: ± 15 V

Threshold: 3 mA (In case of FURUNO device talker connection)

Output drive capability

Differential driver output $R=54$ ohm, 1.1 V min $R=60$ ohm, 1.1 V min Driver short-circuit current: 250

mA max. Data transmission Data format and protocol are transmitted in serial asynchronous form in accordance with the standard referenced in 2.1 of IEC 61162-1. The first bit is a start bit and is followed by data bits, least-significant-bit as illustrated below.

The following parameters are used:

Baud rate: 38.4 Kbps

Data bits: 8 (D7=0), parity none

Stop bits: 1

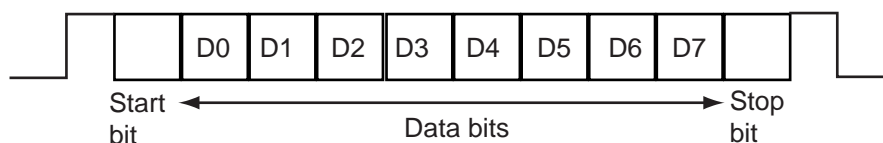

Serial interface I/O circuit

Input/Output Buffer

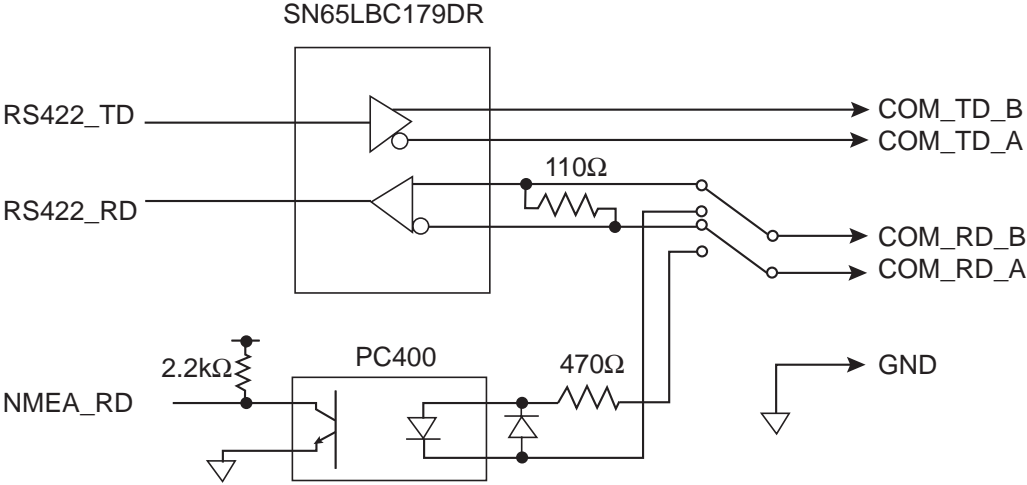

Sentence description

Input sentences

AIQ-AOIS query

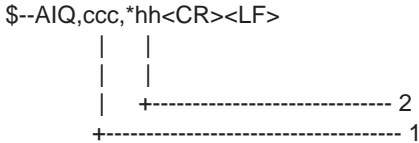

- 1. Query data
- 2. Checksum

BBM-AIS broadcast binary message

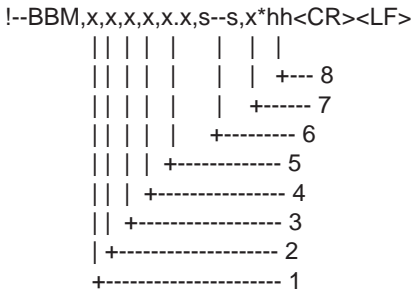

- 1. Total number of sentences needed to transfer the message, 1 to 9
- 2. Message sentence number, 1 to 9
- 3. Sequential Message identifier, 0 to 9
- 4. AIS channel for broadcast of the radio message
- 5. VDL message number(8 or 14), see ITU-R M.1371
- 6. Binary data
- 7. Number of fill-bits, 0 to 5
- 8. Checksum

APPENDIX 4 DIGITAL INTERFACE

DSC

-DSC,xx,xxxxxxxx,xx,xx,xx,x.x,xxxxxxxx,xx,a,a*hh<CR><LF>

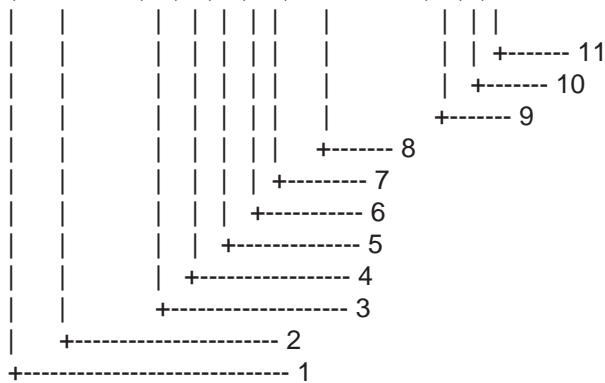

1. Format Specifier
2. Address
3. Category
4. Nature of Distress or First Telecommand
5. Type of Communication or Second Telecommand
6. Position
7. Time
8. MMSI of ship in distress
9. Nature of distress
10. Acknowledgement
11. Expansion indicator

DSE-Expanded digital selective calling

\$--DSE,x,x,a,xxxxxxxx,xx,c-c,.....,xx,c-c*hh<CR><LF>

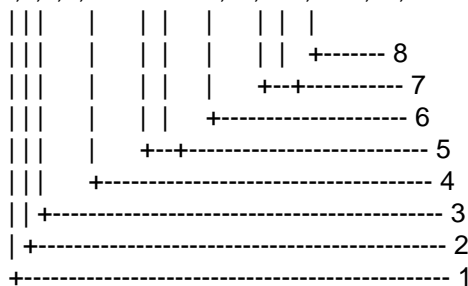

1. Total number of messages
2. Message number
3. Query/reply flag
4. Vessel MMSI
5. Data set '1'
6. Additional data sets
7. Data set 'n'
8. Checksum

DTM-Datum referencew

\$--DTM,ccc,a,x.x,a,x.x,a,x.x,ccc*hh<CR><LF>

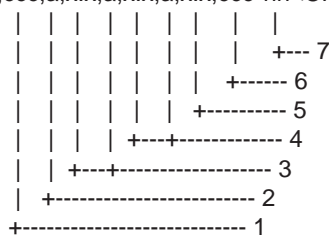

1. Local datum W84 - WGS84
W72 - WGS72
S85 - SGS85
P90 - PE90
999 - User defined
IHO datum code
2. Not used
3. Lat offset, min, N/S
4. Lon offset, min, E/W
5. Not used
6. Reference dattum W84 - WGS84
W72 - WGS72
S85 - SGS85
P90 - PE90
7. Checksum

APPENDIX 4 DIGITAL INTERFACE

GNS-GNSS fix data

\$--GNS,hhmmss.ss,llll.ll,a,yyyy.yy,a,c--c,xx,x.x,x.x,x.x,x.x,x.x,x.x*hh<CR><LF>

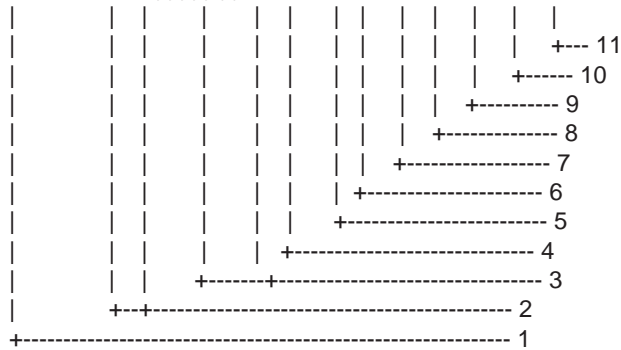

- 1. Not used
- 2. Latitude, N/S
- 3. Longitude, E/W
- 4. Mode indicator
- 5. Not used
- 6. Not used
- 7. Not used
- 8. Not used
- 9. Not used
- 10. Not used
- 11. Checksum

HDT-Heading true

\$--HDT,x.x,T*hh<CR><LF>

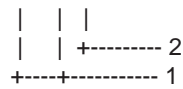

- 1. Heading, degrees true
- 2. Checksum

OSD-Own ship data

\$--OSD,x.x,A,x.x,a,x.x,a,x.x,x.x,a*hh<CR><LF>

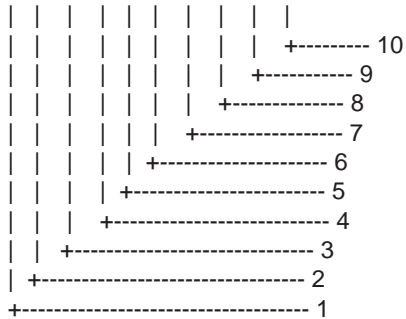

- 1. Heading, degrees true
- 2. Heading status: A=data valid, V=data invalid
- 3. Vessel course, degrees true
- 4. Course reference, B/M/W/R/P(see note)
- 5. Vessel speed
- 6. Speed reference, B/M/W/R/P(see note)
- 7. Not used
- 8. Not used
- 9. Speed units, K(km/h) / N(Knots) / S(statute miles/h)
- 10. Checksum

NOTES - Reference systems(speed/course):

- B = bottom tracking log
- M = manually entered
- W = water referenced
- R = radar tracking(of fixed target)
- P = positioning system ground reference

RMC-Recommended minimum specific GNSS data

--RMC,hhmmss.ss,A,llll.ll,a,yyyy.yy,a,x.x,x.x,xxxxxx,x.x,a,a*hh<CR><LF>

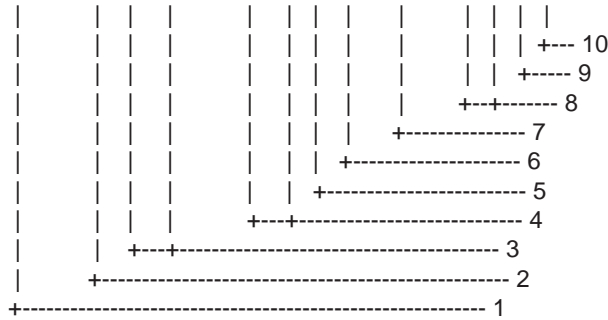

1. UTC of position fix
2. Status: A=data valid, V=navigation receiver warning
3. Latitude, N/S
4. Longitude, E/W
5. Speed over ground, knots
6. Course over ground, degrees true
7. Date: dd/mm/yy
8. Not used
9. Mode indicator (See NOTE.)
10. Checksum

NOTE Positioning system Mode indicator:

- A = Autonomous
- D = Differential
- E = estimated (dead reckoning)
- M = Manual input
- S = Simulator
- N = Data not valid

The Mode indicator field supplements the Status field. The Status field shall be set to V=invalid for all values of Operating Mode except for A=Autonomous and D=Differential. The positioning system Mode indicator and Status field shall not be null fields.

SSD-AIS ship static data

\$\$-SSD,c--c,c--c,xxx,xxx,xx,xx,c, aa*hh<CR><LF>

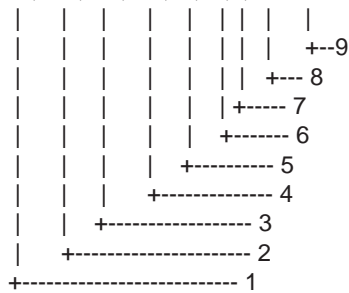

1. Ship's Call Sign, 1 to 7 characters
2. Ship's Name, 1 to 20 characters
3. Pos. ref. point distance, "A," from bow, 0 to 511 Meters
4. Pos. ref. point distance, "B," from stern, 0 to 511 Meters
5. Pos. ref. point distance, "C," from port beam, 0 to 63 Meters
6. Pos. ref. point distance, "D," from starboard beam, 0 to 63 Meters
7. DTE indicator flag
8. Not used
9. Checksum

VBW-Dual ground/water speed

\$\$-VBW,x.x,x.x,A,x.x,x.x,A,x.x,A,x.x,A*hh<CR><LF>

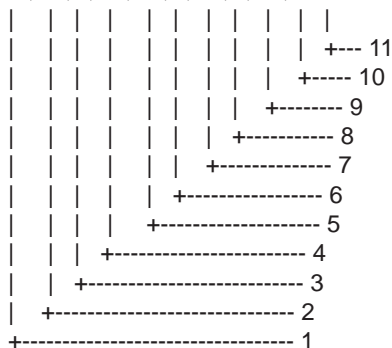

1. Not used
2. Not used
3. Not used
4. Longitudinal ground speed, knots
5. Transverse ground speed, knots
6. Status: ground speed, A=data valid V=data invalid
7. Not used
8. Not used
9. Not used
10. Not used
11. Checksum

APPENDIX 4 DIGITAL INTERFACE

VSD-AIS voyage static data

\$--VSD,x.x,x.x,x.x,c--c,hhmmss.ss,xx,xx,x.x,x.x*hh<CR><LF>

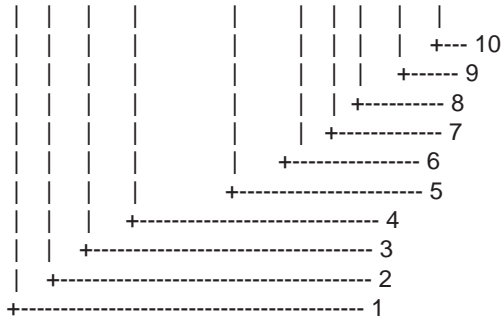

1. Type of ship and cargo category, 0 to 255
2. Maximum present static draught, 0 to 25.5 Meters
3. Persons on-board, 0 to 8191
4. Destination, 1-20 characters
5. Estimated UTC of arrival at destination
6. Estimated day of arrival at destination, 00 to 31(UTC)
7. Estimated month of arrival at destination, 00 to 12(UTC)
8. Navigational status, 0 to 15
9. Regional application flags, 0 to 15
10. Checksum

Note: VTG-Course over ground and ground speed

\$--VTG,x.x,T,x.x,M,x.x,N,x.x,K,a*hh<CR><LF>

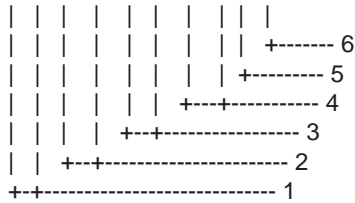

1. Course over ground, degrees true
2. Not used
3. Speed over ground, knots
4. Speed over ground, km/h
5. Mode indicator(see note)
6. Checksum

NOTE Positioning system Mode indicator:

- A = Autonomous
- D = Differential
- E = estimated(dead reckoning)
- M = Manual input
- S = Simulator
- N = Data not valid

The positioning system Mode indicator field shall not be a null field.

Output sentences

ABK-UAIS addressed and binary broadcast acknowledgement

\$--ABK,xxxxxxxx,a,x.x,x,x*hh<CR><LF>

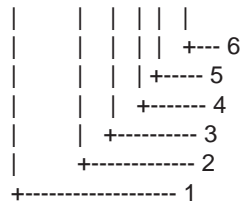

1. MMSI of the addressed AIS unit
2. AIS channel of reception
3. Message type
4. Message sequence number
5. Type of acknowledgement
6. Checksum

ACA-AIS channel assignment message

\$--ACA,x,IIII.l, a,yyyyy.y,a,IIII.l,a,yyyyy.y,a,x,xxxx,x,xxxx,x,x,x,a,x,hhmmss.s*hh<CR><LF>

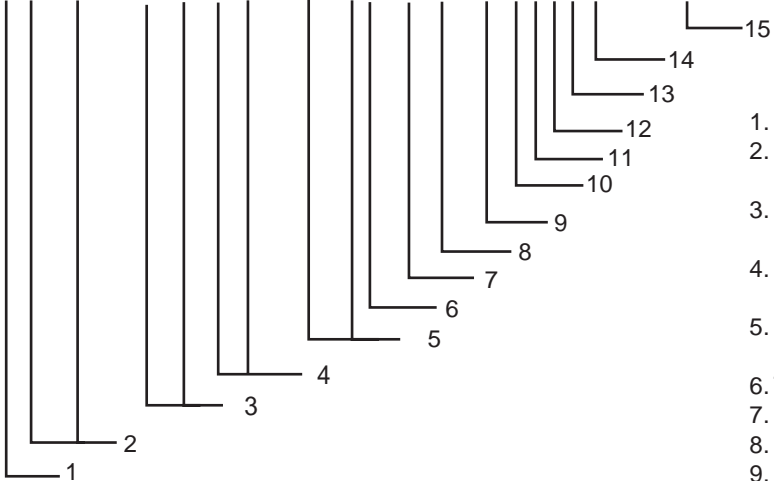

- 1. Sequence number, 0 to 9
- 2. Region Northeast corner latitude - N/S
- 3. Region Northeast corner longitude - E/W
- 4. Region Southwest corner latitude - N/S
- 5. Region Southwest corner longitude - E/W
- 6. Transition Zone Size
- 7. Channel A
- 8. Channel A bandwidth
- 9. Channel B
- 10. Channel B bandwidth
- 11. Tx/Rx mode control
- 12. Power level control
- 13. Not used
- 14. In-use flag
- 15. Time of in-used change

ACS-Channel management information source

\$--ACS,x,xxxxxxxx,hhmmss.ss,xx,xx,xxx*hh<CR><LF>

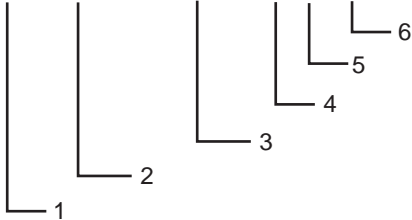

- 1. Sequence number, 0 to 9
- 2. MMSI of originator
- 3. UTC at receipt of regional operating settings
- 4. UTC day, 01- to 31
- 5. UTC month, 01 to 12
- 6. UTC year

ALR-Set alarm state

\$--ALR,hhmmss.ss,xxx,A,A,c--c*hh<CR><LF>

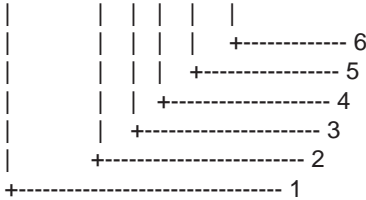

- 1. Time of alarm condition change, UTC
- 2. Local alarm number(identifier)
- 3. Alarm condition(A=threshold exceeded, V=not exceeded)
- 4. Alarm's acknowledge state, A=acknowledged V=unacknowledged
- 5. Alarm's description text
- 6. Checksum

APPENDIX 4 DIGITAL INTERFACE

TXT-Text transmission

\$--TXT,xx,xx,xx,c--c*hh<CR><LF>

```

| | | | |
| | | | +--- 5
| | | +---+--- 4
| | +----- 3
| +----- 2
+----- 1
    
```

1. Total number of message, 01 to 99
2. Message number, 01 to 99
3. Text identifier
4. Text Message
5. Checksum

VDM-AIS VHF data-link message

!--VDM,x,x,x,a,s--s,x*hh<CR><LF>

```

| | | | | | |
| | | | | | +--- 7
| | | | | +----- 6
| | | | +----- 5
| | | +----- 4
| | +----- 3
| +----- 2
+----- 1
    
```

1. Total number of sentences needed to transfer the message, 1 to 9
2. Message sentence number, 1 to 9
3. Sequential message identifier, 0 to 9
4. AIS channel
5. Encapsulated ITU-R M.1371 radio message
6. Number of fill-bits, 0 to 5
7. Checksum

VDO-AIS VHF data-link own vessel report

!--VDO,x,x,x,a,s--s,x*hh<CR><LF>

```

| | | | | | |
| | | | | | +--- 7
| | | | | +----- 6
| | | | +----- 5
| | | +----- 4
| | +----- 3
| +----- 2
+----- 1
    
```

1. Total number of sentences needed to transfer the message, 1 to 9
2. Message sentence number, 1 to 9
3. Sequential message identifier, 0 to 9
4. AIS channel
5. Encapsulated ITU-R M.1371 radio message
6. Number of fill-bits, 0 to 5
7. Checksum

FURUNO

SPECIFICATIONS OF CLASS B AIS TRANSPONDER FA-50

1 GENERAL

- | | | |
|-----|---------------------------|---------------------------------------------------------------------------------------------|
| 1.1 | Type | Class B AIS Transponder |
| 1.2 | RX capacity | 2250 report/minute, 1 channel
4500 report/minute, 2 channel |
| 1.3 | RX system | CSTDMA dual wave simultaneous reception |
| 1.4 | Synchronous framing | Indirect synchronize from external oscillator |
| 1.5 | Operating mode | Autonomous, Assigned, polled/interrogation response |
| 1.6 | Frequency switching | Automatic |
| 1.7 | Prevention of abnormal TX | Auto-suspend for detecting TX more than 1 second |
| 1.8 | Regulations | IMO MSC.140 (76), IEC 62287-1, ITU-R M.1371-2,
DSC ITU R M.825-3, IEC 60945 ed.4 adopted |

2 TRANSMITTER

- | | | |
|-----|---------------------|--------------------------------------------------------------------|
| 2.1 | Frequency range | 156.025 MHz to 162.025 MHz (F1D) |
| 2.2 | Output power | 1W/2W |
| 2.3 | Channel interval | 25 kHz |
| 2.4 | Frequency deviation | ± 3 ppm or less |
| 2.5 | Transmit speed | 9600 bps ± 50 ppm |
| 2.6 | Spurious Emission | 9 kHz to 1 GHz, -36 dBm or less
1 GHz to 4 GHz, -30 dBm or less |

3 AIS RECEIVER

- | | | |
|------|------------------------------|------------------------------------------------------------------------------------------------------------------------|
| 3.1 | Frequency range | 156.025 MHz to 162.025 MHz (DSC: 156.525 MHz) |
| 3.2 | Oscillator frequency | 1 st local oscillator: $f + (51.136/51.236 \text{ MHz})$
2 nd local oscillator: 51.1/51.2 MHz |
| 3.3 | Intermediate frequency | 1 st : 51.136/51.236 MHz, 2 nd : 36 kHz |
| 3.4 | Receiving system | Double-conversion superheterodyne |
| 3.5 | Sensitivity | -107 dBm (PER 20% or less) |
| 3.6 | Error at high input level | -7 dBm |
| 3.7 | Co-channel rejection | 10 dB |
| 3.8 | Adjacent channel selectivity | 70 dB |
| 3.9 | Spurious response | 70 dB (50 MHz to 520 MHz) |
| 3.10 | Inter-modulation | 65 dB |
| 3.11 | Sensitivity suppression | 86 dB (± 5 MHz, ± 10 MHz) |

4 DSC RECEIVER (TIMESHARING SYSTEM)

- | | | |
|-----|---------------------------|--------------------|
| 4.1 | Frequency | 156.525 MHz (CH70) |
| 4.2 | Sensitivity | -107 dBm or less |
| 4.3 | Error at high input level | -7 dBm |

E4442S01A

FURUNO

- 4.4 Co-channel rejection 10 dB
- 4.5 Adjacent channel selectivity 70 dB
- 4.6 Spurious response 70 dB
- 4.7 Inter-modulation 65 dB
- 4.8 Sensitivity suppression 84 dB

4 GPS RECEIVER

- 4.1 Receiving frequency 1575.42 MHz
- 4.2 Tracking code C/A code
- 4.3 Number of channel 12 channels parallel, 12 satellites
- 4.4 Position fixing method All in view, 8-state Kalman filter
- 4.5 Position accuracy 10 m approx., 95% of the time, (HDOP 4)
DGPS: 5m approx., 95% of the time
- 4.6 Tracking velocity 900 kts
- 4.7 Position fixing time Warm start: 36 s typical, Cold start: 43 s typical
- 4.8 Geoids WGS84
- 4.9 Position update interval 1 s
- 4.10 DGPS data correcting By AIS information

5 INTERFACE

5.1 COM I/O

- Input: RS-422 (38.4kbps) / IEC61162-1 (4800bps)
ACK, BBM, DTM, GBS, GGA, GLL, GNS, HDT, OSD, RMC,
SSD, VBW, VSD, VTG, AIQ, DSC, DSE, PFEC
- Output: RS-422 (38.4kbps)
ABK, ACA, ACS, ALR, VDM, VDO, TXT, PFEC

5.2 NETWORK

- Input: Ethernet 10BASE-T/100BASE-TX
ACK, BBM, DTM, GBS, GGA, GLL, GNS, HDT, OSD, RMC,
SSD, VBW, VSD, VTG, AIQ, DSC, DSE, PFEC
- Output: ABK, ACA, ACS, ALR, VDM, VDO, TXT, PFEC

- 5.3 Function alarm LED indication, series data output

6 POWER SUPPLY

12-24 VDC: 2.0-1.0 A

7 ENVIRONMENTAL CONDITIONS

- 7.1 Ambient temperature
 - Antenna unit -30°C to +70°C
 - Transponder -15°C to +55°C
- 7.2 Relative humidity 93% at +40°C
- 7.3 Degree of protection
 - Antenna unit IPX6

E4442S01A

FURUNO

7.4 Bearing vibration IEC 60945

8 COATING COLOR

8.1 GPS antenna unit N9.5

8.2 Transponder N2.5



E4442S01A

PACKING LIST

24AA-X-9853 -5 1/1

GVA-100,GVA-100-T

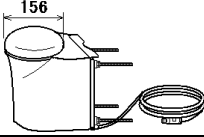
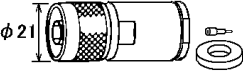
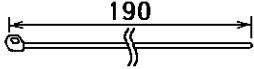
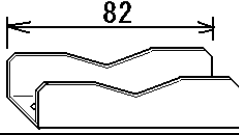
A-1

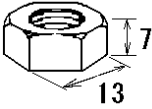
NAME	OUTLINE	DESCRIPTION/CODE	Q'TY
ユニット UNIT			
複合空中線部 GPS/VHF COMBINED ANTENNA		GVA-100 000-053-810-00 **	1
工事材料 INSTALLATION MATERIALS		CP24-00141	
コネクタ(N) CONNECTOR		N-P-8DFB 座金 000-140-463-00	2
コンベックス PLASTIC BAND		CV-200HT CV-200HT 000-162-191-10 000-809-226-00	2
アンテナ取付金具 ANTENNA FIXING BRACKET		24-003-3015-0 100-302-670-00	2
ミガキ平座金 FLAT WASHER		M8 SUS304 000-864-130-00	4
六角ナット 1種 HEX.NUT		M8 SUS304 000-863-110-00	8

1.コード番号末尾の[**]は、選択品の代表型式/コードを表します。
CODE NUMBER ENDING WITH "**" INDICATES THE CODE NUMBER OF REPRESENTATIVE MATERIAL.

型式/コード番号が2段の場合、下段より上段に代わる過渡期品であり、どちらかが入っています。なお、品質は変わりません。
TWO TYPES AND CODES MAY BE LISTED FOR AN ITEM. THE LOWER PRODUCT MAY BE SHIPPED IN PLACE OF THE UPPER PRODUCT. QUALITY IS THE SAME.
(略図の寸法は、参考値です。 DIMENSIONS IN DRAWING FOR REFERENCE ONLY.)

24AA-X-9853

FURUNO

CODE NO.	005-955-560-00	24AC-X-9403 -3
TYPE	CP24-00502	1/1

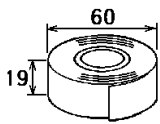
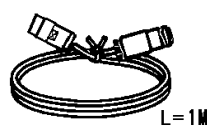
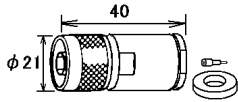
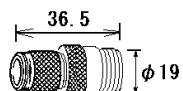
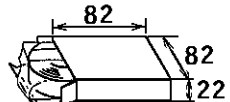
工事材料表					
INSTALLATION MATERIALS					
番号 NO.	名称 NAME	略図 OUTLINE	型名/規格 DESCRIPTIONS	数量 Q'TY	用途/備考 REMARKS
1	ビニールテープ N0360 VINYL TAPE		0.2X19X10000 ケロ エスロン CODE NO. 000-835-215-00	1	
2	変換ケーブル組品 CONVERT CABLE ASSY.		NJ-TP-3DXV-1 CODE NO. 000-123-809-00	1	
3	コネクタ CONNECTOR		N-P-8DSFA CODE NO. 000-167-921-10	2	
4	コネクタ (TNC-N) CONNECTOR		TNCP-NJ CODE NO. 000-156-599-10	1	
5	絶縁テープ SELF-BONDING TAPE		Uテープ 0.5X19X5M CODE NO. 000-165-833-10	1	

型式/コード番号が2段の場合、下段より上段に代わる過渡期品であり、どちらかが入っています。なお、品質は変わりません。

TWO TYPES AND CODES MAY BE LISTED FOR AN ITEM. THE LOWER PRODUCT MAY BE SHIPPED IN PLACE OF THE UPPER PRODUCT. QUALITY IS THE SAME.

(略図の寸法は、参考値です。 DIMENSIONS IN DRAWING FOR REFERENCE ONLY.)

表 1 TABLE 1

寸法区分 (mm) DIMENSION	公差 (mm) TOLERANCE
$L \leq 50$	± 1.5
$50 < L \leq 100$	± 2.5
$100 < L \leq 500$	± 3

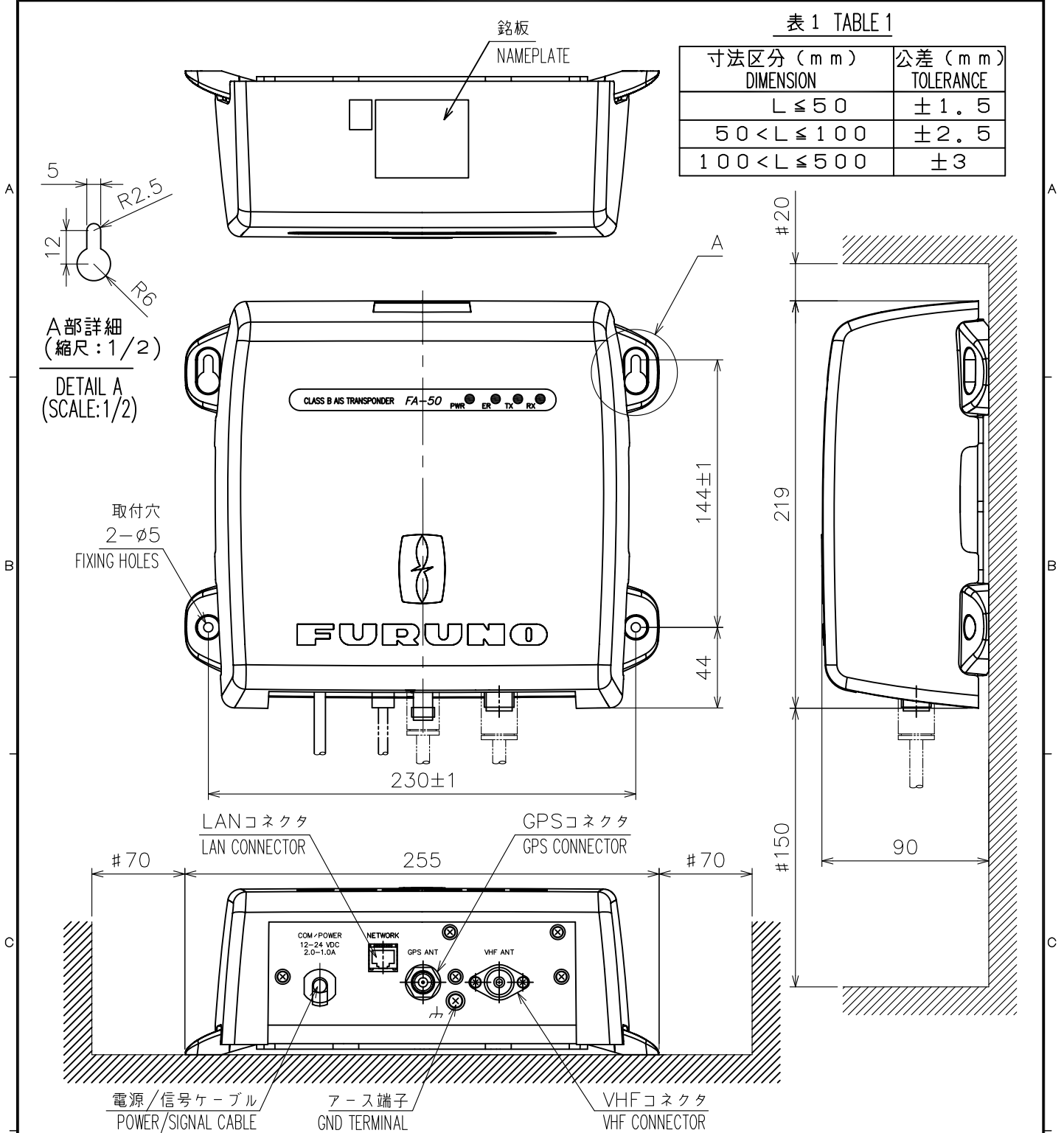

注 記

- 1) #印寸法は最小サービス空間寸法とする。
- 2) 指定外の寸法公差は表 1 による。
- 3) 取付ネジは+トラスタッピンネジ4x20とする。

NOTE

1. # MINIMUM SERVICE CLEARANCE.
2. TABLE 1 INDICATES TOLERANCE OF DIMENSIONS WHICH IS NOT SPECIFIED.
3. USE TAPPING SCREWS 4x20 FOR FIXING THE UNIT.

DRAWN Aug. 24 '07 T.YAMASAKI	TITLE FA-50
CHECKED Aug. 24 '07 T.TAKENO	名称 簡易型船舶自動識別装置
APPROVED Aug. 30 '07 R.Esumi	外寸図
SCALE 1/3	NAME CLASS B AIS TRANSPONDER
MASS 1.7 $\pm 10\%$ kg	OUTLINE DRAWING
DWG.No. C4442-G01-1	REF.No. 05-097-299G-2

A

B

C

D



表1 TABLE 1

寸法区分(mm) DIMENSION	公差(mm) TOLERANCE
$L \leq 50$	± 1.5
$50 < L \leq 100$	± 2.5
$100 < L \leq 500$	± 3

1-14UNS1B

ねじ山数 (25.4mmにつき) : 14
 ピッチ : 1.8143 mm
 オネジ有効長さ : 19 mm以上
 オネジ有効径 : 24.17mm

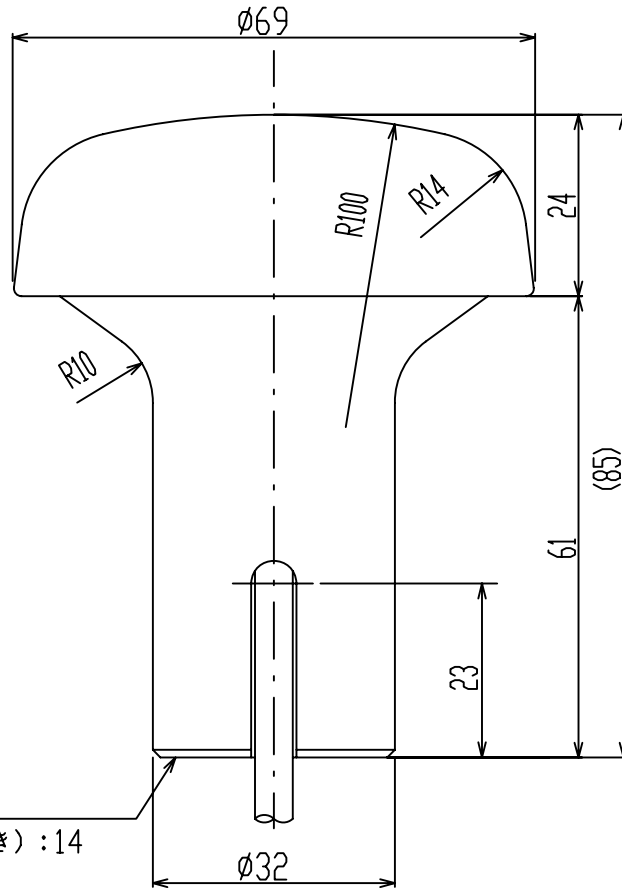
THREAD PER 25.4mm (1 INCH): 14
 PITCH: 1.8143 mm
 THREAD LENGTH: 19 mm OR MORE
 PITCH DIAMETER: 24.17mm



表2 TABLE 2

型式 TYPE	ケーブル長(m) CABLE LENGTH	プラグ PLUG	質量(kg $\pm 10\%$) MASS
GPA-017	10	TNC-P-3	0.6
GPA-017S	0.2	TNC-J-3	0.15

注記

指定外の寸法公差は表1による。

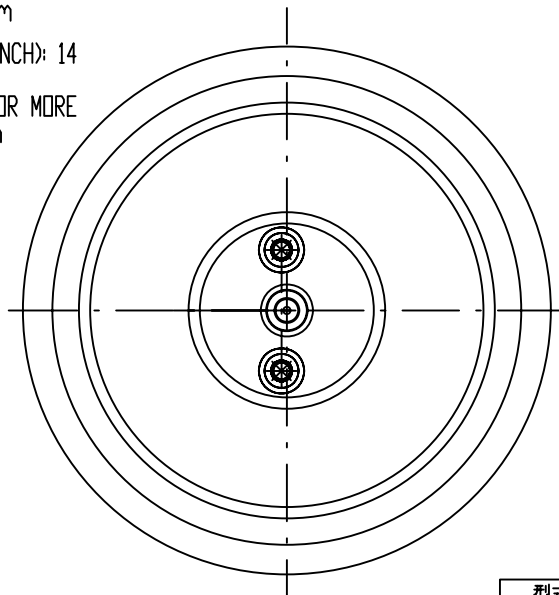
NOTE

TABLE 1 INDICATES TOLERANCE OF DIMENSIONS WHICH IS NOT SPECIFIED.

DRAWN Mar. 27 '07 T.YAMASAKI		TITLE GPA-017/017S
CHECKED Mar. 27 '07 T.TAKENO		名称 空中線部
APPROVED Mar. 27 '07 R.Esumi		外寸図
SCALE 1/1	MASS TABLE 2 表2参照	NAME ANTENNA UNIT
DWG.No. C4384-G04-L		OUTLINE DRAWING

表 1 TABLE 1

寸法区分 (mm) DIMENSIONS	公差 (mm) TOLERANCE
$L \leq 50$	± 1.5
$50 < L \leq 100$	± 2.5
$100 < L \leq 500$	± 3
$500 < L \leq 1000$	± 4
$1000 < L \leq 2000$	± 5

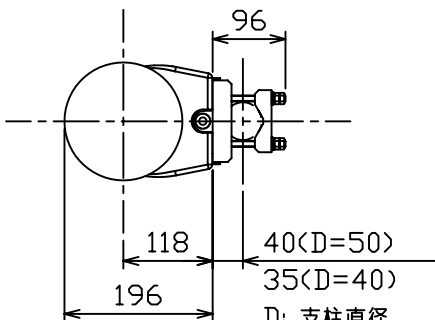

D: 支柱直径
D: DIAMETER OF STANCHION

FAB-151D

GSC-001

$\phi 155$

1245 \pm 15

236 \pm 5

169

この点より上に金属物体が
突出しないようにすること。
NO METAL OBJECTS SHOULD
BE BEYOND THIS POINT.

アンテナ支柱 ($\phi 40 \sim \phi 50$)
STANCHION

60

4-M8

注 記 1) 指定外の寸法公差は表 1 による。

NOTE 1. TABLE 1 INDICATES TOLERANCE OF DIMENSIONS WHICH IS NOT SPECIFIED.

DRAWN Feb. 9 '05 T.YAMASAKI	TITLE GVA-100
CHECKED Feb. 9 '05 T.MATSUGUCHI	名称 GPS/VHF 複合空中線部
APPROVED Feb. 22 '05 T.Matsuguchi	FA-100 外寸図
SCALE 1/10	NAME GPS/VHF COMBINED ANTENNA
MASS 3.3 $\pm 10\%$ kg	OUTLINE DRAWING
DWG.No. C4417-G02-F	24-003-301G-1

寸法区分 (mm) DIMENSION	公差 (mm) TOLERANCE
$L \leq 50$	± 1.5
$50 < L \leq 100$	± 2.5
$100 < L \leq 500$	± 3

表 1 TABLE 1

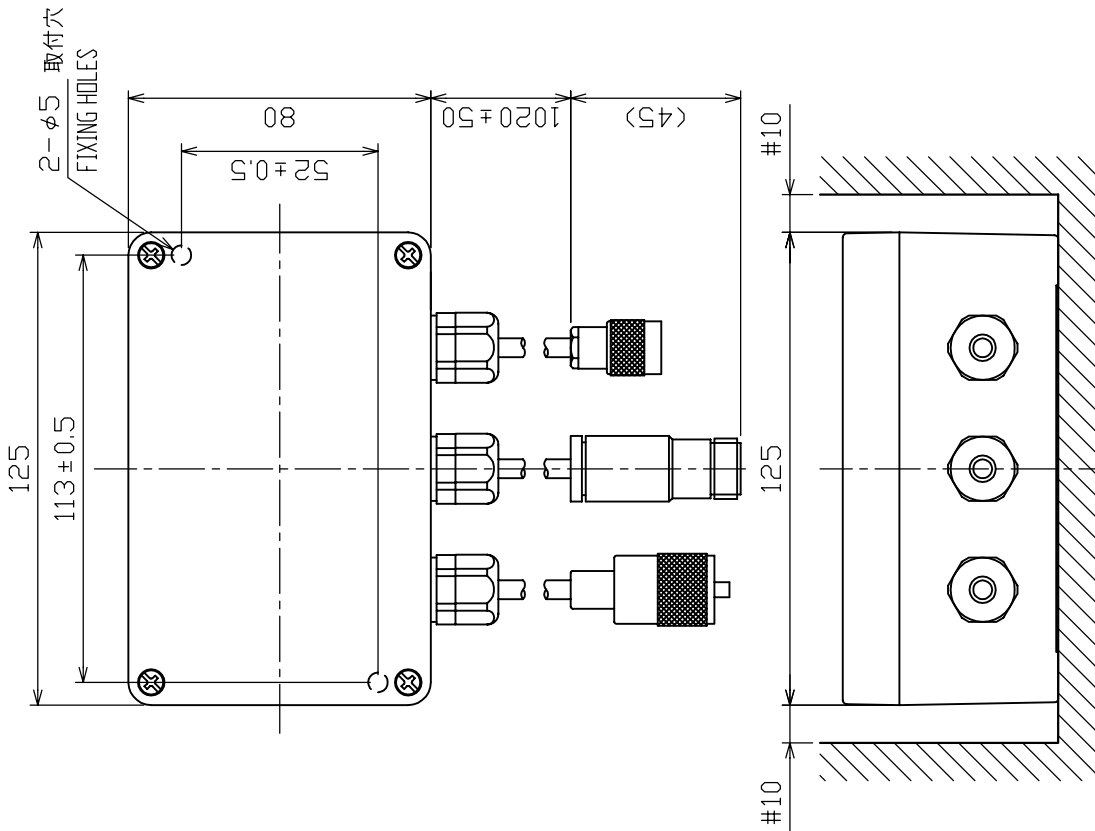

- 注 記
- 1) # 印寸法は最小サービスイ空間寸法とする。
 - 2) 指定外の寸法公差は表 1 による。
 - 3) 取付用ネジは + ナベタップピンネジ 4 x 3.0 を使用のこと。
- NOTE
1. # RECOMMENDED SERVICE CLEARANCE.
 2. TABLE 1 INDICATES TOLERANCE OF DIMENSIONS.
 3. USE TAPPING SCREWS 4x3.0 FOR FIXING THE UNIT.

DRAWN	Jan. 9 '03	T. YAMASAKI	TITLE	DB-1
CHECKED	Jan. 9 '03	Y. KIMURA	名称	分配器
APPROVED	Jan. 9 '03	<i>y. Kimura</i>	外寸図	FA-100
SCALE	1/2	MASS 0.85 kg	NAME	DISTRIBUTOR
DWG No.	C4417-G04-C		24-003-320G-4	OUTLINE DRAWING

A

B

C

D

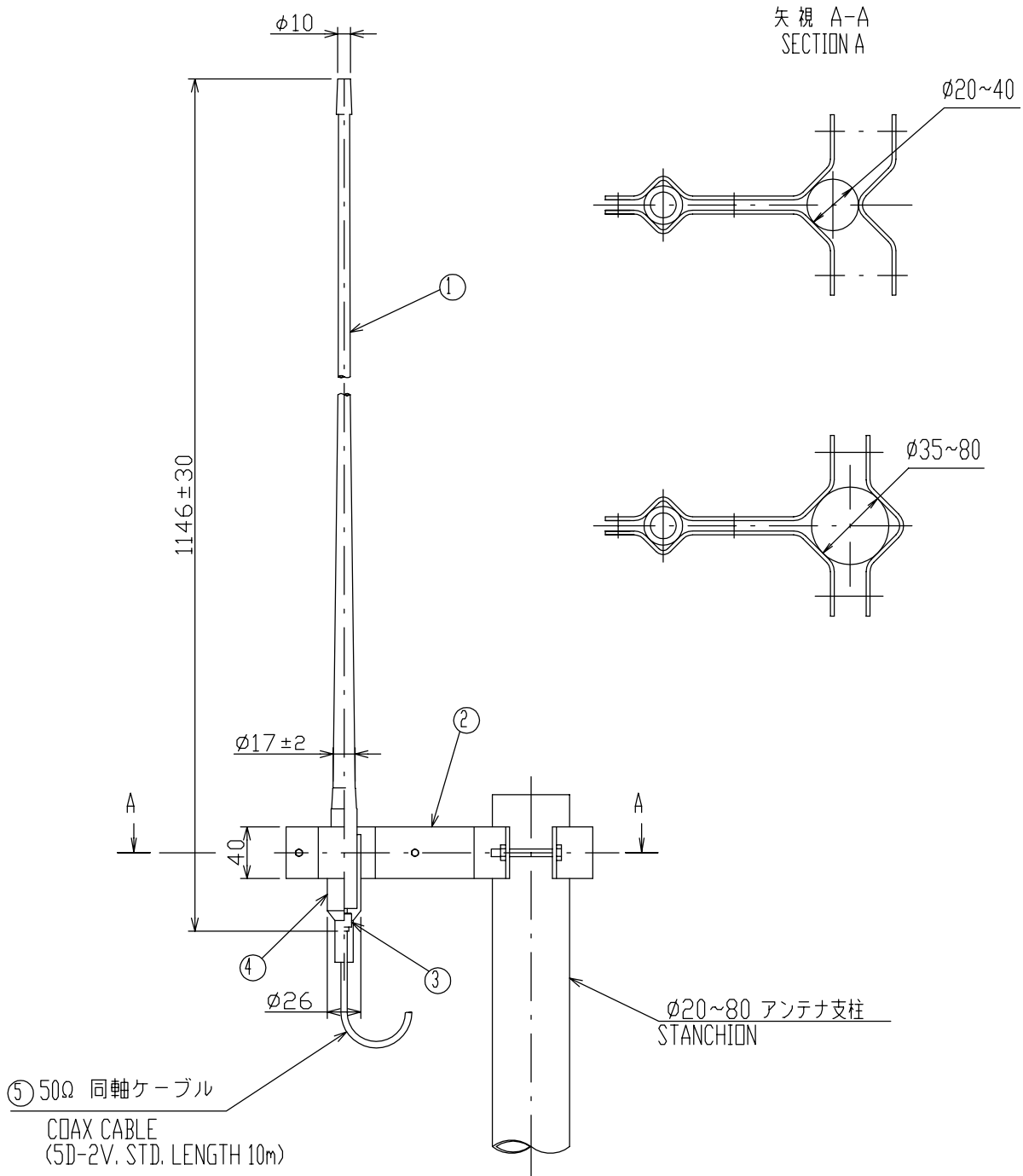

5	同軸ケーブル 50Ω COAX. CABLE		10m	5D-2V	
4	掙ビキャップ CONNECTOR CAP		1		
3	同軸コネクタ COAX. CONNECTOR		2	M-P-5	
2	アンテナ取付金具 ANTENNA BRACKET		1 式 SET		t2
1	アンテナ棒 ANTENNA ELEMENT	FRP	1	150M-W2VN	0.25kg
品番 ITEM	品名 NAME	材質 MATERIAL	数量 Q.TY	図番 DWG.No.	摘要 REMARKS

DRAWN	Nov. 26 '03	T.YAMASAKI	TITLE	150M-W2VN	
CHECKED	Nov. 26 '03	T.TAKENO	名称	150MHzホイップアンテナ	
APPROVED	Nov. 28 '03	<i>Matsuyuchi</i>		外寸図	
SCALE	1/5	MASS 0.7 ±10% kg	NAME	150MHz WHIP ANTENNA	
DWG.No.	C5011-042- C			OUTLINE DRAWING	

取付位置
MOUNTING LOCATION

他の機器のアンテナから下の図の距離以上離す。
THIS FIGURE SHOWS THE SEPARATION DISTANCES FROM OTHER ANTENNAS TO AVOID MUTUAL INTERFERENCE.

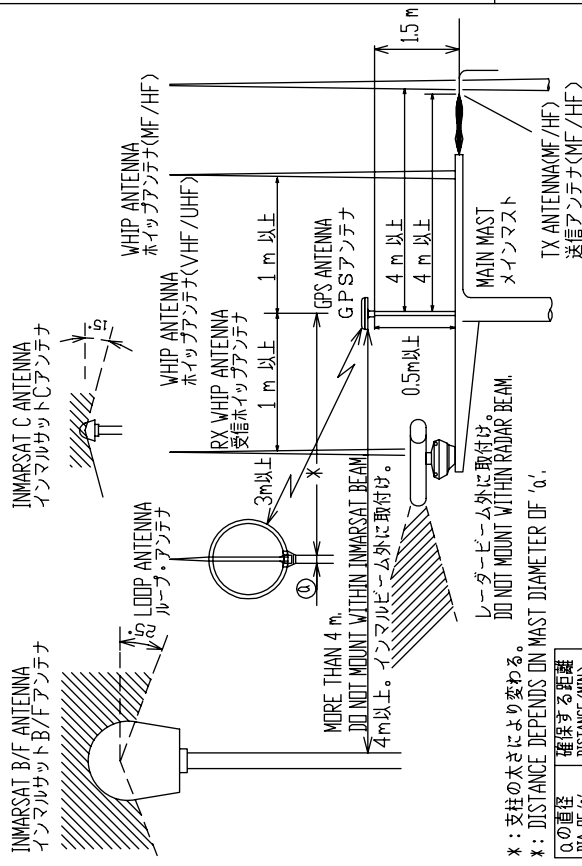

B) スタンションやバルビットにつけるときの

レール用アンテナベース No.13-RC5160
(取付可能レール直径: $\phi 19 \sim \phi 32$)
(コード番号: 000-806-114)

HANDRAIL MOUNTING

USE HANDRAIL MOUNTING BASE No.13-RC5160
(CODE No.000-806-114, OPTION)
THE DIAMETER OF THE HANDRAIL MAY BE FROM $\phi 19$ mm TO $\phi 32$ mm.

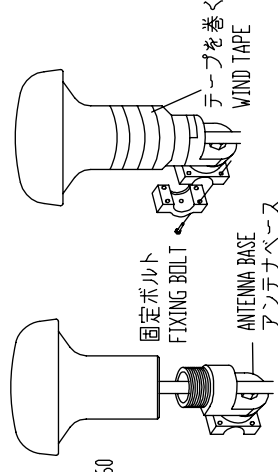

- 注記 1) パイプやアンテナベースはアンテナユニットにねじ込んだ後に固定する。
2) アンテナを固定するときはパイプ(アンテナベース)をアンテナにねじ込むこと。アンテナ側をねじるとコネクタ部やケーブルに無理がかかり、故障の原因となる。
- NOTE 1. FASTEN PIPE(ANTENNA BASE) TO ANTENNA UNIT FIRST THEN FIX THEM TO MAST OR HANDRAIL.
2. WHEN FIXING ANTENNA, TURN PIPE OR ANTENNA BASE, NOT THE ANTENNA. TURNING THE ANTENNA MAY TWIST THE CABLE AND PLACE STRESS ON CONNECTOR.

A) マストへの取付け

MAST MOUNTING

パイプのみの使用するとき
USE A PIPE ONLY.

MAST
 $\phi 25-70$

パイプ
PIPE

アンテナケーブル
ANTENNA CABLE

テープを巻く
WIND TAPE

取付補助金具
MOUNTING BRACKET

アンテナケーブルを固定する
FIX CABLE WITH SEALANT
(LOCAL SUPPLY)

コンベックス
CABLE TIE
(現地手配)

Hose Clamp
 Hose Clamp

パイプ固定板
CABLE FIXTURE

テープを巻く
WIND TAPE

コンベックス
(現地手配)
CABLE TIE
(LOCAL SUPPLY)

アンテナケーブル
ANTENNA CABLE

ケーブル溝のある場合
USING CABLE GUIDE

パイプで傷つかないように
KEEP CABLE ASIDE TO AVOID
INJURY FROM PIPE.

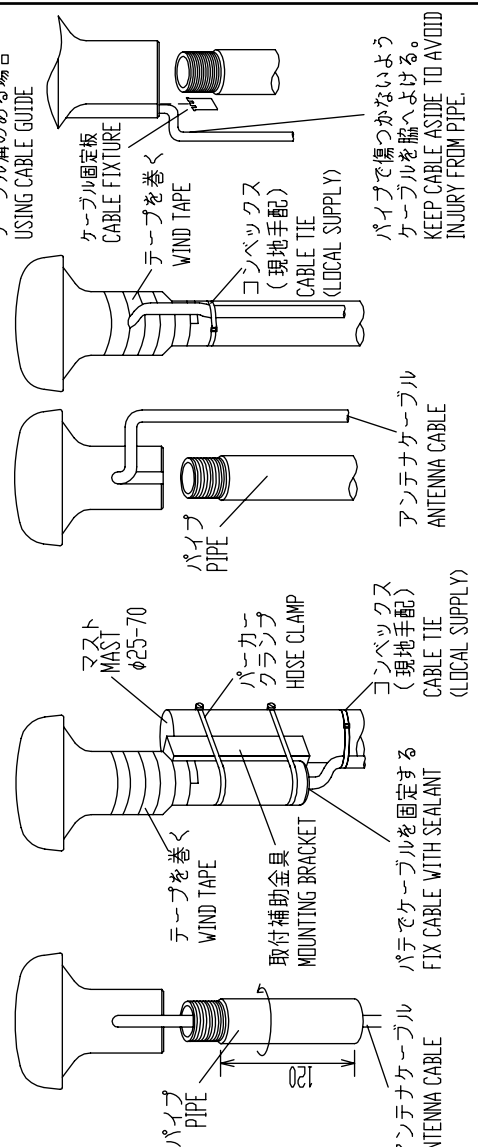

C) 取付ける場所が傾斜しているとき

ANTENNA BASE MOUNTING

オプションのアンテナベースを使う。
USE OPTIONAL ANTENNA BASE.

傾斜 INCLINATION	取付け角度 MOUNTING ANGLE	傾斜角度 INCLINATION	取付け角度 MOUNTING ANGLE	コード番号 CODE No.
-5° - 33°	33°	32° - 65°	65° - 98°	000-803-239
33°	0° - 5°	65°	0°	000-803-240
0° - 5°	0° - 5°	65°	0°	000-803-240
65°	0°	65°	0°	000-803-240
65°	0°	65°	0°	000-803-240

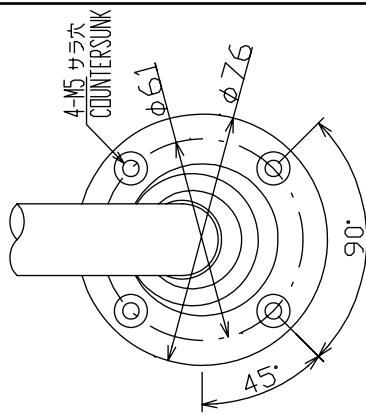

アンテナベース基部

MOUNTING DIMENSIONS OF ANTENNA BASE.

DRAWN	Dec.14_'05	E.MIYOSHI	TITLE	GPA series
CHECKED		TAKAHASHI.T	名称	空中線部
APPROVED		Y. Hatai		装備要領図
SCALE		MASS	NAME	ANTENNA UNIT
DWG.No.	C4384-Y01-E			INSTALLATION PROCEDURE

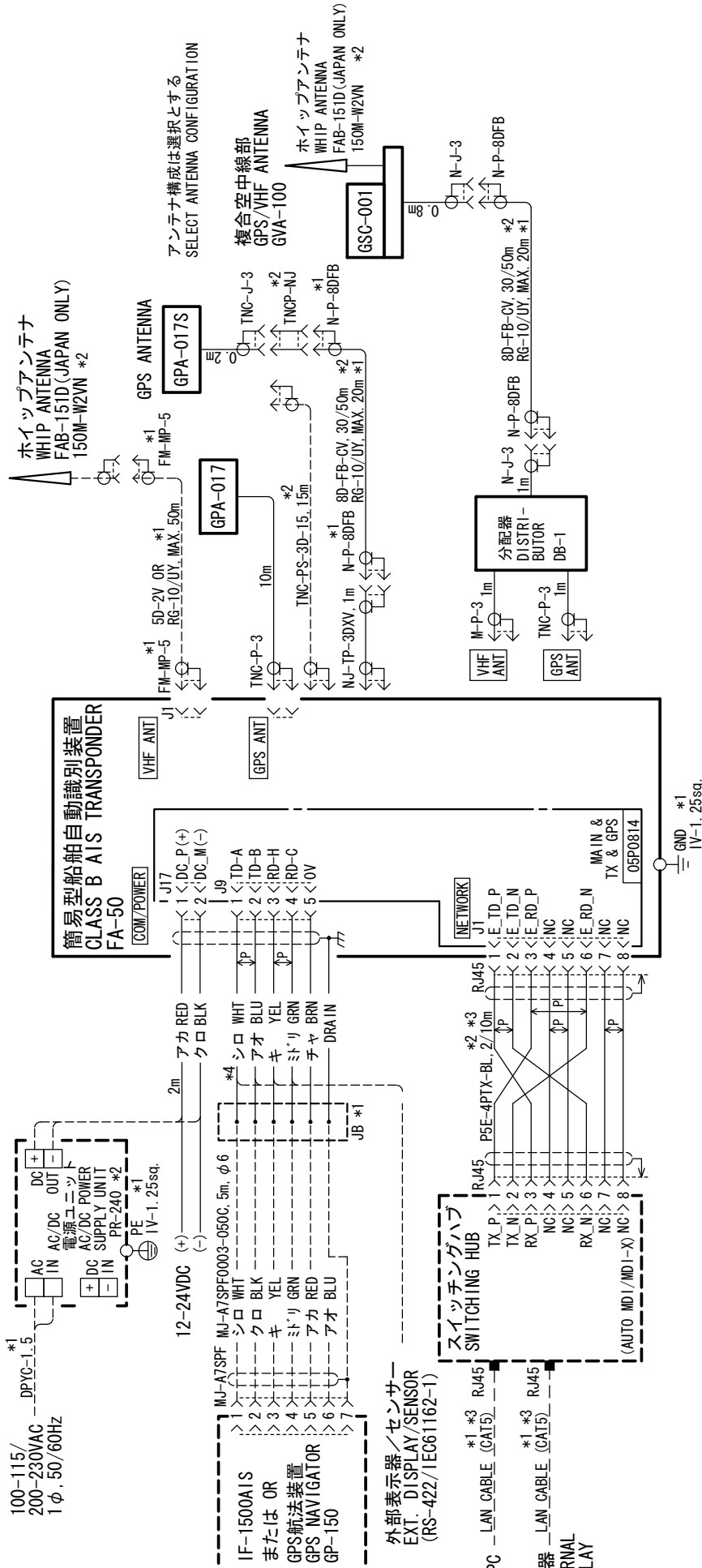

注記

- *1) 造船所手配。
- *2) オプション。
- *3) Auto MDI/MDI-X対応でないHUBのときは、ストレートケーブルを使用する。
- *4) COMラインを使用しないときは、芯線がショートしないようテープで絶縁する。

NOTE

- *1: SHIPYARD SUPPLY.
- *2: OPTION.
- *3: USE STRAIGHT LAN CABLE WHEN A HUB W/O AUTO MDI/MDI-X FUNCTION IS USED.
- *4: IF COM LINES ARE NOT USED, TAPE THEM TO PREVENT SHORT-CIRCUIT.

DRAWN	Jan. 8 '08	T. YAMASAKI	TYPE	FA-50
CHECKED	Jan. 9 '08	T. TAKENO	名称	簡易型船舶自動識別装置
APPROVED	Jan. 18 '08	R. Esumi	相互結線図	
SCALE	MASS	kg	NAME	CLASS B AIS TRANSPONDER
DWG. No.	C4442-C01-B	REF. No.	INTERCONNECTION DIAGRAM	

INDEX

A

AC-DC power supply1-9
alarm status2-7

C

COM PORT.....1-13

D

distributor1-8

F

Fuse3-2
fuse3-2

G

GPS antenna1-5
GPS/VHF combined antenna.....1-7

I

index termAP-6
IP address.....1-12

M

maintenance3-1
menu tree.....AP-1

N

NavNet1-11
NETWORK.....1-14

O

optional supply1-2
own vessel data2-4

P

parts lists.....AP-4
parts location.....AP-5

R

receiving message2-3

S

sending message2-2
sensor status.....2-8
serial interface I/O circuitAP-7
standard supply.....1-1
subnet mask.....1-12

T

troubleshooting3-2

V

VHF antenna.....1-3