



SAFETY INSTRUCTIONS

DANGER

Before turning on the radar, make sure that there is no one near the antenna.

Serious injury or even death may result if a rotating antenna strikes someone standing nearby.

WARNING

Do not place liquid-filled containers on the top of the equipment.

Fire or electrical shock can result if a liquid spills into the equipment.

Do not operate the equipment with wet hands.

Electrical shock can result.

Keep heater away from equipment.

Heat can alter equipment shape and melt the power cord, which can cause fire or electrical shock.

WARNING

Radio Frequency Radiation Hazard

The radar scanner emits electromagnetic radio frequency (RF) energy which can be harmful, particularly to your eyes. Never look directly into the scanner aperture from a close distance while the radar is in operation or expose yourself to the transmitting scanner at a close distance.

Distances at which RF radiation levels of 100 and 10 W/m² exist are given in the table below.

Note: If the scanner unit is installed at a close distance in front of the wheelhouse, your administration may require halt of transmission within a certain sector of scanner revolution. This is possible. Ask your FURUNO representative or dealer to provide this feature.

Model	Radiator type	Distance to 100W/m ² point	Distance to 10W/m ² point
FR-1760DS	SN4A	—	1.2 m
	SN5A	—	1.0 m
FR-1710	XN12AF	—	0.15 m
	XN20AF	—	—
FR-1725	XN20AF	—	1.1 m
	SN24AF	—	1.0 m



WARNING



ELECTRICAL SHOCK HAZARD
Do not open the equipment.

Only qualified personnel should work inside the equipment.



Turn off the radar power switch before servicing the scanner unit. Post a warning sign near the switch indicating it should not be turned on while the scanner unit is being serviced.

Prevent the potential risk of being struck by the rotating scanner and exposure to RF radiation hazard.



Wear a safety belt and hard hat when working on the scanner unit.

Serious injury or death can result if someone falls from the radar scanner mast.

Do not disassemble or modify the equipment.

Fire, electrical shock or serious injury can result.

Turn off the power immediately if water leaks into the equipment or the equipment is emitting smoke or fire.

Continued use of the equipment can cause fire or electrical shock.

Use the proper fuse.

Fuse rating is shown on the equipment. Use of a wrong fuse can result in equipment damage.

Keep heater away from equipment.

Heat can alter equipment shape and melt the power cord, which can cause fire or electrical shock.

Danger/Warning Labels in Display Unit

This radar system contains the danger/warning labels shown below. Do not remove the labels. If a label is peeling off or is illegible, contact a FURUNO agent for replacement.

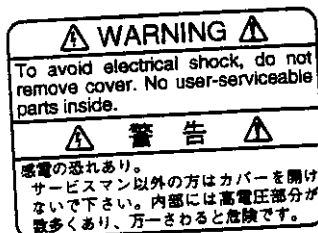

Name : Warning Label
Type : 86-003-1011
Code No. : 100-236-230



Name : Danger Label
Type : 14-055-4202
Code No. : 100-245-220

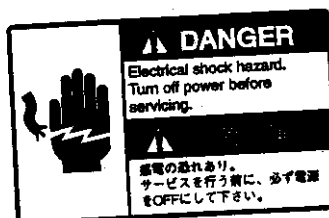

Name : Danger Label
Type : 66-022-2012
Code No. : 100-237-730

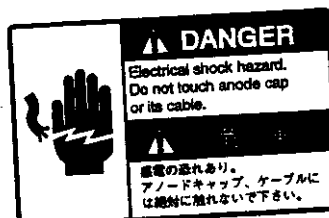

Name : Danger Label
Type : 14-055-4201
Code No. : 100-243-450

TABLE OF CONTENTS

INTRODUCTION	v
SYSTEM CONFIGURATION	vi
MENU TREE	vii
OPERATIONAL OVERVIEW	
1.1 Turning on the Power	1-1
1.2 Transmitter ON	1-1
1.3 Control Description	1-2
1.4 CRT Brilliance	1-3
1.5 Control Panel Backlighting	1-3
1.6 Tuning the Receiver	1-4
1.7 Degaussing the Screen	1-4
1.8 Initializing the Compass Readout	1-5
1.9 On-screen Legends and Markers	1-6
1.10 Presentation Modes	1-8
1.11 Selecting the Range Scale	1-9
1.12 Entering Own Ship's Speed	1-9
1.13 Pulselength, Echo Stretch	1-11
1.14 Adjusting the Sensitivity	1-11
1.15 Suppressing Sea Clutter	1-12
1.16 Suppressing Precipitation Clutter	1-12
1.17 Interference Rejector	1-12
1.18 Measuring the Range	1-13
1.19 Measuring Bearing	1-14
1.20 Collision Assessment by the Offset EBL	1-14
1.21 Measuring Range and Bearing Between Two Targets	1-15
1.22 Setting a Target Alarm Zone	1-16
1.23 Off-centering (shift)	1-17
1.24 Echo Averaging	1-18
1.25 Electronic Plotting Aid (EPA)	1-21
1.26 Target Trails (Echo Trails)	1-23
1.27 Parallel Index Lines	1-24
1.28 Origin Mark	1-24
1.29 Zoom	1-25
1.30 Markers	1-25
1.31 User Keys (F1, F2, F3)	1-26
1.32 Function Keys	1-27
1.33 Suppressing Second-trace Echoes	1-28
1.34 Adjusting Brilliance of Screen Data	1-28
1.35 Noise Rejector	1-28
1.36 Time Alarm	1-29
1.37 Enhanced Video	1-29
1.38 Degaussing Interval	1-30
1.39 Navigation Data	1-30
1.40 Video Contrast	1-30

1.41 Clutter Sweep	1-30
1.42 Outputting Target Position	1-31
1.43 Background Color	1-31
1.44 Selecting Range Scales	1-31
1.45 Selecting Bearing Scale Format	1-32
1.46 Alarms	1-33

RADAR OBSERVATION

2.1 General	2-1
2.2 False Echoes	2-2
2.3 SART (Search and Rescue Transponder)	2-3
2.4 RACON (Radar Beacon)	2-5

MAINTENANCE, TROUBLESHOOTING

3.1 Periodic Maintenance Schedule	3-1
3.2 Life Expectancy of Major Parts	3-2
3.3 Fuse Replacement	3-2
3.4 Replacement of Batteries	3-3
3.5 Simple Troubleshooting	3-3
3.6 Advanced-level Troubleshooting	3-4
3.7 Diagnostic Test	3-7

PARTS LOCATION	4-1
-----------------------------	-----

SPECIFICATIONS	SP-1
-----------------------------	------

INDEX

INTRODUCTION

A Word to the Owner of This FURUNO Radar

Thank you for purchasing this FURUNO radar. We are confident you will discover why FURUNO has become synonymous with quality and reliability.

Dedicated in the design and manufacture of marine electronics equipment for half a century, FURUNO Electric Company has gained an unrivaled reputation as a world leader in the industry. This is the result of our technical excellence as well as our worldwide distribution and service network.

Please carefully read and follow the safety information set forth in this manual before attempting to operate the equipment and conduct any maintenance. Your radar set will perform to the utmost of its ability only if it is operated and maintained in accordance with the correct procedures.

Features

- FR-1760DS is 60kW, S-band radar, FR-1710 is 10kW, X-band radar and FR-1725 is 25kW, X-band radar.
- Daylight-bright rasterscan 17-inch multi-color, high-resolution display
- New microprocessing technology with high-speed high-density gate array and software expertise
- Easy operation by combination of discrete keys, rotary controls, and menu operation, all logically arranged and configured
- Electronic Plotting Aid (EPA) fitted standard, Automatic Tracking Aid (ATA) option
- Reliable CPA and TCPA warning in any plotting mode, accurate target data
- The Clutter Sweep feature suppresses sea and rain clutters within an operator-selected area.
- A Video Plotter (Chart Plotter) and Performance Monitor are also optionally available.

SYSTEM CONFIGURATION

FR-1760DS

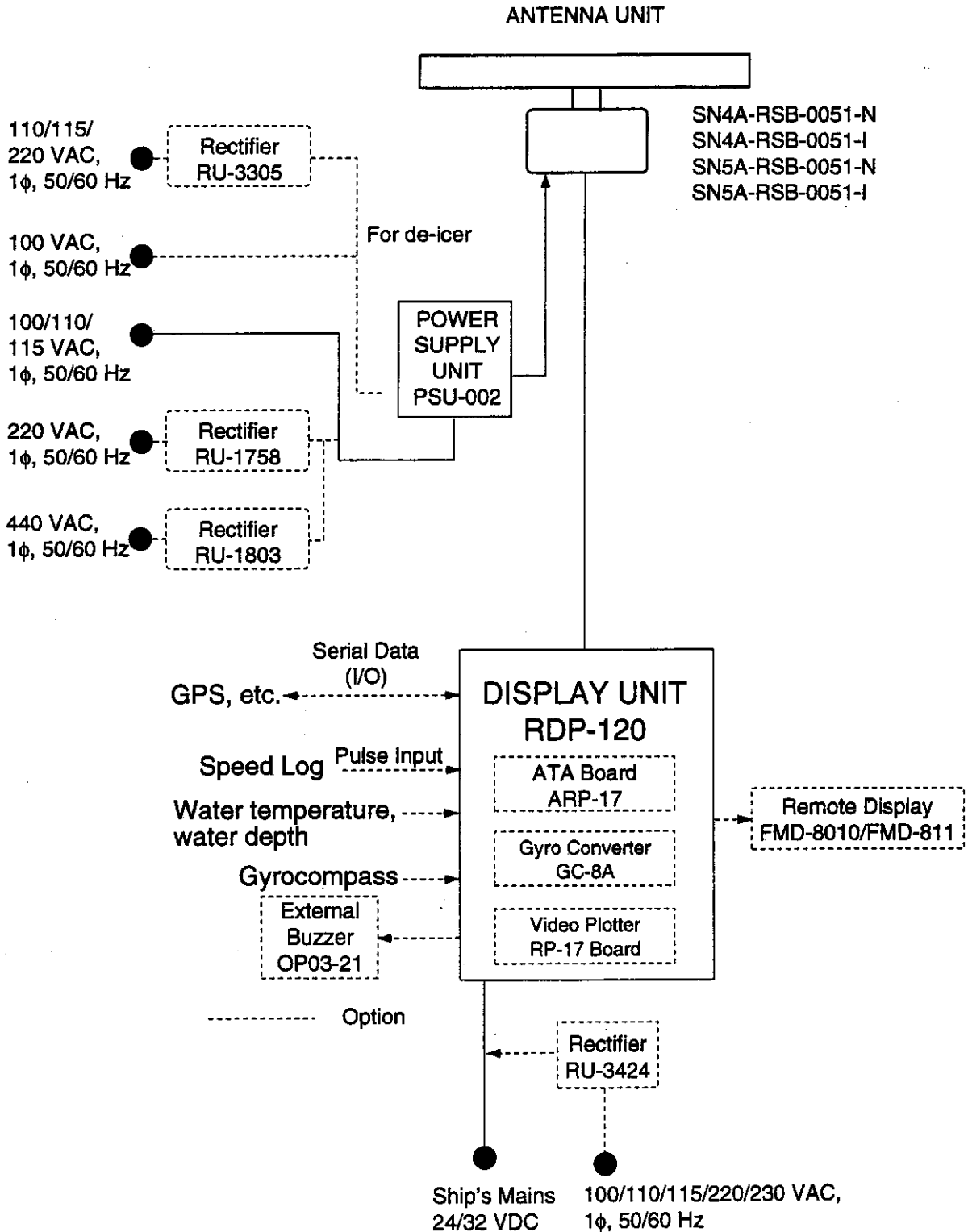

FR-1710/1725

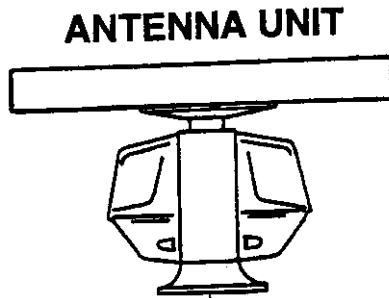

FR-1710

- XN12AF-RSB0074-062 (24 rpm)
- XN20AF-RSB0074-062 (24 rpm)
- XN12AF-RSB0075-062 (42 rpm)
- XN20AF-RSB0075-062 (42 rpm)

FR-1725

- XN20AF-RSB0074-063 (24 rpm)
- XN24AF-RSB0074-063 (24 rpm)
- XN20AF-RSB0075-063 (42 rpm)
- XN24AF-RSB0075-063 (42 rpm)

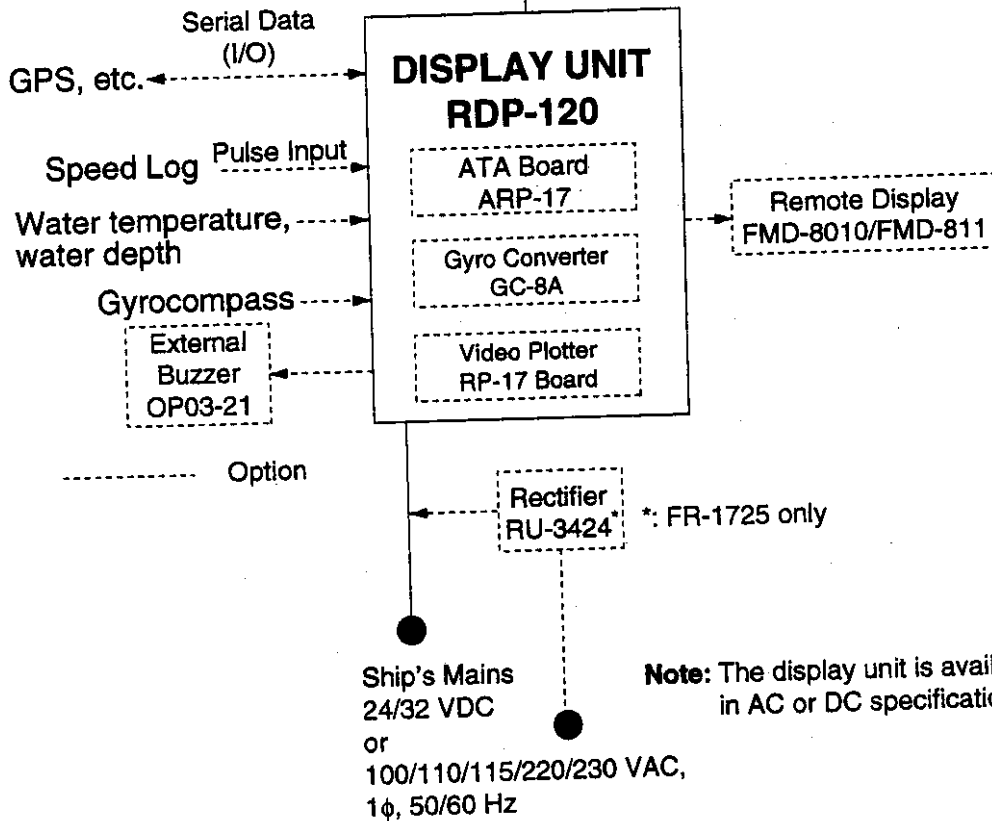

MENU TREE

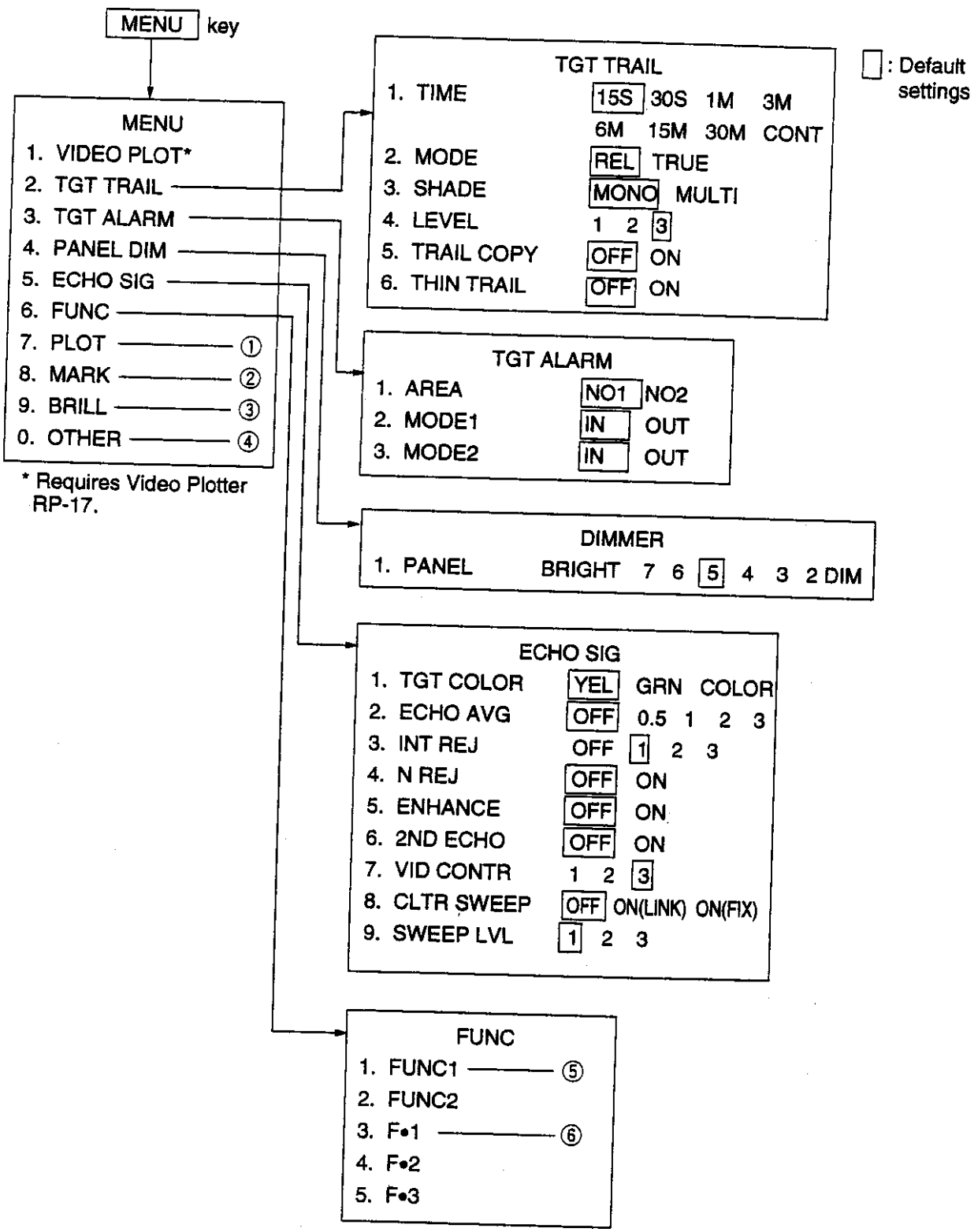

①

PLOT MENU 1

1. MARK DISP	OFF	<input checked="" type="checkbox"/>	ON
2. ERASE			
3. VECT REF	REL	<input checked="" type="checkbox"/>	TRUE
4. VECT TIME	<input checked="" type="checkbox"/>	30S	1 3 6
(min)		15 30	
5. CPA SET	<input checked="" type="checkbox"/>	OFF	0.5NM 1NM 1.5NM
		2NM 3NM 4NM	
		5NM	
6. TCPA SET	<input checked="" type="checkbox"/>	30S	1 2 3
(min)		4 5 6 12 15	
7. TRACK	OFF	<input checked="" type="checkbox"/>	ON
8. INTVAL*	<input checked="" type="checkbox"/>	30S	1 2 3 6
(min)			
9. TARGET BASED SPEED*			
0. ↓			

* Requires Automatic Tracking Aid ARP-17 (Option).

[0]

PLOT MENU 2*

1. ↑			
2. AUTO	<input checked="" type="checkbox"/>	OFF	ON SET
3. GUARD ZONE	<input checked="" type="checkbox"/>	OFF	ON SET
4. TRACK TEST			
5. LAND DISCRIM	0 1	<input checked="" type="checkbox"/>	2 3 4 5
6. TTM	<input checked="" type="checkbox"/>	OFF	REL TRUE
7. VECT START	<input checked="" type="checkbox"/>	1MIN	20SCAN
8. REF TGT VECT	<input checked="" type="checkbox"/>	OFF	ON

②

MARK

1. ERASE	
2. MODE	<input checked="" type="checkbox"/> REL TRUE

③

BRILL

1. TGT TRAIL	<input type="checkbox"/>
2. CHARACTER	<input type="checkbox"/>
3. HDG LINE	<input type="checkbox"/>
4. EBLVRM	<input type="checkbox"/>
5. CURSOR	<input type="checkbox"/>
6. MARK	<input type="checkbox"/>
7. PLOT	<input type="checkbox"/>
8. OS SYMB	<input type="checkbox"/>
9. ↓	

* Requires Video Plotter RP-17 (option).

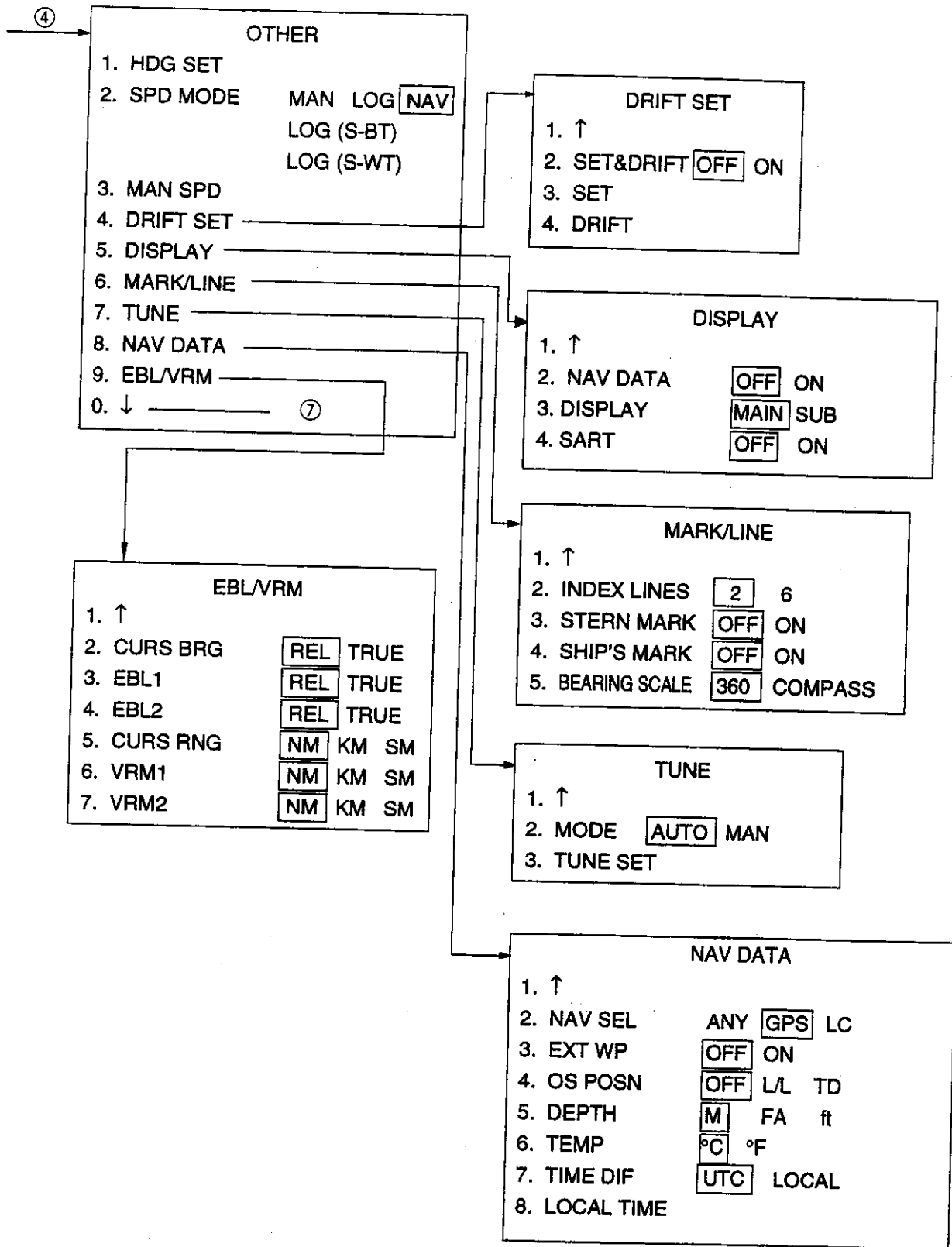

OPERATIONAL OVERVIEW

1.1 Turning on the Power

The [POWER] switch is located at the top left corner of the display unit. Push it to switch on the radar set. To turn off the radar, push it again. The screen shows the bearing scale and digital timer approximately 15 seconds after power-on. The timer counts down three minutes of warm-up time. During this period the magnetron, that is, the transmitter tube, is warmed for transmission. When the timer has reached 0:00, the indication STBY appears, indicating that the radar is now ready to transmit pulses.

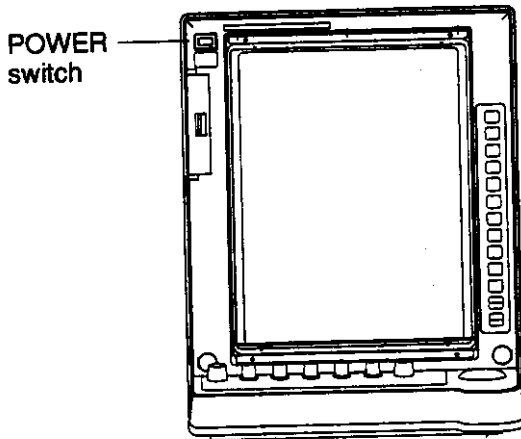

Figure 1-1 Location of power switch

1.2 Transmitter ON

After the power has been turned on and the magnetron has warmed, STBY (Standby) appears at the screen center, indicating the radar is ready to transmit radar pulses.

Press the [STBY/TX] key to transmit.

When you won't be using the radar for an extended period, but you want to keep it in a state of readiness, place it in standby by pressing the [STBY/TX] key. The display shows STBY when the radar is in standby.

Video Lockup Recovery

Video freeze-up or lock-up, can occur unexpectedly on digital rasterscan radars. This is mainly caused by heavy spike noise in the power line and can be noticed by carefully watching the nearly invisible sweep line. If you suspect that the picture is not updated every scan of the antenna or no key entry is accepted notwithstanding the apparently normal picture, do Quick Start to restore normal operation.

1. Turn off the POWER switch and turn it on again within 10 seconds.
2. Push the Transmit switch labeled STBY/TX for Transmit status.

DANGER

Before turning on the radar, make sure that there is no one near the antenna.

Serious injury or even death may result if a rotating antenna strikes someone standing nearby.

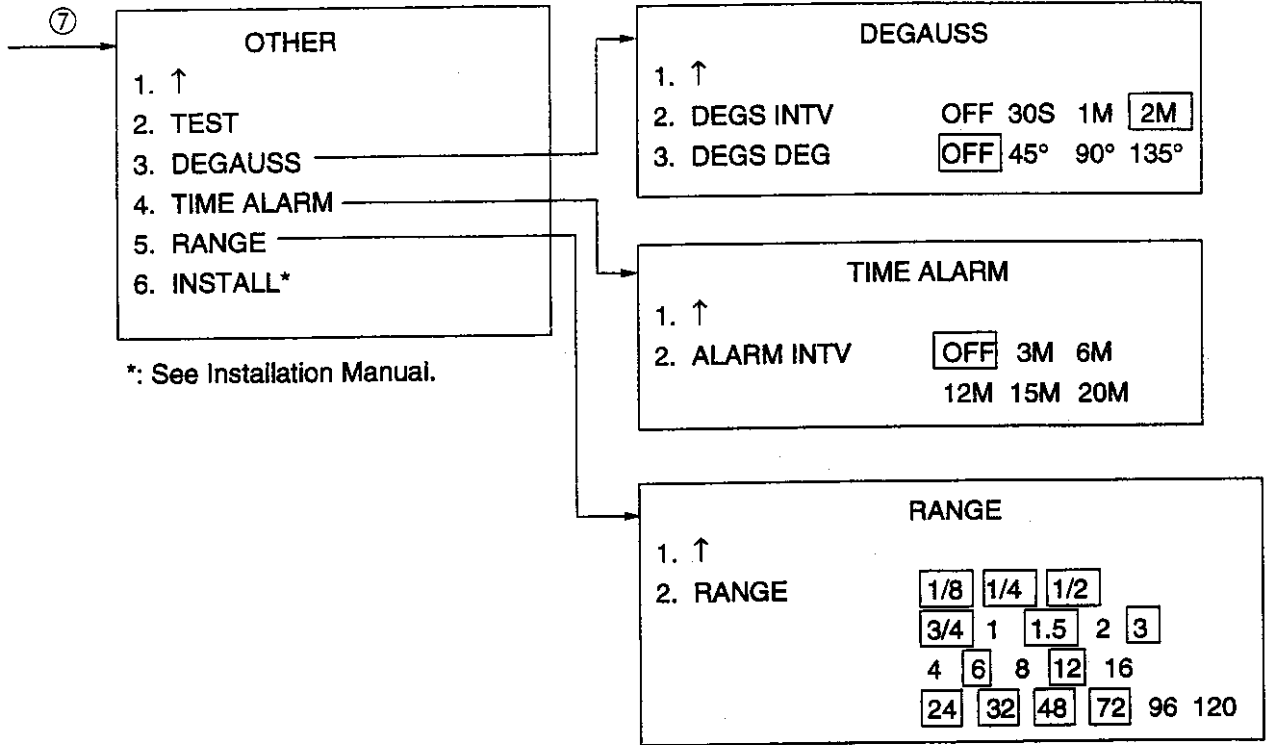

*: See Installation Manual.

FR-1760DS Max. range: 120 NM
 FR-1710 Max. range: 72 NM
 FR-1725 Max. range: 96 NM

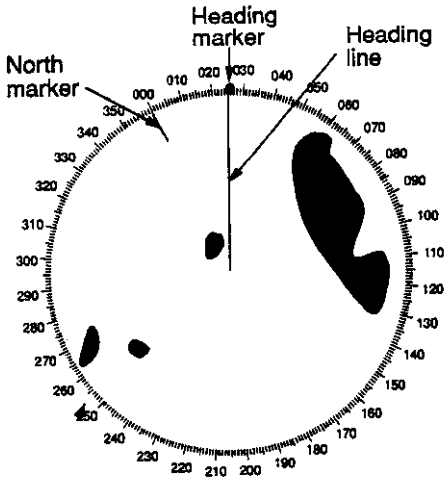
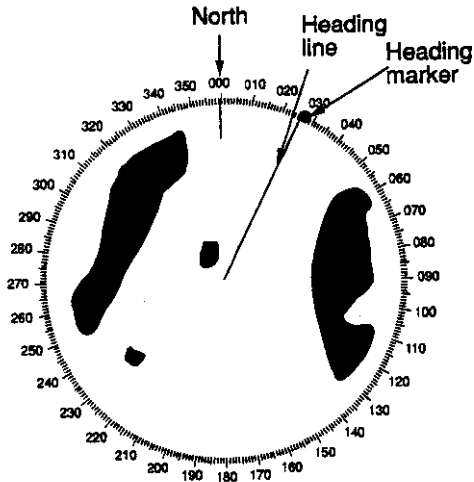
Presentation mode, representative display	Description
 <p>The diagram shows a circular radar display with a heading scale from 000 to 360 degrees. A vertical line, labeled 'Heading line', is positioned at 030 degrees. A 'Heading marker' is located at the top of the scale (000 degrees). A 'North marker' is also shown at 000 degrees. Several target pips of varying sizes are plotted on the scale, representing different vessels at various bearings and distances.</p>	<p>Course-up Mode</p> <p>An azimuth stabilized display in which a line connecting the center with the top of the display indicates own ship's intended course (namely, own ship's previous heading just before this mode has been selected). Target pips are painted at their measured distances and in their directions relative to the intended course which is maintained at the top of screen while the heading line moves in accordance with ship's yawing and course changes. This mode is useful to avoid smearing of picture during course change. After a course change, press the [SHIFT] key to reset the picture orientation if you wish to continue using the course-up mode. The heading line gets back to perpendicular.</p>
 <p>The diagram shows a circular radar display with a heading scale from 000 to 360 degrees. A 'North' marker is at the top of the scale (000 degrees). A 'Heading line' is shown at approximately 030 degrees. A 'Heading marker' is located at the top of the scale (000 degrees). Several target pips are plotted on the scale, representing different vessels at various bearings and distances.</p>	<p>North-up Mode</p> <p>In the north-up mode, target pips are painted at their measured distances and in their true (compass) directions from own ship, north being maintained up of the screen. The heading line changes its direction according to the ship's heading.</p> <p>If the compass fails, the presentation mode changes to head-up and the north marker disappears. Also, the HDG readout shows xxx.x°.</p>

1.3 Control Description

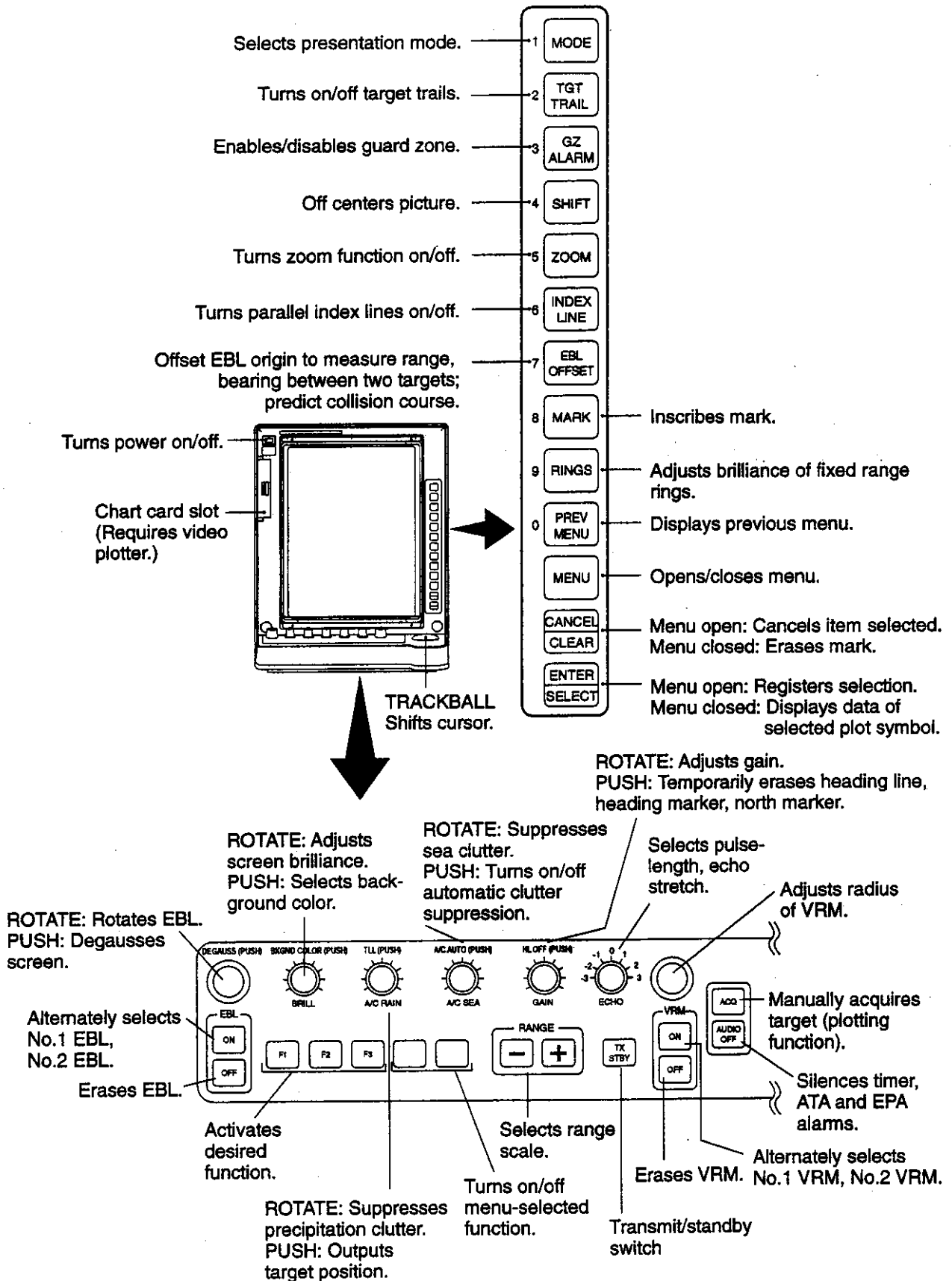

Figure 1-2 Control description

1.12 Entering Own Ship's Speed

EPA requires an own ship speed input and compass signal. The speed can be entered from a speed log or navaid (automatic) or through the plotting keypad (manual).

Automatic speed input

1. Press the [MENU] key and the [0] key twice to show the OTHER menu.

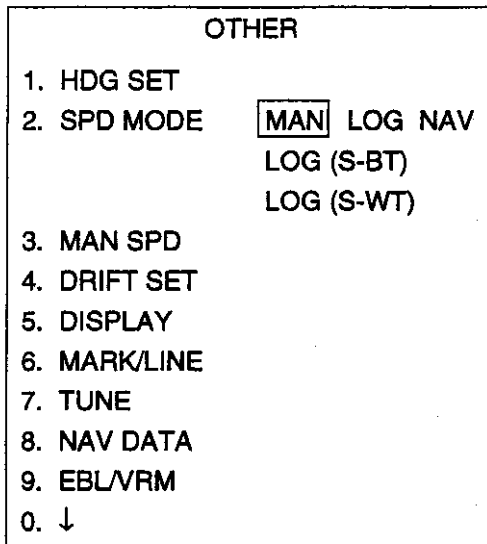

Figure 1-9 OTHER menu

2. Press the [2] key to select the menu item SPD MODE.
3. Press the [2] key again to select the LOG or NAV.

LOG: Pulse input from speed log
NAV: Speed data from navigation equipment
LOG (S-BT): Speed over ground from speed sensor
LOG (S-WT): Speed relative to water from speed sensor

4. Press the [ENTER/SELECT] key to confirm your selection followed by the [MENU] key to close the menu. The ship's speed readout at the top of the screen shows own ship's speed fed from the speed log with the label LOG, or navaid with the label NAV.

Note: Be sure not to select a LOG option or NAV when respective equipment is not connected. If the log signal or navaid signal is not provided, the ship's speed readout at the screen top will be blank.

Manual speed input

If the radar is not interfaced with a speed log, or the speed log does not feed correct speed enter the ship's speed as follows:

1. Press the [MENU] key and the [0] key twice to show the OTHER menu.
2. Press the [2] key to select MAN from the SPD MODE field, and then press the [ENTER/SELECT] key.
3. Press the [3] key twice to select the MAN SPD field.
4. Enter speed with the numeric keys.
5. Press the [ENTER/SELECT] key to confirm your selection followed by the [MENU] key to close the menu. The ship's speed readout at the top of the screen shows own ship's speed fed from the speed log with the label "MAN."

1.13 Pulselength, Echo Stretch

The ECHO control selects pulselength, and echo stretch when it is not turned on with a user key ([F1], [F2], [F3]). The pulselength in use is displayed at the upper-left position of the screen using the abbreviations (suffixed with "P") shown in the table on the next page. Echo stretch level (ES1, ES2) in use appears at the bottom left position, using the indication ES1 or ES2.

Appropriate pulselengths are preset to individual range scales and function keys. Therefore, you are not usually required to select them. If you are not satisfied with the current pulselength settings, however, it is possible to change them by the ECHO control. The ECHO control settings which can select the echo stretch are shown in the table below. The legend and pulselengths are S1P, 0.08 μ s; M1P, 0.2 μ s; M2P, 0.6 μ s, LP, 1.2 μ s.

On long ranges target echoes tend to shrink in the bearing direction, making them difficult to see. On short and medium ranges such as 1.5, 3 and 6 nm scales, the same size targets get smaller on screen as they approach the own ship. These are due to the

3. Press the [7] key twice to display the TUNE menu.

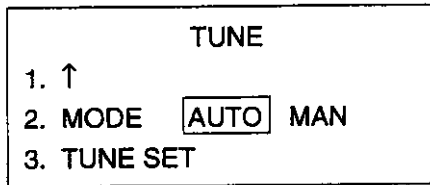

Figure 1-6 TUNE menu

4. Press the [2] key to select the option AUTO or MAN from the MODE field.
5. Press the [ENTER/SELECT] key.
6. Press the [MENU] key to close the menu.

1.7 Degaussing the Screen

Each time the radar is turned on, the degaussing circuit automatically demagnetizes the CRT screen to eliminate color contamination caused by earth's magnetism or magnetized ship structure.

The screen is also degaussed automatically at certain time intervals, which may be selected on the menu. While being degaussed, the screen may be disturbed momentarily with vertical lines. If you wish to degauss by manual operation, push the EBL rotary control (DEGAUSS control).

1.8 Initializing the Compass Readout

With a compass interfaced with the radar, ship's heading is displayed at the top of the screen. Upon turning on the radar, match the on-screen HDG readout with the compass reading by the procedure shown below. Once you have set the initial heading correctly, re-setting is not usually required. However, if the HDG readout goes wrong for some reason, repeat the procedure to correct it.

1. Press the [MENU] key to display the main menu.
2. Press the [0] key twice to display the OTHER menu.

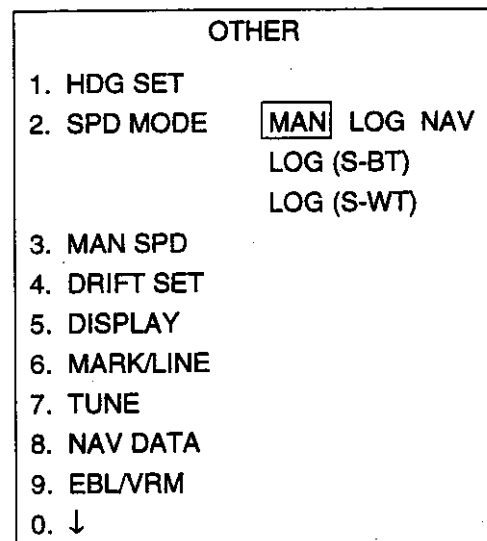

Figure 1-7 OTHER menu

3. Press the [1] key to select HDG SET.
4. Operate the VRM rotary control to duplicate the compass readout on the radar menu display.
5. Press the [ENTER/SELECT] key.
6. Press the [MENU] key to close the menu.

1.14 Adjusting the Sensitivity

The GAIN control adjusts the sensitivity of the receiver. It works in precisely the same manner as the volume control of a broadcast receiver, amplifying the signals received.

The proper setting is such that the background noise is just visible on the screen. If you set up for too little sensitivity, weak echoes may be missed. On the other hand excessive sensitivity yields too much background noise; strong targets may be missed because of the poor contrast between desired echoes and the background noise on the display.

To adjust receiver sensitivity, transmit on long range, and adjust the GAIN control so background noise is just visible on the screen. The current gain setting is shown by the "GAIN bar" at the top right-hand corner of the screen.

1.15 Suppressing Sea Clutter

Echoes from waves cover the central part of the display with random signals known as sea clutter. The higher the waves, and the higher the scanner above the water, the further the clutter will extend. When sea clutter masks the picture, suppress it by the A/C SEA control, rotate for manual adjustment, push for automatic adjustment.

Manual adjustment by the A/C SEA control

The A/C SEA control reduces the amplification of echoes at short ranges (where clutter is the greatest) and progressively increases amplification as the range increases, so amplification will be normal at those ranges where there is no sea clutter.

The proper setting of the A/C SEA control should be such that the clutter is broken up into small dots, and small targets become distinguishable.

If the control is set too low, targets will be hidden in the clutter, while if it is set too high, both sea clutter and targets will disappear from the display. In most cases adjust the control until clutter has disappeared to leeward, but a little is still visible windward.

1. Confirm that the sensitivity is properly adjusted, and then transmit on short range.
2. Adjust the A/C SEA control so small targets are distinguishable but some clutter remains on the display.

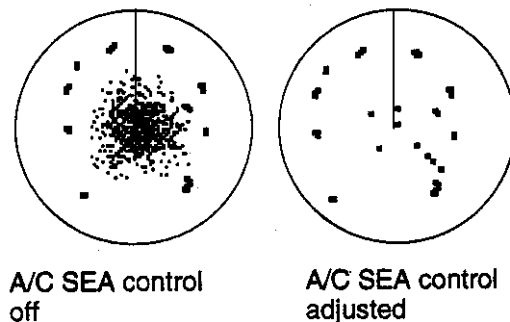

Figure 1-11 How to adjust the A/C SEA control

Automatic adjustment by the A/C AUTO control

The A/C AUTO control automatically suppresses sea clutter as well as rain clutter. Push the A/C SEA control to turn on the automatic A/C circuit. A/C AUTO appears at the bottom left corner when the A/C AUTO circuit is on. Fine adjustment of the circuit can be done with the A/C RAIN and A/C SEA controls.

CAUTION

Turn off the A/C AUTO feature when its use is not required; it can erase weak target echoes.

1.10 Presentation Modes

This radar has the following presentation modes: Head-up, Head-up/TB, Course-up, North-up, and True Motion.

Selecting presentation mode

Press the [MODE] key on the panel at the right side of the display unit. Each time the [MODE] key is pressed, the presentation mode and mode indication at the upper-left corner of the screen change cyclically.

Note: When a failure occurs in the gyrocompass, the radar will automatically be switched to unstabilized presentation mode. All compass related data will read Relative values.

Loss of Compass Signal

When the compass signal is lost, the buzzer sounds once, the presentation mode becomes head-up and the compass readout shows $xxx.x^\circ$. After restoring the compass signal, press the [MODE] key to display the compass readout. Readjust the compass readout as shown on page 1-4. Also GYRO SIGNAL MISSING appears at the bottom of the screen.

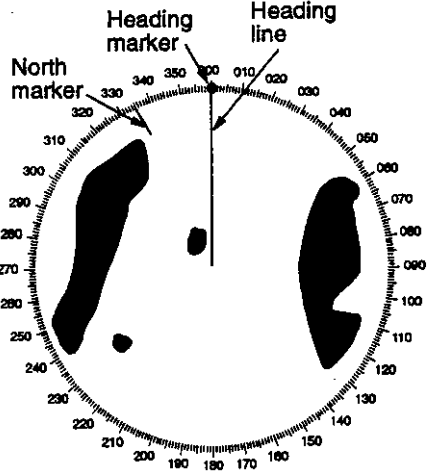
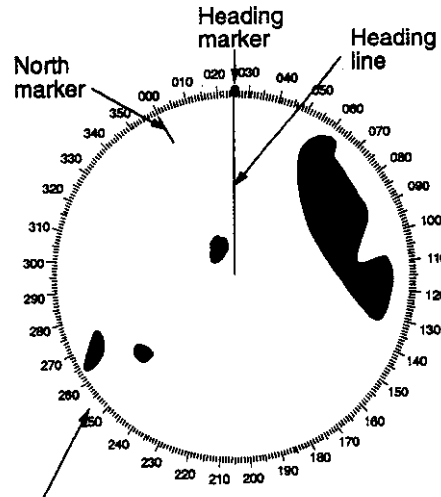
Presentation mode, representative display	Description
	<p>Head-up Mode</p> <p>A display without azimuth stabilization in which the line connecting the center with the top of the display indicates own ship's heading.</p> <p>The target pips are painted at their measured distances and in their directions relative to own ship's heading.</p> <p>A short line on the bearing scale is the north marker indicating compass north. A failure of the compass input will cause the north marker to disappear and the HDG readout to show asterisks $xxx.x^\circ$.</p>
 <p>The bearing scale rotates with a compass signal.</p>	<p>Head-up TB (True Bearing) Mode</p> <p>Radar echoes are shown in the same way as in the head-up mode. The difference from normal head-up presentation lies in the orientation of the bearing scale. The bearing scale is compass stabilized, that is, it rotates in accordance with the compass signal, enabling you to know own ship's heading at a glance.</p> <p>This mode is available only when the radar is interfaced with a compass.</p> <p>If the compass fails, the bearing scale returns to the state of head-up mode.</p>

Measuring range by the variable range marker (VRM)

Use the Variable Range Markers (VRMs) for more accurate measurement of the range to a target. There are two VRMs, No.1 and No.2, which appear as dashed rings so that you can discriminate them from the fixed range rings. The two VRMs can be distinguished from each other by different lengths of dashes.

1. Press the [VRM ON] key to display either of the VRMs. Successive presses of the [VRM ON] key toggle the active VRM between No.1 and No.2 and the currently active VRM readout is circumscribed.
2. Rotate the VRM rotary control clockwise or counterclockwise to align the active VRM with the inner edge of the target of interest and read its distance (unit: nm) at the lower-right corner of the screen. Each VRM remains at the same geographical distance when you operate the [RANGE] key. This means that the apparent radius of the VRM ring changes in proportion to the selected range scale.
3. Press the [VRM OFF] key to erase each VRM.

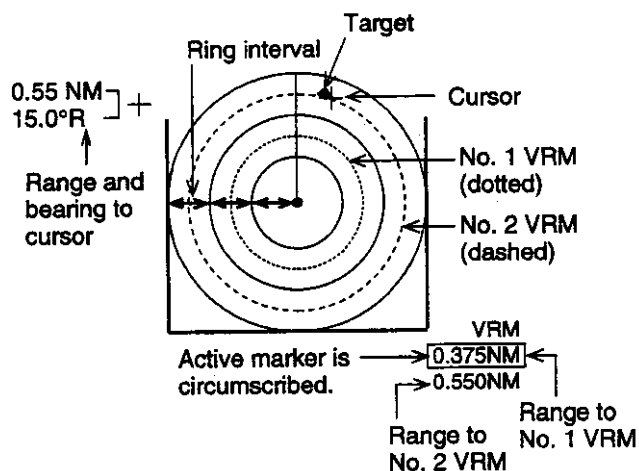

Figure 1-15 How to measure range by VRM

1.19 Measuring Bearing

Use the Electronic Bearing Lines (EBLs) to find bearing of a target. There are two EBLs, No.1 and No.2, which are toggled by successive presses of the [EBL ON] key. Each EBL is a straight dashed line extending out from the own ship position up to the circumference of the radar picture. The fine dashed line is the No.1 EBL and the coarse dashed one is the No.2 EBL.

1. Press the [EBL ON] key to display either of the EBLs. Successive presses of the [EBL ON] key toggle the active EBL between No.1, No.2 and index lines (if displayed) and the currently active EBL readout is circumscribed.
2. Rotate the EBL rotary control clockwise or counterclockwise until the active EBL bisects the target of interest, and read its bearing at the lower-left corner of the screen.
3. Press the [EBL OFF] key to erase each EBL.

The EBL readout is affixed by "R" (relative) if it is relative to own ship's heading, or "T" (true) if it is referenced to the North, as determined by the item EBL/VRM on the OTHER menu.

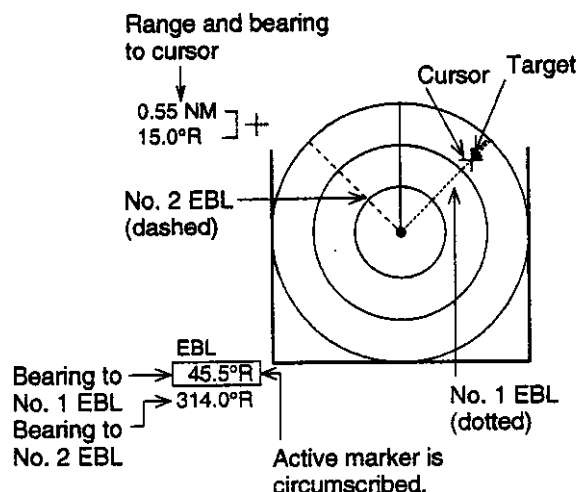
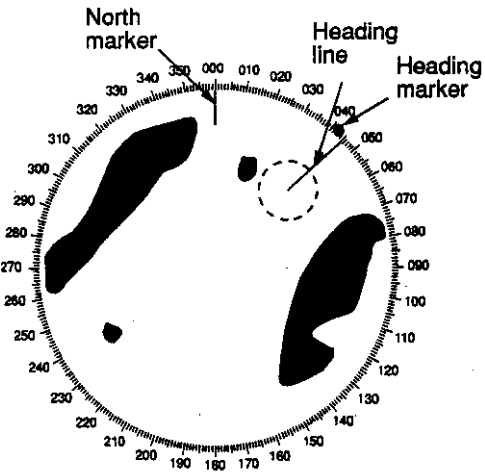
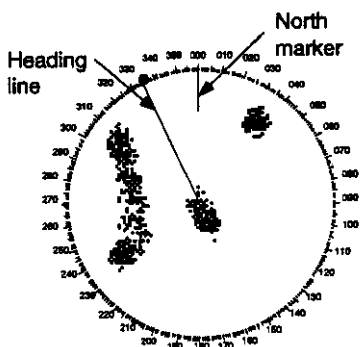
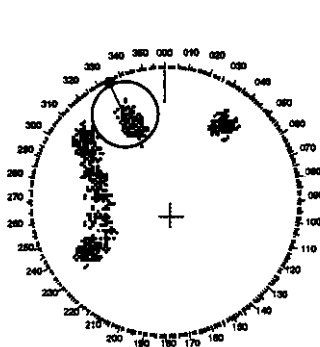

Figure 1-16 How to measure bearing by EBL

Presentation mode, representative display	Description
	<p>True Motion Mode</p> <p>Own ship and other moving objects move in accordance with their true courses and speeds. In ground stabilized TM, all fixed targets, such as landmasses, appear as stationary echoes. In the sea stabilized TM without set and drift input, the landmass can move on the screen.</p> <p>When own ship reaches a point corresponding to 75% of the radius of the display, the own ship is automatically reset to a point of 75% radius opposite to the extension of the heading line passing through the display center. Resetting can be made at any moment before the ship reaches the limit by pressing the [SHIFT] key. Automatic resetting is preceded by a beep sound.</p> <p>If the compass fails, the presentation mode is changed to the head-up mode and the north marker disappears. The HDG readout at the top of the screen shows xxx.x°.</p>



(a) True motion is selected



(b) Own ship has reached a point 75% of display radius

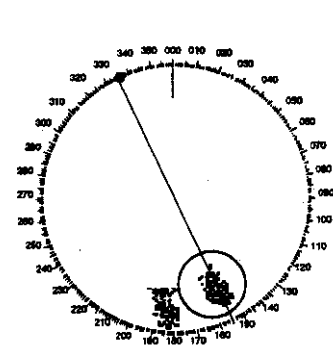

(c) Own ship is automatically reset to 75% of radius

Automatic resetting of own ship position in true motion mode

1.11 Selecting the Range Scale

The range selected automatically determines the range ring interval, the number of range rings and pulse repetition rate, for optimal detection capability in short to long ranges. You can select pulseshift with the ECHO control. For details, see paragraph 1.13.

Press the [RANGE] key to select a range scale. The range, range ring interval and pulseshift appear at the top left corner of the display.

You can repeat the same procedure on third and fourth targets (targets 3 and 4) by using the No.2 EBL and No.2 VRM.

Bearing is shown relative to own ship with suffix "R" or as a true bearing with suffix "T" depending on EBL relative/true settings on the OTHER menu.

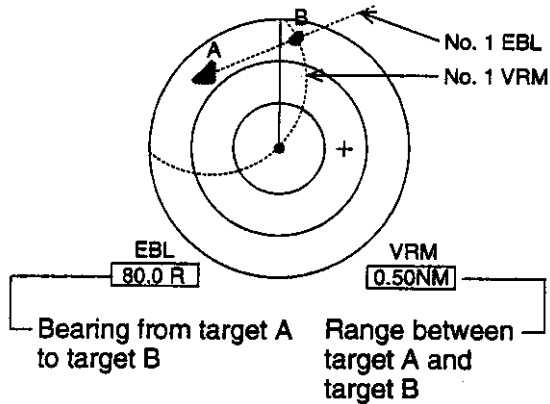

Figure 1-18 Measuring range and bearing between two targets

1.22 Setting a Target Alarm Zone

CAUTION

The target alarm feature should never be relied upon as the sole means for detecting the risk of potential collision. The operator of a ship is not relieved of the responsibility to keep lookout for avoiding collisions, whether or not the radar is in use.

The target alarm serves to alert the navigator to targets (ships, landmasses, etc.) entering a certain area, with visual and audible alarms.

The zone has a fixed width of 0.5 nm in the radial direction (depth) and is adjustable only within 3.0 to 6.0 nm from own ship. The outer and inner boundaries can be set at any distance. The sector of the zone can be set anywhere between 0 and 360 degrees in any direction.

To set target alarm zones:

1. Press the [MENU] key.

2. Press the [3] key twice to show the TGT ALARM menu.

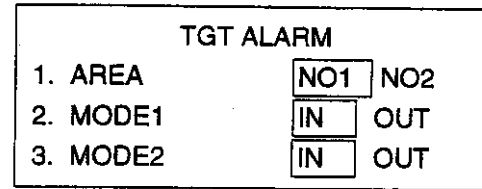

Figure 1-19 TGT ALARM menu

2. Press the [1] key to select target alarm zone to use; NO1 or NO2.
3. Press the [ENTER/SELECT] key.
4. Press the [MENU] key.
5. Place the cursor (+) at point "A" (see figure below) using the trackball. Press the [GZ ALARM] key. GZ1 (or GZ2) SET appears. When both alarms are prepared the active alarm is circumscribed.
6. Move the cursor (+) to point "B" and press the [GZ ALARM] key again. Then, an echo watch zone as illustrated is created and the label IN (or OUT) replaces SET at the lower-right corner of the screen.

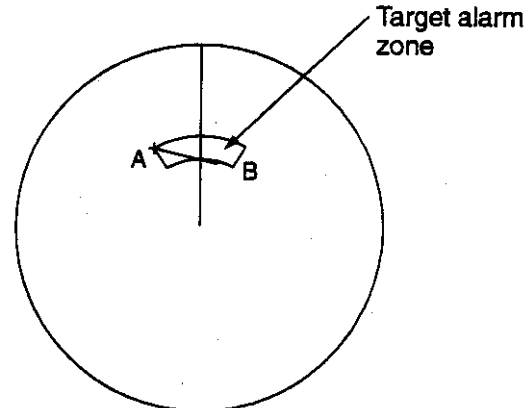

Figure 1-20 Target alarm

Note: If you wish to create a target alarm zone having a 360-degree coverage around own ship, set point "B" in almost the same direction (approx. $\pm 3^\circ$) as point "A" and press the [GZ ALARM] key.

Two alarm zones can be set as described above. To change the active alarm zone, do steps 1 thru 4 in the above procedure. (When both alarms are prepared the active alarm is circumscribed.)

inherent property of the radiation pattern of the antenna. To enhance target video, use the echo stretch function. There are two types: echo stretch 1 (ES1) to enlarge in bearing direction for long range detection, and echo stretch 2 (ES2) to enlarge in range direction.

Note: The echo stretch magnifies not only small target pips but also returns (clutter) from sea surface, rain and radar interference. For this reason make sure these types of interference have been sufficiently suppressed before activating this function.

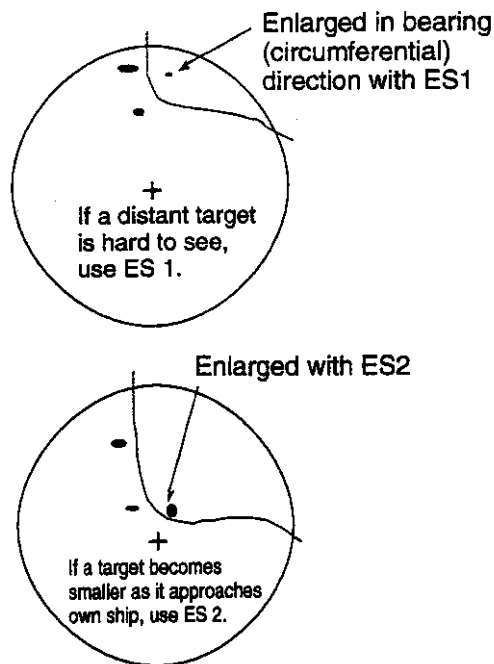

Figure 1-10 Echo stretch

Table 1-1 ECHO control setting, pulselength and echo stretch

ECHO Control Position							
Range	-3	-2	-1	0	1	2	3
0.125	S1P	S1P	S1P	S1P	S1P, ES1	S1P, ES1	S1P, ES1
0.25	S1P	S1P	S1P	S1P	S1P, ES1	S1P, ES1	S1P, ES1
0.5	S1P	S1P	S1P	S1P	S1P, ES1	S1P, ES1	S1P, ES1
0.75	S1P	S1P	S1P	S1P	S1P, ES1	M1P	M1P, ES1
1	S1P	S1P	S1P	S1P	S1P, ES1	M1P	M1P, ES1
1.5	S1P	S1P	S1P	S1P	S1P, ES1	M1P	M1P, ES1
2	S1P	S1P	S1P, ES1	M1P	M1P, ES1	M1P, ES2	M1P, ES2
3	S1P	S1P	S1P, ES1	M1P	M1P, ES1	M1P, ES2	M1P, ES2
4	M1P	M1P	M1P, ES1	M2P	M2P, ES2	M2P, ES2	M2P, ES2
6	M1P	M1P	M1P, ES1	M2P	M2P, ES2	M2P, ES2	M2P, ES2
8	M1P	M1P	M1P, ES1	M2P	M2P, ES2	LP	LP, ES2
12	M1P	M1P	M1P, ES1	M2P	M2P, ES2	LP	LP, ES2
16	M2P	M2P	M2P, ES1	LP	LP, ES1	LP, ES2	LP, ES2
24	M2P	M2P	M2P, ES1	LP	LP, ES1	LP, ES2	LP, ES2
32	LP	LP	LP	LP	LP, ES1	LP, ES2	LP, ES2
48	LP	LP	LP	LP	LP, ES1	LP, ES2	LP, ES2
64	LP	LP	LP	LP	LP, ES1	LP, ES2	LP, ES2
72	LP	LP	LP	LP	LP, ES1	LP, ES2	LP, ES2
96	LP	LP	LP	LP	LP, ES1	LP, ES2	LP, ES2
120	LP	LP	LP	LP	LP, ES1	LP, ES2	LP, ES2

1.24 Echo Averaging

The echo average feature effectively suppresses sea clutter. Echoes received from stable targets such as ships appear on the screen at almost the same position every rotation of the scanner. On the other hand, unstable echoes such as sea clutter appear at random positions.

To distinguish real target echoes from sea clutter, echo average performs scan-to-scan correlation. Correlation is made by storing and averaging echo signals over successive picture frames. If an echo is solid and stable, it is presented in its normal intensity. Sea clutter is averaged over successive scans resulting in the reduced brilliance, making it easier to discriminate real targets from sea clutter.

To properly use the echo average function, it is recommended to first suppress sea clutter with the A/C SEA control and then do the following:

1. Press the [MENU] key.
2. Press the [5] key twice to select the ECHO SIG menu.

ECHO SIG				
1. TGT COLOR	<input type="text" value="YEL"/>	GRN	COLOR	
2. ECHO AVG	<input type="text" value="OFF"/>	0.5	1	2 3
3. INT REJ	<input type="text" value="OFF"/>	1	2	3
4. N REJ	<input type="text" value="OFF"/>	ON		
5. ENHANCE	<input type="text" value="OFF"/>	ON		
6. 2ND ECHO	<input type="text" value="OFF"/>	ON		
7. VID CONTR	<input type="text" value="1"/>	2	3	
8. CLTR SWEEP	<input type="text" value="OFF"/>	ON(LINK)	ON(FIX)	
9. SWEEP LVL	<input type="text" value="1"/>	2	3	

Figure 1-23 ECHO SIG menu

3. Press the [2] key to select echo averaging level (OFF, 0.5, 1, 2, 3) from the ECHO AVG field.

OFF: No averaging effect

0.5: Distinguishes small targets from sea clutter.

1: Distinguishes targets from sea clutter and suppresses brilliance of unstable echoes.

- 2: Distinguishes small stationary targets such as navigation buoys.
- 3: Stably displays distant targets.

4. Press the [ENTER/SELECT] key to conclude your selection followed by the [MENU] key to close the menu.

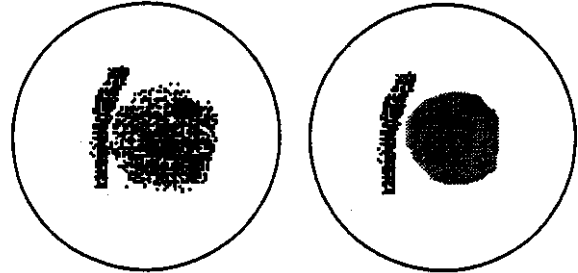

(a) Echo average OFF (b) Echo average ON

Figure 1-24 Echo averaging

Echo averaging uses scan-to-scan signal correlation technique based on the true motion over the ground of each target. Thus, small stationary targets such as buoys will be shown while suppressing random echoes such as sea clutter. True echo average is not however effective for picking up small targets running at high speeds over the ground.

Echo average requires log and compass signals. If you wish to use this feature without a compass signal, consult a FURUNO representative.

Manual speed entry is done at the menu item MAN SPD on the OTHER menu, which is accessed by pressing the [MENU] and [0] (twice) keys.

1.16 Suppressing Precipitation Clutter

The vertical beamwidth of the scanner is designed to see surface targets even when the ship is rolling. However, by this design the unit will also detect rain clutter (rain, snow, or hail) in the same manner as normal targets. Figure 1-12 shows the appearance of rain clutter on the display.

The A/C RAIN control adjusts the receiver sensitivity as the A/C SEA control does but rather in a longer time period (longer range). Clockwise rotation of this control increases the anti-clutter effect.



A/C RAIN control
OFF

A/C RAIN control
adjusted

Figure 1-12 Effect of A/C RAIN control

1.17 Interference Rejector

Mutual radar interference may occur in the vicinity of another shipborne radar operating in the same frequency band (9 GHz). It is seen on the screen as a number of bright spikes either in irregular patterns or in the form of usually curved spoke-like dotted lines extending from the center to the edge of the picture. This type of interference can be reduced by activating the interference rejector circuit.

The interference rejector is a kind of signal correlation circuit. It compares the received signals over successive transmissions and suppresses randomly occurring signals. There are three levels of interference rejection depending on the number of transmissions that are correlated. These are indicated by the legends IR1, IR2 and IR3 at the lower-left position of the screen.

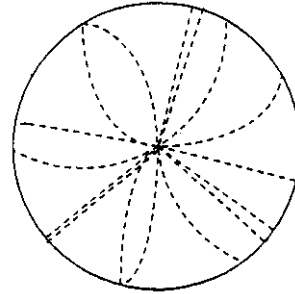

Figure 1-13 Interference

To activate the interference rejector;

1. Press the [MENU] key.
2. Press the [5] key twice to select ECHO SIG.

ECHO SIG			
1. TGT COLOR	<input type="checkbox"/> YEL	GRN	COLOR
2. ECHO AVG	<input type="checkbox"/> OFF	0.5 1 2 3	
3. INT REJ	<input type="checkbox"/> OFF	1 2 3	
4. N REJ	<input type="checkbox"/> OFF	ON	
5. ENHANCE	<input type="checkbox"/> OFF	ON	
6. 2ND ECHO	<input type="checkbox"/> OFF	ON	
7. VID CONTR	<input type="checkbox"/> 1	2 3	
8. CLTR SWEEP	<input type="checkbox"/> OFF	ON(LINK) ON(FIX)	
9. SWEEP LVL	<input type="checkbox"/> 1	2 3	

Figure 1-14 ECHO SIG menu

3. Press the [3] key to select interference rejection level (OFF, 1, 2, or 3) from the INT REJ field.
4. Press the [ENTER/SELECT] key.
5. Press the [MENU] key.

1.18 Measuring the Range

Measuring range by the fixed range rings

Use the fixed range rings to obtain a rough estimate of the range to a target. They are concentric solid circles about own ship, or the sweep origin. The number of rings is automatically determined by the selected range scale and their interval is displayed at the upper-left position of the screen. The fixed range rings may be turned on/off and their brilliance adjusted with the [RINGS] key.

True or relative vector, vector time

Vectors can be displayed relative to own ship's heading (Relative) or with reference to the North (True). This feature is available in all presentation modes (compass must be working correctly). The current vector mode is indicated at the upper-right corner of the screen.

Vector time (or the length of vectors) can be set to 30 seconds, 1, 3, 6, 15 or 30 minutes and the selected vector time is indicated at the upper-right corner of the screen.

1. Press the [MENU] key followed by the [7] key twice to select PLOT.

PLOT MENU 1					
1. MARK DISP	<input type="checkbox"/> OFF	ON			
2. ERASE					
3. VECT REF	<input checked="" type="checkbox"/> REL	TRUE			
4. VECT TIME	<input checked="" type="checkbox"/> 30S	1	3	6	
(min)	15	30			
5. CPA SET	<input type="checkbox"/> OFF	0.5NM	1NM	1.5NM	
		2NM	3NM	4NM	
		5NM			
6. TCPA SET	<input checked="" type="checkbox"/> 30S	1	2	3	
(min)	4	5	6	12	15
7. TRACK	<input type="checkbox"/> OFF	ON			
8. INTVAL*	<input checked="" type="checkbox"/> 30S	1	2	3	6
(min)					
9. TARGET BASED SPEED*					
0. ↓					

* Requires Auto Tracking Aid ARP-10 or ARP-17.

Figure 1-26 PLOT menu

2. Press the [3] key to select REL or TRUE from the VECT REF field as appropriate, and then press the [ENTER/SELECT] key.
3. Press the [4] to select appropriate vector time from the VEC TIME field, and then press the [ENTER/SELECT] key.
4. Press the [MENU] key to close the menu.

The vector tip shows an estimated position of the target after the selected vector time elapses. It can be valuable to extend the vector length to evaluate the risk of collision with any target.

Target data

The radar calculates motion trends (range, bearing, course, speed, CPA and TCPA) of all plotted targets.

In the head-up and head-up true bearing modes, target bearing, course and speed shown in the upper-right target data field become true (T) relative to north. The target data field always displays true bearing, true course and speed over the ground.

Reading the target data

Place the cursor on a plotted target and press the [ENTER/SELECT] key. Then, the following target data is displayed at the right side of the CRT.

RNG/BRG (Range/Bearing): Range and bearing from own ship to last-plotted target with suffix "T" (True).

CRS/SPD (Course/Speed): Course and speed are displayed for the last-plotted target with suffix "T" (True).

CPA/TCPA: CPA (Closest Point of Approach) is the closest range the target will approach to own ship. TCPA is the time to CPA. Both CPA and TCPA are automatically calculated. TCPA is counted up to 99.59 min and beyond that it is indicated as TCPA > *99.59 MIN.

Terminating target plotting

With the EPA you can plot up to 10 targets. You may wish to terminate plotting of less important targets to newly plot other threatening targets.

With Trackball: Place the cursor (+) on a target which you do not want to be tracked any longer by operating the trackball and press the [CANCEL/CLEAR] key.

All Targets: To terminate plotting of all targets at once:

1. Press the [MENU] key followed by the [7] key twice.

1.20 Collision Assessment by the Offset EBL

The origin of the EBL can be placed anywhere with the trackball to enable measurement of range and bearing between any targets. This function is also useful for assessment of the potential risk of collision.

To assess possibility of collision:

1. Press the [EBL ON] key to display or activate EBL No.1
2. Place the cursor (+) on a target of interest (A in the illustrated example) by operating the trackball.
3. Press the [EBL OFFSET] key, and the origin of the active EBL shifts to the cursor position. Press the [EBL OFFSET] key again to anchor the EBL origin.
4. After waiting for a few minutes (at least 3 minutes), operate the EBL rotary control until the EBL bisects the target at the new position (A'). The EBL readout shows the target ship's course, which may be true or relative depending on the settings on the OTHER menu.

If relative motion is selected, it is also possible to read CPA (Closest Point of Approach) by using a VRM as shown below (Figure (a)). If the EBL passes through the sweep origin (own ship) as illustrated (Figure (b)), the target ship is on a collision course.

5. To return the EBL origin to the own ship position, press the [EBL OFFSET] key again.

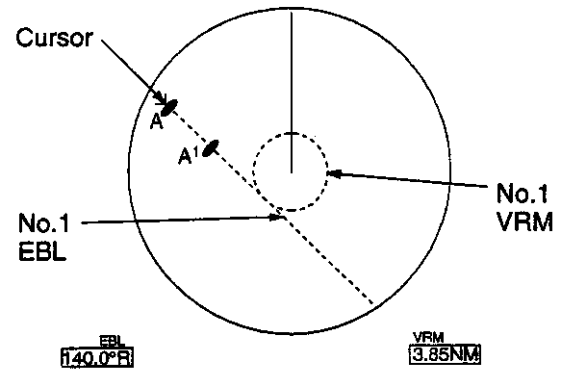

(a) Evaluating target ship's course and CPA in relative motion mode

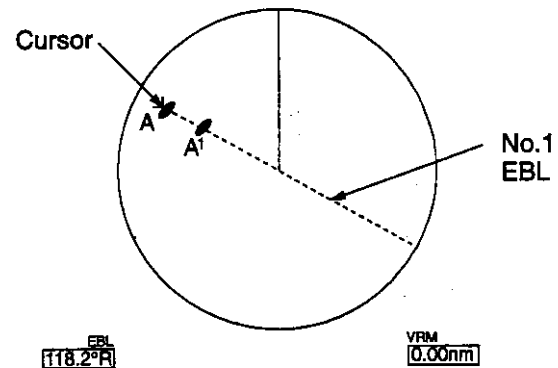

(b) Target ship on collision course

Figure 1-17 How to assess risk of collision

1.21 Measuring Range and Bearing Between Two Targets

1. Press the [EBL ON] key to activate the No. 1 EBL. Press the [EBL OFFSET] key, and place the origin of the No.1 EBL on a target of interest (target 1 in the illustrated example) by operating the trackball.
2. Turn the EBL rotary control until the EBL passes through another target of interest (target 2).
3. Turn the VRM rotary control until the range marker on the No. 1 EBL aligns with target 2. The active VRM readout at the lower-right corner of the screen indicates the distance between the two targets.
4. To return the EBL origin to the own ship position, press the [EBL OFFSET] key again.

PLOT MENU 1				
1. MARK DISP	<input type="checkbox"/> OFF	ON		
2. ERASE				
3. VECT REF	<input type="checkbox"/> REL	TRUE		
4. VECT TIME (min)	<input type="checkbox"/> 30S	1	3	6
	15	30		
5. CPA SET	<input type="checkbox"/> OFF	0.5NM	1NM	1.5NM
		2NM	3NM	4NM
		5NM		
6. TCPA SET (min)	<input type="checkbox"/> 30S	1	2	3
	4	5	6	12
7. TRACK	<input type="checkbox"/> OFF	ON		
8. INTVAL* (min)	<input type="checkbox"/> 30S	1	2	3
		6		
9. TARGET BASED SPEED*				
0. ↓				

* Requires Auto Tracking Aid ARP-10 or ARP-17.

Figure 1-28 PLOT menu

- Press the [7] key to select OFF or ON from the TRACK field as appropriate.
- Press the [ENTER/SELECT] key to register your selection followed by the [MENU] key to close the menu.

1.26 Target Trails (Echo Trails)

It is possible to display the trails of the radar echoes of targets in the form of synthetic afterglow. Target trails are selected either relative or true and may be sea or ground stabilized. The simulated afterglow can be selected in a single tone or gradual shading depending on a setting on the TGT TRAIL menu.

True or relative trails

You may display target trails relative to north or own ship heading in Relative Motion. True motion trails require a compass signal and own ship speed input to cancel out own ship's movement and present true target movements in accordance with their over-the-ground speeds and courses.

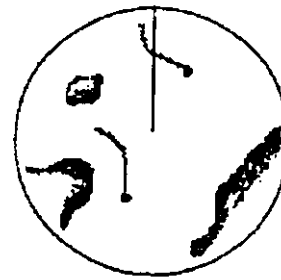

a) True target trails-no smearing of stationary targets

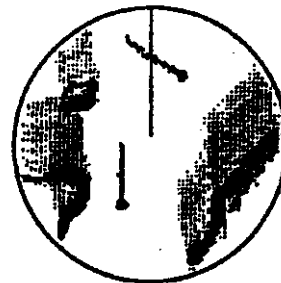

b) Relative target trails-all targets moving relative to own ship

Figure 1-29 Target trails

Note: When relative trail on the TM mode, the legend REL TRAIL appears in red.

To select true or relative target trail presentation:

- Press the [MENU] key.
- Press the [2] key twice to show the TGT TRAIL menu.

TGT TRAIL				
1. TIME	<input type="checkbox"/> 15S	30S	1M	3M
		6M	15M	30M
		CONT		
2. MODE	<input type="checkbox"/> REL	TRUE		
3. SHADE	<input type="checkbox"/> MONO	MULTI		
4. LEVEL	<input type="checkbox"/> 1	2	3	
5. TRAIL COPY	<input type="checkbox"/> OFF	ON		
6. THIN TRAIL	<input type="checkbox"/> OFF	ON		

Figure 1-30 TGT TRAIL menu

- Press the [2] key several times to select REL or TRUE from the MODE field as appropriate.
- Press the [ENTER/SELECT] key to confirm your selection, then the [MENU] key to close the menu.

Acknowledging alarm

A target entering the target alarm zone produces both visual (flashing) and audible (beeping) alarms. To silence the audible alarm, press the [AUDIO OFF] key shortly. ACK replaces IN (or OUT).

This will deactivate the audible alarm but will not stop the flashing of the target in the guard alarm zone. To reactivate the audible alarm, press the [GZ ALARM] key again.

To silence the audible alarm, you may press the [AUDIO OFF] key. However, in this case, the label ACK does not appear.

Deactivating target alarm zone

Hold the [GZ ALARM] key depressed for at least 5 seconds.

Note: The target alarm is given to targets having a certain level of echo strength. This level does not always imply a landmass, reef, ships or other surface objects but can mean returns from the sea surface or precipitation. Properly adjust the GAIN, A/C SEA, and A/C RAIN controls to reduce noise to avoid generation of the guard alarm against false targets.

Inward and outward alarms

The inward target alarm generates visual and audible warnings when a target enters the target alarm zone from any direction. The outward target alarm is produced when a target leaves the target alarm zone. (This is not a target alarm by definition but some users find this feature valuable.)

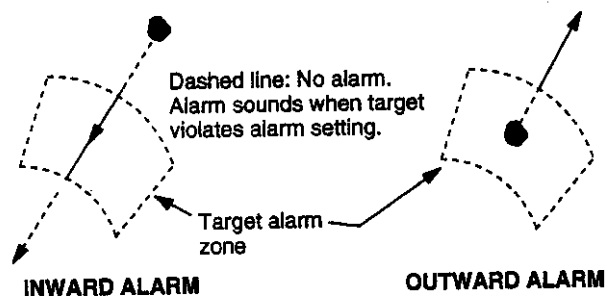

Figure 1-21 Inward and outward alarms

1.23 Off-centering (shift)

Own ship position, or sweep origin, can be displaced to expand the view field without switching to a larger range scale. The sweep origin can be off-centered to a point specified by the cursor, up to 75% of ranges other than 72, 96 and 120 nm.

This feature is not available on the longest range scale or in the true motion mode. The number of range rings increases keeping the original range intervals unchanged.

To off center the radar picture:

1. Place the cursor at a position where you wish to move the sweep origin by operating the trackball.
2. Press the [SHIFT] key. Then, the sweep origin is off-centered to the cursor position. However, the heading line is left in the same position.
3. To cancel off-centering, press the [SHIFT] key again.

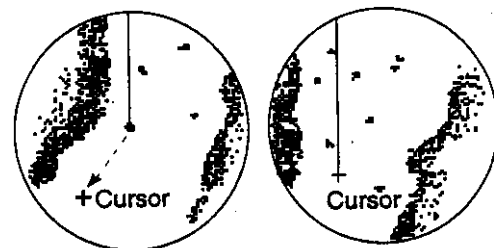

- (a) Select location with cursor. (b) Press SHIFT key to offcenter.

Figure 1-22 Off-centered display

Note: The display is automatically shifted by 75% of the range in use whenever the cursor is placed at an edge of the effective display area.

Resetting target trails

To reset (or clear) the target trail memory, hold the [TGT TRAIL] key depressed for about 3 seconds. Target trails are cleared and the trailing process restarts from time count zero at current target trail plot interval. Note that target trails are also restarted when the shift feature is turned on or the range is changed.

Trail brilliance

The brilliance of target trails can be adjusted on the BRILL menu as follows:

1. Press the [MENU] key.
2. Press the [9] key twice to display the BRILL menu.

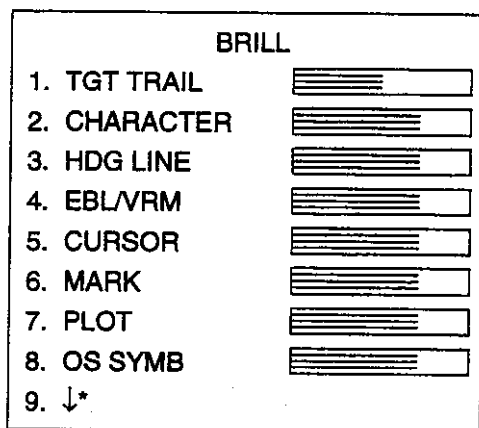

* Requires RP-17 Board.

Figure 1-35 BRILL menu

3. Press the [1] key twice to select TGT TRAIL.
4. Operate the VRM rotary control to adjust brilliance. Current brilliance is shown by the BRILL bar graph at the top right-hand corner of the screen.
5. Press the [ENTER/SELECT] key to conclude your selection followed by the [MENU] key to close the menu.

Thin trails

Target trails may be painted with thinner lines if desired.

1. Press the [MENU] key.
2. Press the [2] key twice to select TGT TRAIL.

3. Press the [6] key to select ON or OFF from the THIN TRAIL field as appropriate.
4. Press the [ENTER/SELECT] key and [MENU] key in order.

Trail afterglow

The strength of the synthetic afterglow to remain on the display may be selected as follows:

1. Press the [MENU] key.
2. Press the [2] key twice to select TGT TRAIL.
3. Press the [4] key to select desired level from the LEVEL field; "3" displays only the highest level of afterglow.
4. Press the [ENTER/SELECT] key and [MENU] key in order.

1.27 Parallel Index Lines

Parallel index lines are useful for keeping a constant distance between own ship and a coastline or a partner ship when navigating. The orientation of the index lines is controlled with the EBL rotary control and the intervals between the lines adjusted with the VRM rotary control (provided that No.2 VRM is active).

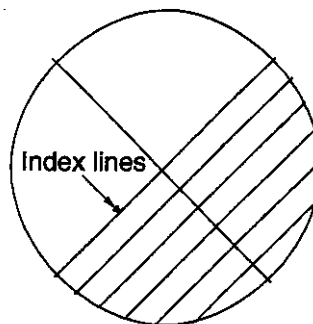

Figure 1-36 Index lines

Displaying/erasing the index lines

Press the [INDEX LINE] key to display/erase the index lines. Each press of the key turns the parallel index lines on (enabling adjustment by VRM, EBL), fixes them on the display or turns them off.

1.25 Electronic Plotting Aid (EPA)

10 operator-selected targets can be plotted electronically to assess their motion trend. Five past positions can be displayed for each of the plotted targets. If you enter a 6th plot on a certain target, the oldest plot (past position) will be erased.

A vector appears when you enter a second plot for the target and is updated each time a new plot is entered. The vector shows the target motion trend based on its latest two plots.

Target data is shown in the data display area which shows range, bearing, course, speed, CPA and TCPA of the last-plotted or selected target.

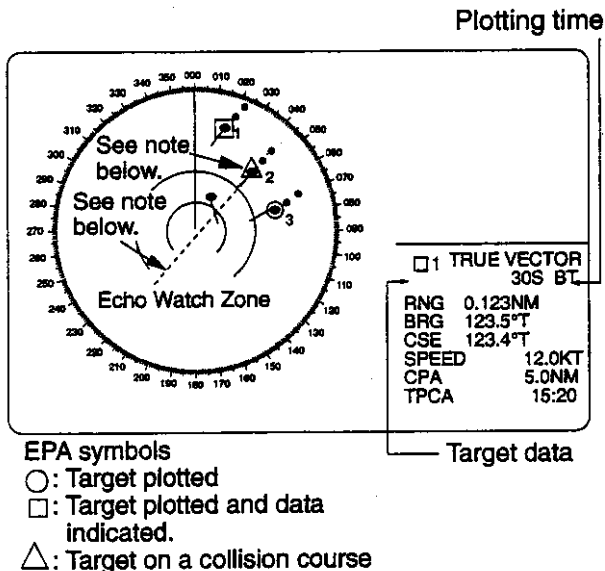

Note:

Target 2 is on a collision course as the extension of its vector goes through the own ship position. Placing the offset EBL will help for assessment. TCPA is counted up to 99.59 min and beyond that it is indicated as TCPA > 99.59 MIN.

Figure 1-25 EPA display

Note: The EPA requires speed input (automatic or manual) and a compass signal. The vector and data are updated on real time between plot entries, but do not neglect to plot a new position over a long period of time. Otherwise, the accuracy will be reduced. Note that the plots will be lost when the compass fails; start the plotting exercise again.

Plotting a target

1. Place the cursor on a target of interest by operating the trackball.
2. Press the [ACQ] key. A plot symbol (circle) plus target number (0-9) appear on the target.
3. Watching the EPA time shown at the right side of the screen, wait for at least 30 seconds. Place the cursor (+) on the plot symbol with number and then press the [ENTER/SELECT] key. The symbol shape changes from circle to square and the target number in the data display flashes.
4. While the target number is flashing, place the cursor on the target and press the [ACQ] key. The plot symbol moves to the new target position and the previous position is marked by a small dot.
5. To acquire other targets, repeat the above steps selecting different plot symbols.

Note: If a target once plotted is not plotted again within 12 minutes, the warning "UPDATE PLOT" will appear on the upper right margin of the screen and the plot symbol of the target flashes. Plotting of a target will be ceased if the time between consecutive plots exceeds 12 minutes. If you want to continue plotting this target, reacquire it within one minute. Otherwise, the target will be regarded as a "lost target" and its plot symbol and target data will be erased. The larger the plotting interval, the less accurate the plotted target data. Plotting of each target should normally be made every 3 or 6 minutes as far as possible. You can use a Time Alarm to warn yourself every 3 or 6 minutes.

Within 30 seconds, you can cancel a last plot by the [CANCEL/CLEAR] key and make a re-entry at a different position. After 30 seconds, the last entry is processed to produce a vector.

1.30 Markers

Heading line and heading marker

The heading line indicate the ship's heading in all presentation modes. The heading line is a line from the own ship position to the outer edge of the radar display area and appears at zero degrees on the bearing scale in head-up mode, it changes the orientation depending on the ship orientation in the north-up and true motion modes. The heading marker appears as a small circle on the bearing scale to indicate the heading when the display is shifted or is in the north-up or TM mode.

Temporarily erasing heading line

To temporarily extinguish the heading line to look at targets existing dead ahead of own ship, press the GAIN control (HM OFF control). The heading line reappears when the control is released.

North marker

The north marker appears as a short dashed line. In the head-up mode, the north marker moves around the bearing scale in accordance with the compass signal.

Stern marker

The stern marker (a dot-and-dash line) appears opposite to the heading line. It can be displayed/erased on the item MARK/LINE in the OTHER menu.

Own ship symbol

The own ship symbol appears at own ship position. It can be displayed/erased on the item MARK/LINE in the OTHER menu. The symbol is scaled to indicate length and beam of the vessel. If the largest dimension of the symbol gets smaller than 6 nm, the symbol will disappear and own ship will be represented by a small dot or circle. The size of the symbol is set at installation.

1.31 User Keys (F1, F2, F3)

The user keys [F1], [F2] and [F3] may be programmed by the operator to display a desired menu. For example, you can program the [F2] key to select target trail time whenever the key is pressed.

The default settings are [F1], echo averaging; [F2], echo stretch and [F3], clutter sweep.

Presetting the user keys

1. Press the [MENU] key.
2. Press the [6] key twice to display the FUNC menu.

FUNC	
1.	FUNC1
2.	FUNC2
3.	F•1
4.	F•2
5.	F•3

Figure 1-39 FUNC menu

3. Press [3], [4], or [5] key twice depending on which user key you want to set. For example, press the [4] key to program the [F2] key.

[F•2 MENU]	
1. TRAIL TIME	26. HUTB MODE
2. TRAIL MODE	27. TUNE A/M
3. TRAIL SHADE	28. EXT WPT
4. TRAIL LEVEL	29. OS POSN
5. ALARM AREA	30. CURS BRG
6. ALARM MODE	31. EBL1 T/R
7. PANEL DIMMER	32. EBL2 T/R
8. TGT COLOR	33. CURS RNG
9. ECHO AVG	34. VRM1 RNG
10. INT REJ	35. VRM2 RNG
11. ECHO STRETCH	36. CLTR SWEEP
12. NOSE REJ	
13. ECHO ENHANCE	
14. 2ND ECHO	
15. VIDEO CONTR	
16. PLOT MENU	
17. MARK MODE	
18. BRILL MENU	
19. DRIFT MENU	
20. NAV DATA	
21. DISPLAY	
22. SART	
23. TIMER ALM MENU	
24. STERN MK	
25. OS MARK	

Select by VRM knob
and hit ENTER key.

Figure 1-40 Function menu

4. Select desired function with the VRM rotary control.

2. Press the [2] key twice to select OFF from the ERASE field.
3. Press the [ENTER/SELECT] key followed by the [MENU] key.

Setting CPA/TCPA alarm ranges

When the predicted CPA of any target becomes smaller than a preset CPA alarm range and its predicted TCPA less than a preset TCPA alarm limit, the EPA releases an audible alarm and displays the warning label COLLISION appears on the screen. In addition, the EPA symbol changes to a triangle and flashes together with its vector.

Provided that this feature is used correctly, it will help prevent the risk of collision by alerting you to threatening targets. It is important that GAIN, A/C SEA, A/C RAIN and other radar controls are properly adjusted.

CPA/TCPA alarm ranges must be set up properly taking into consideration the size, tonnage, speed, turning performance and other characteristics of own ship.

 CAUTION
CPA/TCPA Alarm
<p>The CPA/TCPA alarm feature should never be relied upon as the sole means for detecting the risk of collision.</p> <p>The navigator is not relieved of the responsibility to keep visual lookout for avoiding collisions, whether or not the radar or other plotting aid is in use.</p>

To set the CPA/TCPA alarm ranges:

1. Press the [MENU] key.
2. Press the [7] key twice to display the PLOT menu.

PLOT MENU 1				
1. MARK DISP	<input type="checkbox"/> OFF	ON		
2. ERASE				
3. VECT REF	<input type="checkbox"/> REL	TRUE		
4. VECT TIME	<input type="checkbox"/> 30S	1 3 6		
(min)	15 30			
5. CPA SET	<input type="checkbox"/> OFF	0.5NM 1NM 1.5NM		
	2NM 3NM 4NM			
	5NM			
6. TCPA SET	<input type="checkbox"/> 30S	1 2 3		
(min)	4 5 6 12 15			
7. TRACK	<input type="checkbox"/> OFF	ON		
8. INTVAL*	<input type="checkbox"/> 30S	1 2 3 6		
(min)				
9. TARGET BASED SPEED*				
0. ↓				

* Requires Auto Tracking Aid ARP-10 or ARP-17.

Figure 1-27 PLOT menu

3. Press the [5] key for CPA SET or [6] key for TCPA set.
4. Press the [5] key or [6] key again to select CPA or TCPA range desired.
5. Press the [ENTER/SELECT] key to register your selection.
6. Press the [MENU] key to close the menu.

Silencing CPA/TCPA audible alarm

Press the [AUDIO OFF] key to acknowledge and silence the CPA/TCPA aural alarm.

The flashing of the triangle plot symbol and vector remain on the screen until the dangerous situation is gone or you intentionally terminate tracking of the target by using the trackball.

Past plot points

Past plot points may be marked on the display with as many as nine dots. You can turn this display on/off as follows:

1. Press the [MENU] key.
2. Press the [7] key twice to select PLOT.

3. Press the [2] key twice to select function desired.
4. Change other functions (echo avg, int rej, etc.) if necessary.
5. Press the [ENTER/SELECT] key to register your selection followed by the [MENU] key to close the menu.

1.33 Suppressing Second-trace Echoes

In certain situations, echoes from very distant targets may appear as false echoes (second-trace echoes) on the screen. This occurs when the return echo is received one transmission cycle later, that is, after a next radar pulse has been transmitted.

To activate or deactivate the second-trace echo rejector:

1. Press the [MENU] key followed by the [5] key twice to display the ECHO SIG menu.

ECHO SIG			
1. TGT COLOR	<input type="text" value="YEL"/>	GRN	COLOR
2. ECHO AVG	<input type="text" value="OFF"/>	0.5	1 2 3
3. INT REJ	<input type="text" value="OFF"/>	1	2 3
4. N REJ	<input type="text" value="OFF"/>	ON	
5. ENHANCE	<input type="text" value="OFF"/>	ON	
6. 2ND ECHO	<input type="text" value="OFF"/>	ON	
7. VID CONTR	<input type="text" value="1"/>	2	3
8. CLTR SWEEP	<input type="text" value="OFF"/>	ON(LINK)	ON(FIX)
9. SWEEP LVL	<input type="text" value="1"/>	2	3

Figure 1-43 ECHO SIG menu

2. Press the [6] key to select OFF or ON from the 2ND ECHO field as appropriate.
3. Press the [ENTER/SELECT] key to conclude your selection followed by the [MENU] key to close the menu.

Table 1-3 Default function key settings

Default Function Key Settings							
Label	3. ECHO AVG	4. INT REJ	5. STRETCH	6. N REJ	7. ENHANCE	8. VIDEO CONT	9. A/C A/AUTO
COAST	1	1	OFF	OFF	OFF	2	OFF
OCEAN	1	1	OFF	OFF	OFF	2	OFF
R-SEA	2	1	OFF	OFF	OFF	2	ON
RAIN	0.5	1	OFF	OFF	OFF	2	OFF
BIRD-N	2	1	OFF	ON	OFF	2	OFF
BIRD-F	3	1	2	ON	OFF	3	OFF

Trail gradation

Target trails may be shown in monotone or multitone. Gradual shading paints the trails getting thinner with time just like the afterglow on an analog PPI radar.



Figure 1-31 Monotone and multitone target trails

1. Press the [MENU] key.
2. Press the [2] key twice to select TGT TRAIL.

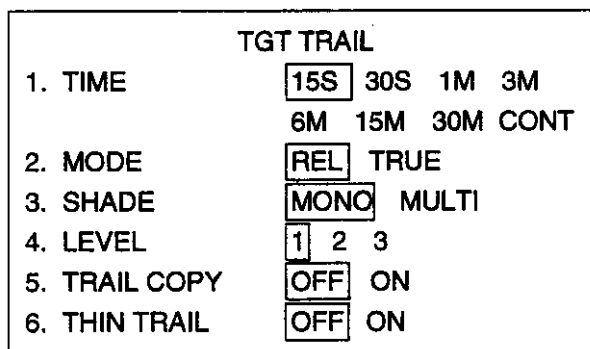

Figure 1-32 TGT TRAIL menu

3. Press the [3] key to select MONO or MULTI from the SHADE field as appropriate.
4. Press the [ENTER/SELECT] key and the [MENU] key in order.

Displaying, erasing target trails

Press the [TGT TRAIL] key to activate or deactivate the target trails feature. The current target trail setting is displayed at the upper right-and corner of the screen.

To remove trails from the screen, press the [TGT TRAIL] with a hit-and-release action. (Trailing continues off screen with target trail timer counting). Press the key again to redisplay the trails.

Selecting trail time

1. Press the [MENU] key.
2. Press the [2] key twice to select TGT TRAIL.

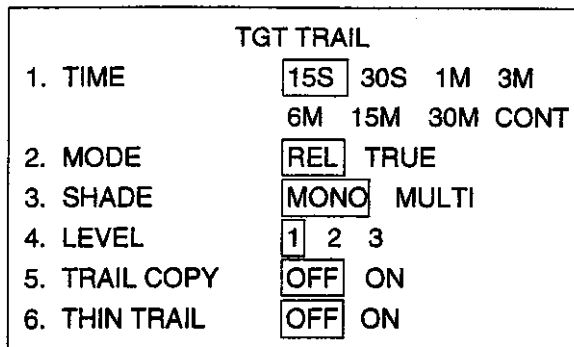

Figure 1-33 TGT TRAIL menu

3. Press the [1] key to select time desired from the TIME field.
4. Press the [ENTER/SELECT] key and the [MENU] key in order.

Restoring trails

Trails are cancelled and restarted whenever the range is changed. However, you can continue trails on the same range, without restarting, when the range is changed to a next larger or smaller range scale. Note however that when the range is changed, only those target trails within the previous range are continued; no trails are generated for targets outside of the previous range.

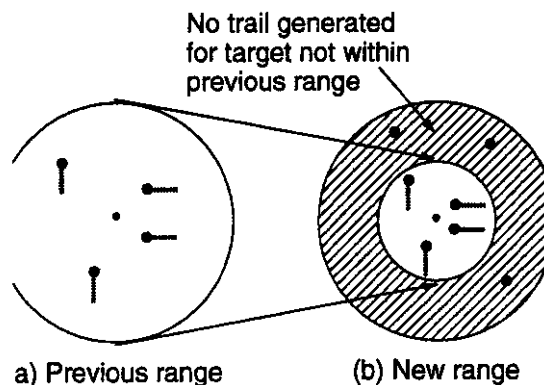

Figure 1-34 How trail copy works

1. Press the [MENU] key.
2. Press the [2] key twice to select TGT TRAIL.
3. Press the [5] key to select ON or OFF from the TRAIL COPY field as appropriate.
4. Press the [ENTER/SELECT] key and [MENU] key in order.

2. Press the [2] key to select desired interval (3, 6, 12, 15, 20 min) from the ALM INTVL field.
3. Press the [ENTER/SELECT] key to conclude your selection followed by the [MENU] key to close the menu.

1.37 Enhanced Video

On long ranges target echoes tend to shrink in the bearing direction, making them difficult to see. On short and medium ranges such as 1.5, 3 and 6 nm scales, the same size targets get smaller on screen as they approach the own ship. These are due to the inherent property of the radiation pattern of the antenna. To enhance target video, use the enhanced video function. It enlarges target echoes in bearing and range direction on 1.5-6 nm scales.

1. Press the [MENU] key followed by the [5] key twice to show the ECHO SIG menu.

ECHO SIG			
1. TGT COLOR	<input type="text" value="YEL"/>	GRN	COLOR
2. ECHO AVG	<input type="text" value="OFF"/>	0.5	1 2 3
3. INT REJ	<input type="text" value="OFF"/>	1	2 3
4. N REJ	<input type="text" value="OFF"/>	ON	
5. ENHANCE	<input type="text" value="OFF"/>	ON	
6. 2ND ECHO	<input type="text" value="OFF"/>	ON	
7. VID CONTR	<input type="text" value="1"/>	2	3
8. CLTR SWEEP	<input type="text" value="OFF"/>	ON(LINK)	ON(FIX)
9. SWEEP LVL	<input type="text" value="1"/>	2	3

Figure 1-47 ECHO SIG menu

2. Press the [5] key to select OFF or ON from the ENHANCE field.
3. Press the [ENTER/SELECT] key, and then press the [MENU] key.

Echo enlarged in bearing and range directions

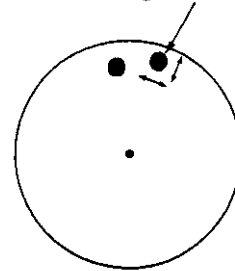

Figure 1-48 How the enhance function works

Note: Enhanced video can also be selected with a user key.

1.38 Degaussing Interval

The screen is degaussed automatically at certain time intervals, as well as each time the radar is turned on, to demagnetize the CRT screen to eliminate color contamination caused by earth's magnetism or magnetized ship structure. You can select the degaussing interval and the degaussing degree as follows:

1. Press the [MENU] key followed by the [0] key twice to select OTHER.
2. Press the [0] key twice to select the OTHER menu.

OTHER	
1. ↑	
2. TEST	
3. DEGAUSS	
4. TIME ALARM	
5. RANGE	
6. INSTALL	

Figure 1-49 OTHER menu

3. Press the [3] key twice to display the DEGAUSS menu.

DEGAUSS			
1. ↑			
2. DEGS INTV	<input type="text" value="OFF"/>	30S	1M 2M
3. DEGS DEG	<input type="text" value="OFF"/>	45°	90° 135°

Figure 1-50 DEGAUSS menu

Selecting number of index lines to display

Maximum number of the index lines can be set for 2 or 6 on the MARK/LINE in the OTHER menu.

1.28 Origin Mark

You can mark any reference points, prominent target or a point of particular interest using the origin mark feature. This mark is geographically fixed, namely, ground stabilized. Twenty such origin marks can be entered. This function is not available when the RP-17 board is installed.

To use the origin mark:

1. Place the cursor (+) at a point where you want to place a reference mark by operating the trackball.
2. Press the [MARK] key. The origin mark appears at the cursor position, of which range and bearing are indicated at the upper-right section of the screen.

Origin mark reference

The origin mark can be set relative to own ship (relative), or referenced to land (sea or ground stabilized).

1. Press the [MENU] key.
2. Press the [8] key twice to select MARK.

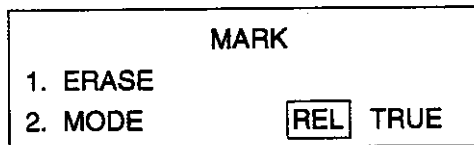

Figure 1-37 MARK menu

3. Press the [2] to select the REL or TRUE from the MODE field as appropriate.
4. Press the [ENTER/SELECT] key.
5. Press the [MENU] key.

Erasing origin marks

Erasing individual origin marks

Select the origin mark with the cursor and then press the [CANCEL/CLEAR] key.

Erasing all origin marks

1. Press the [MENU] key.
2. Press the [8] key twice to select MARK.
3. Press the [1] key to select the ON option from the ERASE field.
4. Press the [ENTER/SELECT] key followed by the [MENU] key.

1.29 Zoom

The zoom function is useful for enlarging an area of interest as large as twice the normal viewing. This performs the range scale reduction to a half and the offset at the same time. Zoom can be used on ranges other than 0.125, 72, 96, 120 nm.

1. Place the cursor (+) close to the point of interest by operating the trackball.
2. Press the [ZOOM] key. The area around the cursor and own ship is enlarged twice as large as the original size.
3. To cancel zoom, press and hold down the [ZOOM] key about two seconds.

Note: The zoom feature is inoperative when the display is off centered.

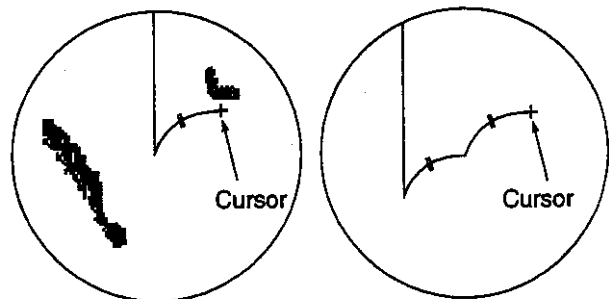

(a) Cursor placed at point of interest

(b) Press ZOOM key to zoom in.

Figure 1-38 Zoom

- ON(LINK): Sweep area moves with trackball operation. Sweep cursor shown by dashed lines.
- ON(FIX): Sweep area is fixed on the screen. Sweep cursor shown by solid lines.

- Press the [9] key (SWEEP LVL) several times to select level of suppression to use; "3" provides the highest level of noise suppression.
- Press the [ENTER/SELECT] key to register your selection and the [MENU] key to finish.
- Operate the trackball to select area to process.

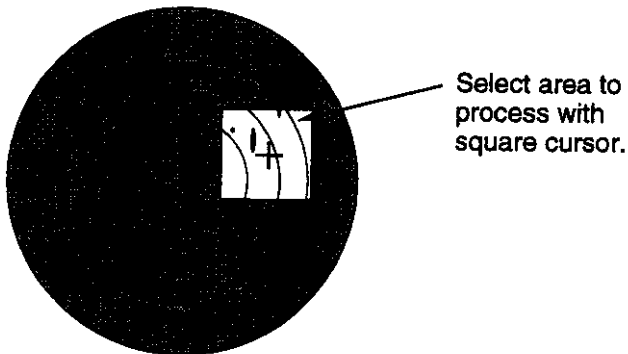

Figure 1-52 Selection of area to process with clutter sweep

The clutter sweep feature may also be activated by a user key.

1.42 Outputting Target Position

Target position can be output (in IEC 61162-1 format) to a video plotter and marked on its screen with a symbol. Select target with the trackball and push the A/C RAIN control. (TLL) This function requires position data and compass signal.

1.43 Background Color

The secondary function of the BRILL control (BKGND COLOR) is to select the color of the background, characters, menu, markers and indications, from the five color combinations shown in the table below. Each press of the control selects one of the five color combinations.

Table 1-4 Available color combinations

Item	1	2	3	4	5
Within Radar Display Area	BLK	D-BLU	L-BLU	L-BLU	BLK
Outside Radar Display Area	BLK	BLK	BLK	L-BLU	BLK
Characters	GRN	GRN	GRN	WHT	RED
Menu	YEL	YEL	YEL	YEL	RED
Selected Item in Menu	RED	RED	RED	RED	RED
EBL, VRM	BLU	GRN	GRN	GRN	BLU
Rings	GRN	WHT	WHT	WHT	GRN
Cursor	WHT	GRN	GRN	GRN	WHT
Heading Line	GRN	WHT	WHT	WHT	GRN
Guard Zone	WHT	BLU	BLU	BLU	WHT
North Marker	WHT	BLU	BLU	BLU	WHT

1.44 Selecting Range Scales

Range scales to use may be selected as follows:

- Press the [MENU] key.
- Press the [0] key four times to display the OTHER sub menu.

OTHER	
1.	↑
2.	TEST
3.	DEGAUSS
4.	TIME ALARM
5.	RANGE
6.	INSTALL

Figure 1-53 OTHER sub menu

5. Press the [ENTER/SELECT] key to register your selection, and then press the [MENU] key to finish.

Activating a user-defined key

Press a user key. Press the key again to select option desired.

1.32 Function Keys

The function keys work similar to the automatic dialing feature on a telephone, playing back control settings just as they were registered. Instead of manually adjusting controls to set up for a particular condition, for example, navigation in a harbor, you can have a function key do it for you.

Each function key can be assigned a combination of particular radar settings that will be most suited to a specific navigation purpose, and an adhesive-backed label (such as OCEAN, COAST) is usually attached to the keytop for easy identification of the assigned purpose.

Presetting the function keys

The radar's internal computer offers several navigation setups as outlined in the table on the next page. For instance, you might want to select RAIN as the objective of a function key. Then, when you press that function key the radar will be instantly set up to operate under heavy rain conditions.

Each setup option defines a combination of several radar settings for achieving optimum setup for a particular navigating situation. Those involved are interference rejector, echo stretch, echo average, automatic anti-clutter, noise rejector, video contrast, and enhanced video.

Adjusting these features on a function key menu changes the original function key settings. To restore the original settings for a particular function key, it is necessary to display the relevant function key menu and select appropriate menu options.

Table 1-2 FUNC key objectives

Label	Description
COAST	Optimum setting for short range detection using a range scale between 1.5 and 6 nm on calm seas.
OCEAN	Optimum setting for long range detection using a range scale between 6 and 24 nm.
R-SEA	Optimum setting for heavy seas using a range scale between 3 and 12 nm.
RAIN	Optimum setting for heavy rain conditions using a range scale between 6 and 24 nm.
BIRD-N	Optimum setting for detecting birds using a range scale between 3 and 8 nm.
BIRD-F	Optimum setting for detecting birds using a range scale between 16 and 24 nm.

1. Press the [MENU] key followed by the [6] key twice to display the FUNC menu.

FUNC	
1.	FUNC1
2.	FUNC2
3.	F•1
4.	F•2
5.	F•3

Figure 1-41 FUNC menu

2. Press [1] or [2] key twice to select function to program. For example, press the [1] key to program FUNC1. The following menu appears.

FUNC 1 MENU	
1.	↑
2.	FUNC SEL COAST <input type="checkbox"/> OCEAN <input checked="" type="checkbox"/>
	R-SEA RAIN
	BIRD-N BIRD-F
3.	ECHO AVG OFF 0.5 <input type="checkbox"/> 1 <input checked="" type="checkbox"/> 2 3
4.	INT REJ OFF 1 <input type="checkbox"/> 2 <input checked="" type="checkbox"/> 3
5.	STRETCH <input type="checkbox"/> OFF <input checked="" type="checkbox"/> 1 2
6.	N REJ <input type="checkbox"/> OFF <input checked="" type="checkbox"/> ON
7.	ENHANCE <input type="checkbox"/> OFF <input checked="" type="checkbox"/> ON
8.	VIDEO CONTR OFF 1 <input type="checkbox"/> 2 <input checked="" type="checkbox"/> 3
9.	A/C AUTO <input type="checkbox"/> OFF <input checked="" type="checkbox"/> ON

Figure 1-42 FUNC1 menu

1.46 Alarms

The table below shows the alarm indications which appear on the display screen.

Table 1-5 Alarms

Fault	Audible alarm	Visual alarm	To quit alarm status
Heading failure	beeps	Heading label reads "xxx.x°" and the message "GYRO SIGNAL MISSING" appears in red. Display is automatically switched to Head-up mode within 1 min.	Match the on-screen Heading readout with the actual compass reading, if necessary. To stop audible alarm press the [AUDIO OFF] key.
Target alarm	Beeps	Target flashes.	Press [TGT ALARM] key. (Section 1.22).
Watch alarm	Beeps	WATCH 0:00 (Label "WATCH TIM" turns red and time count freezes at "0:00.>").	Press the [AUDIO OFF] key. The label WATCH turns to normal video and the timer is reset (Section 1.36).
Own ship lat/lon Cursor lat/lon	None	"xxx.x" in own ship position field "xxx.x" in cursor position field	Make sure that own ship position data is fed from external radionav equipment.
System failure	None	Message "AZIMUTH SIGNAL MISSING" appears. No radar echoes.	
Incorrect keystroke	Double beep tone	None	Correct keystroke is responded by a single beep provided that KEY BEEP ON is selected at installation.
Log failure	2 beeps	LOG "xx.x" and "LOG SIGNAL MISSING" appear, if no log signal is input for 30 sec.	If the log has failed, use the Manual Speed mode, or other appropriate sensor.
EPA plotting	None	UPDATE PLOT informs that a target which was once plotted is not plotted within 10 minutes.	Plot target again.
Target on collision course	Beeps	COLLISION appears when EPA-tracked target is on collision course.	Take evasive action or terminate tracking of target.

1.34 Adjusting Brilliance of Screen Data

You can adjust relative brilliance levels of various marks and alphanumeric readouts displayed on the screen as follows:

1. Press the [MENU] key.
2. Press the [9] key twice to show the BRILL menu.

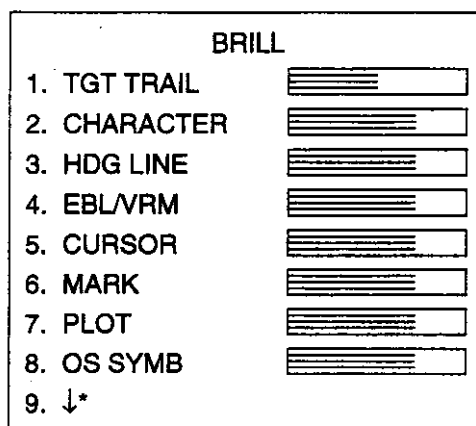

* Requires RP-17 Board.

Figure 1-44 BRILL menu

3. Press appropriate numeric key twice to select item to adjust. For example, press the [1] key if you want to change the brilliance of target trails.
4. Operate the VRM rotary control to adjust brilliance. Current brilliance level is displayed on the selected item's bar graph. The adjustment range is as follows;
 1. ECHO TRAIL: 10%-50%
 2. CHARACTER, 3. HDG LINE: 50%-100%
 4. EBL/VRM, 5. CURSOR, 6. MARK, 7. PLOT, 8. OS SYMB: 0%-100%
5. Press the [ENTER/SELECT] key to conclude your selection followed by the [MENU] key to close the menu.

1.35 Noise Rejector

The noise rejector suppresses white noise, which appears on the screen as many dots scattered randomly over the display.

To suppress white noise:

1. Press the [MENU] key.
2. Press the [5] key twice to show the ECHO SIG menu.

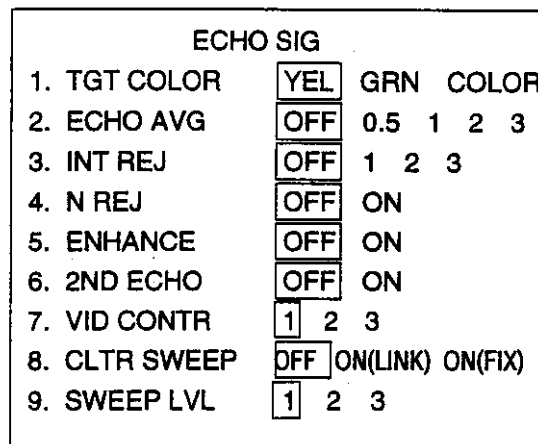

Figure 1-45 ECHO SIG menu

3. Press the [4] to select OFF or ON from the N REJ field as appropriate.
4. Press the [ENTER/SELECT] key to conclude your selection followed by the [MENU] key to close the menu.

1.36 Time Alarm

The time alarm gives an aural at a predetermined interval.

To silence the alarm, press the [AUDIO OFF] key. The label T-ALM turns to normal color and the timer is reset to initial value and starts the count-down sequence again.

To activate the time alarm:

1. Press [MENU], [0] twice and [4] twice to display the TIME ALARM.

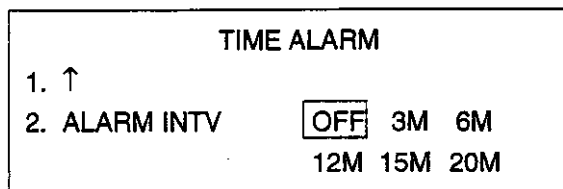

Figure 1-46 TIME ALARM menu

RADAR OBSERVATION

2.1 General

Minimum and maximum ranges

Minimum range

The minimum range is defined by the shortest distance at which, using a scale of 1.5 or 0.75 nm, a target having an echoing area of 10 m² is still shown separate from the point representing the scanner position.

It is mainly dependent on the pulselength, scanner height, and signal processing such as main bang suppression and digital quantization. It is a good practice to use a shorter range scale as far as it gives favorable definition or clarity of picture. The IMO Resolution A. 477 (XII) and IEC 936 require the minimum range to be less than 50 m. All FURUNO radars satisfy this requirement.

Maximum range

The maximum detecting range of the radar, R_{max} , varies considerably depending on several factors such as the height of the scanner above the waterline, the height of the target above the sea, the size, shape and material of the target, and the atmospheric conditions.

Under normal atmospheric conditions, the maximum range is equal to the radar horizon or a little shorter. The radar horizon is longer than the optical one by about 6% because of the diffraction property of the radar signal. The R_{max} is given in the following equation.

$$R_{max} = 2.2 \times (\sqrt{h_1} + \sqrt{h_2})$$

where R_{max} : radar horizon (nautical miles)
h1: scanner height (m)
h2: target height (m)

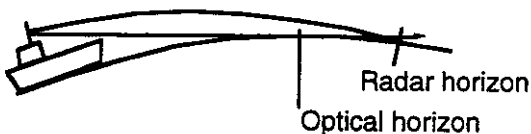

Figure 2-1 Radar horizon

For example, if the height of the scanner above the waterline is 9 meters and the height of the target is 16 meters, the maximum radar range is;

$$R_{max} = 2.2 \times (\sqrt{9} + \sqrt{16}) = 2.2 \times (3 + 4) = 15.4 \text{ nm}$$

It should be noted that the detection range is reduced by precipitation (which absorbs the radar signal).

X-band and S-band

In fair weather, the above equation does not give a significant difference between X- and S-band radars. However, in heavy precipitation condition, an S-band radar would have better detection than an X-band radar.

Radar resolution

There are two important factors in radar resolution (discrimination): bearing resolution and range resolution.

Bearing resolution

Bearing resolution is the ability of the radar to display as separate pips the echoes received from two targets which are at the same range and close together. It is proportional to the scanner length and reciprocally proportional to the wavelength. The length of the scanner radiator should be chosen for a bearing resolution better than 2.5° (IMO Resolution). This condition is normally satisfied with a radiator of 1.2 m (4 ft) or longer in the X-band. The S-band radar requires a radiator of about 12 feet (3.6 m) or longer.

4. Press the [2] key to select desired de-gaussing interval (OFF, 1, 5, 10 min) from the DEGS INTV field, and then press the [ENTER/SELECT] key.
5. Press the [3] key to select desired de-gaussing degree (45°, 90°, 135°) from the DEGS DEG field. For example, selecting 45° will automatically degauss the screen when the ship makes a turn which is between 45° and 89°.
6. Press the [ENTER/SELECT] key followed by the [MENU] key.

1.39 Navigation Data

Various navigation data can be displayed (and their format selected) with connection of appropriate external sensors. You can select which navigation data to display as follows:

1. Press the [MENU] key, and then the [0] key twice show the OTHER menu.
2. Press the [8] key twice to select display the NAV DATA menu.
3. Press appropriate numeric key to turn data on/off, select format, etc. Press the [ENTER/SELECT] key after setting each option.

Note: OFF in the OS POSN field simply erases own ship position data; it does not stop input of nav data from a navigation device.
4. Press the [MENU] key.

All navigation data may be turned on/off by the keying sequence of [MENU], [0] (twice) and [5].

1.40 Video Contrast

The video contrast is adjustable in three levels according to the radar video sampling level. Select the level so that the video contrast feature changes the dynamic range of the video signal to improve picture contrast. Picture shows up most clearly from the background.

1. Press the [MENU] key.
2. Press the [5] key twice to display the ECHO SIG menu.

ECHO SIG				
1. TGT COLOR	<input type="text" value="YEL"/>	GRN	COLOR	
2. ECHO AVG	<input type="text" value="OFF"/>	0.5	1 2 3	
3. INT REJ	<input type="text" value="OFF"/>	1 2 3		
4. N REJ	<input type="text" value="OFF"/>	ON		
5. ENHANCE	<input type="text" value="OFF"/>	ON		
6. 2ND ECHO	<input type="text" value="OFF"/>	ON		
7. VID CONTR	<input type="text" value="1"/>	2 3		
8. CLTR SWEEP	<input type="text" value="OFF"/>	ON(LINK)	ON(FIX)	
9. SWEEP LVL	<input type="text" value="1"/>	2 3		

Figure 1-51 ECHO SIG menu

3. Press the [7] key to select desired contrast level from the VID CONTR field.
4. Press the [ENTER/SELECT] key to register you selection and the [MENU] key to finish.

1.41 Clutter Sweep

The clutter sweep feature suppresses sea and rain clutters within the trackball-selected area, to discriminate specific targets from noise. The user may select the area to process and the level of suppression to apply as follows:

1. Press the [MENU] key.
2. Press the [5] key twice to select the ECHO SIG menu.
3. Press the [8] key to turn on/off the clutter sweep function, and then press the [ENTER/SELECT] key.

OFF: Turns off clutter sweep feature.

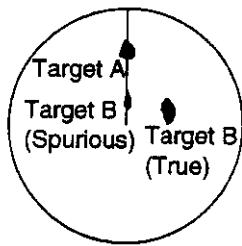

Figure 2-3 Sidelobe echoes

Virtual image

A relatively large target close to your ship may be represented at two positions on the screen. One of them is the true echo directly reflected by the target and the other is a false echo which is caused by the mirror effect of a large object on or close to your ship as shown in the figure below. If your ship comes close to a large metal bridge, for example, such a false echo may temporarily be seen on the screen.

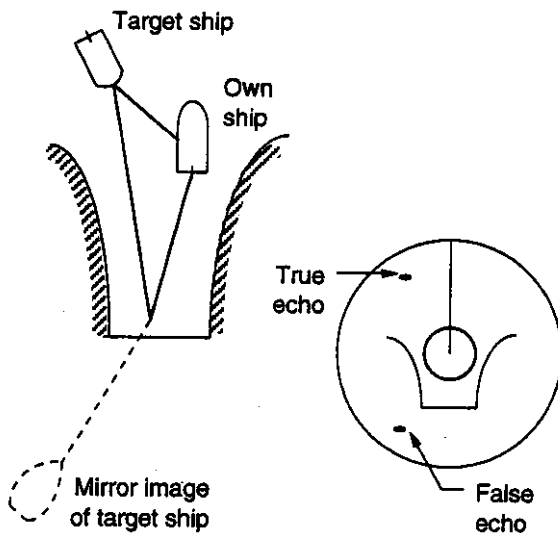

Figure 2-4 Virtual image

Shadow sectors

Funnels, stacks, masts, or derricks in the path of the scanner block the radar beam. If the angle subtended at the scanner is more than a few degrees, a non-detecting sector may be produced. Within this sector targets can not be detected.

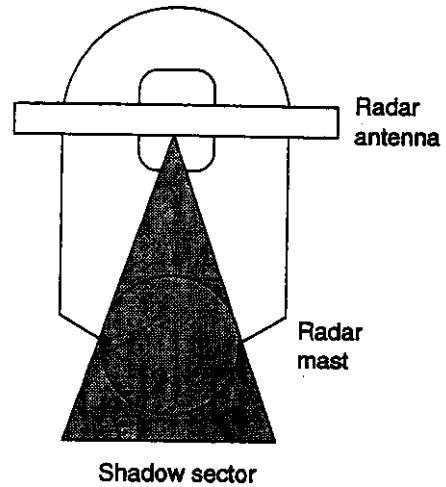

Figure 2-5 Shadow sectors

2.3 SART (Search and Rescue Transponder)

A Search and Rescue Transponder (SART) may be triggered by any X-Band (3 cm) radar within a range of approximately 8 nm. Each radar pulse received causes it to transmit a response which is swept repetitively across the complete radar frequency band. When interrogated, it first sweeps rapidly ($0.4 \mu\text{s}$) through the band before beginning a relatively slow sweep ($7.5 \mu\text{s}$) through the band back to the starting frequency. This process is repeated for a total of twelve complete cycles. At some point in each sweep, the SART frequency will match that of the interrogating radar and be within the pass band of the radar receiver. If the SART is within range, the frequency match during each of the 12 slow sweeps will produce a response on the radar display, thus a line of 12 dots equally spaced by about 0.64 nautical miles will be shown.

3. Press the [5] key twice to select RANGE.

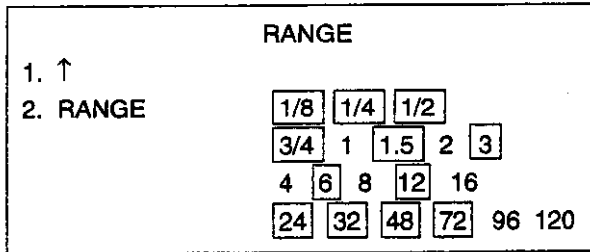

Figure 1-54 RANGE menu

4. Press the [2] key to place the underline under the range scale to select/deselect and then press the [ENTER/SELECT] key. Active ranges are highlighted. Repeat to select/deselect other ranges.
5. Press the [MENU] key.

1.45 Selecting Bearing Scale Format

The bearing scale may be displayed in degrees or compass points or degrees as follows:

1. Press the [MENU] key.
2. Press the [0] key twice to display the OTHER menu.
3. Press the [6] key twice to display the MARK/LINE menu.

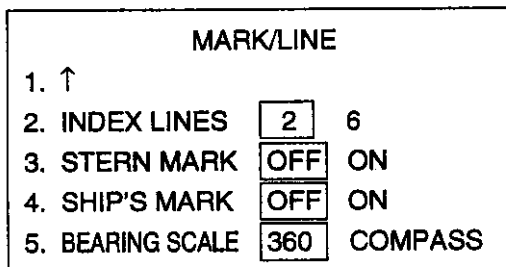

Figure 1-55 MARK/LINE menu

4. Press the [5] key to select 36 (degrees) or COMPASS.
5. Press the [ENTER/SELECT] key to register your selection and the [MENU] key to close the menu.

Radar side lobes

As the SART is approached, side lobes from the radar scanner may show the SART responses as a series of arcs or concentric rings. These can be removed by the use of the anti-clutter sea control although it may be operationally useful to observe the side lobes as they may be easier to detect in clutter conditions and also they will confirm that the SART is near to the ship.

Gain

For maximum range SART detection the normal gain setting for long range detection should be used, that is, with background noise speckle visible.

A/C SEA control

For optimum range SART detection, this control should be set to the minimum. Care should be exercised as wanted target in sea clutter may be obscured. Note also that in clutter conditions the first few dots of the SART response may not be detectable, irrespective of the setting of the anti-clutter sea control. In this case, the position of the SART may be estimated by measuring 9.5 nm miles from the furthest dot back towards own ship.

Some sets have automatic/manual anti-clutter sea control facilities in which case the operator should switch to manual.

A/C RAIN control

This should be used normally (to break up areas of rain) when trying to detect a SART response which, being a series of dots, is not affected by the action of the anti-clutter rain circuitry. Note that Racon responses, which are often in the form of a long flash, will be affected by the use of this control.

Some sets have automatic/manual anti-clutter rain control facilities in which case the operator should switch to manual.

Note: This SART information is excerpted from IMO SN/Circ 197 Operation of Marine Radar for SART Detection.

2.4 RACON (Radar Beacon)

A racon is a radar transponder which emits a characteristic signal when triggered by a ship's radar (usually only the 3 centimeter band). The signal may be emitted on the same frequency as that of the triggering radar, in which case it is superimposed on the ship's radar display automatically.

The racon signal appears on the PPI as a radial line originating at a point just beyond the position of the radar beacon or as a Morse code signal (figure below) displayed radially from just beyond the beacon.

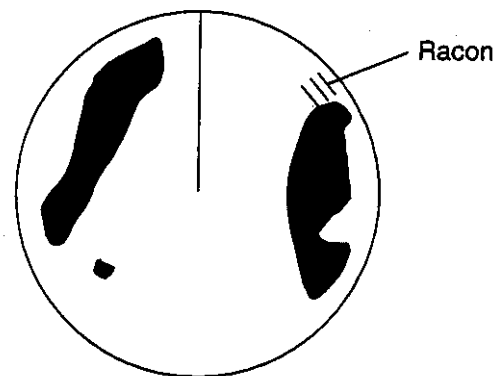





Figure 2-9 Appearance of RACON signal on the radar display

MAINTENANCE, TROUBLESHOOTIN

 WARNING	
	<p>ELECTRICAL SHOCK HAZARD Do not open the equipment.</p> <p>Only qualified personnel should work inside the equipment.</p>
	<p>Turn off the radar power switch before servicing the scanner unit. Post a warning sign near the switch indicating it should not be turned on while the scanner unit is being serviced.</p> <p>Prevent the potential risk of being struck by the rotating scanner and exposure to RF radiation hazard.</p>
	<p>Wear a safety belt and hard hat when working on the scanner unit.</p> <p>Serious injury or death can result if someone falls from the radar scanner mast.</p>

3.1 Periodic Maintenance Schedule

Periodic checks and maintenance are important for proper operation of any electronic systems. This chapter contains maintenance instructions to be followed to obtain optimum performance and the longest possible life of the equipment.

Table 3-1 Maintenance schedule

Interval	Check point	Check and measures	Remarks
Weekly	Display unit	Periodically clean the exterior of display unit with a dry soft cloth. Use of commercially available CRT cleaner (spray) having antistatic effect is recommended.	A CRT screen produces static charge which attracts dust. DO NOT use strong solvents like paint thinner or abrasive cleaners for cleaning. Dust and dirt on CRT creates symptoms similar to poor sensitivity.

(Continued on next page)

Range resolution

Range resolution is the ability to display as separate pips the echoes received from two targets which are on the same bearing and close to each other. This is determined by pulselength only. Practically, a 0.08 microsecond pulse offers the discrimination better than 35 m as do so with all FURUNO radars.

Test targets for determining the range and bearing resolution are radar reflectors having an echoing area of 10 m².

Bearing accuracy

One of the most important features of the radar is how accurately the bearing of a target can be measured. The accuracy of bearing measurement basically depends on the narrowness of the radar beam. However, the bearing is usually taken relative to the ship's heading, and thus, proper adjustment of the heading line at installation is an important factor in ensuring bearing accuracy. To minimize error when measuring the bearing of a target, put the target echo at the extreme position on the screen by selecting a suitable range.

Range measurement

Measurement of the range to a target is also a very important function of the radar. Generally, there are two means of measuring range: the fixed range rings and the variable range marker (VRM). The fixed range rings appear on the screen with a predetermined interval and provide a rough estimate of the range to a target. The variable range marker's diameter is increased or decreased so that the marker touches the inner edge of the target, allowing the operator to obtain more accurate range measurements.

2.2 False Echoes

Occasionally echo signals appear on the screen at positions where there is no target or disappear even if there are targets. They are, however, recognized if you understand the reason why they are displayed. Typical false echoes are shown below.

Multiple echoes

Multiple echoes occur when a transmitted pulse returns from a solid object like a large ship, bridge, or breakwater. A second, a third or more echoes may be observed on the display at double, triple or other multiples of the actual range of the target as shown below. Multiple reflection echoes can be reduced and often removed by decreasing the gain (sensitivity) or properly adjusting the A/C SEA control.

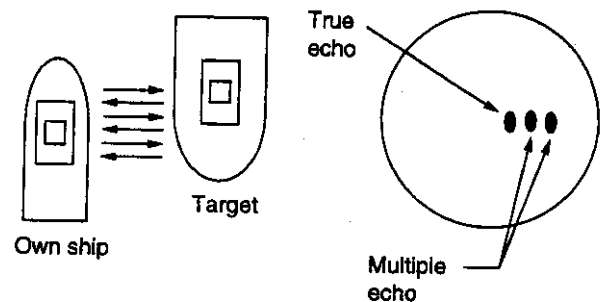

Figure 2-2 Multiple echoes

Sidelobe echoes

Every time the radar pulse is transmitted, some radiation escapes on each side of the beam, called "sidelobes." If a target exists where it can be detected by the side lobes as well as the main lobe, the side echoes may be represented on both sides of the true echo at the same range. Side lobes show usually only on short ranges and from strong targets. They can be reduced through careful reduction of the gain or proper adjustment of the A/C SEA control.

3.3 Fuse Replacement

Various fuses are used to protect the equipment from overvoltage (overcurrent) or equipment fault. If the fuse blows find the cause before replacing. If the fuse blows again after replacement, request service.

 CAUTION
<p>Use the proper fuse.</p> <p>Use of a wrong fuse can cause fire or equipment damage.</p>

Table 3-3 Fuses

FR-1760DS	Display unit	20A	
	Power Supply Unit	5A, 2A	
FR-1710 FR-1725	Display unit	20A 10A 5A	DC unit 100VAC 220VAC

3.4 Replacement of Batteries

The GYRO CONVERTER Board (option) has a battery. The battery for the RP Board preserves data when the power is turned off, and its life is about five years. When the battery voltage is low, NG (No Good) appears at the diagnostic test for the RP board. When this happens, contact your dealer to request replacement of the battery.

Table 3-4 Battery replacement information

Board Name	Battery Type	Code Number
RP Board	ER3S	000-127-759
GC Board	CR 1/2 8.L	000-103-769

3.5 Simple Troubleshooting

This paragraph describes how to cure operational problems, which can be made by observing the radar picture and using operator controls and keys without opening the display unit, antenna unit or other equipment units.

The table below shows user-level troubleshooting procedures.

Table 3-5 Easy troubleshooting

Problem	Remedy
No own ship marker	Check that SHIP'S MARK ON is selected at the MARK/LINE menu (keying sequence: [MENU], [0], [0] [6], [6]). Also, own ship information (length, width, etc.) should have been entered in initial settings. Consult a FURUNO representative or dealer for details.
No picture	Turn the BRILL control clockwise.
Color appears abnormal	Push the EBL rotary control to degauss the screen.
No nav data	Turn on navigation device.

When the range to the SART is reduced to about 1 nm, the radar display may show also the 12 responses generated during the fast sweeps. These additional dot responses, which also are equally spaced by 0.64 nm, will be interspersed with the original line of 12 dots. They will appear slightly weaker and smaller than the original dots.

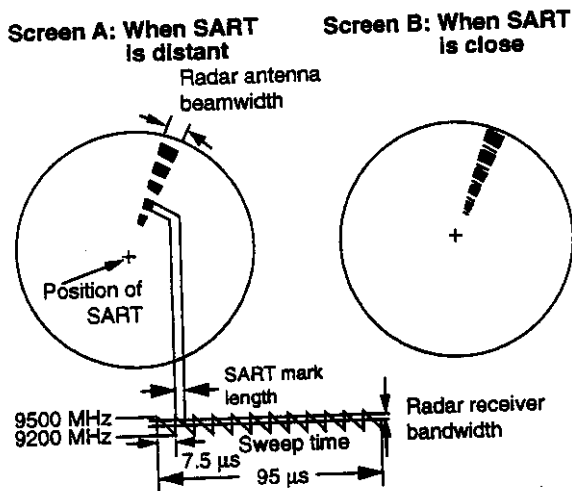

Figure 2-6 Appearance of SART signal on the radar display

Showing SART marks on the radar display

A range scale between 6 and 12 nm with normal radar settings should display SART signals. However, this radar has a special feature which enhances the SART signals.

1. Detune the radar. Press the [MENU] key followed by the [0] key twice to display the OTHER menu.

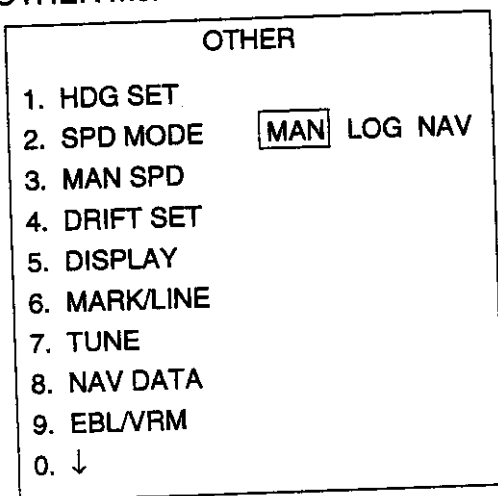

Figure 2-7 OTHER menu

2. Press the [0] key twice.
3. Press the [5] key twice select DISPLAY.

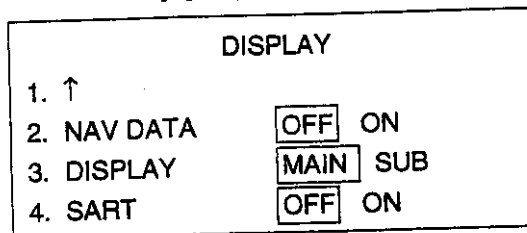

Figure 2-8 DISPLAY menu

4. Press the [4] key several times to select OFF or ON from the SART field as appropriate.
5. Press the [ENTER/SELECT] key followed by the [MENU] key.

When the SART function is turned on the range is set to 12 nm, the noise rejector, echo averaging, AUTO A/C and interference rejector are turned off, and SART is displayed at the upper left-hand corner of the screen.

General remarks on receiving SART

SART range errors

When responses from only the 12 low frequency sweeps are visible (when the SART is at a range greater than about 1 nm), the position at which the first dot is displayed may be as much as 0.64 nm beyond the true position of the SART. When the range closes so that the fast sweep responses are seen also, the first of these will be no more than 150 meters beyond the true position.

Radar bandwidth

This is normally matched to the radar pulselength and is usually switched with the range scale and the associated pulselength. Narrow bandwidths of 3-5 MHz are used with long pulses on long range and wide bandwidths of 10-25 MHz with short pulses on short ranges.

Any radar bandwidth of less than 5 MHz will attenuate the SART signal slightly, so it is preferable to use a medium bandwidth to ensure optimum detection of the SART.

Table 3-6 Advanced-level troubleshooting

Problem	Check point and probable cause	Remedy
Adjust GAIN control with A/C SEA control set at minimum. Marks and legends appear but no noise or echo.	<ol style="list-style-type: none"> 1. IF amplifier 2. Signal cable between antenna and display 3. Video Amplifier Board 	<ol style="list-style-type: none"> 1. Replace IF amplifier. 2. Check continuity and isolation of coaxial cable. (Note: Disconnect the plug and lugs at both ends of coaxial cable before checking it by ohmmeter.) 3. Check video coax line for secure connection. If connection is good, replace SPU Board.
Marks, legends and noise appear but no echo. (Transmission leak, representing own ship position, is absent.)	<ol style="list-style-type: none"> 1. Magnetron 2. Modulator Board 3. SPU Board 	<ol style="list-style-type: none"> 1. Check magnetron current. 2. Replace Modulator Board. 3. Replace SPU Board.
Picture not updated	<ol style="list-style-type: none"> 1. Bearing Signal Generator Board (scanner unit) 2. SPU Board 3. Video lockup 	<ol style="list-style-type: none"> 1. Check the connection of signal cable. 2. Replace SPU Board. 3. Turn off and on radar.
Incorrect orientation of picture	<ol style="list-style-type: none"> 1. SPU Board 2. Gyro Interface 	<ol style="list-style-type: none"> 1. The message "HD SIG MISSING" appears when the heading pulse is not received during stand-by. 2. Replace gyro interface.
Tuning manually adjusted but poor sensitivity	<ol style="list-style-type: none"> 1. Deteriorated magnetron 2. Detuned MIC 3. Dirt on radiator face 4. Second trace rejection is ON. 	<ol style="list-style-type: none"> 1. With radar transmitting on 48 nm range, check magnetron current. If current is below normal value, magnetron may be defective. Replace magnetron. 2. Check MIC detecting current. If it is below normal value, MIC may have become detuned. MIC must be tuned. 3. Clean radiator surface. 4. Disable the second-trace rejector referring to paragraph 1.33.
Range changed but radar picture does not change	<ol style="list-style-type: none"> 1. Defective RANGE key 2. SPU Board 3. Mother Board 4. Video lockup 	<ol style="list-style-type: none"> 1. Try to hit [+] and [-] RANGE keys several times. If unsuccessful, replacement of keypad may be required. 2. Replace SPU Board. 3. Replace Mother Board. 4. Turn off and on radar.

3.7 Diagnostic Test

A diagnostic test program is provided to enable testing of major circuit boards in the radar display unit. Note that the normal radar picture is lost during this test.

Proceed as follows to execute the diagnostic test:

1. Press the MENU key to shown the main menu.
2. Press the [0] key four times to select the OTHER sub menu.
3. Press the [2] key to select TEST.

Program numbers appear. The diagnostic test is executed and the screen shows test results as shown on the next page. OKs appear for normal operation. ARP results appear only when optional ARP Board is mounted. If NG (No Good) appears, corresponding components may be defective. Consult your dealer.

5. Small squares and circles displayed on the test results screen are for testing the keys and controls. As you operate the keys, corresponding squares are highlighted, indicating that your control/key operations are properly recognized.
6. Press the [ENTER/SELECT] key to check the display circuit. See page 3-9.
7. To terminate the diagnostic test, press the [MENU] key.

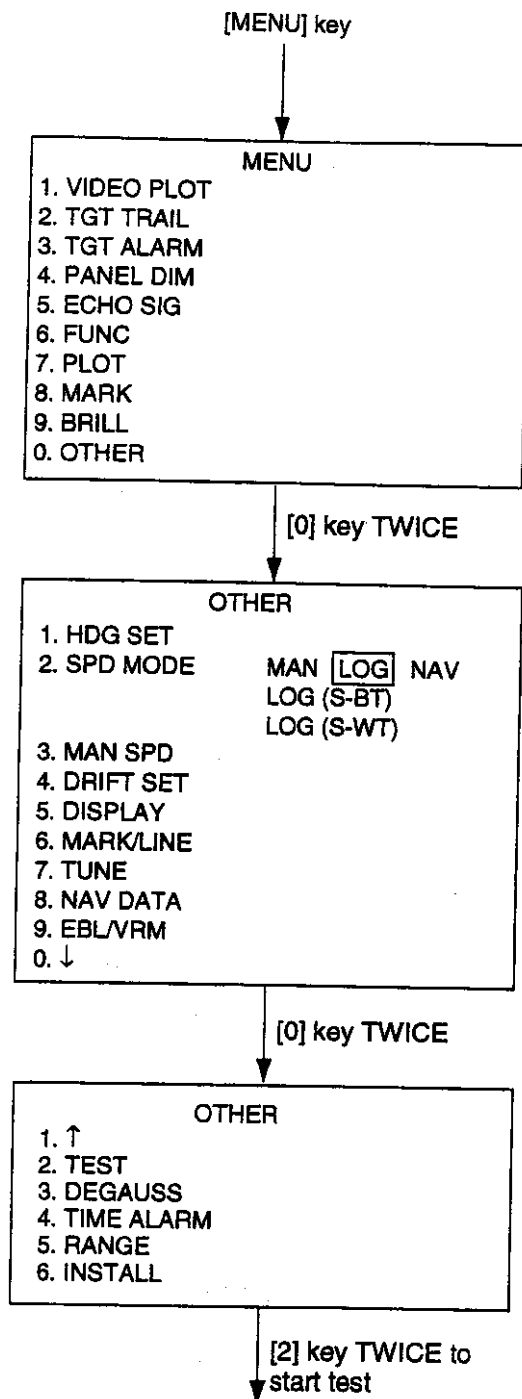

Figure 3-1 Sequence for diagnostic test

Table 3-1 Maintenance schedule (con't)

Interval	Check point	Check and measures	Remarks
3 to 6 months (for qualified technicians only)	Exposed nuts and bolts on scanner unit	Check for corroded or loosened nuts and bolts. If necessary, clean and repaint them thickly. Replace them if heavily corroded.	Sealing compound may be used instead of paint. Apply a small amount of grease between nuts and bolts for easy removal in future.
	Scanner radiator	Check for dirt and cracks on radiator surface. Thick dirt should be wiped off with soft cloth dampened with fresh water. If a crack is found, apply a slight amount of sealing compound or adhesive as a temporary remedy, then call for repair.	Do not use plastic solvent (acetone) for cleaning. If you need to remove ice from scanner unit, use a wooden hammer or plastic head hammer. Crack on the unit may cause water ingress, causing serious damages to internal circuits.
	Terminal strips and plugs in scanner unit	Open scanner cover to check terminal strip and plug connections inside. Also check the rubber gasket of antenna covers for deterioration.	When closing scanner covers in position, be careful not to catch loose wires between covers and unit.
6 months to one year (for qualified technicians only)	CRT and surrounding components	High voltage at CRT and surrounding components attract dust in environment which will cause poor insulation. Ask a FURUNO representative or dealer to clean internal high-voltage components.	If CRT anode rubber cap or wire sheath is cracked, replace it. For service technician: Wait at least 3 minutes until high voltage components (CRT and HV capacitors) discharge their residual charges before accessing them.
	Terminal strips, sockets, earth terminal	Check for loose connections. Check contacts and plugs for proper seating, etc.	

3.2 Life Expectancy of Major Parts

Table 3-2 Life expectancy of major parts

Part	Type	Code No.	Life expectancy	Radar Type
Magnetron	MG5240F (60 kW)	000-100-240	3,000 hours	FR-1760DS
Magnetron	MG5241	000-100-036	3,000 hours	FR-1710
Magnetron	MG5436	000-140-762	3,000 hours	FR-1725

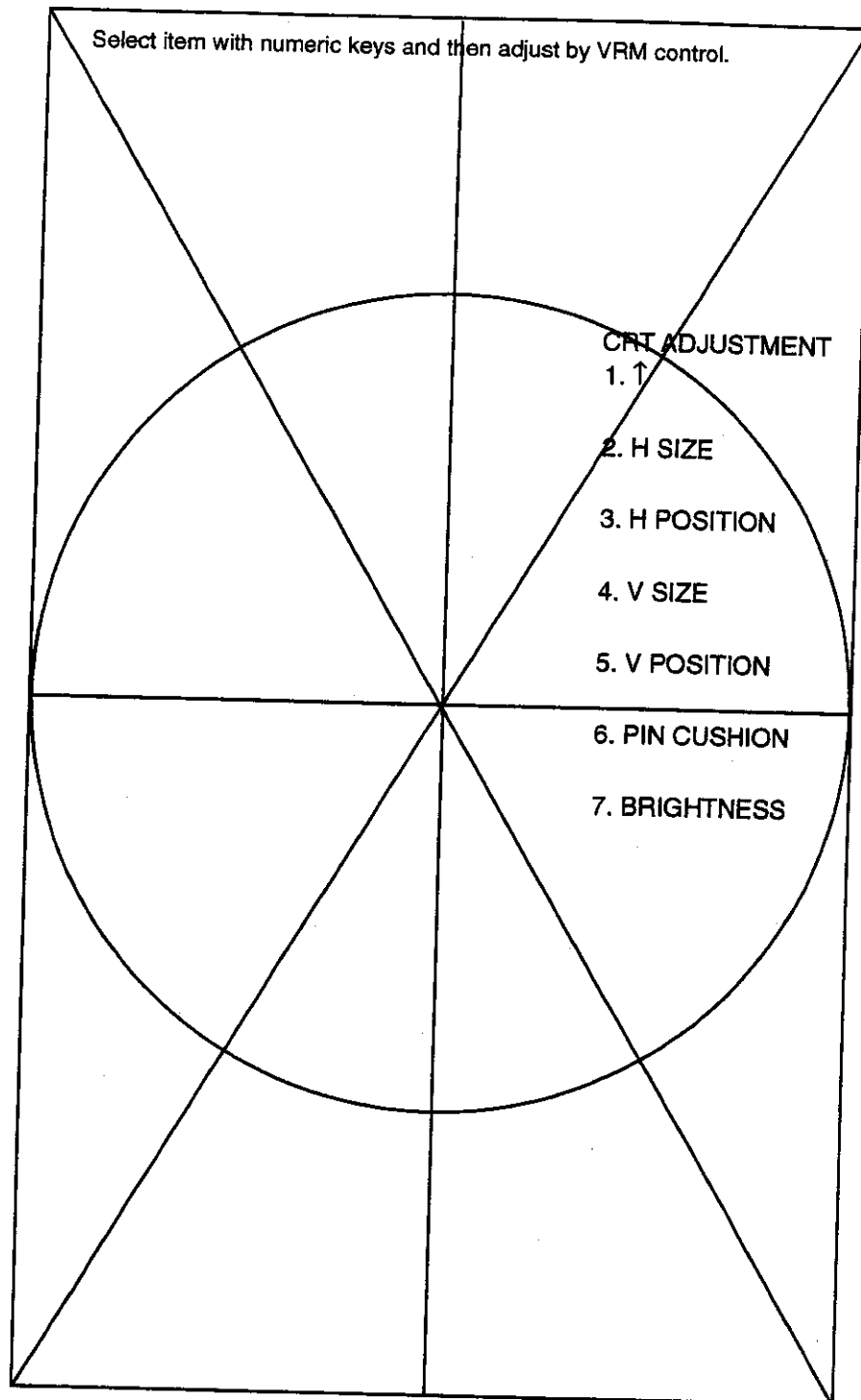

Figure 3-3 Display circuit test

3.6 Advanced-level Troubleshooting

This paragraph describes how to cure hardware and software troubles which should be carried out by qualified service personnel.

Note: This radar equipment contains complex modules in which fault diagnosis and repair down to component level are not practicable by users.

Serviceman qualification

All adjustments of radio transmitter during or coinciding with the installation, servicing, or maintenance which may affect the proper operation must be performed by or under the immediate supervision and responsibility of a person holding an operator certificate containing a ship radar endorsement.

This is what the U.S. Codes of Federal Regulations part 80.169 implies (not exact extract).

As such, every administration sets forth its own rule; service personnel must be aware of this kind of competency requirements.

Service call

When making a service call to your service agent, check S/N and symptom beforehand.

PARTS LOCATION

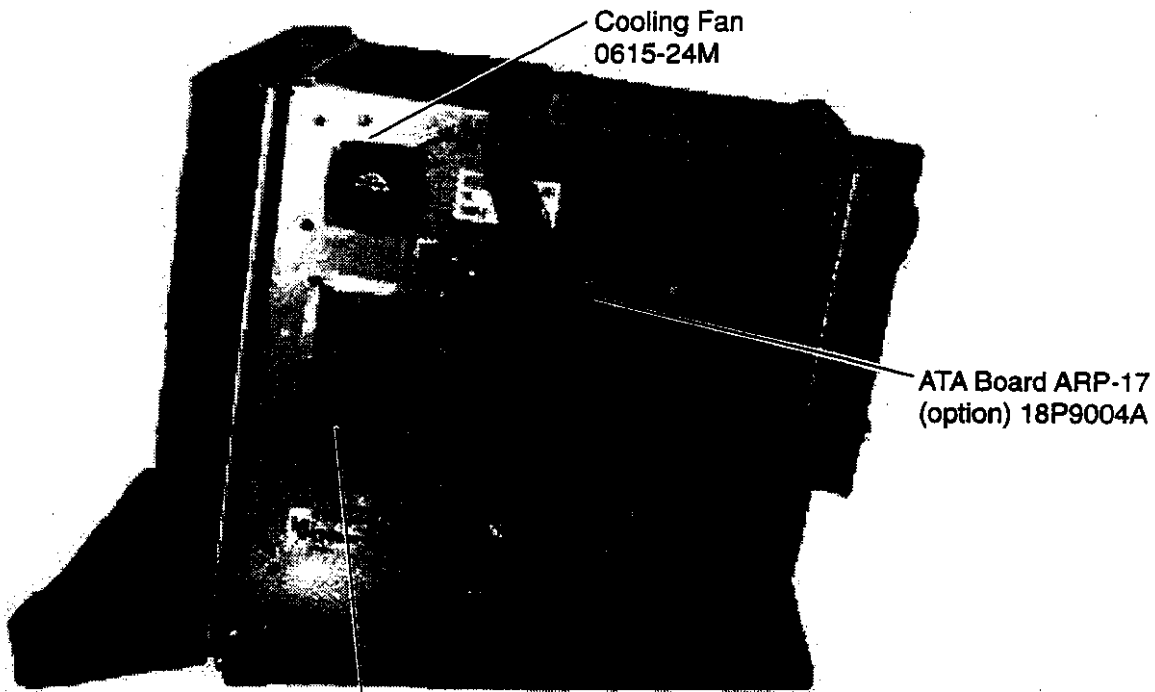

	DANGER
	Electrical shock hazard. Do not touch anode cap or its cable.

Figure 4-1 Display unit, right side view

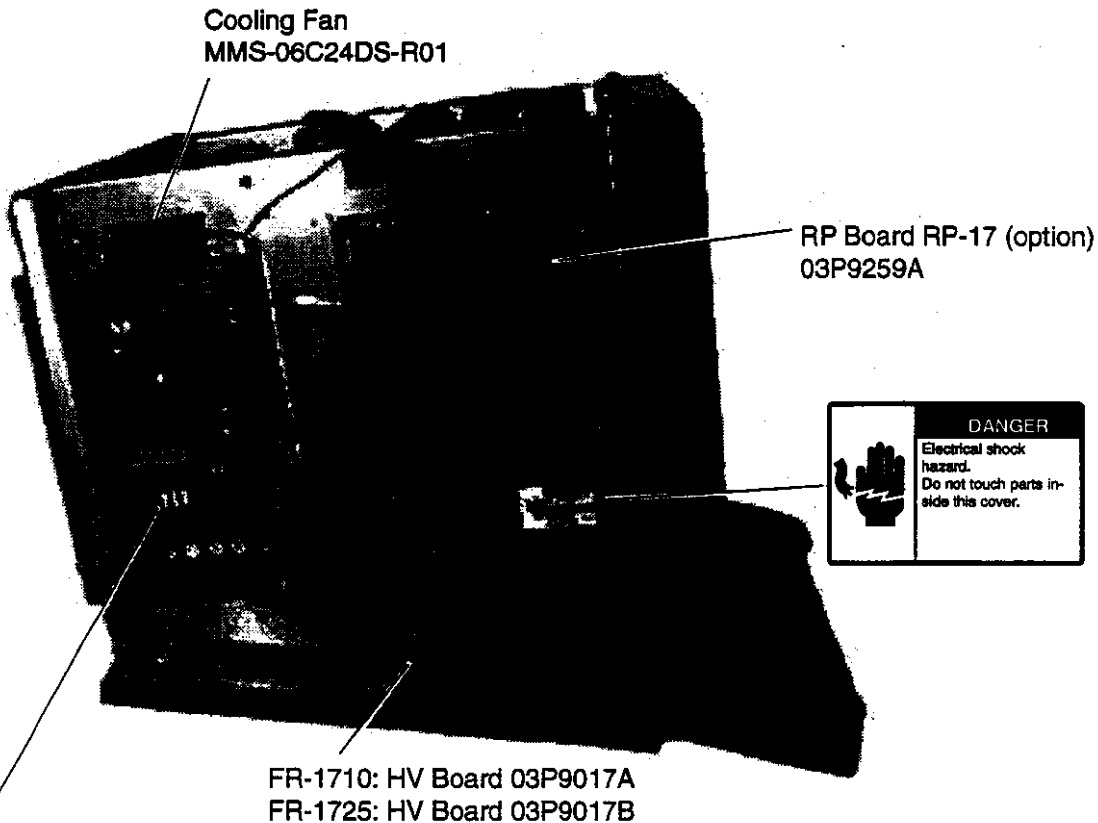

	DANGER
	Electrical shock hazard. Do not touch parts inside this cover.

FR-1760DS:DC-PTU Board 03P9223B
FR-1710/1725: DC-PTU Board 03P9223A

Table 3-7 Advanced-level troubleshooting (con't)

Problem	Check point and probable cause	Remedy
Interference rejector inoperable (interference rejection level not displayed)	1. SPU Board 2. Mother Board	1. Replace SPU Board. 2. Replace Mother Board.
Echo stretch ineffective (Neither "ES1" nor "ES2" is displayed.)	1. SPU Board	1. Replace SPU Board.
Only 2 parallel index lines (6 lines wanted)	1. Incorrect setting of index line interval	1. Set index line interval referring to paragraph 1.27.
Range rings are not displayed.	1. Adjust the brilliance of range rings with the intensity is increased. 2. SPU Board	1. Replace associated circuit board if unsuccessful. 2. Replace SPU Board.
Poor discrimination at range	1. Sea clutter control not functioning properly.	1. Improper setting of A/C SEA control. If A/C SEA is seen only at very close range, suspect inaccurate frequency of crystal oscillator.
True motion presentation not working correctly.	1. Poor contact of MODE key. 2. Selection is not accessed. 3. Speed entry is incorrect. 4. TM display inaccurate	1. Try to press MODE key a little harder. 2. Press MODE key until "TM" appears. 3. Enter correct own ship speed referring to paragraph 1.12. 4. Make sure that speed and compass inputs are accurate.
Target not tracked correctly	1. Poor definition of targets in sea clutter	1. Adjust A/C SEA and A/C RAIN controls referring to paragraphs 1.14 and 1.15.

FR-1760DS Scanner Unit

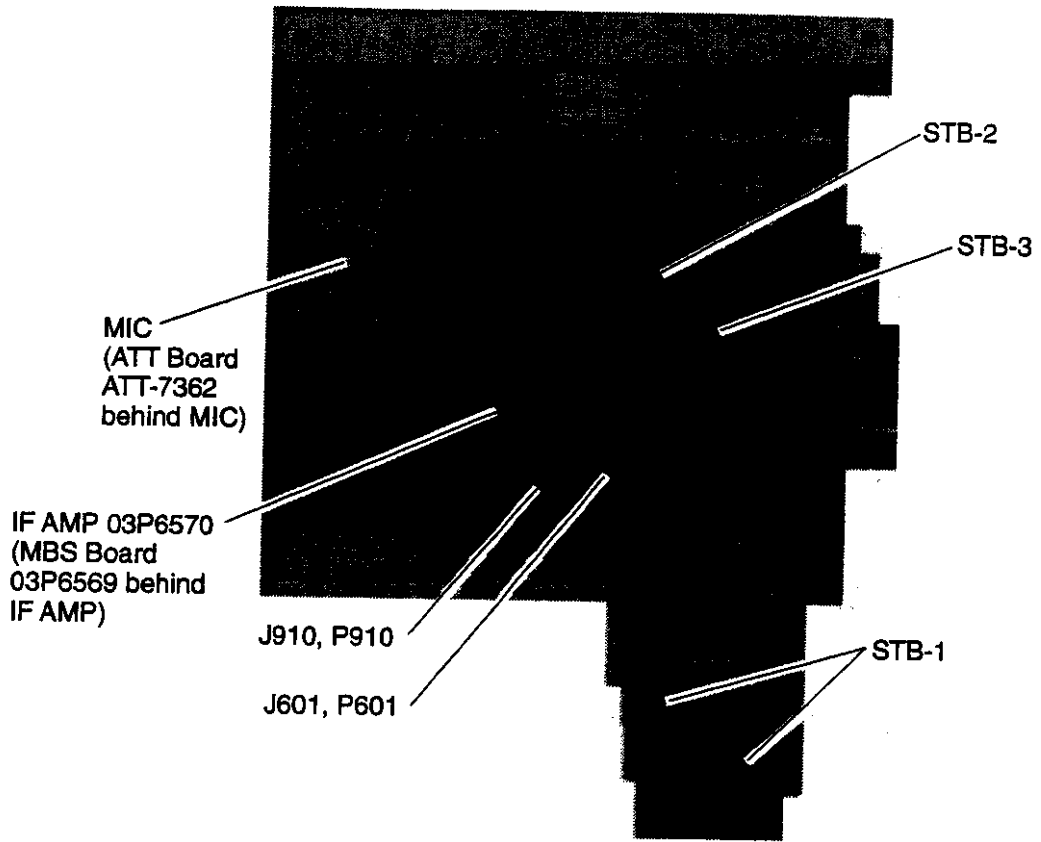

Figure 4-5 Scanner unit, left side view

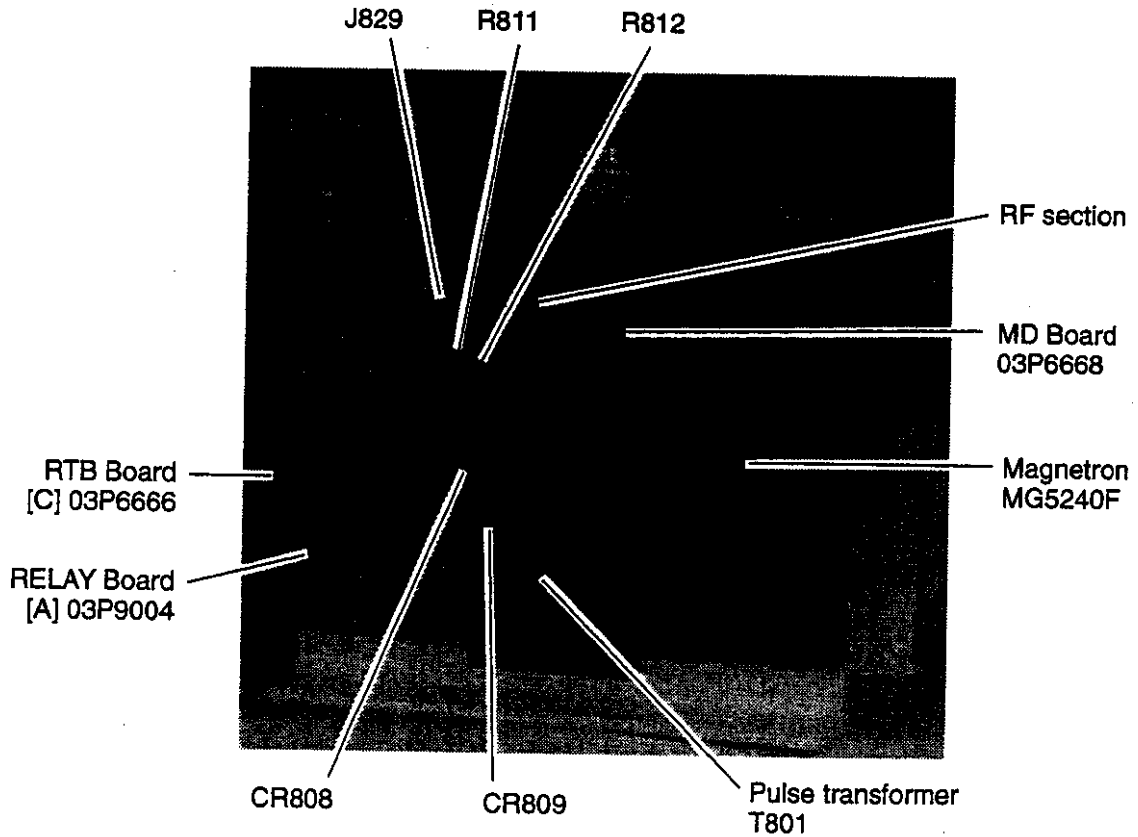

Figure 4-6 Scanner unit, right side view

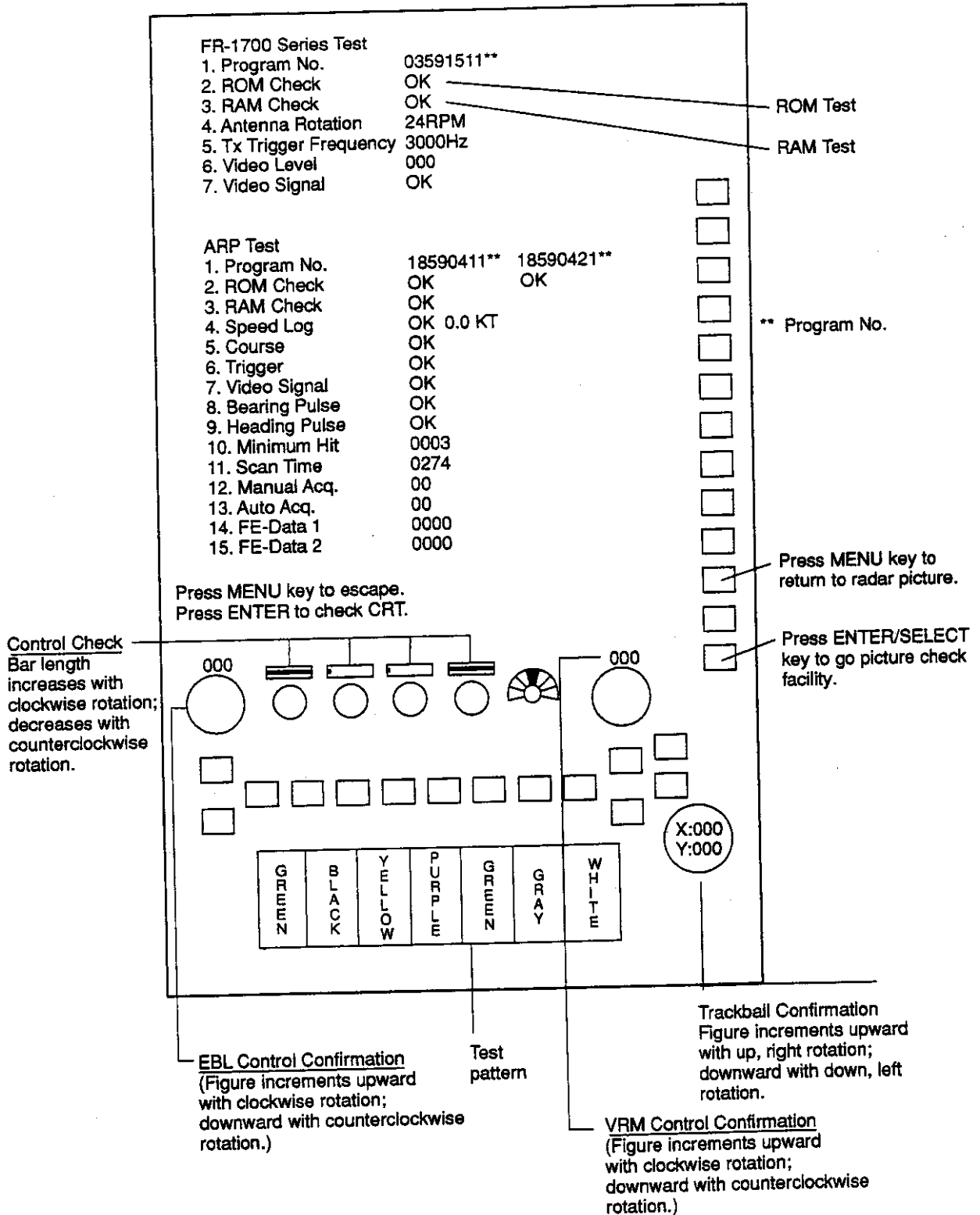

Figure 3-2 Test results screen

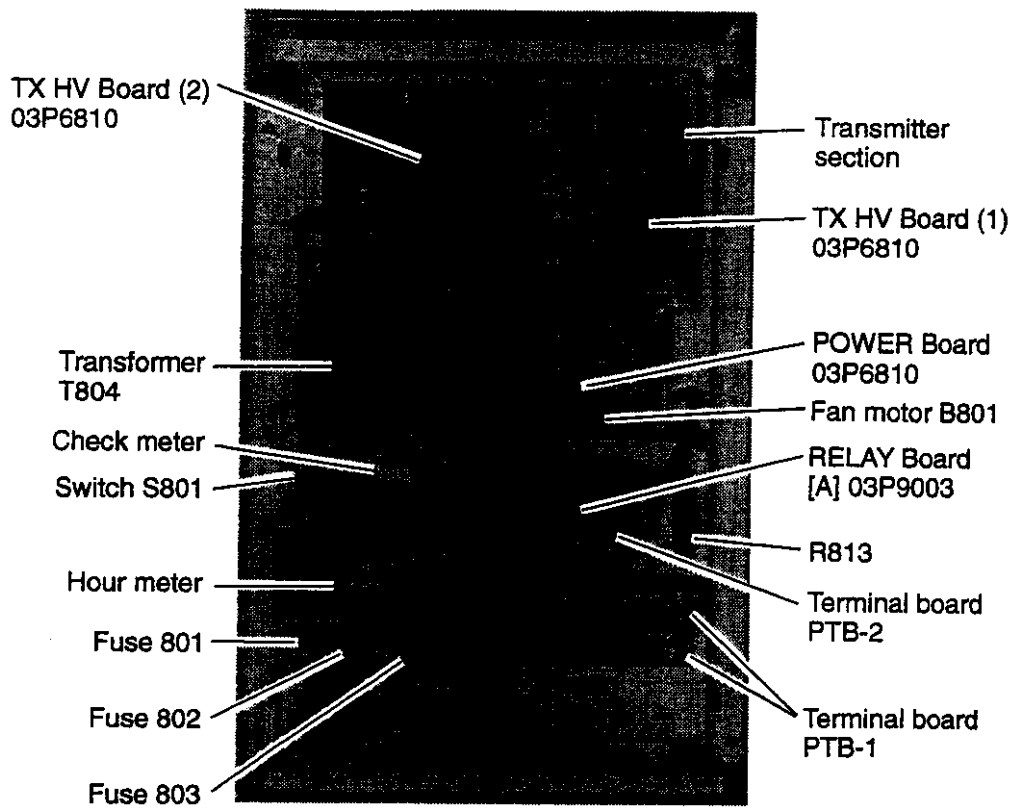
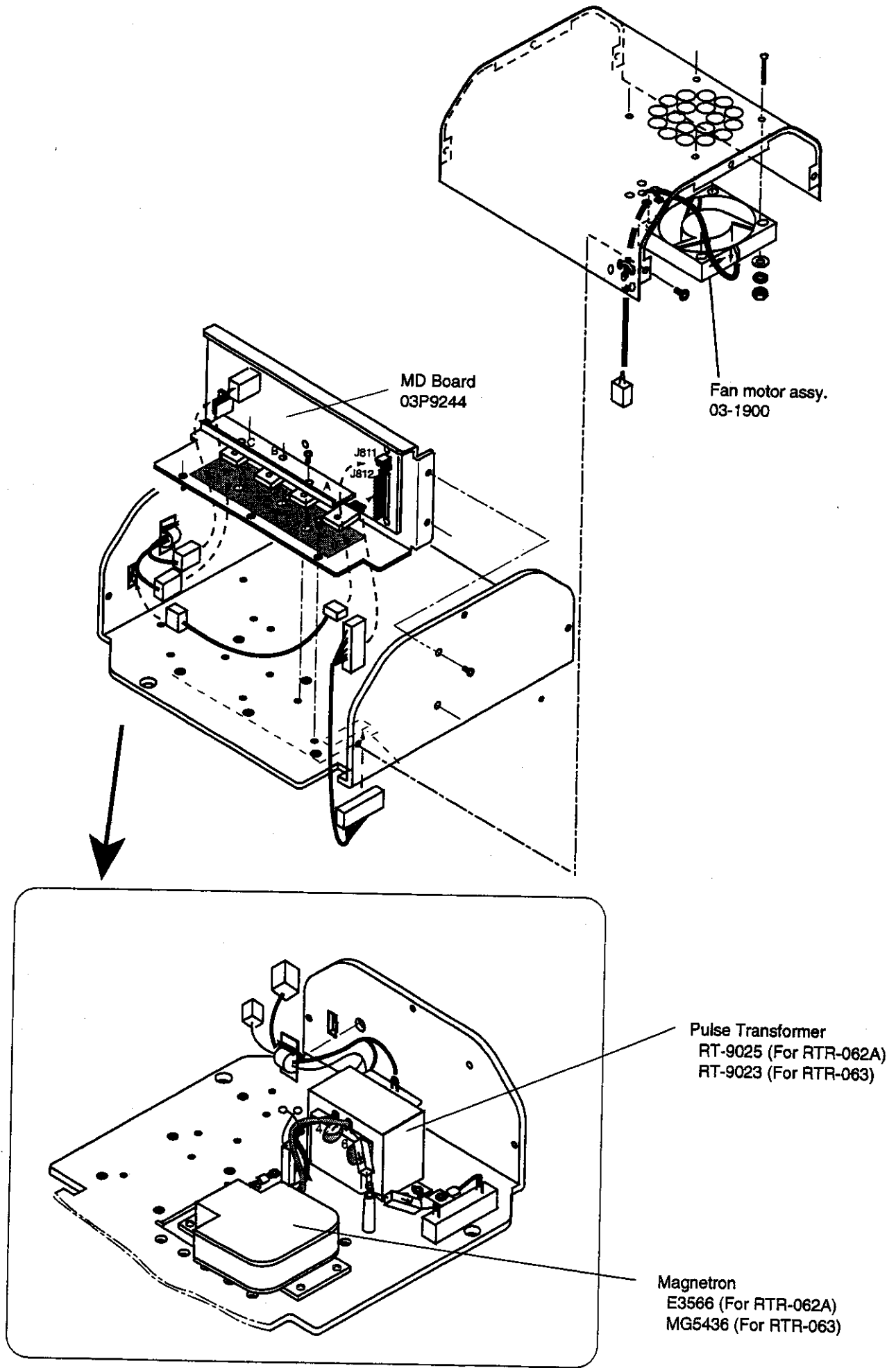

Figure 4-9 FR-1760DS Power supply unit



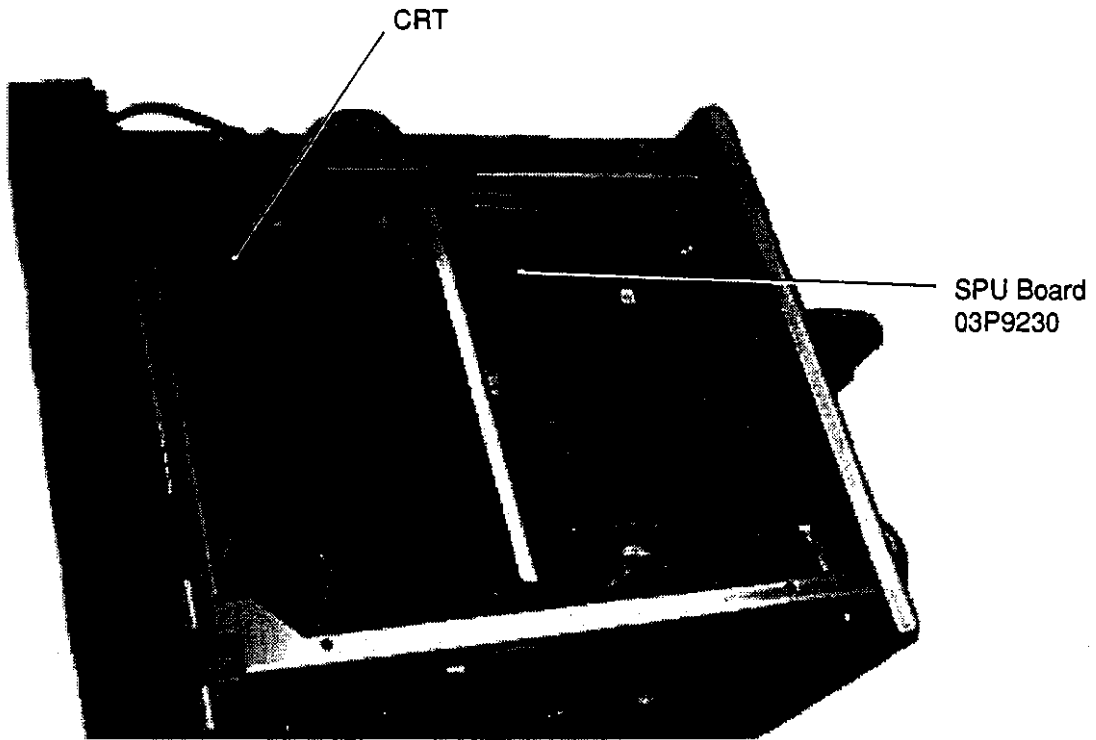

Figure 4-3 Display unit, top view

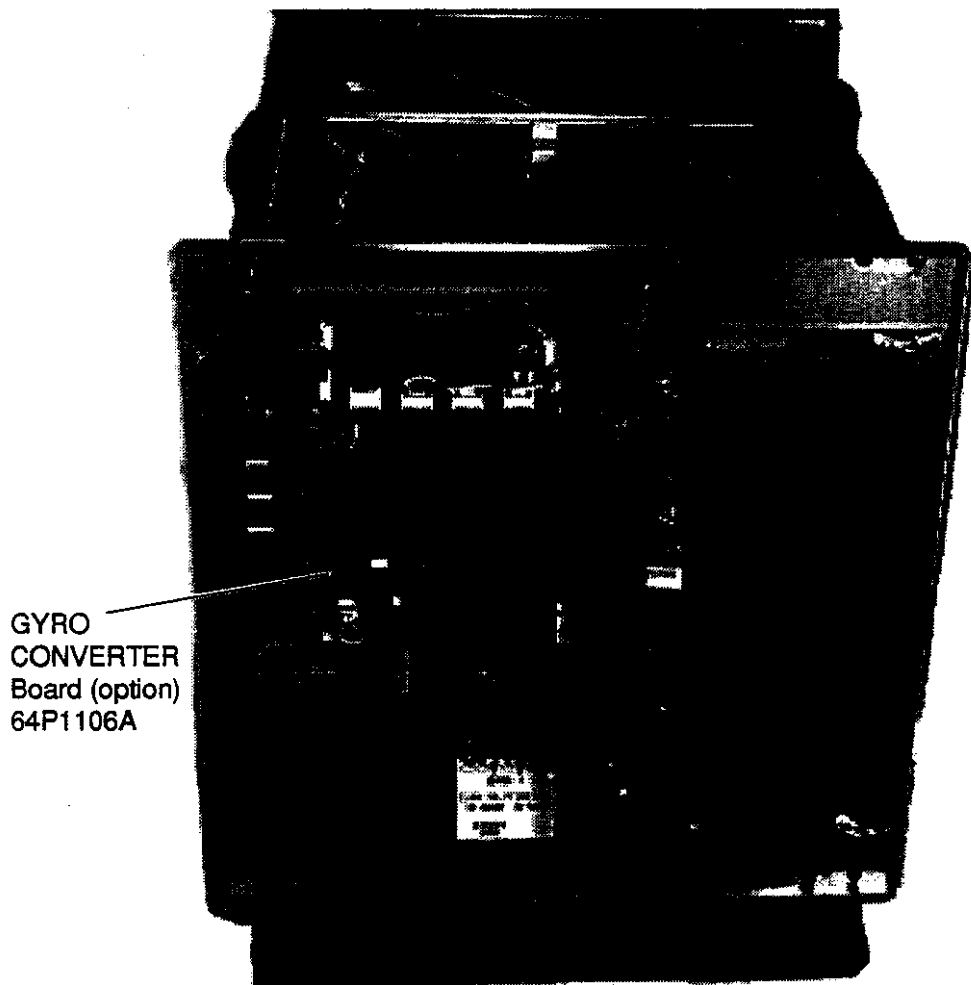

Figure 4-4 Display unit, top view

SPECIFICATIONS OF MARINE RADAR

FR-1710/1725/1760DS

1. ANTENNA RADIATORS

- | | |
|--------------------------|---|
| (1) Type | Slotted waveguide array |
| (2) Polarization | Horizontal |
| (3) Rotation | 24 rpm or 42 rpm (FR-1760DS: 24 rpm only) |
| (4) Radiator length | 4 ft (XN12AF), 6.5 ft (XN20AF), 8 ft (XN24AF)
8.1 ft (SN4A), 9 ft (SN5A) |
| (5) Horizontal Beamwidth | |
| -3 dB: | 1.8° (XN12AF), 1.23° (XN20AF), 0.95° (XN24AF)
2.68° (SN4A), 1.23° (SN5A) |
| -20 dB: | 3.1° (XN12AF), 3.1° (XN20AF), 2.5° (XN24AF) |
| (6) Vertical Beamwidth | 20° |
| (7) Sidelobe attenuation | |
| XN12AF: | -24 dB (within ±10° of main-lobe)
-30 dB (outside ±10° of main-lobe) |
| XN20AF/XN24AF: | -24 dB (within ±20° of main-lobe)
-30 dB (outside ±20° of main-lobe) |
| SN4A: | -23 dB (within ±20° of main-lobe)
-25 dB (outside ±20° of main-lobe) |
| SN5A: | -20 dB (within ±20° of main-lobe)
-25 dB (outside ±20° of main-lobe) |
| (8) Antenna Gain | XN12AF: 27.5 dB, XN20AF: 30.0 dB, XN24AF: 31.5 dB
SN4A: 26.0 dB, SN5A: 26.4 dB |
| (9) Wind Speed | 51.5 m/s relative |

2. RF TRANSCEIVER

- | | |
|-----------------------|--|
| (1) Frequency | FR-1710/1725: 9410 MHz ±30 MHz
FR-1760DS: 3050 MHz ±30 MHz |
| (2) Output Power | FR-1710: 10 kW, FR-1725: 25 kW, FR-1760DS: 60 kW |
| (3) Spurious Response | -40 dB or less |
| (4) IF Amplifier | 60 MHz, Logarithmic |
| (5) Bandwidth | |
| FR-1710/1725: | Short 1/2, Middle 1 pulse: 27 MHz
Middle 2/3, Long pulse: 3 MHz |
| FR-1760DS: | Short pulse: 27 MHz
Middle 1/2, Long pulse: 3 MHz |

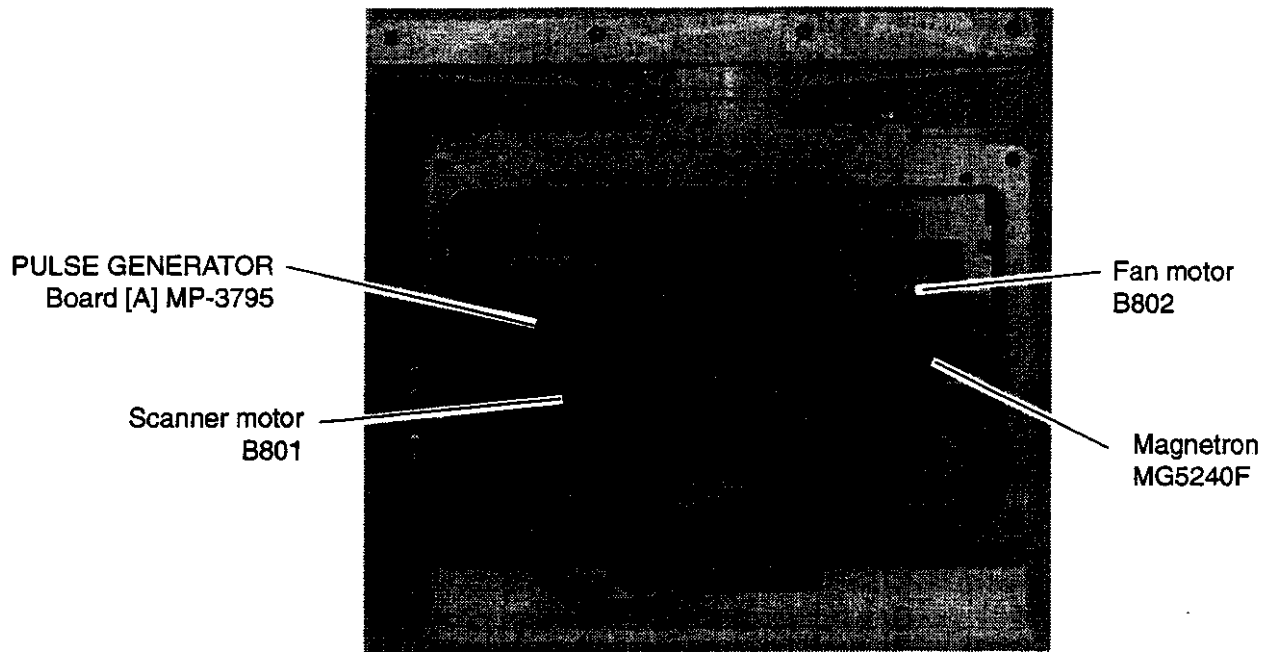

Figure 4-7 Scanner unit, right side view, RF section removed

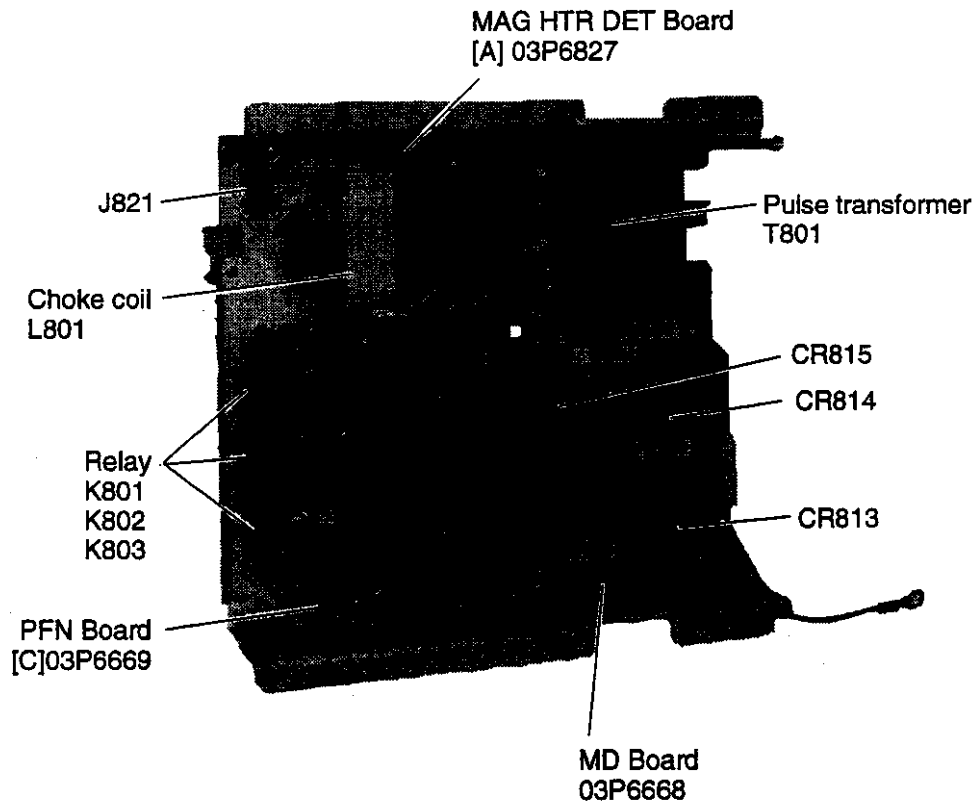

Figure 4-8 RF section, rear view

- (7) Bearing accuracy $\pm 1^\circ$
- (8) Range accuracy 1% of range in use or 8 m whichever is the greater
- (9) Presentation modes Head-up, Head-up TB, North-up, Course-up, True motion north-up
(Gyro signal required except for HU)
- (10) Variable Range Markers Two Variable Range Markers, switchable
- (11) Electronic Bearing Lines Two Electronic Bearing Lines, switchable
- (12) Offcenter Sweep origin can be offcentered by 75% of range in use in any direction
(Not available for maximum range)

4. POWER SUPPLY

- (1) DC Source
 - FR-1710/1725: 24 rpm: 24/32 VDC: 8.5/6.4 A, 42 rpm: 24/32 VDC: 8.8/6.6 A
 - FR-1760DS: 24 VDC: 5.6 A
- (2) AC Source
 - FR-1710: 100-115/200-230 VAC, 1 phase, 50-60 Hz
2.3 A (24 rpm), 3.2 A (42 rpm)
 - FR-1725: 100-115/200-230 VAC, 1 phase, 50-60 Hz
3.2 A (24 rpm), 3.3 A (42 rpm)
 - FR-1760DS:
 - Display unit: 24 VDC: 5.6 A
 - Antenna power supply unit: 100-115 VAC: 3.0 A, 1 phase, 50-60 Hz
220/240 VAC, 1 phase, 50-60 Hz (optional rectifier required)

5. DIMENSION AND MASS

See Outline Drawing

6. ENVIRONMENTAL CONDITIONS

- (1) Ambient temperature (Complies with IEC 945)
 - Display unit: -15 to + 55°C
 - Antenna unit : -25 to + 70°C
- (2) Relative humidity 95% at 40°C
- (3) Water proofing Display unit (panel): IEC60529 IPX2, Antenna unit: IEC60529 IPX6
- (4) Vibration ± 1 mm $\pm 10\%$, 2(5) to 13.2 Hz,
Maximum acceleration 7 m/s^2 , 13.2 to 100 Hz
- (5) Category of Equipment Units
 - Display unit: To be installed in a protected area
 - Antenna power supply unit To be installed in a protected area
 - Antenna unit: To be installed in an exposed area

FR-1710/1725 Scanner Unit

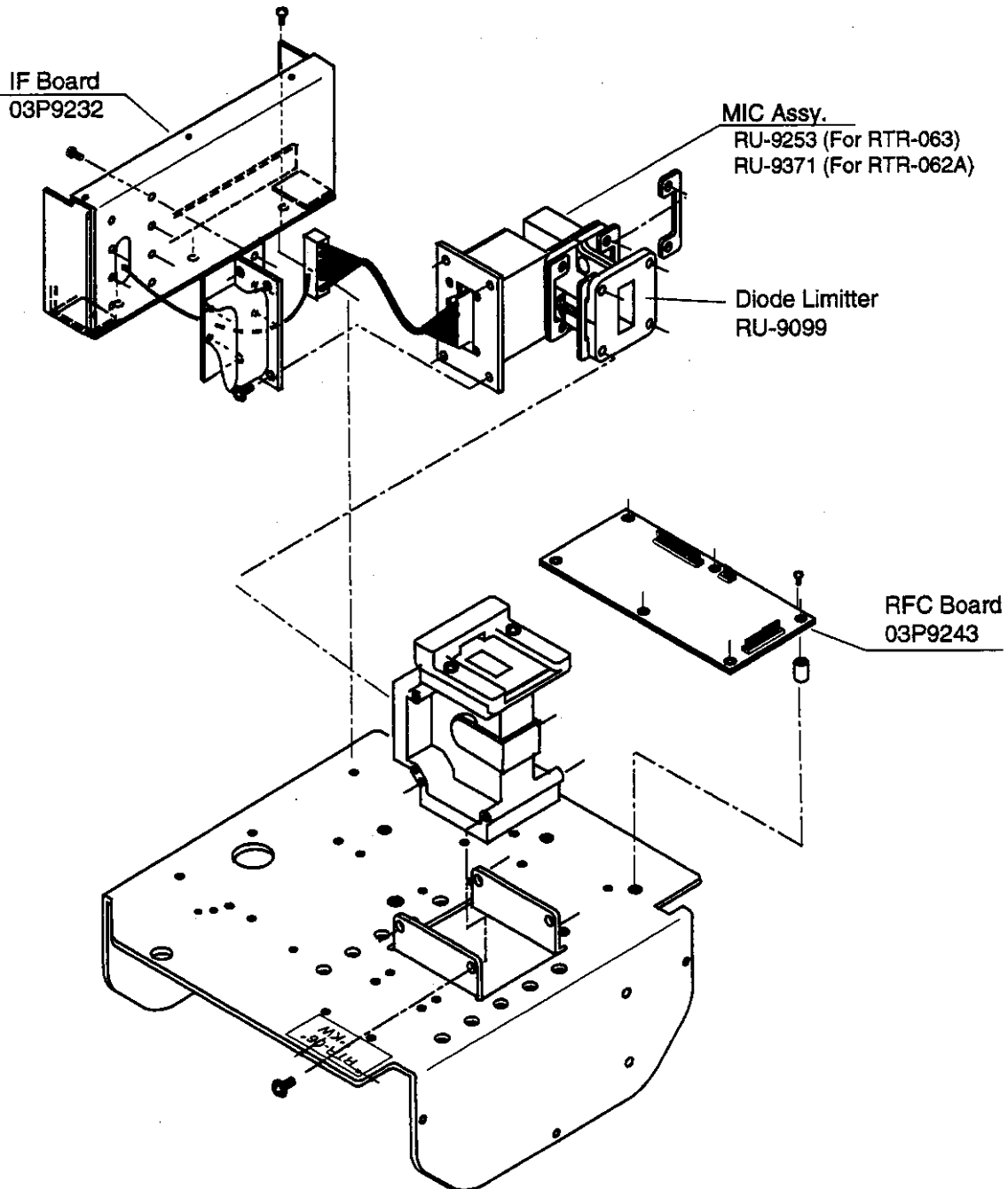
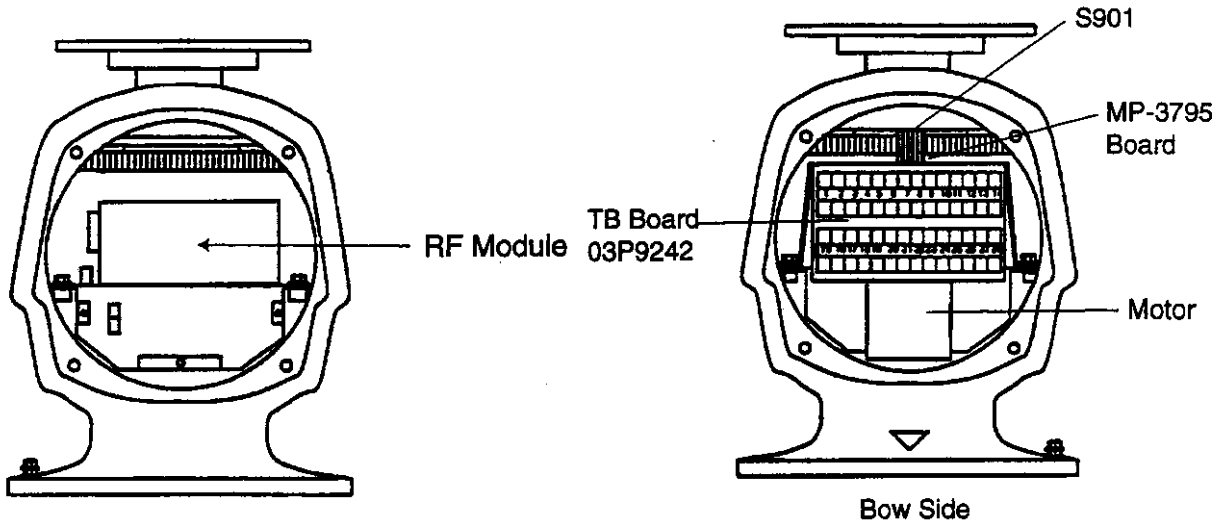

INDEX

A

A/C AUTO control 1-11
A/C RAIN control 1-12
A/C SEA control 1-11
ACQ key 1-18
Alarms 1-33
AUDIO OFF key 1-20

B

Background color 1-31
Battery replacement 3-3
Bearing measurement 1-13
Bearing scale format 1-32
BRILL control 1-3
Brilliance
 screen 1-3
 screen data 1-28

C

Clutter sweep 1-30
Compass readout adjustment 1-4

D

DEGAUSS control 1-4
Degaussing interval 1-29
Diagnostic test 3-7

E

EBL OFF key 1-13
EBL OFFSET key 1-14
EBL ON key 1-13
Echo averaging 1-17
ECHO control 1-9
Echo stretch 1-9
Electronic Plotting Aid (EPA) 1-18–1-21
 CPA/TCPA ranges 1-20
 past plot points 1-20
 plotting a target 1-18
 silencing audio alarm 1-20
 target data 1-19
 terminating plotting 1-19
 true, relative vector 1-19
 vector time 1-19
Enhanced video 1-29

F

False echoes 2-2–2-3
Function keys 1-26
Fuse replacement 3-3

G

GAIN control 1-11
GZ ALARM key 1-15

H

Heading line 1-25
Heading marker 1-25
HM OFF control (GAIN control) 1-25

I

INDEX LINE key 1-23
Interference rejector 1-12

M

Maintenance schedule 3-1
Major parts life expectancy 3-2
MARK key 1-24
Menu tree vii
MODE key 1-6
Multiple echoes 2-2

N

Navigation data 1-30
Noise rejector 1-28
North marker 1-25

O

Offcentering 1-16
Origin marks 1-24

P

Panel backlighting 1-3
Parallel index lines 1-23
POWER switch 1-1
Presentation modes 1-6
Pulselength 1-9

R

RACON 2-5
RANGE key 1-8
Range measurement 1-12
Range scale 1-8
Range scale preset 1-31
RINGS key 1-12

S

SART (Search and Rescue Transponder) 2-3
Second-trace echoes 1-27
Shadow sector 2-3
SHIFT key 1-16
Sidelobe echoes 2-2

(6) Range, Pulselength (PL) & Pulse Repetition Rate (PRR)

FR-1710/1725:

		Range (nm)												
PL	PRR (Hz)	0.125	0.25	0.5	0.75	1.5	3	6	12	24	48	72	96	
S1P	3000	0.07 μ s												
S2P	3000			0.15 μ s										
M1P	1500			0.3 μ s										
M2P	1000							0.5 μ s						
M3P	1000							0.7 μ s						
LP	600									1.2 μ s				

*: Second echo trace mode PRR; 500 Hz

Maximum Range: FR-1710: 72 nm, FR-1725: 96 nm

FR-1760DS:

		Range (nm)													
PL	PRR (Hz)	0.125	0.25	0.5	0.75	1.5	3	6	12	24	48	72	96	120	
SP	1900	0.08 μ s													
M1P	1100			0.3 μ s											
M2P	600							0.6 μ s							
LP	600*									1.2 μ s					

*: 450 Hz on 120 nm range

- (7) Duplexer Ferrite circulator with diode limiter
 (8) Noise figure FR-1710/1725: 6 dB, FR-1760DS: 4dB

3. RADAR DISPLAY

- (1) Picture tube 17" color CRT, Effective display diameter: 225 mm
 Yellow or green echoes in 16 levels
 (2) Scanning Raster scan at scanning frequency 48.3 kHz horizontal, 60 Hz vertical.
 Number of scanning lines 768, non-interlaced.

(3) Range scales and ring intervals

Range(nm)	0.125	0.25	0.5	0.75	1.5	3	6	12	24	48	72	96	120
Ring interval(nm)	0.025	0.05	0.1	0.25	0.25	0.5	1	2	4	8	12	16	20
No. of Rings	5	5	5	3	6	6	6	6	6	6	6	6	6

Maximum Range: FR-1710: 72 nm, FR-1725: 96 nm, FR-1760DS: 120 nm

- (4) Range discrimination 34 m on 1.5 nm range
 (5) Bearing discrimination XN12AF: 2.03°, XN20AF: 1.46°, XN24AF: 1.18°
 SN4A: 2.83°, SN5A: 2.53°
 (6) Minimum range 28 m

Performance Monitor: To be installed in an exposed area

7. COATING COLOR

- (1) Display Unit Panel: N3.0, Chassis: 2.5GY5/1.5
- (2) Antenna Unit N9.5

8. COMPASS SAFE DISTANCE

- (1) Display unit Standard: 1.15 m Steering: 0.90 m
- (2) Antenna unit
 - FR-1710: Standard: 1.65 m Steering: 1.25 m
 - FR-1725: Standard: 2.15 m Steering: 1.60 m
 - FR-1760DS: Standard: 4.40 m Steering: 3.30 m
- (3) Antenna power supply unit Standard: 1.20 m Steering: 0.90 m