

# SAFETY INSTRUCTIONS



## **DANGER**

**Before turning on the radar/ARPA, make sure that there is not one near the antenna unit. Serious injury or even death may result if a rotating antenna strikes someone standing nearby.**



## **WARNING**

### **Radio frequency Radiation Hazard**

The radar antenna emits electromagnetic radio frequency (RF) energy which can be harmful, particularly to your eyes. Never look directly into the antenna aperture from a close distance while the radar is in operation or expose yourself to the transmitting antenna at a close distance.

 **WARNING**



Do not open the equipment.

Hazardous voltage which can cause electrical shock exists inside the equipment. Only qualified personnel should work inside the equipment.



Turn off the radar power switch before servicing the antenna unit. Post a warning sign near the switch indicating it should not be turned on while the antenna unit is being serviced.

Prevent the potential risk of being struck by the rotating antenna and exposure to RF radiation hazard.



Wear a safety belt and hard hat when working on the antenna unit.

Serious injury or death can result if someone falls from the radar antenna mast.

Do not disassemble or modify the equipment.

Fire, electrical shock or serious injury can result.

Turn off the power immediately if water leaks into the equipment or the equipment is emitting smoke or fire.

Continued use of the equipment can cause fire or electrical shock.

 **WARNING**

Do not place liquid-filled containers on the top of the equipment.

Fire or electrical shock can result if a liquid spills into the equipment.

Do not operate the equipment with wet hands.

Electrical shock can result.

Keep heater away from equipment.

Heat can alter equipment shape and melt the power cord, which can cause fire or electrical shock.

 **CAUTION**

Do not use the equipment for other than its intended purpose.

Use of the equipment as a stepping stool, for example, can result in personal injury or equipment damage.

Replace the monitor when the picture becomes difficult to see.

The average life of the monitor is about 10 years. Replace it when the picture becomes difficult to see, to protect vision.

A warning label is attached to the equipment. Do not remove the label. If the label becomes soiled or illegible, contact a FURUNO agent or dealer.

No one navigation device should ever be solely relied upon for the navigation of a vessel.

Always confirm position against all available aids to navigation, for safety of vessel and crew.

# TABLE OF CONTENTS

<b>INTRODUCTION</b> .....	<b>I</b>
A WORD TO THE OWNER OF FURUNO RADAR .....	I
SPECIFICATIONS OF FR-2105 SERIES RADAR AND ARPA .....	A
<b>CHAPTER 1 OPERATION</b> .....	<b>1.1</b>
1.1 TURNING ON THE POWER .....	1
1.2 TRANSMITTER ON .....	1
1.3 CONTROL HEAD .....	3
1.4 CRT BRILLIANCE .....	5
1.5 TUNING THE RECEIVER .....	5
1.6 ON-SCREEN LEGENDS AND MARKERS .....	7
1.7 DEGAUSSING THE CRT SCREEN .....	9
1.8 INITIALIZING THE GYRO READOUT .....	9
1.9 PRESENTATION MODES .....	9
1.10 SELECTING THE RANGE SCALE .....	13
1.11 SELECTING THE PULSELENGTH .....	13
1.12 ADJUSTING THE SENSITIVITY .....	15
1.13 SUPPRESSING SEA CLUTTER .....	15
1.14 SUPPRESSING PRECIPITATION CLUTTER .....	17
1.15 INTERFERENCE REJECTOR .....	17
1.16 MEASURING THE RANGE .....	18
1.17 MEASURING THE BEARING .....	19
1.18 COLLISION ASSESSMENT BY OFFSET EBL .....	20
1.19 MEASURING RANGE AND BEARING BETWEEN TWO TARGETS .....	21
1.21 OFF-CENTERING .....	23
1.22 ECHO STRETCH .....	24
1.23 ECHO AVERAGING .....	25
1.24 ELECTRONIC PLOTTING AID (EPA) .....	27
1.25 ENTERING OWN SHIP'S SPEED .....	31
1.26 TARGET TRAILS (ECHO TRAILS) .....	32
1.27 PARALLEL INDEX LINES .....	34
1.28 ORIGIN MARK .....	36
1.29 ZOOM .....	37
1.30 MARKERS .....	38
1.31 MENU KEYS .....	38
1.32 RADAR 1, 2 AND 3 MENU SETTINGS .....	39
1.33 FUNCTION KEYS .....	41
1.34 BARGE INFORMATION .....	47
1.35 RADAR MAP .....	47
1.36 SUPPRESSING SECOND-TRACE ECHOES .....	52

1.37 ADJUSTING BRILLIANCE OF SCREEN DATA .....	52
1.38 DISPLAY OF ANCILLARY INFORMATION .....	54
1.39 ALARMS.....	55
<b>CHAPTER 2 OPERATION OF ARPA (OPTION) .....</b>	<b>2.1</b>
<b>2.1 GENERAL.....</b>	<b>1</b>
2.2 KEYPADS FOR ARPA.....	2
2.3 ARPA MENU OPERATION.....	2
2.4 START-UP PROCEDURE.....	3
2.5 AUTOMATIC ACQUISITION .....	6
2.6 MANUAL ACQUISITION .....	8
2.7 CHANGING PLOT SYMBOL SIZE .....	9
2.8 ADJUSTING BRILLIANCE OF PLOT MARKS .....	12
2.9 DISPLAYING TARGET DATA.....	12
2.10 VECTOR MODES .....	13
2.11 PAST POSITION DISPLAY .....	14
2.12 SET AND DRIFT (SET AND RATE) .....	15
2.13 SETTING CPA/TCPA ALARM RANGES.....	16
2.14 SETTING A GUARD ZONE.....	17
2.15 OPERATIONAL WARNINGS .....	18
2.16 TRIAL MANEUVER .....	19
2.17 ARPA PERFORMANCE TEST .....	22
2.18 CRITERIA FOR SELECTING TARGETS FOR TRACKING.....	22
2.19 FACTORS AFFECTING ARPA FUNCTIONS .....	24
<b>CHAPTER 3 RADAR OBSERVATION .....</b>	<b>3.1</b>
3.1 GENERAL .....	1
3.2 FALSE ECHOES .....	2
3.3 SART (SEARCH AND RESCUE TRANSPONDER).....	3
THIS INFORMATION IS EXCERPTED FROM IMO SN/CIRC 197 OPERATION OF MARINE RADAR FOR SART DETECTION. ....	5
<b>4 OPERATION OF VIDEO PLOTTER.....</b>	<b>4.1</b>
4.1 GENERAL .....	1
4.2 THE VIDEO PLOTTER DISPLAY .....	1
4.3 DISPLAY MODES .....	2
4.4 SET-UP OF VIDEO PLOTTER DISPLAY .....	3
4.5 TRACK.....	5
4.6 MARKS, LINES.....	7
4.7 WAYPOINTS .....	9
4.8 NAVIGATION LINES.....	11
4.9 RECORDING & REPLAYING DATA.....	13
4.10 INITIAL SETTINGS .....	14
4.11 LATITUDE ERROR TABLE (ON 96 NM RANGE SCALE) .....	16

<b>CHAPTER 5 MAINTENANCE</b> .....	<b>5.1</b>
5.1 PERIODIC MAINTENANCE SCHEDULE.....	1
5.2 LIFE EXPECTANCY OF MAJOR PARTS .....	2
5.3 REPLACEMENT OF BATTERY .....	2
<b>CHAPTER 6 TROUBLESHOOTING</b> .....	<b>6.1</b>
6.1 EASY TROUBLESHOOTING .....	1
6.2 ADVANCED-LEVEL TROUBLESHOOTING.....	1
6.3 DIAGNOSTIC TEST.....	4
<b>CHAPTER 7 MENU OVERVIEW</b> .....	<b>7.1</b>
<b>APPENDIX</b> .....	<b>8.1</b>
A.1 PERFORMANCE MONITOR (OPTION) .....	1
A.2 INTERSWITCHING UNIT .....	3
A.3 FOR FISHING VESSEL.....	4
A.3 NAVIGATION DATA (DIGITAL INTERFACE IEC 61162-1) .....	5
A.4 PARTS LIST AND MAJOR PARTS LOCATION.....	23

# INTRODUCTION

## A Word to the Owner of FURUNO Radar

Thank you for purchasing this FURUNO radar. We are confident you will discover why FURUNO has become synonymous with quality and reliability.

Dedicated in the design and manufacture of marine electronics equipment for half a century, FURUNO Electric Company has gained an unrivaled reputation as a world leader in the industry. This is the result of our technical excellence as well as our worldwide distribution and service network.

Please carefully read and follow the safety information and operating and maintenance instructions set forth in this manual before attempting to operate the equipment and conduct any maintenance. Your radar set will perform to the utmost of its ability only if it is operated and maintained in accordance with the correct procedures.

### FEATURES OF THIS SERIES OF RADARS AND ARPAs

- Daylight-bright rasterscan 21-inch multi-color, high-resolution display
- New microprocessing technology with high-speed high-density gate array and software expertise
- New cast aluminum scanner gearbox and new series of radiators
- Easy operation by combination of discrete keys, rotary controls, and menu operation, all logically arranged and configured
- Electronic Plotting Aid (EPA) fitted standard, Automatic Radar Plotting Aid (ARPA) option exceeding IMO and IEC standards . The ARPA self-contains another radar plotting function - Automatic Tracking Aid (ATA).
- Reliable CPA and TCPA warning in any plotting mode, accurate target data.
- Stand-alone or integrated configuration
- Meets the current and future IMO (\*) and IEC standards as a shipborne radar, high speed craft radar, and ARPA. (\*) New radar standard MSC.64(67) Annex 4 must be met for new installation on and after January 1, 1999

## FR-2105 Series of Radars and ARPAs

The FURUNO FR-2105 Series of radars and ARPAs are designed to meet various customers' needs and the exacting requirements of international and national standards and regulations including:

- IMO A.477(XII): Performance Standards for Radar Equipment (up to 31.12.1998)
- IMO MSC.64(67) Annex 4: Performance Standards for Radar Equipment (1.1.1999 and after)
- IEC 60936-1: Shipborne Radar Operational and Performance Requirement (1.1.1999 and after)
- IMO A.823(19): Performance standards for Automatic Radar Plotting Aids (ARPAs) (1.1.1997 and after)
- IEC 60872-1: Automatic Radar Plotting Aids (ARPAs) (1.1.1997 and after)
- IEC 60945: 1996-11(3rd Ed) Marine Navigational Equipment General Requirements
- IMO A.820(19): Performance standards for navigational radar equipment for high speed craft (1.1.1996 and after)
- IEC 60936-2: Performance standards for navigational radar equipment for high speed craft

## Models

This series of radar and ARPA is available in the following models:

Model	Freq Band	Output	Transceiver configuration
FR-2115	X-band	12 kW	TR-up
FR-2125	X-band	25 kW	TR-up
FR-2125W	X-band	25 kW	TR-down
FR-2155	X-band	50 kW	TR-up
FR-2135S	S-band	30 kW	TR-up
FR-2135SW	S-band	30 kW	TR-down
FR-2165DS	S-band	60 kW	TR-up

All comes with the EPA (Electronic Plotting Aid) standard fitted. An option is available to provide the full functionality of ARPA (Automatic Radar Plotting Aid). Also with an optional Video Plotter (Chart Plotter).

Besides the choice of the above models, the FR-2105 Series is available in the **Regular type** (R-type) and **IMO type**. The IMO type is designed as a primary radar under the 1974 SOLAS Convention on ships below 10,000 GT and as a second radar on ships of 10,000 GT and upwards, and also as a high speed craft radar when fitted with ARPA function (at least ATA by IEC 60936-2). The R-type satisfies the IMO and IEC standards but includes more flexibility of functionality to meet the fishing boats particularly (thus, this is an expanded type in other word).

The table below shows the differences between R-type and IMO type radars. Other functions and specifications are common. The operator cannot navigate between these two types. The type is factory set with respect to the requirements by the type testing authorities.

Function	IMO type	Regular type (R-type)
Range scales	0.125, 0.25, 0.5, 0.75, 1.5, 3, 6, 12, 24, 48, 96 nm	FR-2115: 0.125, 0.25, 0.5, 0.75, 1.5, 3, 6, 12, 24, 48, 72 nm Other models: 0.125, 0.25, 0.5, 0.75, 1.5, 3, 6, 12, 24, 48, 120 nm
Alarm zones	Radar: Target Alarm Zone: 1st TAZ between 3 and 6 nm, 2nd TAZ anywhere provided the 1st TAZ is valid. ARPA: Guard Zones: 1st GZ - between 3 and 6 nm, in 0.5 nm range depth 2nd GZ - Anywhere in 0.5 nm range depth, but needs 1st GZ operative	Radar: Target Alarm Zone: 1st and 2nd TAZs anywhere. Alarm can be selected for inside (as TAZ) or outside (as off-zone watch) mode. ARPA: Guard Zones: 1st GZ - Anywhere in 0.5 nm depth 2nd GZ - Anywhere in 0.5 nm depth
x2 Zoom	Not available	Available on menu
Echo colors	Monochrome yellow or green in 16 tones	Choice of monochrome in 16 tones or 3 colors depending on echo strengths



# Specifications of FR-2105 Series Radar and ARPA

## ANTENNA RADIATOR

- Type: Slotted waveguide array
- Beamwidth: X-band S-band  
 Radiator type: XN12AF XN20AF XN24AF SN7AF SN5AF  
 Length: 4 ft 6.5 ft 8 ft 12 ft 9 ft  
 Beamwidth (H): 1.8° 1.23° 0.95° 1.9° 2.3°  
 Beamwidth (V): 20° 20° 20° 20° 20°  
 Sidelobes  $\pm 10^\circ$ : -28 dB all radiators  
 Polarization: Horizontal (all radiators)  
 (9 ft radiator not for SOLAS ships)
- Rotation: 24 rpm (X/S-band), 42 rpm (X-band)

## RF TRANSCEIVER

- Frequency: X-band 9410 MHz  $\pm$  30 MHz (12, 25 kW)  
 9415 MHz  $\pm$  30 MHz (50 kW)  
 S-band 3050 MHz  $\pm$  30 MHz
- Output power: FR-2115: 12 kW, FR-2125/W: 25 kW, FR-2155/W: 50 kW  
 FR-2165DS: 60 kW, FR-2135S/SW: 35 kW
- Pulselengths and PRR

<RF aloft>

Range scales	P/L ( $\mu$ s)	PRR (Hz)
0.125, 0.25	0.07	3000
0.5	0.07/0.15	3000
0.75, 1.5	2 from 0.07/0.15/0.3	3000/1500
3	2 from 0.15/0.3/0.5/0.7	3000/1500
6	2 from 0.3/0.5/0.7/1.2	1500/1000
12, 24	2 from 0.5/0.7/1.2	1000/600
48, 96	1.2	600

<RF down>

Range scales	P/L ( $\mu$ s)	PRR (Hz)
0.125, 0.25, 0.5	0.08	2200
0.75, 1.5	0.08/0.3	2200/1100
3	2 from 0.08/0.3/0.6	2200/1100
6	2 from 0.08/0.3/0.6	2200/1100
12, 24	0.6/1.2	1100/600
48, 96	1.2	600

- IF: 60 MHz, Logarithmic. BW 28/3 MHz
- Noise figure: 6 dB
- Duplexer: Ferrite circulator with diode limiter for FR-2115/2125/2135AS/2135S/2165DA. Ferrite circulator with TR limiter for FR-2125/2155

## DISPLAY

- Picture tube: 21" multi-color, 1280 x 1024 pixels, Rasterscan non-interlace at 61.44 kHz hor, 60 Hz vert.  
 Effective display diameter 275 mm
- IMO type: Yellow or green echoes in 16 levels. Echoes in the same color in 16 graduation for smooth display. Different colors for marks, legends,

- Regular type: Yellow or green echoes in 16 levels or 3 colors depending on echo strengths
- Minimum range and discrimination: Meets 35 m HSC requirements
- Range scales: 0.125, 0.25, 0.5, 0.75, 1.5, 3, 6, 12, 24, 48, 96 nm
- Range accuracy: 1% of range or 15 m, whichever is the greater
- Bearing discrimination: Better than 2.5° except 9 ft S-band radiator. Accuracy  $\pm 1^\circ$
- Presentation: Head-up, Head-up TB, North-up, TM Sea or ground stabilization
- Plotting facilities: EPA 10 targets in different symbols (standard)  
 ARPA Automatic Radar Plotting Aid for 40 targets automatically or manually acquired, dynamic and static trial maneuver, complies with A.823(19).  
 Common features: Sea and ground stabilized vectors and target trails, 3 target data readout at a time
- Radar map: Nav lines, coastlines, buoys, etc. produced by operator as required by IMO and IEC standards. 150 points x 10 areas stored in EEROM.
- Guard zone: 2 GZs at 3 and 6 nm in width of 0.5 nm, any sector, in ARPA mode.
- Target alarm zone: 1st zone within 3-6 nm, 2nd zone anywhere
- Target trails: Plotted in light blue not to interfere with radar picture, intervals 15,30 s, 1, 3, 6, 15, 30 min, true or relative on RM mode; true only in TM mode.
- Parallel index line: Choice of 2, 3 or 6 lines $\beta$

## INTERFACE

- IEC 61162-1: OSD, RSD, TTM, etc.  
 Analog: RGB video, H/V sync for VDR with optional interface board  
 Gyrocompass: Built-in interface for sync signal 20-50 V, 50-400 Hz, or stepper 20-50 V  
 Speed log: IEC 61162-1, contact closure or 200/400/500 pulses/nm

## EQUIPMENT LIST

### Standard

- Display nit
- Antenna unit
- Transceiver unit for TR down version
- Power supply unit for FR-2125/2155/2135S/2135S/2165DS

### Option

- Waveguide for TR down version
- Gyro interface GC-8 (built-in type)
- Interswitch box RJ-7, RJ-8
- Performance monitor PM-30 (X), PM-50 (S)
- 42 rpm scanner motor

6 ARPA board ARP-26  
 7 Video plotter board RP-26  
 8 ROM card (for digital charts), RAM card (for custom data) for RP-26, expanded radar map  
 9 Sub display FMD-8001 (R-type)

FR-2115: 24 V, 9.6 A; 32 V, 7.2 A; 230 VAC, 2.4 A  
 FR-2125: 24 V, 10.8 A; 32 V, 8.2 A; 230 VAC, 2.7 A  
 FR-2135S: Display/Transceiver 230 VAC, 320 VA;  
 Antenna unit 230 V, 3ø, 200 VA

**POWER SUPPLY**

**X-Radiation**

None of the equipment or any device used in it will not give rise to dose rate > 5 µJ/kg h (0.5 mrem/h) at 50 mm.

**Electromagnetic radiofrequency radiation**

MODEL	RADIATOR TYPE	Distance to 100 W/cm <sup>2</sup>	Distance to 10 W/cm <sup>2</sup>	RF power density on antenna aperture
FR-2115 (X, 12 kW)	XN12AF (4')	0.1 m worst case	3.5 m	150 W/cm <sup>2</sup>
	XN20AF (6.5')			
	XN24AF (8')		1.4 m	
FR-2125 (X, 25 kW)	XN12AF (4')	1.1 m worst case	10.0 m worst case	200 W/cm <sup>2</sup> worst case
	XN20AF (6.5')			
	XN24AF (8')			
FR-2135S (S, 30 kW)	SN5AF (9')	-		
	SN7AF (12')			
FR-2165DS (S, 60 kW)	SN4AF (8')	-		
	SN5A (9')			
FR-2155 (X, 50 kW)	XN20AF (6.5')	-		
	XN24AF (8')			

**Category of Equipment Units**

Display unit	To be installed in a Protected area
Power supply unit	To be installed in a Protected area
RF Transceiver unit	To be installed in a Protected area
Antenna unit	To be installed in an Exposed area
Performance Monitor	To be installed in an Exposed area

# CONFIGURATION OF FR-2115 SERIES RADAR AND ARPA

Your RADAR or ARPA is model FR-21\_\_\_\_  
 consisting of checked component units. (Check by yourself or your service representative)

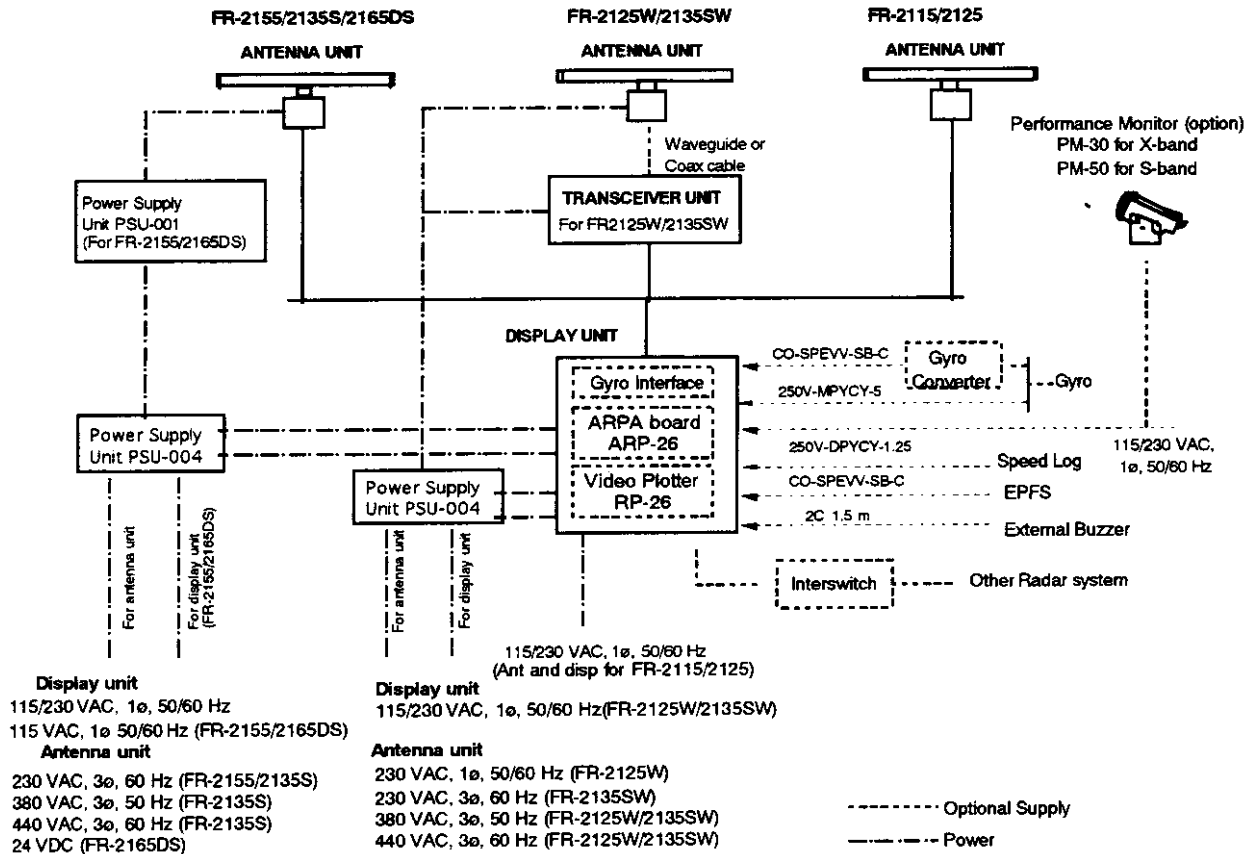

Please specify power supply when ordering.  
 Optional transformer is required for other mains



# Chapter 1 OPERATION

## DANGER



Before turning on the radar, make sure that there is no one near the antenna unit.

Serious injury or even death may result if a rotating antenna strikes someone standing nearby.

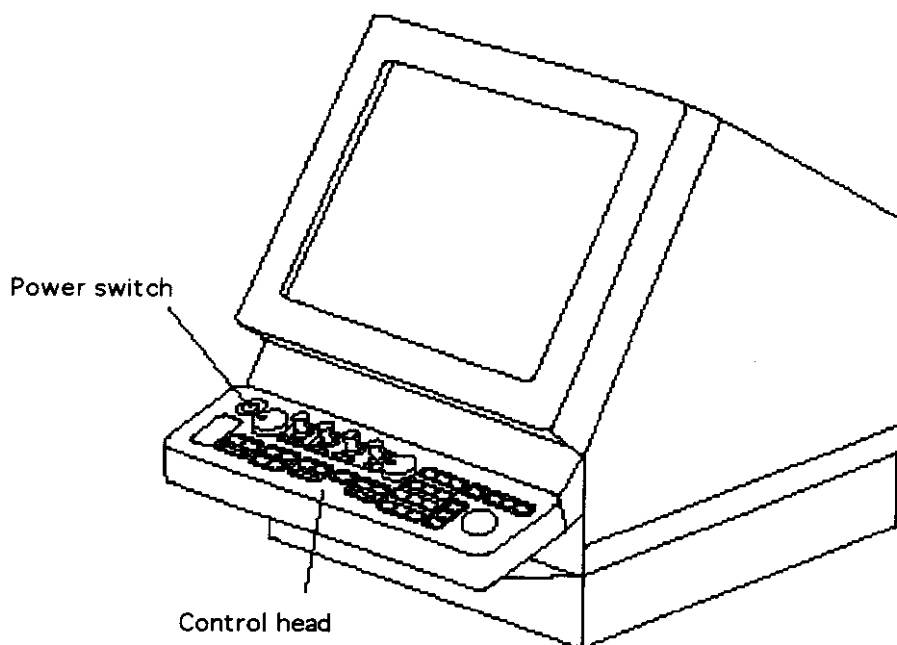

## 1.1 Turning on the Power

The POWER switch is located at the left corner of the control head. Push it to switch on the radar system. To turn off the radar, push it again. The screen shows the bearing scale and digital timer in approximately 15 seconds after power-on. The timer counts down three minutes of warm-up time. During this period the magnetron, i.e., transmitter tube, is warmed for transmission. When the timer has reached 0:00, the indication STBY appears indicating that the radar is now ready to transmit pulses.

In warm-up and standby condition, you will see the message BRG SIG MISSING. This is normal because a bearing (azimuth) signal is not yet generated when the antenna is not rotating. ON TIME and TX TIME values shown at the bottom of the screen are the time counts in hours and tenths of hour when the radar has been powered.

## 1.2 Transmitter ON

When the STANDBY status is displayed on the screen, press the transmit switch labeled STBY/TX on the control panel of the display unit.

The radar is initially set to previously used range and pulsewidth. Other settings such as brilliance

levels, VRMs, EBLs and menu option selections are also set to previous settings.

The transmit switch toggles the radar between STANDBY and TRANSMIT status. The antenna stops in STANDBY status and rotates in TRANSMIT status.

### **Quick Start**

Provided that the radar was once in use with the transmitter tube (magnetron) still warm, you can turn the radar into TRANSMIT condition without 3-minutes standby. If the Power Switch has been turned off by mistake or the like and you wish to restart the radar promptly, turn on the Power Switch not later than 10 seconds after power-off.

### **Notes:**

- 1) If the antenna does not rotate in TRANSMIT status, check whether the antenna switch in the tuning compartment is in the OFF position.
- 2) The magnetron ages with time resulting in a reduction of output power. It is highly recommended that the radar be set to STANDBY status when not used for an extended period of time.

# 1.3 Control head

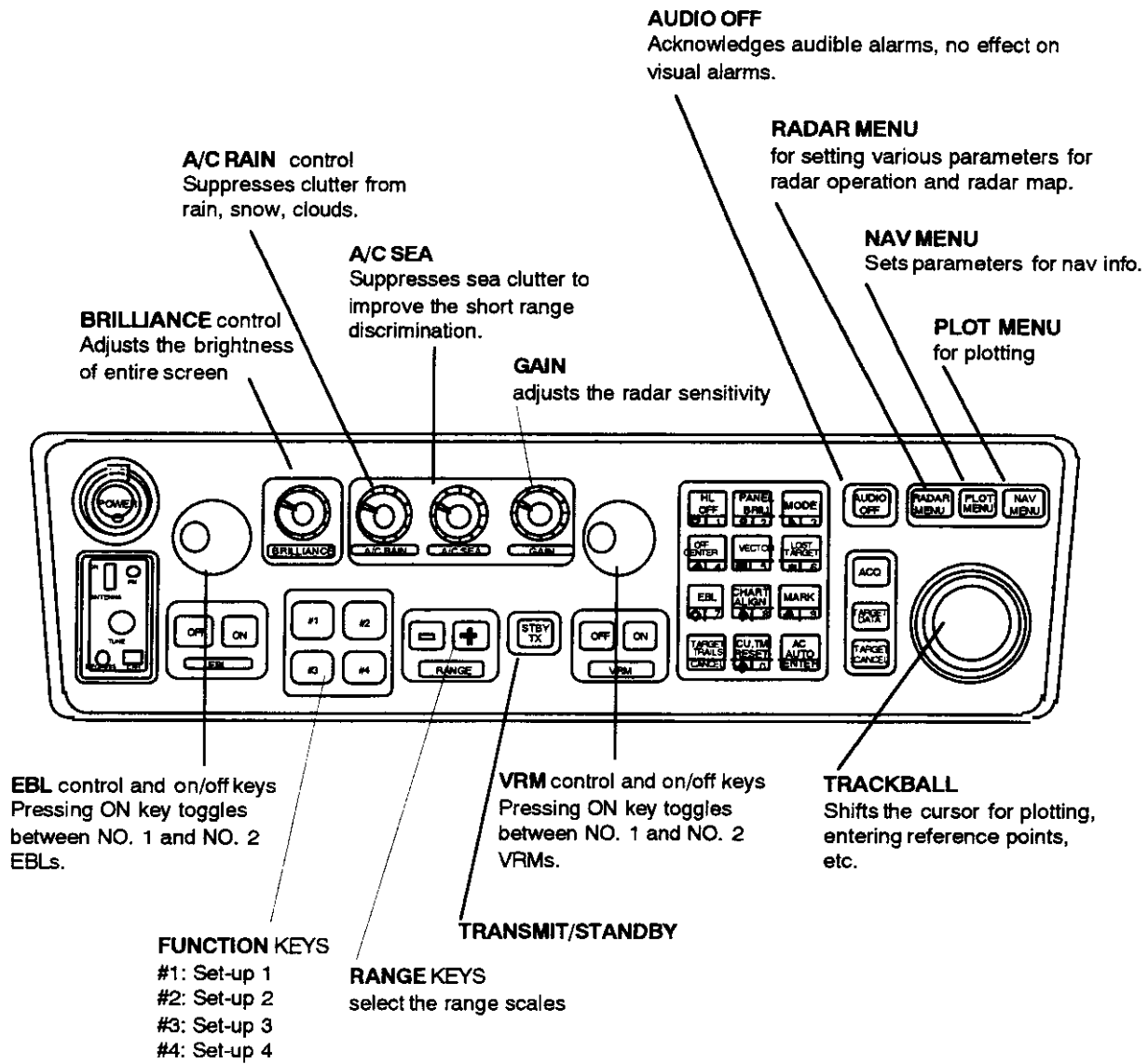

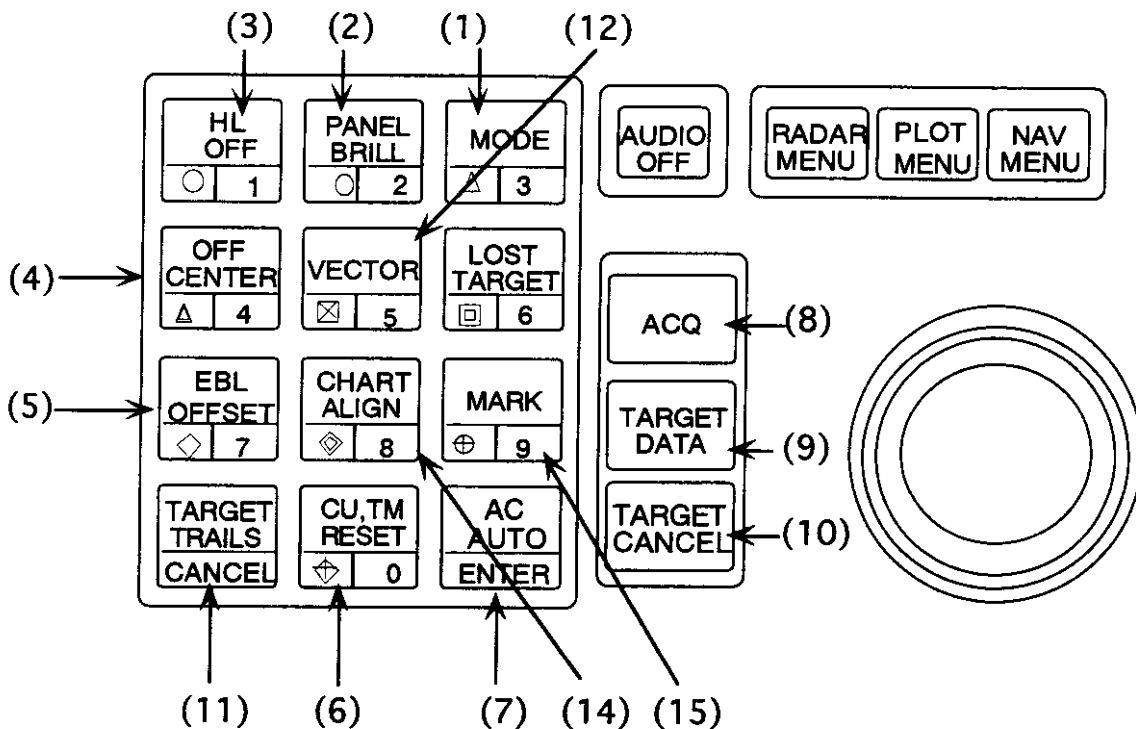

- 1 **MODE** Selects presentation modes: Head-up, Head-up TB, North-up, Course-up and True Motion.
- 2 **PANEL BRILL** Adjusts brightness of panel.
- 3 **HL OFF** Temporarily erases the heading line.
- 4 **OFF-CENTER** Activates and deactivates off-centering of the own ship position.
- 5 **EBL OFFSET** Activates and deactivates off-centering of the EBL origin.
- 6 **C U, TM RESET** Resets the heading line to 000° in course-up mode; moves own ship position to 75% radius in stern direction in the True Motion mode.
- 7 **A/C AUTO** Reduces sea clutter at preset level. Permits manual override by A/C SEA and A/C RAIN controls.
- 11 **TARGET TRAILS CANCEL** Erases target trails.

### Keys for EPA or ARPA (optional)

- 8 **ACQ key** Acquires a target after selecting it by trackball.
- 9 **TARGET DATA** Displays the acquired target data for 2 or 3 targets at a time.
- 10 **TARGET CANCEL** Terminates plotting of a specified target or all tracked targets.
- 12 **VECTOR** Select vector mode; true or relative.
- 13 **LOST TARGET** Silences the lost target audible alarm and erases the lost target symbol.
- 14 **CHART ALIGN** Aligns chart with the radar display.
- 15 **MARK** Enters/erases mark.
- 16 **Keys 0-9** Select video plotting symbols. Also used for entering numeric data in any mode as applicable.
- 17 **ENTER** Used to save settings on menu screen.



## 1.4 CRT Brilliance

BRILLIANCE control on the control head of the display unit adjusts the entire screen brightness. Note that the optimum point of adjustment varies with ambient light conditions, especially between daytime and nighttime.

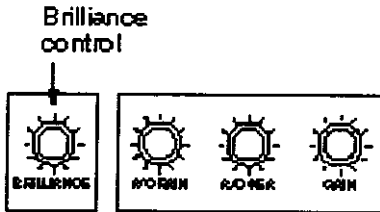

**Note:** The CRT brilliance should be adjusted before adjusting relative brilliance levels on the BRILLIANCE menu to be explained later.

## 1.5 Tuning the Receiver

Tuning method can be selected at RADAR 3 menu; auto or manual.

1. Press the RADAR MENU key.
2. Press the [0], [0], [2], [0] and [0] in sequence to reach the RADAR 3 menu item.
3. Press the [9] twice to change between Auto and Manual.
4. Press the ENTER key to confirm your selection.
5. Press the RADAR MENU key to close the menu.

### Automatic tuning

The radar receiver is tuned automatically each time the power is turned on; thus, there is no front panel control. The tuning indicator and the label AUTO TUNE at the top right corner of the display unit show the tuning circuit is working.

### Manual tuning

If you are not satisfied with the current tune setting, follow these steps to fine-tune the receiver:

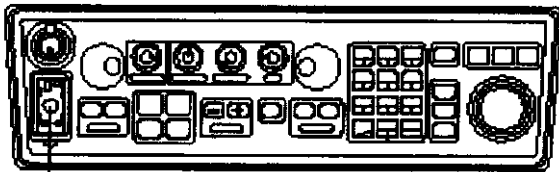

TUNE control

1. Set the tuning method to manual as described before.
2. While observing the picture on the 48 mile scale, slowly adjust TUNE control in the tune compartment and find the best tuning point.
3. Make sure that the radar has been set to the best tuning point. This condition is where the tuning indicator lights to about 80% of its total length. Note the tuning indicator will never extend to full length.



## **Video Freeze-up Recovery**

Video freeze-up or lock-up can occur unexpectedly on any digital rasterscan radars. This is mainly caused by heavy spike noise in the power line and can be noticed by carefully watching the nearly visible sweep line. If you suspect that the picture is not updated every scan of the antenna or no key entry is accepted notwithstanding the apparently normal pictures, do Quick Start to restore normal operation.

- .1 Turn off the Power Switch and within 10 s turn it on again.
- .2 Press the Transmit switch labeled STBY/TX for transmit condition.

**NOTE:** This equipment has self-diagnostic function to check operational software periodically. If any trouble has been found, the ERROR lamp lights. In this case, do the above procedure.

# 1.6 On-screen Legends and Markers

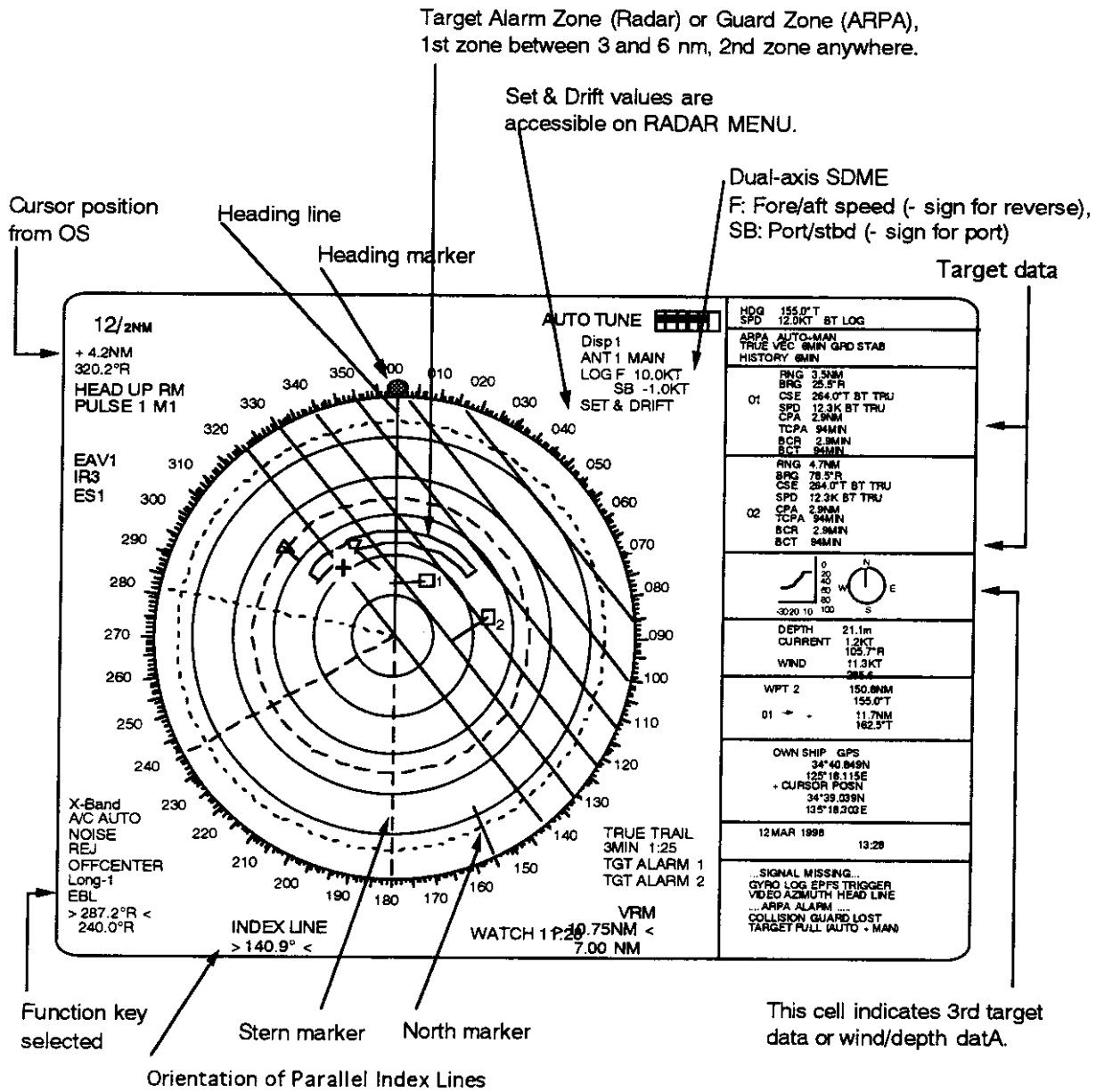

# DATA DISPLAY

HDG 155.0° T  
SPEED 12.0KT BT LOG

ARPA AUTO+MAN  
TRUE VEC 6MIN GRD STAB  
HISTORY 6MIN

01  
RNG 4.7NM  
BRG 25.5°T  
CSE 264.0°T BT TRU  
SPD 12.3K BT TRU  
CPA 3.4NM  
TCPA 94MIN  
BCR 2.9 MIN  
BCT 94MIN

02  
RNG 2.0NM  
BRG 180.0°T  
CSE 200.0°T BT TRU  
SPD 10.5K BT TRU  
CPA 1.3NM  
TCPA 15.1min  
BCR 3.0MIN  
BCT 25MIN

03  
RNG 2.0NM  
BRG 180.0°T  
CSE 200.0°T BT TRU  
SPD 10.5K BT TRU  
CPA 1.3NM  
TCPA 15.1min  
BCR 3.0MIN  
BCT 25MIN

DEPTH 21.1m

CURRENT 2.2KT  
105.7°R  
WIND 11.3KT  
285.6°R

WPT 2 150.8NM  
155.0°T  
01 → + 11.7NM  
162.5°T

OWN SHIP [GP]  
34°40.849N  
125°18.115E  
+ CURSOR POSN  
34°39.039N  
135°18.303E

12 MAR 1998 13:28 LOCAL

... SIGNAL MISSING...  
GYRO LOG EPFS TRIGGER  
VIDEO AZIMUTH HEAD LINE  
.... ARPA ALARM .....

HDG: Heading T (True = corrected gyro or magnetic heading)

Speed data is LOG, MAN etc. showing sensor and types.

When set/drift is manually applied, BT appears instead of WT.  
(WT: Water tracking mode, BT: Bottom Tracking mode)

SEA STAB: Sea stabilization, displayed objects subject to water, current.

GND STAB: Ground stabilization, compensated for the current; stationary objects appear stationary on the display.

Target NO. 01 - 40 in ARPA, 01 - 10 in EPA, automatically assigned. The numbers are left occupied if targets are lost or intentionally removed until the full numbers are used up.

Interpreting Course Ex. 180.0°T BT TRU

T: True, referenced to True North

BT: Bottom tracking (referenced on the bottom)

TRU: Vector orientation

Numerals on division lines Ex. 1:23: Elapsed time since last plot (EPA only)

This third target data area may be used to indicate the graphics of wind and depth data if the third target data is not interested.

This display cell shows digital readouts of water depth, ocean currents, wind if associated sensors are in use.

Bearing and range from origin mark to cursor.  
Bearing and range to waypoint

Electronic Position-Fixing System, such as GPS, DGPS, DECCA, LORAN C. Status (Healthy or invalid) will be indicated.

Date and time. Not displayed in case of a failure of EPFS.

Warning and indications

## 1.7 Degaussing the CRT Screen

Each time the radar is turned on, the degaussing circuit automatically demagnetizes the CRT screen to eliminate color contamination caused by earth's magnetism or magnetized ship structure.

The screen is also degaussed automatically at certain time intervals. While being degaussed, the screen may be disturbed momentarily with vertical lines. If you wish to degauss by manual operation, open the tuning compartment and press the Degauss switch.

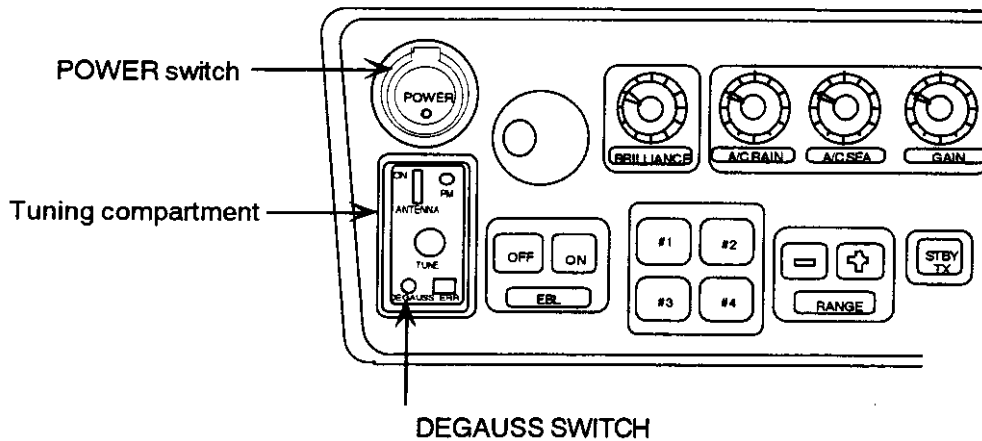

## 1.8 Initializing the Gyro Readout

With a gyrocompass interfaced with the radar, ship's heading is displayed at the top of the screen. Upon turning on the radar, align the on-screen GYRO readout with the gyrocompass reading by the procedure shown below. Once you have set the initial heading correctly, resetting is not usually required. However, if the GYRO readout goes wrong for some reason, repeat the procedure to correct it.

1. Press the RADAR MENU key to display the FUNCTIONS 1 menu.
2. Press the [0] key twice to display the FUNCTIONS 3 menu.
3. Press the [9] key to select GYRO SETTING option.
4. Rotate the EBL control to adjust the gyrocompass reading.
5. Press the ENTER key to confirm the setting.

## 1.9 Presentation Modes

This radar has the following presentation modes:

### Relative Motion (RM)

- Head-up: Unstabilised
- Head-up TB: Head-up with compass-stabilized bearing scale (True Bearing) where the bearing scale rotates with the compass reading.
- Course-up: Compass-stabilized relative to ship's intended course
- North-up: Compass-stabilized with reference to north

### True Motion (TM)

- North-up: Ground or sea stabilized with compass and speed inputs

## Selecting presentation mode

Press the MODE key on the control head. Each time the MODE key is pressed, the presentation mode and mode indication at the upper-left corner of the screen change cyclically.

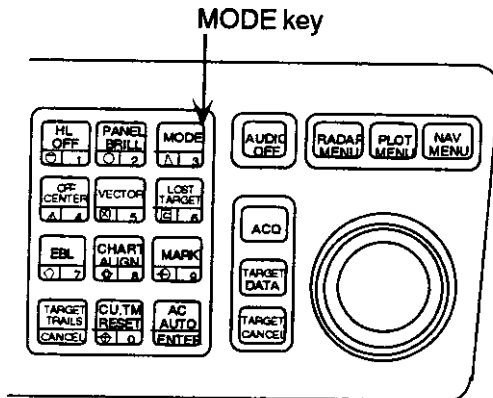

### Loss of Gyrocompass signal

When the compass signal is lost, the presentation mode automatically becomes head-up and the HDG (heading) readout at the top of the text area shows asterisks \*\*\*. Also GYRO appears in red characters at the lower right corner on the screen. When the gyrocompass signal is restored, the SET HDG appears at the upper-right corner on the screen. Press the MODE key, and the asterisks and GYRO go off. Align the HDG readout with the gyrocompass reading, referring to the previous section 1.8. Finally press the CANCEL key to erase the message SET HDG.

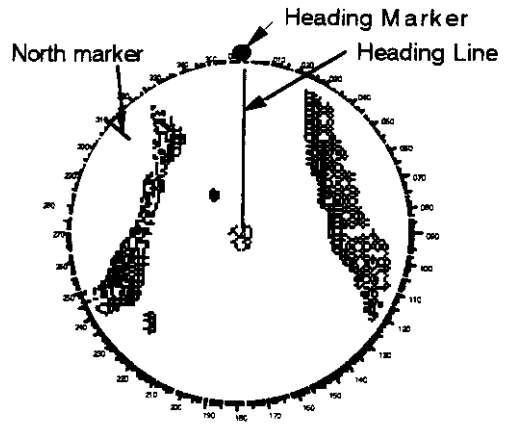
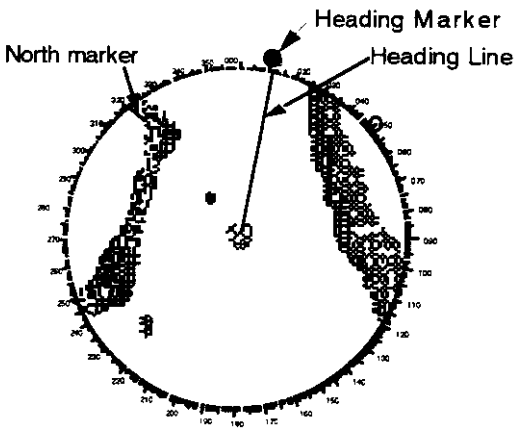
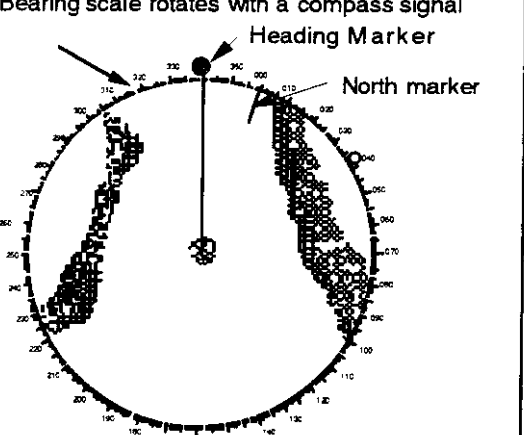
Presentation mode, representative display	Description
 <p>The diagram shows a circular radar display with a bearing scale from 0 to 360 degrees. A vertical line, labeled 'Heading Line', points from the center to the top of the scale (0 degrees). A 'Heading Marker' is positioned at the top of the scale. A 'North marker' is also indicated on the scale. Radar returns are shown as two vertical, textured bands on either side of the center.</p>	<p><b>Head-up mode</b></p> <p>A display without azimuth stabilization in which the line connecting the center with the top of the display indicates own ship's heading.</p> <p>The target pips are painted at their measured distances and in their directions relative to own ship's heading.</p> <p>A shore line on the bearing scale is the north marker indicating compass north. A failure of the compass input will cause the north marker to disappear and the readout to show asterisks (***) and the message SET GYRO appears in red at the lower-right corner of the screen.</p>
 <p>The diagram shows a circular radar display similar to the head-up mode. The 'Heading Line' is tilted clockwise from the vertical, indicating the ship's intended course. The 'Heading Marker' is at the top of the scale. The 'North marker' is also present. Radar returns are shown as two vertical, textured bands.</p>	<p><b>Course-up mode</b></p> <p>An azimuth stabilized display in which a line connecting the center with the top of the display indicates own ship's intended course (namely, own ship's previous heading just before this mode has been selected).</p> <p>Target pips are painted at their measured distances and in their directions relative to the intended course which is maintained at the 0-degree position while the heading line moves in accordance with ship's yawing and course change. This mode is useful to avoid smearing of picture during course change. After a course change, press the [CU, TM RESET] key to reset the picture orientation if you wish to continue using the course-up mode. The heading line gets back to scale zero.</p>
 <p>The diagram shows a circular radar display where the bearing scale is rotated counter-clockwise from the vertical. The 'Heading Marker' is at the top of the scale. A 'North marker' is also indicated. Radar returns are shown as two vertical, textured bands.</p>	<p><b>Head-up TB (True Bearing) mode</b></p> <p>Radar echoes are shown in the same way as in the head-up mode. The difference from normal head-up presentation lies in the orientation of the bearing scale. The bearing scale is compass stabilized. That is, it rotates in accordance with the compass signal, enabling you to know own ship's heading at a glance.</p> <p>This mode is available only when the radar is interfaced with a gyrocompass.</p> <p>If the compass fails, the bearing scale returns to the state of head-up mode.</p>

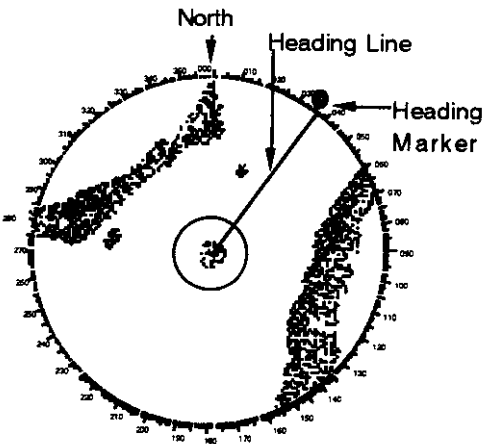
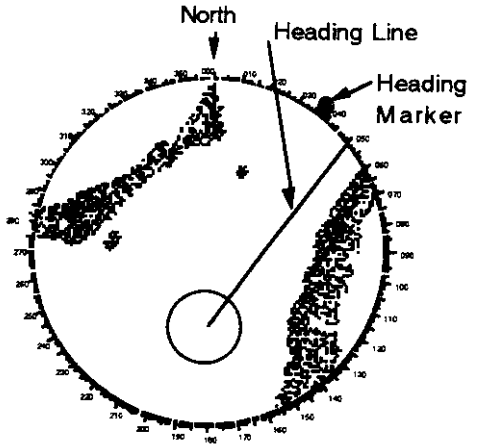
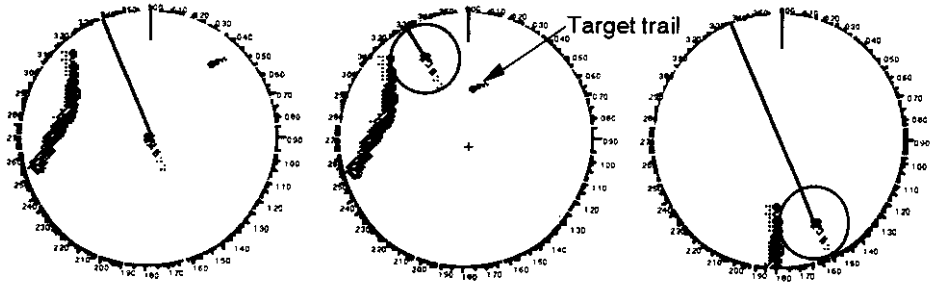
Presentation mode, representative display	Description
 <p>A circular radar display in north-up mode. The display is oriented with North at the top. A heading line is drawn from the center (own ship) towards the top-right. A heading marker is shown as a small circle on the heading line. The display shows a coastline on the left and a landmass on the right. A scale of 0 to 240 is visible around the perimeter.</p>	<p><b>North-up mode</b></p> <p>In the north-up mode, target pips are painted at their measured distances and in their true (compass) directions from own ship, north bearing maintained up of the screen. The heading line changes its direction according to the ship's heading.</p> <p>If the gyrocompass fails, the presentation mode changes to head-up and the north marker disappears. Also, the HDG readout shows asterisks (***) And the message GYRO appears in red at the lower-right corner of the screen.</p>
 <p>A circular radar display in true motion mode. The display is oriented with North at the top. A heading line is drawn from the center (own ship) towards the top-right. A heading marker is shown as a small circle on the heading line. The display shows a coastline on the left and a landmass on the right. A scale of 0 to 240 is visible around the perimeter.</p>	<p><b>True motion mode</b></p> <p>Own ship and other moving objects move in accordance with their true courses and speed. In ground stabilized TM, all fixed targets, such as landmasses, appear as stationary echoes. In the sea stabilized TM without set and drift inputs, the landmass can move on the screen.</p> <p>When own ship reaches a point corresponding to 75% of the radius of the display, it is automatically reset to a point of 75% radius opposite to the extension of the heading marker passing through the display center. Resetting can be made at any moment before the ship reaches the limit by pressing the [CU, TM reset]. Automatic resetting is preceded by a beep sound.</p> <p>If the compass fails, the mode is changed to the head-up and the north marker disappears. The HDG readout shows asterisks (***) and the message GYRO appears in red at the lower-right corner of the screen.</p>
 <p>Three circular radar displays illustrating the automatic reset process in true motion mode. The first display (a) shows the ship's heading line and heading marker. The second display (b) shows the ship's heading line and heading marker moving towards the 75% radius limit. The third display (c) shows the ship's heading line and heading marker reset to the 75% radius limit opposite to the previous position. A 'Target trail' is visible in the second display.</p>	

(a) True motion is selected

(b) Own ship has reached a point 75% of display radius

(c) own ship is automatically reset to 75% of radius



## 1.10 Selecting the Range Scale

The display range scale is changed in 11 steps by pressing the [+] and [-] keys. The selected range scale and range ring interval are shown at the upper left corner on the screen.

0.125–0.25–0.5–0.75–1.5–3–6–12–24–48–96 nm

## 1.11 Selecting the Pulselength

The pulselength in use is displayed at the upper-left position of the screen using the abbreviations shown in the table below.

Appropriate pulselengths are preset to individual range scales and function keys. Therefore, you are not usually required to select them. If you are not satisfied with the current pulselength settings, however, it is possible to change them by the Radar menu operation shown below.

You can choose the pulselength 1 or 2 on the scales 0.5 to 24 nm ranges on FR-2115/2125 models (0.75 to 24 nm ranges on the other models).

### Selecting pulselength 1 or 2

1. Press the RADAR MENU key to display the FUNCTIONS 1 menu.
2. Press the [6] key to select PULSELENGTH 1 or 2 as appropriate.
3. Press the RADAR MENU key to close the FUNCTIONS menu.

LABEL	P/L in FR-2115, 2125	P/L in FR-2125W, 2135DS, 2155, 2165DS, 2135S
S (Short pulse)	-	0.08 $\mu$ s
S1 (Short pulse 1)	0.07 $\mu$ s	-
S2 (Short pulse 2)	0.15 $\mu$ s	-
M1 (Medium pulse 1)	0.3 $\mu$ s	0.3 $\mu$ s (0.2 $\mu$ s in FR-2155, 2165DS)
M2 (Medium pulse 2)	0.5 $\mu$ s	0.6 $\mu$ s
M3 (Medium pulse 3)	0.7 $\mu$ s	-
L (Long pulse)	1.2 $\mu$ s	1.2 $\mu$ s

### Presetting pulselengths 1 and 2

Pulselength 1 and 2 can be preset on the PULSE WD 1 and 2 menus. Shown below are examples of the pulselength setup procedure:

1. To enable selection of S1 (0.07  $\mu$ s) and S2 (0.15  $\mu$ s) pulselength on the 0.5 nm range on FR-2115/2125 model, select S1 at 0.5 nm on the PULSE WD 1 menu and S2 at 0.5 nm on the PULSELENGTH 2 menu.
2. To enable selection of S2 (0.15  $\mu$ s) and M1 (0.3  $\mu$ s) pulselength on the 3 nm range on FR-2115/2125 model, select S2 at 3 nm in the PULSE WD 1 menu and M1 at 3 nm in the PULSE WD 2 menu.

A longer pulse provides an increased detection range, but with reduced discrimination. If you need discrimination in preference to detection, choose a shorter pulse.

**Example:** To select S1 (0.07  $\mu$ s) as Pulselength 1 for the 0.5 nm range, display the PULSELENGTH 1 menu following the steps shown above and hit the [2] key to choose "0.5 NM." Further hit the [2] key until the menu option "S1" is highlighted to the right of "0.5 NM."

[RADAR MENU] key



- | [FUNCTIONS 1] |                               |
|---------------|-------------------------------|
| 1             | TARGET TRAILS                 |
| 2             | GUARD ALARM           1 or 2  |
| 3             | ORIGIN MARK           1 to 10 |
| 4             | INDEX LINES                   |
| 5             | ZOOM .....<R-TYPE ONLY>       |
| 6             | PULSE WIDTH                   |
| 7             | INT REJECT                    |
| 8             | ARPA                          |
| 9             | VIDEO PLOT                    |
| 0             | [FUNCTION 2]                  |

[0] key ↓

[1] key ↑

- | [FUNCTIONS 2] |  |
|---------------|--|
| 1             | [FUNCTIONS 1]  |
| 2             | BKGD COLOR           BLK(GRN CHAR)/<br>BLK(RED)/<br>BLU (ECHO AREA)<br>BLU/<br>BRT BLU |
| 3             | ECHO STRETCH       OFF/1/2/3   |
| 4             | ECHO AVERAGE     OFF/1/2/3   |
| 5             | ECHO COLOR        YEL/GRN  |
| 6             | SHIP SPEED        LOG/NAV/MAN  |
| 7             | SET, DRIFT        OFF/MAN<br>SET = xxx.x°<br>DRIFT = xx.xKT                            |
| 8             | INDEX LINES       NO. 2 VRM/MAN<br>MAN = XX.XX NM                                      |
| 9             | BRILLIANCE (1)   |
| 0             | [FUNCTION 3]   |

[0] key ↓ [1] key ↑

- | [FUNCTIONS 3] |                      |
|---------------|----------------------|
| 1             | [FUNCTIONS 2]        |
| 2             | RADAR 1              |
| 3             | FUNCTION KEY 1       |
| 4             | FUNCTION KEY 2       |
| 5             | FUNCTION KEY 3       |
| 6             | FUNCTION KEY 4       |
| 7             | RADAR            1/2 |
| 7             | INTER SWITCH         |
| 8             |                      |
| 9             | GYRO SETTING         |
| 0             | [FUNCTIONS 4]        |

→ [2]

- | [RADAR 1] |  |
|-----------|--|
| 1         | [FUNCTIONS 3]                          |
| 2         | EBL 1           REL/TRUE               |
| 3         | EBL 2           REL/TRUE               |
| 4         | VRM 1           NM/km (IMO: nm   only) |
| 5         | VRM 2           NM/km (IMO: nm   only) |
| 6         | TRAIL           REL/TRUE               |
| 7         | TRAIL GRAD     SGL/MULT                |
| 8         | [PULSE WD 1]                           |
| 9         | [PULSE WD 2]                           |
| 0         | [RADAR 2]                              |

In RADAR 1 menu, select 8 for pulselength 1 or 9 for pulselength 2. Selection available is as below for FR-2115/2125:

0.5 nm range	S1/S2	0.75 nm range	S1/S2/M1
1.5 nm range	S1/S2/M1	3 nm range	S2/M1/M2/M3
6 nm range	M1/M2/M3/L	12-24 nm range	M2/M3/L

## 1.12 Adjusting the Sensitivity

The GAIN control is used to adjust the sensitivity of the receiver, and thus the intensity of echoes as they appear on the screen. It should be adjusted so that speckled background noise is just visible on the screen.

To become acquainted with the way the GAIN control works, try rotating it between fully counterclockwise and clockwise positions while observing the radar picture. You will notice that clockwise rotation increases the echo intensity level. A low gain setting results in the loss of weak echoes and a reduced detection range. If you turn the GAIN control too far clockwise for an excessive gain setting, desired echoes will be masked in the strong background noise.

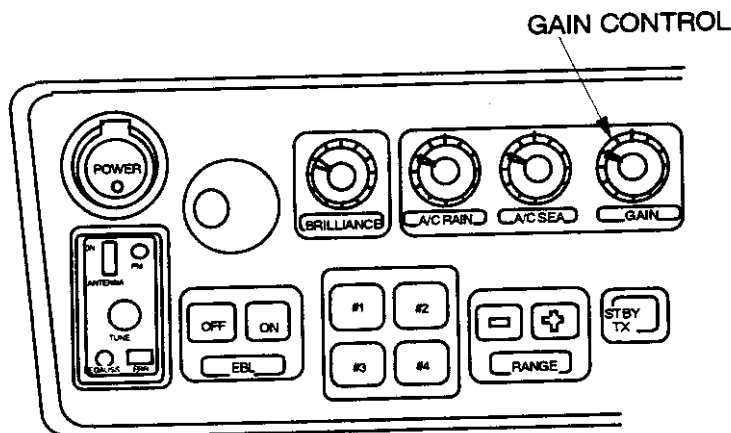

## 1.13 Suppressing Sea Clutter

In rough weather conditions returns from the sea surface are received over several miles around own ship and mask close targets. This situation can be improved by properly adjusting the A/C SEA (Anti-Clutter Sea) control.

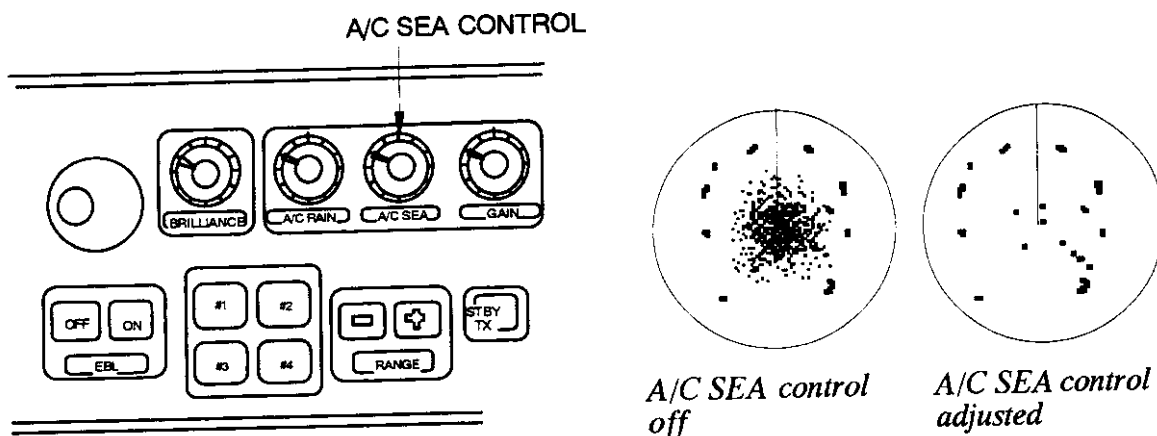

## Automatic anti-clutter control

The easiest way to suppress the surface clutter is to use the automatic control. Press the A/C AUTO key. Use of a function key is also a good method for reducing sea clutter. For this purpose, presetting is required. Consult a FURUNO representative.

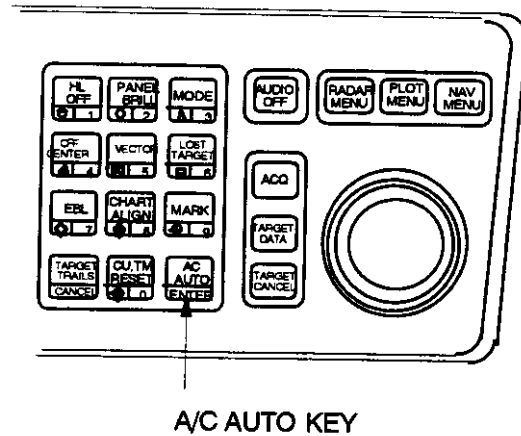

### CAUTION

The auto A/C function can erase weak target echoes.

## Manual anti-clutter control

From the fully counterclockwise position, slowly turn the A/C SEA control clockwise. For optimum target detection, you should leave speckles of the surface return slightly visible.

The anti-clutter sea control is often referred to as STC (Sensitivity Time Control) which decreases the amplification of the receiver immediately after a radar pulse is transmitted, and progressively increases the sensitivity as the range increases.

A common mistake is to over-adjust the A/C SEA control so that the surface clutter is completely removed. By rotating the control fully clockwise, you will see how dangerous this can be; a dark zone is created near the center of the screen and close-in targets can be lost. This dark zone is even more dangerous if the gain has not been properly adjusted. Always leave a little surface clutter visible on the screen. If no surface clutter is observed (on a very calm water), set the control at the fully counterclockwise position.

## 1.14 Suppressing Precipitation Clutter

In adverse weather conditions, clouds, rain or snow produce a lot of spray-like spurious echoes and impairs target detection over a long distance. This situation can be improved by using a function key provided that it is so programmed. If the function key fails to offer a favorable suppression of the rain clutter, adjust the A/C RAIN control on the front control head.

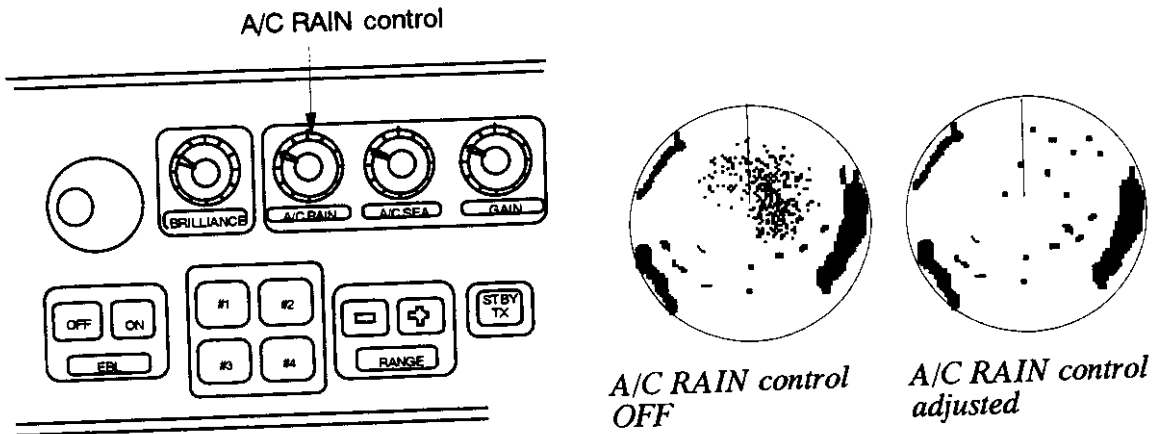

The A/C RAIN control adjusts the receiver sensitivity as the A/C SEA control does but rather in a longer time period (longer range). Clockwise rotation of this control increases the anti-clutter effect.

## 1.15 Interference Rejector

Mutual radar interference may occur in the vicinity of another shipborne radar operating in the same frequency band (9 GHz for X-band, 3 GHz for S-band). It is seen on the screen as a number of bright spikes either in irregular patterns or in the form of usually curved spoke-like dotted lines extending from the center to the edge of the picture. This type of interference can be reduced by activating the interference rejector circuit.

The interference rejector is a kind of signal correlation circuit. It compares the received signals over successive transmissions and suppresses randomly occurring signals. There are three levels of interference rejection depending on the number of transmissions that are correlated. These are indicated by the legends IR1, IR2 and IR3 at the upper-left position of the screen.

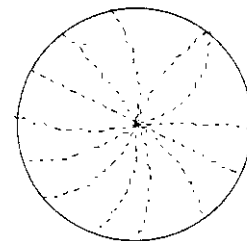

Radar interference

To activate the interference rejector;

1. Press the RADAR MENU key. The following appears.

[FUNCTIONS 1]	
1 TARGET TRAILS	
2 GUARD ALARM	1 or 2
3 ORIGIN MARK	1 to 10
4 INDEX LINES	
5	
6 PULSE WIDTH	
7 INT REJECT	
8 ARPA	
9 VIDEO PLOT	
0 [FUNCTION 2]	

2. Press the [7] key to select the INT REJECT option.
3. Successive presses of the key increase the effect of interference rejection, up to level 3. A fourth press deactivates the interference rejector. Switch off the interference rejector when no interference exists; otherwise weak targets may be lost.

**Note:** For stable reception of certain types of radar beacons (Racons) or SART (Search and Rescue Radar Transponder) as required by SOLAS 1974 as amended 1988 (GMDSS), it is recommended to turn the interference rejector off.

## 1.16 Measuring the Range

Use the fixed range rings to obtain a rough estimate of the range to a target. They are concentric solid circles about own ship, or the sweep origin. The number of rings is automatically determined by the selected range scale and their interval is displayed at the upper-left position of the screen.

### Procedure

1. Press the RADAR MENU key to display FUNCTIONS 1 menu.
2. Press the [0] key to display FUNCTIONS 2 menu.
3. Press [9] key to display BRILLIANCE 1 menu.

[BRILLIANCE 1]	
1	[FUNCTIONS 2]
2	RINGS BRILL      OFF/DIM/M1/M2/BRT
3	EBL BRILL          DIM/M1/M2/BRT
4	VRM BRILL          DIM/M1/M2/BRT
5	+CURSOR BRILL OFF/DIM/M1/M2/BRT
6	CHAR BRILL        DIM/M1/M2/BRT
7	MARK BRILL        DIM/M1/M2/BRT
8	TRAIL BRILL        DIM/M1/M2/BRT
9	HL BRILL           DIM/M/BRT
0	[BRILLIANCE 2]

4. Press [2] key to select RINGS BRILL option.
5. Press [2] key again. Each pressing gradually increase their brightness in 4 steps and fifth press erases the range rings.
6. Press the ENTER key to confirm you selection.
7. Press the RADAR MENU key to close the menu.

Use the Variable Range Markers (VRMs) for more accurate measurement of the range to a target. There are two VRMs, No. 1 and No. 2, which appear as dashed rings so that you can discriminate them from the fixed range rings. The two VRMs can be distinguished from each other by different lengths of dashes.

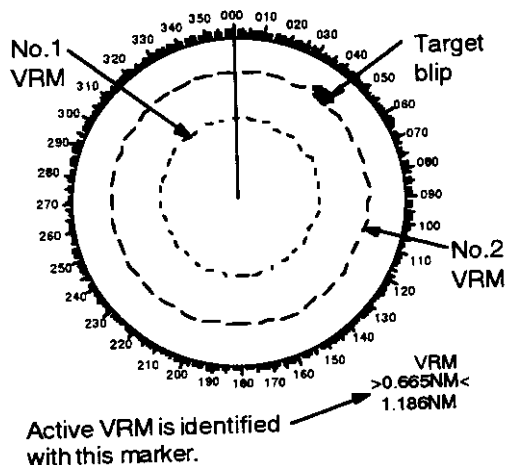

### *Measuring the range*

Press the VRM ON key to display either of the VRMs.

Successive presses of the VRM ON key toggle the active VRM between No. 1 and No. 2 and the currently active VRM readout is circumscribed by >.....<.

Turning the VRM control, align the active variable range marker with the inner edge of the target of interest and read its distance at the lower-right corner of the screen. Each VRM remains at the same geographical distance when you operate the RANGE+ or RANGE- key. This means that the apparent radius of the VRM ring changes in proportion to the selected range scale.

Press the VRM OFF key to key to erase each VRM.

## **1.17 Measuring the Bearing**

Use the Electronic Bearing Lines (EBLs) to take bearings of a target. There are two EBLs, No. 1 and No. 2, which are toggled by successive presses of the EBL ON key. Each EBL is a straight dashed line extending out from the own ship position up to the circumference of the radar picture. The fine dashed line is the No. 1 EBL and the coarse dashed one is the No. 2 EBL.

Press the EBL ON key to display either of the EBLs.

Successive presses of the EBL ON key toggle the active EBL between No. 1 and No. 2 and the currently active EBL readout is circumscribed by >... <.

Rotate the EBL rotary control clockwise or counterclockwise until the active EBL bisects the target of interest, and read its bearing at the lower-left corner of the screen.

The EBL readout is affixed by "R" (relative) if it is relative to own ship's heading, "T" (true) if it is referenced to the north, as determined by RADAR 2 menu settings.

Each EBL carries a range marker, or a short line crossing the EBL at right angles and its distance from the EBL origin is indicated at the VRM readout whether or not the corresponding VRM is displayed. The range marker changes its position along the EBL with the rotation of the VRM control.

Press the EBL OFF key to erase each EBL.

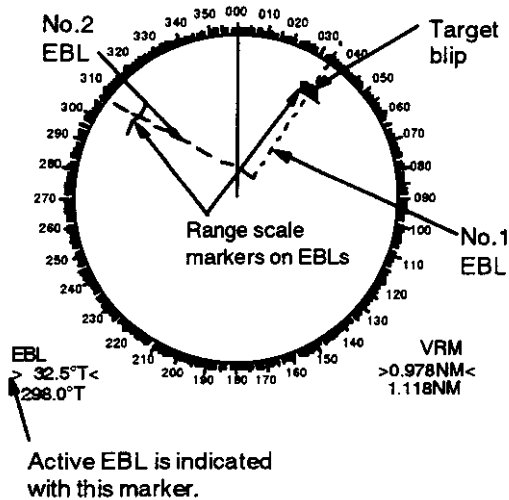

## 1.18 Collision Assessment by Offset EBL

The origin of the EBL can be placed anywhere with the trackball to enable measurement of range and bearing between any targets. This function is also useful for assessment of the potential risk of collision. To assess possibility of collision:

1. Press the EBL ON key to display or activate an EBL (No. 1 or 2).
2. Place the cursor (+) on a target of interest (A in the illustrated example) by operating the trackball.
3. Press the EBL OFFSET key on the mode panel, and the origin of the active EBL shifts to the cursor position. Press the EBL OFFSET key again to anchor the EBL origin.
4. After waiting for a few minutes (at least 3 minutes), operate the EBL control until the EBL bisects the target at the new position (A'). The EBL readout shows the target ship's course, which may be true or relative depending on the settings on the RADAR 1 menu.

If relative motion is selected, it is also possible to read CPA (Closest Point of Approach) by using a VRM as shown below (Figure (a)). If the EBL passes through the sweep origin (own ship) as illustrated (Figure (b)), the target ship is on a collision course.

5. To return the EBL origin to the own ship's position, press the EBL OFFSET key again.

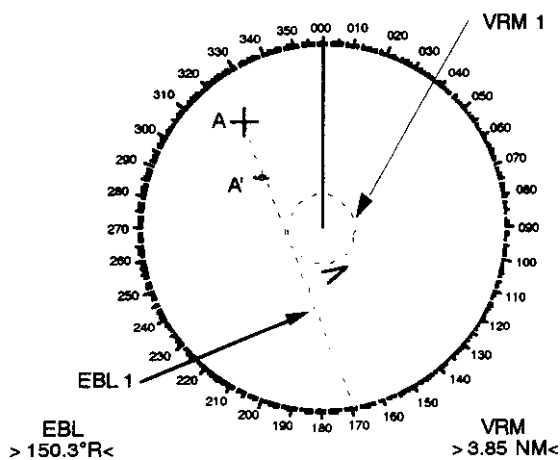

(a) Evaluating the target ship course in RM

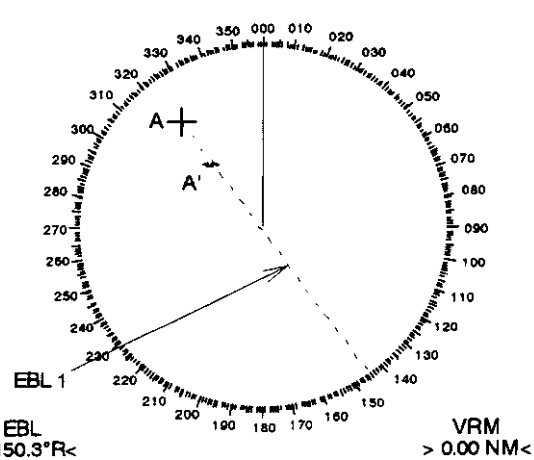

(b) Target ship on collision course



## 1.19 Measuring Range and Bearing Between Two Targets

Press the EBL OFFSET key, and place the origin of No. 1 EBL, for example, on a target of interest (target 1 in the illustrated example) by operating the trackball.

Turn the EBL control until the EBL passes through another target of interest (target 2).

Turn the VRM control until the range marker aligns with target 2. The active VRM readout at the lower-right corner of the screen indicates the distance between the two targets.

You can repeat the same procedure on third and fourth targets (targets 3 and 4) by using No. 2 EBL and No. 2 VRM.

Bearing is shown relative to own ship with suffix "R" or as a true bearing with suffix "T" depending on EBL relative/true settings on the RADAR 1 menu. To return the EBL origin to the own ship position, press the EBL OFFSET key again.

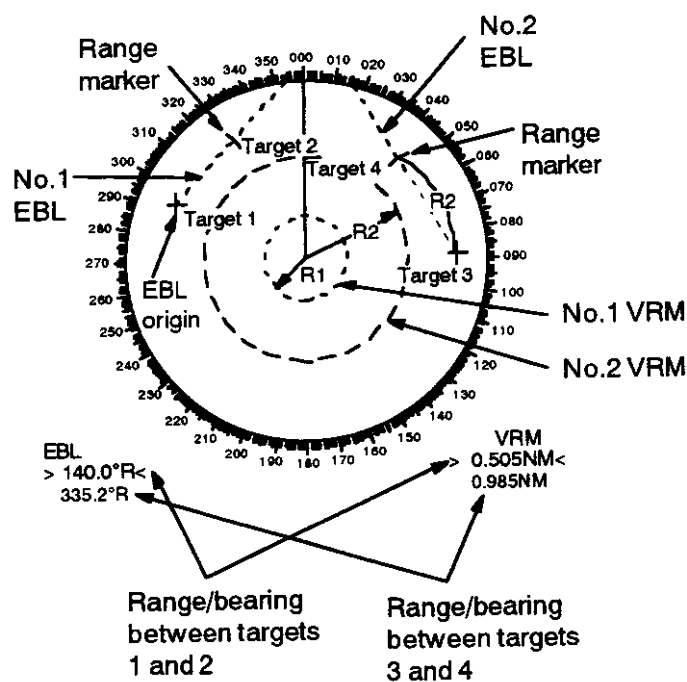

## 1.20 Setting a Target Alarm Zone



### CAUTION

The target alarm feature should never be relied upon as the sole means for detecting the risk of potential collision. The operator of a ship is not relieved of the responsibility to keep lookout for avoiding collisions, whether or not the radar is in use.

The target alarm serves to alert the navigator to targets (ships, landmasses, etc.) entering a certain area with visual and audible alarms.

The zone has a fixed width of 0.5 nm in the radial direction (depth) and is adjustable only within 3.0 to 6.0 nm from own ship. On the R-type, the outer and inner boundaries can be set at any

distance. On any radar type, the sector of the zone can be set anywhere between 0 and 360 degrees in any direction.

To set a target alarm zone:

1. Place the cursor (+) at point "A" (see figure below) using the trackball.
2. Press the RADAR MENU key to show the FUNCTION 1 menu.
3. Press [2] key to set start point (point "A") of the alarm zone. The message TGT ALARM 1 (or 2) SET appears at the bottom-right corner of the screen.
4. Move the cursor (+) to point "B" and press the [2] key again. Then, the target alarm zone as illustrated is created and the label TGT ALARM 1 (or 2) appears instead of TGT ALARM 1 (or 2) SET at the lower-right corner of the screen.

**Note:** If you wish to create a target alarm zone having a 360-degree coverage around own ship, set point "B" in almost the same direction (approx.  $\pm 3^\circ$ ) as point "A" and press the [2] key.

If you change the range scale to less than half of the TAZ, the warning TGT ALARM 1 (or 2) OUT appears instead of TGT ALARM 1 (or 2).

5. Two alarm zones can be set as described above. Press [ENTER] and [2] keys in that order while displaying the FUNCTION 1 menu and repeat the above steps.

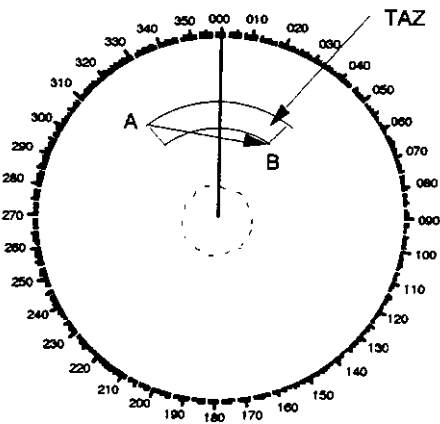

Target alarm zone (TAZ) can be set in any sector between 3 and 6 nm on IMO-type, or anywhere on the R-type.

When the radar has an ARPA board ARP-26, a total of 4 alarm zones (2 each TAZ and GZ) may be set.

The 2nd TAZ or 2nd GZ is available only when the 1st TAZ or 1st GZ is valid.

## Acknowledging alarm

A target entering the watch zone produces both visual (flashing) and audible (beeping) alarms. To silence the audible alarm, press [2] key shortly on the FUNCTION 1 menu and the label TGT ALARM 1 ACK replaces TGT ALARM 1 on the display.

This will deactivate the audible alarm but will not stop the flashing of the target in the guard alarm zone. To reactivate the audible alarm, press [2] key again on the FUNCTIONS 1 menu.

When an external buzzer is connected, the audible alarm does not stop until deactivation of the guard alarm.

## Deactivating guard alarm

Hold the [2] key depressed for at least 5 seconds on the FUNCTION 1 menu. In the IMO type, deactivation of TAZ 1 deactivates TAZ 2. TAZ 1 and 2 work independent in the Regular type.

**Note:** The echo watch alarm is given to targets having a certain level of echo strength. This level

does not always imply a landmass, reef, ships or other surface objects but can mean returns from the sea surface or precipitation. Properly adjust the GAIN, A/C SEA, and A/C RAIN controls to reduce noise to avoid generation of an alarm against false target.

## Inward and outward guard alarms

On the R-type, an inward or outward guard alarm can be selected on the RADAR 2 menu. On the IMO type, only the inward guard alarm is available. The inward guard alarm generates visual and audible warnings when a target enters the guard zone from any direction. The outward guard alarm is produced when a target leaves the guard zone (This is not a guard zone by definition but some users find this feature valuable).

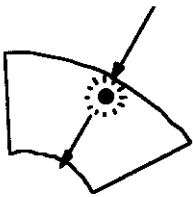

(a) *Inward guard alarm available on IMO and R-types*

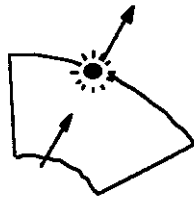

(b) *Outward guard alarm available on R-type only*

## 1.21 Off-Centering

Own ship position, or sweep origin, can be displaced to expand the view field without switching to a larger range scale. The sweep origin can be off-centered to the cursor position, but not more than 75% of the range in use; if the cursor is set beyond 75% of the range scale, the sweep origin will be off-centered to the point of 75% of the limit.

This feature is not available on the longest range scale. The number of range rings increases keeping the original range intervals unchanged.

To off-center the radar picture:

1. Place the cursor at a position where you wish to move the sweep origin by operating the trackball.
2. Press the OFF CENTER key. Then, the sweep origin is off-centered to the cursor position.
3. To cancel off-centering, press the OFF CENTER key again.

The picture cannot be off-centered in the true motion mode.

## 1.22 Echo Stretch

On long ranges target echoes tend to shrink in the bearing direction, making them difficult to see. On short and medium ranges such as 1.5, 3 and 6 nm scales, the same size targets get smaller on screen as they approach the own ship. These are due to the inherent property of the radiation pattern of the antenna. To enhance target video, use the echo stretch function. There are 3 settings: echo stretch 1 (ES1) to enlarge in bearing direction for long range detection, echo stretch 2 (ES2) to enlarge in range direction and echo stretch 3 (ES3) to enlarge in bearing and range directions.

To activate the echo stretch:

1. Press the RADAR MENU key to show the FUNCTIONS 1 menu.
2. Press the [0] key to display the FUNCTIONS 2 menu.
3. Press the [3] key to select ECHO STRETCH.
4. Press [3] until Echo Stretch option 1, 2, 3 or OFF as desired is highlighted.
5. Press the ENTER key to conclude your selection followed by the RADAR MENU key to close the FUNCTIONS menu. Selected setting is marked on the left side of the radar display.

[FUNCTIONS 2]	
1 [FUNCTIONS 1]	
2 BKGD COLOR	BLK(GRN CHAR)/ BLK(RED)/ BLU (ECHO AREA) BLU/ BRT BLU
3 ECHO STRETCH	OFF/1/2/3
4 ECHO AVERAGE	OFF/1/2/3
5 ECHO COLOR	YEL/GRN
6 SHIP SPEED	LOG/NAV/MAN MAN = xx.xKT (STW/SOG)
7 SET, DRIFT	OFF/MAN SET = xxx.x° DRIFT = xx.xKT
8 INDEX LINES	NO. 2 VRM/MAN MAN = XX.XX NM
9 BRILLIANCE (1)	
0 [FUNCTION 3]	

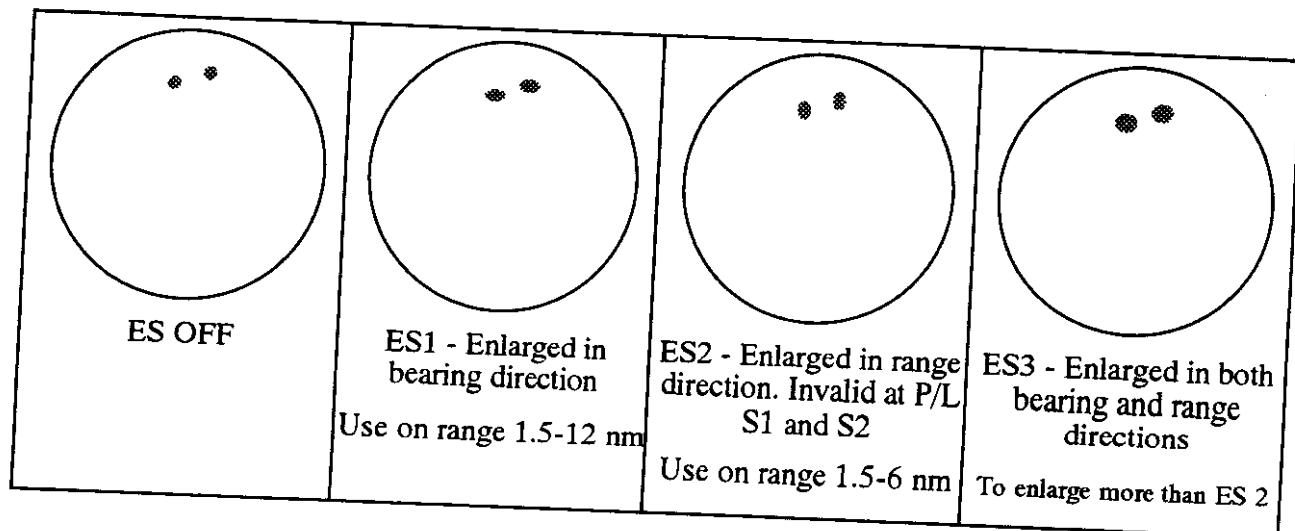

## Notes:

- 1) If the 1.5 nm range is preset with a pulselength of S1 or S2, and the 3 nm scale with S2, the echo stretch is not available on these range scales.
- 2) The echo stretch magnifies not only small target pips but also returns (clutter) from sea surface, rain and radar interference. For this reason make sure these types of interference have been sufficiently suppressed before activating this function.

## 1.23 Echo Averaging

The echo average feature effectively suppresses sea clutter. Echoes received from stable targets such as ships appear on the screen at almost the same position every rotation of the antenna. On the other hand, unstable echoes such as sea clutter appear at random positions.

To distinguish real target echoes from sea clutter, this radar performs scan-to-scan correlation. Correlation is made by storing and averaging echo signals over successive picture frames. If an echo is solid and stable, it is presented in its normal intensity. Sea clutter is averaged over successive scans resulting in the reduced brilliance, making it easier to discriminate real targets from sea clutter.

To properly use the echo average function, it is recommended to first suppress sea clutter with the A/C SEA control and then do the following:

1. Press the RADAR MENU key and the [0] key to show the FUNCTIONS 2 menu.

[FUNCTIONS 2]	
1 [FUNCTIONS 1]	
2 BKGD COLOR	BLK(GRN CHAR)/ BLK(RED)/ BLU (ECHO AREA) BLU/ BRT BLU
3 ECHO STRETCH	OFF/1/2/3
4 ECHO AVERAGE	OFF/1/2/3
5 ECHO COLOR	YEL/GRN
6 SHIP SPEED	LOG/NAV/MAN
7 SET, DRIFT	OFF/MAN SET = xxx.x° DRIFT = xx.xKT
8 INDEX LINES	NO. 2 VRM/MAN MAN = XX.XX NM
9 BRILLIANCE (1)	
0 [FUNCTION 3]	

2. Press the [4] key to select ECHO AVERAGE.
3. Press [4] until echo average option 1, 2, 3 or OFF as desired is highlighted.  
OFF: No averaging effect  
1: Helps distinguish targets from sea clutter and suppresses brilliance of unstable echoes  
2: Distinguishes small stationary targets such as navigation buoys.  
3: Stably displays distant targets.
4. Press the ENTER key to conclude your selection followed by the RADAR MENU key to close the FUNCTIONS menu.

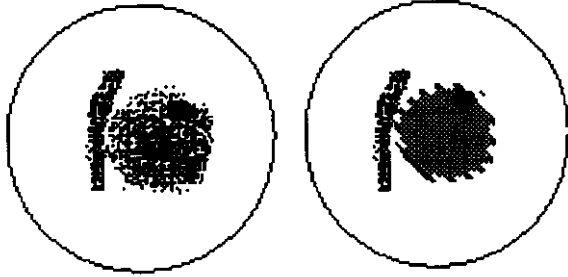

(a) *Echo average OFF*      (b) *Echo average ON*

Echo averaging uses scan-to-scan signal correlation technique based on the true motion over the ground of each target. Thus, small stationary targets such as buoys will be shown while suppressing random echoes such as sea clutter. True echo average is not however effective for picking up small targets running at high speeds over the ground.

Echo average is inoperable when a gyrocompass signal is not available. If you wish to use this feature without a gyrocompass signal, consult a FURUNO representative.

Manual speed entry is done at menu item 6 SHIP'S SPEED on the FUNCTIONS 2 menu which is accessed by pressing the RADAR MENU key.



**Do not use the Echo Average function under heavy pitching and rolling; loss of target detection can result.**

## 1.24 Electronic Plotting Aid (EPA)

A maximum 10 operator-selected targets can be plotted electronically to assess their motion trend. Five past positions can be displayed for each of the plotted targets. If you enter a 6th plot on a certain target, the oldest plot (past position) will be erased.

A vector appears when you enter a second plot for the target and is updated each time a new plot is entered. The vector shows the target motion trend based on its latest two plots. The vector origin will move across the screen at a rate and direction defined by the calculated true course and speed until a next manual plotting.

Target data is shown in the data display area which shows:

bearing, course, speed, CPA, TCPA, calculated true course of targets, calculated true speed of targets

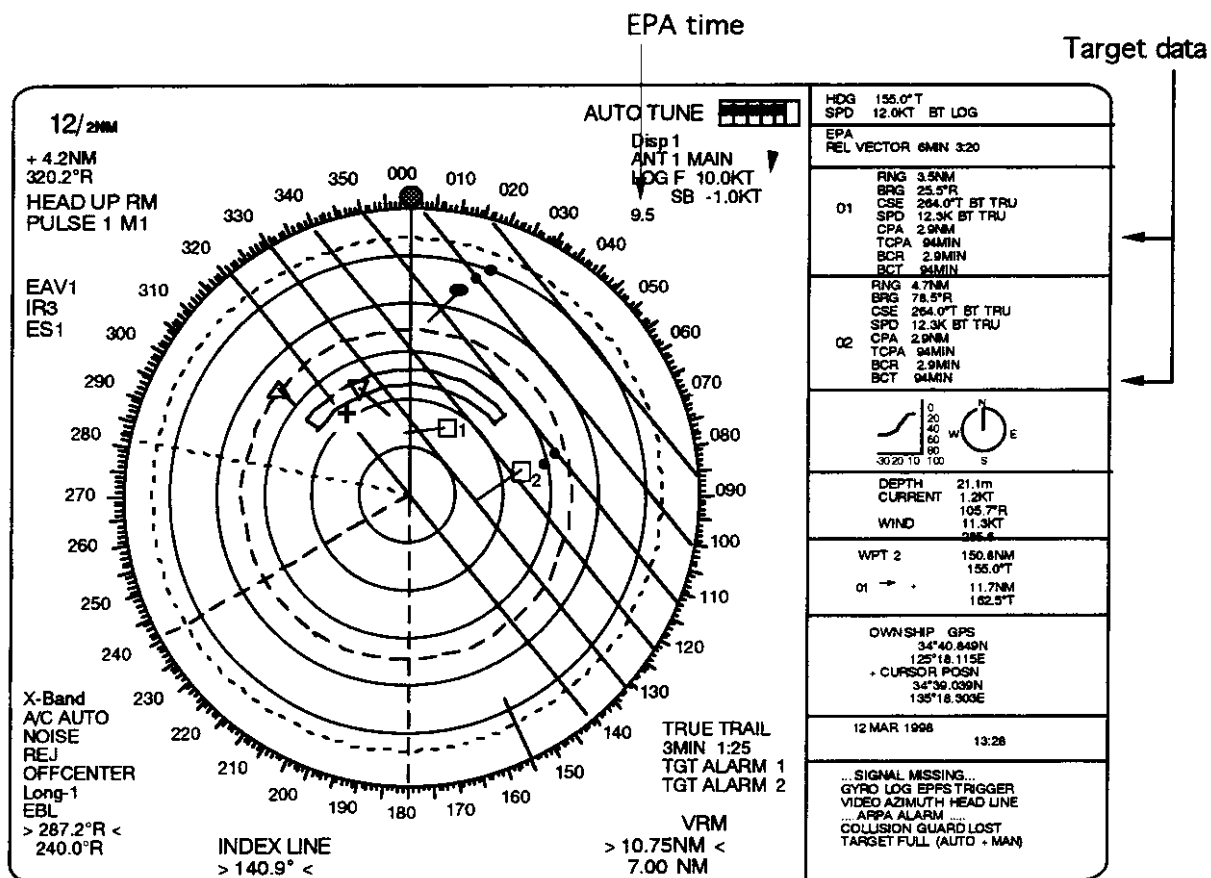

Target 2 is on a collision course as the extension of the vector goes through the own ship position. Placing the offset EBL will be a help for assessment. TCPA is counted up to 99.9 min and beyond this it is indicated as TCPA > 99.9 MIN.

**Note:** EPA requires own ship's speed input (automatic or manual) and a compass signal. The vector and data is updated on real time between plot entries, but do not neglect to plot a new position over a long period of time. The accuracy will be reduced. Note the plots will be lost when the compass fails; start the plotting exercise again.

## Plotting a target

To perform electronic plotting:

1. Place the cursor(+) on a target of interest by operating the trackball.
2. Press the ACQ key and one of numeric keys, and the selected plot symbol is marked at the cursor position.
3. Watching the EPA time (TIM xx:xx) shown at the upper right margin of the screen, wait for at least 30 seconds. Place the cursor (+) on the target at its new location, press the ACQ key, and the same numeric key for the target.

The plot symbol moves to the new target position and previous position is marked by a small dot.

4. To acquire other targets, repeat the above steps selecting different plot symbols.

**Note:** If a target once plotted is not plotted again within 12 minutes, the warning "UPDATE PLOT" will appear on the upper right margin of the screen and the plot symbol of the target flashes. The plot will be dropped if the time between consecutive plots exceeds 12 min. If you want to continue plotting this target, reacquire it within one minute. Otherwise, the target will be regarded as a "lost target" and its plot symbol and target data will be erased. The larger the plotting interval, the less accurate the plotted target data. Plotting of each target should normally be made every 3 or 6 minutes as far as possible. You can use a Watch Alarm to warn yourself every 3 or 6 min or whichever you may set.

Within 30 s, you can cancel a last plot by CANCEL key and make a re-entry at a different position. After 30 s, the last entry is processed to produce a vector.

## True or relative vector

Vectors can be displayed relative to own ship's heading (Relative) or with reference to the north (True). Press the VECTOR key to select the required mode. This feature is available in all presentation modes (gyrocompass must be working correctly). The current vector mode is indicated at the upper-right corner of the screen.

## Vector time

Vector time (or the length of vectors) can be set to 30 s, 1, 2, 3, 6, 12, 15 or 30 min and the selected vector time is indicated at the upper-right corner of the screen.

1. Press the PLOT MENU key, and [1] key several times until the desired vector time is reached.

	[PLOT]
1 VECTOR TIME	30SEC/1/2/3/6/12/15/30 MIN
2 COLLISION ALARM	OFF/ON
	CPA x.x NM
	TCPA xx.x MIN
3 MARK	STD/LARGE
4 PLOT NO.	OFF/ON

2. Press the [ENTER] key to confirm your selection.
3. Press the PLOT MENU key to close the menu. The vector tip shows an estimated position of the target after the selected vector time elapses. It can be valuable to extend the vector length to evaluate the risk of collision with any target.



## Target data

The radar calculates motion trends (range, bearing, course, speed, CPA and TCPA) of all plotted targets.

In head-up and head-up true bearing modes, target bearing, course and speed shown in the upper-right target data field become true (T) relative to north or relative (R) relative to own ship in accordance with true/relative vector setting. In north-up, course-up, and True Motion modes, the target data field always displays true bearing, true course and speed over the ground.

## Reading the target data

Press the ACQ key and corresponding numeric key, and the following target data is displayed.

**RNG/BRG (Range/Bearing):** Range and bearing from own ship to last-plotted target with suffix "T" (True) or "R" (Relative) plot symbol.

**CSE/SPD (Course/Speed):** Course and speed are displayed for the last-plotted target with suffix "T" (True) or "R" (Relative) plot symbol.

**CPA/TCPA:** CPA (Closest Point of Approach) is a closest range the target will approach to own ship. TCPA is the Time to CPA. Both CPA and TCPA are automatically calculated. TCPA is counted up to 99.9 min and beyond this, it is indicated as TCPA > \*99.9 MIN.

**BCR/BCT:** BCR (Bow Cross Range) is the range at which target will cross own ship's bow. BCT (Bow Cross Time) is the estimated time at which target will cross own ship's bow. If BCR is negative, BCR/BCT readout should be displayed as \*.\*.

## Terminating target plotting

With EPA you can plot up to 10 targets. You may wish to terminate plotting of less important targets to newly plot other threatening targets.

**By Symbol:** To terminate plotting of a certain target, press the corresponding plot symbol key. Then press the TARGET CANCEL key.

**With Trackball:** Place the cursor (+) on a target which you do not want to be tracked any longer by operating the trackball and press the TARGET CANCEL key.

**All Targets:** To terminate plotting of all targets at once, press and hold the TARGET CANCEL key until all plot symbols and marks disappear in about 3 seconds.

## Setting CPA/TCPA Alarm Ranges

When the predicted CPA of any target becomes smaller than a preset CPA alarm range and its predicted TCPA less than a preset TCPA alarm limit, the EPA releases an aural alarm and displays the warning label COLLISION on the screen. In addition, the EPA symbol changes to a triangle and flashes together with its vector.

Provided that this feature is used correctly, it will help prevent the risk of collision by alerting you to threatening targets. It is important that GAIN, A/C SEA, A/C RAIN and other radar controls are properly adjusted.

CPA/TCPA alarm ranges must be set up properly taking into consideration the size, tonnage, speed, turning performance and other characteristics of own ship.



## CAUTION

### CPA/TCPA

The CPA/TCPA alarm feature should never be relied upon as the sole means for detecting the risk of collision. The navigator is not relieved of the responsibility to keep visual lookout for avoiding collisions, whether or not the radar or other plotting aid is in use.

To set the CPA/TCPA alarm ranges:

1. Press the PLOT MENU key to show the EPA menu.
2. Press the [2] key to select menu item COLLISION ALARM. At this point, a highlight cursor appears at the "CPA x.x NM" field.
3. Enter the CPA alarm range in nautical miles (max 9.9 min) without omitting leading zeroes, if any, and press the ENTER key. The highlight cursor now moves to the "TCPA xx.x MIN" field.
4. Enter the TCPA alarm limit in minutes (max. 99.0 min) without omitting leading zeroes, if any, and press the ENTER key.
5. Press the PLOT MENU key to close the menu.

### Silencing CPA/TCPA audible alarm

Press the AUDIO OFF key to acknowledge and silence the CPA/TCPA audible alarm.

The warning label COLLISION and the flashing of the triangle plot symbol and vector remain on the screen until the dangerous situation is gone or you intentionally terminate tracking of the target by using the CANCEL key.

### Changing size of the plotting symbols

You can change the size of the plotting symbols as the procedure shown below:

1. Press the PLOT MENU key to show the EPA menu.
2. Press the [3] key two or three times until plot symbol size option STD (standard) or LARGE is highlighted.
3. Press the ENTER key to conclude your selection followed by the PLOT MENU key to close the PLOT menu.

## 1.25 Entering own ship's speed

EPA and any azimuth stabilized presentation modes require an own ship speed input and compass signal. The speed can be entered from a speed log (automatic) or through the plotting keypad (manual).

### Automatic speed input

1. Press the RADAR MENU key and the [0] key to show the FUNCTIONS 2 menu.

[FUNCTIONS 2]	
1 [FUNCTIONS 1]	
2 BKGD COLOR	BLK(GRN CHAR)/ BLK(RED)/ BLU (ECHO AREA) BLU/ BRT BLU
3 ECHO STRETCH	OFF/1/2/3
4 ECHO AVERAGE	OFF/1/2/3
5 ECHO COLOR	YEL/GRN
6 SHIP SPEED	LOG/NAV/MAN MAN = xx.xKT (STW/SOG)
7 SET, DRIFT	OFF/MAN SET = xxx.x° DRIFT = xx.xKT
8 INDEX LINES	NO. 2 VRM/MAN MAN = XX.XX NM
9 BRILLIANCE (1)	
0 [FUNCTION 3]	

2. Press the [6] key to select menu item 6 SHIP'S SPEED.
3. Press the [6] key to select (or highlight) LOG option.
4. When the serial speed data is selected at the installation menu, select the speed mode, STW (speed through the water) or SOG (speed over the ground). If pulse speed data is selected, the STB/SOG disappears.
5. Press the ENTER key to confirm your selection followed by the RADAR MENU key to close the FUNCTIONS menu. The ship's speed readout at the screen top shows own ship's speed fed from the speed log followed by the label "LOG."

### Notes:

- 1) IMO Resolution A.823(19) for ARPA recommends that a speed log to be interfaced with an ARPA should be capable of providing through-the-water speed.
- 2) Be sure not to select LOG when a speed log is not connected. If the log signal is not provided, the ship's speed readout at the screen top will be blank.
- 3) SPEED \*\*. \* and SIGNAL MISSING " LOG" appears if no log signal is present for 30 s while the ship speed has been more than 5.0 kt or for 3 min below 5.0 kt.
- 4) With the serial speed inputs and SOG selection, if the type of data is changed from SOG to STW, the label SOG appears in red at the upper right corner on the screen.

### Manual speed input

If the radar is not interfaced with a speed log, or the speed log does not feed correct speed enter the ship's speed as follows:

1. Press the RADAR MENU and [0] key to show the FUNCTIONS 2 menu.
2. Press the [6] key to select menu 6 SHIP'S SPEED.
3. Press the [6] key to select (or highlight) MAN option.
4. Press the ENTER key to confirm selection. At this point, "MAN = XX. KT" appears on the FUNCTIONS 2 menu.
5. Enter the ship speed by hitting corresponding numeric keys followed by the ENTER without omitting leading zeros, if any. A example, if the ship speed is 8 knots, [0] [8] [ENTER].
6. Press the RADAR MENU key to close FUNCTIONS menu. The ship speed read at the screen top shows own ship speed entered followed by the label "MAN."

## 1.26 Target Trails (Echo Trails)

It is possible to display the trails by the radar echoes of targets in the form of synthetic afterglow. The afterglow can be selected in a single tone or gradual shading as set on RADAR 1 menu.

### True or relative trails

You may display echo trails in true or relative motion (only true trail on TM). Relative trails show relative movements between targets and own ship. True motion trails require a gyrocompass signal and own ship speed input to cancel out own ship's movement and present true target movements in accordance with their over-the-ground speeds and courses.

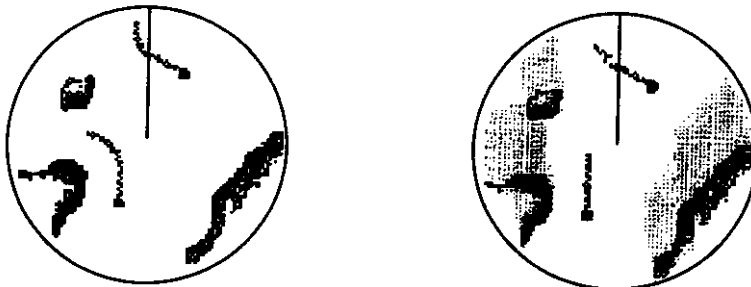

- (a) True target trails - no smearing of stationary targets      (b) Relative target trails - all targets moving relative to own ship

**Note:** When true trail is selected on the RM mode, the legend TRUE TRAIL appears in red. No true-relative selection on TM, it is only True trails on TM mode.

To select true or relative echo trail presentation:

- .1 Press the RADAR MENU key to show the FUNCTIONS 1 menu.
- .2 Press the [0] key twice for FUNCTION 3 menu, then [2] key to show the RADAR 1 menu.
- .3 Press the [6] key to select menu item 6 TRAIL.
- .4 Press the [6] key to select (or highlight) REL (Relative) or TRUE option.
- .5 Press the ENTER key to confirm your selection; then RADAR MENU key to close the menu.

Press [RADAR MENU] key.



- | [FUNCTIONS 1] |                          |
|---------------|--------------------------|
| 1             | TARGET TRAILS            |
| 2             | GUARD ALARM      1 or 2  |
| 3             | ORIGIN MARK      1 to 10 |
| 4             | INDEX LINES              |
| 5             |                          |
| 6             | PULSE WIDTH              |
| 7             | INT REJECT               |
| 8             | ARPA                     |
| 9             | VIDEO PLOT               |
| 0             | [FUNCTION 2]             |

↓ Press [0] key.

- | [FUNCTIONS 2] |   |
|---------------|---|
| 1             | [FUNCTIONS 1]   |
| 2             | BKGD COLOR      BLK(GRN CHAR)/<br>BLK(RED)/<br>BLU (ECHO AREA)<br>BLU/<br>BRT BLU |
| 3             | ECHO STRETCH    OFF/1/2/3   |
| 4             | ECHO AVERAGE   OFF/1/2/3  |
| 5             | ECHO COLOR    YEL/GRN   |
| 6             | SHIP SPEED      LOG/NAV/MAN   |
| 7             | SET, DRIFT      OFF/MAN<br>SET = xxx.x°<br>DRIFT = xx.xKT                         |
| 8             | INDEX LINES     NO. 2 VRM/MAN<br>MAN = XX.XX NM                                   |
| 9             | BRILLIANCE (1)  |
| 0             | [FUNCTION 3]  |

↓ Press [0] key.

- | [FUNCTIONS 3] |                      |
|---------------|----------------------|
| 1             | [FUNCTIONS 2]        |
| 2             | RADAR 1              |
| 3             | FUNCTION KEY 1       |
| 4             | FUNCTION KEY 2       |
| 5             | FUNCTION KEY 3       |
| 6             | FUNCTION KEY 4       |
| 7             | RADAR            1/2 |
| 7             | INTER SWITCH         |
| 8             |                      |
| 9             | GYRO SETTING         |
| 0             | [FUNCTIONS 4]        |

→ [2]

- | [RADAR 1] |                           |
|-----------|---------------------------|
| 1         | [FUNCTIONS 3]             |
| 2         | EBL 1            REL/TRUE |
| 3         | EBL 2            REL/TRUE |
| 4         | VRM 1                     |
| 5         | VRM 2                     |
| 6         | TRAIL            REL/TRUE |
| 7         | TRAIL GRAD      SGL/MULT  |
| 8         | [PULSE WD 1]              |
| 9         | [PULSE WD 2]              |
| 0         | [RADAR 2]                 |

### Trail gradation

Echo trails may be shown in monotone or gradual shading. Gradual shading paints the trails getting thinner with time just like the afterglow on an analog PPI radar.



Monotone (SGL)          Gradual shading (MULT)

- Press the [7] key to select menu item 7 TRAIL GRAD (graduation) in step 4, and
- Press the [7] key to select (or highlight) SGL (single tone) or MULT (multiple shading) option in step 5.

## Displaying and erasing echo trails

Press the RADAR MENU and [1] key to activate or deactivate the echo trails feature.

[FUNCTIONS 1]	
1 TARGET TRAILS	
2 GUARD ALARM	1 or 2
3 ORIGIN MARK	1 to 10
4 INDEX LINES	
5	
6 PULSE WIDTH	
7 INT REJECT	
8 ARPA	
9 VIDEO PLOT	
0 [FUNCTION 2]	

Each press of the [1] key within 5 seconds cyclically changes echo trail length (time) as below:

OFF - 30 s - 1 min - 3 min - 5 min - 15 min - 30 min - continuous - OFF

The current echo trail setting is displayed at the lower-right corner of the screen.

Suppose that "3 MIN" has just been selected. If the [1] key is hit on the FUNCTION 1 menu more than 5 seconds later, echo trails are removed from the display (memory still alive with echo trail timer count going on). Next hitting of the key calls out the echo trails on the screen. To proceed to longer plot intervals, successively push the [1] key with a hit-and-release action. The larger the echo trail length, the larger the echo trail plot interval.

**Note:** Holding the [1] key depressed for about 3 seconds on the FUNCTION 1 menu will cause a loss of echo trail data so far stored in an memory.

## Resetting echo trails

To reset (or clear) the echo trail memory, hold the TARGET TRAILS CANCEL key depressed for about 3 seconds. Echo trails are cleared and the trailing process restarts from time count zero at current echo trail plot interval. When memory assigned to echo trailing becomes the echo trail timer at the lower-right corner of the screen freezes and the oldest trails are erased to show the latest trails.

## 1.27 Parallel Index Lines

Parallel index lines are useful for keeping a constant distance between own ship and a coastline or a partner ship when navigating. Index lines are drawn in parallel with the No. 2 EBL (No. 2 EBL must be active). The orientation of the index lines is controlled with the EBL control (without effecting the EBL indication) and the intervals between the lines adjusted with the VRM rotary control (provided that No. 2 VRM is active).

Maximum number of the index line can be set on INITIAL SETTING 3 menu: 2, 3 or 6.

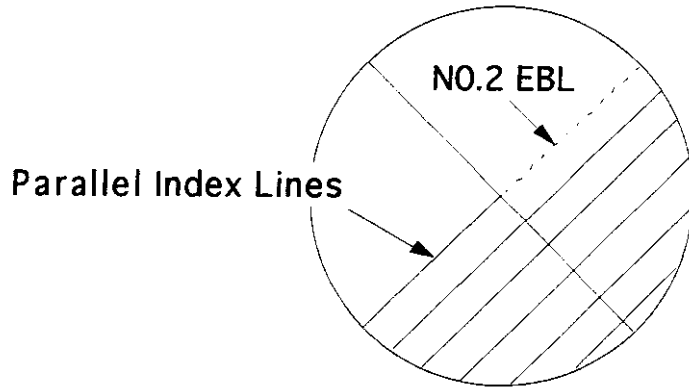

### Displaying and erasing the index lines

1. Press the RADAR MENU and [4] key, and the index lines appears.

[FUNCTIONS 1]	
1	TARGET TRAILS
2	GUARD ALARM      1 or 2
3	ORIGIN MARK      1 to 10
4	INDEX LINES
5	
6	PULSE WIDTH
7	INT REJECT
8	ARPA
9	VIDEO PLOT
0	[FUNCTION 2]

2. Orient the index lines in a desired direction with the EBL rotary control. The azimuth of the index lines appear at the left bottom of the screen.

### Adjusting index line intervals

1. Press the RADAR MENU AND [0] key to show the FUNCTIONS 2 menu.

[FUNCTIONS 2]	
1	[FUNCTIONS 1]
2	BKGD COLOR      BLK(GRN CHAR)/ BLK(RED)/ BLU (ECHO AREA) BLU/ BRT BLU
3	ECHO STRETCH    OFF/1/2/3
4	ECHO AVERAGE   OFF/1/2/3
5	ECHO COLOR      YEL/GRN
6	SHIP SPEED      LOG/NAV/MAN
7	SET, DRIFT      OFF/MAN SET = xxx.x° DRIFT = xx.xKT
8	INDEX LINES      NO. 2 VRM/MAN MAN = XX.XX NM
9	BRILLIANCE (1)
0	[FUNCTION 3]

2. Press the [8] key to select menu item 8 INDEX LINES.
3. Press the [8] key to select (or highlight) No. 2 VRM or MAN (manual) option.
4. Press the ENTER key to conclude your selection.
5. If you have selected MAN in step 3 above, "MAN = XX.XX NM" appears at the bottom of the FUNCTIONS 2 menu. Enter a desired line interval by hitting numeric keys followed by the ENTER key without omitting leading zeroes, if any. There are choices of 2, 3 and 6 index lines but the number of lines visible on the screen may be less than 6 depending on the line intervals.
6. If you have selected NO. 2 VRM in step 3 above, make sure that the No. 2 VRM is active and adjust the spacing between the index lines by operating the VRM control.
7. Press the RADAR MENU key to close the FUNCTIONS 2 menu.

**To erase the index lines;**

1. Press the RADAR MENU key and the [4] key.
2. Press the RADAR MENU key.

## **1.28 Origin Mark**

You can mark any reference points, prominent target or a point of particular interest using the origin mark feature. This mark is geographically fixed, i.e., ground stabilized. To display the origin marks, heading signal and own ship position data are required.

To use the origin mark:

1. Place the cursor (+) at a point where you want to place a reference mark by operating the trackball.
2. Press the RADAR MENU to show the FUNCTION 1 menu.
3. Press [3] key. The origin mark appears at the cursor position of which range and bearing are indicated at the lower-right section of the screen.
4. To measure the range and bearing to a target of interest from the origin mark, move the cursor to the target of interest. Then, the range and bearing from the origin mark to the target are shown at the target data display.
5. To enter another origin mark, press the ENTER key and the [3] key in the FUNCTIONS 1 menu. Place the cursor where you want to place the origin mark, then press the [3] key.
6. To erase the origin mark, select the mark number in the FUNCTIONS 1 menu by pressing the ENTER key and the [3] key repeatedly, and then press the [3] key once again.



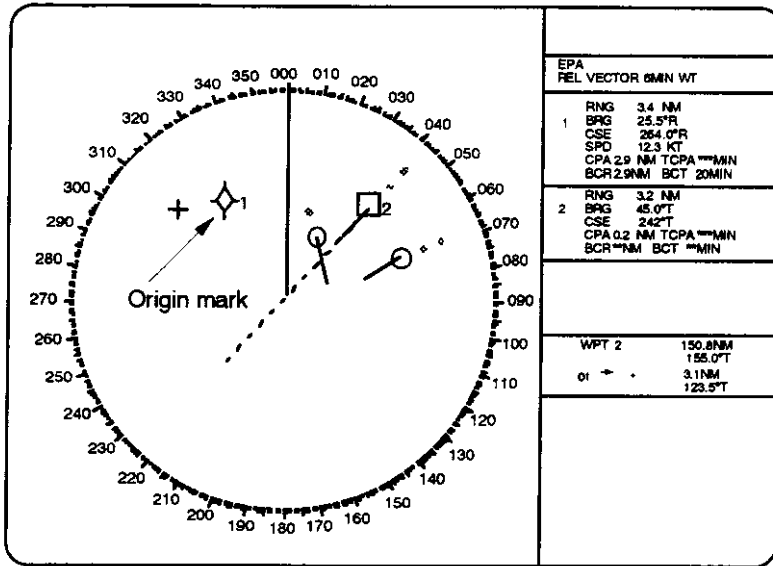

- Origin marks may be affixed with ID numbers or symbols corresponding to the keys in use.
- 1 Press the RADAR menu key and [0] [0] [2] [0] and [0] keys to show the RADAR 3 menu.
  - 2 Press the [5] key twice to select the number or symbol.
  - 3 Press the ENTER key to conclude your selection.

## 1.29 Zoom

The zoom function is available on the R-type radar only. This enlarges an area of interest as large as twice the normal viewing.

1. Place the cursor (+) close to the point of interest by operating the trackball.
2. Press the RADAR MENU to show FUNCTION 1 menu.
3. Press [5] key. The area around the cursor and own ship is enlarged twice as large as the original size and the label ZOOM appears at the lower-left corner of the screen.
4. To cancel zoom, press the [5] key again on the FUNCTIONS 1 menu.

**Note:** The zoom feature is inoperative when the display is off centered.

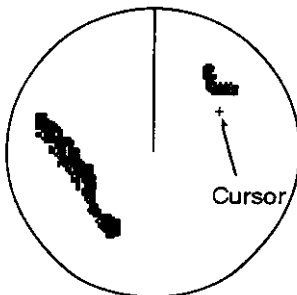

(a) Cursor placed at point of interest

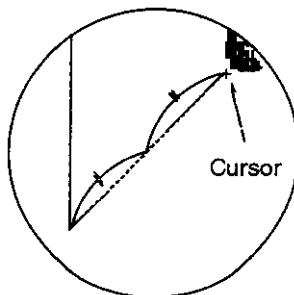

(b) Zoom in (R-type only)

## 1.30 Markers

### Heading marker and heading line

The heading marker and the heading line indicate the ship's heading in all presentation modes. The heading line is a line from the own ship position to the outer edge of the radar display area and appears at zero degrees on the bearing scale in head-up mode centered; it changes the orientation depending on the ship orientation in north-up and true motion modes. The heading marker appears as a small circle on the bearing scale to indicate the heading when the display is off-centered or is in north-up or TM mode.

### Temporarily erasing heading line

To temporarily extinguish the heading line to look at targets existing dead ahead of own ship, press the HL OFF key. The heading line reappears when the key is released.

### North marker

The north marker appears as a short dashed line. In the head-up mode, the north marker moves around the bearing scale in accordance with the compass signal.

### Stern marker

The stern marker (a dot-and-dash line) appears opposite to the heading line. This marker can be displayed provided that STERN MK ON is selected on the RADAR 2 menu.

## 1.31 Menu Keys

Three menu keys are provided on the right hand corner of the control head, RADAR MENU, PLOT MENU and NAV MENU keys.

**RADAR MENU:** Permits setting of basic radar parameters.

**PLOT MENU:** Permits setting of Electronic Plotting Aids (EPA) parameters or the optional ARPA ARP-26.

**NAV MENU:** Provides a choice of navigation data for on-screen display. Also selects display data for the optional Video Plotter.

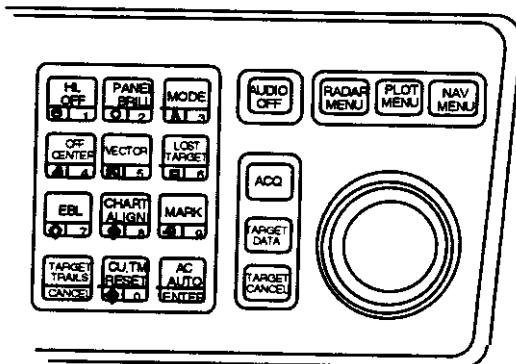

Note: Menu automatically goes off in 30 seconds if you do not press any key.

## 1.32 RADAR 1, 2 and 3 Menu Settings

Press [RADAR MENU] key.



[FUNCTIONS 1]	
1	TARGET TRAILS
2	GUARD ALARM           1 or 2
3	ORIGIN MARK           1 to 10
4	INDEX LINES
5	ZOOM .....<R-TYPE ONLY>
6	PULSE WIDTH
7	INT REJECT
8	ARPA
9	VIDEO PLOT
0	[FUNCTION 2]

↓ Press [0] key.

[FUNCTIONS 2]	
1	[FUNCTIONS 1]
2	BKGD COLOR           BLK(GRN CHAR)/ BLK(RED)/ BLU (ECHO AREA) BLU/ BRT BLU
3	ECHO STRETCH       OFF/1/2/3
4	ECHO AVERAGE      OFF/1/2/3
5	ECHO COLOR       YEL/GRN
6	SHIP SPEED           LOG/NAV*/MAN
7	SET, DRIFT           OFF/MAN SET = xxx.x° DRIFT = xx.xKT
8	INDEX LINES         NO. 2 VRM/MAN MAN = XX.XX NM
9	BRILLIANCE (1)
0	[FUNCTION 3]

2 Background color - Character color

BLACK ... Green character

BLACK ....Red character

BLUE .....Display area

BLUE

BRIGHT BLUE

\* 5 ECHO COLOR: Plus Color echoes in R-type

\* 6 NAV available in R-type

[FUNCTIONS 3]	
1	[FUNCTIONS 2]
2	RADAR 1
3	FUNCTION KEY 1
4	FUNCTION KEY 2
5	FUNCTION KEY 3
6	FUNCTION KEY 4
7	RADAR               1/2
8	
9	GYRO SETTING       EBL = xx.x°
0	[FUNCTIONS 4]

7 RADAR: Select 1 for single radar installation or for connecting to antenna NO. 1 on dual radar installation. , 2 for connecting to antenna NO. 2 on dual radar installation.

↓ Press [2] key.

[RADAR 1]	
1	[FUNCTIONS 3]
2	
3	
4	
5	
6	TRAIL               REL/TRUE

7 TRAIL	SGL/MULT
8 [PULSE WD 1]	
9 [PULSE WD 2]	
0 [RADAR 2]	

↓ Press [0] key.

	[RADAR 2]
1 [RADAR 1]	
2 + CURSOR	REL/TRUE
3 NOISE REJ	OFF/ON
4 STERN MK	OFF/ON
5 SHIP MK	OFF/ON
6 ALARM	*
7	
8 AUDIO ALARM	L/M/H
9 2ND ECHO REJ	OFF/ON
0 [RADAR 3]	

↓ Press [0] key.

	[RADAR 3]
1 [RADAR 2]	
2 BARGE MK	OFF/ON
3 BARGE SIZE	LENGTH=XXX ft WIDTH = xx ft
4 [BARGE INFORMATION]	
5 ORIGIN MK DISP	NO/SYMBOL
6 ORIGIN MK STAB	GND/SEA
7 ANTENNA REVOLUTION	LOW/HIGH
8 RADAR NO.	1/2
9 TUNE	MAN/AUTO
0 TUNE INITIALIZE	

4 STERN MK OFF/ON in R-type

5 SHIP MARK in R-type

6 ALARM: OFF for off-zone alarm in R-type only

7 KEY BEEP: Key beep sound level in R-type only

8 AUDIO ALARM level: 65/70/80 dB(A)

## 1.33 Function Keys

The four function keys (#1-4) on the control head serve for a macro function to instantly select a combination of assigned functions or settings. The function keys provide optimum radar settings for a specific purpose with a single key operation.

Each function key can be assigned a combination of particular radar settings that will be most suited to your specific navigating purpose, and an adhesive label (such as BUOY, HARBOR, COAST or the like) is usually attached to the key top for easy identification of the assigned purpose.

The individual function keys are preset, or programmed, for the following purposes by qualified service personnel at the time of installation using the procedures described in the succeeding paragraphs:

Function keys #1, #2 and #3: Picture setup and specific operation

Function key #4: Specific operation or watch alarm

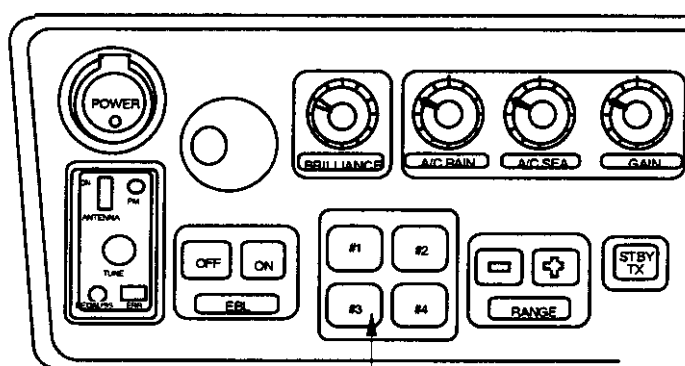

### FUNCTION KEYS

- #1: SET-UP 1
- #2: SET-UP 2
- #3: SET-UP 3
- #4: SET-UP 4

### 1.33.1 Picture setup

Suppose that you have been navigating along a coast for hours and now you are approaching a harbor, your final destination. You will have to adjust your radar to change from the settings for coastal navigation to those for harbor approach. Every time your navigating environment or task changes, you must adjust the radar, which can be a nuisance in a busy situation. Instead of changing radar settings case by case, it is possible to assign the function keys to provide optimum settings for often encountered situations.

The radar's internal computer offers several picture setup options to be assigned to each function key for your specific navigating requirements. For instance, one of the function keys may be assigned the buoy detecting function and labeled BUOY on the key top. If you press this key, the radar will be instantly set for optimum detection of navigation buoys and similar objects and the label BUOY is shown at the left margin of the screen. If you re-press the same key, the radar returns to the previous settings.

The picture setup options assignable to any of the function keys are shown in the table below:

LABEL	DESCRIPTION	LABEL	DESCRIPTION
BUOY	Optimum setting for detecting navigation buoys, small vessels and other small surface objects	SHIP	Optimum setting for detecting vessels

SHORT	Optimum setting for short range detection using a range scale of 3 nm or less on calm seas	LONG	Optimum setting for long range detection using a range scale of 6 nm or larger
CRUISING	For cruising using a range scale of 1.5 nm or larger	HARBOR	Optimum setting for short range navigation in a harbor area using a range scale of 1.5 nm or less
COAST	For coastal navigation using a range of 12 nm or less	SEA	Transoceanic voyage using a range scale of 12 nm or larger
ROUGH SEA	Optimum setting for rough weather or heavy rain	RIVER	Optimum setting for navigation on a river

Each picture setup option defines a combination of several radar settings for achieving optimum setup for a particular navigating situation. Those involved are interference rejector, echo stretch, echo average, automatic anti-clutter, pulselength and noise rejector settings.

Adjusting these features on a function key menu changes the original function key settings. To restore the original settings for a particular function key, it is necessary to display the relevant function key menu and select appropriate menu options.

**Note:** Function key presetting requires a good knowledge of optimum radar settings. If you want to change the original function key settings, consult your nearest FURUNO representative or dealer.

### 1.33.2 Specific operation

Most often used controls are placed on the center panel while less often used controls are provided in the menu. To avoid opening the menus to set up the radar for a particular situation, function keys #1, #2, #3 and #4 may be assigned a combination of the following settings at the time of installation.

- Target trails (See paragraph 1.25.)
- Echo stretch 1,2 or 3 (See paragraph 1.22.)
- Pulselength 1 or 2 (See paragraph 1.11.)
- Echo averaging 1, 2 or 3 (See paragraph 1.23.)
- Echo color (See paragraph 1.32.)
- Panel illumination
- Marks brilliance
- Noise rejection

Provided that the function key is assigned the specific operation feature, press the key to instantly set the radar for the preset purpose. The corresponding label will be displayed at the left margin of the screen. If you re-press the function key, the radar returns to the previous settings.

### 1.33.3 Watch alarm

The watch alarm sounds an external buzzer at selected time intervals to help you keep regular watch of the radar picture for safety or other purposes. This feature can be assigned to function key #4 with a choice of alarm intervals of 6, 10, 12, 15 and 20 minutes. (See the flowchart for keystroke sequence.)

Provided that function key #4 is assigned the watch alarm feature, just press function key #4 to activate the feature. The label WATCH appears at the lower-left corner of the screen associated with a watch alarm timer counts down from the initial value (e.g., "12:00").

When a preset time interval has elapsed, an audible watch alarm is released and the screen label WATCH turns red and the watch alarm timer freezes at "0:00."

To silence the alarm, press the AUDIO key. The label WATCH turns to normal color and the watch alarm timer is reset to the initial value and starts the count-down sequence again.

If you press the AUDIO OFF key before the selected time interval is reached, the watch alarm timer is reset to the initial value and starts the count-down sequence again.

### 1.33.4 Setting for function keys #1/#2/#3

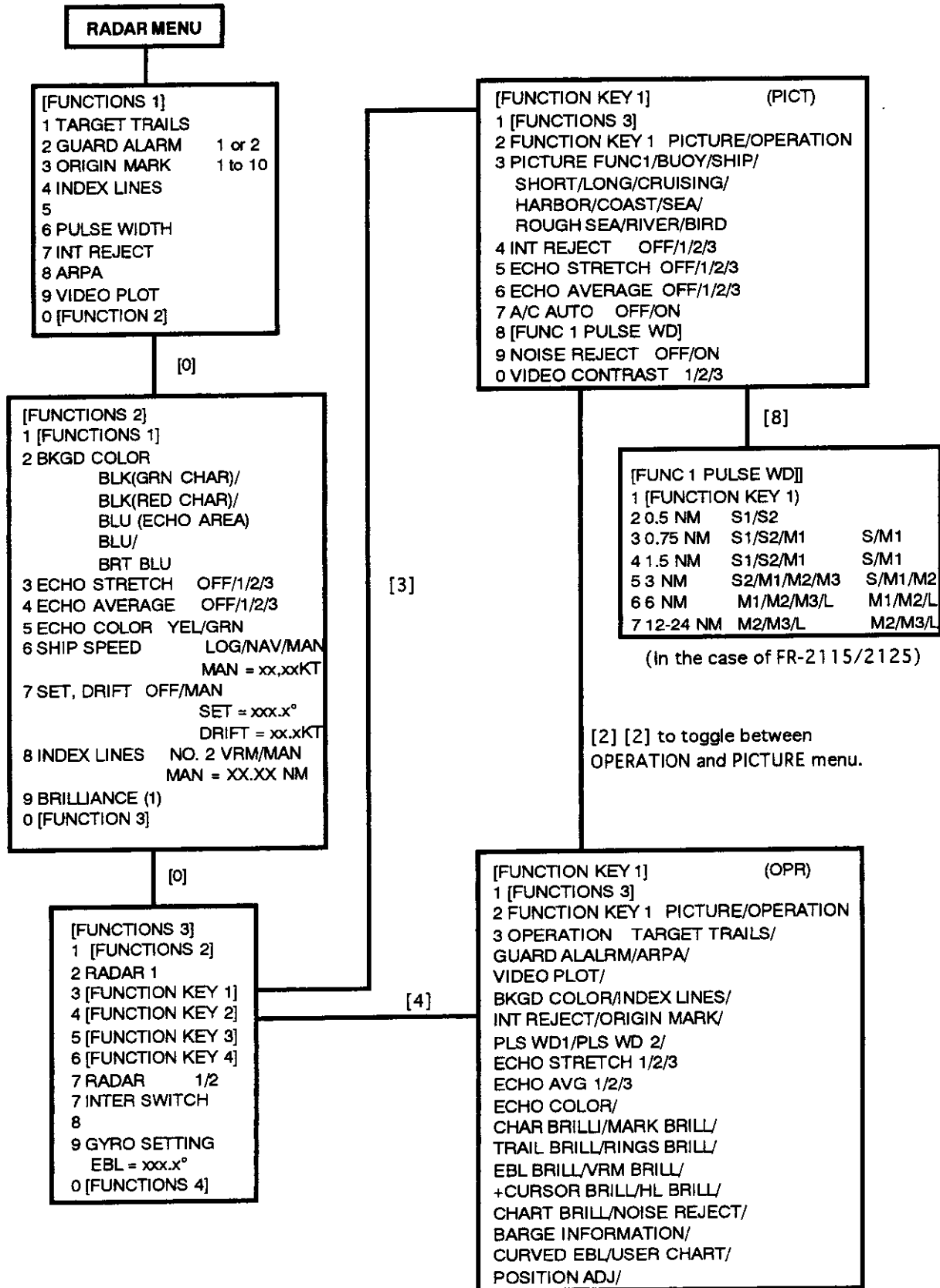



### Picture setup default for Function Keys 1, 2 and 3

	4. INT Reject	5. ES	6. ES	7. A/C Auto	9. Noise Rejector	P/L on 0.5 nm	P/L on 0.75 nm	P/L on 1.5 nm	P/L on 3 nm	P/L on 65 nm	P/L on 12-24 nm
RIVER	2	1	OFF	OFF	OFF	S	S1	S1	S2	M1	M2
BUOY	3	2	3	OFF	ON	S1	S2	S2	M1	M2	L
SHIP	3	2	3	OFF	ON	S1	S2	S2	M1	M2	L
SHORT	2	OFF	OFF	OFF	OFF	S1	S1	S1	S2	M1	M2
LONG	3	2	3	OFF	ON	S1	S1	S1	S2	M1	M2
CRUISING	3	OFF	3	OFF	ON	S2	S2	S2	M2	L	L
HARBOR	3	OFF	OFF	OFF	OFF	S1	S1	S1	S2	M1	M2
COAST	2	OFF	OFF	OFF	OFF	S1	S1	S2	M1	L	L
OCEAN	2	OFF	3	OFF	OFF	S1	S2	S2	M1	M2	L
ROUGH SEA	2	OFF	2	ON	OFF	S1	S1	S2	M1	M2	L

### 1.33.5 Setting for function key #4

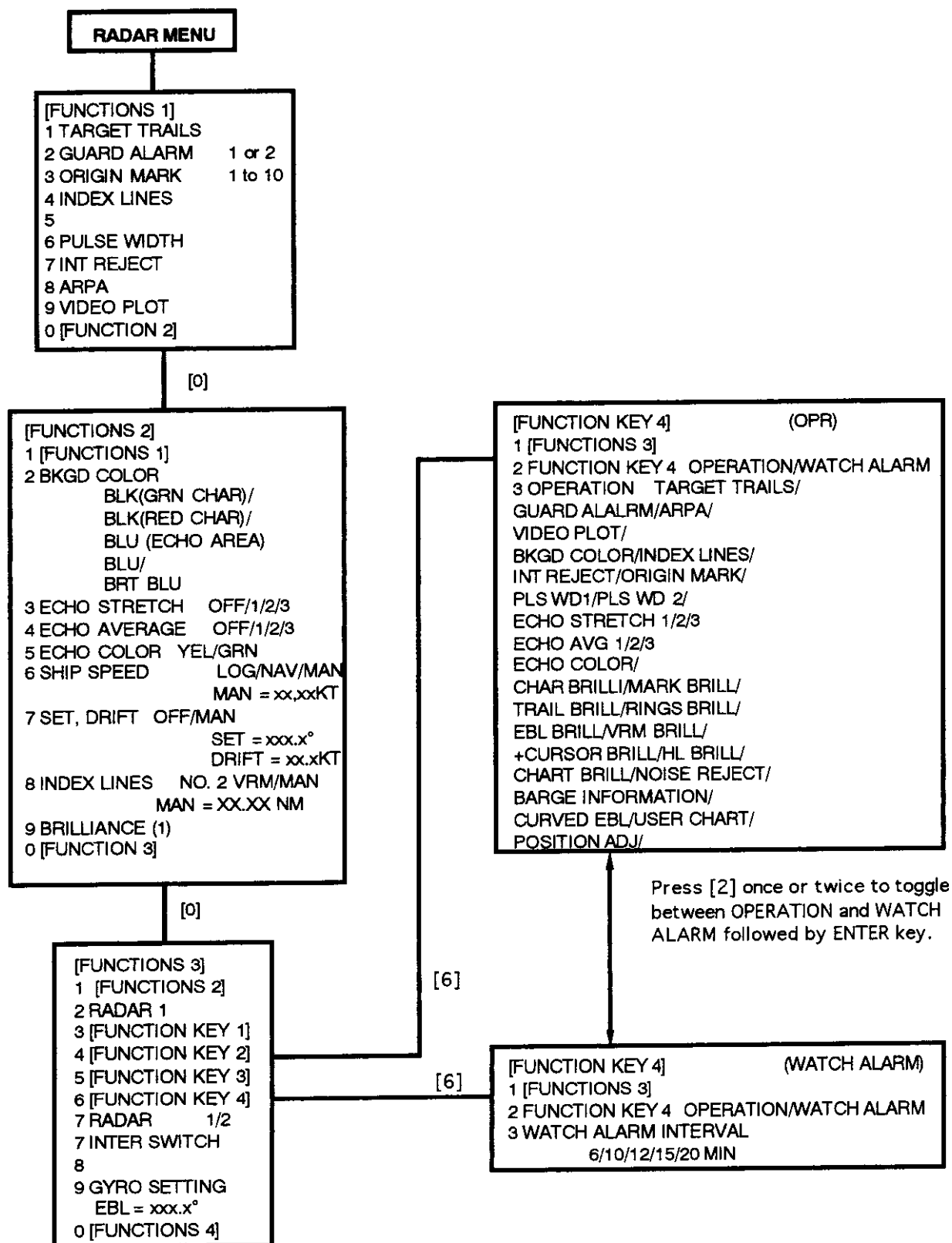

## 1.34 Barge information

Do the following to display the barge information. This function is not available in all radar.

1. Press the RADAR MENU, [0],[0],[2],[0] and [0] to reach the RADAR 3 menu.
2. Press [2] key twice to select BARGE MK ON, followed by the ENTER key.
3. Press [3] key to select BARGE SIZE and enter length and width of a barge, followed by the ENTER key.
4. Press [4] key to display BARGE INFORMATION menu.
5. Enter number of barges in first row, followed by the ENTER key.
6. Enter the number of barges for 2nd, 3rd, 4th and/or 5th row followed by the ENTER key. The barge information appears on the radar display.

## 1.35 Radar Map

A radar map is a combination of map lines and symbols whereby the user can define and input the navigation, route planning and monitoring data on the radar equipment. Map lines are navigational facility whereby the observer can define lines to indicate channels or traffic separation schemes. Also called **nav lines**, these lines can be ground stabilized to stop them drifting. (Definition in Annex C of IEC 60936-1 and IEC 60872-1)

In this series of radar, a radar map may contain 150 points of mark and line data on one map. 10 maps can be memorized to facilitate the repeated use on the routine navigation area.

The user can create a radar map on-real time base while using the radar for navigation or at leisure time at anchor or while the radar is not being used. Place of a map can be made for any waterways part from the actual own ship location. The map data is stored on EEROM card which is mounted on the main processor board socket. When the optional Video Plotter board RP-26 and RAM card installed in the display unit, much more data can be created and copied to another card.

### General operation procedure:

Press the NAV MENU key to show the NAV INFORMATION 1 menu.

Press [2] key to select the SELECT NAVAID operation.

Press [3] key again to select navigation data input device, followed by the ENTER key.

Enter other nav data parameters as appropriate referring to the operation flow shown on the

NAV MENU key to close the NAV INFORMATION menu.

The radar display requires an input from radionavigational equipment such as a GPS receiver with the data format as defined by IEC 61162-1.

Depth, water temperature are not displayed when relevant sensors are not used. If these are used for displaying another target data.

### Waypoint and Navigation line

Another waypoint can be displayed by setting WAYPOINT and to display the menu, press the NAV MENU and [8], [2] for the line.

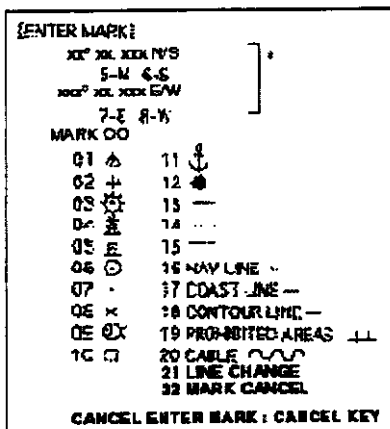

^ These appear when a position is entered.

Note: When the waypoint is more than 5000 nm away from own ship, the data shows ">5000 nm".

### 1.35.2 Making a radar map

1. Press the NAV MENU key to display the NAV INFORMATION 1 menu.
2. Press the [2] key twice to set MAP ON, then press the ENTER key.
3. Press the [8] key to select the MAP DISP SELECT menu.

[MAP DISP SELECT]	
1 [RADAR MAP]	
2 DANGER HIGHLIGHT	OFF/ON
3 COAST LINE	OFF/ON
4 MARK	OFF/ON
5 NAV LINE	OFF/ON
6 PROHIBITED AREAS	OFF/ON
7 BUOY	OFF/ON
8 CONTOUR LINE	OFF/ON
9 WPT MARK	OFF/ON

4. Press appropriate numeric key twice to select ON, then press the ENTER key.
5. Press the NAV MENU key to close the menu.

### Mark entry mode

Marks can be entered in 3 different ways.

1. Press the NAV MENU key to display the NAV INFORMATION 1 menu.
2. Press [1] key to display the RADAR MAP menu.
3. Press [6] key and further [6] key to select the entry mode - cursor, L/L or own ship position.
4. Press the ENTER key followed by the NAV MENU key.
5. Press the MARK key to read the following legends.

3. Press the NAV MENU key to leave the menu.

Press [NAV MENU] key.

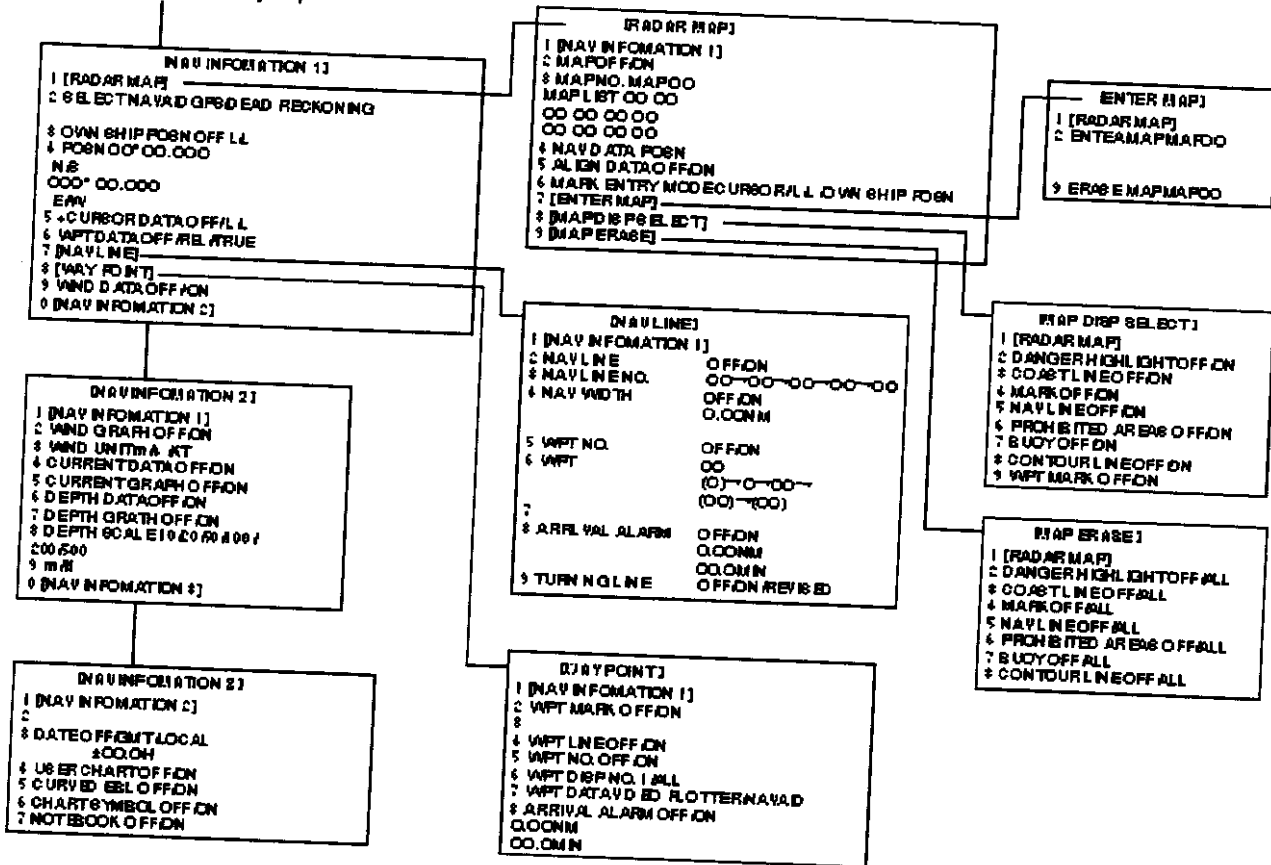

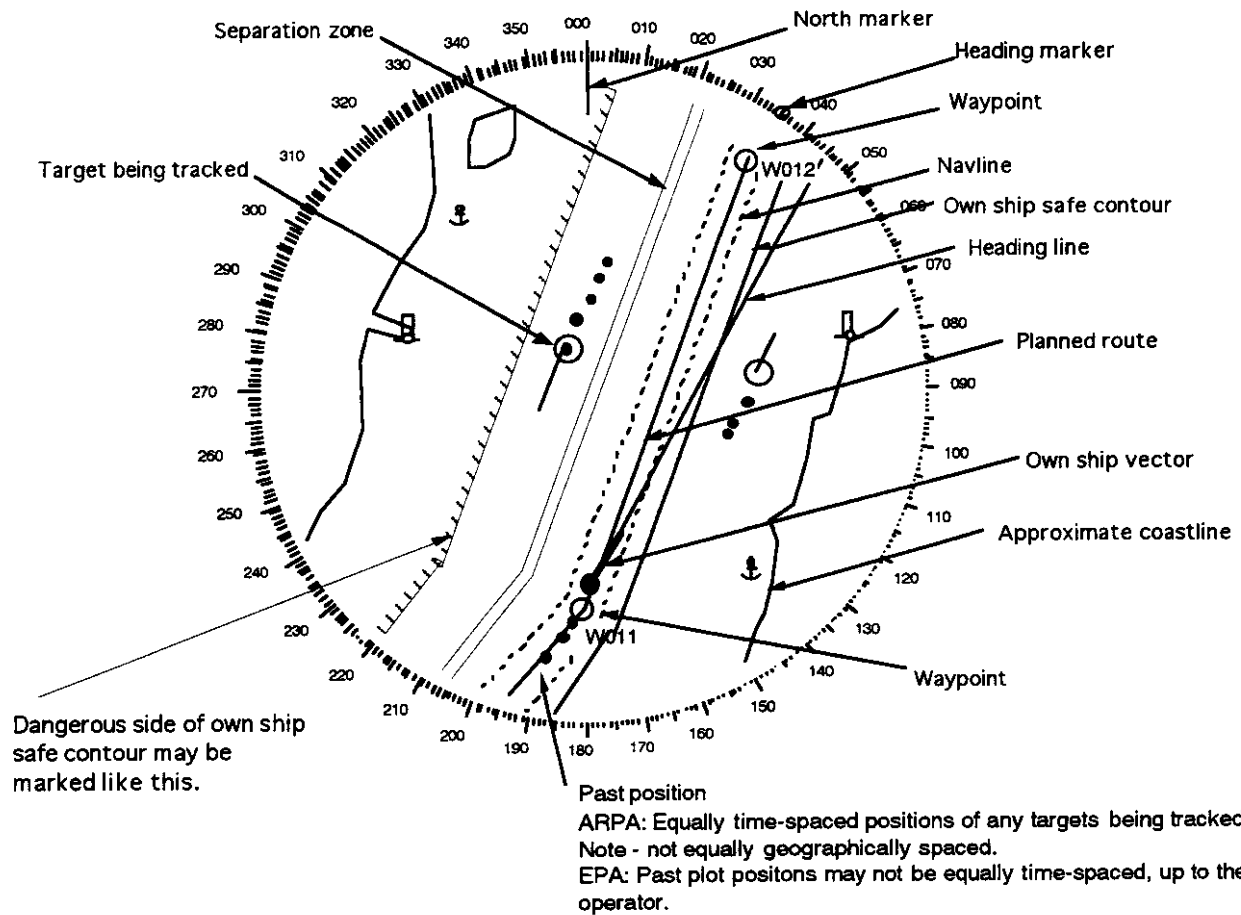

**Concept of Radar map, Ground stabilized**

(Above excludes radar pictures. In reality, radar echoes are always displayed)

4. Press [1] and [7] key in order to display the NAV LINE menu.
5. Press [4] key twice to select NAV WIDTH ON and enter navigation width in nautical mile.
6. Press the ENTER key followed by the NAV MENU key.

**1.35.5 Erasing contents of a radar map**

1. Press the NAV MENU, [1] and [9] key to display MAP ERASE menu.
2. Press a wanted number key twice to select ON or ALL, followed by the ENTER key.

[MAP ERASE]	
1 [RADAR MAP]	
2 DANGER HIGHLIGHT	OFF/ALL
3 COAST LINE	OFF/ALL
4 MARK	OFF/ALL
5 NAV LINE	OFF/ALL
6 PROHIBITED AREAS	OFF/ALL
7 BUOY	OFF/ALL
8 CONTOUR LINE	OFF/ALL
9 WPT MARK	OFF/ALL

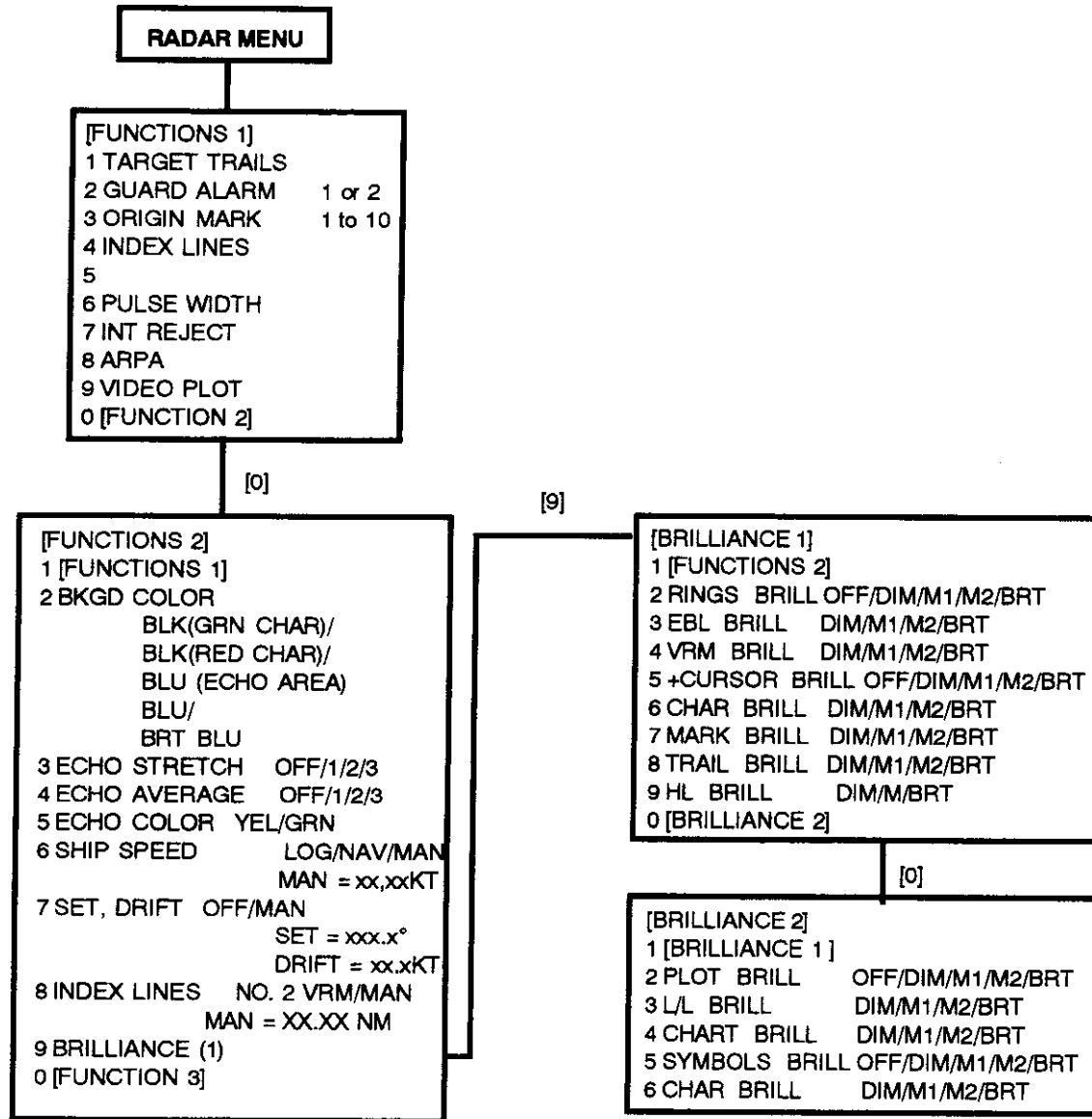

The table below describes which menu item adjusts the brilliance of which picture element.

Menu Item	Functions adjusted	Menu Item	Functions adjusted
RINGS	Fixed range rings	EBL	Electronic bearing lines NO. 1, 2
VRM	Variable range markers NO. 1, 2	+ CURSOR	Trackball controlled cursor
CHAR	Alphanumeric readouts	MARKS	Bearing scale
TRAILS	Target trails	HL	Heading Line and stern marker
PLOT	Plots for EPA and ARP-26	L/L	Latitude and longitude grid lines
CHART	Charts		

**Note:** You should adjust the entire CRT brilliance by operating the BRILLIANCE control before adjusting the respective brilliance levels on the BRILLIANCE 1 and 2 menu.

## 1.36 Suppressing Second-trace Echoes

In certain situations, echoes from very distant targets may appear as false echoes (second-trace echoes) on the screen. This occurs when the return echo is received one transmission cycle later, that is, after a next radar pulse has been transmitted.

To activate or deactivate the second-trace echo rejector:

- .1 Press the RADAR MENU, [0], [0], [2] and [0] key to show the RADAR 2 menu.
- .2 Press the [9] key to select menu item 2ND ECHO REJ option.
- .3 Further press the [9] key to activate (ON) or deactivate (OFF) the second-trace echo rejector.
- .4 Press the ENTER key to conclude selection followed by the RADAR MENU key to close the RADAR menu.

## 1.37 Adjusting Brilliance of Screen Data

You can adjust relative brilliance levels of various marks and alphanumeric readouts displayed on the screen by the steps below:

- .1 Press the RADAR MENU key to show the FUNCTIONS 1 menu.
- .2 Press the [0] and [9] key to show the BRILLIANCE 1 menu. To display the BRILLIANCE 2 menu, further press the [0] key.
- .3 Select a desired menu item by pressing the corresponding numeric key. As an example, press [8] in the BRILLIANCE menu if you want to change the brilliance of echo trails.
- .4 Further press the same numeric key as you pressed in step 3 above to select or highlight a desired brilliance level.
- .5 Press the ENTER key to conclude your selection followed by the RADAR MENU key to close the FUNCTIONS menu.



## 1.38 Display of ancillary information

Wind and tide data and depth sounding data can be displayed in the text cell which is normally used to indicate third target ship data. Do as below:

1. Press the NAV menu to show the NAV INFORMATION 1 menu.
2. Press [9] key twice to set WIND DATA ON and press the ENTER key.
3. Press [0] key to show NAV INFORMATION 2 menu.
4. Press [2] key twice to set WIND GRAPH ON and press the ENTER key.
5. Do the same to indicate ocean current graph and echo-sounding chart. Depth scales can be selected among 10, 20, 50, 100, 200 and 500 m.
6. Press [0] key to show the NAV INFORMATION menu.
7. To indicate the date and time in UTC, press [3] key twice or three times to select UTC and press ENTER key.
8. To indicate the local time, press [3] key twice or three times and press ENTER key twice. Enter time difference between UTC and local time, followed by the ENTER key.

Note: Wind data and current data require the respective sensors. The depth data requires an adequate echo-sounding equipment. The echogram shows the last 30 minutes of depths along the ship's track. Wind vector shows a direction from which the wind blows in, relative to own ship heading, and labeled T\*. Wind velocity is a true wind speed as a result of compensating for own ship's speed and orientation. Ocean current (tide) is the direction to which the current is flowing away from os position, relative to north.

\* T in this case means an true value meanwhile T denotes "relative to True North" in the case of EBLs and target ship vectors.

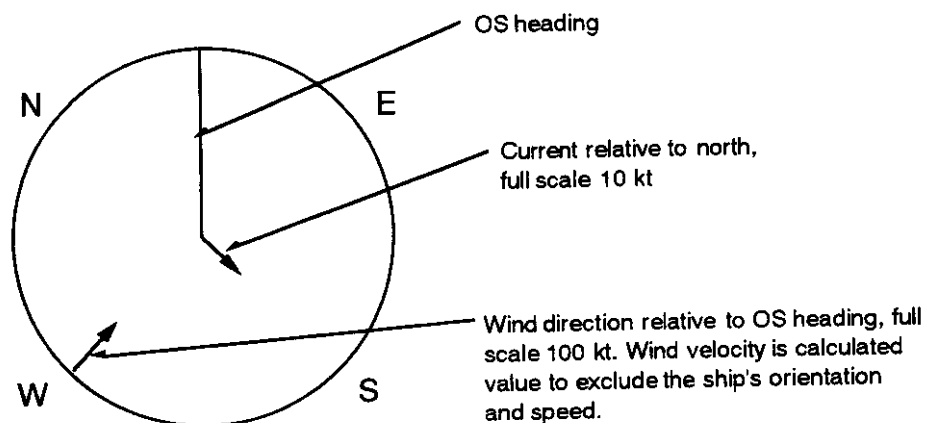

Example of Head-up mode

## 1.39 Alarms

The table below summarizes alarms which may occur at various warning conditions.

Fault	Audible alarm	Visual alarm	To quit alarm status
Gyro failure	2 beeps	HDG label reads "***.*" and the message SET HEADING appears at the lower-left corner of the screen. SYSTEM FAILURE GYRO in red. Display is automatically switched to head-up mode within 1 min (IEC 60936-1/3.12.2.1).	Match the on-screen HDG readout with the actual compass reading, if necessary. Then, press the Cancel key to erase the message SET HEADING.
Target alarm (TAZ)	beeps	Target flashes.	Press [2] key on Function 1 menu (Section 1.20).
Watch alarm	beeps	WATCH 0:00 (Label WATCH turns red and time count freezes at 0:00).	Press the AUDIO OFF key. The label WATCH turns to normal video and the timer is reset (Section 1.32.3).
Own ship lat/lon Cursor lat/lon	none	"***.*" In own ship position field "***.*" In cursor position field	Make sure that own ship position data is fed from external radionav equipment.
System failure	none	Message BRG SIGNAL MISSING at screen bottom. No radar echoes. SYSTEM FAILURE in red at the lower left of the display during test.	Make sure the antenna switch in the tuning compartment is on.
Incorrect keystroke	double beep tone	none	Correct keystroke is responded by a single beep provided that KEY BEEP ON is selected in initial settings.
Log failure	2 beeps	LOG *.* and SYSTEM FAIL LOG appear, if no log signal is input for 30 s while the ship speed has been more than 5.0 kt or for 3 min below 0.1 kt.	If the SDME has failed, use the Manual Speed mode or other appropriate sensor.



# Chapter 2 OPERATION OF ARPA (Option)

## 2.1 General

The FR-2105 series radar can accommodate an ARPA (Automatic Radar Plotting Aid) module ARP-26 complying with IMO A.823 and IEC 60987-1. This chapter describes the operation of the ARPA. For operation of normal radar, refer to Chapter 1.

### Principal specifications

#### Acquisition and tracking

- Automatic acquisition of up to 20 targets plus manual acquisition of 20 targets, or fully manual acquisition of 40 targets between 0.2 and 32 nm. Manual acquisition has a priority over automatic acquisition. Therefore, if 30 targets have been manually acquired, the capacity for automatic acquisition is 10 targets.
- The ARPA automatically tracks all acquired targets, whether manually or automatically acquired, between 0.1 and 32 nm (0.1 and 24 nm depending on initial setting). Manually acquired targets are indicated in bold symbols and the automatically acquired targets, in thinner symbols.

Vector length: 0.5, 1, 2, 3, 6, 12, 15, 30 min.

Orientation: True velocity or relative velocity

Stabilization: Sea or Ground as selected with Vector key.

Motion trend: Displayed within 1 min, full accuracy within 3 min after acquisition.

Past positions: Choice of 5, 10 or 20 past positions at intervals of 30 s, 1, 2, 3 or 6 min.

Alarms: Visual and audible alarms against targets violating CPA/TCPA limits, lost targets, targets crossing guard zone, system failure and target full status.

Trial maneuver: Predicted situation appears in 1 min after selected delay (1-60 minutes).

## 2.2 Keypads for ARPA

The ARPA uses the keys on the plotting keyboard on the right side of the radar screen and two keys on the control head.

**PLOT MENU:** Shows/hides ARPA menus.

**Plot Symbol keys:** Select specific plot symbols for manually acquired targets.

**TARGET CANCEL:** Terminates tracking of a single target specified by the trackball if the key is pressed with a hit-and-release action. If the key is held depressed for about 3 seconds, tracking of all targets is terminated.

**ENTER:** Registers menu options selected.

**VECTOR:** Selects true or relative presentation of target vectors.

**TARGET DATA:** Displays data on one of tracked targets selected by the trackball.

**LOST TARGET:** Silences the lost target aural alarm and erases the lost target symbol.

**ACQ** (on control head): Manually acquires a target.

**AUDIO OFF** (on control head): Silences aural alarm.

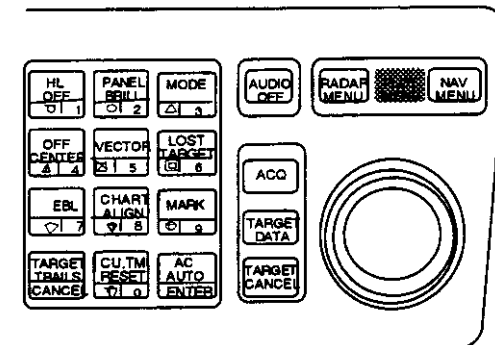

*Plotting keypad*

## CRITERIA OF TRACKING

A target measuring 800 m or more in the radial or circumferential direction is regarded as a landmass and not acquired or tracked. Echoes smaller than 800 m are regarded as targets to be tracked.

## 2.3 ARPA Menu Operation

To activate ARPA function;

1. Press the RADAR MENU key.
2. Press [8] key to select ARPA, instead of EPA.

Note that the label ARPA appears in the upper-right box on the screen.

Various parameters for the ARPA are set on the ARPA 1 and ARPA 2 menus. To do this, follow the steps shown below:

1. Press the PLOT MENU key to show the ARPA 1 menu.
2. Press the [0] key once if you wish to go to the ARPA 2 menu.
3. Select a desired menu item by pressing the corresponding numeric key.

4. Select a menu option by pressing the same numeric key as pressed in step 3 above. If there is more than one option on the current menu item, you may need to press the numeric key several times. Press it until the desired option is highlighted. (Note that certain menu items will prompt you to enter numeric data or to define points on the radar screen with the trackball.)
5. Press the ENTER key to register settings.
6. Press the PLOT MENU key to close the menu.

Press [PLOT MENU] key.



[ARPA 1]	
1 VECTOR TIME	30SEC/1/2/3/6/12/15/30MIN
2 AUTO ACQ	OFF/ON
3 AUTO ACQ AREA	3 6/SET *
4 GUARD ZONE	OFF/ON
5 GUARD ZONE SET **	
6 TARGET BASED SPEED 1 OR 2 OR 3	
7 REFERENCE TARGET VECTOR	OFF/ON
8 COLLISION ALARM	CPA x.xKT TCPA xx.xMIN
9 TRIAL MANEUVER	
0 [ARPA 2]	

\* SET opens the [AUTO ACQ AREA SET] submenu which reads:

- 1 [ARPA1]
- 2 1/2 SET LEFT/RIGHT BOUNDARY  
CANCEL PREVIOUS AREA: CANCEL KEY

\*\* This submenu reads:

- 1 [ARPA 1]
- 2 1/2 SET LEFT/RIGHT BOUNDARY  
CANCEL PREVIOUS AREA: CANCEL KEY

↓ Press [0].

[ARPA 2]	
1 [ARPA 1]	
2 TRIAL MODE	STATIC/DYNAMIC
3 HISTORY POINTS	5/10/20
4 HISTORY INTVL	30SEC/1/2/3/60MIN
5 MARK SIZE	STD/LARGE
6 GUARD, ACQ STABILIZE	NORTH/CRT
7	
8 INPUT SIG CHECK	
9 ARPA TRACK TEST	
0 [ARPA INITIAL SETTING]	

## 2.4 Start-up Procedure

### Entering own ship's speed

The ARPA requires own ship's speed and heading data. The speed can be entered automatically from a speed log (SDME, Speed and Distance Measuring Equipment), navaid, or by referencing to a target-based speed (based on 3 max. stationary objects). Manual input is also possible.

### Automatic speed input

For speed log input:

1. Press the RADAR MENU key and [0] key to show the FUNCTIONS 2 menu.

Press [RADAR MENU] key.

↓

[FUNCTIONS 1]	
1	TARGET TRAILS
2	GUARD ALARM            1 or 2
3	ORIGIN MARK            1 to 10
4	INDEX LINES
5	
6	PULSE WIDTH
7	INT REJECT
8	ARPA
9	VIDEO PLOT
0	[FUNCTION 2]

↓ Press [0] key.

[FUNCTIONS 2]	
1	[FUNCTIONS 1]
2	BKGD COLOR            BLK(GRN CHAR)/ BLK(RED)/ BLU (ECHO AREA) BLU/ BRT BLU
3	ECHO STRETCH        OFF/1/2/3
4	ECHO AVERAGE      OFF/1/2/3
5	TARGETS COLOR      YEL/GRN
6	SHIP SPEED            LOG/NAV/MAN
7	SET, DRIFT            OFF/MAN SET = xxx.x° DRIFT = xx.xKT
8	INDEXLINES            NO. 2 VRM/MAN MAN = XX.XX NM
9	BRILLIANCE (1)
0	[FUNCTION 3]

2 Background color - Character color

BLACK ... Green character

BLACK ....Red character

BLUE .....Display area

BLUE

BRIGHT BLUE

\* 5 ECHO COLOR: Plus Color echoes in R-type

2. Press the [6] key to select menu item SHIP'S SPEED.

3. Press the [6] key to select (or highlight) LOG option.

4. Press the ENTER key to conclude your selection followed by the RADAR MENU key to close the FUNCTIONS 2 menu. The ship's speed readout at the top of the screen shows own ship's speed fed from the speed log preceded by the label "LOG."

#### Notes:

- 1) IMO Resolution A.823(19) for ARPA recommends that a speed log to be interfaced with an ARPA should be capable of providing through-the-water speed data (forward speed).
- 2) Be sure not to select LOG when a speed log is not connected. If the log signal is not provided, the ship speed readout at the top of the screen will be blank. In the event of a log error, you can continue plotting by entering a manual speed.
- 3) If a log signal interval becomes more than 30 seconds with the ship's speed 5 kt or more, the radar regards the speed log is defective and LOG FAIL appears, reading xx.x KT. If no speed input is present for 3 minutes at below 0.1 kt, the radar regards the log is defective.

#### Manual speed input

To manually enter the ship's speed with the numeric keys:

1. Press the RADAR MENU key and [0] key to show the FUNCTIONS 2 menu.

2. Press the key [6] to select menu item SHIP'S SPEED.
3. Press the key [6] to select (or highlight) MAN option.
4. Press the ENTER key to conclude your selection. At this point, "MAN = xx.x KT" appears at the bottom of the FUNCTIONS 2 menu.
5. Enter the ship speed by hitting corresponding numeric keys followed by the ENTER key without omitting leading zeroes, if any. As an example, if the ship speed is 8 knots, press [0] [8] [ENTER]. For 4.5 knots, [0] [4] [5] [ENTER].
6. Press the RADAR MENU key to close the FUNCTIONS 2 menu. The ship speed readout at the screen top shows own ship's speed you entered preceded by the label "MENU."



### Target-based speed

The use of target-based speed is recommended when:

- The speed log is not operating properly or not connected to the radar.
- The vessel has no device which can measure ship's leeward movement (Doppler sonar, speed log, etc.) when leeward movement can not be disregarded.

If you select target-based speed, the ARP-26 calculates own ship's speed relative to a fixed reference target. The number of targets may be 1, 2 or 3. They appear as tracked targets, each shown in a small circle, but without a vector. When a plural of objects are selected, the mean value is used for stabilization and speed. Select the number in [PLOT MENU], see section 2.3.

1. Select a small fixed island or any radar prominent point located at 0.2 to 24 nm from own ship.
2. Place the cursor (+) on the target by operating the trackball.
3. Press the PLOT MENU key and [6] key followed by the ENTER key.  
The reference target mark (see below) appears at the cursor position and the own ship data label changes from "LOG," "NAV" or "MENU" to "REF." Note that it takes 60 scans or approximately 1 min before a new speed is displayed. If tracking has failed for a reference target, the target is marked with a lost target mark (symbol formed with two triangles).

 R changes to  R in 60 scans

#### Notes:

- 1) When the reference target is lost or goes out of the acquisition range, the reference target mark blinks and the speed reads "xx.x." Select a different reference target in this case.
- 2) When all targets are deleted, the reference target mark is also deleted and the target-based speed becomes invalid. The speed is indicated in KTBT where BT means Bottom Track (speed over ground).
- 3) The vector of the reference target can be displayed by menu operation (ARPA 1 menu).

### Canceling target-based speed

To cancel the target-based speed, the PLOT MENU and [6] key. The speed is shown by LOG, NAV\* or MANUAL as selected previously.

### Deactivating the ARPA

To deactivate the ARPA, press the RADAR MENU key and [8] key twice followed by the ENTER key. Target plotting symbols and the on-screen label ARPA will disappear. The label EPA appears.



## 2.5 Automatic Acquisition

The ARPA can acquire up to 40 targets (20 automatically and 20 manually or all 40 manually). If AUTO ACQ is selected after more than 20 targets have been manually acquired, only the remaining capacity of targets can be automatically acquired. For example, when 30 targets have been acquired manually, then the ARPA is switched to AUTO ACQ. Only 10 targets can be acquired automatically.

A target just acquired automatically is marked with a broken square and a vector appears within 20 scans of antenna to indicate the target's motion trend. Within 60 scans, the initial tracking stage is finished and the target becomes ready for stable tracking. At this point, the broken square mark changes to a solid circle. (Targets automatically acquired are distinguished from those acquired manually, the targets which are acquired manually are displayed by bold symbol.)

### Enabling and disabling auto acquisition

1. Press the RADAR MENU key and [8] key twice followed by the ENTER and RADAR MENU key if the ARPA is not yet activated. Note that the label ARPA appears in the box at the upper-right on the screen.
2. Press the PLOT MENU key to show the ARPA 1 menu.

[ARPA 1]	
1 VECTOR TIME	30SEC/1/2/3/6/12/15/30MIN
2 AUTO ACQ	OFF/ON
3 AUTO ACQ AREA	3 6/SET *
4 GUARD ZONE	OFF/ON
5 GUARD ZONE SET **	
6 TARGET BASED SPEED 1 OR 2 OR 3	
7 REFERENCE TARGET VECTOR	OFF/ON
8 COLLISION ALARM	CPA x.xKT TCPA xx.xMIN
9 TRIAL MANEUVER	
0 [ARPA 2]	

3. Press the [2] key to select menu item AUTO ACQ.
4. Further press the [2] key to select (or highlight) ON (enable auto acquisition) or OFF (disable auto acquisition) as appropriate.
5. Press the ENTER key to conclude your selection followed by the PLOT MENU key to close the ARPA 1 menu. Note that the label AUTO+MAN is displayed in the box at the upper-right on the screen when auto acquisition is enabled; MAN when auto acquisition is disabled.

**Note:** When the ARPA has acquired 20 targets automatically, the message AUTO TARGET FULL is displayed in the box at the right-hand side of screen.

### Auto acquisition areas

Automatic acquisition is performed within 1 or 2 zones. Outside these zones is auto acquisition suppressed zones. The zones can be set at 3-3.5 n and/or 5.5-6.0 nm, or anywhere within 0.2 - 32 nm.

### Predefined auto acquisition areas (Menu item: 3 & 6 NM)

1. Press the PLOT MENU key to show the ARPA 1 menu.

2. Press the [3] key to select menu item AUTO ACQ AREA.
3. Further press the [3] key to select (or highlight) menu option 3, 6NM.
4. Press the ENTER key to confirm your selection followed the PLOT MENU key to close the ARPA 1 menu.

The illustration below shows how the auto acquisition areas are displayed on the screen. Up to 20\* targets within the auto acquisition areas are acquired automatically. There is no priority in picking up. It is recommended to use 2 zones on high speed craft.

\* If 30 targets have already been acquired manually in the MAN ACQ mode (AUTO OFF on ARPA 1 menu), only 10 more targets can be acquired automatically.

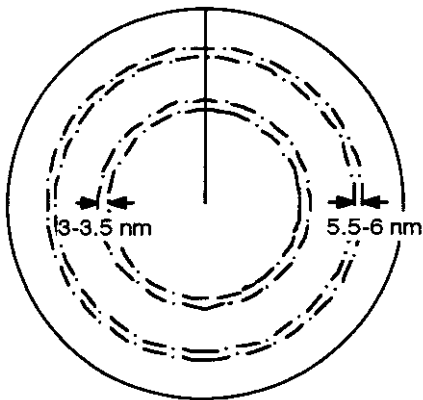

*Predefined auto acquisition areas*

### Free selection of acquisition zones (Menu item: SET)

To set auto acquisition areas with trackball:

1. Press the PLOT MENU key to show the ARPA 1 menu.
2. Press the [3] key to select menu item AUTO ACQ AREA.
3. Further press the [3] key to select (or highlight) SET option.
4. Press the ENTER key to conclude your selection. At this point the AUTO ACQ SETTING menu is displayed at the screen bottom.

```

[AUTO ACQ AREA SET]
1 [ARPA 1]
2 1/2

```

5. Press the [2] key to select menu item "1/2" and press the ENTER key. Then, you will see the message as shown below:

```

[AUTO ACQ SETTING]
1 [ARPA 1]
2 1/2

SET LEFT/RIGHT BOUNDARY
CANCEL PREVIOUS AREA: CANCEL KEY

```

6. Place the cursor at the outer counterclockwise corner of the area (point A) and press the ENTER key.

7. Place the cursor at the clockwise edge of the area (point B) and press the ENTER key.

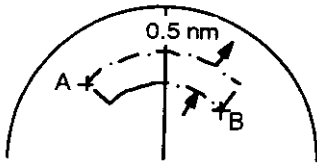

**Note:** If you wish to create an auto acquisition area having a 360-degree coverage around own ship, set point B in almost the same direction (approx.  $\pm 5^\circ$ ) as point A and press the ENTER key.

8. Repeat steps 5 to 7 above if you want to set another auto acquisition area with the trackball.
9. Press the [1] key followed by the PLOT MENU key to close the ARPA 1 menu.

An auto acquisition area like the example shown above appears on the display. Note that each auto acquisition area has a fixed radial extension (width) of 0.5 nm.

Note that the auto acquisition areas are preserved in an internal memory of the ARPA even when auto acquisition is disabled or the ARPA is turned off.

## Terminating tracking of targets

When the ARPA has acquired 20 targets automatically, the message AUTO TARGET FULL is displayed in the box at right-hand side of the screen and no more auto acquisition occurs unless targets are lost. You may find this message before you set an auto acquisition area. Should this happen, cancel tracking of less important targets or perform manual acquisition.

### Canceling individual targets

Place the cursor (+) on a target to cancel tracking by operating the trackball. Press the TARGET CANCEL key.

### Canceling all targets at a time

Press and hold the TARGET CANCEL key down more than 3 seconds. In the automatic acquisition mode, acquisition begins again.

## Discrimination between landmass and true targets

A target is recognized as a landmass and thus not acquired if it is 800 m or more in range or bearing direction.

## 2.6 Manual Acquisition



In auto acquisition mode (AUTO ACQ ON), up to 20 targets can be manually acquired in addition to 20 auto acquired targets. When auto acquisition is disabled (AUTO ACQ OFF), up to 40 targets can be manually acquired and automatically tracked.

To manually acquire a target:

1. Place the cursor (+) on a target of interest by operating the trackball.
2. Press the ACQ key on the control head. The selected plot symbol is marked at the cursor

position.

Note that the plot symbol is drawn by broken lines during the initial tracking stage. A vector appears in about one minute after acquisition indicating the target's motion trend. If the target is consistently detected for three minutes, the plot symbol changes to a solid mark. If acquisition fails, the target plot symbol blinks and disappears shortly.

-  (a) Immediately after acquisition, this plot symbol is shown in broken lines.
-  (b) Within 20 scans of antenna after acquisition, a vector appears to show a trend of movement.
-  (c) Within 60 scans of antenna after acquisition, the plot symbol changes to a small circle indicating steady-state tracking condition.

#### Notes:

- 1) For successful acquisition, the target to be acquired should be within 0.2 to 32 nm from own ship and not obscured by sea or rain clutter.
- 2) When you have acquired 40 targets manually, the message MAN TARGET FULL is displayed at the screen bottom. Cancel tracking of non-threatening targets if you wish to acquire additional targets manually. (See "Terminating tracking of acquired targets" on page 2-6.)

## 2.7 Changing Plot Symbol Size

Press a desired plot symbol key, and the symbol is enlarged for about 7 seconds.

You may also choose plot symbol size. To choose a large or standard size for all plot symbols:

1. Press the PLOT MENU key followed by the [0] key to show the ARPA 2 menu.
2. Press the [6] key to select MARK SIZE.
3. Further press the [6] key to select (or highlight) STANDARD or LARGE as appropriate.
4. Press the ENTER key to conclude your selection followed by the PLOT MENU key to close the ARPA 2 menu.



















### CAUTION - TARGET SWAP

When a target being tracked nears another target being tracked, the targets may be "swapped". When two targets acquired either automatically or manually come close to each other, one of the two may become a Lost Target. Should this happen, manual re-acquisition of the Lost Target may be required after the two have separated.

## ARPA symbols

The symbols used in this equipment comply with IEC 60872-1.

Item	Symbol	Status	Remarks
Automatically acquired targets		Initial stage epvs symbol no. 3	Broken square around an echo to indicate the target under acquisition and initial stage of tracking, before steady-state tracking.
		epvs symbol no. 3	Between 20 and 60 scans of antenna after acquisition (vector still unreliable)
		Steady tracking epvs symbol no. 4a	Solid circle with vector indicating steady state tracking (60 scans after acquisition)
	 (flashing)	CPA alarm epvs symbol no. 8	Plot symbol changes to an equilateral triangle flashing to indicate the target is predicted to come into CPA or TCPA.
		CPA alarm acknowledge epvs symbol no. 8	Flashing stops after CPA/TCPA alarm is acknowledged.
	 (flashing)	Lost target epvs symbol no. 9	Lost target is indicated by flashing diamond symbol. The diamond is formed from two equal triangles.
Manually acquired targets		Initial stage epvs symbol no. 3	Plot symbol selected for a target acquired manually is shown in bold broken lines.
		epvs symbol no. 3	Bold broken square for 20 - 60 scans of antenna after acquisition
		Steady tracking epvs symbol no. 4a	Manual plot symbol in a bold solid circle (60 scans after acquisition)
	 (flashing)	CPA alarm (collision course) epvs symbol no. 8	Plot symbol changes to an equilateral triangle flashing if a target is predicted to come into the preset CPA or TCPA.
		epvs symbol no. 8	Flashing stops after CPA/TCPA alarm is acknowledged.
	 (flashing)	Lost target epvs symbol no. 9	Lost target is indicated by flashing diamond symbol. The diamond is formed from two equal triangles (one apex up and the other apex down).
guard zone alarm	 (flashing)	On target passing through operator-set guard zone epvs symbol no. 7	Plot symbol changes to an equilateral triangle, apex down, flashing together with vector if target entering guard zone.
automatic acquisition area		5.5 - 6.0 nm, 3 - 3.5 nm or anywhere epvs symbol no. 2	Sector or full circle as selected by the operator.
Target selected for data readout		On selected target epvs symbol no. 12	Target data (range, bearing, course, speed, CPA and TCPA)
Reference target	 In 60 scans, changes to 	On reference target	Used to calculate own ship's over-the-ground speed (target-based speed) for ground stabilization.

**ARPA symbols (continued)**

ITEM	SYMBOL	STATUS	REMARKS
Trial maneuver	<b>T</b> (flashing)	Bottom center EPVS SYMBOL NO. 10	Appears during execution of a trial maneuver.
Performance test	<b>X X</b> (flashing)	Bottom center EPVS SYMBOL NO. 11A	Appears during execution of a performance test.

**NON-ARPA SYMBOLS for Radar**

ITEM	SYMBOL	STATUS	REMARKS
Non-ARPA symbols			These are non-ARPA symbols, but only for E-plot. Not available in the ARPA mode.

## 2.8 Adjusting Brilliance of Plot Marks

1. Press the RADAR MENU and [0] key to show the FUNCTIONS 2 menu.
2. Press the [9] and [0] key to show the BRILLIANCE 2 menu.
3. Press the [2] key to select PLOT BRILL.
4. Further press the [2] key to select (or highlight) a desired brilliance level.
5. Press the ENTER key to confirm your selection followed by the RADAR MENU key to close the BRILLIANCE 2 menu.

**Note:** Refer to paragraph 1.37 for the BRILLIANCE menu screen.

## 2.9 Displaying Target Data

The ARPA mode (with built-in ARP-26 optional board) provides the full functionality of ARPA as required by the IMO Resolution A.823(19) and IEC 60972-1, including display of range, bearing, course, speed, CPA and TCPA of all plotted targets. Data on 3 targets may be displayed on the text area at a time.

In head-up and head-up true bearing modes, target bearing, course and speed shown in the upper-right target data field become true (suffix "T") or relative (suffix "R") to own ship in accordance with the true/relative vector setting. In north-up, course-up and true motion modes, the target data field always displays true bearing, true course and speed over the ground.

Place the cursor on a desired target and press the [TARGET DATA] key. Target data display is as below.

**RNG/BRG (Range/Bearing):** Range and bearing from own ship to the selected target with suffix "T" (True) or "R" (Relative).

**CSE/SPD (Course/Speed):** Course and speed are displayed for the selected target with suffix "T" (True) or "R" (relative).

**CPA/TCPA:** CPA(Closest Point of Approach) is the closest range a target will approach to own ship. TCPA is the time to CPA. Both CPA and TCPA are automatically calculated. When the CPA has passed clear of own ship, it is indicated by a TCPA with a negative (-) sign. TCPA is counted to 99.9 min and beyond this, it is indicate as TCPA> -99.9MIN.

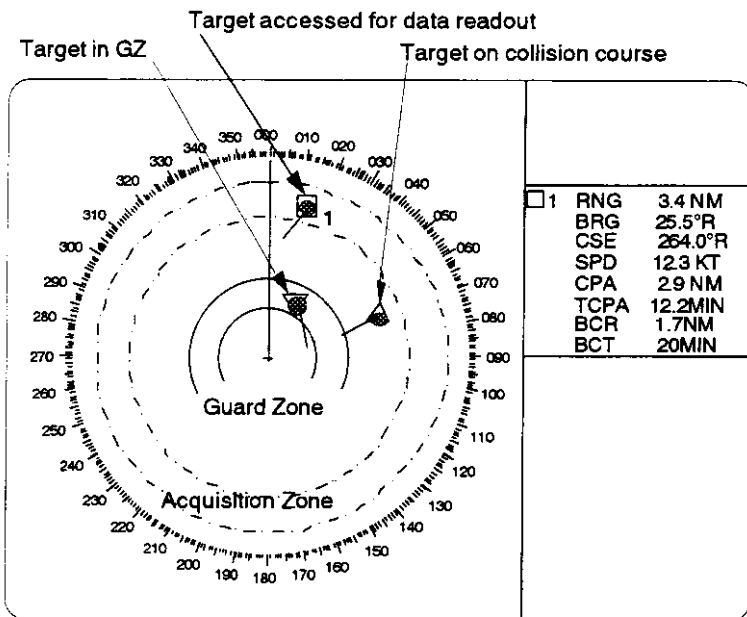

Target being accessed for data readout is marked  1, 2, ...etc.

- RNG: Range from own ship to target
- BRG: Bearing from own ship to target in R (Relative) or T (True)
- CSE: Course of target, True or Relative
- SPD: Speed of target
- CPA: Closest Point of Approach of target to own ship
- TCPA: Time to CPA
- BCR: Bow crossing range of target
- BCT: Bow crossing time of target

## 2.10 Vector modes

Target vectors can be displayed relative to own ship's heading (Relative) or north (True).

### Ground stabilization and Sea Stabilization

Target vectors can be ground stabilized or sea stabilized. Sea stabilization is a mode where own ship and all targets are referenced to the sea using gyro heading and single axis log water speed inputs in True Motion mode. Ground stabilization is a mode where own ship and all targets are referenced to the ground using the ground track or set and drift inputs. If the accuracy seems unsatisfactory, enter the set and drift correction (section 2.12).

### True vector

Vector mode, True or Relative, is selected with the VECTOR key. With true vectors the radar display will look like the one shown below.

In the true motion mode, all fixed targets such as land, navigational marks and ships at anchor remain stationary on the radar screen with vector length zero. But in the presence of wind and/or current, vectors appear on fixed targets representing the reciprocal of set and drift affecting own ship unless set and drift values are properly entered.

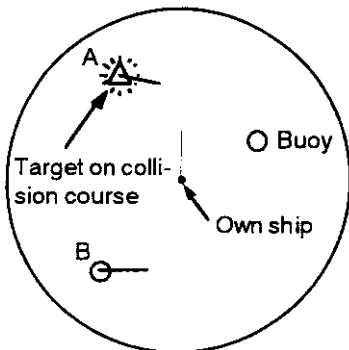

(a) True vectors in head-up mode

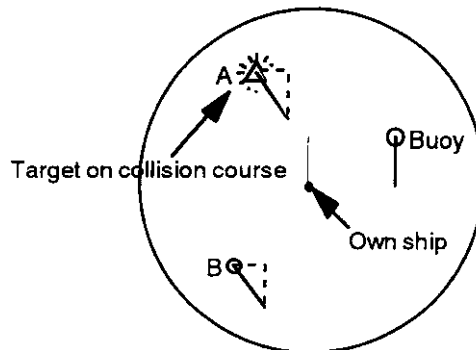

(b) Relative vectors in head-up mode



## Relative vector

With relative vectors the radar display will look like (b).

Relative vectors on targets which are not moving over the ground such as land, navigational marks and ships at anchor will represent the reciprocal of own ship's ground track. A target of which vector extension passes through own ship is on the collision course. (Dotted lines in the figure are for explanation only.)

## Vector time

Vector time (or the length of vectors) can be set to 30 seconds, 1, 2, 3, 6, 12, 15 or 30 minutes and the selected vector time is indicated at the upper-right corner of the screen.

1. Press the PLOT MENU key to display the ARPA 1 menu.
2. Press the [1] key to select the VECTOR TIME option.
3. Further press the [1] key to select (or highlight) a desired vector time.
4. Press the ENTER key to conclude your selection.
5. Press the PLOT MENU key to close the menu.

The vector tip shows an estimated position of the target after the selected vector time elapses. It can be valuable to extend the vector length to evaluate the risk of collision with any target.

## 2.11 Past Position Display

The ARPA displays equally time-spaced dots marking the past positions of any targets being tracked.

A new dot is added every minute (or at preset time intervals) until the preset number is reached. If a target changes its speed, the spacing will be uneven. If it changes the course, its plotted course will not be a straight line.

### Displaying and erasing past positions

#### To display past positions;

1. Press the [PLOT MENU] and [0] key to display the ARPA 2 menu.

[ARPA 2]	
1 [ARPA 1]	
2 TRIAL MODE	STATIC/DYNAMIC
3 HISTORY	OFF/1/2
4 HISTORY POINTS	5/10/20
5 HISTORY INTVL	30S/1/2/3/6MIN
6 MARK SIZE	STD/LARGE
7 GUARD, ACQUISITION STABILIZE	NORTH/CRT
8 INPUT SIG CHECK	
9 ARPA TRACK TEST	
0 ARPA INITIAL SETTING	

2. Press [3] key twice to select HISTORY ON.
3. Press the ENTER key followed by the PLOT MENU key.

The label HISTORY appears at the upper-right corner of the screen.

**To erase past positions;** press the [3] key twice on the ARPA 2 menu.

### **Selecting the number of dots and past position plot intervals**

1. Press the PLOT MENU and [0] key to show the ARPA 2 menu.
2. Press the [4] key to select menu item HISTORY POINTS.
3. Further press the [4] key to select a desired number of past positions (5, 10 or 20). The IMO-type has the selection of only 5 or 10.
4. Press the ENTER key to confirm your selection.
5. Press the [5] key to select menu item HISTORY INTERVAL.
6. Further press the [5] key to select a desired past position plot interval (0.5, 1, 2, 3 or 6 minutes).
7. Press the ENTER key to conclude your selection.
8. Press the PLOT MENU key to close the menu.

## **2.12 Set and Drift (Set and Rate)**

Set, the direction in which a water current flows, can be manually entered in 0.1-degree steps. Drift, in another word Rate, the speed of tide, can also be entered manually in 0.1 knot steps.

Set and drift corrections are beneficial for increasing the accuracy of vectors and target data. The correction is best made in the head-up mode with true vectors, watching landmasses, or other stationary targets. Thus, the speed and course of own ship over the ground are reciprocally calculated and compared with the relative bearing and range to the reference target to produce a Set and Drift. These values are automatically applied to all targets. If stationary targets have vectors, set and drift values should be adjusted until they lose vectors.

Proceed as follows to enter set and drift (rate):

1. Press the RADAR MENU key to show the FUNCTIONS 1 menu.
2. Press the [0] key to show the FUNCTIONS 2 menu.
3. Press the [7] key to select menu item SET, DRIFT.
4. Further press the [7] key to select OFF or MAN option.  
OFF: No correction against set and drift.  
MAN: Manual entry of set and drift data.
5. If OFF is selected, press the ENTER key.
6. If you have selected MAN in step 4 above, the highlight cursor will advance to right requesting you to enter SET xxx.x°. Enter the value of set in degrees by hitting numeric keys without omitting leading zeroes, if any, and press the ENTER key.

The highlight cursor will then advance to the next line DRIFT xx.xKT. Enter the value of drift in knots by hitting numeric keys without omitting leading zeroes, if any, and press the ENTER key. Set and drift have the same effect on own ship and all targets.

7. Press the RADAR MENU key to close the menu. The label LOG (or NAV) on the top of the display changes to SMG xx.x KTBT, where SMG stands for Speed Made Good and BT, Bottom Track. Set and drift data can also be used in the basic radar without ARPA function.

## 2.13 Setting CPA/TCPA Alarm Ranges

The ARPA continuously monitors the predicted range at the Closest Point of Approach (CPA) and predicted time to CPA (TCPA) of each tracked target to own ship.

When the predicted CPA of any target becomes smaller than a preset CPA alarm range and its predicted TCPA less than a preset TCPA alarm limit, the ARPA releases an aural alarm and displays the warning label COLLISION on the screen. In addition, the ARPA symbol changes to a triangle and flashes together with its vector.

Provided that this feature is used correctly, it will help prevent the risk of collision by alerting you to threatening targets. It is important that GAIN, A/C SEA, A/C RAIN and other radar controls are properly adjusted.

CPA/TCPA alarm ranges must be set up properly taking into consideration the size, tonnage, speed, turning performance and other characteristics of own ship.

 <b>CAUTION</b>
<b>CPA/TCPA Alarm</b>
The CPA and TCPA alarm feature should never be relied upon as the sole means for detecting the risk of collision.
The navigator is not relieved of the responsibility to keep visual lookout for avoiding collisions, whether or not the radar or other plotting aid is in use.

To set the CPA/TCPA alarm ranges:

1. Press the PLOT MENU key to show the ARPA 1 menu.
2. Press the [8] key to select menu item COLLISION ALARM. At this point, a highlight cursor appears at the "CPA x.x NM" field.
3. Enter the CPA alarm range in nautical miles (max 9.9 min) without omitting leading zeroes, if any, and press the ENTER key. The highlight cursor now moves to the "TCPA xx.x MIN" field.
4. Enter the TCPA alarm limit in minutes (max. 99.0 min) without omitting leading zeroes, if any, and press the ENTER key.
5. Press the PLOT MENU key to close the menu.

### Acknowledging CPA/TCPA audible alarm

Press the AUDIO OFF key to acknowledge and silence the CPA/TCPA aural alarm.

The warning label COLLISION and the flashing of the triangle plot symbol and vector remain on the screen until the dangerous situation is gone or you intentionally terminate tracking of the target by using the CANCEL key.

## 2.14 Setting a Guard Zone

When a target transits the operator-set guard zone, the buzzer sounds and the indication **GUARD** appears at the screen bottom. The target causing the warning is clearly indicated with an inverted flashing triangle.

 <b>CAUTION</b>
<b>Guard zone (GZ)</b> The Guard Zone Alarm feature should never be relied upon as a sole means for detecting the risk of collision. The navigator is not relieved of the responsibility to keep visual lookout for avoiding collisions, whether or not the radar or other plotting aid is in use.

### Activating the guard zone

One or two guard zones may be selected. The NO. 1 guard zone is available between 3 and 6 nm and NO. 2 guard zone can be set anywhere when the NO. 1 zone is already in use.

To set and activate the guard zone:

1. Press the PLOT MENU key to show the ARPA 1 menu.
2. Press the [4] key to select menu item GUARD ZONE.
3. Further press the [4] key to select (or highlight) ON to activate the guard zone.
4. Press the ENTER key to conclude your selection.
5. Press the [5] key to select menu item GUARD ZONE SET. At this point the GUARD ZONE SET menu is displayed at the screen bottom.

[GUARD ZONE SET]
1 [ARPA 1] 2 1/2
SET LEFT/RIGHT BOUNDARY CANCEL PREVIOUS AREA: CANCEL KEY

6. Press the [2] key and ENTER key. ([2] [2] [ENTER] when setting the No. 2 zone.)
7. Referring to figure below, place the cursor at the outer left corner of the area (point A) and press the ENTER key.
8. Place the cursor at the right edge of the area (point B) and press the ENTER key.

**Note:** If you wish to create a guard zone having a 360-degree coverage around own ship, set point B in almost the same direction (approx.  $\pm 3^\circ$ ) as point A and press the ENTER key.

If the range scale is changed to less than half of GZ, the label GZ OUT appears in red at the upper right corner of the screen.

9. Press the [1] key followed by the PLOT MENU key to close the ARPA 1 menu.

The guard zone like an example below appears on the display. Note that the guard zone has a fixed radial extension (width) of 0.5 nm. The label GZ is displayed in the box at the upper-right on the screen when guard zone is enabled.

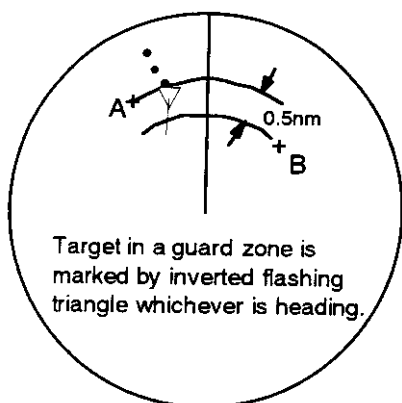

NO. 1 Guard Zone (GZ) is available between 3 and 6 nm with a fixed range depth of 0.5 nm. NO. 2 GZ may be set anywhere when the NO. 1 GZ is valid.

Two more alarm zones (NO. 1 and NO. 2 Target Alarm Zones = TAZ) may be added in addition. This means a maximum 4 alarm zones are available at a time. ARPA symbols are not changed to inverted triangles in the TAZ, only those in GZ do so.

### Deactivating the guard zone

1. Press the PLOT MENU key to show the ARPA 1 menu.
2. Press the [4] key to select menu item GUARD ZONE.
3. Further press the [4] key to select (or highlight) OFF to deactivate the guard zone.
4. Press the ENTER key to conclude your selection followed by the PLOT MENU key to close the menu.

### To acknowledge the guard zone alarm

Press the AUDIO OFF key to acknowledge and silence the guard zone aural alarm.

## 2.15 Operational Warnings

There are six main situations which cause the ARPA to trigger visual and aural alarms:

- CPA/TCPA alarm
- Guard zone alarm
- Lost target alarm
- Target full alarm for manual acquisition
- Target full alarm for automatic acquisition
- System failures

### CPA/TCPA alarm

Visual and aural alarms are generated when the predicted CPA and TCPA of any target become less than their preset limits. Press the AUDIO OFF key to acknowledge and silence the CPA/TCPA aural alarm.

### Guard zone alarm

Visual and aural alarms are generated when a target transits the operator-set guard zone. Press the AUDIO OFF key to acknowledge and silence the guard zone aural alarm. (Refer to paragraph 2.14 Setting a Guard Zone for further information.)

## Lost target alarm

When the system detects a loss of a tracked target, the target symbol becomes a flashing diamond (◊) and the label "LOST" appears at the screen bottom. At the same time, an aural alarm is produced for one second.

Press the LOST TARGET key to acknowledge the lost target alarm. Then, the lost target mark disappears.

## Target full alarm

When the memory becomes full, the memory full status is indicated and the relevant indication appears on the screen and a short beep sounds.

## Manually acquired targets

The indication "MAN TARGET FULL" appears at the screen bottom and a short beep tone sounds when the number of manually acquired targets reaches 20 or 40 depending on whether auto acquisition is activated or not.

## Automatically acquired targets

The indication "AUTO TARGET FULL" appears at the screen bottom and a short beep tone sounds when the number of automatically acquired targets reaches 20.

## System failure alarm

When the ARP board receives no signal input from the radar or external equipment, the screen shows both "SYSTEM FAIL" associated with an indication denoting offending equipment, also releasing an aural alarm. The missing signals are denoted as shown below:

Missing Signal	Indication
* Speed log signal	LOG
* Heading signal, Gyrocompass or Magnetic compass	HDG T (G/M)
Trigger signal from radar	T
Video from radar	V
* Bearing signal from radar antenna	B
* Heading pulses from radar antenna	H

\* The alarm is available with or without ARPA.

## 2.16 Trial Maneuver

Trial simulates the effect on all tracked targets against own ship's maneuver without interrupting the updating of target information.

There are two types of trial maneuvers: static and dynamic.

### Dynamic trial maneuver

A dynamic trial maneuver displays predicted positions of the tracked targets and own ship. You

enter own ship's intended speed and course with a certain "delay time." Assuming that all tracked targets maintain their present speeds and courses, the targets' and own ship's future movements are simulated in one-second increments indicating their predicted positions in one-minute intervals as illustrated below.

The delay time represents the time lag from the present time to the time when own ship will actually start to change her speed and/or course. You should therefore take into consideration own ship's maneuvering characteristics such as rudder delay, turning delay and acceleration delay. This is particularly important on large vessels. How much the delay is set the situation starts immediately and ends in a minute.

In the example shown below, own ship will advance straight ahead (even after a maneuver) for a delay time of 5 minutes and then alters speed and course until operator-specified intended speed and course are achieved (position OS7 in this example).

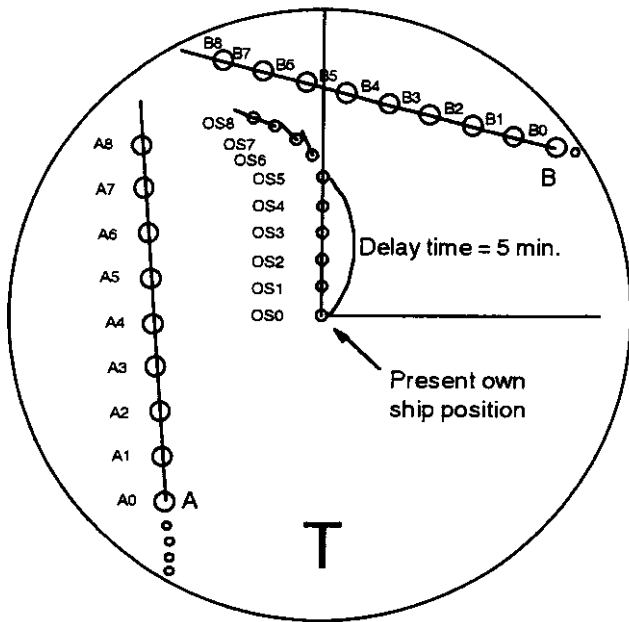

Dynamic trial maneuver

Note that once a dynamic trial maneuver is initiated, you cannot alter own ship's trial speed, course or delay time until the trial maneuver is terminated.

### Static trial maneuver

A static trial maneuver displays only the final situation of the simulation. If you enter the same trial speed, course and delay time under the same situation as in the aforementioned example of dynamic trial maneuver, the screen will instantly show position OS7 for own ship, position A7 for target A and position B7 for target B, omitting the intermediate positions. Thus, the static trial maneuver will be convenient when you wish to know the maneuver result immediately.

**Note:** For accurate simulation of ship movements in a trial maneuver, own ship's characteristics such as acceleration and turning performance should be properly set in initial settings at the time of installation.

To perform a trial maneuver:

1. Press the PLOT MENU key followed by the [0] key to show the ARPA 2 menu.

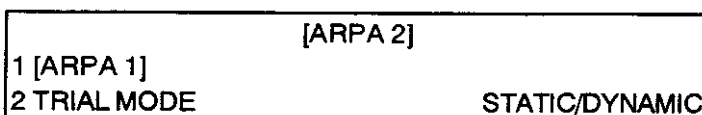

3 HISTORY	OFF/1/2
4 HISTORY POINTS	5/10/20
5 HISTORY INTVL	30S/1/2/3/6MIN
6 MARK SIZE	STD/LARGE
7 GUARD, ACQUISITION STABILIZE	NORTH/CRT
8 INPUT SIG CHECK	
9 ARPA TRACK TEST	
0 ARPA INITIAL SETTING	

2. Press the [2] key to select TRIAL MODE.
3. Further press the [2] key to select (or highlight) STATIC or DYNAMIC trial maneuver option as appropriate.
4. Press the ENTER key to conclude your selection followed by the [1] key to go back to the ARPA menu.
5. Press the VECTOR key to select true or relative vector.
6. Press the [9] key on the ARPA 1 menu. The TRIAL DATA SETTING menu appears at the screen bottom associated with the current own ship's speed and course readouts.

TRIAL DATA SETTING	
[DYNAMIC MODE]:	
SPEED (VRM)	15.0KT
COURSE (EBL)	53.6°
DELAY TIME	xx.xMIN

**Note:** The second line reads [STATIC MODE] in the event of a static trial maneuver.

7. Enter own ship's intended speed, course and delay time in the following manner:
  - Speed: Set with the VRM control.
  - Course: Set with the EBL control.
  - Delay time: Enter in minutes by hitting numeral keys. This is the time after which own ship takes a new situation, not the time the simulation begins. Change the delay time according to own ship loading condition, etc.
8. Press the [9] key again on the ARPA 1 menu to start a trial maneuver.
9. Press the PLOT MENU to close the menu.

Trial maneuver takes place in three minutes with the letter "T" displayed at the bottom of the screen. If any tracked target is predicted to be on a collision course with own ship (that is, the target ship comes within preset CPA/TCPA limits), the target plot symbol changes to a triangle ( $\Delta$ ) and flashes. If this happens, change own ship's trial speed, course or delay time to obtain a safe maneuver. The trial maneuver is automatically terminated and the normal radar picture is restored three minutes later.

### Terminating trial maneuver

Press the PLOT MENU key and the [9] key at any time.



## 2.17 ARPA Performance Test

Test program is provided for assessing the ARPA overall performance. Note that normal operation is interrupted and the label "XX" is displayed at the bottom of the screen during this test. The test may be terminated at any moment.

To execute the performance test:

1. Select the north-up presentation mode on the 12 nm range.
2. Enter own ship speed of 0 knots.
3. Press the PLOT MENU key followed by the [0] key to show the ARPA 2 menu.
4. Press the [9] key to select ARP TRACK TEST. The display is cleared and a performance test picture comes on.
5. Press the ENTER key.

An alert XX flickers during the test. It takes approximately 3 minutes for all vectors to be displayed. The test does not need echo signals, gyro nor speed log input. 7 targets having different speeds and courses, as shown in the table below, are simulated automatically.

6. The test continues for 5 minutes and then repeats.

To terminate the track test, press the STBY/TX key twice and the STBY display will appear.

Select any target with the cursor and check that the selected target shows the course and speed as in the table. CPA and TCPA shown below are initial values which change with time.

Target	Course	Speed (kt)	CPA (nm)	TCPA (min)
Target A	90.0°T	10.0	1.0	10.4
Target B	0.0°T	0.0	4.0	-
Target C	180.0°T	10.0	1.7	28.2
Target D	216.5°T	23.8	0.9	15.0
Target E	273.5°T	14.2	6.0	22.5
Target F	180.0°T	20.0	0.0	30.0
Target G	24.6°T	15.6	4.0	43.6

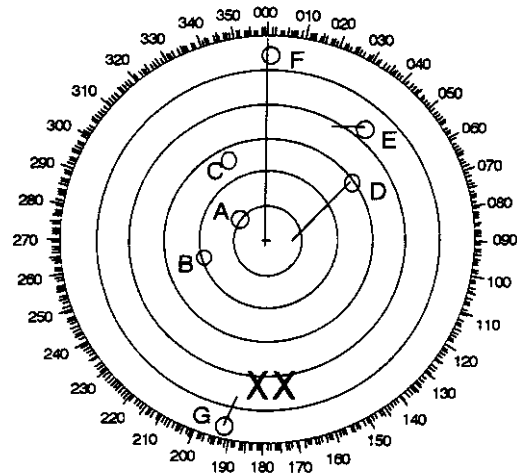

**Note:** Note that target numbers are subject to change. If test results show any deviation from the above, consult with your service representative.

## 2.18 Criteria for Selecting Targets for Tracking

The FURUNO ARPA video processor detects targets in midst of noise and discriminates radar echoes on the basis of their size. Target whose echo measurements are greater than those of the largest ship in range or tangential extent are usually land and are displayed only as normal radar video. All smaller ship-sized echoes which are less than this dimension are further analyzed and regarded as ships and displayed as small circles superimposed over the video echo.

When a target is first displayed, it is shown as having zero true speed but develops a course vector

as more information is collected. In accordance with the International Marine Organization Automatic Radar Plotting Aid (IMO ARPA) requirements, an indication of the motion trend should be available within 20 scans of antenna and full vector accuracy within 60 scans. The FURUNO ARPAs comply with these requirements.

## **Acquisition and tracking**

A target which is hit by 5 consecutive radar pulses is detected as a radar echo. Manual acquisition is done by designating a detected echo with the trackball. Automatic acquisition is done in the acquisition areas when a target is detected 5-7 times continuously depending upon the congestion. Tracking is achieved when the target is clearly distinguishable on the display for 5 out of 10 consecutive scans whether acquired automatically or manually.

Targets not detected in 5 consecutive scans become "lost targets."

## **Quantization**

The entire picture is converted to a digital form called "Quantified Video." A sweep range is divided into small segments and each range element is "1" if there is radar echo return above a threshold level, or "0" if there is no return.

The digital radar signal is then analyzed by a ship-sized echo discriminator. As the antenna scans, if there are 5 consecutive radar pulses with 1's indicating an echo presence at the exact same range, a target "start" is initiated. Since receiver noise is random, it is not three bang correlated, and it is filtered out and not classified as an echo.

The same is true of radar interference. Electronic circuits track both the closet and most distant edges of the echo. At the end of the scanning of the echo, the discriminator indicates the measured maximum range extent and total angular extent subtended by the echo. If the echo is larger than a ship-sized echo in range extent and/or angular width, adjusted as a function of range, it is declared to be a coastline and the closet edge is put into memory as a map of the area. This land outline is used to inhibit further acquisition and tracking of ship sized echoes beyond the closest coast outline. 5 consecutive scans of coastal outline are retained in memory to allow for signal variation. All smaller echoes are declared to be ship sized and the middle of the leading edge is used to provide precise range and bearing coordinates of each echo on every scan. This range/bearing data is matched to previous data and analyzed from scan-to-scan for consistency. When it is determined to be as consistent as a real target, automatic acquisition occurs and tracking is initiated. Continued tracking and subsequent calculation develop the relative course and speed of the target just as a man would do when plotting the relative course and speed of the target on the scope with a grease pencil.

The true course and speed of own ship are computed from own ship's gyro and speed inputs, and the resulting course and speed of each tracked target is easily computed by vector summing of the relative motion with own ship's course and speed. The resulting true or relative vector is displayed for each of the tracked targets. This process is updated continually for each target on every scan of the radar.

## **Automatic acquisition areas and suppression lines**

Performance of auto-acquisition is enhanced by controlling the limit lines (suppression line) in the former series of FURUNO ARPAs. In this new series of ARPAs, the automatic acquisition rings are used instead of the limit lines.

Auto acquisition rings work as suppression lines when viewed from the opposite direction. They should be placed clear of a landmass or shoreline. The acquisition areas may be a full 360 degree circle or sector of any angles are gyro stabilize.

## **Qualitative description of tracking error**

The FURUNO ARPA accuracy complies with or exceeds IMO standards.

### **Own ship maneuvers**

For slow turns there is no effect. For very high turning rates (greater than 150°/minute, depending on gyro), there is some influence on all tracked targets which last for a minute or two and then all tracked targets revert to full accuracy.

### **Other ship maneuvers**

Target ship courses, lag 15 to 30 seconds at high relative speed, or 3 to 6 seconds at low (near 0) relative speed. It is less accurate during a turn due to lag, but accuracy recovers quickly.

## **2.19 Factors Affecting ARPA Functions**

### **Sea returns**

If the radar anti-clutter control is adjusted properly, there is no serious effect because distant wave clutter, not eliminated by this control, is filtered out by more than one bang correlation and scan-to-scan matching of data.

### **Rain and snow**

Clutter can be acquired and tracked as targets. Adjust the A/C RAIN control. If it is heavy rain, switch to S-band if provided, or switch on the interference rejector on the radar. If heavy clutter still exists, switch to manual acquisition. Accuracy can be affected.

### **Low clouds**

Usually no effect. If necessary, adjust the A/C RAIN control.

### **Non-synchronous emissions**

No effect.

### **Low gain**

Insufficient or low radar receiver gain will result in some targets not being acquired at long distance. ARPA display will be missing on one or more targets that could only be visible if the radar sensitivity control (GAIN control) were increased.

The setting of the correct radar receiver gain is not critical but the target should be on the radar PPI and be clearly visible and well defined.

Manual acquisition is done if a target is positively displayed more than once. Automatic acquisition is done when the target is detected 5-7 times continuously. Tracking is achieved when the target is detected 5 times (not necessarily continuously) out of 10 scans. If not detected 6 times out of 10 scans, the target will become a "lost target." The ARPA will acquire a radar echo that is present once in every six antenna scans and continue tracking if 1 in 10.

## **Second trace echoes**

When the radar beam is super refracted, strong echoes may be received at such long ranges that they appear on a different timebase sweep than the transmitted pulse. This gives an incorrect range indication. Second and third trace echoes can be tracked if they are consistent enough to meet acquisition and tracking criteria but target course and speed data will be in error.

## **Blind and shadow sectors**

Radar shadow or blind areas caused by obstructions aboard ship, for example, funnels and masts, in the path of the radar beam can result in reduction of radar beam intensity in that particular direction. This may eliminate the detection of some targets. The ARPA system will lose track of targets shortly after they are lost on the radar picture and if they remain in a blind zone. These targets will however be acquired and tracked when they pass out of the blind zone and again present normal radar echo. The angular width and bearing of any shadow sector should be determined for their influence on the radar. In certain cases false echoes in the shadow sector cause the ARPA system to acquire, track, and vector them. Shadow sectors should be avoided.

## **Indirect echoes**

A target at close range is usually picked up directly, but it can also be received as reflection from a large, flat surface. This will result in the radar presenting two or more echoes on the display, each at a different range. The ARPA can acquire and track the false echo if it is detected by five consecutive scans. Reduction in radar GAIN can eliminate the multiple echoing but care should be taken as range detection also will be reduced.

## **Radar interference**

If interference is extreme due to another radar operating at close range, spiral "dotting" and/or false targets may appear momentarily. The interference rejector can clear the display.

To receive radar beacon or SART signals, turn off the radar interference rejection and echo average which operate on the correlation technique.



# Chapter 3 RADAR OBSERVATION

## 3.1 General

### Minimum and maximum ranges

#### Minimum range

The minimum range is defined by the shortest distance at which, using a scale of 1.5 or 0.75 nm, a target having an echoing area of 10 m<sup>2</sup> is still shown separate from the point representing the antenna position.

It is mainly dependent on the pulselength, antenna height, and signal processing such as main bang suppression and digital quantization. It is a good practice to use a shorter range scale as far as it gives favorable definition or clarity of picture. The IMO Resolution MSC.64(67) Annex 4 (Shipborne radar) and A.820: 1995 (High Speed Craft Radar) require the minimum range to be less than 50 m and 35 m, respectively. This series of radars satisfy this requirement.

#### Maximum range

The maximum detecting range of the radar,  $R_{max}$ , varies considerably depending on several factors such as the height of the antenna above the waterline, the height of the target above the sea, the size, shape and material of the target, and the atmospheric conditions.

Under normal atmospheric conditions, the maximum range is equal to the radar horizon or a little shorter. The radar horizon is longer than the optical one by about 6% because of the diffraction property of the radar signal. The  $R_{max}$  is given in the following equation.

$$R_{max} = 2.2 \times (\sqrt{h_1} + \sqrt{h_2})$$

where  $R_{max}$ : radar horizon (nautical miles)  
h1: antenna height (m)  
h2: target height (m)

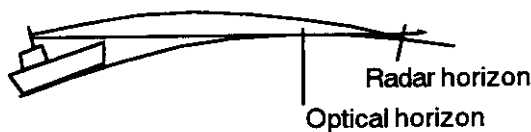

For example, if the height of the antenna above the waterline is 9 meters and the height of the target is 16 meters, the maximum radar range is;

$$R_{max} = 2.2 \times (\sqrt{9} + \sqrt{16}) = 2.2 \times (3 + 4) = 15.4 \text{ nm}$$

It should be noted that the detection range is reduced by precipitation (which absorbs the radar signal).

#### X-band and S-band

In fair weather, the above equation does not give a significant difference between X- and S-band radars. However, in heavy precipitation condition, an S-band radar would have better detection than an X-band radar.

## **Radar resolution**

There are two important factors in radar resolution (discrimination): bearing resolution and range resolution.

### **Bearing resolution**

Bearing resolution is the ability of the radar to display as separate pips the echoes received from two targets which are at the same range and close together. It is proportional to the antenna length and reciprocally proportional to the wavelength. The length of the antenna radiator should be chosen for a bearing resolution better than  $2.5^\circ$  (IMO Resolution). This condition is normally satisfied with a radiator of 1.2 m (4 ft) or longer in the X-band. The S-band radar requires a radiator of about 12 feet (3.6 m) or longer.

### **Range resolution**

Range resolution is the ability to display as separate pips the echoes received from two targets which are on the same bearing and close to each other. This is determined by pulselength only. Practically, a 0.08 microsecond pulse offers the discrimination better than 35 m as do so with all FURUNO radars.

Test targets for determining the range and bearing resolution are radar reflectors having an echoing area of  $10 \text{ m}^2$ .

### **Bearing accuracy**

One of the most important features of the radar is how accurately the bearing of a target can be measured. The accuracy of bearing measurement basically depends on the narrowness of the radar beam. However, the bearing is usually taken relative to the ship's heading, and thus, proper adjustment of the heading marker at installation is an important factor in ensuring bearing accuracy. To minimize error when measuring the bearing of a target, put the target echo at the extreme position on the screen by selecting a suitable range.

### **Range measurement**

Measurement of the range to a target is also a very important function of the radar. Generally, there are two means of measuring range: the fixed range rings and the variable range marker (VRM). The fixed range rings appear on the screen with a predetermined interval and provide a rough estimate of the range to a target. The variable range marker's diameter is increased or decreased so that the marker touches the inner edge of the target, allowing the operator to obtain more accurate range measurements.

## **3.2 False Echoes**

Occasionally echo signals appear on the screen at positions where there is no target or disappear even if there are targets. They are, however, recognized if you understand the reason why they are displayed. Typical false echoes are shown below.

### **Multiple echoes**

Multiple echoes occur when a transmitted pulse returns from a solid object like a large ship, bridge, or breakwater. A second, a third or more echoes may be observed on the display at double, triple or other multiples of the actual range of the target as shown below. Multiple reflection echoes can be reduced and often removed by decreasing the gain (sensitivity) or properly adjusting the A/C SEA

## Sidelobe echoes

Every time the radar pulse is transmitted, some radiation escapes on each side of the beam, called "sidelobes." If a target exists where it can be detected by the side lobes as well as the main lobe, the side echoes may be represented on both sides of the true echo at the same range. Side lobes show usually only on short ranges and from strong targets. They can be reduced through careful reduction of the gain or proper adjustment of the A/C SEA control.

## Virtual image

A relatively large target close to your ship may be represented at two positions on the screen. One of them is the true echo directly reflected by the target and the other is a false echo which is caused by the mirror effect of a large object on or close to your ship as shown in the figure below. If your ship comes close to a large metal bridge, for example, such a false echo may temporarily be seen on the screen.

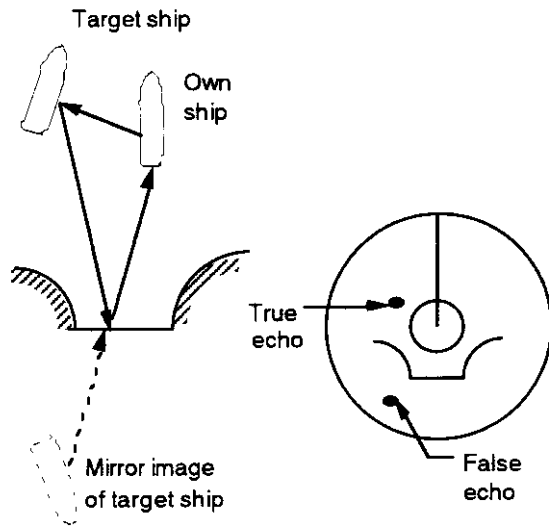

Virtual image by mirror effect

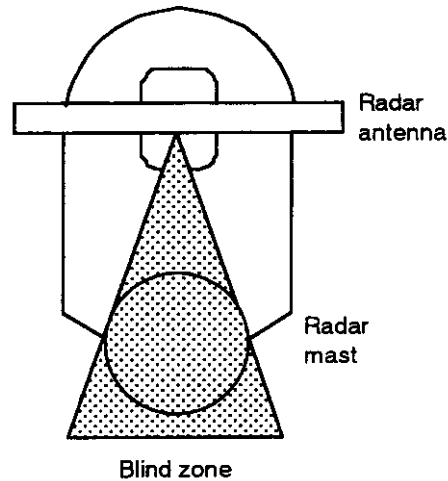

Blind zone by stern block

## Shadow sectors (see above right)

Funnels, stacks, masts, or derricks in the path of the antenna block the radar beam. If the angle subtended at the scanner is more than a few degrees, a non-detecting sector may be produced. Within this sector targets can not be detected.

## 3.3 SART (Search and Rescue Transponder)

A Search and Rescue Transponder (SART) may be triggered by any X-Band (3 cm) radar within a range of approximately 8 nm. Each radar pulse received causes it to transmit a response which is swept repetitively across the complete radar frequency band. When interrogated, it first sweeps rapidly ( $0.4 \mu\text{s}$ ) through the band before beginning a relatively slow sweep ( $7.5 \mu\text{s}$ ) through the band back to the starting frequency. This process is repeated for a total of twelve complete cycles. At some point in each sweep, the SART frequency will match that of the interrogating radar and be within the pass band of the radar receiver. If the SART is within range, the frequency match during each of the 12 slow sweeps will produce a response on the radar display, thus a line of 12 dots equally spaced by about 0.64 nautical miles will be shown.

When the radar to the SART is reduced to about 1 nm, the radar display may show also the 12



responses generated during the fast sweeps. These additional dot responses, which also are equally spaced by 0.64 nautical miles, will be interspersed with the original line of 12 dots. They will appear slightly weaker and smaller than the original dots.

#### When SART is distant

#### When SART is close

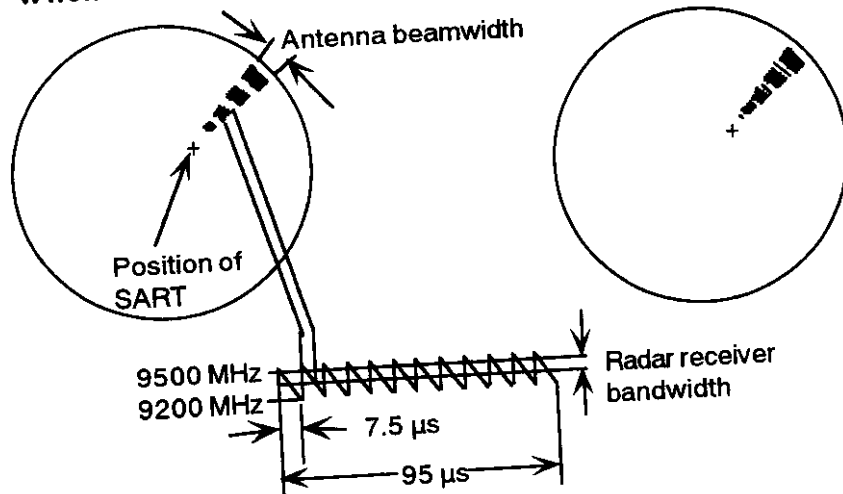

### Showing SART marks on the radar display

To show the SART marks only on the radar display, detune the radar receiver by turning the TUNE control out of best tuning condition. This erases or weakens all normal radar echoes, but, the SART marks are not erased because the SART response signal scans over all frequencies in the 9 GHz band. When the radar approaches the SART in operation, the SART marks will enlarge to large arcs, blurring a large part of the screen. Reduce the sensitivity and adjust the sea clutter control of the radar.

### Summary to detect SART response

1. Use range scale of 6 or 12 nm as the spacing between the SART responses is about 0.6 nm (1125 m) to distinguish the SART.
2. Turn off the automatic clutter suppression.
3. Turn off the Interference Rejector.
4. Turn off the Echo Average.

### General remarks on receiving SART

#### Radar range scale

When looking for a SART it is preferable to use either the 6 or 12 nautical mile range scale. This is because the total displayed length of the SART response of 12 (or 24) dots may extend approximately 9.5 nautical miles beyond the position of the SART and it is necessary to see a number of response dots to distinguish the SART from other responses.

#### SART range errors

When responses from only the 12 low frequency sweeps are visible (when the SART is at a range greater than about 1 nm), the position at which the first dot is displayed may be as much as 0.64 nm beyond the true position of the SART. When the range closes so that the fast sweep responses are seen also, the first of these will be no more than 150 meters beyond the true position.

## **Radar bandwidth**

This is normally matched to the radar pulselength and is usually switched with the range scale and the associated pulselength. Narrow bandwidths of 3-5 MHz are used with long pulses on long range scales and wide bandwidths of 10-25 MHz with short pulses on short ranges.

A radar bandwidth of less than 5 MHz will attenuate the SART signal slightly, so it is preferable to use a medium bandwidth to ensure optimum detection of the SART.

## **Radar side lobes**

As the SART is approached, side lobes from the radar antenna may show the SART responses as a series of arcs or concentric rings. These can be removed by the use of the anti-clutter sea control although it may be operationally useful to observe the side lobes as they may be easier to detect in clutter conditions and also they will confirm that the SART is near to own ship.

## **Detuning the radar**

To increase the visibility of the SART in clutter conditions, the radar may be detuned to reduce the clutter without reducing the SART response. Radar with automatic frequency control may not permit manual detune of the equipment. Care should be taken in operating the radar in the detuned condition as other wanted navigational and anti-collision information may be removed. The tuning should be returned to normal operation as soon as possible.

## **Gain**

For maximum range SART detection the normal gain setting for long range detection should be used, i. e., with a light background noise speckle visible.

## **A/C SEA control**

For optimum range SART detection, this control should be set to the minimum. Care should be exercised as wanted targets in sea clutter may be obscured. Note also that in clutter conditions the first few dots of the SART response may not be detectable, irrespective of the setting of the anti-clutter sea control. In this case, the position of the SART may be estimated by measuring 9.5 nautical miles from the furthest dot back towards own ship.

Some sets have automatic/manual anti-clutter sea control facilities in which case the operator is advised to use manual control initially until the SART has been detected. The effect of the auto sea control on the SART response can then be compared with manual control.

## **A/C RAIN control**

This should be used normally (i.e. to break up areas of rain) when trying to detect a SART response which, being a series of dots, is not affected by the action of the anti-clutter rain circuitry. Note that Racon responses, which are often in the form of a long flash, will be affected by the use of this control.

Some sets have automatic/manual anti-clutter rain control facilities in which case the operator is advised to use manual control initially until the SART has been detected. The effect of the auto sea control on the SART response can then be compared with manual control.

This information is excerpted from IMO SN/Circ 197 OPERATION OF MARINE RADAR FOR SART DETECTION.

### 3.4 RACON (Radar beacon)

Racon is a radar transponder which emits a characteristic signal when triggered by a ship's radar (X or S band). There are several signal formats; in general, the Racon signal appears on the radar screen as a radial line originating at a point just beyond the position of the radar beacon or as a Morse code pattern from just beyond the beacon.

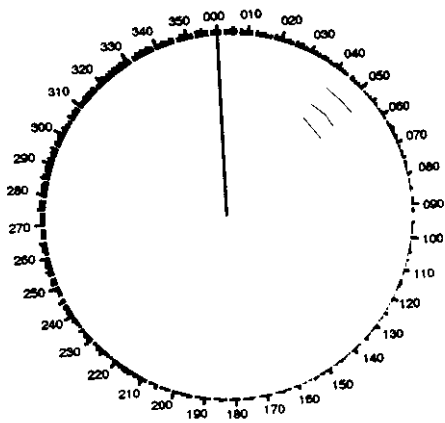

## **4 OPERATION OF VIDEO PLOTTER**

### **4.1 General**

The Video Plotter RP-26 is an optional circuit board which is accommodated in the display unit of the radar. It permits use of 2 memory cards, a memory card(RAM) for storing the operator created radar maps, and the other is a chart card(ROM) storing Furuno made digital charts.

The memory card enables the operator to create radar maps more precisely than the standard supplied radar map card (150 points per map). Navigation lines can have as many segments and vertexes as required (maximum 25 lines and 30 vertexes per line). The card permanently retains the data you have entered from the radar display or by Lat/Long positions. Own ship and other ship tracks may be stored at a selected interval. To display Nav line, RTE and WPL sentences are necessary. WPL ID sentence received in figure only. The data can be copied for other ships of the same shipping company.

Charts are superimposed on the radar picture without disturbing the radar observation. The chart area is dependent on the radar range in use.

The drive for the ROM card can also drive the Electronic Reference Chart (ERC). The ERC is a digital chart published by the Japanese Hydrographic Bureau. Note it is not an ENC used for ECDIS.

### **4.2 The Video Plotter Display**

Press the RADAR MENU. Press [9] once or twice for "Chart plus Radar" or "Radar".

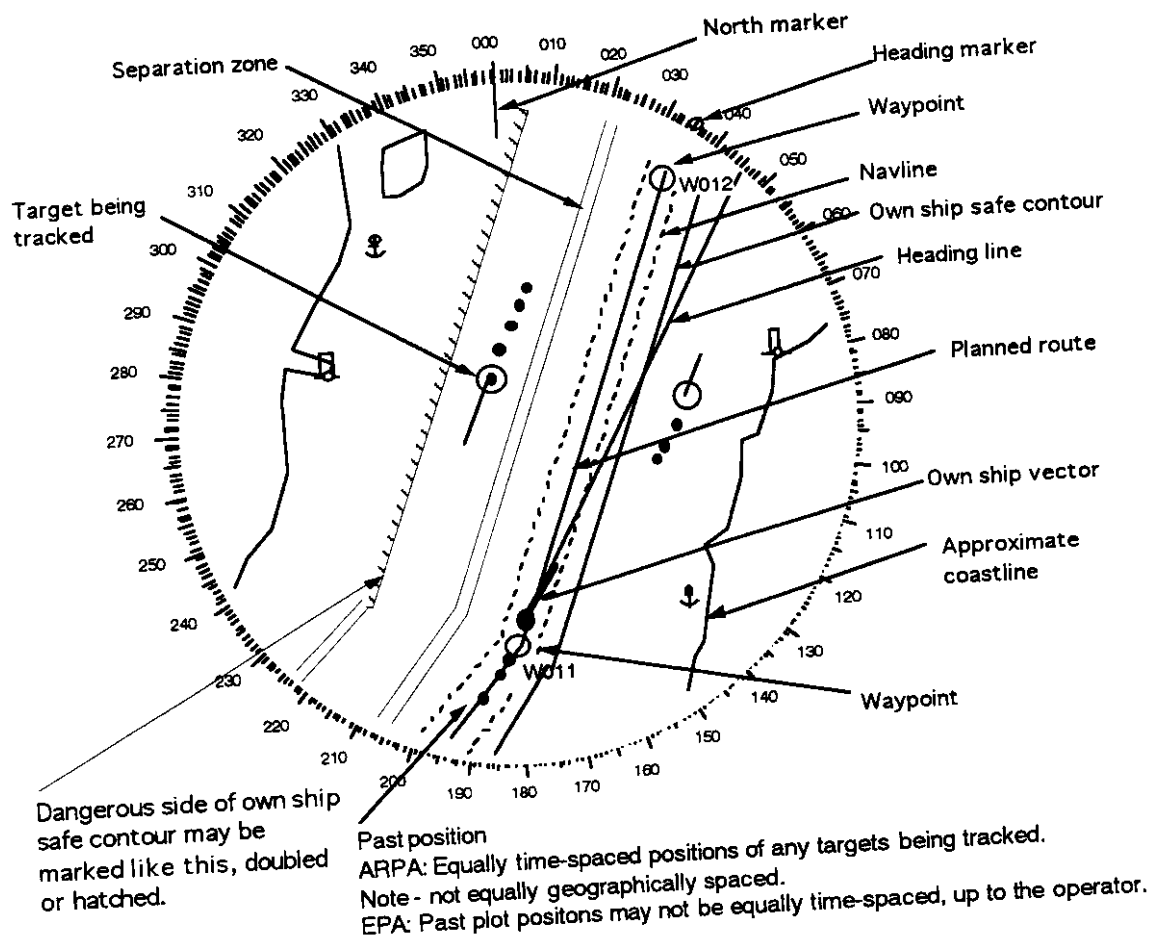

### 4.3 Display Modes

The RP-26 has two motion displays and three presentation modes.

Motion Displays: Relative Motion (RM),  
 True Motion (TM)

Presentation Modes: North-up (NU),  
 Course-up (CU),  
 Head-up (HU)

Note: HU is not available on RADAR/VIDEO PLOTTER display.

When own ship mark is at a distance from the screen center 3/4 the range in use it is automatically reset to a point of 50% radius.

#### Precaution for Chart/Memory Card

Both the chart card and memory card are susceptible to sunlight and magnetic material.

- Keep them away from direct sunlight, heat sources and active gases.
- Keep cards away from water and chemicals.
- Keep the connector free of foreign material.
- Do not drop the cards.

## How to Display Charts

To display a chart;

1. Insert the chart RAM card in one of 2 slots.

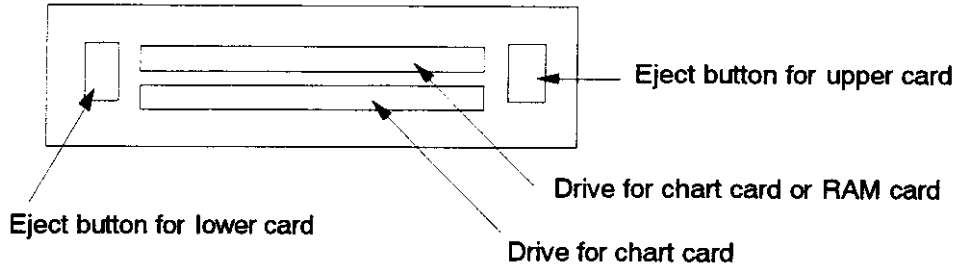

2. Press the RANGE to select the radar range. The chart appears. The following ranges are available:

0.125, 0.25, 0.5, 0.75, 1.5, 3, 6, 12, 24, 48, 96 nm

## Chart Position Correction

There may be a case where the radar picture does not match the chart overlay. This is due to an error in the position fixing system (GPS, Loran, etc.) or the different coordinates between the position fixing system and the radar. You can align chart with the radar image as follows:

1. Press [CHART ALIGN] key. CHART ALIGN appears at the top of the screen.
2. Rotate the trackball to shift the chart (or own ship) to the correct position.
3. Press [CHART ALIGN] again.

## Canceling chart correction

1. Press [NAV MENU] and [0] to display the VIDEO PLOTTER 2 menu.
2. Press [2] to select NAV DATA POSN.
3. Press [ENTER] to cancel correction. Navaid position data is restored.

The cursor position can be corrected on "ALIGN DATA" submenu in the VIDEO PLOTTER 2 menu.

## 4.4 Set-up of Video Plotter Display

### Hiding/Showing Graphics

1. Press [NAV MENU] and [8] to display the PLOT DISPLAY SELECT menu. Current selections appear in reverse video.

Blank items have been turned off on the INITIAL SETTING menu. For further details see 4.11 Initial Settings.

[PLOT DISP SELECT]	
1 [VIDEO PLOTTER 1]	
2 DANGER HIGHLIGHT	OFF/ON
3 COAST LINE	OFF/ON
4 LAND DENSITY	OFF/ON
5 PLACE NAME	OFF/ON
6 MARK	OFF/ON

7 OWN SHIP PLOT	OFF/SEPARATE/CONTINUE
8 TARGET PLOT	OFF/ON
9 CONTOUR LINE	OFF/ON
0 GRID	OFF/ON

2. Press appropriate numeral key twice to hide or show graphic.
3. Press [ENTER].
4. Repeat steps 2 and 3 to hide or show other graphics.
5. Press [NAV MENU] to close the menu.

**Note:** LAND DENSITY fills (ON) or hollows (OFF) land on an electronic chart. Land will be hollow when wrong card or wrong scale is used regardless of LAND DENSITY setting.

### Hiding/Showing Nav Data

You may select what navigation data to display on the video plotter display as follows:

1. Press [NAV MENU] to display the NAV INFORMATION 1 menu.

[NAV INFORMATION 1]	
1 [VIDEO PLOTTER 1]	
2 SELECT NAVAID	GPS/DEAD RECKONING
3 OWN SHIP POSN	OFF L/L
4 POSN	xx°xx.xxx N/S xx°xx.xxx E/S
5 +CURSOR DATA	OFF/L/L
6 WPT DATA	OFF/REL/TRUE
7 [NAV LINE]	
8 [WAYPOINT]	
9 WINO DATA	OFF/ON
0 [NAV INFORMATION 2]	

2. Press appropriate numeral key to select both item and option. Press [ENTER] to register selection.

For "OWN SHIP POSN" (manual input of position), do the following;

- 1) Press [4].
  - 2) Enter latitude in seven digits.
  - 3) Press [ENTER]. (If necessary to change to coordinate, press [4] and press [ENTER]).
  - 4) Enter longitude in eight digits.
  - 5) Press [ENTER]. (If necessary to change to coordinate, press [5] and press [ENTER]).
3. Press [0] to go to next page, the NAV INFORMATION 2 menu. Select options as you did on the previous menu. To return to the previous menu, press [1].

[NAV INFORMATION 2]	
1 [NAV INFORMATION 1]	
2 WIND GRAPH	OFF/ON
3 WIND UNIT	m/s/KT
4 CURRENT DATA	OFF/ON
5 CURRENT GRAPH	OFF/ON
6 DEPTH DATA	OFF/ON
7 DEPTH GRAPH	OFF/ON

8 [DEPTH SCALE	10/20/50/100/200/500
9 DEPTH UNIT	m/ft
0 [NAV INFORMATION 3]	

4. Press [0] to display the NAV INFORMATION 3 menu.

[NAV INFORMATION 3]	
1 [NAV INFORMATION 2]	
2 WATER TEMPERATURE	OFF/ON
3 DATE	OFF/GMT/LOCAL
	±xx.xH
4 USER CHART	OFF/ON
5 CURVED EBL	OFF/ON
6 CHART SYMBOL	OFF/ON
7 NOTEBOOK	OFF/ON

4, 5, 6: When the radar is a component of an INS.

5. To set time indication, press [3] key several time to select OFF, UTC or LOCAL and press [ENTER].

6. Press [NAV MENU] to close the menu.

## 4.5 Track

This section provides the information necessary for setting the track display conditions of both own ship and other vessels.

### Stopping Plotting of Own Ship's Track

1. Press [NAV MENU] and [5] key in order.

[OWN SHIP, TARGET PLOT]	
1 [VIDEO PLOTTER 1]	
2 RECORD OWN SHIP PLOT	OFF/ON
3 OWN SHIP PLOT INTVL	10/30SEC/1/2/3/6MIN
4 OWN SHIP PLOT COLOR	RED/MAGENTA/YEL
	GRN/CYAN/BLE
5 RECORD TARGET PLOT	OFF/ON
6 TARGET PLOT INTVL	10/30SEC/1/2/3/6MIN
7	
8 SMOOTHING	OFF/1/2/3/6/7/8/9

2. Press [2] twice to select OFF.

3. Press [ENTER].

Own ship's track is neither plotted or saved to the memory. To resume plotting, select ON at step 2 and press [ENTER].

### Stopping Plotting of Other Ship's Track

1. Press [NAV MENU] and [5] key in order.

2. Press [2] twice to select OFF.

3. Press [ENTER].

Other ship's tracks are neither plotted or saved to the memory. To resume plotting, select ON at



step 3 and press [ENTER].

### Track Plotting Interval

The memory stores ship's position in latitude and longitude at a sampling rate set on the OWN SHIP, TARGET PLOT menu. The position data so stored is used to display past own ship's track on the screen.

The plotting interval affects track reconstruction. A shorter interval provides more accurate reconstruction of track, however storage time of the track is reduced.

1. Press [NAV MENU] and [5] in order.
2. To change own ship's track plotting interval, press [3] several times to display desired plotting interval in reverse video.
3. Press [ENTER].
4. To change ship's track plotting interval, press [6] (several times) to select plotting interval.
5. Press [ENTER].

### Plot interval and track storage time

Memory capacity for own ship's track and other ship's track is 6,000 points each. For other ship's track the 6,000 points is divided equally among ten targets, so there are 600 points per target. When a track memory becomes full the oldest track is deleted to make room for a new entry.

If own ship track is stored every minute, 6,000 points of memory represents 100 hours of time span; 3 min intervals covers 16 days and 16 h. The time span covering one other ship is 1/10 of own ship as a total of 10 other ships equal to one OS.

### Memory used

Press [NAV MENU] and [0]. Memory used appears as below:

MEMORY IN USE	
OWN SHIP	= 3456
TARGET	= 1124
MARK	= 0021

### Smoothing

Even when the vessel is sailing in a straight line the track shown on the display looks irregular. This is due to signal variation of the external navaid. You can compensate for this irregularity with smoothing.

A smoothing factor between 1 and 9 is available. OFF provides no smoothing. In most cases a smoothing setting between 1 and 5 is satisfactory.

1. Press [NAV MENU] and [5] in order.
2. Press [8] to select smoothing factor.
3. Press [ENTER].

### Erasing Track

In the busy traffic, the screen may become cluttered. You can remove all or a percentage of own ship wakes from the memory to clear the display. Wakes of other ships can also be cleared.

1. Press [NAV MENU].
2. Press [9] to display the PLOTTER ERASE menu.

[PLOTTER ERASE]	
1 [VIDEO PLOTTER 1]	
2 OWN SHIP PLOT	30%/50%/80%/ALL
3 TARGET PLOT	30%/50%/80%/ALL
4 MARK	OFF/ALL
5 WPT	OFF/ALL
6 NAV LINE	OFF/ALL

3. Press [2] several times to select OWN SHIP PLOT and the amount of track points you wish to erase.
4. Press [ENTER].
5. To erase other ship's track, press [3] to select TARGET PLOT and the amount of track to erase. To ERASE means an action to remove the relevant data from the memory. Once removed, the data will not be recalled any more.
6. Press [ENTER].

## 4.6 Marks, Lines

### Entering Marks

You can inscribe marks on the display to note important points, for example, a buoy or a wreck. The mark memory capacity is 6,000 points.

### Selecting method of entry

Marks can be entered by cursor position or own ship's position.

1. Press [NAV MENU] and [0] in order.
2. Press [6] to select method of mark entry; CURSOR, L/L or OWN SHIP POSN.
3. Press [ENTER].
4. Press [NAV MENU].

### Entering marks/lines at CURSOR or OWN SHIP POSITION mode

1. Press [MARK] key to display the ENTER MARK menu.

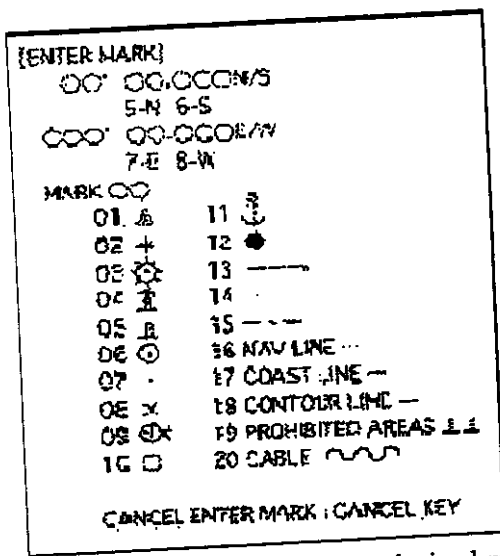

2. Enter mark number to select desired mark, followed by the ENTER key. On the OWN SHIP POSN mode, selected mark is entered to own ship's position.
3. On the CURSOR mode, operate the trackball to place the cursor on the position desired for the mark.
4. Press the [ENTER].
5. To escape the mark entry mode, press the CANCEL key.

### Entering marks on L/L mode

1. Press the MARK key.
2. Enter latitude by numeric keys followed by the ENTER key.
3. Enter longitude followed by the ENTER key.
4. Enter mark number to select desired mark followed by the ENTER key.
5. To escape the mark entry mode, press the CANCEL key.

### Erasing Marks/Lines

When the mark memory becomes full no marks can entered unless you erase unnecessary marks.

#### Erasing individual marks

1. Operate the trackball to place the cursor on the mark you want to erase.
2. Press [CANCEL].

#### Erasing all marks and all lines

1. Press [NAV MENU] and [9] key in order.
2. Press [4] key twice to select MARK OFF followed by [ENTER].

#### Erasing lines

1. Operate the trackball to place the cursor on the starting or end point of the line you want to erase. Selecting the intersection of two lines, erasing both lines.
2. Press the CANCEL.



xx xx° xx.xxxN
xxx° xx.xxxE
9 ERASE WPTxx
0 [WPT LIST 2]

## Displaying a Waypoint

A single waypoint may be shown on the display.

1. Press [NAV MENU], [1] and [8] to choose the WAYPOINT menu.

[WAYPOINT]	
1 [NAV INFORMATION 1]	
2 WPT MARK	OFF/ON
3 WPT	WPTxx xx°xx.xxxN/S xxx°xx.xxxE/W
4 WPT LINE	OFF/ON
5 WPT NO.	OFF/ON
6 WPT DISPLAY NO.	1/ALL
7 WPT DATA	VIDEO PLOTTER/NAVAID
8 ARRIVAL ALARM	OFF/ON x.xxNM xx.xMIN

3. Press [2] key twice to select WPT ON and then press [ENTER].

4. Press [3] key.

5. Enter waypoint number in two digits and press [ENTER]. Registered waypoint (01 to 109). The latitude and longitude position of the waypoint appears on the menu and the waypoint is displayed on the screen.

To hide the waypoint, select OFF in step 3 and press [ENTER]

## Deleting Waypoints

Waypoints can be deleted individually, or collectively through the waypoint list.

### Deleting individual waypoints

1. Press [NAV MENU], [4] and [3] to display the WPT LIST 1 menu.
2. Press [0] to display the page which contains the waypoint you want to delete.
3. Press [9] and enter waypoint number in two digits.
4. Press [ENTER].

### Deleting all waypoints

1. Press [NAV MENU] and [9] to display the PLOTTER ERASE menu.
2. Press [5] twice followed by [ENTER].

**Note:** Waypoints used for navigation lines cannot be deleted except by editing or deleting navigation line.

You can show the external waypoint from a navaid by following steps.

1. Press [NAV MENU] and [8] to open WAYPOINT menu.

2. Press [7] to select WPT DATA.
3. If NAVAID is not in reverse video, press [7] again.
4. Press [2].
5. If ON is not in reverse video, press [2] again.
6. Press the ENTER key.

## 4.8 Navigation Lines

30 navigation lines may be entered, and each line may have up to 30 waypoints.

### Entering New Navigation Line

1. Press [NAV MENU], [4] and [5].
2. Press [2].
3. Enter navigation line number in two digits and press [ENTER].
4. Enter waypoint number in two digits and press [ENTER].
5. Repeat step 4 to continue entering waypoint numbers.
6. Press [NAV MENU] to register navigation line.

### Adding Waypoint to Navigation Lines

To add waypoints to a navigation line;

1. Press [NAV MENU], [4] and [5].
2. Press [2]. Enter navigation line number and press [ENTER].
3. Press [8].
4. Enter "FROM" waypoint number to add and press [ENTER].
5. Enter waypoint number to add.

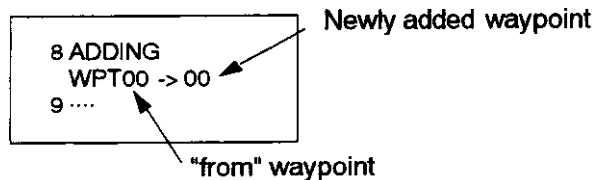

6. PRESS [NAV MENU] to close the menu.

### Removing Waypoints in Navigation Lines

1. Press [NAV MENU], [4] and [5].
2. Press [2] and enter navigation line number and press [ENTER].
3. Press [9], enter waypoint number and press [ENTER].

### Nav Line List

Press [NAV MENU], [4] and [6] to display the list.

## Deleting individual navigation lines

1. Press [NAV MENU], [4], [6] and [9].
2. Enter navigation line number you want to delete. (The line in use is not deleted.)
3. Press [ENTER].

## Deleting all navigation lines

1. Press [NAV MENU] and [9].
2. Press [6] twice to select ALL.
3. Press [ENTER].

## Displaying Navigation Lines

Navigation lines may be set up as follows:

1. Press [NAV MENU] and [3].
2. Press [2] to select NAV LINE.
3. If ON is not in reverse video, press [2] again.
4. Press [ENTER].

	[NAVLINE]
1 [NAV INFORMATION 1]	
2 NAV LINE	OFF/ON
3 NAV LINE NO.	xx/xx/xx/xx/xx
4 NAV WIDTH	OFF/ON x.xxNM
5 WPT NO.	OFF/ON
6 WPT	xx (x)→→xx)→ (xx)→(xx)
7 NAVLINE DATA	VIDEO PLOTTER/NAVAID
8 ARRIVAL ALARM	OFF/ON x.xxNM xx.xMIN
9 TURNING LINE	OFF/ON/REVISED

5. Press [7] to choose NAV LINE DATA; VIDEO PLOTTER for internally generated navigation width data or NAV AID for external navaid generated data.
6. Press [ENTER].
7. Press [4] to select NAV WIDTH.
8. Enter line width (in nautical miles) and then press [ENTER].
9. To display waypoint number of the route on the display, press [5] to select ON and then press [ENTER].
10. To skip a waypoint, press [6], enter next waypoint to head to, and then press [ENTER].
11. Press [ENTER].
12. If you want to be alerted when own ship nears a waypoint, press [8] to select ON, press [ENTER], enter arrival alarm range and press [ENTER].

13. Press [9] to set turning line and then press [ENTER].

OFF: Turns turning lines off.

ON: Use this setting when vessel is not to correct cross track error to return to course set, after arriving at turning line location.

REVISED: Use this setting when vessel is to return to course set after correcting cross track error, after arriving at turning line location.

14. Press [3].

15. Enter navigation line number and then press [ENTER].

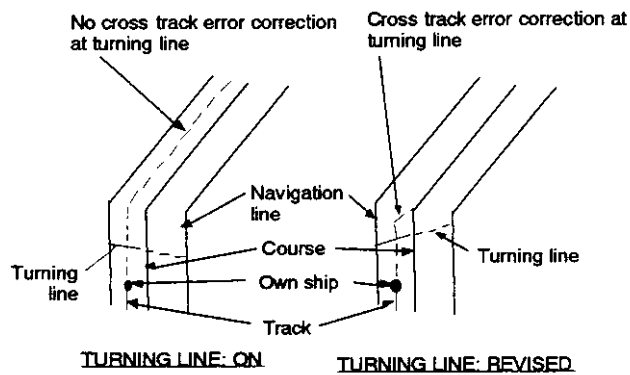

## 4.9 Recording & Replaying Data

### Formatting Memory Cards

Before you can use a memory card (RAM card) with the RP-26, the card must be formatted. Formatting prepares the recording surface of the card for use with the system. Insert a new memory card in the right side card drive and follow the procedure below to format it.

1. Press [NAV MENU] and [6] to choose CARD.
2. If RECORD is not in reverse video, press [6] again.
3. Press [ENTER].

[RECORD CARD]	
1 [VIDEO PLOTTER 1]	
2 OWN SHIP PLOT	T
3 TARGET PLOT	A
4 MARK	M
5	
6	
7	
8	
9	
0 FORMAT	NO/YES

4. Press [0] twice to select YES.
5. Press [ENTER].

### Recording Data

When the track memory becomes full, the oldest track is erased to make room for the latest. Further, when the mark memory becomes full you cannot enter another mark unless you erase a mark. Thus you should save important data to a memory card.



1. Insert a formatted RAM card into the card drive.
2. Press [NAV MENU] and [6] to choose CARD.
3. If RECORD is not in reverse video, press [6] again.
4. Press [ENTER].
5. To record own ship's track press [2]; target track press [3]; marks press [4]; or radar map press [5].
6. Enter file name. You may use ten figures.
7. Press [ENTER].

### Data

1. Press [NAV MENU] and [6].
2. If REPLAY is not in reverse video, press [6] again.
3. Press [ENTER].

[REPLAY CARD 1]	
1	[VIDEO PLOTTER]
2	XXX
3	XXX
4	XXX
5	XXX
6	XXX
7	XXX
8	XXX
9	XXX
0	[REPLAY CARD 2]

4. Press numeral key to select file to replay. You can go to the next page by pressing [0].
5. Press [ENTER].

## 4.10 Initial Settings

An item on the PLOTTER DISP SELECT menu can be deleted through the VIDEO PLOTTER INITIAL SETTING menu.

1. Press [NAV MENU].
2. Press [0] twice to display the VIDEO PLOTTER INITIAL SETTING menu.

[VIDEO PLOTTER INITIAL SETTING]	
1	[VIDEO PLOTTER 2]
2	DANGER HIGHLIGHT      ON/OFF
3	COASTLINE                ON/OFF
4	LAND DENSITY            ON/OFF
5	PLACE NAME              ON/OFF
6	MARK                      ON/OFF
7	OWN SHIP PLOT          ON/OFF
8	TARGET PLOT             ON/OFF
9	CONTOUR LINE            ON/OFF
0	GRID                      ON/OFF

3. Press appropriate numeral key to turn on or off item.
4. Press [ENTER].

5. Repeat 3 and 4.

**NOTE: If Video Plotter fails to provide intended functions, turn ON the required functions on this menu.**

# 4.11 Latitude Error Table (on 96 nm range scale)

The longitude lines concentrate on the north pole and south pole, namely, 1 nm is equivalent to 1 minute at 0 degree latitude, 2 minutes at 60 degrees latitude, 3 minutes at 70 degrees latitude and so on. For this reason, a longitude error occurs on the radar display. For example, when own ship is at 60°N and 135°E, even if the cursor indication is 62°N and 139°E, the real cursor position is deviated to left (west) side. The table below shows the longitude error, represented from 0° to 90° at 96 nm from the radar center (own ship).

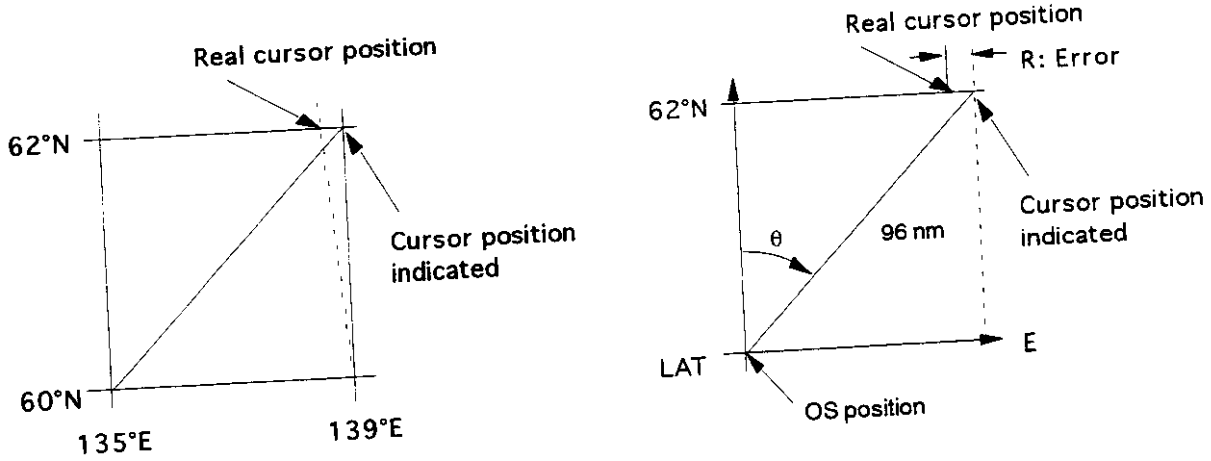



EBL LAT	5°	10°	15°	20°	25°	30°	35°	40°	45°
75°	0.2256	0.4444	0.6496	0.8350	0.9950	1.1248	1.2202	1.2786	1.2980
70°	0.21980213	0.43290201	0.632803	0.8134132	0.96923215	1.09551918	1.1884382	1.24517456	1.26402037
65°	0.21229339	0.41810678	0.61115946	0.78556318	0.93600295	1.05790007	1.14755221	1.20224625	1.22034042
60°	0.20316898	0.40012949	0.58486463	0.75173456	0.89565021	1.0122297	1.09793265	1.15016811	1.16737294
55°	0.19249832	0.37910698	0.55411863	0.71218478	0.84848102	0.95885565	1.03998717	1.08933651	1.10552105
50°	0.18036264	0.35519924	0.51915545	0.66721485	0.79485438	0.89818413	0.97406698	1.02021439	1.03525547
45°	0.16685429	0.32858822	0.48024119	0.61716701	0.73517843	0.83067689	0.90076355	0.94332783	0.95711098
40°	0.15207608	0.29947644	0.437672	0.56242216	0.66990732	0.7568477	0.82060477	0.85926197	0.87168229
35°	0.13614047	0.26808546	0.39177186	0.53339693	0.59953781	0.67725844	0.73420069	0.76865661	0.77961957
30°	0.11916876	0.2346542	0.3428901	0.44054055	0.52460545	0.59251483	0.6422089	0.67220131	0.68162348
25°	0.10129001	0.19943707	0.29139874	0.37433139	0.44568053	0.50326182	0.54532952	0.57063015	0.57843983
20°	0.08264056	0.16270211	0.23768966	0.30527334	0.36336372	0.41017869	0.44429984	0.46471615	0.47085389
15°	0.06336208	0.12472888	0.18217162	0.23389198	0.27828148	0.31397386	0.33988878	0.35526538	0.35968447
10°	0.04360137	0.0858064	0.12526714	0.16073056	0.19108136	0.21537949	0.23289096	0.24311083	0.24577764
5°	0.02350833	0.04623087	0.0674093	0.08634588	0.10242699	0.11514595	0.1241207	0.12910605	0.13000029
0°	0.00323737	0.0063035	0.00903844	0.01130406	0.01293309	0.01403609	0.0144058	0.0141187	0.01323356

EBL LAT	50°	55°	60°	65°	70°	75°	80°	85°	90°
75°	1.2780	1.2192	1.1233	0.9933	0.8332	0.6479	0.4431	0.2249	0
70°	1.24442563	1.18701379	1.09356117	0.96694117	0.81103484	0.3061092	0.43117887	0.21881975	0
65°	1.20131324	1.14577786	1.05546143	0.93315023	0.78260251	0.60843159	0.41596331	0.21107193	0
60°	1.14905813	1.09582188	1.00932899	0.89225746	0.74821409	0.58162173	0.397582	0.20171772	0
55°	1.08805799	1.03752602	0.95551494	0.84457408	0.70813132	0.55038538	0.37617487	0.19082831	0
50°	1.0187708	0.97133397	0.89442885	0.79046297	0.66265924	0.51496026	0.35190481	0.17848659	0
45°	0.94174265	0.89774948	0.82653562	0.73033596	0.61214392	0.47561599	0.32495654	0.16478648	0

40°	0.85754099	0.81733258	0.75235195	0.66465066	0.55696981	0.43265198	0.29553516	0.14983224	0
35°	0.76681293	0.73069528	0.63744242	0.59390696	0.49755683	0.38639524	0.26386458	0.13373769	0
30°	0.67024897	0.63849695	0.58741521	0.51864327	0.43435714	0.33719779	0.23018583	0.11662531	0
25°	0.568584	0.54143927	0.49791741	0.43943239	0.36785173	0.28543407	0.19475522	0.09862535	0
20°	0.46259176	0.44026091	0.40463016	0.35687717	0.29854675	0.23149802	0.15784242	0.07987479	0
15°	0.35307892	0.3357319	0.30826343	0.2716059	0.22696965	0.17580013	0.11972833	0.06051633	0
10°	0.2487894	0.22864776	0.20955062	0.18426754	0.15366517	0.1187643	0.08070304	0.0406973	0
5°	0.12684572	0.11982348	0.10624302	0.09552679	0.0791912	0.04106355	0.04106355	0.02056855	0
0°	0.01184713	0.01008727	0.008104	0.00605903	0.00411455	0.00111154	0.00111154	0.00028325	0



# Chapter 5 MAINTENANCE

<b>⚠ WARNING</b>	
	<p><b>Do not open the equipment.</b></p> <p>Hazardous voltage which can cause electrical shock exists inside the equipment. Only qualified personnel should work inside the equipment.</p>
	<p><b>Turn off the radar power switch before servicing the antenna unit. Post a warning sign near the switch indicating it should not be turned on while the antenna unit is being serviced.</b></p> <p>Prevent the potential risk of being struck by the rotating antenna and exposure to RF radiation hazard.</p>
	<p><b>Wear a safety belt and hard hat when working on the antenna unit.</b></p> <p>Serious injury or death can result if someone falls from the radar antenna mast.</p>

Periodic checks and maintenance are important for proper operation of any electronic systems. This chapter contains maintenance instructions to be followed to obtain optimum performance and the longest possible life of the equipment.

## 5.1 Periodic Maintenance Schedule

Interval	Check point	Check and measures	Remarks
3 to 6 months	Exposed nuts and bolts on antenna unit	Check for corroded or loosened nuts and bolts. If necessary, clean and repaint them thickly. Replace them if heavily corroded.	Sealing compound may be used instead of paint. Apply a small amount of grease between nuts and bolts for easy removal in future.
	Antenna radiator	Check for dirt and cracks on radiator surface. Thick dirt should be wiped off with soft cloth dampened with fresh water. If a crack is found, apply a slight amount of sealing compound or adhesive as a temporary remedy, then call for	Do not use plastic solvent (acetone) for cleaning. If you need to remove ice from antenna unit, use a wooden hammer or plastic head hammer. Crack on the unit may cause water ingress, causing serious damages to internal circuits.

		repair.	
	Terminal strips and plugs in antenna unit	Open antenna cover to check terminal strip and plug connections inside. Also check the rubber gasket of antenna covers for deterioration.	When closing antenna covers in position, be careful not to catch loose wires between covers and unit.
6 months to one year	CRT and surrounding components	High voltage at CRT and surrounding components attract dust in environment which will cause poor insulation. Ask your nearest FURUNO representative or dealer to clean internal high-voltage components.	If CRT anode rubber cap or wire sheath is cracked, ask your dealer to replace it. Wait for at least 3 minutes until high voltage components (CRT and HV capacitors) discharge their residual charges before accessing them.
	Terminal strips, sockets, earth terminal	Check for loose connections. Check contacts and plugs for proper seating, etc.	

## 5.2 Life Expectancy of Major Parts

Parts	Type	Life expectancy	Remarks
Antenna motor	D8G-571 (X-band) 42 rpm D8G-571 (X-band) 24 rpm	Gears more than 10,000 h	Wind load 100 kt
Magnetron	MG 5241, X-band, 12 kW MG 5436, X-band, 25 kW MG 5223F, S-band, 30 kW MG 5240, S-band, 60 kW	2,000 - 3,000 h	





## 5.3 Replacement of Battery

A battery installed on the RP board or Gyrocompass board inside the display unit help preserve the data when the power is turned off. The life of the battery is about five years. When the battery voltage is low, NG appears at diagnostic test for RP board. Contact your dealer for replacement.

	Battery Type	Code number
RP board	ER3s	000 127 759
GC board	CR 1/2 8.L	000 103 769

# Chapter 6

# TROUBLESHOOTING

 <b>WARNING</b>	
	<b>Do not open the equipment.</b> Hazardous voltage which can cause electrical shock exists inside the equipment. Only qualified personnel should work inside the equipment.
	<b>Turn off the radar power switch before servicing the antenna unit. Post a warning sign near the switch indicating it should not be turned on while the antenna unit is being serviced.</b>  Prevent the potential risk of being struck by the rotating antenna and exposure to RF radiation hazard.
	<b>Wear a safety belt and hard hat when working on the antenna unit.</b>  Serious injury or death can result if someone falls from the radar antenna mast.

## 6.1 Easy Troubleshooting

This paragraph describes how to cure operational problems, which can be made by observing the radar picture and using operator controls and keys without opening the display unit, antenna unit or other equipment units.

The table below shows user-level troubleshooting procedures.

Problem	Remedy
Key beep inaudible	Adjust key beep level on RADAR 2 menu referring to paragraph 1.32.
No own ship mark	On the R-type, check that SHIP'S MARK ON is selected at the RADAR 2 menu, referring to section 1.32. Also, own ship information (length, width, etc.) should have been entered in initial settings. Consult your service representative or Furuno dealer for details. On the IMO-type, the own ship marks is not available.

## 6.2 Advanced-level Troubleshooting

This paragraph describes how to cure hardware and software troubles which should be carried out by qualified service personnel.



**Note:** This radar equipment contains complex modules in which fault diagnosis and repair down to component level are not practicable by users.

### Serviceman qualification

All adjustments of radio transmitter during or coinciding with the installation, servicing, or maintenance which may affect the proper operation must be performed by or under the immediate supervision and responsibility of a person holding an operator certificate containing a ship radar endorsement.

This is what the U.S. Codes of Federal Regulations part 80.169 implies (not exact extract).

As such, every administration sets forth its own rule; service personnel must be aware of this kind of competency requirements.

### Service call

When making a service call to your service agent, check S/N and symptom beforehand.

Problem	Probable causes or check points	Remedy
Power turned on but radar does not operate at all. Control panel is not illuminated.	<ol style="list-style-type: none"> <li>1 Blown fuse F1 and F2.</li> <li>2 Mains voltage/polarity</li> <li>3 Power supply board</li> <li>4 Illumination lamps</li> </ol>	<ol style="list-style-type: none"> <li>1 Replace blown fuse.</li> <li>2 Correct wiring and input voltage.</li> <li>3 Replace power supply board.</li> <li>4 Replace defective lamps.</li> </ol>
CRT brilliance adjusted but no picture	<ol style="list-style-type: none"> <li>1 RADAR 1/2/3 menu settings</li> <li>2 CRT high tension voltage</li> <li>3 SPU board</li> </ol>	<ol style="list-style-type: none"> <li>1 In case of single display installation without radar interswitching unit, make sure RADAR 1 is selected on RADAR 3 menu.</li> <li>2 Check high tension voltage supply with utmost care. DANGER.</li> <li>3 Replace SPU board.</li> </ol>
Antenna not rotating	<ol style="list-style-type: none"> <li>1 Antenna drive mechanism (note that the message BRG SIG MISSING appears in standby.</li> <li>2 Defective antenna drive motor relay (thermal relay K2, 200/220/380, 440/100 VAC)</li> <li>3 INT 9170 board.</li> </ol>	<ol style="list-style-type: none"> <li>1 Make sure that there is no short circuit across #1 and #2 of J461 on IN9170 board.</li> <li>2 Press relay reset button.</li> <li>3 Check that antenna switch is on.</li> </ol>
Data and marks not displayed in Transmit status	<ol style="list-style-type: none"> <li>1 SPU board</li> </ol>	<ol style="list-style-type: none"> <li>1 Replace SPU board.</li> </ol>
Adjust GAIN control with A/C SEA control set at minimum. Marks and legends appear but no noise or echo	<ol style="list-style-type: none"> <li>1 IF amplifier</li> <li>2 Signal cable between antenna and display</li> </ol>	<ol style="list-style-type: none"> <li>1 Replace IF amplifier.</li> <li>2 Check continuously and isolation of coaxial cable. Note: Disconnect the plug and lugs at both ends of coaxial cable before checking it by ohmmeter.</li> <li>3 Check video coax line for secure</li> </ol>

	3 Video amplifier board	connection. If connection is good, replace SPU board.
Marks, legends and noise appear but no echo (Transmission leak representing own ship position is absent)	1 TX fuse F801 (Transmitter unit) 2 Magnetron 3 Modulator board 4 SPU board	1 If fuse is blown, replace it. If it blows again, the modulator or associated circuit may be defective. 2 Check magnetron current with the check meter in the sub panel. Replace magnetron. 3 Replace modulator board. 4 Replace SPU board.
Picture not updated or picture freeze-up	1 Bearing signal generator board (in antenna unit) 2 SPU board 3 Video freezeup	1 Check the connection of signal cables. 2 Replace SPU board. 3 Turn off and on the radar.
Incorrect orientation of picture	1 SPU board 2 Gyro interface	1 The message HD SIG MISSING appears when the heading pulse is not received during standby. 2 Replace the gyro interface.
TUNE control adjusted but poor sensitivity	1 Deteriorated magnetron 2 Detuned MIC 3 Dirt on radiator face 4 Water ingress to the waveguide or other feeder line 5 Second trace rejection is ON	1 With radar transmitting on 48 nm range, check magnetron current. If current is below normal, magnetron may be defective. Replace it. 2 Check MIC detecting current. If it is below normal value, MIC may have become detuned. MIC must be tuned. 3 Clean the radiator surface. 4 Remove water from the feeder line. 5 Disable the second-trace rejecter referring to section 1.35.
Range changed but radar picture not changing	1 Defective range key 2 SPU board 3 Mother board 4 Video freezeup	1 Try to hit [+] and [-] range keys several times. If unsuccessful, replacement of keypad may be required. 2 Replace SPU board. 3 Replace mother board. 4 Turn off and on radar.
Interference rejector inoperable (interference rejection level not displayed)	1 Bad contact of key 2 SPU board 3 Mother board	1 Repair contact of key. 2 Replace SPU board. 3 Replace mother board.
Echo stretch ineffective (Neither ES1 nor ES2 is displayed)	1 SPU board	1 Replace SPU board.
Only 2 parallel index lines when 6 lines are wanted	1 Incorrect setting of index line intervals	1 Set index line interval referring to section 1.26.
Range rings are not displayed	1 Adjust the brilliance of range rings at the BRILLIANCE 1 menu to	1 Replace associated circuit board if unsuccessful.

	see if intensity is increased. 2 SPU board	2 Replace SPU board.
Poor discrimination in range	1 Sea clutter control not functioning properly	1 Improper setting of A/C SEA control. If A/C SEA is seen only at very close range, suspect inaccurate frequency of reference oscillator.
True motion presentation not working correctly	1 Poor contact of MODE key 2 Selection not accessed 3 Speed entry incorrect 4 TM display inaccurate	1 Try to press MODE key a little harder. 2 Press MODE key until TM appears. 3 Enter correct own ship speed referring to section 1.24. 4 Make sure that speed and compass inputs are accurate.
Target not tracked correctly	1 Poor definition of targets in sea clutter	1 Adjust A/C SEA and A/C RAIN controls referring to section 1.13 and 1.14.

### 6.3 Diagnostic Test

A diagnostic test program is provided to enable testing of major circuit boards in the radar display unit. Note that the normal radar picture is lost during this test.

Proceed as follows to execute the diagnostic test:

Proceed as follows to execute the diagnostic test:

1. Press the RADAR MENU key to show the FUNCTIONS 1 menu.
2. Press the [0] key three times to show the FUNCTIONS 4 menu.
3. Press the key [3] to select menu item TEST. Then, press the ENTER key.

Program numbers appear. The diagnostic test is executed and the screen shows test results as shown on the next page. OKs appear for normal operation. If NG (No good) appears, corresponding components may be defective. Consult your dealer.

4. Small squares displayed at the right bottom of the test result screen are for testing the control and keys on the operator control panel. As you operate these controls and keys, corresponding squares are highlighted, indicating that your control/key operations are properly recognized.
5. To terminate the diagnostic test, press STBY/TX key once or twice.

**RADAR MENU**

↓ Press [RADAR MENU] key.

**[FUNCTIONS 1]**

- 1 TARGET TRAILS
- 2 GUARD ALARM      1 or 2
- 3 ORIGIN MARK      1 to 10
- 4 INDEX LINES
- 5
- 6 PULSE WIDTH
- 7 INT REJECT
- 8 ARPA
- 9 VIDEO PLOT
- 0 [FUNCTION 2]

↓ Press [0] key.

**[FUNCTIONS 2]**

- 1 [FUNCTIONS 1]
- 2 BKGD COLOR    BLK(GRN CHAR)/  
                  BLK(RED)/  
                  BLU (ECHO AREA)  
                  BLU/  
                  BRT BLU
- 3 ECHO STRETCH    OFF/1/2/3
- 4 ECHO AVERAGE    OFF/1/2/3
- 5 TARGETS COLOR    YEL/GRN
- 6 SHIP SPEED            LOG/NAV/MAN
- 7 SET, DRIFT    OFF/MAN  
                                  SET = xxx.x°  
                                  DRIFT = xx.xKT
- 8 INDEXLINES      NO. 2 VRM/MAN  
                                  MAN = XX.XXNM
- 9 BRILLIANCE (1)
- 0 [FUNCTION 3]

↓ Press [0] key.

**[FUNCTIONS 3]**

- 1 [FUNCTIONS 2]
- 2 RADAR 1
- 3 FUNCTION KEY 1
- 4 FUNCTION KEY 2
- 5 FUNCTION KEY 3
- 6 FUNCTION KEY 4
- 7 RADAR      1/2
- 7 INTERSWITCH
- 8
- 9 GYRO SETTING
- 0 [FUNCTIONS 4]

↓ Press [0] key.

**[FUNCTIONS 4]**

- 1 [FUNCTIONS 3]
- 2
- 3 TEST

The test program checks the logic boards and the keyboard. The squares (□) represent the corresponding keypads. Numerals indicate the position of the controls under check. Note: Analog controls such as Brilliance, A/C Rain, A/C Sea and Gain controls can not be tested.

**FR-2105 TEST**

	PROGRAM NO	ROM	RAM	CRAM	DISPSW
MAIN	0359149101	OK	OK		
ARP	1859038104	OK	OK	OK	1010
DSP	1859039101	OK	OK	OK	
RP	0359156101	OK	OK	OK	0001
DRAM			OK		
RP BOARD BAT		OK			
RP CARD 1		OK	CARD 2		OK
CARD 1 BAT		OK			
ANTENNA SPEED		42 RPM			
TRIG FREQ		872 Hz			
MAG CURRENT		11 V			
R. MONITOR		1.2 V			
TUNE IND		1.1 V			
				□ □ □ □ □ □ □	
	1 2 3		002	□ □ □ □	2 5 1
□ □ □ □ □ □ □			□ □	□ □ □ □	0 0 8
□ □ □ □				□ □ □ □	

To quit press [STBY/TX] key twice.

To quit the test program, press the [STBY/TX] key twice.

# Chapter 7

# MENU OVERVIEW

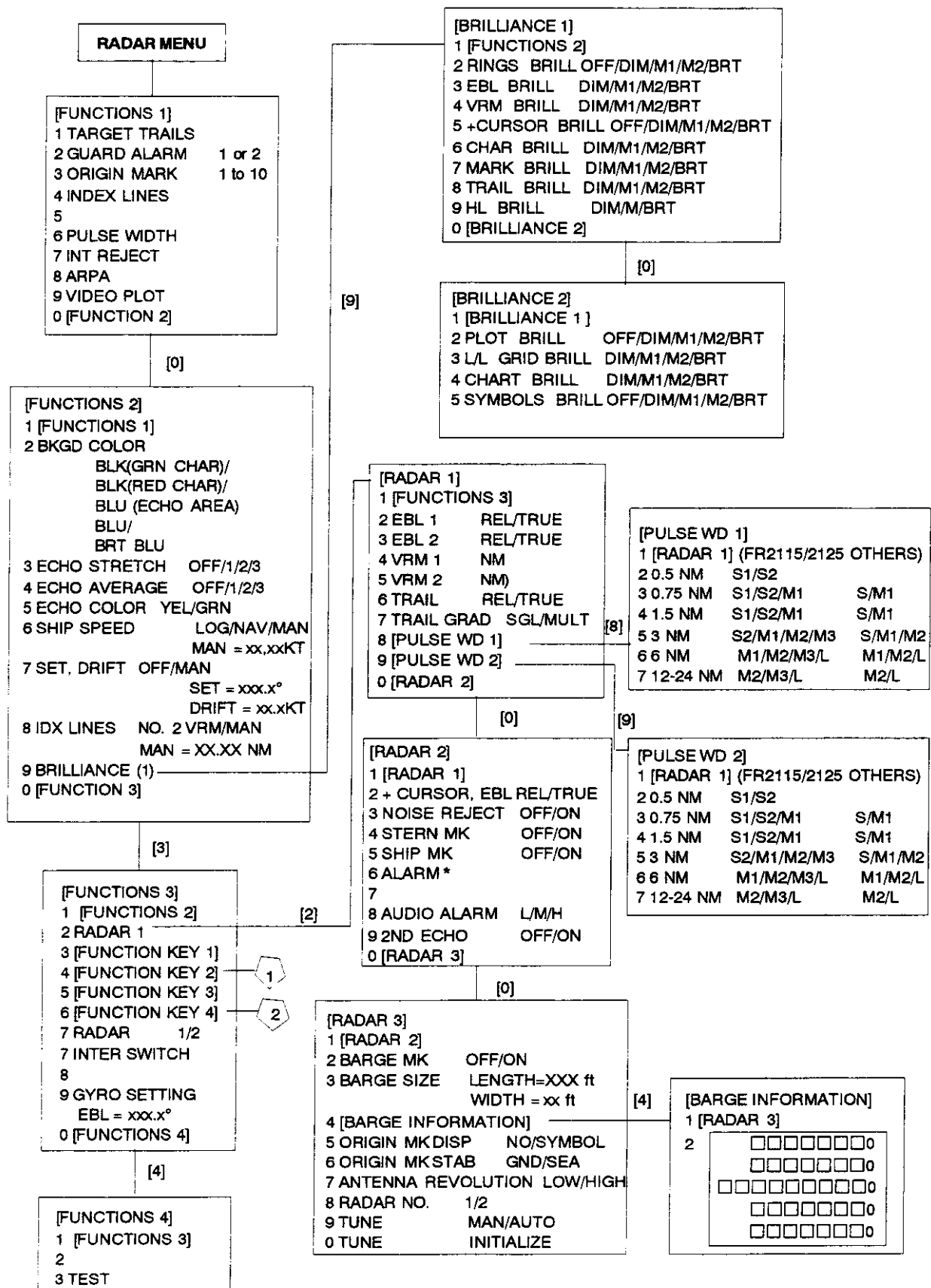

1

[3], [4] or [5]

[FUNCTION KEY 1] (PICT)

1 [FUNCTIONS 3]

2 FUNCTION KEY 1 PICTURE/OPERATION

3 PICTURE FUNC1/BUOY/SHIP/  
SHORT/LONG/CRUISING/  
HARBOR/COAST/SEA/  
ROUGH SEA/RIVER/BIRD

4 INT REJECT OFF/1/2/3

5 ECHO STRETCH OFF/1/2/3

6 ECHO AVERAGE OFF/1/2/3

7 A/C AUTO OFF/ON

8 [FUNC 1 PULSE WD]

9 NOISE REJECT OFF/ON

0 VIDEO CONTRAST 1/2/3

[8]

[FUNC 1 PULSE WD]

1 [FUNCTION KEY 1]

2 0.5 NM	S1/S2		S/M1
3 0.75 NM	S1/S2/M1		S/M1
4 1.5 NM	S1/S2/M1		S/M1
5 3 NM	S2/M1/M2/M3		S/M1/M2
6 6 NM	M1/M2/M3/L		M1/M2/L
7 12-24 NM	M2/M3/L		M2/M3/L

(In the case of FR-2115/2125)

[2] [2] to toggle between OPERATION and PICTURE menu.

[FUNCTION KEY 1] (OPR)

1 [FUNCTIONS 3]

2 FUNCTION KEY 1 PICTURE/OPERATION

3 OPERATION TARGET TRAILS/  
GUARD ALALRM/ARPA/  
VIDEO PLOT/  
BKGD COLOR/INDEX LINES/  
INT REJECT/2ND ECHO/ORIGIN MARK/  
PLS WD1/PLS WD 2/  
ECHO STRETCH 1/2/3  
ECHO AVG 1/2/3  
ECHO COLOR/  
CHAR BRILL/MARK BRILL/  
TRAIL BRILL/RINGS BRILL/  
EBL BRILL/VRM BRILL/  
+CURSOR BRILL/HL BRILL/  
CHART BRILL/NOISE REJECT/  
BARGE INFORMATION/  
CURVED EBL/USER CHART/  
POSITION ADJ/

2

[FUNCTION KEY 4] (OPR)

1 [FUNCTIONS 3]

2 FUNCTION KEY 1 OPERATION/WATCH ALARM

3 OPERATION TARGET TRAILS/  
GUARD ALALRM/ARPA/  
VIDEO PLOT/  
BKGD COLOR/INDEX LINES/  
INT REJECT/ORIGIN MARK/  
PLS WD1/PLS WD 2/  
ECHO STRETCH 1/2/3  
ECHO AVG 1/2/3  
ECHO COLOR/  
CHAR BRILL/MARK BRILL/  
TRAIL BRILL/RINGS BRILL/  
EBL BRILL/VRM BRILL/  
+CURSOR BRILL/HL BRILL/  
CHART BRILL/NOISE REJECT/  
BARGE INFORMATION/  
CURVED EBL/USER CHART/  
POSITION ADJ/

Press [2] once or twice to toggle between OPERATION and WATCH ALARM followed by ENTER key.

[FUNCTION KEY 4] (WATCH ALARM)

1 [FUNCTIONS 3]

2 FUNCTION KEY 4 OPERATION/WATCH ALARM

3 WATCH ALARM INTERVAL  
6/10/12/15/20 MIN

**[PLOT MENU] KEY**

[EPA]	
1 VECTOR TIME	30SEC/1/2/3/6/12/15/30MIN
2 COLLISION ALARM	OFF/ON
	CPA x.xNM
	TCPA xx.xMIN
3 MARK SIZE	STD/LARGE
4 PLOT NO.	OFF/ON

**[NAV MENU] KEY**

(Radar only mode)

[NAV INFORMATION 1]	
1 [RADAR MAP]	
2 SELECT NAVAID	GPS/DEAD RECKONING
3 OWN SHIP POSN	OFF/L/L
4 POSN	xx°xx.xxx N/S
	xx°xx.xxx E/S
5 +CURSOR DATA	OFF/L/L
6 WPT DATA	OFF/REL/TRUE
7 [NAV LINE]	
8 [WAYPOINT]	
9 WIND DATA	OFF/ON
0 [NAV INFORMATION 2]	

[1]

[RADAR MAP]	
1 [NAV INFORMATION 1]	
2 MAP	OFF/ON
3 MAP NO.	MAP xx
	MAP LIST
	xx xx xx xx xx
	xx xx xx xx xx
4 NAV DATA POSN	
5 ALIGN +CURSOR DATA	OFF/ON
6 MARK ENTRY MODE	CURSOR/OWN SHIP POSN/L/L
7 [ENTER MAP]	
8 [MAP DISP SELECT]	
9 [MAP ERASE]	

[7]

[8]

[ENTER MAP]	
1 [RADAR MAP]	
2 ENTER MAP	MAP xx
9 ERASE MAP	MAP xx

[MAP DISP SELECT]	
1 [RADAR MAP]	
2 DANGER HILIGHT	OFF/ON
3 COASTLINE	OFF/ON
4 MARK	OFF/ON
5 NAVLINE	OFF/ON
6 PROHIBITED AREA	OFF/ON
7 BUOY	OFF/ON
8 CONTOUR LINE	OFF/ON

[0]

[NAV INFORMATION 2]	
1 [NAV INFORMATION 1]	
2 WIND GRAPH	OFF/ON
3 WIND UNIT	m/s/KT
4 CURRENT DATA	OFF/ON
5 CURRENT GRAPH	OFF/ON
6 DEPTH DATA	OFF/ON
7 DEPTH GRAPH	OFF/ON
8 [DEPTH SCALE]	10/20/50/100/200/500
9 DEPTH UNIT	m/ft
0 [NAV INFORMATION 3]	

[7]

[NAV LINE]	
1 [NAV INFORMATION]	
2 NAV LINE	OFF/ON
3 NAV LINE NO.	xx - xx - xx - xx
4 NAV WIDTH	OFF/ON
5 WPT NO.	x.xxxNM
6 WPT	xx
	(xx) - Åδ - xx -
	(xx) - Åü - xx -
7 NAV LINE DATA	VIDEO PLOTTER/NAVAID/OFF/ALL
8 ARRIVAL ALARM	OFF/ALL
9 TURNING LINE	x.xxxNM
	OFF/ON/REVISED

[0]

[NAV INFORMATION 3]	
1 [NAV INFORMATION 2]	
2 WATER TEMPERATURE	OFF/ON
3 DATE	OFF/UTC/LOCAL
	xx.xH
4 USER CHART	OFF/ON
5 CURVED EBL	OFF/ON
6 CHART SYMBOL	OFF/ON
7 NOTEBOOK	OFF/ON

[8]

[WAYPOINT]	
1 [NAV INFORMATION 1]	
2 WPT MARK	OFF/ON
3 WPT	WPTxx
	WPTxx
	WPTxx
	WPTxx
	WPTxx
4 WPT LINE	OFF/ON
5 WPT NO.	OFF/ON
6 WPT DISPLAY NO.	1/ALL
7 WPT DATA	VIDEO PLOTTER/NAVAID
8 ARRIVAL ALARM	OFF/ON
	x.xxxNM

[9]

[MAP ERASE]	
1 [RADAR MAP]	
2 DANGER HILIGHT	OFF/ALL
3 COASTLINE	OFF/ALL
4 MARK	OFF/ALL
5 NAVLINE	OFF/ALL
6 PROHIBITED AREA	OFF/ALL
7 BUOY	OFF/ALL
8 CONTOUR LINE	OFF/ALL



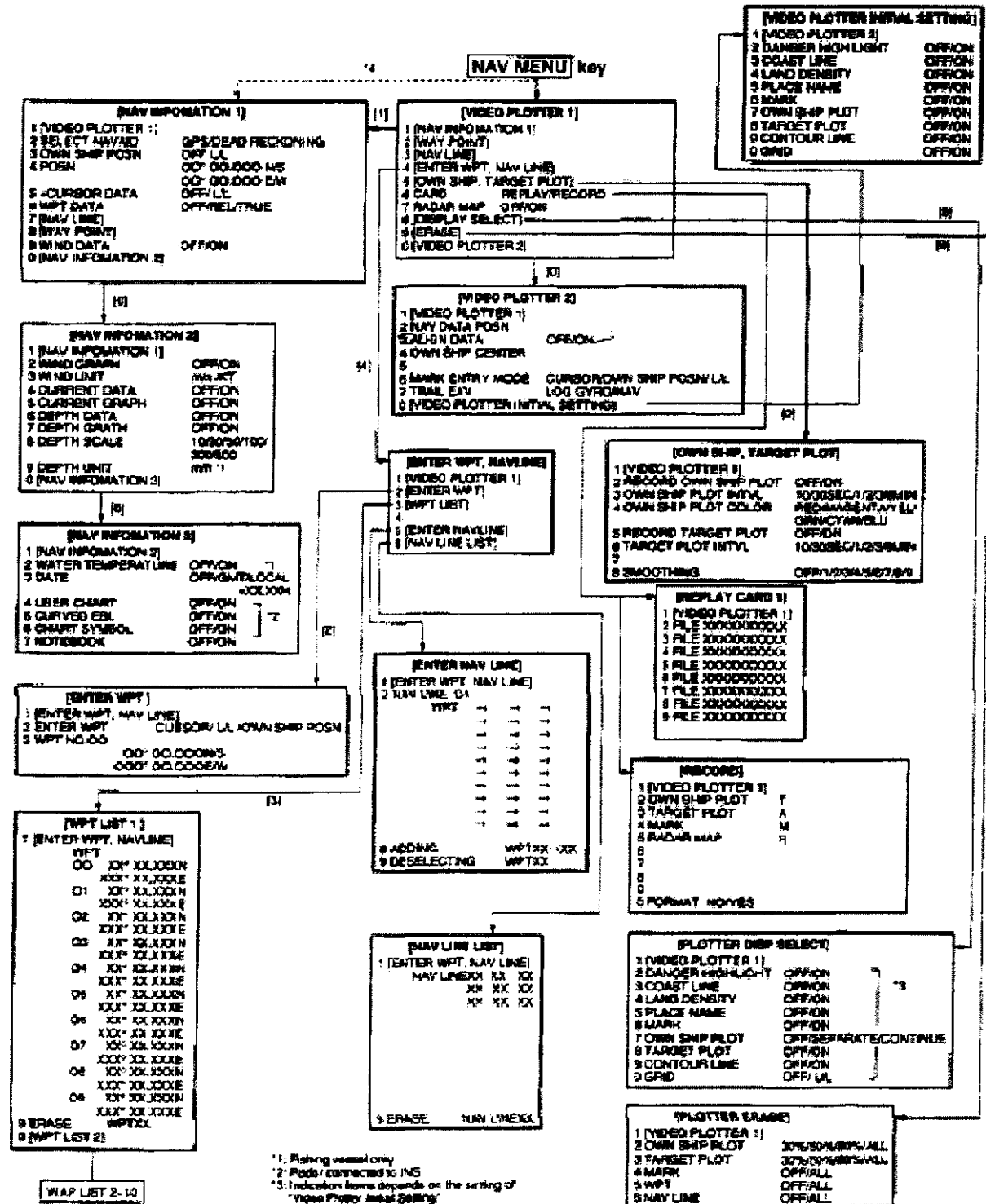

1: Rating vessel only  
 2: Radar connected to I/S  
 3: Indicator how depends on the setting of "Video Plotter Initial Settings"  
 4: The NAV INFORMATION 1 menu appears by pressing the NAV MENU key at the Radar only display mode

# APPENDIX

## A.1 Performance Monitor (Option)

A performance monitor is required for a radar installed on vessels of 300 GT and upward engaged in international voyages. For X-band radars, the FURUNO PM-30 or PM-50 satisfies the requirement covering  $9410 \pm 50$  MHz. For S-band radars, the PM-50 is available covering  $3050 \pm 30$  MHz. The following describes how to use these performance monitors.

The performance monitor is an independent unit, namely, it is not interconnected with any unit of the radar system except for the 100 VAC power cable. In some radars the power cable is not routed via the power switch or other control of the radar and the monitor is operated as completely a separate device.

### Operating the performance monitor

When Radar Interswitch RJ-7 is connected, set it to the "straight" mode. Press the PM ON/OFF button in the Turning Compartment, and the range scale is automatically set to 24 nm. The radar screen will show several arcs, opposite to the heading marker (provided that the performance monitor is installed behind the radar antenna as is normally the case). If the radar transmitter and receiver are in good working conditions in as much as the original state when the monitor was turned up, the innermost arcs should appear at 12 nm and there should be a total of 4 arcs.

The range of the innermost arc reduces 3 nm with every 3 dB loss of transmitted power. Meanwhile the receiver sensitivity can be evaluated from the number of visible arcs; one arc is lost every 3 dB deterioration of the sensitivity.

Transmitter performance		Receiver performance	
Range to innermost arc	Loss	Number of arcs	Loss
12 nm	0 dB	4	0 dB
9 nm	3 dB	3	3 dB
6 nm	6 dB	2	6 dB
3 nm or less or none	> 10 dB	1	> 9 dB
		0	> 12 dB

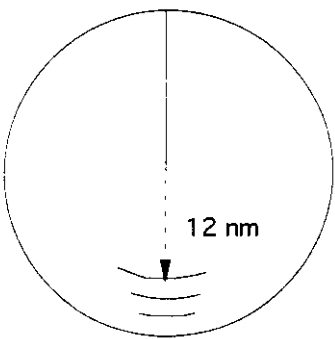
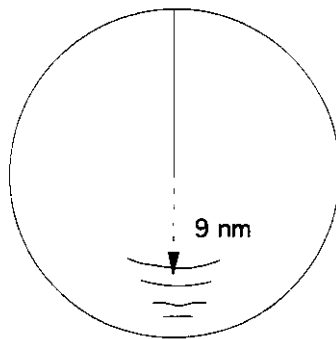
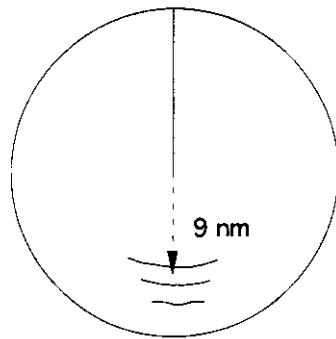
 <p><b>Transmitter: normal</b> <b>Receiver: normal</b></p>	 <p><b>Transmitter: 3 dB loss</b> (Transmitter system has lost a half of initial power. Suspect magnetron and feeder system.)</p> <p><b>Receiver: normal</b></p>	 <p><b>Transmitter: 3 dB loss</b> (Transmitter system has lost a half of initial power. Suspect magnetron and feeder system.)</p> <p><b>Receiver: 3 dB loss</b> (Receiver has lost a half of initial sensitivity. Suspect receiver front end, water ingress in feeder system, etc.)</p>
---	---	--

## A.2 Interswitching Unit

The interswitching unit RJ-7 permits independent or coordinated operation of two radar systems among FR-2100 series, FR-2105 series and FR/FAR-2805 series. The following indicates the menu structure for the guideline of use.

- [FUNCTIONS 3]
- 1 [FUNCTIONS 2]
- 2 RADAR 1
- 3 FUNCTION KEY 1
- 4 FUNCTION KEY 2
- 5 FUNCTION KEY 3
- 6 FUNCTION KEY 4
- 7 RADAR 1/2
- 7 INTERSWITCH
- 8
- 9 GYRO SETTING
- 0 [FUNCTIONS 4]

↓ [7]

- 1 [FUNCTIONS 3]
- 2 DISPLAY 1 → ANT 1M
- 3 DISPLAY 2 → ANT 2M
- 4
- 5
- 2 .....
- .....1
- 6 STORE SETTING
- 7
- 7
- 8
- 9
- 0 [INITIAL SETTING RJ-7]

↓ [0]

- [INITIAL SETTING RJ-7]
- 1 [INTERSWITCHING RJ-7]
- 2 ANTENNA 1 LOCATION
- 3 ANTENNA 2 LOCATION
- 4
- 5
- .....
- .....
- 6 STORE SETTING
- 7
- 7
- 8
- 9
- 0 SET DISPLAY NO. 1/2

Antenna height

## A.3 For Fishing Vessel

This radar can be customized as a fishing vessel version with an internal setting. The fishing vessel version offers an additional picture setup option "BIRD," which is assignable to one of the function keys depending on a setting on FUNCTION KEY 1, 2 or 3 menu shown below.

If the BIRD option is menu-selected at the time of installation, the corresponding function key is labeled "BIRD." Press the function key "BIRD" and the radar will be set for optimum detection of sea birds between 6 and 16 nm. As is well known by professional fishermen, locating a flock of sea birds is useful for finding certain species of fish.

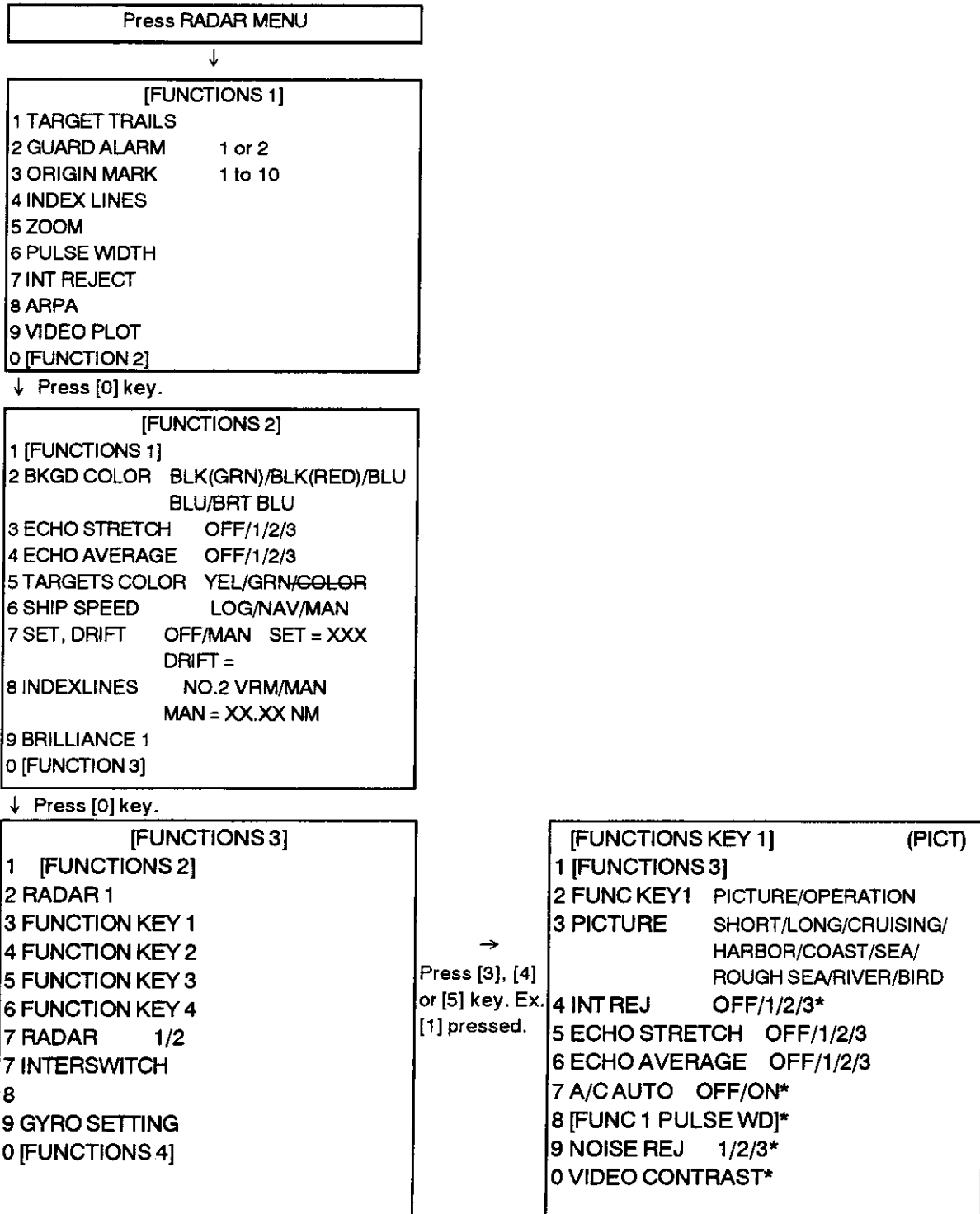

Note: Items marked \* should be left in the default settings.

## **A.3 Navigation Data (Digital interface IEC 61162-1)**

### **1. I/O Sentences of Channel 1**

#### **Input**

BWC, BWR, DBS, DBT, DPT, GGA, GLL, HDT, MTW (\*), MWV, RMA, RMB, RMC, RTE, VDR, VTG(\*), VWR, VWT, WPL, ZDA, \* not recommended in IMO type

#### **Output**

OSD (every 3 s), RSD (3 s), TTM (every 10 s when acquiring 10 targets)

#### **NOTE**

Channel 1 serial port may be connected with a multiplexer interface box IF-2300 to feed Own Ship data, and Wind/Depth/Others data.

### **2. I/O Sentences of Channel 2**

#### **Input**

VBW, VHW

#### **Output**

None

### **3. Serial Signal I/O Circuit**

See succeeding page.

**NOTE:** VDR is connected to the radar display unit via an optional integral interface board.

### **4. Sentence Description**

See page A-6 and after.



**Sentences without checksum will not be accepted as a proper data.**

# FR-2105 SERIES SERIAL INTERFACE I/O CIRCUIT

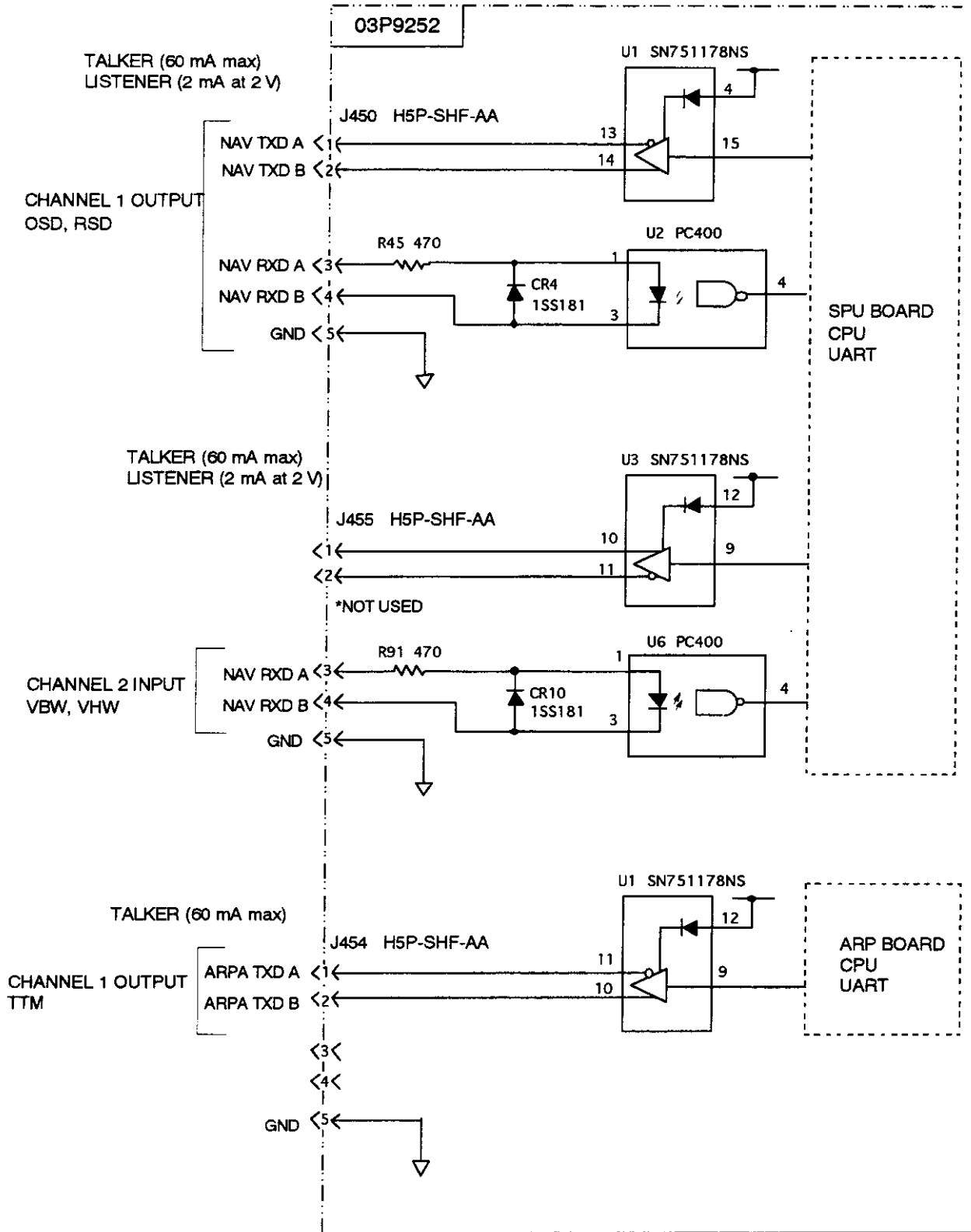

# Description of Sentence

## Channel 1 Input

### BWC - Bearing and distance to waypoint - great circle

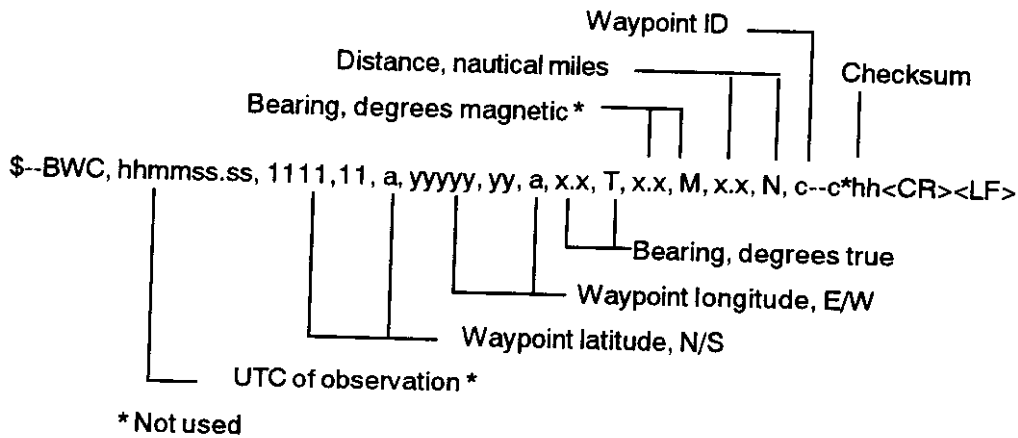

### BWR - Bearing and distance to waypoint - rhumb line

Time (UTC) and distance and bearing to, location of, a specified waypoint from present position. \$--BWR data is calculated along the rhumb line from present position rather than along the great circle path.

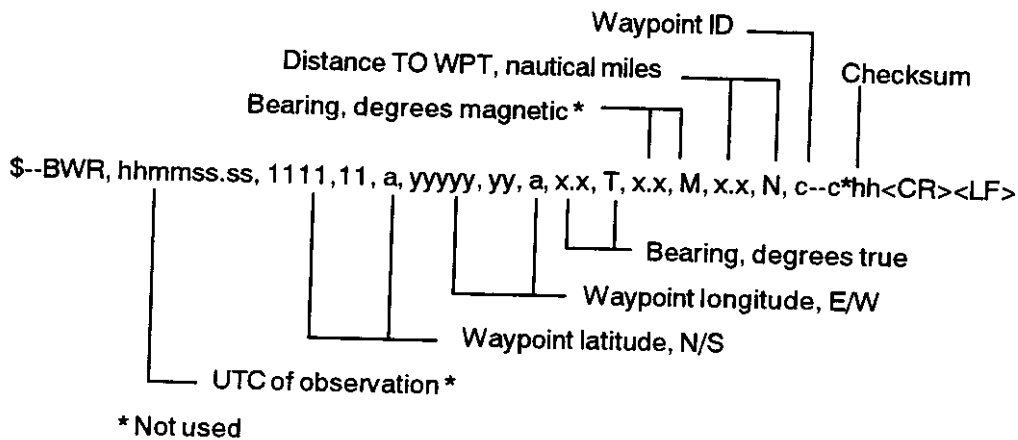

### DBS - Depth below sea surface

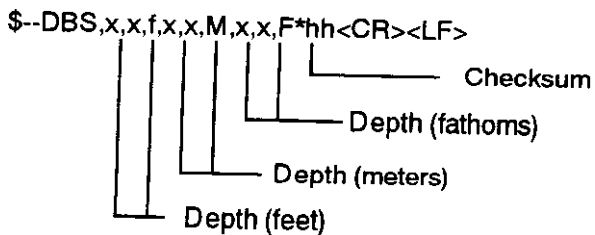



**DBT - Depth below transducer**

Water depth referenced to the transducer.

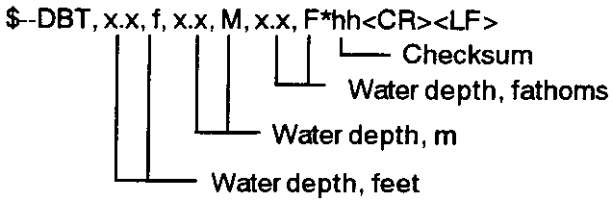

**DPT - Depth**

IMO Resolution A.224 (VI). Water depth relative to the transducer and offset of the measuring transducer. Positive offset numbers provide the distance from the transducer to the waterline. Negative offset numbers provide the distance from the transducer to the part of the keel of interest.

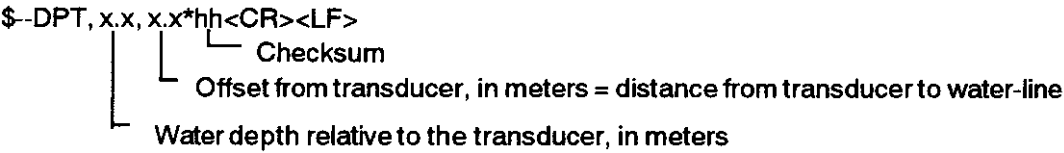

**GGA - Global positioning system (GPS) fix data**

Time, position and fix related data for a GPS receiver.

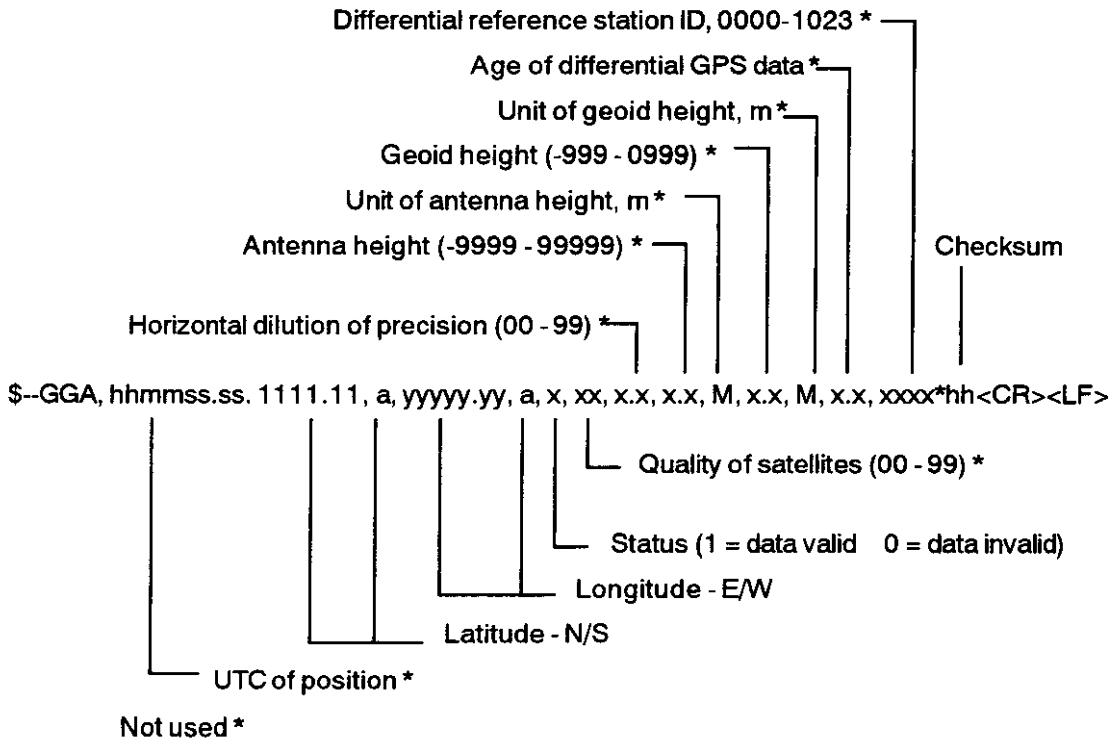

### GLL - Geographic position - latitude/longitude

Latitude and longitude of present vessel position, time of position fix and status.

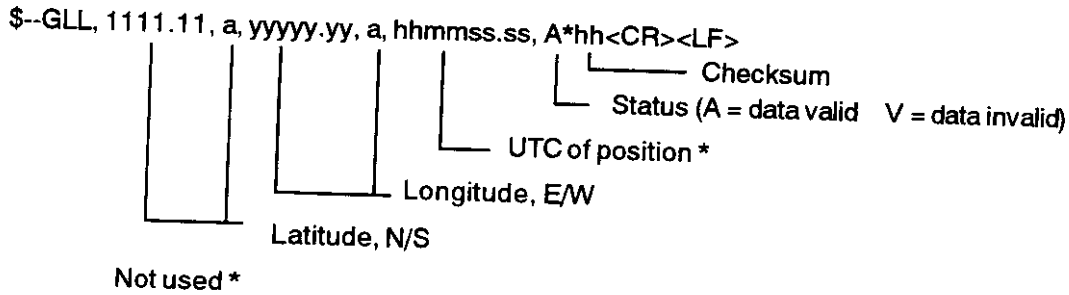

### HDT - Heading True

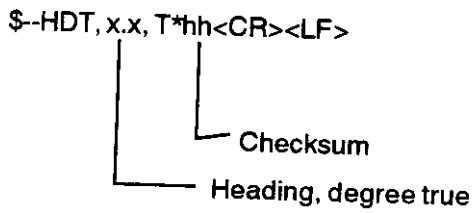

### MTW - Water temperature

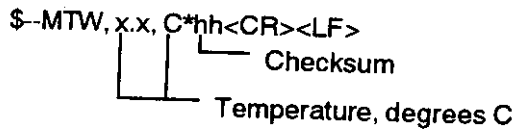

### MWV - Wind speed and angle

When the reference field is set to relative, data is provided giving the wind angle in relation to the vessel's heading and wind speed, both relative to the moving vessel.

When the reference field is set to true, data is provided giving the wind angle relative to the vessel's heading and wind speed, both with reference to the moving water. True wind is the vector sum of the relative apparent wind vector and the vessel's velocity vector along the heading line of the vessel. It represents the wind at the vessel if it were stationary relative to the water and heading in the same direction.

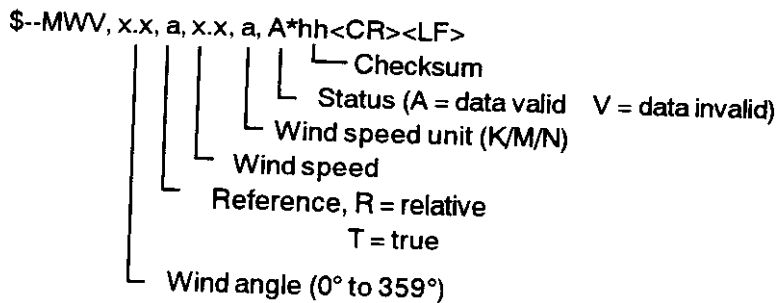

**RMA - Recommended minimum specific LORAN-C data**

Position, course and speed data provided by a LORAN-C receiver. Time differences A and B are those used in computing latitude/longitude. Checksum is mandatory in this sentence. This sentence is transmitted at intervals not exceeding 2 s and is always accompanied by RMB when a destination waypoint is active. RMA and RMB are the recommended minimum data to be provided by a LORAN-C receiver. All data fields must be provided, null fields used only when data is temporarily unavailable.

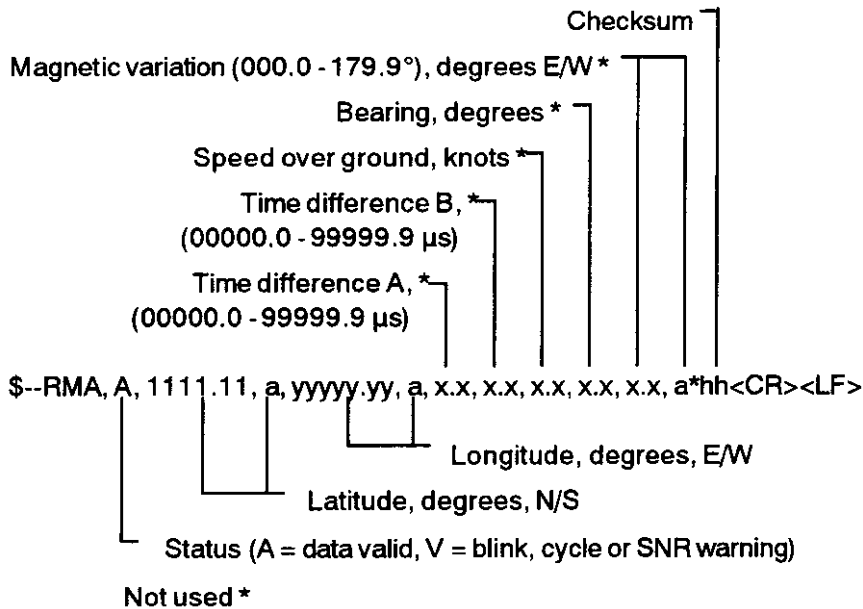

**RMB - Recommended minimum navigation information**

Navigation data from present position to a destination waypoint provided by a LORAN-C, TRANSIT, OMEGA, GPS, DECCA, navigation computer or other integrated navigation system. Checksum is mandatory in this sentence. This sentence always accompanies RMA or RMC sentences when a destination is active when provided by a LORAN-C, TRANSIT or GPS receiver, other systems may transmit \$--RMB without \$--RMA or \$--RMC.

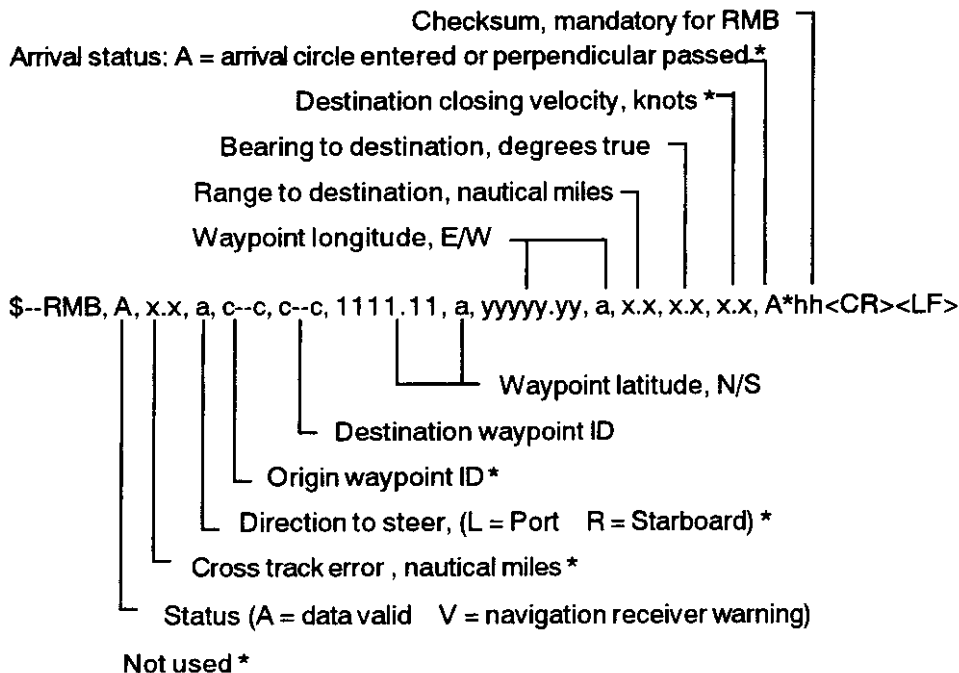

### RMC - Recommended specific GPS/TRANSIT data

Time, date, position, course and speed data provided by a GPS or TRANSIT navigation receiver. Checksum is mandatory in this sentence. This sentence is transmitted at intervals not exceeding 2 s and is always accompanied by RMB when a destination waypoint is active. RMC and RMB are the recommended minimum data to be provided by a GPS or TRANSIT receiver. All data fields must be provided, null fields used only when data is temporarily unavailable.

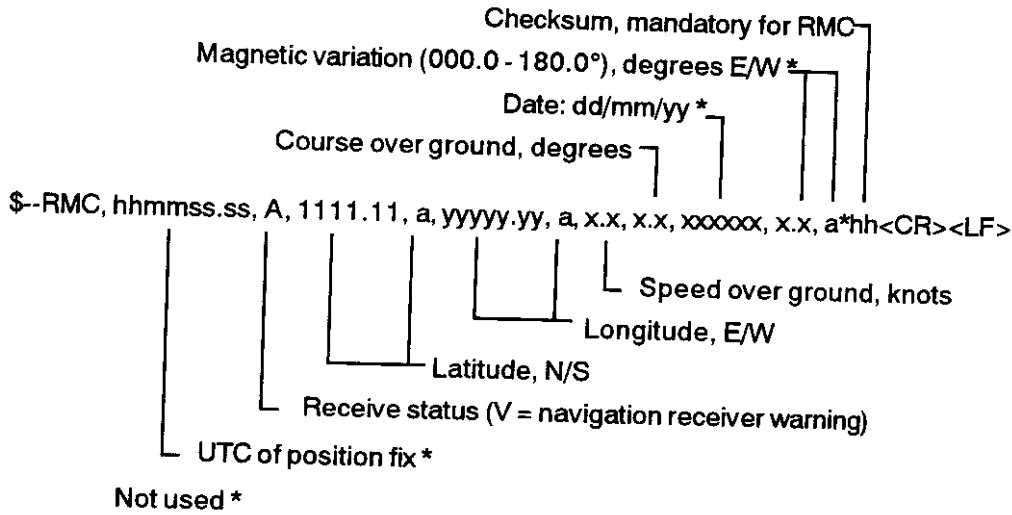

### RTE - Routes

Waypoint identifiers, listed in order with starting waypoint first, for the identified route. Two modes of transmission are provided: "c" indicates that the complete list of waypoints in the route is being transmitted; "w" indicates a working route where the first listed waypoint is always the last waypoint that had been reached (FROM), while the second listed waypoint is always the waypoint that the vessel is currently heading for (TO), the remaining list of waypoints represents the remainder of the route.

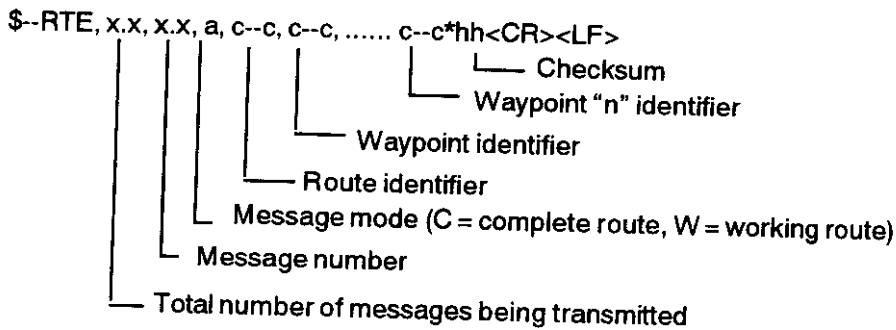

**\*VBW - Dual ground/water speed: (IEC 61162 : 1997)**

\$--VBW, x.x, x.x, A, x.x, x.x, A, x.x, A, x.x, A\*hh<CR><LF>

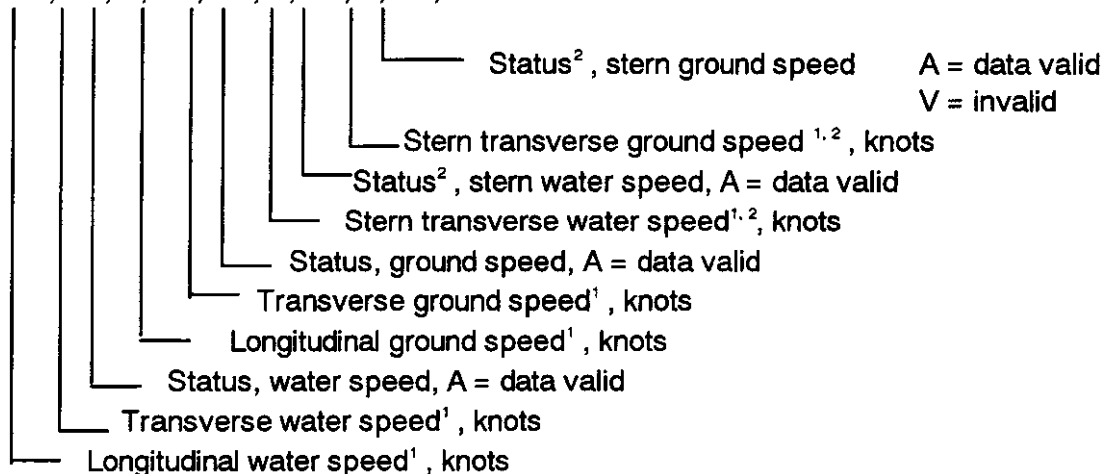

**NOTES**

1. Transverse speed: "-" = port, Longitudinal speed: "-" astern.
2. For vessels equipped with dual water and/or ground speed systems ; data for the equipment mounted towards the stern are reported in these fields.

**VDR - Set and drift**

The direction towards which a current flows (set) and speed (drift) of current.

\$--VDR, x.x, T, x.x, M, x.x, N\*hh<CR><LF>

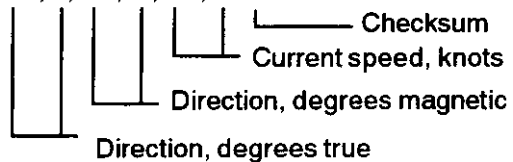

**VTG - Course over ground and ground speed (R-TYPE ONLY)**

The actual course and speed relative to the ground.

\$--VTG, x.x, T, x.x, M, x.x, N, x.x, K\*hh<CR><LF>

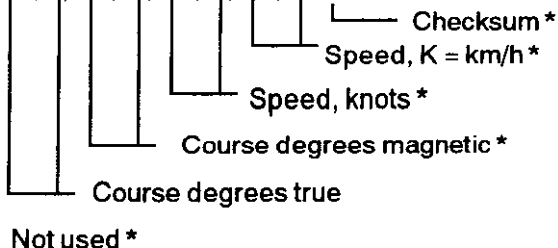

**VWR - Relative wind angle and speed**

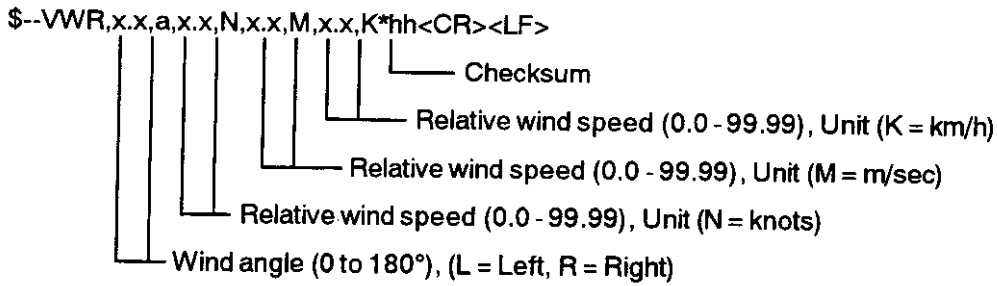

**VWT - True wind angle and speed**

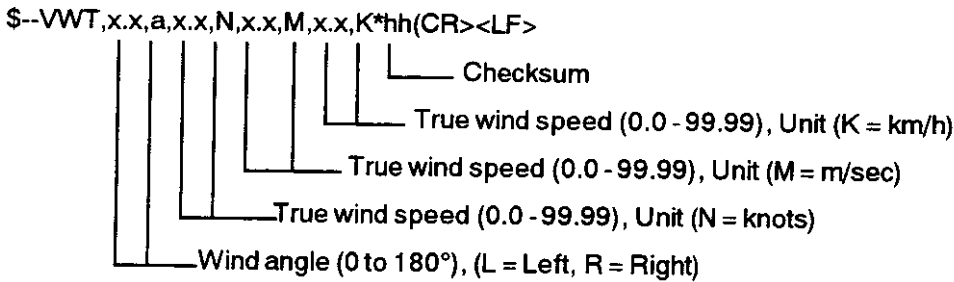

**WPL - Waypoint location**

Latitude and longitude of specified waypoint

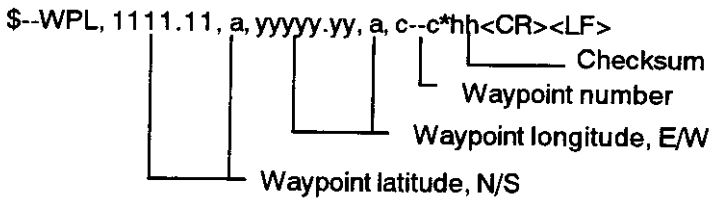

**ZDA - Time and date**

UTC, day, month, year and local time zone.

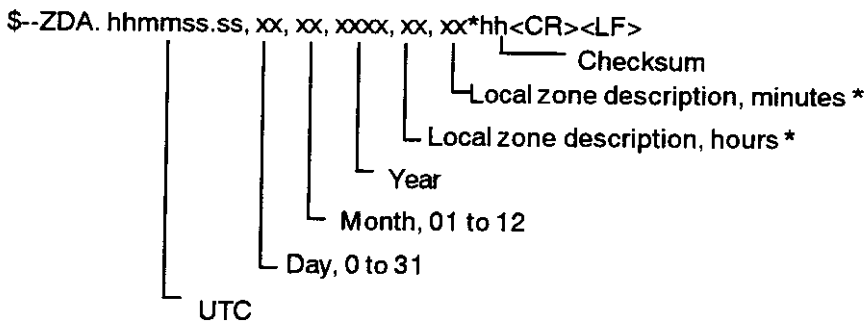

Not used \*

## Channel 1 output

### RAOSD - Own ship data

\$RAOSD,x,x,A,x,x,a,x,x,a,x,x,x,x,a\*hh<CR><LF>

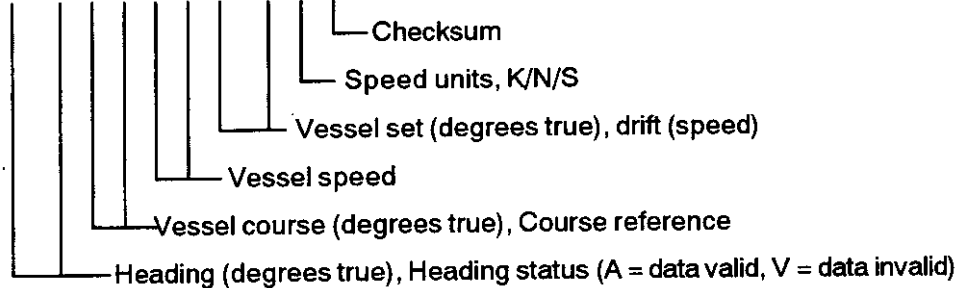

### RARSD - Radar system data

\$RARSD,x,a,a\*hh<CR><LF>

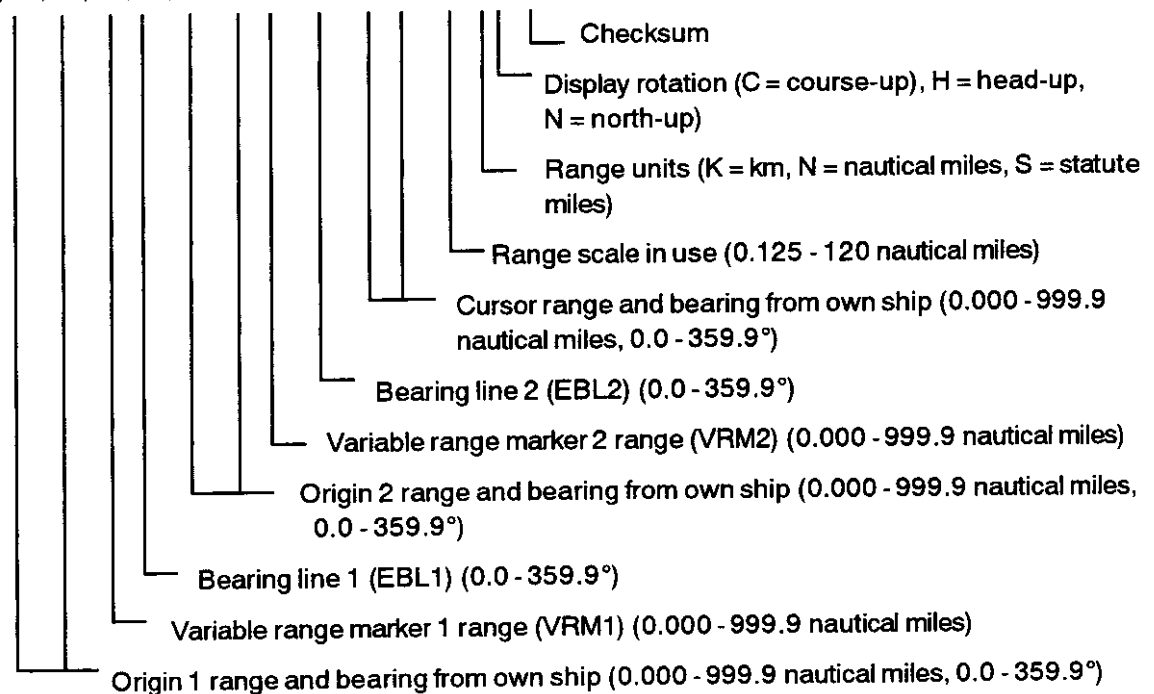

### RATTM - Tracked target message

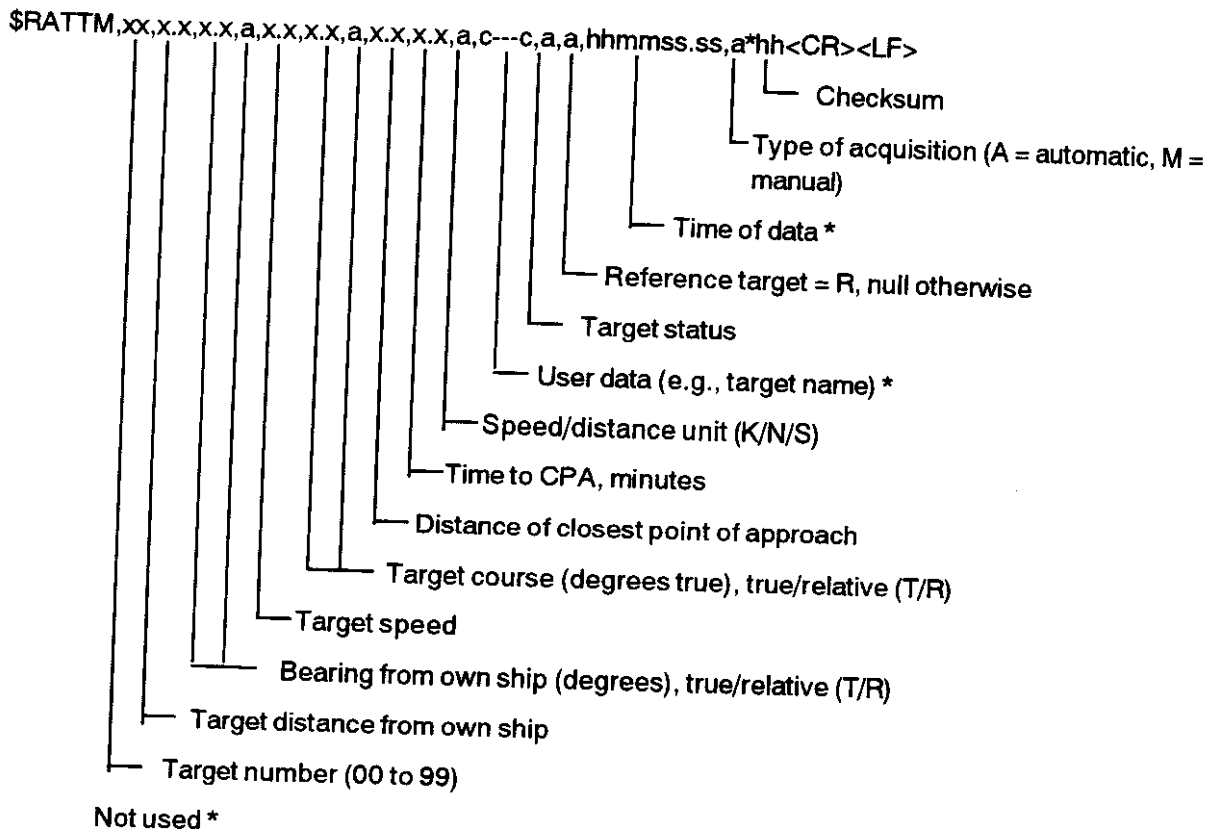

### Channel 2 input

This channel is normally for VBW and VHW.

### IIDPT - INS depth

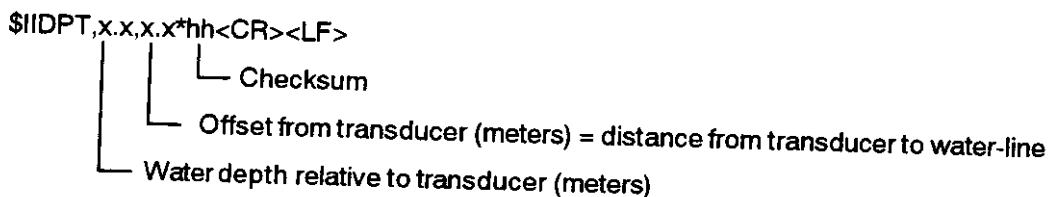

### FUGLL - INS future position

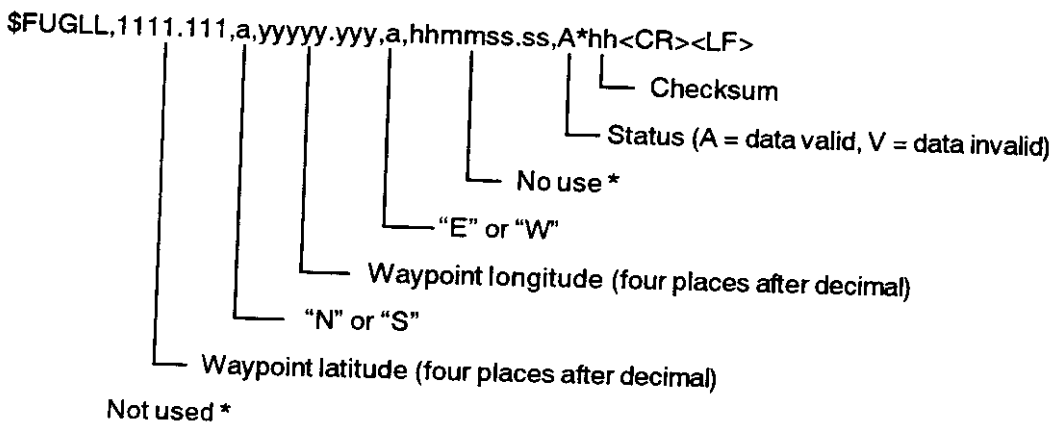



**IIGLL - INS position**

\$IIGLL,1111.111,a,yyyyy.yyy,a,hhmmss.ss,A\*hh<CR><LF>

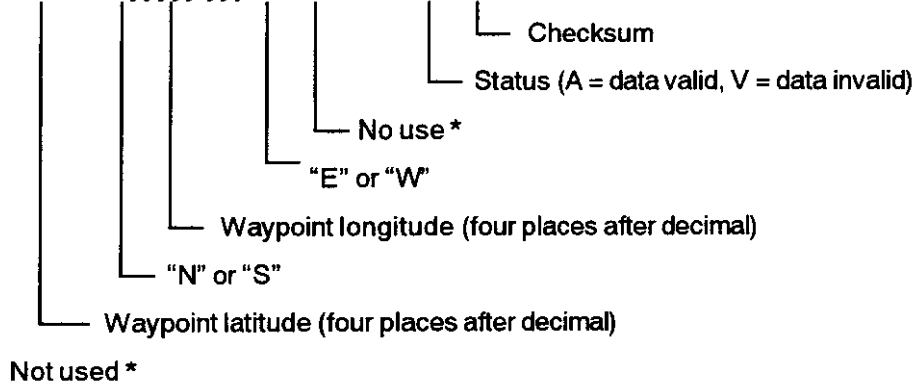

**IIMWV - INS wind angle and direction**

\$IIMWV,x.x,a,x.x,a,A\*hh<CR><LF>

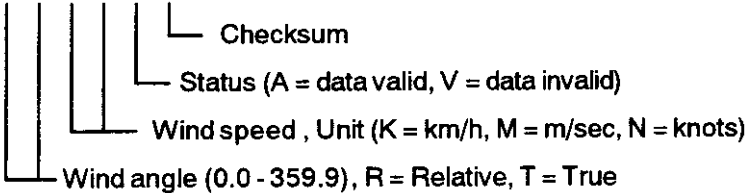

**IIOSD - INS own ship data**

\$IIOSD,x.x,A,x.x,a,x.x,a,x.x,x.x,N,x.x,A\*hh<CR><LF>

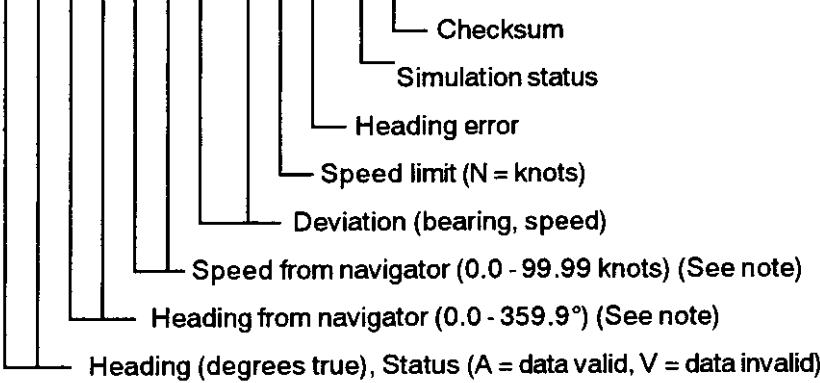

Note - Reference systems (speed/course)

- B = bottom tracking log
- M = manually entered
- W = water referenced
- R = radar tracking (of fixed target)
- P = positioning system ground reference

**PAESC - Curved EBL**

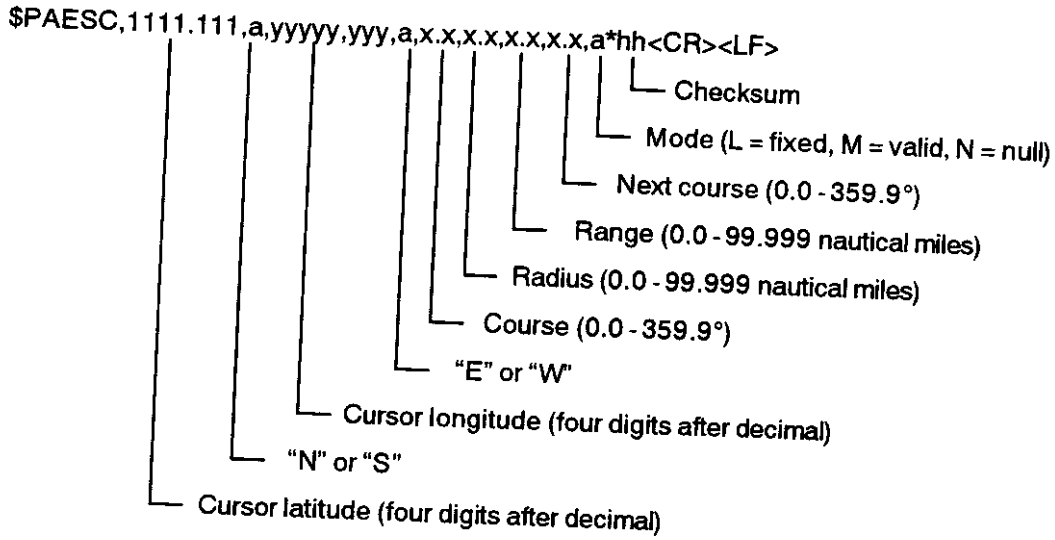

**PAESF - Target acquisition and cancel**

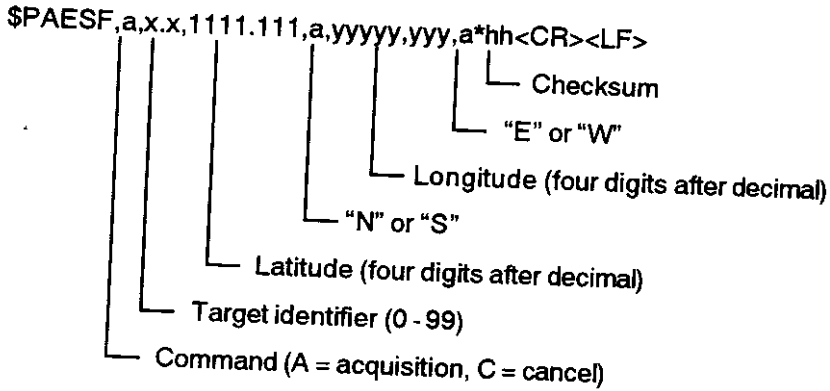

**PAESN - INS notebook**

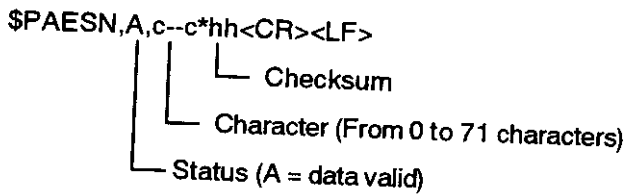

**PAESP - Position offset**

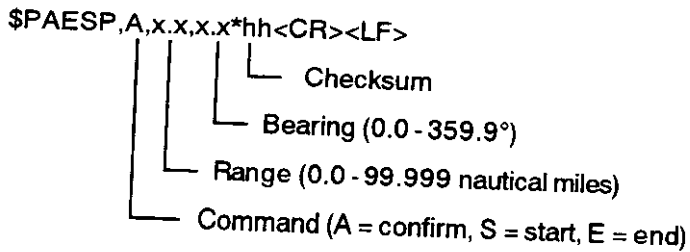

**PAESW - INS waypoint list**

\$PAESW,1111.111,a,yyyyy.yyy,a,c--c,x,x,x,x,x,a\*hh<CR><LF>

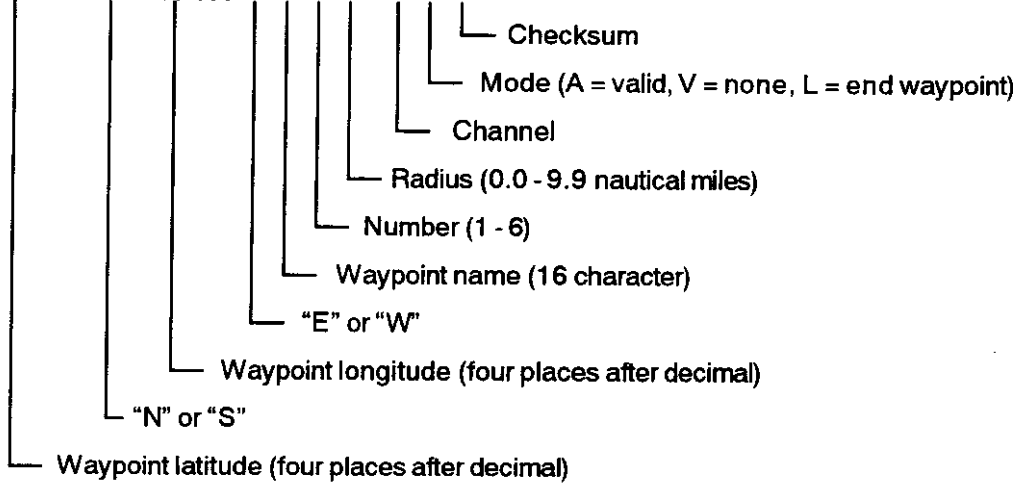

**PLSPL - user chart**

\$PLSPL,1111.111,a,yyyyy.yyy,a,1111.111,a,yyyyy.yyy,a,a,xxx,a\*hh<CR><LF>

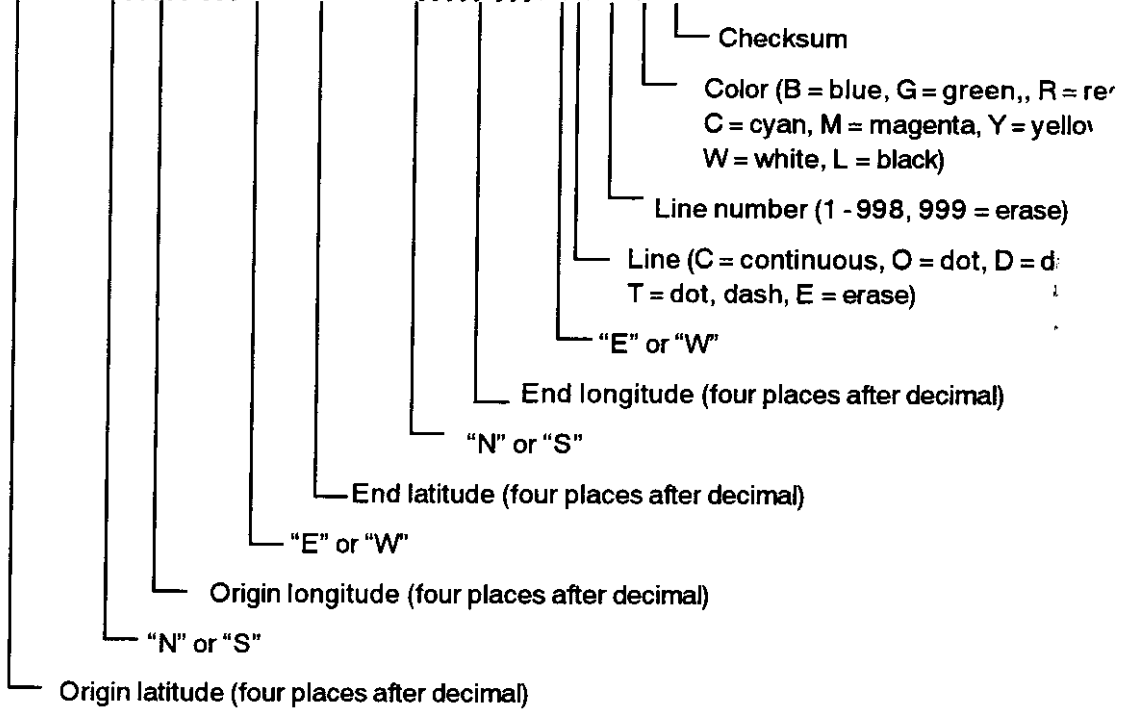

**PLSPS - chart symbol**

\$PLSPS,1111.111,a,yyyyy.yyy,a,xxx,c--c,a\*hh<CR><LF>

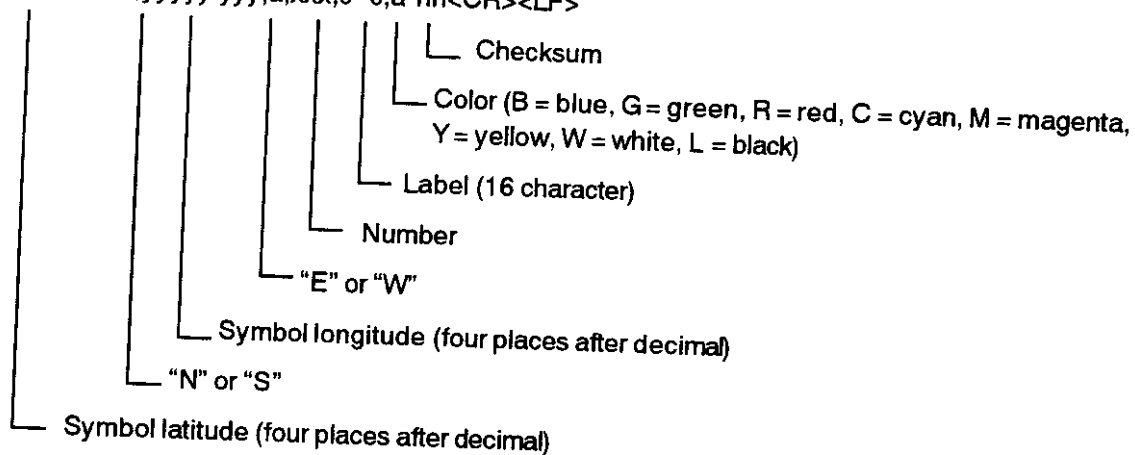

**VBW - Dual ground/water speed**

\$--VBW,x.x,x.x,A,x.x,x.x,A\*hh<CR><LF>

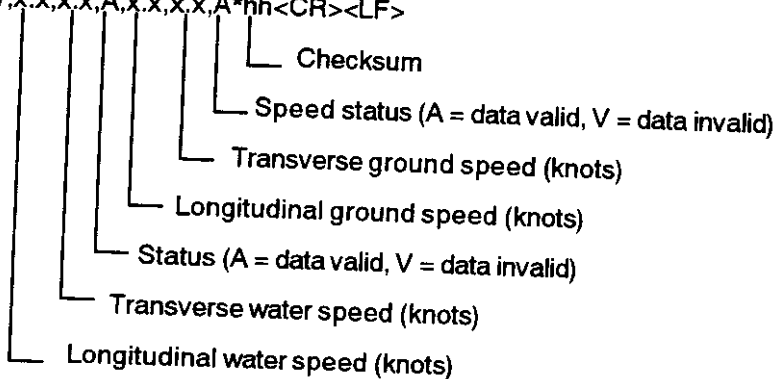

**VHW - Water speed and heading**

The compass heading to which the vessel points and the speed of the vessel relative to the water.

\$--VHW,x.x,T,x.x,M,x.x,N,x.x,K\*hh<CR><LF>

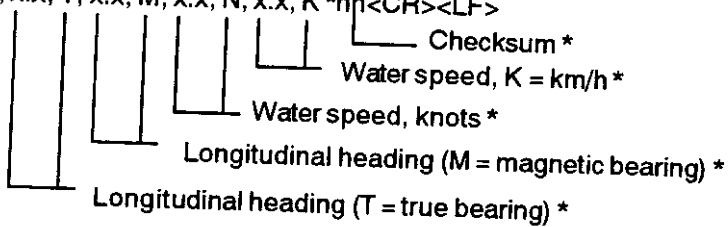

## Channel 2 output

**This channel is not normally used.**

### RAOSD - own ship data

\$RAOSD,x.x,A,x.x,a,x.x,a,x.x,x.x,N,x.x,A\*hh<CR><LF>

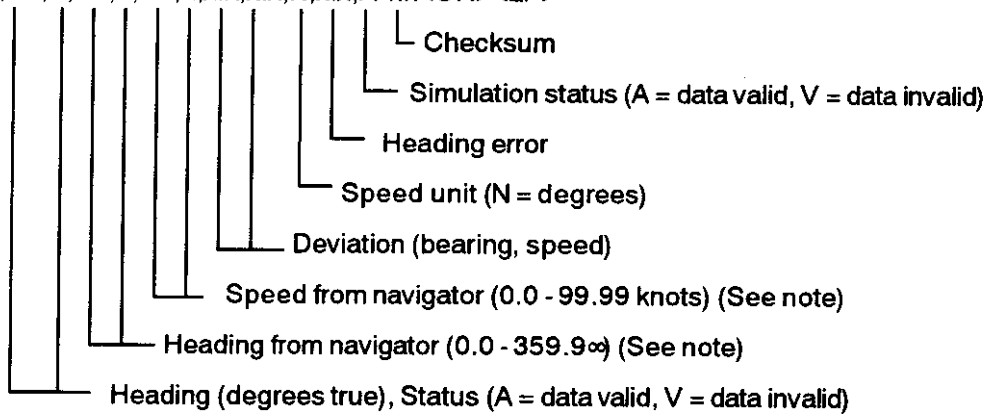

Note - Reference systems (speed/course)

B = bottom tracking log

M = manually entered

W = water referenced

R = radar tracking (of fixed target)

P = positioning system ground reference

**RARSD - INS radar system data**

\$RARSD,x.x,x.x,x.x,x.x,x.x,x.x,x.x,x.x,x.x,x.x,x.x,x.x,x.x,x.x,x.x,a,a,a,1111.111,a,yyyyy.yyy,a\*hh<CR><LF>

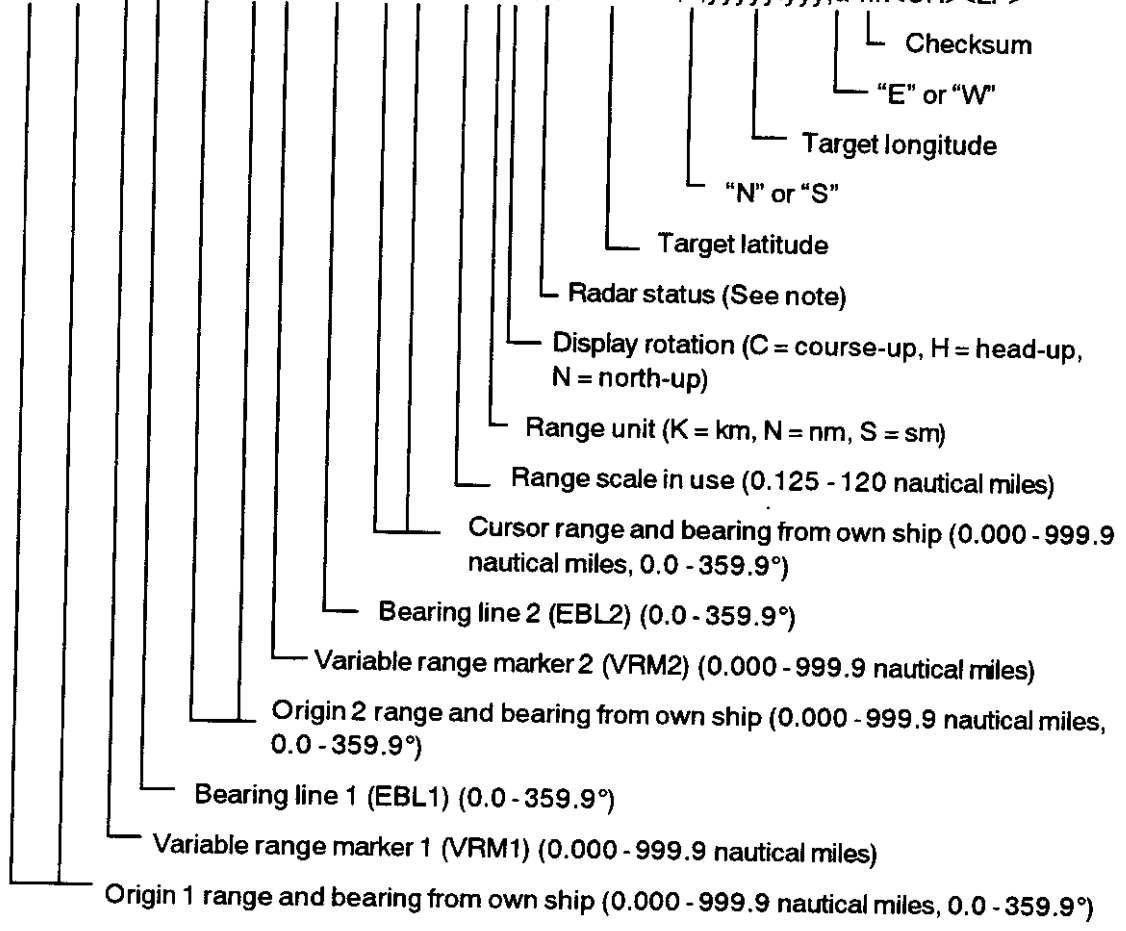

Note A = Normal, T = Tracking unit normal, D = Display unit normal, R = Transmitter unit normal, N = Antenna unit normal, ? = Other

**RATTM - Tracked target data**

\$RATTM,xx,x.x,x.x,a,x.x,x.x,a,x.x,x.x,a,c--c,a,a,1111.111,a,yyyyy.yyy,a\*hh<CR><LF>

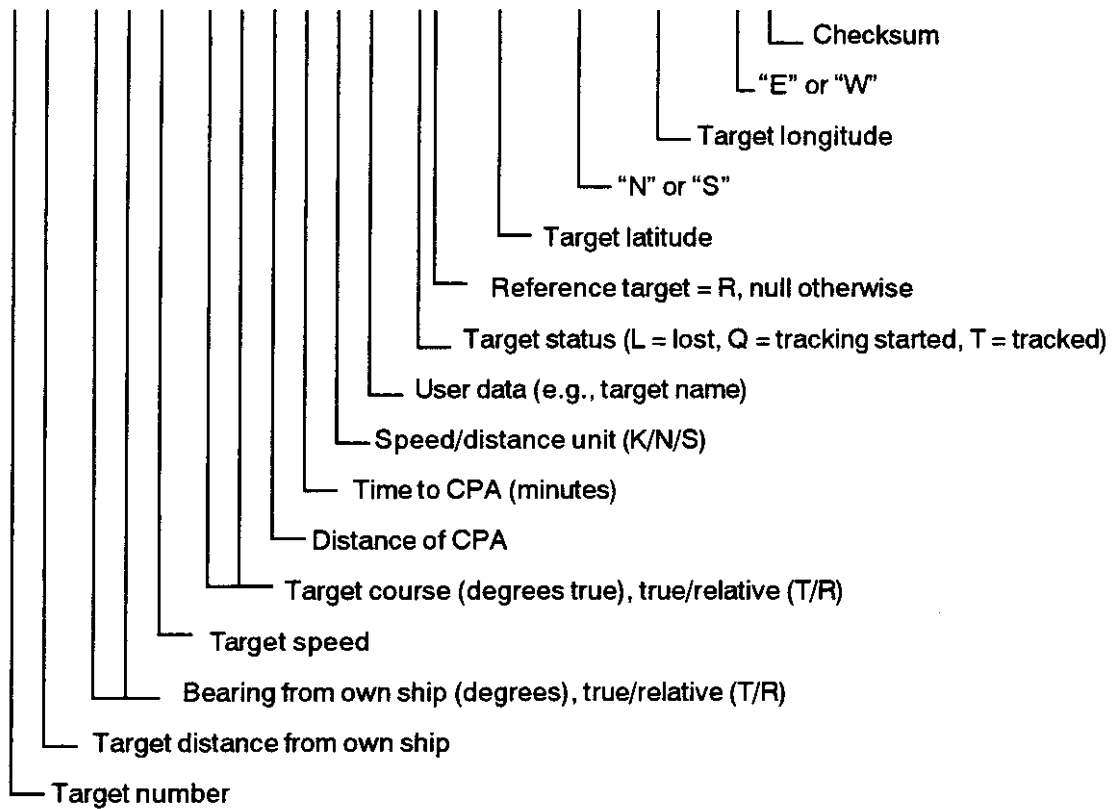

**PAESP - Position offset**

\$PAESP,A,x.x,x.x\*hh<CR><LF>

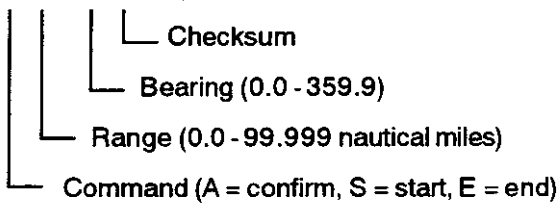

## A.4 Parts List And Major Parts Location

1 FR-2115/2125 DISPLAY UNIT RDP-124

FR-2115/2125		Unit	DISPLAY UNIT RDP-124	
ELECTRICAL PARTS LIST		Ref. Dwg.	C3464-K01-A	
98/5		Blk. No.		
SYMBOL	TYPE	CODE No.	REMARKS	SHIPPABLE ASSEMBLY
<b>PRINTED CIRCUIT BOARD</b>				
1B7	03P9252, INT	008-487-550		X
1B8	03P9253, SPU	008-487-500		X
1B9	03P9254, PAL	008-487-570		X
1B10	03P9255, PNL	008-487-600		X
1B11	03P6256, PAR	008-487-580		X
1B13	HV9017A, HV	008-481-630	FR-2115	X
	HV9017B, HV	008-481-640	FR-2125	X
U4	64P1106A, GC	004-412-220	OPTION	X
U5	18P9002B, ARP	008-473-650	OPTION	X
U6	14P0298, RP	008-487-640	OPTION	X
U6	14P0299, CARD I/F	008-487-660	OPTION	X
U18	03P9225, PM-IN	008-487-620	OPTION	X
<b>CRT ASSEMBLY</b>				
1B15	CDT2136B, PDM9025	008-487-360		X
<b>PANEL ASSEMBLY</b>				
-	PAL/PAR/PNL/TB301	008-487-370	Japanese	X
		008-487-390	English	X
<b>POWER BLOCK ASSY</b>				
1B3	03P9245A, PTU	008-487-430	115VAC, 24 rpm	X
	03P9245B, PTU	008-487-880	115VAC, 36 rpm	X
	03P9245C, PTU	008-487-890	115VAC, 42 rpm	X
	03P9245D, PTU	008-487-900	220 VAC, 24 rpm	X
	03P9245E, PTU	008-487-910	220 VAC, 36 rpm	X
	03P9245F, PTU	008-487-920	220 VAC, 42 rpm	X
<b>COOLING FAN</b>				
B1, B2	MMS-06C24DS-R01	000-128-409	w/cable	X
<b>FUSE</b>				



F1, F2	FGBO 5A 250 VAC	000-549-022	For 230 VAC
	FGBO 10A 125 VAC	000-549-065	For 115VAC
F3	FGBO 0.5A 125 VAC	000-549-060	
<b>FILTER</b>			
FL1	LF-210	000-588-410	
<b>SWITCH</b>			
S1	S-331	000-474-214	
S2	LB-26WKS1	000-140-814	

2 **FR-2115/2125 SCANNER UNIT RSB-0074/0075**

Model	FR-2115/2125	Unit	SCANNER UNIT RSB-0074/0075	
<b>ELECTRICAL PARTS LIST</b> 98/5		Ref. Dwg.	C3466-K02-B	
		Blk. NO.		
<b>SYMBOL</b>	<b>TYPE</b>	<b>CODE No.</b>	<b>REMARKS</b>	<b>SHIPPABLE ASSEMBLY</b>
<b>PRINTED CIRCUIT BOARD</b>				
2B2	03P9243A, RFC	008-487-260	FR-2115	X
	03P9243B, RFC	008-487-280	FR-2125	X
2B3	03P9244A, MD	008-487-300	FR-2115	X
	03P9244B, MD	008-487-320	FR-2125	X
2B4	03P9232, IF	008-487-240		X
2B6	03P9242, TB	008-487-230		X
2B7	MP-3795	008-312-370		X
<b>SCANNER CHASSIS</b>				
-	RSB-0074	008-488-010	24 rpm, w/o RF module	X
-	RSB-0075	008-488-030	42 rpm, w/o RF module	X
<b>RF MODULE</b>				
-	RTR-062	008-487-160		X
-	RTR-063	008-487-170		X
<b>MIC ASSEMBLY</b>				
U801	RU-9253	008-487-350	RTR-063	X
	RU-9371	008-487-340	RTR-062	X
<b>MOTOR</b>				
B801	D8G-516	000-631-715	24 rpm, w/capacitor	

B802	D8G-571 109P0824H602	000-136-566 000-140-764	42 rpm, w/capacitor 25 kW, w/cable	X
<b>SWITCH</b>				
S901	RS-1 NO	000-478-301		
<b>DIODE</b>				
CR870	HVR-1X-40B MD-12N1	000-121-156	FR-2115	
CR871	HVR-1X-40B	000-133-735 000-121-156	FR-2125	
<b>DIODE LIMITER</b>				
CR880	RU-9099	000-126-369		
<b>CIRCULATOR</b>				
HY801	RC-3686	000-106-850		
<b>RESISTOR</b>				
R899	ERF-10HMJ102	000-123-395		
<b>TRANSFORMER</b>				
T801	RT-9025 RT-9023	000-123-823 000-123-394	FR-2115 FR-2125	
<b>SYMBOL TYPE</b>				
		<b>CODE No.</b>	<b>REMARKS</b>	<b>SHIPPABLE ASSEMBLY</b>
<b>MAGNETRON</b>				
V801	MG5241 E3566 MG5436	000-100-036 000-141-073 000-140-762	FR-2115 FR-2115 FR-2125	

DISPLAY UNIT, TOP VIEW and BOTTOM VIEW

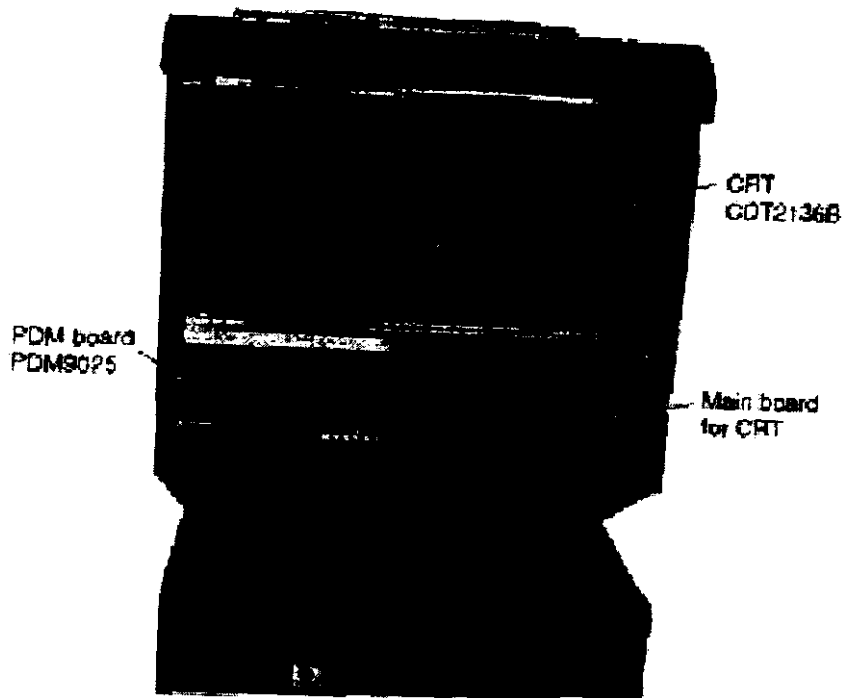

*Display Unit (Rear view, CRT block lifted)*

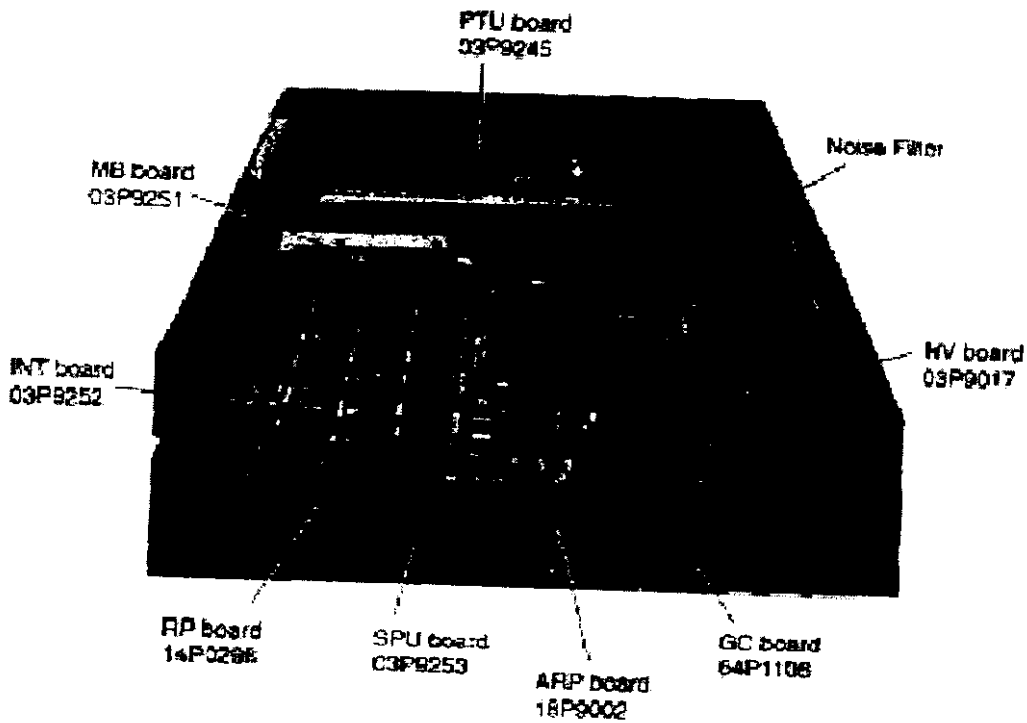

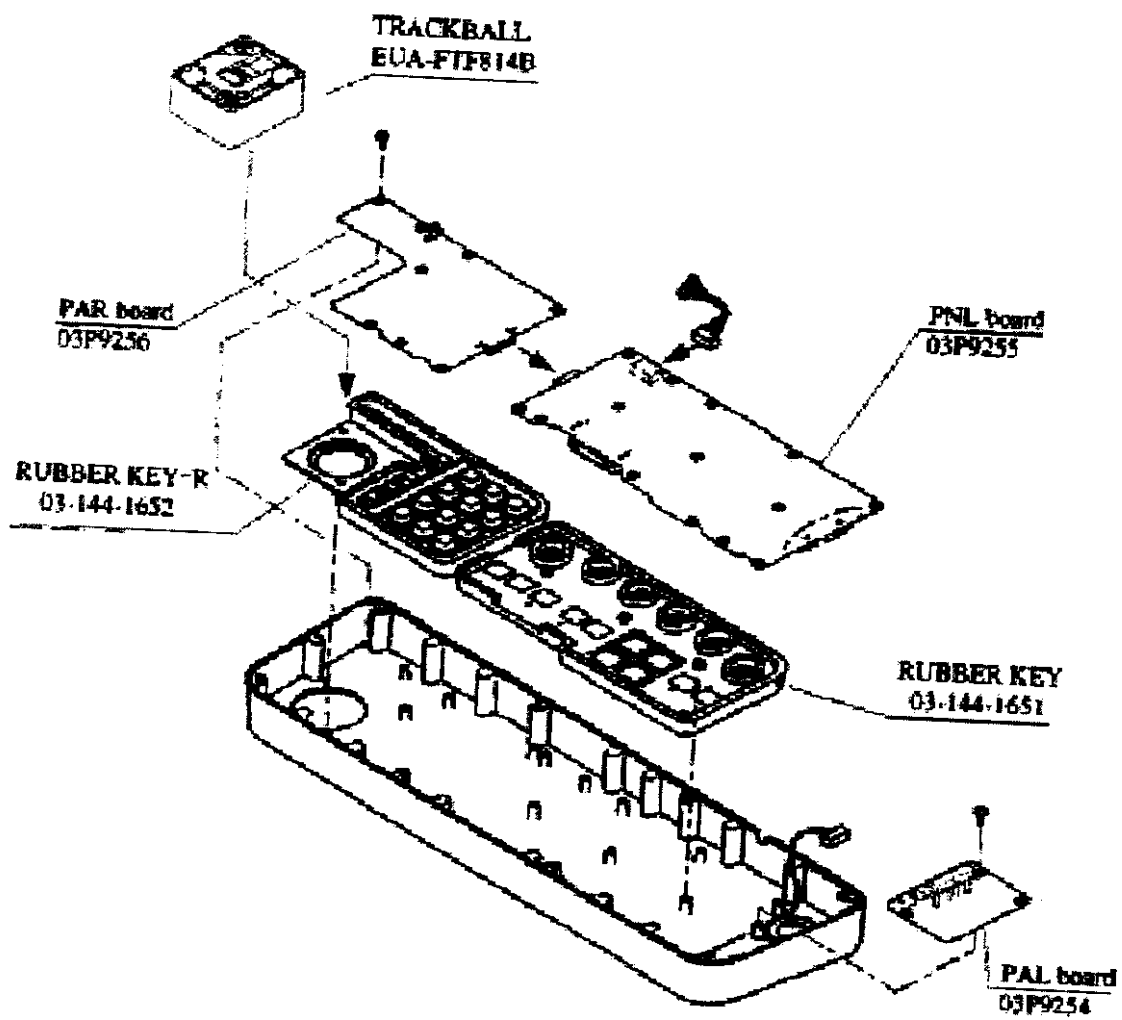

EXPLODED VIEW OF DISPLAY UNIT CONTROL HEAD

ANTENNA UNIT, SCANNER OUTLINE and RF MODULE

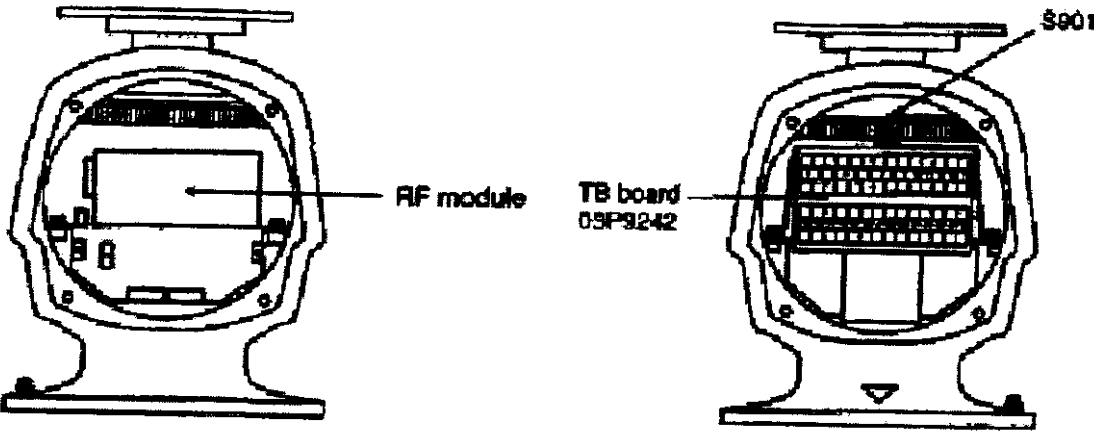

*Scanner Unit*

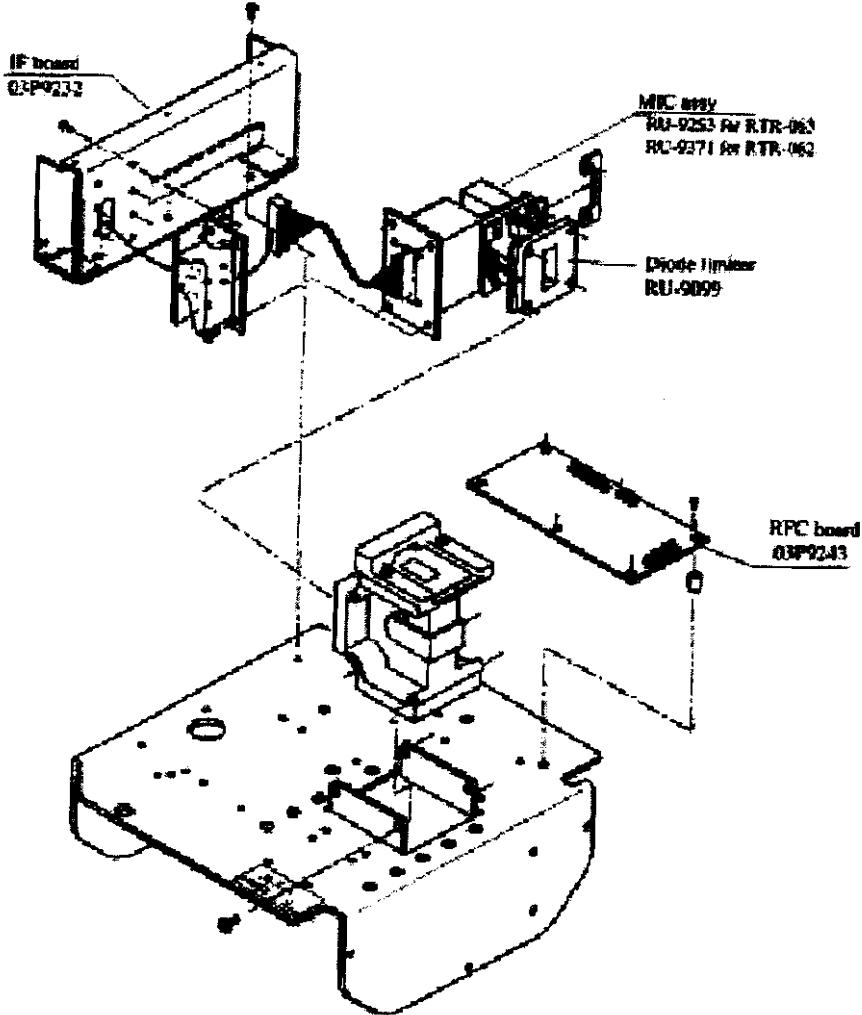

RF module, top view

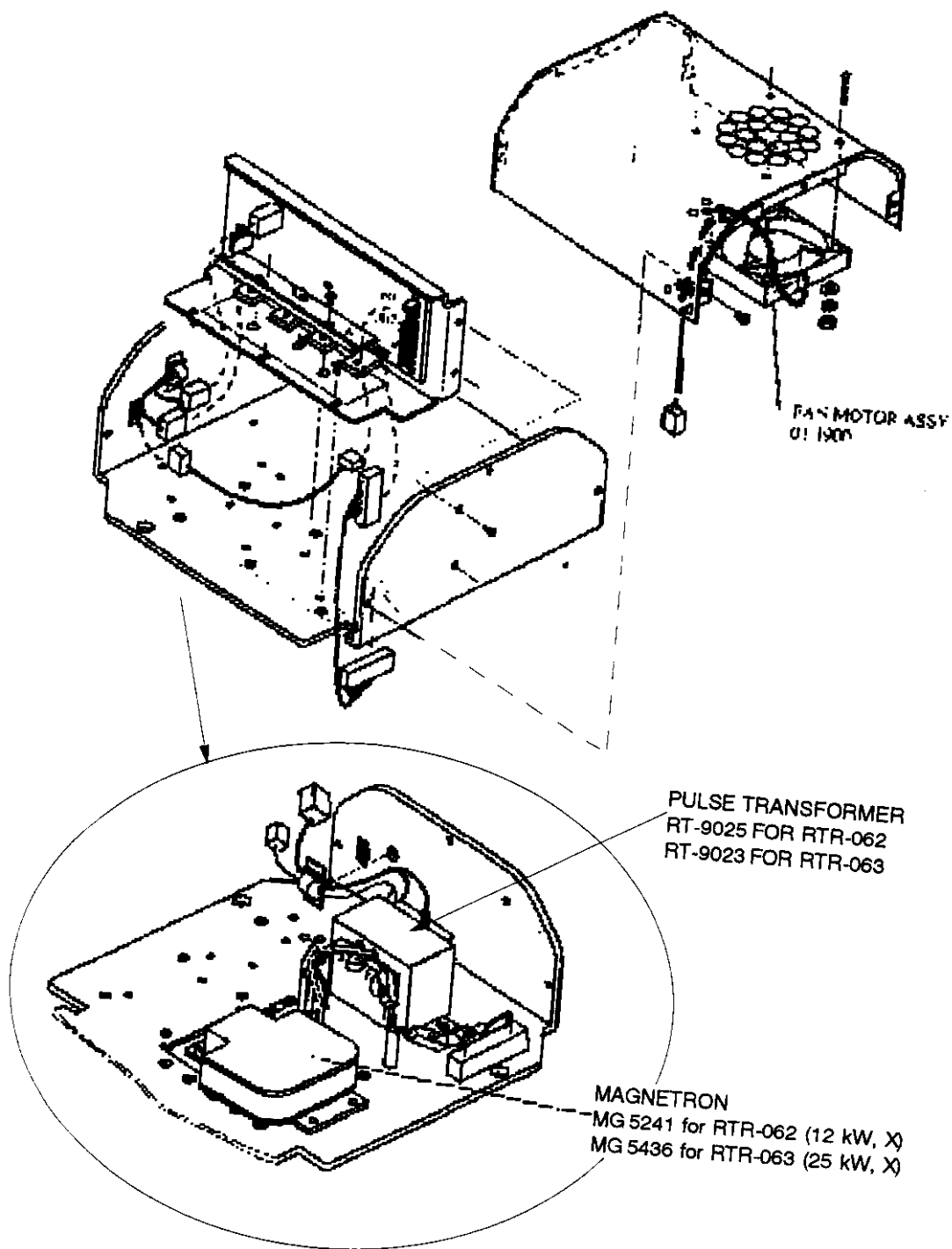

RF MODULE, BOTTOM VIEW



A magnetron has strong magnetism. Do not bring a ferrous material in close contact with it. Do not place the magnetron on a steel table.

For further information on parts location and how to replace components, refer to the Service Manual which will be available at extra cost.

# SIMPLIFIED INTERCONNECTION DIAGRAM

(See Installation Manual for terminal connections)

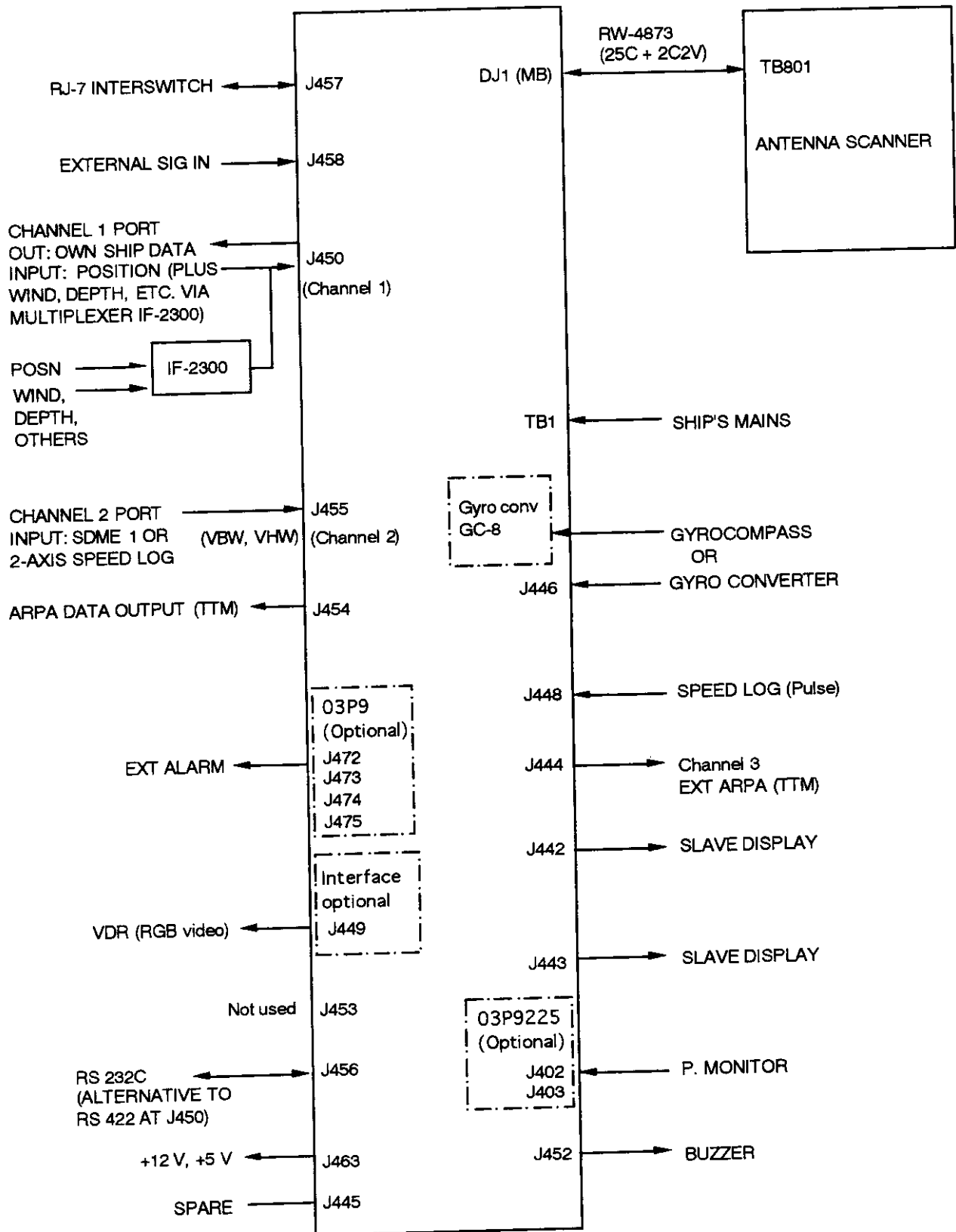

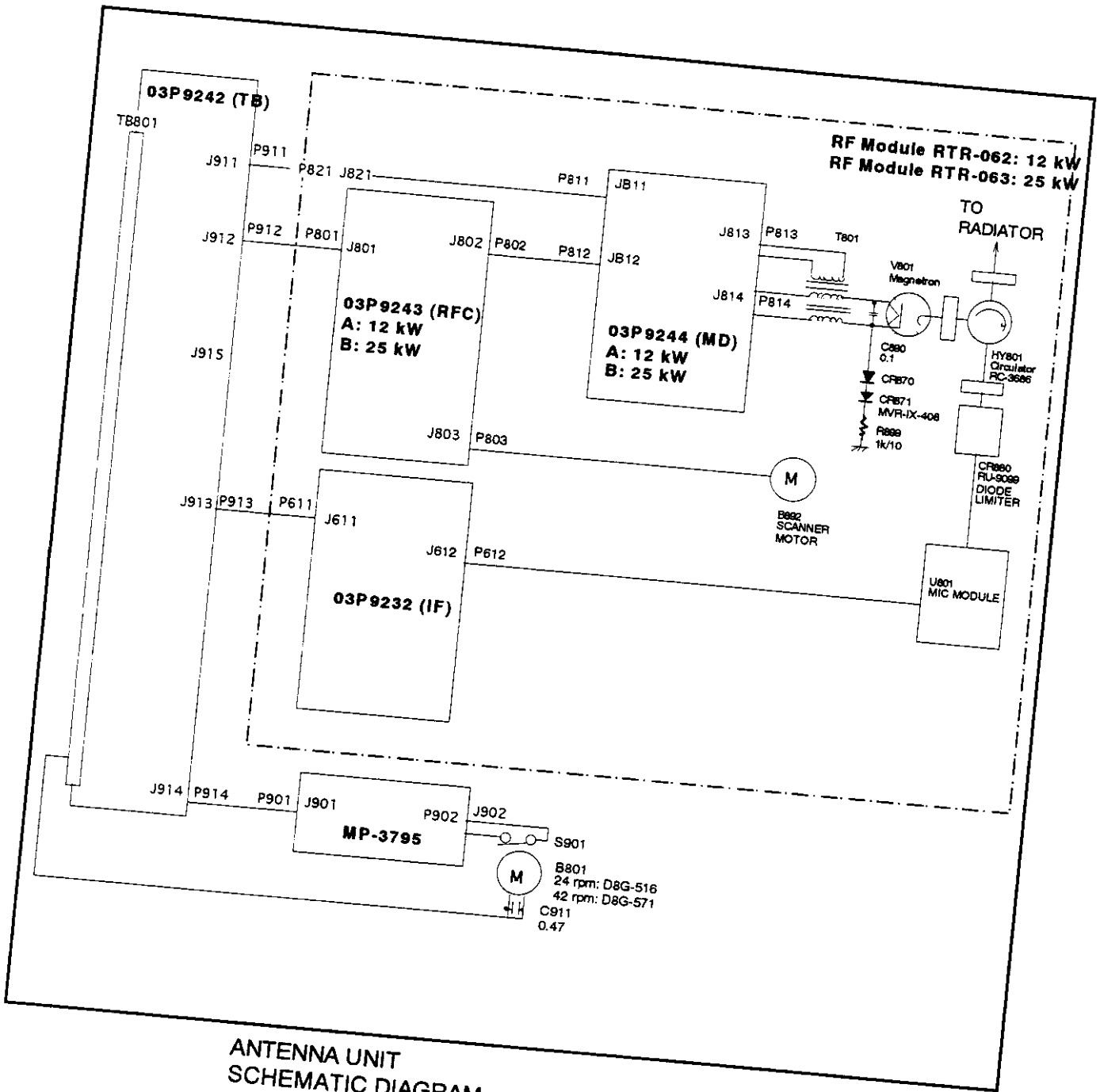

**ANTENNA UNIT  
SCHEMATIC DIAGRAM**  
(For more detail, refer to installation manual or service manual.)



