

1.28 Custom Setup

1.28.1 About custom setup

When your navigating environment or task changes, you must adjust the radar. Instead of changing radar settings case by case, you can assign the **CUSTOM** key to provide best settings for common conditions.

There are three default custom setups for the internal computer of the radar (see the table on the next page). You can adjust these settings on the [Custom 1], [Custom 2] and [Custom 3] menus to meet your navigation needs.

To activate a custom setup, press the **CUSTOM** key. The **CUSTOM** key switches between Custom 1, Custom 2 or Custom 3 each time you press the key. (Custom setup numbers which are turned off are ignored.) The selected custom setup name is shown at the upper-left corner. To escape from custom setup, operate any control.

1.28.2 Description of custom setup items

Description of custom setup items

Menu item	Available settings	See section
[Custom1(2 or 3)]	Turn on/off each custom program.	
[Copy]	Copy settings from the [Echo] menu. The message "Complete" appears after the copying is completed.	
[Gain Mode]	[Auto]: Automatic gain adjustment according to noise level [Manual]: Manual gain adjustment	1.9
[Manual Gain]	Copy the current position of the GAIN knob when you do [Copy]. This item is for read-only.	
[Sea Mode]	[Auto]: Automatic sea clutter adjustment according to sea state [Manual]: Manual sea clutter adjustment	1.10
[Auto Sea]	[Coastal]: Suppress both land and sea clutter. [Advanced]: Automatically discriminate land echoes from sea reflections to suppress only sea reflections.	1.10
[Manual Sea]	Copy the current position of the A/C SEA knob when you do [Copy]. This item is for read-only.	
[Rain Mode]	[Auto]: Automatic rain clutter adjustment according to rain cloud [Manual]: Manual rain clutter adjustment	1.11
[Auto Rain]	[Calm]: For light rain [Moderate]: When you can not reduce the rain clutter with [Calm] mode [Rough]: For heavy rain	1.11
[Manual Rain]	Copy the current position of the A/C RAIN knob when you do [Copy]. This item is for read-only.	
[A/C Auto]	[Off], [On]	1.12

Menu item	Available settings	See section
[Pulse Length]	[Short] or [Long], you can select on 1.5, 1.6, 3.0 and 3.2 nm ranges.	1.18
[Echo Stretch]	[Off], [1], [2], [3]	1.22
[Echo Average]	[Off], [1], [2], [Auto]	1.23
[Noise Rejector]	[Off], [On]	1.30
[Wiper]	[Off], [1], [2]	1.31
[Int Rejector]	[Off], [1], [2], [3]	1.14
[Display-Dynamic]	[Narrow]: Erase weak echoes. [Normal]: Normal use [Wide]: Display weaker echoes compared to [Narrow].	1.36
[Display-Curve]	[1]: Reduce weak echoes. [2]: Normal use [3]: Display weaker echoes in stronger color compared to [1].	1.37
[Color Erase]	0 - 11	1.44.3

1.28.3 How to set custom setups

1. Press the **MENU** key to open the menu.
2. Use the Cursorpad (▲ or ▼) to select [Custom 1 (2 or 3)] and press the **ENTER** key.

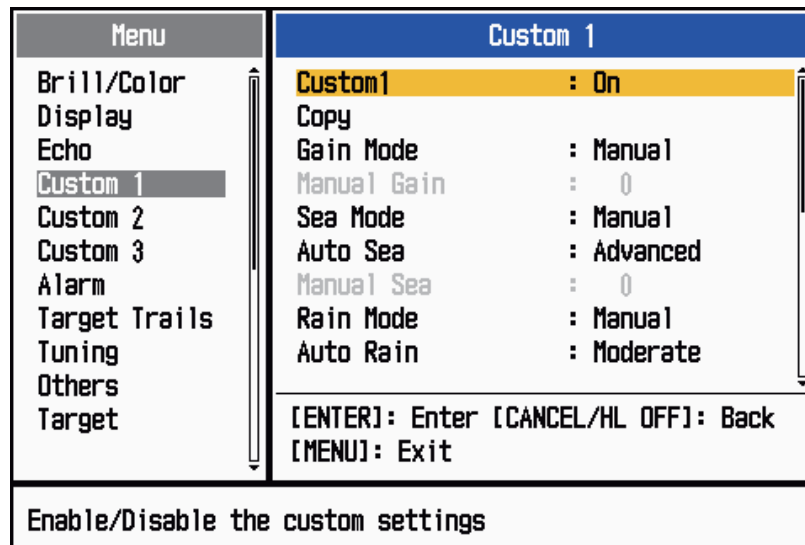

Custom menu

3. Set menu items.
Note: For easy set up, you can copy the settings of the [Echo] menu (to [Custom 1], [Custom 2], [Custom 3]). Select [Copy] and press the **ENTER** key. When the copying is completed, the message "Complete" appears. To erase this message, press any key.
4. Press the **MENU** key to close the menu.

1.29 How to Program Function Keys (F1, F2 and F3 keys)

You can program function keys (**F1**, **F2** and **F3**) to provide one-touch access to a required function.

Function key operation

To activate a function, press function key, **F1**, **F2** or **F3**. Press same key to change the setting.

The default programs are [Gain Mode] for **F1**, [Sea Mode] for **F2**, [A/C Auto] for **F3**. When you press the **F1** or **F2** key, the window for Gain/Sea/Rain indicator shows. See section 1.9 and 1.10 for operation. When you press the **F3** key, [A/C Auto] is turned on.

How to change a function key program

1. Press the **MENU** key to open the menu.
2. Use the Cursorpad (▲ or ▼) to select [Others] and press the **ENTER** key.
3. Use the Cursorpad (▲ or ▼) to select [F1 (F2 or F3) Setup] and press the **ENTER** key.
4. Use the Cursorpad (▲ or ▼) to select a function from the list and press the **ENTER** key. Below are the available functions.

Rings Brill	Pulse Length	WPT Mark
Mark Brill	Echo Stretch	EBL Reference
HL Brill	Echo Average	VRM Unit
Character Brill	Noise Rejector	Cursor Position
View Position	Wiper	TLL Key Mode
Display Color	Int Rejector	Vector Reference
Echo Color	Display-Dynamic	History Dots
Background Color	Display-Curve	History Interval
Character Color	2nd Echo Rejector	CPA
Menu Transparency	Target Alarm 1	TCPA
Echo Color Mode	Target Alarm 2	Proximity
Display Mode	Alarm Level	ARPA-Display
Zoom	Watchman	ARPA-Color
Zoom Mode	Panel Buzzer	ARPA-Auto Acquisition
Echo Area	External Buzzer	ARPA-ACK Lost Targets
Data Box	Trails-Gradation	AIS-Display
STBY Display	Trails-Color	AIS-Color
Gain Mode	Trails-Mode	AIS-Sort By
Sea Mode	Trails-Level	AIS-ACK Lost Targets
Auto Sea	Trails-Restart	GPS-Mode
Rain Mode	Trails-Narrow	GPS-Datum
Auto Rain	Trails-Own Ship	GPS-WAAS
A/C Auto	Tuning Mode	

Function list

5. Press the **MENU** key to close the menu.

1.30 Noise Rejector

White noise can appear on the screen as random "marks". You can reduce this noise as follows:

1. Press the **MENU** key to open the menu.
2. Use the Cursorpad (▲ or ▼) to select [Echo] and press the **ENTER** key.
3. Use the Cursorpad (▲ or ▼) to select [Noise Rejector] and press the **ENTER** key.



Noise Rejector options

4. Use the Cursorpad (▲ or ▼) to select [Off] or [On] then press the **ENTER** key.
5. Press the **MENU** key to close the menu.

1.31 Wiper

The wiper feature automatically reduces the brilliance of unwanted weak signals (noise, sea clutter, rain clutter, etc.) and unnecessary signals, like radar interference, to clear the picture of unnecessary echoes. The result of wiper depends on the wiper setting used and whether echo averaging is turned on or off, as described below.

Echo averaging and wiper states and wiper effect

	Wiper 1	Wiper 2
Echo Average Off	Processing content A	
Echo Average On (1, 2, Auto)	Processing content A	Processing content B

Processing content A: The brilliance of unnecessary weak echoes, like noise and radar interference, is reduced to clear the picture. The difference between wiper 1 and 2 is that brilliance is lowered more slowly in 1.

Processing content B: Echo averaging is automatically turned on from off when the wiper feature is turned on. You can see how the picture changes with the echo averaging turned off and turned on.

To activate the wiper feature, do the following:

1. Press the **MENU** key to open the menu.
2. Use the Cursorpad (▲ or ▼) to select [Echo] and press the **ENTER** key.
3. Use the Cursorpad (▲ or ▼) to select [Wiper] and press the **ENTER** key.

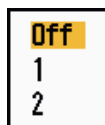

Wiper options

4. Use the Cursorpad (▲ or ▼) to select [1] or [2] then press the **ENTER** key.
5. Press the **MENU** key to close the menu.

Note: When the [Display Mode] is [True View], this function is not available (see section 1.7.2).

1.32 How to Reduce Second-trace Echoes

Echoes from very distant targets can appear as false echoes (second-trace echoes) on the screen. The second-trace echo occurs when the return echo is received one transmission cycle later, or after a next transmission of radar pulse.

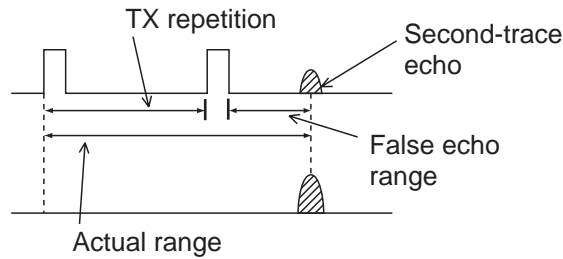

Second-trace echoes

1. Press the **MENU** key to open the menu.
2. Use the Cursorpad (▲ or ▼) to select [Echo] and press the **ENTER** key.
3. Use the Cursorpad (▲ or ▼) to select [2nd Echo Rejector] and press the **ENTER** key.



2nd Echo Rejector options

4. Use the Cursorpad (▲ or ▼) to select [Off] or [On] then press the **ENTER** key.
5. Press the **MENU** key to close the menu.

1.33 Watchman

The Watchman sounds the buzzer to tell the operator to check the radar display. The radar transmits for one minute and then goes into standby for the selected time interval. If the target alarm is active and a target is found in the alarm zone, Watchman is cancelled, and the radar transmits continuously.

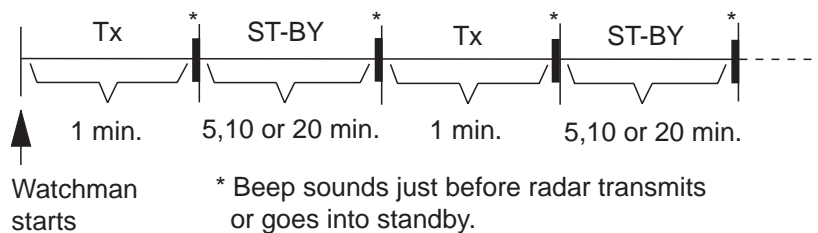

How watchman operates

In standby, the timer near the <WATCH> label at the center of the screen counts down the remaining time until the transmission. When the set time interval has passed, the audio alarm sounds, the timer disappears and the radar transmits for one minute. After one minute, the audio alarm sounds and the watch alarm timer again begins the count-down sequence.

If you press the **STBY/TX** key before the set time interval comes, the radar goes into transmission.

Do the following to activate the Watchman:

1. Press the **MENU** key to open the menu.
2. Use the Cursorpad (▲ or ▼) to select [Alarm] and press the **ENTER** key.
3. Use the Cursorpad (▲ or ▼) to select [Watchman] and press the **ENTER** key.

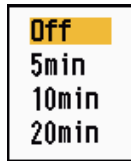

Watchman options

4. Use the Cursorpad (▲ or ▼) to select [Off] or the time ([5min], [10min] or [20min]) then press the **ENTER** key.
5. Press the **MENU** key to close the menu.

1.34 Color Selections

1.34.1 Preset colors

This radar is preset with color combinations that provide best viewing in daytime, nighttime and twilight. Below are the default color settings for each display item and display color setting.

Display item, color design and color

Display item	Day	Night	Twilight	Custom
Characters	Black	Red	Green	Green
Range rings, marks	Green	Red	Green	Green
Echo	Yellow	Green	Green	Yellow
Background	White	Black	Blue	Black

1. Press the **MENU** key to open the menu.
2. Use the Cursorpad (▲ or ▼) to select [Brill/Color] and press the **ENTER** key.
3. Use the Cursorpad (▲ or ▼) to select [Display Color] and press the **ENTER** key.



Display Color options

4. Use the Cursorpad (▲ or ▼) to select the color design and press the **ENTER** key.
5. Press the **MENU** key to close the menu.

1.34.2 Custom colors

The custom color design lets you select preferred echo, background, characters, range rings and marks colors. Select [Custom] in the [Display Color] menu item (see section 1.34.1) to use the user selected echo, background, characters, range rings and marks colors.

1. Press the **MENU** key to open the menu.
2. Use the Cursorpad (▲ or ▼) to select [Brill/Color] and press the **ENTER** key.
3. Use the Cursorpad (▲ or ▼) to select [Echo Color] and press the **ENTER** key.

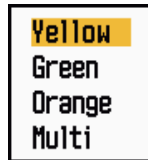

Echo Color options

4. Use the Cursorpad (▲ or ▼) to select an echo color and press the **ENTER** key. [Multi] displays echoes in colors of red, yellow and green according to echo strength, and [Multi] is not available in the [IEC] or [Russian-River] mode.
5. Use the Cursorpad (▲ or ▼) to select [Background Color] and press the **ENTER** key.



Background Color options

6. Use the Cursorpad (▲ or ▼) to select a background color and press the **ENTER** key.
7. Use the Cursorpad (▲ or ▼) to select [Character Color] and press the **ENTER** key.



Character Color options

8. Use the Cursorpad (▲ or ▼) to select a character color (including range rings and marks) and press the **ENTER** key.
9. Press the **MENU** key to close the menu.

1.35 Navigation Data

1.35.1 Navigation data during standby

The navigation data is shown in standby when [STBY Display] on the [Display] menu is set to [Nav]. Appropriate sensors are required to display the data.

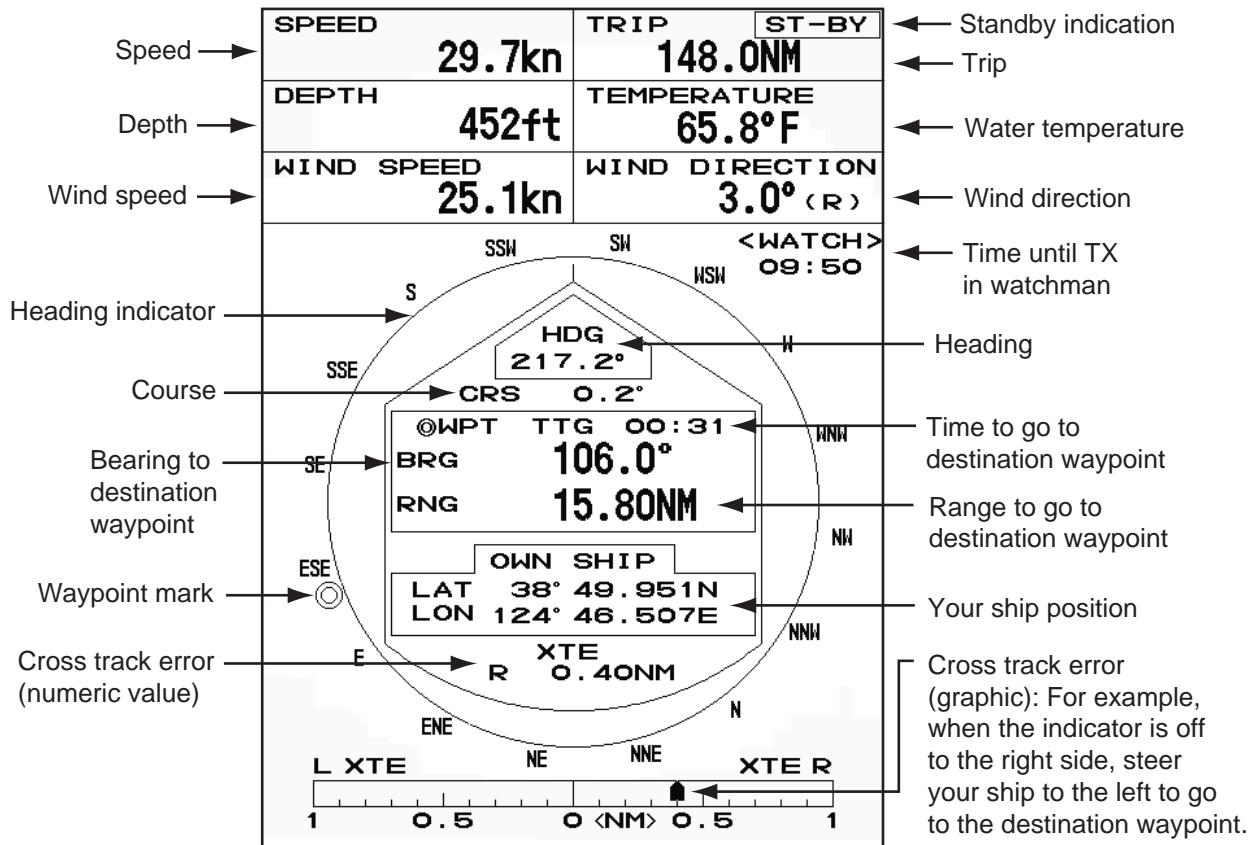

Navigation data display at standby

1.35.2 Navigation data at the bottom of the screen

The navigation data is displayed at the bottom of the screen.

- Cursor latitude position
- Cursor longitude position
- Time to go to cursor position

OWN SHIP		+ CURSOR		WAYPOINT	
LAT	34°56.123N	LAT	34°56.123N	BRG	14.8°
LON	135°34.567E	LON	135°34.567E	RNG	0.876NM
SPEED	12.3KN	TTG	01:00	TTG	00:20

Your ship position and speed

- Bearing from your ship to waypoint
- Range from your ship to waypoint
- Time to go from your ship position to waypoint

Navigation data

1. DESCRIPTION OF OPERATION

To show or hide the navigation data at the bottom of the screen, do the following:

1. Press the **MENU** key to open the menu.
2. Use the Cursorpad (▲ or ▼) to select [Display] and press the **ENTER** key.
3. Use the Cursorpad (▲ or ▼) to select [Data Box] and press the **ENTER** key.

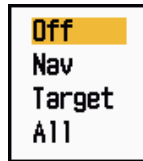

Data Box options

4. Use the Cursorpad (▲ or ▼) to select an option and press the **ENTER** key.
[Off]: Turn off the data display.
[Nav]: Navigation data
[Target]: ARPA and AIS target data (See section 3.8 and 4.5.)
[All]: Navigation data plus ARPA and AIS target data
5. Press the **MENU** key to close the menu.

1.36 Dynamic Range

You can change the dynamic range to erase unwanted weak echoes (sea reflections, etc.). Select [Narrow], [Normal] or [Wide] depending on conditions.

1. Press the **MENU** key to open the menu.
2. Use the Cursorpad (▲ or ▼) to select [Echo] and press the **ENTER** key.
3. Use the Cursorpad (▲ or ▼) to select [Display-Dynamic] and press the **ENTER** key.

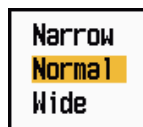

Display-Dynamic options

4. Use the Cursorpad (▲ or ▼) to select [Narrow], [Normal] or [Wide] then press the **ENTER** key.
[Narrow]: Erase weak echoes.
[Normal]: Normal use
[Wide]: Display weaker echoes compared to [Narrow].
5. Press the **MENU** key to close the menu.

1.37 Characteristics Curve

You can change the characteristics curve to reduce unwanted weak echoes (sea reflections, etc.). Select [1], [2] or [3] depending on conditions when unwanted weak echoes hide wanted targets.

1. Press the **MENU** key to open the menu.
2. Use the Cursorpad (▲ or ▼) to select [Echo] and press the **ENTER** key.
3. Use the Cursorpad (▲ or ▼) to select [Display-Curve] and press the **ENTER** key.



Display-Curve options

4. Use the Cursorpad (▲ or ▼) to select [1], [2] or [3] then press the **ENTER** key.
 - [1]**: Reduce weak echoes.
 - [2]**: Normal use
 - [3]**: Display weaker echoes in stronger color compared to [1].

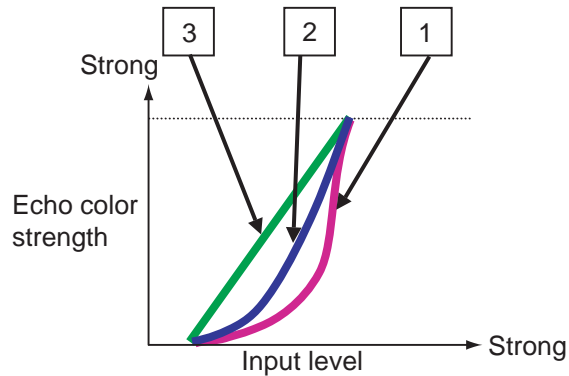

Display curve

5. Press the **MENU** key to close the menu.

1.38 Waypoint Marker

The waypoint marker shows the location of the destination waypoint set on a navigation plotter. The heading signal or course data are required. You can turn on/off the waypoint marker as follows:

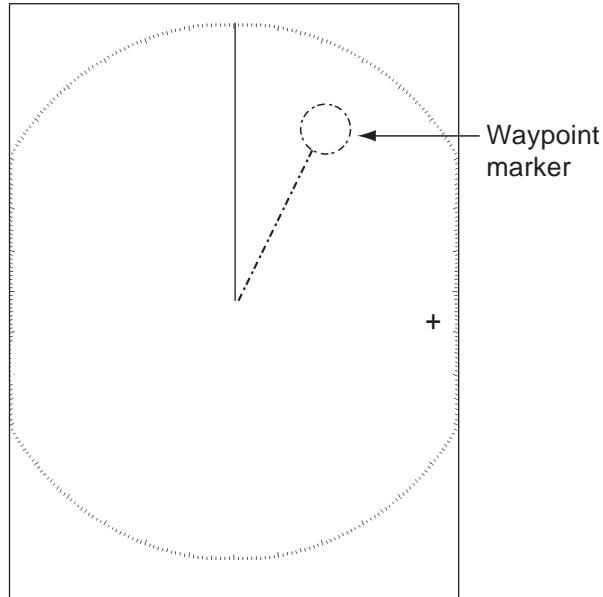

Waypoint marker

1. Press the **MENU** key to open the menu.
2. Use the Cursorpad (▲ or ▼) to select [Others] and press the **ENTER** key.
3. Use the Cursorpad (▲ or ▼) to select [WPT Mark] and press the **ENTER** key.



WPT Mark options

4. Use the Cursorpad (▲ or ▼) to select [Off] or [On] then press the **ENTER** key.
5. Press the **MENU** key to close the menu.

1.39 Alarm Message

The alarm status window shows all currently violated alarms.

Note: The alarm status window is not automatically displayed when an alarm occurs.

1. Press the **MENU** key to open the menu.
2. Use the Cursorpad (▲ or ▼) to select [Alarm] and press the **ENTER** key.

3. Use the Cursorpad (▲ or ▼) to select [Alarm Status] and press the **ENTER** key.

Alarm Status	
[SIGNAL MISSING]	TRIGGER HEADING BEARING GYRO VIDEO POSITION NMEA_HDG
[TARGET ALARM1]	IN OUT
[TARGET ALARM2]	IN OUT
[ARPA ALARM]	COLLISION LOST PROXIMITY
[AIS ALARM]	COLLISION PROXIMITY
[AIS SYSTEM]	TX ANT CH1 CH2 CH70 FAIL MKD EPFS L/L SOG COG HDG ROT
[OTHER]	OVER_TEMP
[CANCEL/HL OFF]:Close	

Alarm Status display

4. Press the **CANCEL/HL OFF** key to close the alarm status display.
 5. Press the **MENU** key to close the menu.

Alarm category	Meaning
SIGNAL MISSING*	
TRIGGER	Trigger signal lost (only for remote display)
HEADING	Heading signal lost
BEARING	Bearing signal lost
GYRO	AD-10 format gyro signal lost
VIDEO	Video signal lost
POSITION	NMEA format position data lost
NMEA_HDG	NMEA format heading signal lost
TARGET ALARM1(2)	
IN	An echo has entered a target alarm zone.
OUT	An echo has exited a target alarm zone.
ARPA ALARM	
COLLISION	CPA and TCPA of an ARPA target is less than CPA and TCPA alarm settings.
LOST	Acquired ARPA target becomes lost.
PROXIMITY	The range to an ARPA target is less than the user-set proximity alarm range.
AIS ALARM	
COLLISION	CPA and TCPA of an AIS target is less than CPA and TCPA alarm settings.
PROXIMITY	The range to an AIS target is less than the user-set proximity alarm range.

1. DESCRIPTION OF OPERATION

Alarm category	Meaning
AIS SYSTEM*	
TX	TX stopped or TX error
ANT	Antenna VSWR problem
CH1	TDM2 RX1 board problem
CH2	TDM2 RX2 board problem
CH70	RX channel 70 problem
FAIL	System failure
MKD	Minimum input device lost
EPFS	Navigator (GPS, etc.) problem
L/L	Position data lost
SOG	Speed data lost
COG	Course data lost
HDG	Heading data lost
ROT	Rate of turn data lost
OTHER*	
OVER_TEMP	The temperature of the equipment is more than the specified value.

*: Have a qualified technician check the equipment.

1.40 Echo Area

You can select the display area from [Normal] or [Full Screen].

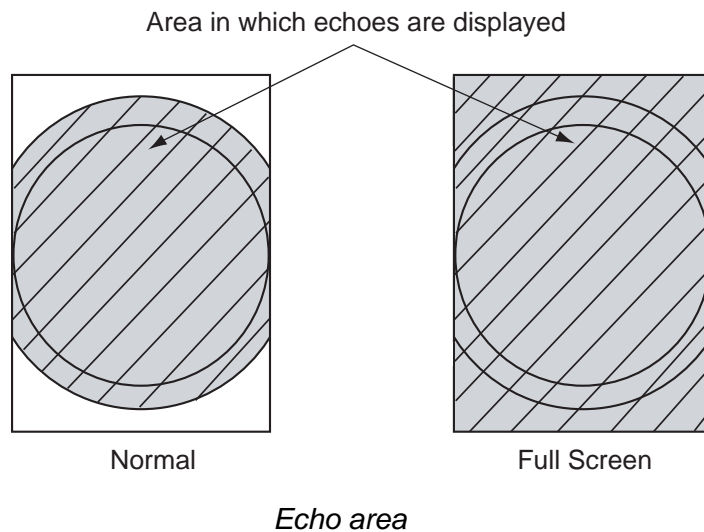

1. Press the **MENU** key to open the menu.
2. Use the Cursorpad (▲ or ▼) to select [Display] and press the **ENTER** key.

- Use the Cursorpad (▲ or ▼) to select [Echo Area] and press the **ENTER** key.

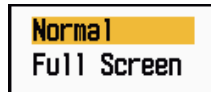

Echo Area options

- Use the Cursorpad (▲ or ▼) to select [Normal] or [Full Screen] then press the **ENTER** key.
- Press the **MENU** key to close the menu.

1.41 Initial Sub Menu

The [Initial] sub menu in the [System] menu contains the items which allow you to customize your radar to meet your needs.

1.41.1 How to open the Initial sub menu

- Press the **MENU** key to open the menu.
- Use the Cursorpad (▲ or ▼) to select [Initial] and press the **ENTER** key.

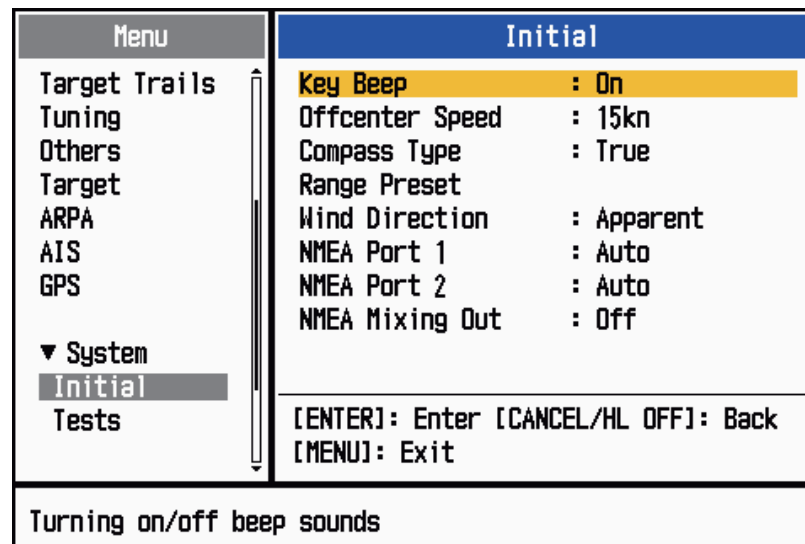

Initial sub menu

1.41.2 Description of Initial sub menu

[Key Beep]: When a key is pressed, a beep sounds. You can turn on or off this beep.

[Offcenter Speed]: Set the speed of your ship to calculate amount of your ship's off-center. The setting range is 1-99 (kn).

[Compass Type]: Select the type of bearing sensor connected to the radar; [True] (gyrocompass, satellite compass) or [Magnetic] (magnetic compass).

[Range Preset]: You can select the radar ranges. Select a range and press the **ENTER** key to switch on and off. At least two ranges must be turned on. The maximum range available depends on the radar model. 0.0625 is not available in KM (kilometers).

1. DESCRIPTION OF OPERATION

0.0625	On
0.125	On
0.25	On
0.5	On
0.75	On
1	Off
1.5	On
1.6	Off
2	Off
3	On
3.2	Off
4	Off
6	On
8	Off
12	On
16	Off
24	On
32	Off
36	On
48	Off
64	Off
Exit?	Yes

0.0625	Off
0.125	On
0.25	On
0.5	On
0.75	On
1	Off
1.5	On
1.6	Off
2	Off
3	On
3.2	Off
4	Off
6	On
8	Off
12	On
16	Off
24	On
32	Off
36	On
48	Off
64	Off
Exit?	Yes

0.0625	On
0.125	On
0.25	On
0.5	On
0.75	On
1	Off
1.5	On
1.6	Off
2	Off
3	On
3.2	Off
4	Off
6	On
8	Off
12	On
16	Off
24	On
32	Off
36	On
48	Off
64	Off
Exit?	Yes

NM (nautical miles)

KM (kilometers)

SM (statute miles)

Available ranges for MODEL 1835

0.0625	On
0.125	On
0.25	On
0.5	On
0.75	On
1	Off
1.5	On
1.6	Off
2	Off
3	On
3.2	Off
4	Off
6	On
8	Off
12	On
16	Off
24	On
32	Off
36	Off
48	On
64	Off
Exit?	Yes

0.0625	Off
0.125	On
0.25	On
0.5	On
0.75	On
1	Off
1.5	On
1.6	Off
2	Off
3	On
3.2	Off
4	Off
6	On
8	Off
12	On
16	Off
24	On
32	Off
36	Off
48	On
64	Off
Exit?	Yes

0.0625	On
0.125	On
0.25	On
0.5	On
0.75	On
1	Off
1.5	On
1.6	Off
2	Off
3	On
3.2	Off
4	Off
6	On
8	Off
12	On
16	Off
24	On
32	Off
36	Off
48	On
64	Off
Exit?	Yes

NM (nautical miles)

KM (kilometers)

SM (statute miles)

Available ranges for MODEL 1935

0.0625	On
0.125	On
0.25	On
0.5	On
0.75	On
1	Off
1.5	On
1.6	Off
2	Off
3	On
3.2	Off
4	Off
6	On
8	Off
12	On
16	Off
24	On
32	Off
36	Off
48	On
64	On
Exit?	Yes

0.0625	Off
0.125	On
0.25	On
0.5	On
0.75	On
1	Off
1.5	On
1.6	Off
2	Off
3	On
3.2	Off
4	Off
6	On
8	Off
12	On
16	Off
24	On
32	Off
36	Off
48	On
64	On
Exit?	Yes

0.0625	On
0.125	On
0.25	On
0.5	On
0.75	On
1	Off
1.5	On
1.6	Off
2	Off
3	On
3.2	Off
4	Off
6	On
8	Off
12	On
16	Off
24	On
32	Off
36	Off
48	On
64	On
Exit?	Yes

NM (nautical miles)

KM (kilometers)

SM (statute miles)

Available ranges for MODEL 1945

[Wind Direction]: Wind direction is shown as [Apparent] or [True].

[NMEA Port 1]: Set the baud rate of the equipment connected to Port 1 ([Auto], [4800], or [38400] (bps)). [Auto] provides automatic detection of baud rate from 4800, 9600, 19200 or 38400 (bps).

[NMEA Port 2]: Same function as Port 1 but for Port 2.

[NMEA Mixing Out]: Data input to Port 1 may be output from Port 2 mixed with data output to Port 2. Select [On] to use this feature.

1.42 Units Sub Menu

You can select the unit of measurement for range, ship speed, depth, temperature and wind speed on the [Units] sub menu in the [System] menu. You can not open this sub menu in normal operation. To open this menu, select [Units], hold the **CANCEL/HL OFF** key and press the **MENU** key five times.

Menu	Units
Target	Range Unit : NM
ARPA	Ship Speed Unit : kn
AIS	Depth Unit : ft
GPS	Temperature Unit : °F
▼ System	Wind Speed Unit : kn
Initial	
Tests	
Sector Blanks	
Units	
Installation	[ENTER]: Enter [CANCEL/HL OFF]: Back [MENU]: Exit
Choosing an unit of range	

Units sub menu

[Range Unit]: NM, KM, SM

[Ship Speed Unit]: kn, km/h, mph

[Depth Unit]: m, ft, fa, pb, HR

[Temperature Unit]: °C, °F

[Wind Speed Unit]: kn, km/h, mph, m/s

1.43 Sector Blank

You must prevent the transmission in some areas to protect passengers and crew from microwave radiation. Also, if the reflections of echoes from the mast appear on the screen, you must prevent the transmission in that area. You can set two sectors.

1. Press the **MENU** key to open the menu.
2. Use the Cursorpad (▲ or ▼) to select [Sector Blanks] and press the **ENTER** key.
3. Use the Cursorpad (▲ or ▼) to select [Sect-Blank 1 (or 2) Status] and press the **ENTER** key.



Sect-Blank Status options

4. Use the Cursorpad (▲ or ▼) to select [On] and press the **ENTER** key.
5. Use the Cursorpad (▲ or ▼) to select [Sect-Blank 1 (or 2) Start] and press the **ENTER** key.

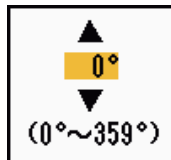

Sect-Blank Start setting window

6. Use the Cursorpad (▲ or ▼) to set the start point of the sector and press the **ENTER** key.
7. Use the Cursorpad (▲ or ▼) to select [Sect-Blank 1 (or 2) End] and press the **ENTER** key.

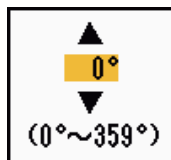

Sect-Blank End setting window

8. Use the Cursorpad (▲ or ▼) to set the end point of the sector and press the **ENTER** key.

Note 1: You can not set the sector more than 180 degrees.

Note 2: You can not set the total width of sector 1 and sector 2 more than 270 degrees.

9. Press the **MENU** key to close the menu.

As shown in the following illustration, dashed lines mark the start and end points of the sector.

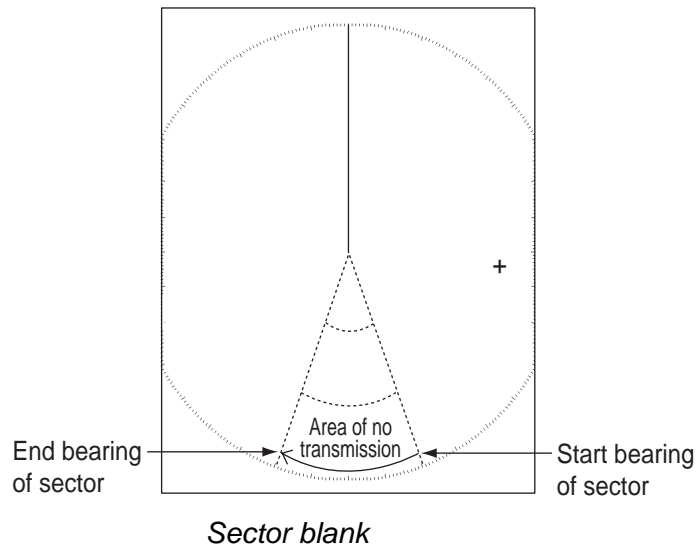

1.44 Other Menu Items

This section describes the menu items not previously described.

1.44.1 Menu items on the [Brill/Color] menu

[View Position]: You can select the angle from where you see the screen.

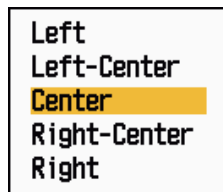

View Position options

[Menu Transparency]: You can select the degree of transparency of the menu window so the menu window does not hide the echo display. [4] is the greatest degree of transparency. [Off] functions to hide the echo display behind the menu window completely.

Note: Alpha blending technology is used for transparency effects.

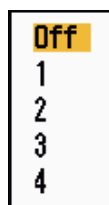

Menu Transparency options

[Echo Color Mode]: You can select the color palette from [System] or [Custom]. [System] is the pre-set color palette and [Custom] is the color palette you can set yourself. This function is not available in the [IEC] or [Russian-River] mode.

1. DESCRIPTION OF OPERATION

[Custom Echo Color]: You can customize the echo color with the following two methods. This function is not available in the [IEC] or [Russian-River] mode.

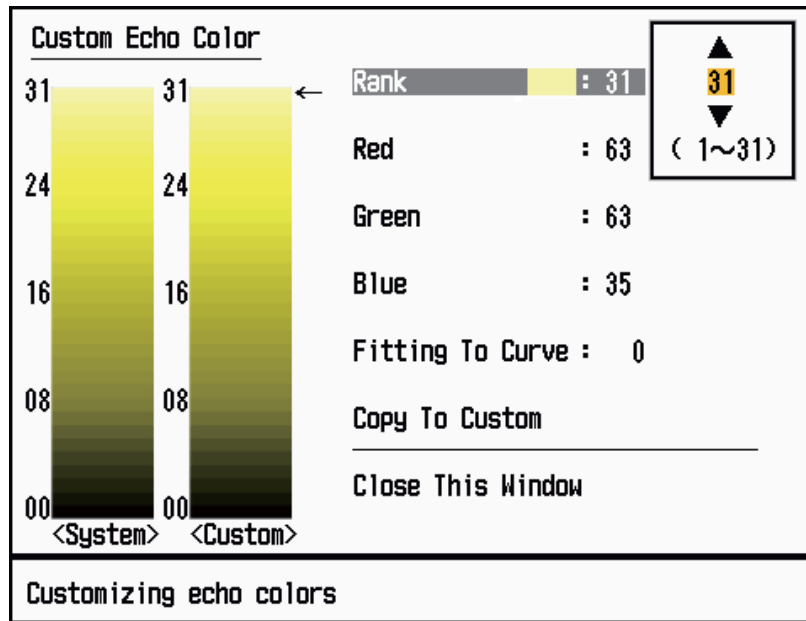

Custom Echo Color setting window

Method 1: 1) Select the echo rank to change on the [Rank] (setting range: 1 - 31).
2) Set the RGB values for selected echo rank on the [Red], [Green] and [Blue] (setting range: 0 - 63).

Method 2: 1) Select 31 on the [Rank].
2) Set the RGB values for 31 echo rank on the [Red], [Green] and [Blue] (setting range: 0 - 63).
3) Interpolate the RGB values between the maximum rank and minimum rank on the [Fitting To Curve] with the following curves (setting range: -20 to 20).
Setting range > 0: Logarithmic curve, useful to emphasize the weak echoes.
Setting range = 0: Straight line
Setting range < 0: Exponential curve, useful to emphasize the strong echoes.

[Copy To Custom]: Copy the color palette from [System] to [Custom].

1.44.2 Menu items on the [Display] menu

[Base Text Display]: You can select on/off for the text indications of the following items on the display. The settings on this function are used when you set [Echo Area] to [Full Screen] on the [Display] menu. This function is not available in the [IEC] or [Russian-River] mode.

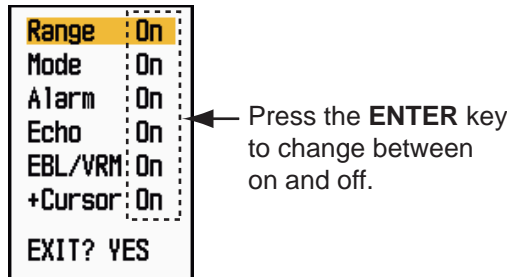

Base Text Display options

The text indications set to off appear when you operate any key. The indications disappear when there is no key operation for 10 seconds.

[Gain/Sea/Rain Bar]: Open the Gain/Sea/Rain indicator. You can check the current settings.

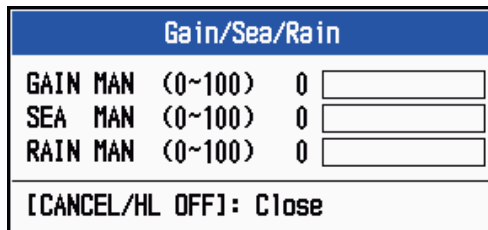

Gain/Sea/Rain Bar

[STBY Display]: Set the function of the standby display.



STBY Display options

[Normal]: Display "ST-BY" at the screen center.

[Nav]: Display navigation data.

[Economy]: Turn off the backlight of the LCD. The radar must be switched from TX to ST-BY to activate this mode.

1.44.3 Menu items on the [Echo] menu

[Color Erase]: Erase the lower echo color whose level is set here. Set a large value to display only the stronger echoes.

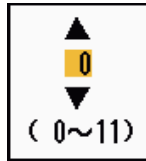

Color Erase setting window

1.45 Remote Display

You can use this radar as a remote display when you set [Input Source] to [Slave] on the [Installation] sub menu. When this setting is done, the menu and display change as described below. To display the radar image on the remote display, transmit from the main radar.

Note: The message "Please turn to STBY-mode when you change this setting." appears when you switch the mode in transmission.

Unavailable menu items

The menu items are not available with the remote display as shown in the table.

Menu	Unavailable menu item(s)
[Echo]	[Pulse Length], [2nd Echo Rejector]
[Custom 1, 2, 3]	[Pulse Length]
[Alarm]	[Watchman]
[Tuning]	All menu items are inoperative.
[System] - [Sector Blanks]	All menu items are inoperative.
[System] - [Installation]	[Antenna Rotation], [MBS Adjust], [Auto Install Setup], [Total TX Time]

Display appearance

The display changes as shown in the following illustration.

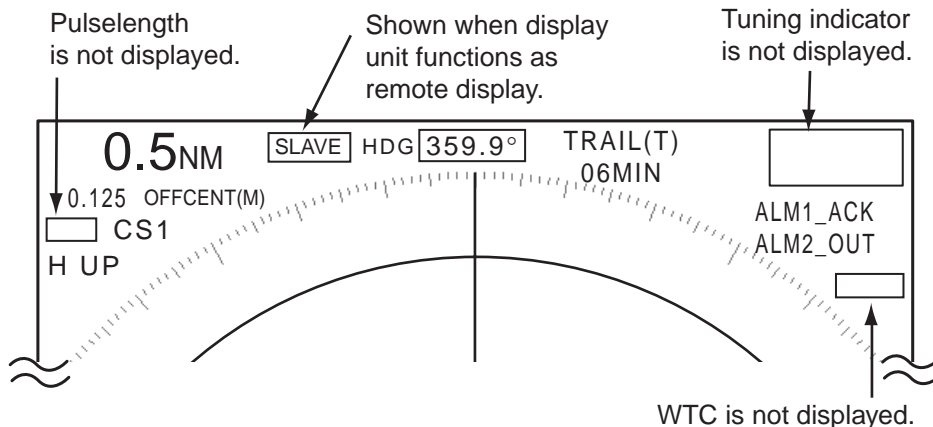

Transmitting or standby display indications for remote display

Items unavailable with Function key F1, F2 and F3

- [Pulse Length] ([Echo] menu)
- [2nd Echo Rejector] ([Echo] menu)
- [Watchman] ([Alarm] menu)
- [Tuning Mode] ([Tuning] menu)

Total TX time indication

The total TX time (TX TIME XXXXXX.XH) does not appear on the diagnostic test or on the Normal standby display.

1. DESCRIPTION OF OPERATION

This page is intentionally left blank.

2. DESCRIPTION OF RADAR

2.1 General

2.1.1 Minimum and maximum ranges

Minimum range

The minimum range is defined by the shortest distance at which, using a scale of 0.0625 or 0.125 nm, a target having an echoing area of 10 m² is shown separate from the point representing the antenna position.

The minimum range depends on the pulselength, antenna height, and signal processing (like main bang suppression and digital quantization). Use a shorter range scale as far as it gives favorable definition or clarity of picture. This MODEL 1835 series meets the requirements of IEC 62252 5.14.1 (Class A).

Maximum range

The maximum detection range, R_{max}, varies depending on the height of the antenna, the height of the target above the sea, the size, shape and material of the target, and the atmospheric conditions.

Under normal atmospheric conditions, the maximum range is equal or a little shorter than the optical horizon. The radar horizon is longer than the optical one by approximately 6% because of the diffraction property of the radar signal. The R_{max} is shown in the following formula.

$$R_{\max} = 2.2 \times (\sqrt{h_1} + \sqrt{h_2})$$

where R_{max}: radar horizon (nautical miles)

h₁: antenna height (m)

h₂: target height (m)

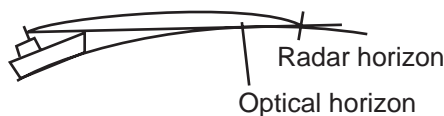

If the height of the antenna is 9 m and the height of the target is 16 m, the maximum radar range is;

$$R_{\max} = 2.2 \times (\sqrt{9} + \sqrt{16}) = 2.2 \times (3 + 4) = 15.4 \text{ nm}$$

Note: The detection range is reduced by precipitation (which absorbs the radar signal).

2.1.2 Radar resolution

The bearing resolution and range resolution are important in radar resolution.

Bearing resolution

The bearing resolution is the ability of the radar to display the echoes received from two targets at the same range as the separate echoes. The bearing resolution is proportional to the antenna length and the wavelength.

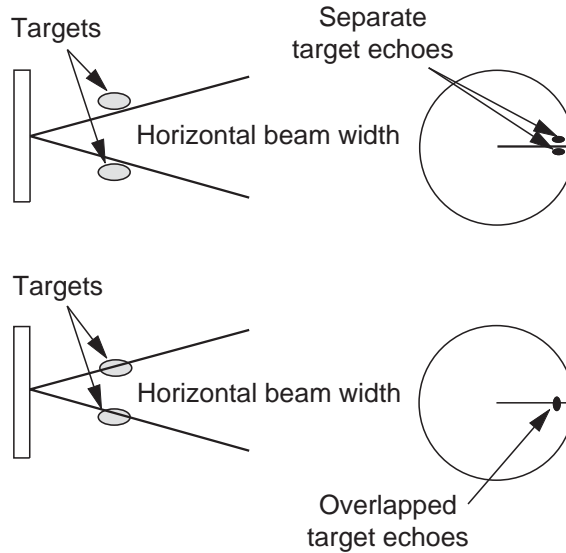

Range resolution

The range resolution is the ability to display the echoes received from two targets on the same bearing as separate echoes. The range resolution is determined by only pulselength.

The test targets used to determine the range and bearing resolution are radar reflectors that have an echoing area of 10 m².

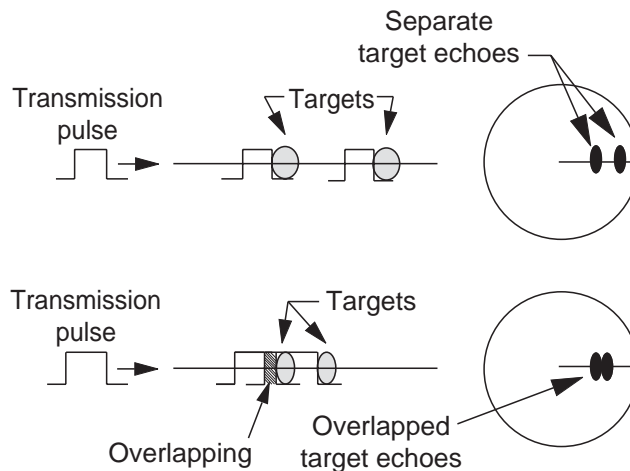

2.1.3 Bearing accuracy

One of the most important features of the radar is how accurately the bearing of a target can be measured. The accuracy of bearing measurement depends on the narrowness of the radar beam. The bearing is taken relative to the heading of the ship. Correct adjustment of the heading line at installation is important to get accurate bearings. To minimize the error when you measure the bearing of a target, put the target echo at the extreme position on the screen by selecting a suitable range.

2.1.4 Range measurement

Measurement of the range to a target is important function of the radar. There are three methods of measuring range: the fixed range rings, the Variable Range Marker (VRM), and the cursor (if set to measure range and bearing). The fixed range rings appear on the screen with a given interval and provide a rough estimate of the range to a target. The diameter of VRM is increased or decreased so that the marker touches the inner edge of the target (see section 1.15.2). The VRM is a more accurate range measurement than the fixed range rings. For cursor, see section 1.13.

2.2 False Echoes

The echo signals can appear on the screen at positions where there is no target or disappear when there are targets. These false echoes are shown below.

2.2.1 Multiple echoes

Multiple echoes occur when a transmitted pulse returns from a solid object like a large ship, bridge, or breakwater. A second, a third or more echoes can be seen on the display at double, triple or other multiples of the actual range of the target as shown below. You can reduce and remove the multiple reflection echoes with the **A/C SEA** control.

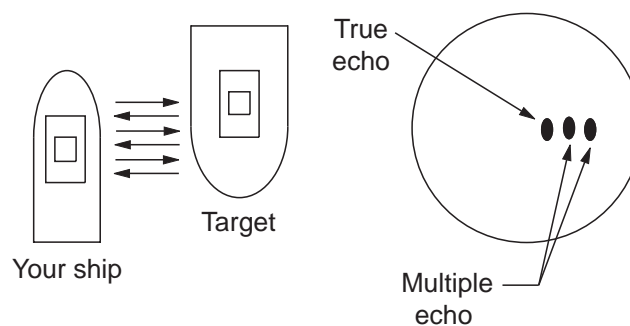

Multiple echoes

2.2.2 Sidelobe echoes

When the radar pulse is transmitted, some radiation escapes on each side of the beam, called "sidelobes". If a target is where a target can be detected by the sidelobes as well as the mainlobe, the side echoes can be shown on both sides of the true echo at the same range. Sidelobes show normally only on short ranges and from strong targets. You can reduce the sidelobes with the **A/C SEA** control.

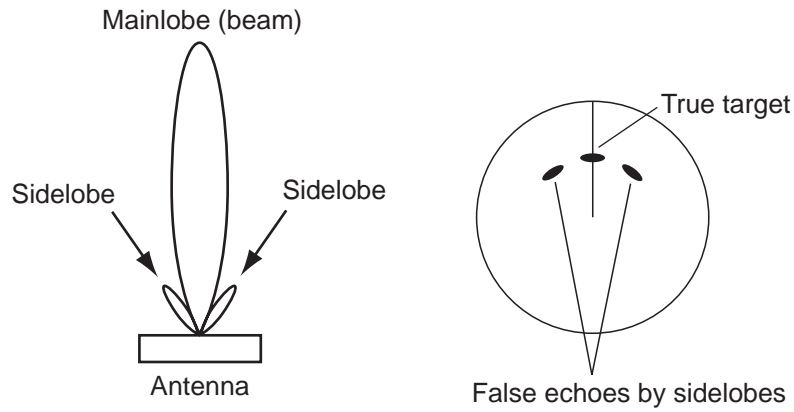

Sidelobe echoes

2.2.3 Virtual image

A large target close your ship can appear at two positions on the screen. One of them is the true echo reflected by the target. The other is a false echo which is caused by the mirror effect of a large object on or close your ship as shown in the following figure. If your ship comes close to a large metal bridge, for example, a false echo can temporarily appear on the screen.

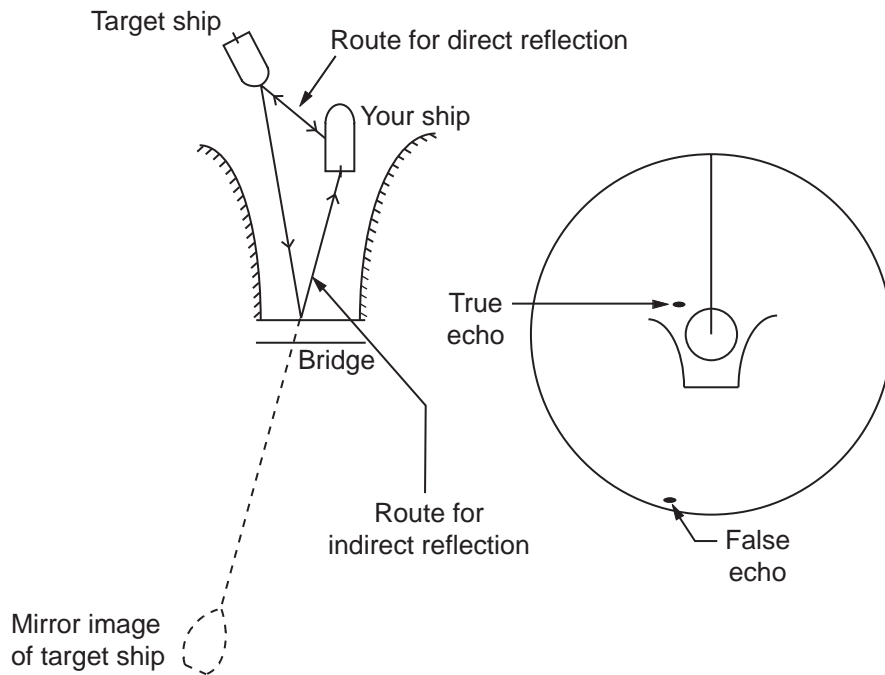

Virtual image

2.2.4 Shadow sector

Funnels, stacks, masts, or derricks near the antenna interrupt the radar beam, and a non-detecting sector can occur. Targets can not be detected within this sector.

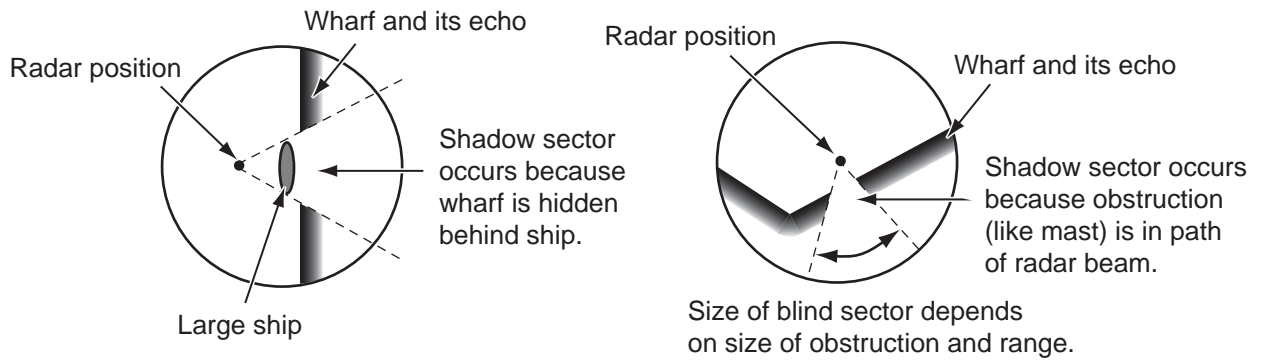

Shadow sector

2.3 SART (Search and Rescue Transponder)

2.3.1 SART description

When any X-band radar reaches within a range of approximately 8 nm, a Search and Rescue Transponder (SART) sends a response to the radar signal. The transmitter signal of response is 12-sweeps signal between 9,500 MHz to 9,200 MHz. The time of slow sweep signal is $7.5 \mu\text{s}$ and the time of fast sweep signal is $0.4 \mu\text{s}$. When the radar receives this SART signal, a line of 12 dots appears. When the position of SART is distant, the radar display shows only slow sweep signals like the illustration of screen A.

When the radar reaches the SART within approximately 1 nm, the radar display can also show the 12 responses of fast sweep signals like the illustration of screen B. The position of the SART is the closest position of the radar echoes.

Screen A: When SART is distant

Screen B: When SART is close

Lines of 12 dots are displayed in concentric arcs.

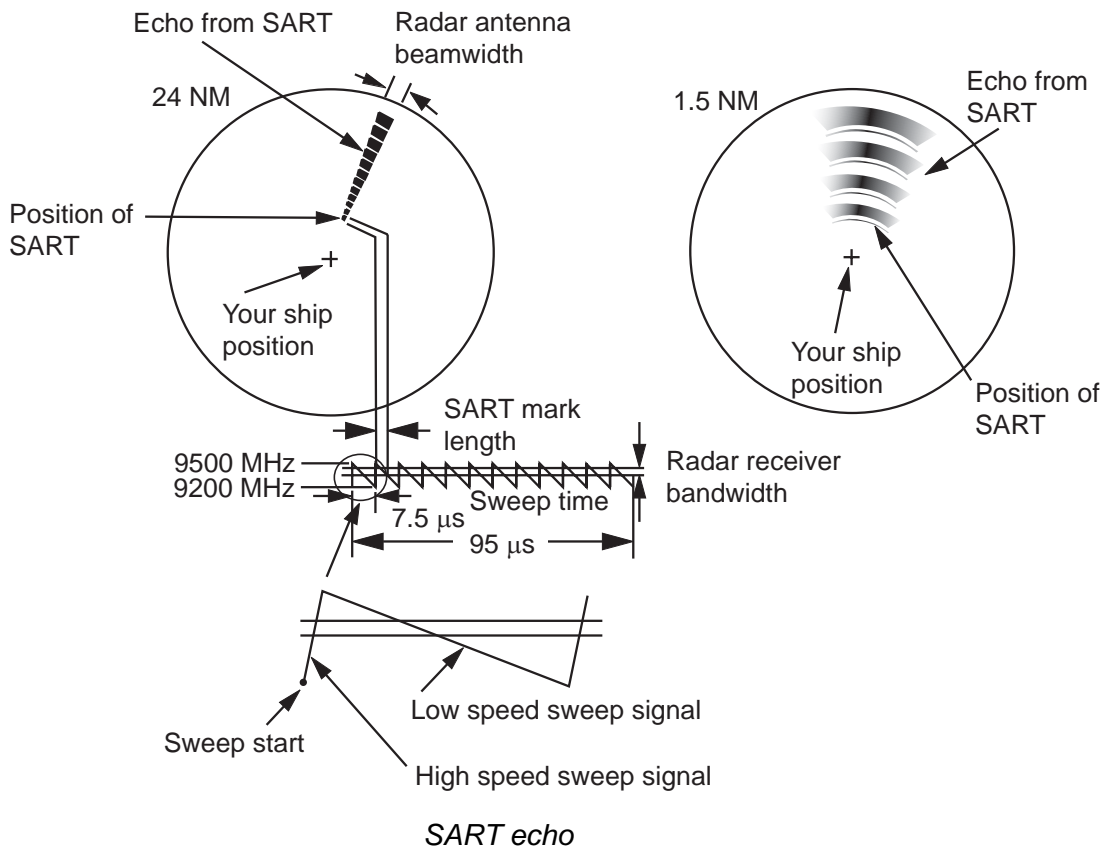

2.3.2 General remarks on receiving SART

SART range errors

When the SART is at a range greater than approximately 1 nm, the first dot is displayed at 0.64 nm beyond the true position of the SART. When the range closes so that the fast sweep responses are seen also, the first range echoes are displayed at 150 m beyond the true position.

Range scale

When you find the SART position, do as follows:

1. Use the **RANGE** key to set the range scale to 6 nm or 12 nm.
2. Turn off [A/C Auto].
3. Turn off [Int Rejector].

SART display

To display only the SART echo clearly on the radar screen, reduce the tuning on manual mode. The normal radar echoes get weak, however, the SART echoes remain. Your ship comes close to the SART, the arc for the SART display becomes larger. Most of the radar screen becomes fuzzy. Adjust the **A/C SEA** and **GAIN** controls to display the necessary screen.

2.4 RACON

A RACON is a radar beacon which emits radar-receivable signals in the radar frequency spectrum (X- or S-band). There are several signal formats; in general, the RACON signal appears on the radar screen as a rectangular echo originating at a point just beyond the position of the radar beacon. It has a Morse coded pattern. Note that the position on the radar display is not accurate.



Echoes on the radar screen

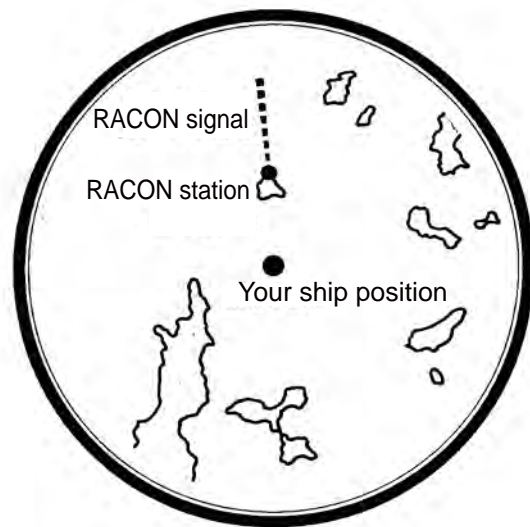

Echo description

RACON

3. ARPA OPERATION

The Automatic Radar Plotter ARP-11 (option) manually or automatically acquires and tracks ten targets. Once a target is acquired automatically or manually, a target is automatically tracked within 0.1 to 16 nm.

3.1 Precautions for Use

 CAUTION
<p>Do not depend on one navigation device for the navigation of the ship. The navigator must check all aids available to confirm position. Electronic aids are not a replacement for basic navigation principles and common sense.</p> <p>The ARPA automatically tracks an automatically or manually acquired radar target and calculates its course and speed, indicating them by a vector. Since the data from the auto plotter depend on the selected radar targets, the radar must be optimally tuned for use with the auto plotter, to ensure required targets will not be lost or unnecessary targets like sea returns and noise will not be acquired and tracked.</p> <p>A target is not always a landmass, reef, ship, but can be returns from the sea surface and clutter. As the level of clutter changes with the environment, the operator must correctly adjust the A/C SEA, A/C RAIN and GAIN controls so that the target echoes do not disappear from the radar screen.</p>

 CAUTION
<p>The plotting accuracy and response of this ARPA meets IMO standards. The tracking accuracy is affected by the following:</p> <p>The tracking accuracy is affected by course change. One to two minutes is required to restore vectors to full accuracy after a sudden course change. (The actual amount depends on gyrocompass specifications.) The amount of tracking delay is inversely proportional to the relative speed of the target. Delay is on the order of 15-30 seconds for high relative speed; 30-60 seconds for low relative speed.</p>
<p>The display accuracy is affected by the following:</p> <ul style="list-style-type: none">Echo intensityPulse width of radar transmissionRadar bearing errorGyrocompass errorCourse change (your ship or target)

3.2 Controls for Use with ARPA

ENTER: Acquire cursor-selected target. Display data for tracked target (in the data box at the bottom of the screen).

CANCEL/HL OFF: Remove data of cursor-selected tracked target from the data box. Stop tracking the cursor-selected target (when its data is not displayed in the data box).

MENU: Access the [Target] and [ARPA] menus for ARPA operations.

Cursorpad: Select a target to acquire (or cancel the tracking). Select a target to show (or remove) target data.

3.3 ARPA Display On/Off

You can turn the ARPA display on or off. The system continuously tracks ARPA targets regardless of this setting.

1. Press the **MENU** key to open the menu.
2. Use the Cursorpad (▲ or ▼) to select [ARPA] and press the **ENTER** key.
3. Use the Cursorpad (▲ or ▼) to select [Display] and press the **ENTER** key.



ARPA-Display options

4. Use the Cursorpad (▲ or ▼) to select [Off] or [On] then press the **ENTER** key.
5. Press the **MENU** key to close the menu.

3.4 How to Acquire and Track the Targets

Ten targets are acquired and tracked manually or automatically.

3.4.1 Manual acquisition

You can acquire up to ten ARPA targets. When the automatic acquisition ([Auto Acquisition] on the [ARPA] menu) is set to on, you can manually acquire up to five targets.

1. Use the Cursorpad to put the cursor on the target to acquire.
2. Press the **ENTER** key.

The ARPA target symbol changes over time as below. A vector which indicates the motion direction of the target appears approximately one minute after acquisition.

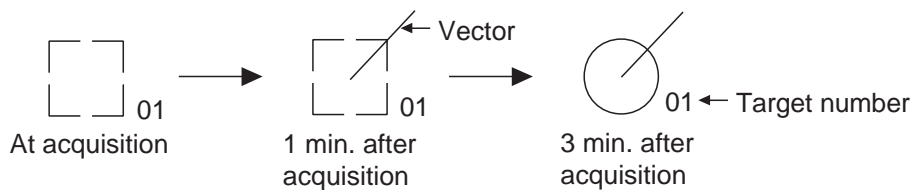

ARPA target symbol

Target number

River and Sea (Non-IEC system): An acquired target gets the youngest unused number. When a target is lost and disappears from the number list, the next acquired target takes the number of that lost target (ie; In a 5 target list, if the target 2 is lost, the next acquired target takes the number of target 2).

IEC and Russian-River (IEC system): An acquired target gets the youngest unused number. When a target is lost and disappears from the number list, the next acquired target takes the next sequential number until reaching a maximum 10. If the target number reaches a maximum 10, the next acquired target takes the number of a previously lost target.

3.4.2 Automatic acquisition

When you set an automatic acquisition area, the ARPA can acquire up to five targets automatically.

The automatic acquisition area is 2.0 to 2.5 nm in range and $\pm 45^\circ$ on either side of the heading line in bearing. When you change the automatic acquisition to manual acquisition, targets being tracked in automatic acquisition are continuously tracked.

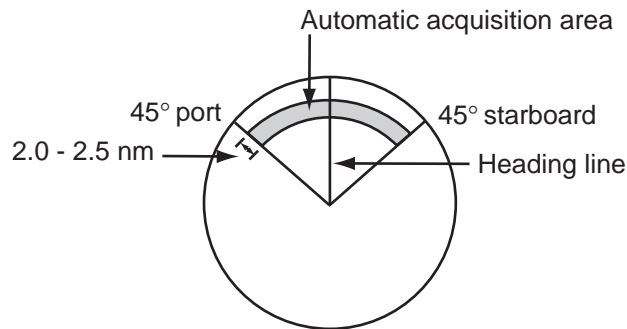

Automatic acquisition area

1. Press the **MENU** key to open the menu.
2. Use the Cursorpad (**▲** or **▼**) to select [ARPA] and press the **ENTER** key.
3. Use the Cursorpad (**▲** or **▼**) to select [Auto Acquisition] and press the **ENTER** key.



Auto Acquisition options

4. Use the Cursorpad (**▲** or **▼**) to select [On] and press the **ENTER** key.
5. Press the **MENU** key to close the menu.

3.5 How to Stop the Tracking of ARPA Target

When ten targets have been acquired, no more acquisition occurs unless targets are cancelled. If you acquire additional targets, you must cancel one or more individual targets, or all targets. Use one of the following procedures.

3.5.1 How to stop the tracking of selected targets

1. Use the Cursorpad to put the cursor on the target to cancel the tracking.
2. Press the **CANCEL/HL OFF** key to cancel the tracking and erase the ARPA symbol. The unit beeps twice and the symbol is erased from the screen.

3.5.2 How to stop the tracking of all targets

1. Press the **MENU** key to open the menu.
2. Use the Cursorpad (**▲** or **▼**) to select [ARPA] and press the **ENTER** key.

3. ARPA OPERATION

- Use the Cursorpad (▲ or ▼) to select [All Cancel] and press the **ENTER** key.

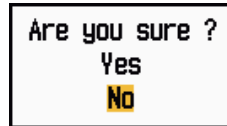

All Cancel options

- Use the Cursorpad (▲) to select [Yes] and press the **ENTER** key. All symbols are erased from the screen and the long beep sounds.
- Press the **MENU** key to close the menu.

3.6 Vector Attributes

3.6.1 What is a vector?

A vector is a line extending from a tracked target. A vector shows speed and course of the target. The top of a vector shows estimated position of the target after the selected vector time elapses. If you extend the vector length (time), you can evaluate the risk of collision with any target.

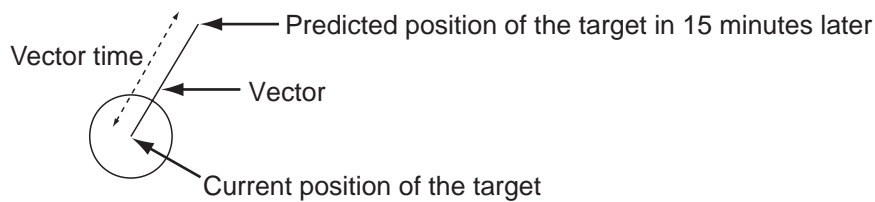

When vector time is 15 minutes

3.6.2 Vector time and vector reference

- Press the **MENU** key to open the menu.
- Use the Cursorpad (▲ or ▼) to select [Target] and press the **ENTER** key.

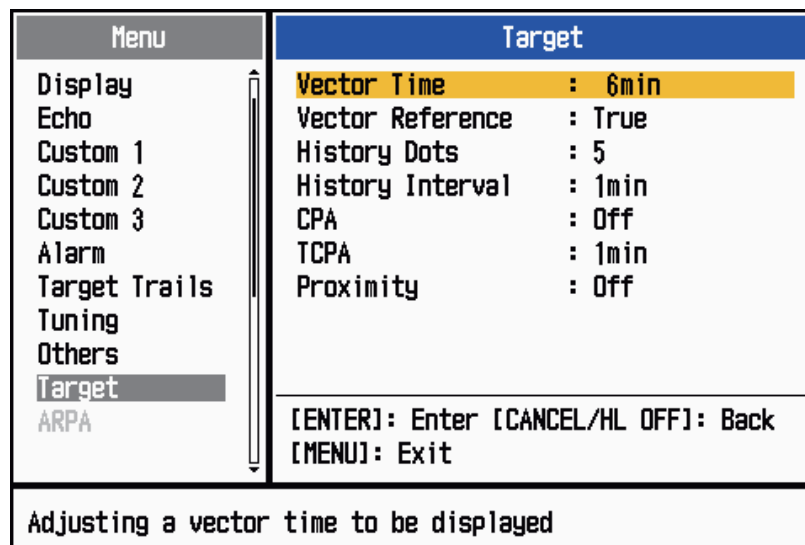

Target menu

3. Use the Cursorpad (▲ or ▼) to select [Vector Time] and press the **ENTER** key.



Vector Time setting window

4. Use the Cursorpad (▲ or ▼) to select time and press the **ENTER** key.
 5. Use the Cursorpad (▲ or ▼) to select [Vector Reference] and press the **ENTER** key.

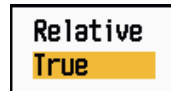

Vector Reference options

6. Use the Cursorpad (▲ or ▼) to select [Relative] or [True] then press the **ENTER** key. This function is not activate for [IEC] or [Russian-River] purpose. The mode is set to [True].
[Relative]: Other ships' vectors are displayed relative to your ship. This mode helps find targets on a collision course. If a ship is on a collision course with your ship, the vector of a ship points toward your ship position.
[True]: Your ship's and other ships' vectors are displayed at their true motions. This mode helps discriminate between moving and stationary targets.
7. Press the **MENU** key to close the menu.

Note: The functions of the [Target] menu are shared by ARPA and AIS.

3.6.3 Vector of your ship

The vector of your ship is shown as an arrow from your ship position. The vector of your ship is shown on the following conditions:

- Connect ARP-11 (option)
- Select [True] on the menu item [Vector Reference] on the [Target] menu
- Independent of on/off on the menu item [Display] on the [ARPA] menu

Note: The vector of your ship is shown in the same color as the ARPA symbol color (see section 3.12).

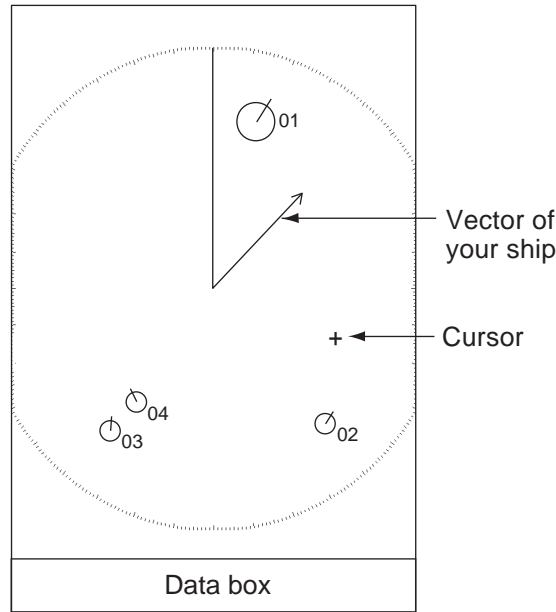

3.7 History Display (target past position)

This radar can display time-spaced dots (maximum ten dots) that mark the past positions of any tracked ARPA target. You can evaluate actions of a target by the spacing between dots. Below are examples of dot spacing and target movement.

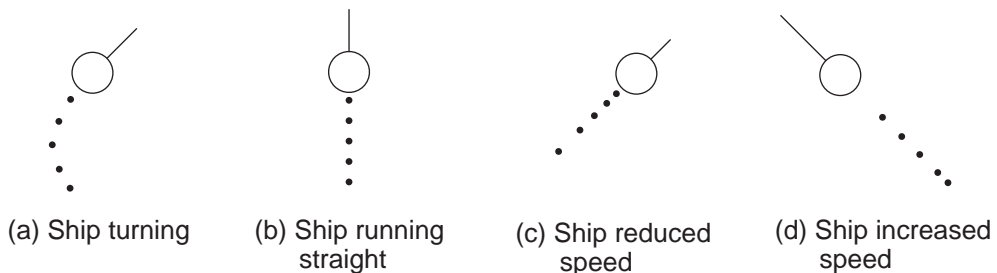

Target movement and history display

You can select the number of history dots to display and the time interval to display the history dots.

1. Press the **MENU** key to open the menu.
2. Use the Cursorpad (▲ or ▼) to select [Target] and press the **ENTER** key.
3. Use the Cursorpad (▲ or ▼) to select [History Dots] and press the **ENTER** key.

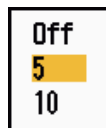

History Dots options

4. Use the Cursorpad (▲ or ▼) to select number of history dots to display (5 or 10) or select [Off] to turn off the history display.
5. Press the **ENTER** key.

6. Use the Cursorpad (▲ or ▼) to select [History Interval] and press the **ENTER** key.

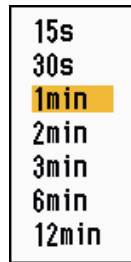

History Interval options

7. Use the Cursorpad (▲ or ▼) to select the time interval and press the **ENTER** key.
8. Press the **MENU** key to close the menu.

3.8 ARPA Target Data

You can show the data for a tracked ARPA target in the data box at the bottom of the screen. To display ARPA target data, the menu item [Display] on the [ARPA] menu must be set for [On] and the menu item [Data Box] on the [Display] menu must be set for [Target] or [All].

1. Use the Cursorpad to put the cursor on an ARPA target.
2. Press the **ENTER** key to show the data of the target.

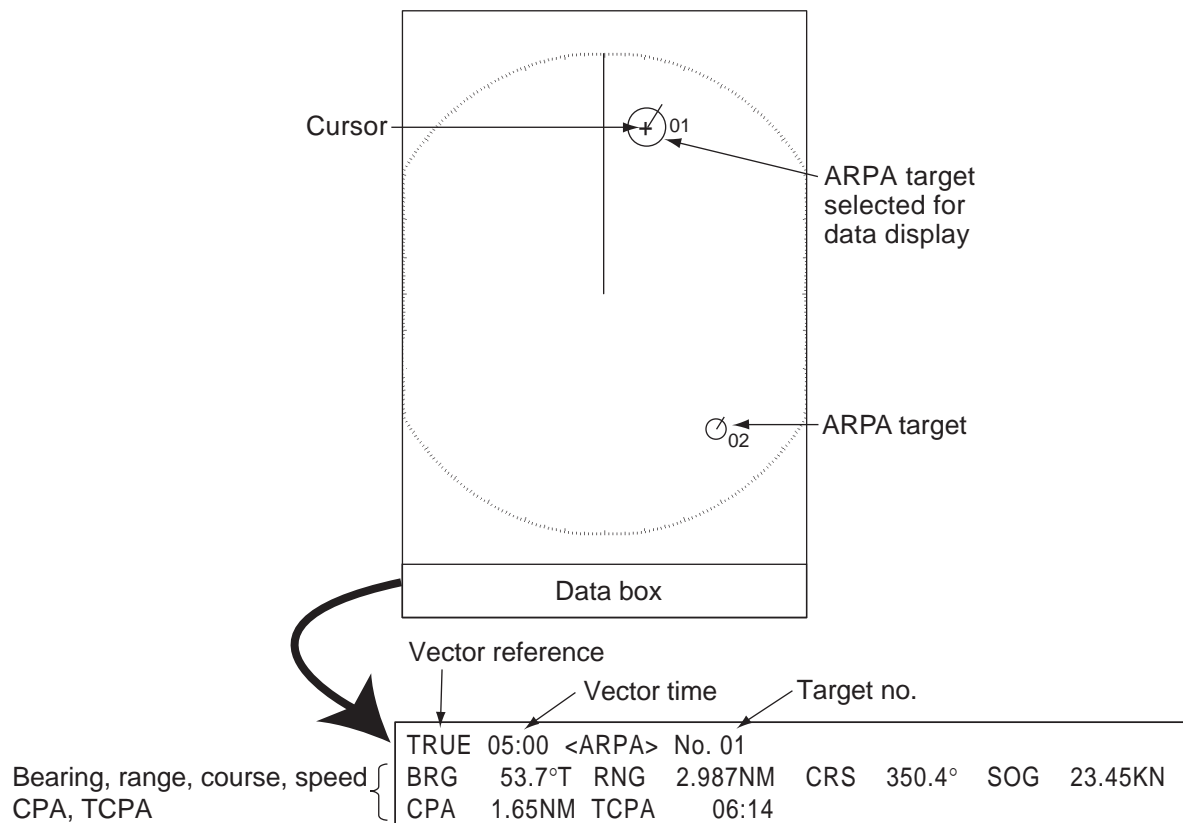

ARPA target data

The symbol for the selected ARPA target is enlarged double to distinguish from other symbols.

To remove the data of a target from a data box, put the cursor on its target symbol and press the **CANCEL/HL OFF** key.

3.9 CPA/TCPA Alarm

Set CPA (Closest Point of Approach) alarm range and TCPA (predicted Time to CPA) alarm time to alert you to targets that can be on a collision course. When CPA and TCPA of any ARPA target become less than the preset CPA and TCPA alarm settings, the audio alarm sounds. The alarm message "COLLISION" appears. The target symbol changes to a dangerous target symbol (triangle) and flashes with its vector. You can stop the audio alarm with any key. The flashing of the triangle stops when the tracked ARPA target is not in the CPA and TCPA alarm setting. The ARPA continuously monitors CPA and TCPA of all tracked ARPA targets.



Dangerous target symbol

This feature helps identify targets that can be on a collision course. Correctly adjust **GAIN, A/C SEA, A/C RAIN** and other radar controls.

 CAUTION
Do not depend on the CPA/TCPA alarm as the only method to detect the risk of collision. The navigator is not released of the responsibility to keep visual caution for collision situations, whether or not the radar or other plotting aid is in use.

1. Press the **MENU** key to open the menu.
2. Use the Cursorpad (▲ or ▼) to select [Target] and press the **ENTER** key.
3. Use the Cursorpad (▲ or ▼) to select [CPA] and press the **ENTER** key.

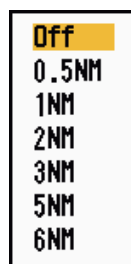

CPA options

4. Use the Cursorpad (▲ or ▼) to select CPA distance and press the **ENTER** key.

- Use the Cursorpad (▲ or ▼) to select [TCPA] and press the **ENTER** key.

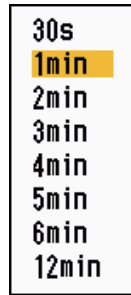

TCPA options

- Use the Cursorpad (▲ or ▼) to select TCPA and press the **ENTER** key.
- Press the **MENU** key to close the menu.

3.10 Proximity Alarm

The proximity alarm alerts you when an ARPA target is within the range you set. The audio alarm sounds and the alarm message "PROXIMITY" appears. The target symbol changes to a dangerous target symbol (triangle, see section 3.9) and flashes with its vector. Press any key to stop the audio alarm. The flashing continues until the target is not within the range set, the alarm range is changed to exclude the target, or the proximity alarm is deactivated.

- Press the **MENU** key to open the menu.
- Use the Cursorpad (▲ or ▼) to select [Target] and press the **ENTER** key.
- Use the Cursorpad (▲ or ▼) to select [Proximity] and press the **ENTER** key.

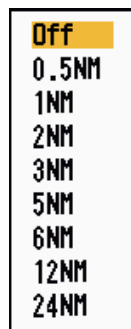

Proximity options

- Use the Cursorpad (▲ or ▼) to select the range and press the **ENTER** key.
- Press the **MENU** key to close the menu.

3.11 Lost Target

When the system detects a lost target, the audio alarm sounds and the alarm message "LOST" appears. The target symbol becomes a flashing square like the following illustration. When the system detects the target again, the target symbol becomes a normal symbol.

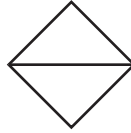

Lost target symbol

To erase a lost target symbol, put the cursor on the symbol and press the **CANCEL/HL OFF** key. If you leave a lost target symbol flashing, the symbol disappears after one minute.

You can remove all lost ARPA targets from the screen as follows:

1. Press the **MENU** key to open the menu.
2. Use the Cursorpad (▲ or ▼) to select [ARPA] and press the **ENTER** key.
3. Use the Cursorpad (▲ or ▼) to select [ACK Lost Targets] and press the **ENTER** key.

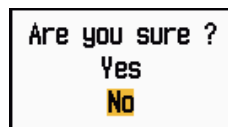

ACK Lost Targets options

4. Use the Cursorpad (▲) to select [Yes] and press the **ENTER** key. All lost target symbols are erased from the screen and the long beep sounds.
5. Press the **MENU** key to close the menu.

3.12 Symbol Color

You can select the ARPA symbol color from Green, Red, Blue, White or Black.

1. Press the **MENU** key to open the menu.
2. Use the Cursorpad (▲ or ▼) to select [ARPA] and press the **ENTER** key.
3. Use the Cursorpad (▲ or ▼) to select [Color] and press the **ENTER** key.

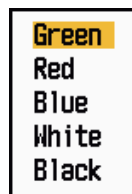

Color options

4. Use the Cursorpad (▲ or ▼) to select the color and press the **ENTER** key.
5. Press the **MENU** key to close the menu.

Note: Symbols can not be shown in the same color as the background color.

4. AIS OPERATION

Connected to the FURUNO AIS Transponders FA-150, FA-100, FA-50 or the AIS Receiver FA-30, the MODEL 1835 series can show the name, position and other navigation data of the nearest 100 AIS transponder-equipped ships.

This radar accepts position data fixed by WGS-84 geodetic datum. Set the datum to WGS-84 on the GPS navigator connected to this radar. If this radar is interfaced with the FURUNO GPS Navigator GP-320B, see section 5.2 for the procedure.

4.1 Controls for Use with AIS

ENTER: Activate cursor-selected target. Display data for selected active target (in the data box at the bottom of the screen).

CANCEL/HL OFF: Remove data of cursor-selected AIS target from the data box. Sleep cursor-selected target (when its data is not displayed in the data box).

MENU: Access the [Target] and [AIS] menus for AIS operations.

Cursorpad: Select a target to activate (or sleep). Select a target to show (or remove) target data.

4.2 AIS Display On/Off

You can turn the AIS display on or off. The system continues processing AIS targets regardless of on/off for AIS display when the AIS transponder is turned on.

1. Press the **MENU** key to open the menu.
2. Use the Cursorpad (**▲** or **▼**) to select [AIS] and press the **ENTER** key.

Menu	AIS
Custom 1	Display : Off
Custom 2	Color : Green
Custom 3	Number of Targets : 30
Alarm	Sort By : Range
Target Trails	Range : 24.0NM
Tuning	Sector Start : 340°
Others	Sector End : 20°
Target	Ignore Slow Targets : 5.0kn
ARPA	ACK Lost Targets
AIS	[ENTER]: Enter [CANCEL/HL OFF]: Back
GPS	[MENU]: Exit

Turning on/off AIS display

AIS menu

4. AIS OPERATION

- Use the Cursorpad (▲ or ▼) to select [Display] and press the **ENTER** key.



AIS-Display options

- Use the Cursorpad (▲ or ▼) to select [Off] or [On] then press the **ENTER** key.
- Press the **MENU** key to close the menu.

4.3 AIS Symbols

When the AIS is turned on, AIS targets are displayed with AIS symbol as below.



AIS symbols

Note: The AIS symbols are momentarily erased after the screen is redrawn when the heading is changed on the head-up mode.

4.4 Activating, Sleeping Targets

When you change a sleeping target to an activated target, a vector shows the course and speed of that target. You can easily judge the target movement by the vector.

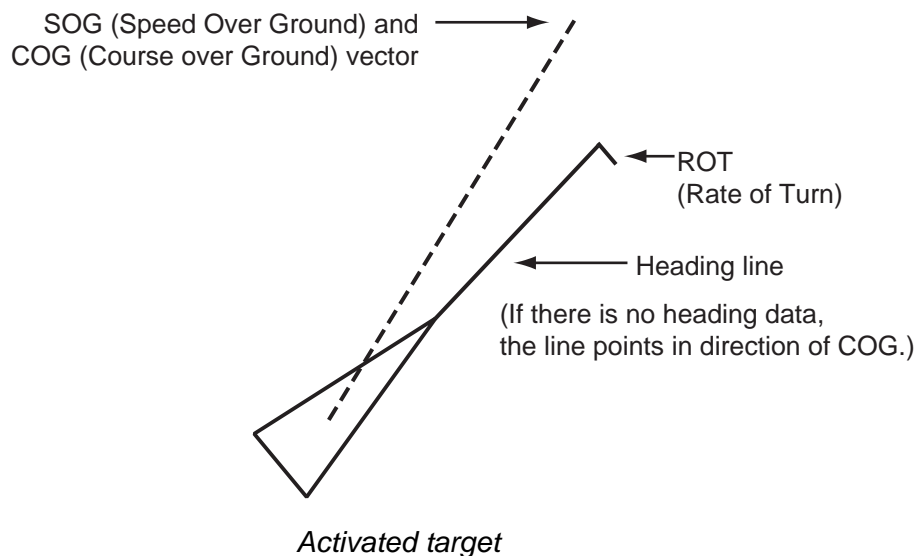

When there are many activated targets on the screen, you can not easily distinguish the activated targets from the radar images or ARPA targets. You can sleep an activated target for easy view of radar images.

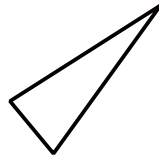

Sleeping target

To activate a target: Put the cursor on the target and press the **ENTER** key.

To sleep a target: Put the cursor on the target and press the **CANCEL HL/OFF** key.

4.5 AIS Target Data

You can show the AIS target data in the data box at the bottom of the screen. To display AIS target data, the menu item [Display] on the [AIS] menu must be set for [On] and the menu item [Data Box] on the [Display] menu must be set for [Target] or [All].

1. Use the Cursorpad to put the cursor on an activated target.
2. Press the **ENTER** key to show the data of the target.

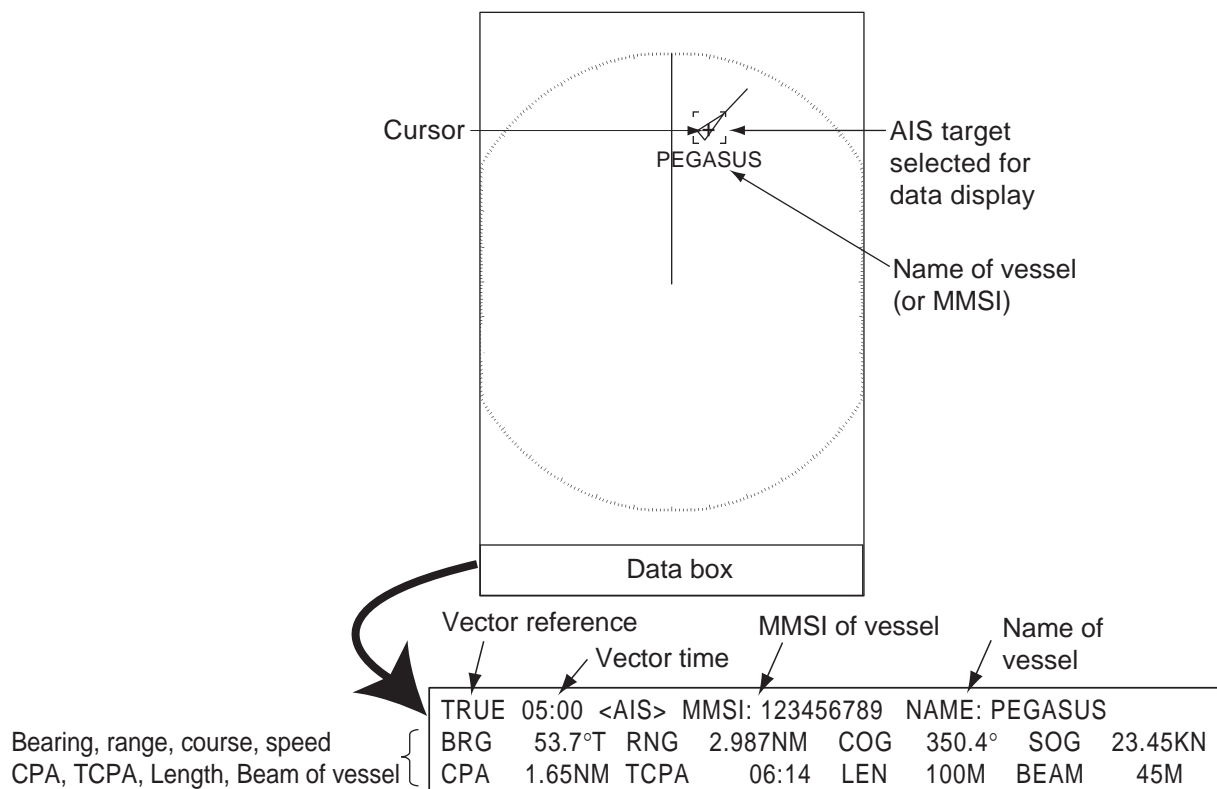

AIS target data

To remove the target data from a data box, put the cursor on its target symbol and press the **CANCEL/HL OFF** key.

4.6 How to Sort Targets

You can sort the AIS targets received from the AIS transponder by range from your ship, by sector, by CPA or TCPA.

1. Press the **MENU** key to open the menu.
2. Use the Cursorpad (▲ or ▼) to select [AIS] and press the **ENTER** key.
3. Use the Cursorpad (▲ or ▼) to select [Sort By] and press the **ENTER** key.

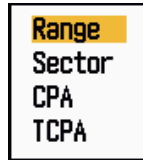

Sort By options

4. Use the Cursorpad (▲ or ▼) to select sorting method and press the **ENTER** key.
 - [Range]:** Sort targets within the display range set (see section 4.7), from nearest to furthest.
 - [Sector]:** Sort targets within the display sector set (see section 4.8) and within 24 nm, from nearest to furthest.
 - [CPA]:** Sort targets within 24 nm by CPA, from closest to furthest.
 - [TCPA]:** Sort targets within 24 nm by TCPA, from earliest time to latest time.
5. Press the **MENU** key to close the menu.

4.7 Display Range

You can set the AIS system to show only those AIS targets within the range you set. The setting range is 0.1-36 nm for MODEL 1835, 0.1-48 nm for MODEL 1935, 0.1-64 nm for MODEL 1945. Actual range depends on the AIS Transponder. If the target sorting method is selected to [Range], the target data within the range set here is transmitted to this radar.

1. Press the **MENU** key to open the menu.
2. Use the Cursorpad (▲ or ▼) to select [AIS] and press the **ENTER** key.
3. Use the Cursorpad (▲ or ▼) to select [Range] and press the **ENTER** key.

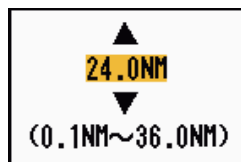

AIS-Range setting window (for MODEL 1835)

4. Use the Cursorpad (▲ or ▼) to set the display range and press the **ENTER** key.
5. Press the **MENU** key to close the menu.

Note: The unit of measurement for range is NM.

4.8 How to Display the Targets within a Specific Sector

You can display AIS targets only within a specific sector. If the target sorting method is selected to [Sector], the target data within the sector set here is transmitted to this radar.

1. Press the **MENU** key to open the menu.
2. Use the Cursorpad (▲ or ▼) to select [AIS] and press the **ENTER** key.
3. Use the Cursorpad (▲ or ▼) to select [Sector Start] and press the **ENTER** key.

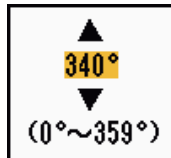

Sector Start setting window

4. Use the Cursorpad (▲ or ▼) to set the start point for the sector and press the **ENTER** key.
5. Use the Cursorpad (▲ or ▼) to select [Sector End] and press the **ENTER** key.

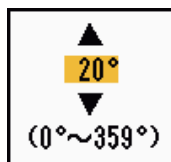

Sector End setting window

6. Use the Cursorpad (▲ or ▼) to set the end point for the sector and press the **ENTER** key.
7. Press the **MENU** key to close the menu.

4.9 Number of Targets to Display

You can select the maximum number of AIS targets to display. The setting value is 10 to 100. When the screen becomes cluttered with AIS targets, you can limit the number of AIS targets to show. Targets are selected and displayed according to sort method. (See section 4.6.)

1. Press the **MENU** key to open the menu.
2. Use the Cursorpad (▲ or ▼) to select [AIS] and press the **ENTER** key.
3. Use the Cursorpad (▲ or ▼) to select [Number of Targets] and press the **ENTER** key.

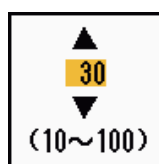

Number of Targets setting window

4. AIS OPERATION

4. Use the Cursorpad (▲ or ▼) to select the number of targets to display and press the **ENTER** key.
5. Press the **MENU** key to close the menu.

4.10 Vector Attributes

4.10.1 What is a vector?

A vector is a line extending from a tracked target. A vector shows speed and course of the target. The top of a vector shows estimated position of the target after the selected vector time elapses. If you extend the vector length (time), you can evaluate the risk of collision with any target.

4.10.2 Vector time and vector reference

1. Press the **MENU** key to open the menu.
2. Use the Cursorpad (▲ or ▼) to select [Target] and press the **ENTER** key.
3. Use the Cursorpad (▲ or ▼) to select [Vector Time] and press the **ENTER** key.



Vector Time setting window

4. Use the Cursorpad (▲ or ▼) to select time and press the **ENTER** key.
5. Use the Cursorpad (▲ or ▼) to select [Vector Reference] and press the **ENTER** key.

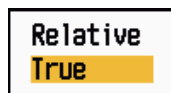

Vector Reference options

6. Use the Cursorpad (▲ or ▼) to select [Relative] or [True] then press the **ENTER** key. This function is not activate for [IEC] or [Russian-River] purpose. The mode is set to [True].
[Relative]: Other ships' vectors are displayed relative to your ship. This mode helps find targets on a collision course. If a ship is on a collision course with your ship, the vector of a ship points toward your ship position.
[True]: Your ship's and other ships' vectors are displayed at their true motions. This mode helps discriminate between moving and stationary targets.
7. Press the **MENU** key to close the menu.

4.11 History Display (target past position)

This radar can display time-spaced dots (maximum ten dots) that marks the past positions of any tracked AIS target. You can evaluate actions of a target by the spacing between dots. Below are examples of dot spacing and target movement.

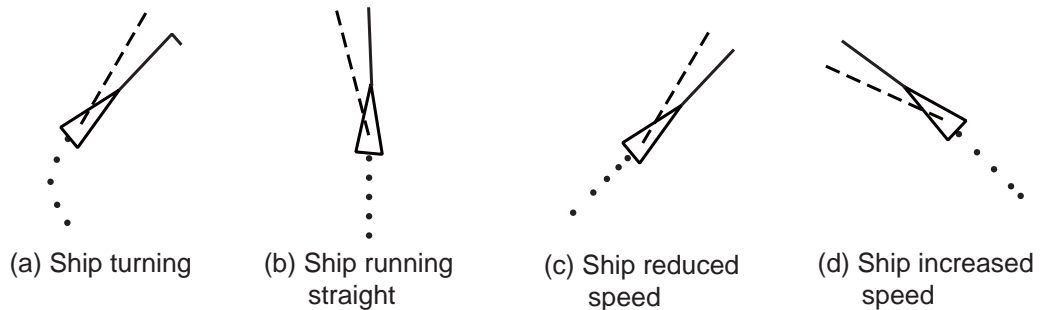

Target movement and history display

You can select the number of history dots to display and the time interval to display the history dots.

1. Press the **MENU** key to open the menu.
2. Use the Cursorpad (▲ or ▼) to select [Target] and press the **ENTER** key.
3. Use the Cursorpad (▲ or ▼) to select [History Dots] and press the **ENTER** key.

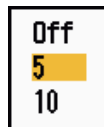

History Dots options

4. Use the Cursorpad (▲ or ▼) to select number of history dots to display (5 or 10) or select [Off] to turn off the history display.
5. Press the **ENTER** key.
6. Use the Cursorpad (▲ or ▼) to select [History Interval] and press the **ENTER** key.

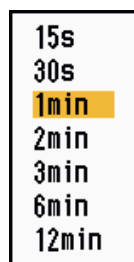

History Interval options

7. Use the Cursorpad (▲ or ▼) to select time interval and press the **ENTER** key.
8. Press the **MENU** key to close the menu.

4.12 CPA/TCPA Alarm

Set CPA (Closest Point of Approach) alarm range and TCPA (predicted Time to CPA) alarm time to alert you to targets that can be on a collision course. When CPA and TCPA of any AIS target (including a sleeping target) become less than the preset CPA and TCPA alarm settings, the audio alarm sounds. The alarm message "COLLISION" appears. The target symbol changes to a dangerous target symbol (red) and flashes with its vector. You can stop the audio alarm and flashing with any key. The dangerous target symbol is displayed until the AIS target is not in the CPA and TCPA alarm setting. The AIS continuously monitors CPA and TCPA of all AIS targets.

This feature helps identify targets that can be on a collision course.

1. Press the **MENU** key to open the menu.
2. Use the Cursorpad (▲ or ▼) to select [Target] and press the **ENTER** key.
3. Use the Cursorpad (▲ or ▼) to select [CPA] and press the **ENTER** key.

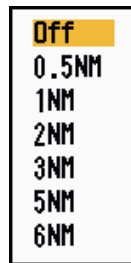

CPA options

4. Use the Cursorpad (▲ or ▼) to select CPA distance and press the **ENTER** key.
5. Use the Cursorpad (▲ or ▼) to select [TCPA] and press the **ENTER** key.



TCPA options

6. Use the Cursorpad (▲ or ▼) to select TCPA and press the **ENTER** key.
7. Press the **MENU** key to close the menu.

4.13 Proximity Alarm

The proximity alarm alerts you when an AIS target is within the range you set. The audio alarm sounds and the alarm message "PROXIMITY" appears. The target symbol changes to a dangerous target symbol (red) and flashes with its vector. Press any key to stop the audio alarm and flashing. The dangerous target symbol is displayed until the target is not within the range set, the alarm range is changed to exclude the target, or the proximity alarm is deactivated.

1. Press the **MENU** key to open the menu.
2. Use the Cursorpad (▲ or ▼) to select [Target] and press the **ENTER** key.
3. Use the Cursorpad (▲ or ▼) to select [Proximity] and press the **ENTER** key.

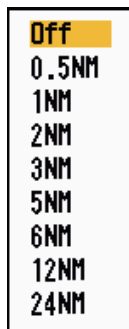

Proximity options

4. Use the Cursorpad (▲ or ▼) to select the range and press the **ENTER** key.
5. Press the **MENU** key to close the menu.

4.14 Lost Target

When AIS data is not received from a target at fixed interval (3-5* report intervals), the target symbol changes to the lost target symbol (flashing). No audio or visual alarm is given for a lost target.



Lost target symbol

* The interval at which AIS data is sent depends on speed of the AIS transponder. For detailed information, refer to the Operator's Manual for the AIS transponder.

You can remove all lost AIS targets from the display as follows:

1. Press the **MENU** key to open the menu.
2. Use the Cursorpad (▲ or ▼) to select [AIS] and press the **ENTER** key.
3. Use the Cursorpad (▲ or ▼) to select [ACK Lost Targets] and press the **ENTER** key.

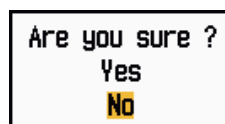

ACK Lost Targets options

4. AIS OPERATION

4. Use the Cursorpad (▲) to select [Yes] and press the **ENTER** key. All lost targets symbols are erased from the screen and the long beep sounds.
5. Press the **MENU** key to close the menu.

4.15 Symbol Color

You can select the AIS symbol color among Green, Red (unavailable in the [IEC] or [Russian-River] purpose), Blue, White or Black.

1. Press the **MENU** key to open the menu.
2. Use the Cursorpad (▲ or ▼) to select [AIS] and press the **ENTER** key.
3. Use the Cursorpad (▲ or ▼) to select [Color] and press the **ENTER** key.



Color options

4. Use the Cursorpad (▲ or ▼) to select the color and press the **ENTER** key.
5. Press the **MENU** key to close the menu.

Note: Symbols can not be shown in the same color as the background color.

4.16 How to Ignore Slow Targets

You can prevent activation of the CPA/TCPA alarm against AIS targets that are traveling at a speed lower than set here. The AIS symbols are not affected by this setting.

1. Press the **MENU** key to open the menu.
2. Use the Cursorpad (▲ or ▼) to select [AIS] and press the **ENTER** key.
3. Use the Cursorpad (▲ or ▼) to select [Ignore Slow Targets] and press the **ENTER** key.

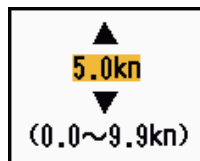

Ignore Slow Targets setting window

4. Use the Cursorpad (▲ or ▼) to select speed (0.0 - 9.9 kn) and press the **ENTER** key.
5. Press the **MENU** key to close the menu.