

FURUNO

OPERATOR'S MANUAL

MARINE RADAR

MODEL 1835

MODEL 1935

MODEL 1945

ECF

(Elemental Chlorine Free)

The paper used in this manual
is elemental chlorine free.

FURUNO ELECTRIC CO., LTD.

9-52 Ashihara-cho,
Nishinomiya, 662-8580, JAPAN

Telephone : +81-(0)798-65-2111

Fax : +81-(0)798-65-4200

• FURUNO Authorized Distributor/Dealer

All rights reserved. Printed in Japan

Pub. No. OME-35790-C

(YOTA) MODEL1835/1935/1945

A : FEB . 2009

C : JAN . 18, 2010



* 0 0 0 1 7 0 2 4 5 1 2 *

IMPORTANT NOTICES

General

- This manual has been authored with simplified grammar, to meet the needs of international users.
- The operator of this equipment must read and follow the descriptions in this manual. Wrong operation or maintenance can cancel the warranty or cause injury.
- Do not copy any part of this manual without written permission from FURUNO.
- If this manual is lost or worn, contact your dealer about replacement.
- The contents of this manual and equipment specifications can change without notice.
- The example screens (or illustrations) shown in this manual can be different from the screens you see on your display. The screens you see depend on your system configuration and equipment settings.
- Save this manual for future reference.
- Any modification of the equipment (including software) by persons not authorized by FURUNO will cancel the warranty.
- All brand and product names are trademarks, registered trademarks or service marks of their respective holders.

How to discard this product

Discard this product according to local regulations for the disposal of industrial waste. For disposal in the USA, see the homepage of the Electronics Industries Alliance (<http://www.eiae.org/>) for the correct method of disposal.

How to discard a used battery

Some FURUNO products have a battery(ies). To see if your product has a battery(ies), see the chapter on Maintenance. Follow the instructions below if a battery(ies) is used.

In the European Union

The crossed-out trash can symbol indicates that all types of batteries must not be discarded in standard trash, or at a trash site. Take the used batteries to a battery collection site according to your national legislation and the Batteries Directive 2006/66/EU.

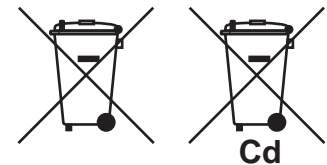

In the USA

The Mobius loop symbol (three chasing arrows) indicates that Ni-Cd and lead-acid rechargeable batteries must be recycled. Take the used batteries to a battery collection site according to local laws.

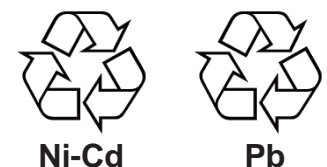

In the other countries

There are no international standards for the battery recycle symbol. The number of symbols can increase when the other countries make their own recycle symbols in the future.



SAFETY INSTRUCTIONS

Read these safety instructions before you operate the equipment.



WARNING

Indicates a condition that can cause death or serious injury if not avoided.



CAUTION

Indicates a condition that can cause minor or moderate injury if not avoided.



Warning, Caution



Prohibitive Action



Mandatory Action



WARNING







Radio Frequency Radiation Hazard





The radar antenna sends the electromagnetic radio frequency (RF) energy. This energy can be dangerous to you, especially your eyes. Do not look at the radiator or near the antenna when the antenna is rotating.

The distances at which RF radiation levels of 100 W/m^2 , 50 W/m^2 and 10 W/m^2 exist are shown in the table.

Note: If the antenna unit is installed at a close distance in front of the wheel house, prevent the transmission in that area to protect passengers and crew from microwave radiation. Set the [Sector Blanks] in the [System] menu.

Model	Distance to 100 W/m^2 point	Distance to 50 W/m^2 point	Distance to 10 W/m^2 point
1835	—	Worst case 0.0 m	Worst case 1.0 m
1935	—	Worst case 0.2 m	Worst case 1.2 m
1945	Worst case 0.1 m	Worst case 0.2 m	Worst case 1.7 m

 WARNING	
	<p>ELECTRICAL SHOCK HAZARD Do not open the equipment.</p> <p>Only qualified persons can work inside the equipment.</p>
	<p>Turn off the power before you service the antenna unit. Post a warning sign near the power switch not to turn on the power while you service the antenna unit.</p> <p>Prevent the potential risk of being struck by the rotating antenna and exposure to RF radiation hazard.</p>
	<p>When you work on the antenna unit, wear a safety belt and hard hat.</p> <p>Serious injury or death can result if a person falls from the radar antenna mast.</p>
	<p>Do not disassemble or modify the equipment.</p> <p>Fire or electrical shock can occur.</p>
	<p>Turn off the power immediately if water leaks into the equipment or smoke or fire is coming from the equipment.</p> <p>Failure to turn off the equipment can cause fire or electrical shock.</p>

 WARNING	
	<p>Use the correct fuse.</p> <p>A wrong fuse can damage the equipment and cause fire.</p>
	<p>Keep heater away from the equipment.</p> <p>Heat can change the equipment shape and melt the power cord, which can cause fire or electrical shock.</p>
	<p>Do not put liquid-filled containers on the top of the equipment.</p> <p>Fire or electrical shock can occur if a liquid spills into the equipment.</p>
	<p>Do not operate the equipment with wet hands.</p> <p>Electrical shock can occur.</p>



WARNING



Do not depend on one navigation device for the navigation of the ship. The navigator must check all aids available to confirm position. Electronic aids are not a replacement for basic navigation principles and common sense.

The ARPA automatically tracks an automatically or manually acquired radar target and calculates its course and speed, indicating them by a vector. Since the data from the auto plotter depend on the selected radar targets, the radar must be optimally tuned for use with the auto plotter, to ensure required targets will not be lost or unnecessary targets like sea returns and noise will not be acquired and tracked. A target is not always a landmass, reef, ship, but can also be returns from the sea surface and from clutter. As the level of clutter changes with the environment, the operator must correctly adjust the **A/C SEA**, **A/C RAIN** and **GAIN** controls so that the target echoes do not disappear from the radar screen.



CAUTION

The plotting accuracy and response of this ARPA meets IMO standards. The tracking accuracy is affected by the following:

The tracking accuracy is affected by course change. One to two minutes is required to restore vectors to full accuracy after a sudden course change. (The actual amount depends on gyrocompass specifications.) The amount of tracking delay is inversely proportional to the relative speed of the target. Delay is on the order of 15-30 seconds for high relative speed; 30-60 seconds for low relative speed.

The data from ARPA and AIS are intended for reference purposes only.

Check all available navigation aids to determine target movement.

WARNING LABELS

Warning labels are attached to the equipment. Do not remove any label. If a label is missing or damaged, contact a FURUNO agent or dealer about replacement.

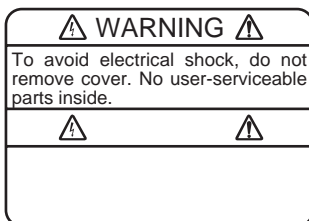

DISPLAY UNIT

Name: Warning Label 1
Type: 86-003-1011-3
Code No.: 100-236-233-10

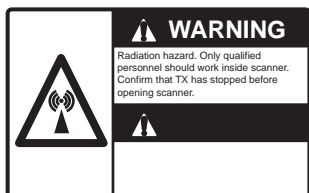

ANTENNA UNIT

Name: Warning Sticker
Type: 03-142-3201-0
Code No.: 100-266-890-10

TFT LCD

The high quality TFT (Thin Film Transistor) LCD displays 99.999% of its picture elements. The remaining 0.001% may drop out or light, however this is an inherent property of the LCD; it is not a sign of malfunction.

TABLE OF CONTENTS

FOREWORD.....	ix
SYSTEM CONFIGURATION	xii
1. DESCRIPTION OF OPERATION	1-1
1.1 Controls	1-1
1.2 How to Turn the Radar On/Off and Transmit.....	1-2
1.3 Display Indications.....	1-3
1.4 How to Adjust Display Brilliance, Panel Dimmer	1-4
1.5 Menu Description.....	1-4
1.6 Tuning.....	1-6
1.7 Display Modes	1-7
1.7.1 How to select the display mode.....	1-7
1.7.2 Description of display modes	1-8
1.8 How to Select a Range Scale.....	1-9
1.9 How to Adjust the Gain (sensitivity).....	1-10
1.10 How to Reduce the Sea Clutter	1-11
1.11 How to Reduce the Rain Clutter	1-12
1.12 Automatic Adjustments of Sea and Rain Clutters	1-13
1.13 Cursor.....	1-14
1.14 Interference Rejector	1-15
1.15 How to Measure the Range to a Target	1-16
1.15.1 How to adjust range ring brilliance	1-16
1.15.2 How to measure the range with a VRM.....	1-17
1.15.3 How to select VRM unit	1-17
1.16 How to Measure the Bearing to a Target.....	1-18
1.16.1 How to measure the bearing with an EBL	1-18
1.16.2 EBL reference	1-19
1.17 How to Measure the Range and Bearing Between Two Targets	1-19
1.18 How to Select a Pulselength.....	1-20
1.19 Target Alarm.....	1-21
1.19.1 How to set a target alarm zone	1-22
1.19.2 How to stop the audio alarm.....	1-22
1.19.3 How to select the alarm type	1-23
1.19.4 How to sleep a target alarm temporarily.....	1-23
1.19.5 How to deactivate a target alarm.....	1-24
1.19.6 How to select the target strength which triggers a target alarm	1-24
1.19.7 How to turn the buzzer on/off	1-24
1.20 How to Off-center the Display.....	1-25
1.20.1 How to select the off-center mode.....	1-25
1.20.2 Off-center the display	1-25
1.21 Zoom	1-27
1.21.1 Zoom mode	1-27
1.21.2 How to zoom	1-27
1.22 Echo Stretch	1-29
1.23 Echo Average	1-29
1.24 Target Trails	1-30
1.24.1 Trail time.....	1-30
1.24.2 How to start, stop the trails	1-31
1.24.3 Trail mode	1-31
1.24.4 Trail gradation	1-32
1.24.5 Trail color.....	1-32
1.24.6 Trail level	1-33

TABLE OF CONTENTS

1.24.7	How to restart, stop the trails	1-33
1.24.8	Narrow trails	1-34
1.24.9	Your ship trail	1-34
1.25	How to Send the Target Position and Enter the Origin Mark	1-34
1.26	How to Hide the Heading Line Temporarily	1-35
1.27	Presentation Brilliance	1-35
1.28	Custom Setup	1-36
1.28.1	About custom setup	1-36
1.28.2	Description of custom setup items	1-36
1.28.3	How to set custom setups	1-37
1.29	How to Program Function Keys (F1, F2 and F3 keys)	1-38
1.30	Noise Rejector	1-39
1.31	Wiper	1-39
1.32	How to Reduce Second-trace Echoes	1-40
1.33	Watchman	1-40
1.34	Color Selections	1-41
1.34.1	Preset colors	1-41
1.34.2	Custom colors	1-42
1.35	Navigation Data	1-43
1.35.1	Navigation data during standby	1-43
1.35.2	Navigation data at the bottom of the screen	1-43
1.36	Dynamic Range	1-44
1.37	Characteristics Curve	1-45
1.38	Waypoint Marker	1-46
1.39	Alarm Message	1-46
1.40	Echo Area	1-48
1.41	Initial Sub Menu	1-49
1.41.1	How to open the Initial sub menu	1-49
1.41.2	Description of Initial sub menu	1-49
1.42	Units Sub Menu	1-51
1.43	Sector Blank	1-52
1.44	Other Menu Items	1-53
1.44.1	Menu items on the [Brill/Color] menu	1-53
1.44.2	Menu items on the [Display] menu	1-55
1.44.3	Menu items on the [Echo] menu	1-56
1.45	Remote Display	1-56
2.	DESCRIPTION OF RADAR	2-1
2.1	General	2-1
2.1.1	Minimum and maximum ranges	2-1
2.1.2	Radar resolution	2-2
2.1.3	Bearing accuracy	2-3
2.1.4	Range measurement	2-3
2.2	False Echoes	2-3
2.2.1	Multiple echoes	2-3
2.2.2	Sidelobe echoes	2-4
2.2.3	Virtual image	2-4
2.2.4	Shadow sector	2-5
2.3	SART (Search and Rescue Transponder)	2-6
2.3.1	SART description	2-6
2.3.2	General remarks on receiving SART	2-7
2.4	RACON	2-8

3. ARPA OPERATION	3-1
3.1 Precautions for Use	3-1
3.2 Controls for Use with ARPA	3-1
3.3 ARPA Display On/Off	3-2
3.4 How to Acquire and Track the Targets	3-2
3.4.1 Manual acquisition.....	3-2
3.4.2 Automatic acquisition	3-3
3.5 How to Stop the Tracking of ARPA Target	3-3
3.5.1 How to stop the tracking of selected targets	3-3
3.5.2 How to stop the tracking of all targets	3-3
3.6 Vector Attributes	3-4
3.6.1 What is a vector?.....	3-4
3.6.2 Vector time and vector reference	3-4
3.6.3 Vector of your ship	3-5
3.7 History Display (target past position).....	3-6
3.8 ARPA Target Data.....	3-7
3.9 CPA/TCPA Alarm	3-8
3.10 Proximity Alarm	3-9
3.11 Lost Target	3-10
3.12 Symbol Color.....	3-10
4. AIS OPERATION	4-1
4.1 Controls for Use with AIS	4-1
4.2 AIS Display On/Off	4-1
4.3 AIS Symbols	4-2
4.4 Activating, Sleeping Targets.....	4-2
4.5 AIS Target Data.....	4-3
4.6 How to Sort Targets.....	4-4
4.7 Display Range	4-4
4.8 How to Display the Targets within a Specific Sector	4-5
4.9 Number of Targets to Display.....	4-5
4.10 Vector Attributes	4-6
4.10.1 What is a vector?.....	4-6
4.10.2 Vector time and vector reference	4-6
4.11 History Display (target past position).....	4-7
4.12 CPA/TCPA Alarm	4-8
4.13 Proximity Alarm	4-9
4.14 Lost Target	4-9
4.15 Symbol Color.....	4-10
4.16 How to Ignore Slow Targets	4-10
5. GPS OPERATION	5-1
5.1 Navigator Mode	5-1
5.2 Datum.....	5-1
5.3 WAAS Setup.....	5-2
5.4 Satellite Monitor	5-3
5.5 Cold Start.....	5-4
6. MAINTENANCE, TROUBLESHOOTING	6-1
6.1 Preventive Maintenance	6-2
6.2 Fuse Replacement	6-3
6.3 Magnetron Life.....	6-3
6.4 LCD Backlight Life	6-3
6.5 Simple Troubleshooting.....	6-4
6.6 Advanced-level Troubleshooting	6-5
6.7 Diagnostic Test.....	6-7

TABLE OF CONTENTS

6.8 LCD Test..... 6-9
6.9 ARPA Test 6-10
6.10 GPS Test..... 6-11

APPENDIX 1 MENU TREEAP-1
APPENDIX 2 GEODETIC CHART LISTAP-5
SPECIFICATIONSSP-1
INDEX.....IN-1
Declaration of Conformity

FOREWORD

A Word to the Owner of the MODEL 1835/1935/1945 Marine Radar

Congratulations on your choice of the FURUNO MODEL 1835/1935/1945 Marine Radar. We are confident you will see why the FURUNO name has become synonymous with quality and reliability.

For over 60 years FURUNO Electric Company has enjoyed an enviable reputation for innovative and dependable marine electronics equipment. This dedication to excellence is furthered by our extensive global network of agents and dealers.

Your equipment is designed and constructed to meet the rigorous demands of the marine environment. However, no machine can perform its intended function unless properly installed and maintained. Please carefully read and follow the operation and maintenance procedures set forth in this manual.

We would appreciate feedback from you, the end-user, about whether we are achieving our purposes.

Thank you for considering and purchasing FURUNO equipment.

Features

The MODEL 1835/1935/1945 (the MODEL 1835 series herein after) display ships, lands, etc. on a 10.4-inch color LCD. You can operate this equipment with the keys, knob controls and Cursor-pad.

The main features are as shown below.

- The MODEL 1835 series has the following models:

Model	Output power	Max range	Size and type for radar antenna	Antenna rotation
MODEL 1835	4 kW	36 nm	60 cm, Radome	24 RPM
MODEL 1935	4 kW	48 nm	100 cm, Open	24/48 RPM
MODEL 1945	6 kW	64 nm	120 cm, Open	

- Bright 10.4-inch LCD is visible in direct sunlight.
- An easy to understand user interface with on-screen menu
- “Fog-Free” color LCD provides clear view in any weather conditions.
- Echo area display with full screen provides observation of a wider range around the vessel.
- Optional Auto Plotter ARP-11 is available for ARPA operation.
- User programmable function keys
- AIS data can be displayed with connection of FURUNO AIS Transponder/Receiver.
- Echoes in yellow, green, orange or multiple colors

Radar Type and Function Availability

This radar series is available in four types: [River], [Sea], [IEC] and [Russian-River], and function availability depends on type. The table below shows type and function availability.

[River]: For river, [Sea]: For sea, [IEC]: IEC compliant radar, [Russian-River]: For Russian river

Type and function availability

Item	Type			
	River	Sea	IEC	Russian-River
Automatic menu closure	Menu does not close automatically.		Menu closes automatically when there is no menu operation for 10 seconds.	
Effective radius dot count	240 dots		210 dots	
Echo color	Select the echo display color among [Yellow], [Green], [Orange] or [Multi].		Select the echo display color among [Yellow], [Green] or [Orange].	
Echo color customizing	Can customize the echo display color.		Can not customize the echo display color.	
Echo area	Select the display area from [Normal] or [Full Screen].		Can not select. Display area is circle only.	
Base text display	Can show or hide the base text indications.		Can not hide the base text indications.	
Range preset	Select the radar ranges to use.			Can not select the radar ranges to use.
Unit defaults 1) range 2) speed	1) KM 2) km/h, m/s	1) NM 2) kn	1) KM 2) km/h, m/s	
Bearing scale	Graduation every 1°, 5°, 10°, 30°, no numeric indication, displayed in the effective radius		Graduation every 1°, 5°, 10°, 30°, numeric indication every 30°, displayed out of the effective radius	
VRM unit	Can set the VRM unit independently from the range unit.		Can not set the VRM unit independently from the range unit.	
Range unit	Can change the range unit when transmitting.		Can not change the range unit in transmit. Only in standby.	
AIS symbol color	Select the AIS symbol color from [Green], [Red], [Blue], [White] or [Black].		Select the AIS symbol color from [Green], [Blue], [White] or [Black].	
Vector reference	Select the display mode for the vector from [Relative] or [True].		[True]	

Item	Type			
	River	Sea	IEC	Russian-River
Pulselength	<ul style="list-style-type: none"> • 2NM/4KM/2SM: MP • 4NM/8KM/4SM: LP 			<ul style="list-style-type: none"> • 2NM/4KM/2SM: SP or MP • 4NM/8KM/4SM: MP or LP
The rule for the numbering of ARPA targets	Non-IEC system		IEC system	
Marks temporary hidden by pressing and holding the CANCEL/HL OFF key	Heading line, all marks (EBL, VRM, target alarm zone, etc.)		Heading line, vector of your ship (with ARP-11), north marker	

Note on Chinese font: The Chinese font used in this equipment is Ricoh Company Ltd.'s Ricoh bitmap font.

中文字型由北京字研技术开发中心提供

SYSTEM CONFIGURATION

Basic configuration is shown below with solid line.

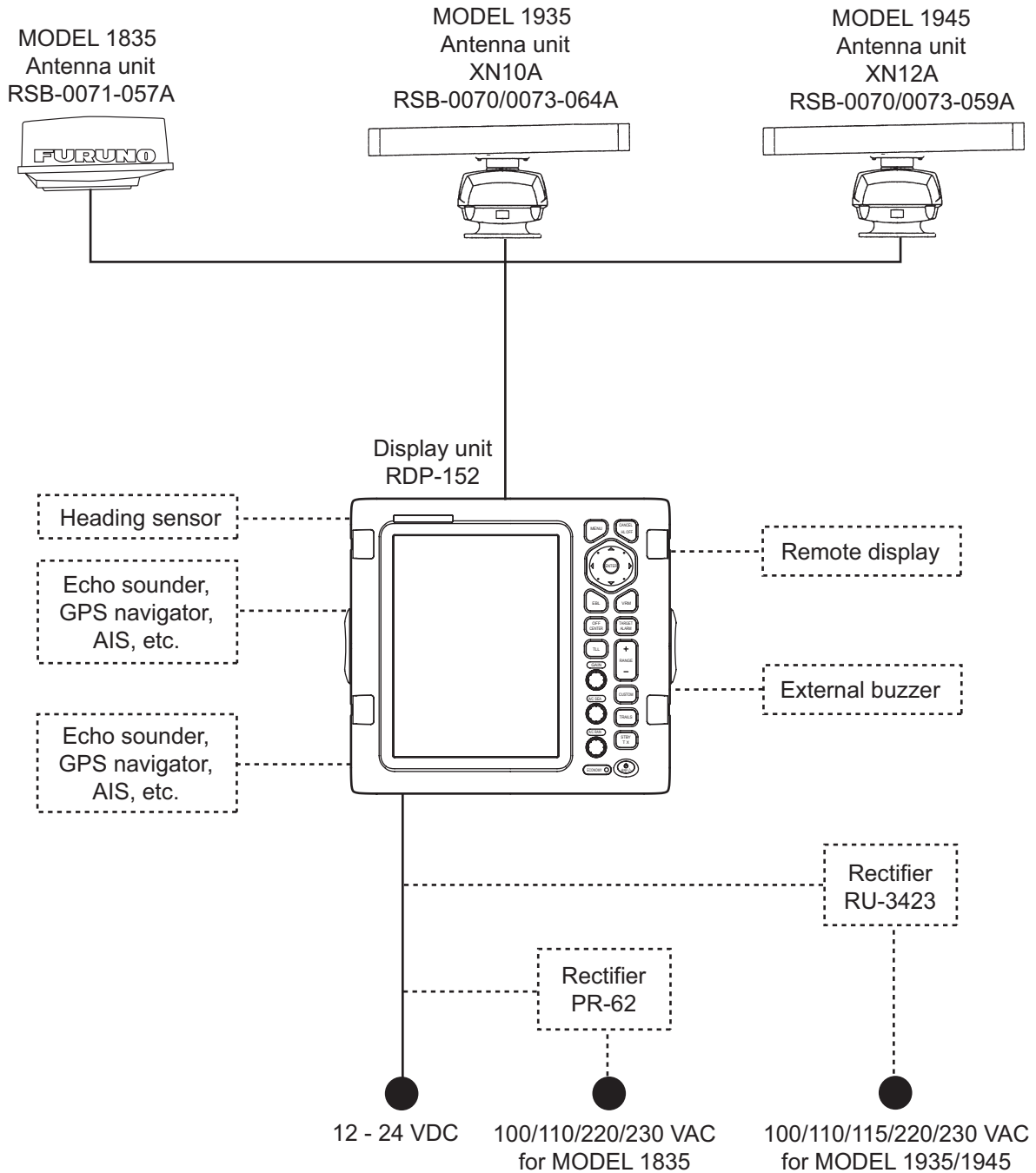

1. DESCRIPTION OF OPERATION

1.1 Controls

Display unit

The display unit has 16 keys which have labels with their functions, three knob controls and a Cursorpad. When you correctly operate this equipment, the unit beeps one time. If your operation is wrong, the unit beeps three times.

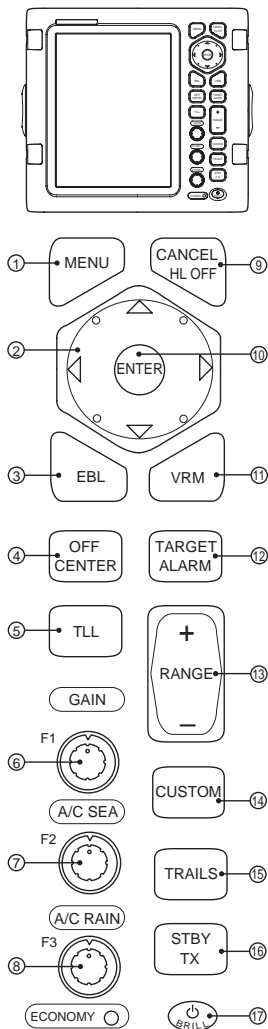

No.	Control	Description
1	MENU	Open/close the menu.
2	Cursorpad	Select the menu items and options. Move the cursor.
3	EBL	Measure the bearing to a target.
4	OFF CENTER	Off-center the display.
5	TLL	Send the latitude and longitude position of a target to a navigation plotter. Enter an origin mark at the cursor position on the radar display.
6	GAIN	Rotating: Adjust the sensitivity of the radar receiver.
7	A/C SEA	Rotating: Reduce the sea clutter.
8	A/C RAIN	Rotating: Reduce the rain clutter.
6, 7, 8	F1, F2, F3	Push: Activate the function given to the key.
9	CANCEL/ HL OFF	Erase the heading line while you press this key. Cancel last entry in menu operation. Cancel the tracking of ARPA target. Remove data of selected ARPA or AIS target from the data box. Return one layer in multiple level menu.
10	ENTER	Save selected menu option. Acquire ARPA target. Select ARPA or AIS target to display its data.
11	VRM	Measure the range to a target.
12	TARGET ALARM	Set the target alarm, which checks for targets in the operator-set area.
13	RANGE	Select the detection range.
14	CUSTOM	Preset the radar controls for one-touch operation of radar.
15	TRAILS	Plot the radar echo movement.
16	STBY/TX	Transmit the radar pulses and put the radar in standby alternately.
17	Power/BRILL	Short press: Turn on the power. Adjust the brilliance. Long press: Turn off the power.

1.2 How to Turn the Radar On/Off and Transmit

Press the  key to turn on the radar. To turn off the radar, press and hold down the key until the screen turns off.

When you turn on the power, the initialization screen appears followed by the start-up screen. The start-up screen shows the model name, program number and the results of the ROM and RAM check, OK or NG (No Good). If NG appears, contact your dealer for instruction.

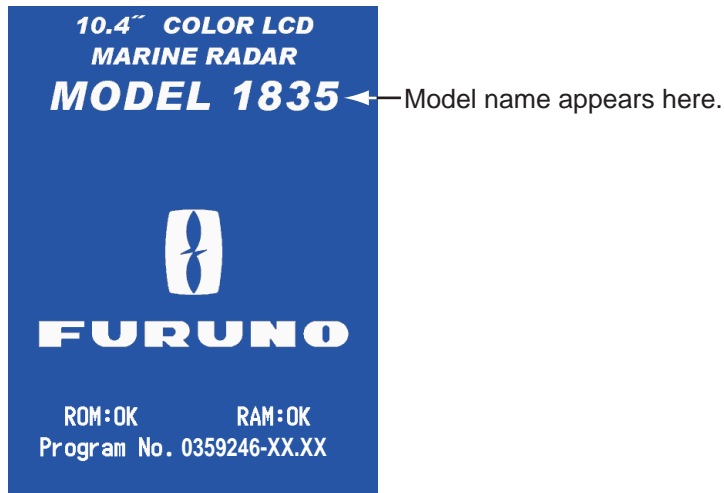

XX: Program version no.



Start-up screen

After the self-tests are completed, the bearing scale and a digital timer appear. The digital timer counts down time necessary to warm the magnetron, which transmits the radar pulses. The time to warm the magnetron takes 90 sec.

After the timer reads 0:00, the STBY screen appears. The STBY screen has three types. (See section 1.44.2.) The radar is ready to transmit the radar pulses. Press the **STBY/TX** key to transmit the radar pulses.

The **STBY/TX** key switches between standby and transmit. The antenna rotates in transmit and is stopped in standby. The magnetron gets old with use. To increase the life of the magnetron, set the radar in standby when you do not use the radar.

Quick start

If the magnetron is still warm, you can get the radar to TRANSMIT without the warm-up time. When the  key is turned off by accident, turn on the  key within 10 seconds after you turn off the power.

1.3 Display Indications

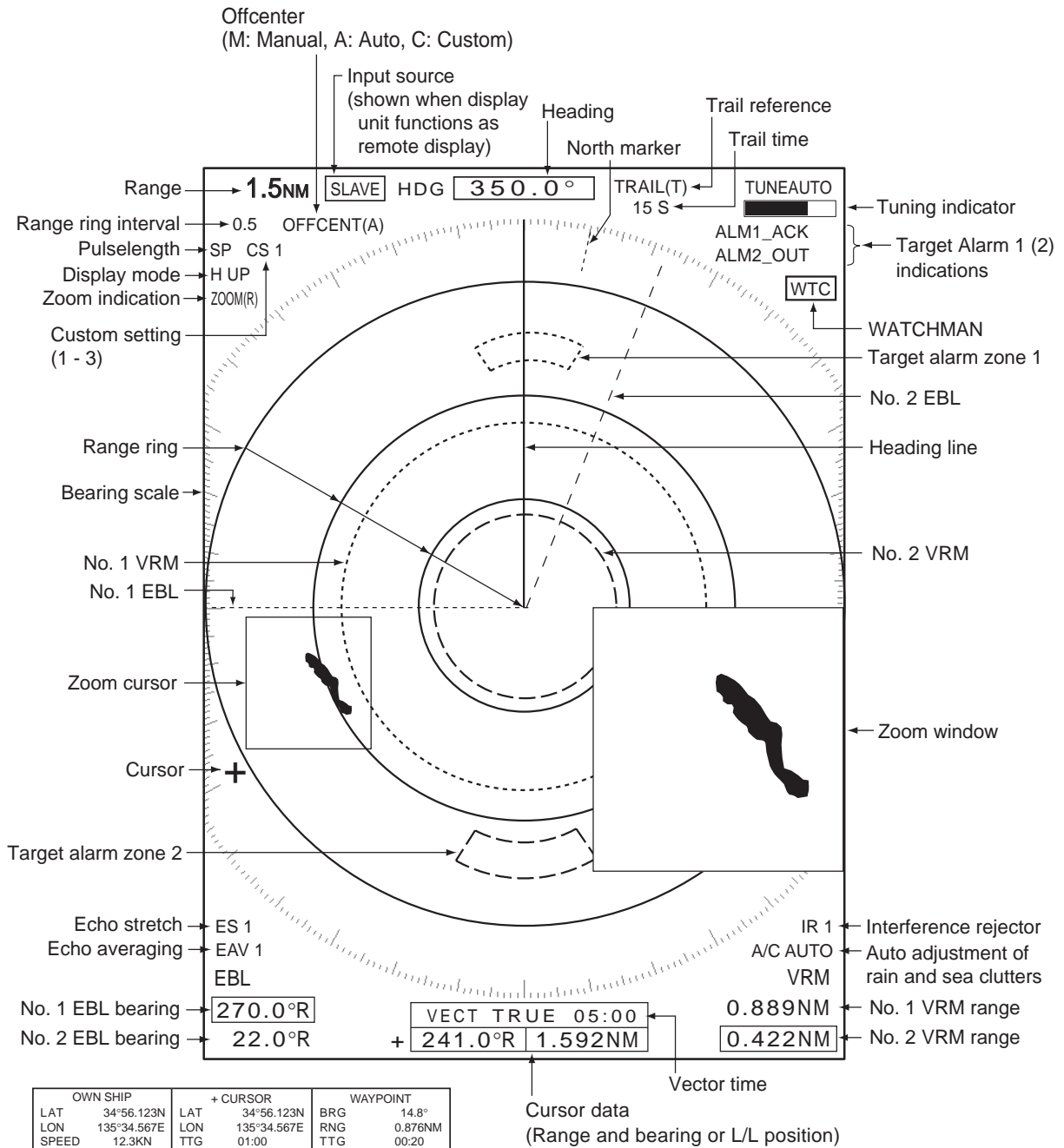

Nav data: Appears at screen bottom when [Data Box] in the [Display] menu is set to [Nav] or [All]. Appropriate sensors required to display nav data.

Display indications

1.4 How to Adjust Display Brilliance, Panel Dimmer

You can adjust the display brilliance and panel dimmer as follows:

1. Press the  key momentarily to show the [Brill/Panel] dialog box.

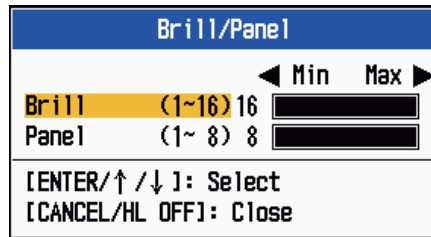

Brill/Panel dialog box

2. Press the **ENTER** key (or ▲, ▼) to select [Brill] or [Panel].
3. Use the Cursorpad (◀ or ▶) to adjust. (For brilliance, you can also use the  key.)
4. Press the **CANCEL/HL OFF** key to close the window.

1.5 Menu Description

This MODEL 1835 series has 15 menus and 6 sub menus. Below is the basic procedure for menu operation.

1. Press the **MENU** key to open the menu.

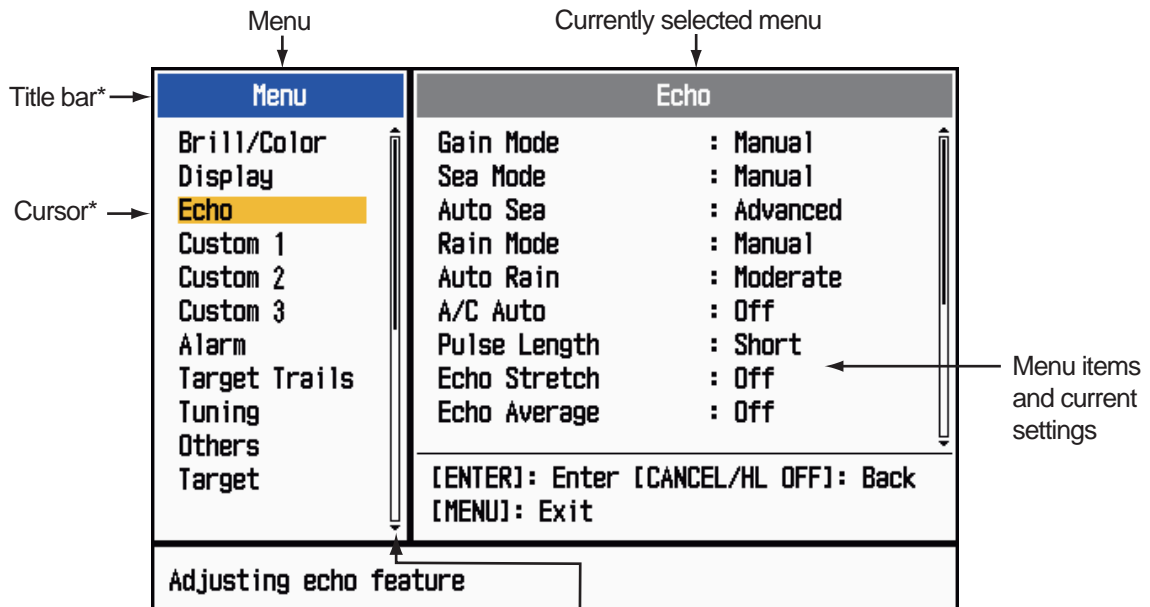

Guide message
(The simple explanation for
the current menu.)

Scroll bar (Indicates menus currently not shown in menu window. Black vertical line indicates location in menu. You can see the menus and sub menus currently not shown by using ▲ or ▼.)

*: Title bar in currently controllable column is blue; selected cursor is yellow.
Title bar of inactive column is gray.

Menu

- Use the Cursorpad (▲ or ▼) to select a menu or a sub menu. The cursor (yellow) in the Menu column indicates the menu currently selected. The menu items in the right window change according to the menu selected.

Menu description

[Brill/Color]: Adjust the brilliance and color.

[Display]: Set up the display-related features.

[Echo]: Adjust the echo feature.

[Custom 1] - [Custom 3]: Customize the user settings.

[Alarm]: Set up the alarm items.

[Target Trails]: Process trails of the radar targets.

[Tuning]: Adjust the radar tuning.

[Others]: Set up other items.

[Target]: Set up the targets configuration.

[ARPA]: Set up ARPA targets.

[AIS]: Set up AIS targets.

[GPS]: Set up GP-320B (Black-Box GPS).

[System]

[Initial]: Initial settings.

[Tests]: System diagnostic and LCD test.

[Sector Blanks]: Set up the sector blanks to prevent the transmission in a certain area.

[Units]: Set up units.

[Installation] and [Factory]: For use by the installer. See the Installation Manual.

- Press the **ENTER** key to switch the control to the menu items column. The cursor in the menu column now turns gray and the cursor in the menu items column is yellow. The control moves to the menu items column. To switch the control from the menu items column to the menu column, use the **CANCEL/HL OFF** key. The color of the title bar of the active column is blue and of the inactive column is gray.
- Use the Cursorpad (▲ or ▼) to select a menu item and press the **ENTER** key. A window with options for the related menu item appears.



Display Color options

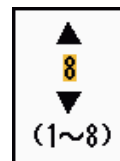

Echo Brill setting window

Example windows

- Use the Cursorpad (▲ or ▼) to select an option or numeric value.
- Press the **ENTER** key to save your selection. To close the window without saving, press the **CANCEL/HL OFF** key (instead of the **ENTER** key).
- Press the **MENU** key to close the menu.

Note: The menus on the [IEC] and [Russian-River] types close automatically when there is no menu operation for 10 seconds, according to IEC regulations. The following menus and screens are excluded from this regulation:

Alarm message, Alarm status, Tuning Init Adjust, GPS self test, GPS satellite monitor, System self test, System LCD pattern, and Auto installation setup.

The menus do not close automatically in the [River] or [Sea] configuration.

1.6 Tuning

In default, the radar receiver can be tuned automatically after turning the radar to TX. If you require fine tuning in manual, do the following:

1. Transmit the radar and select the maximum range with the **RANGE** key.
2. Press the **MENU** key to open the menu.
3. Use the Cursorpad (**▲** or **▼**) to select [Tuning] and press the **ENTER** key.

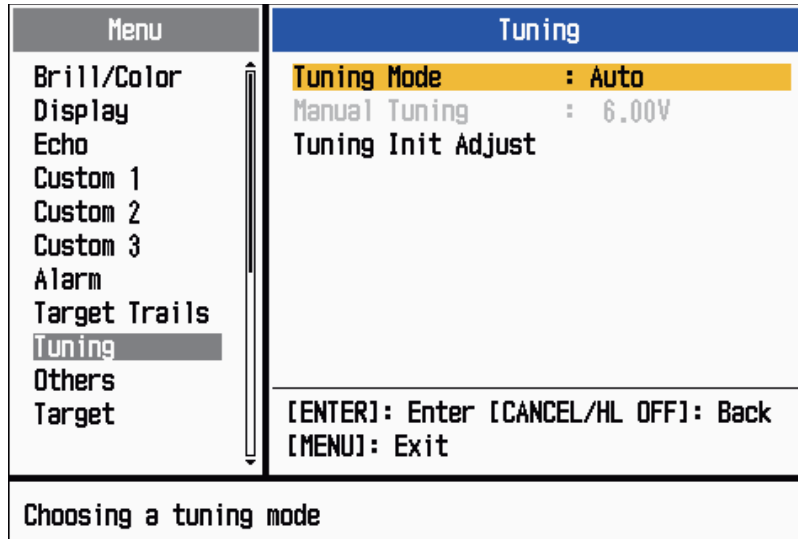

Tuning menu

4. Use the Cursorpad (**▲** or **▼**) to select [Tuning Mode] and press the **ENTER** key.



Tuning Mode options

5. Use the Cursorpad (**▲** or **▼**) to select [Manual] and press the **ENTER** key.
6. Use the Cursorpad (**▲** or **▼**) to select [Manual Tuning] and press the **ENTER** key. The window shown below appears.

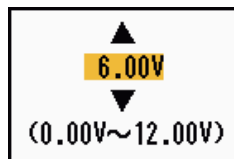

Manual Tuning setting window

7. Use the Cursorpad (**▲** or **▼**) to adjust the tuning while you look the tuning bar at the upper-right corner of the display. The best tuning point is where the tuning bar moves to maximum value. The vertical bar on the tuning bar shows the tuning voltage.

TUNE MAN ← Tuning method (Manual)

← Tuning bar

← Vertical bar
8. Press the **ENTER** key.
9. Press the **MENU** key to close the menu.

Note: If the automatic tuning does not give the correct tuning, run the [Tuning Init Adjust] again.

1.7 Display Modes

This radar has the display modes shown below. All modes except head-up require a heading signal. The true motion mode additionally requires position data.

Relative Motion (RM)

- [Head Up] (H UP)
- [Course Up] (C UP)
- [North Up] (N UP)
- [True View] (TRUE VIEW)

True Motion (TM)

- [True Motion] (TM)

1.7.1 How to select the display mode

1. Press the **MENU** key to open the menu.
2. Use the Cursorpad (▲ or ▼) to select [Display] and press the **ENTER** key.

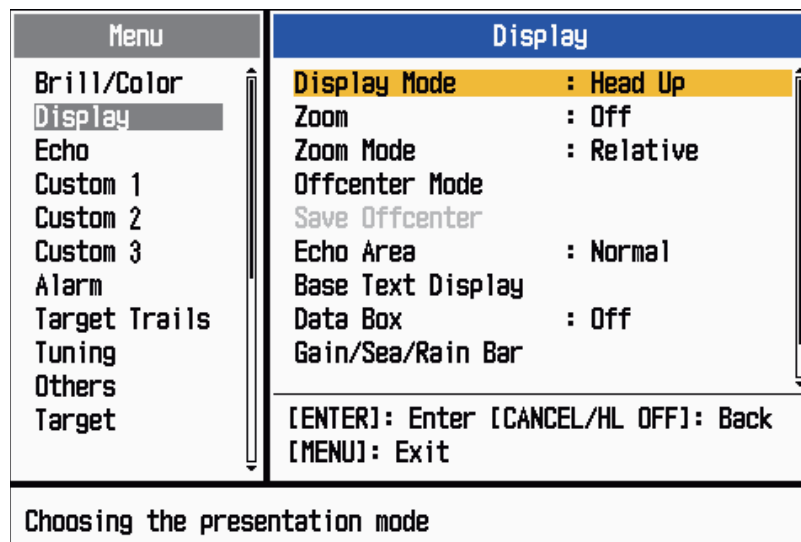

Display menu

3. Use the Cursorpad (▲ or ▼) to select [Display Mode] and press the **ENTER** key.

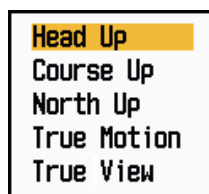

Display Mode options

4. Use the Cursorpad (▲ or ▼) to select a display mode and press the **ENTER** key.
5. Press the **MENU** key to close the menu.

Note: All modes except head-up require a heading signal in AD-10 format or NMEA format. If the heading signal is lost, the mode is changed to head-up and the north marker disappears. The display for heading is XXX.X and the alarm sounds. The message "GYRO" (AD-10 format data) or "NMEA_HDG" (NMEA format data) appears in

1. DESCRIPTION OF OPERATION

the alarm message display. To stop the audio alarm, press any key. When the heading signal is restored, check the heading. To check the heading, press the **F3** key. The numeric value is displayed at the heading indication when the heading signal is restored.

1.7.2 Description of display modes

Head-up mode

A display without azimuth stabilization in which the line that connects the center with the top of the display indicates your heading. Targets are shown at their measured distances and their directions relative to your heading. The short dotted line on the bearing scale is the north marker.

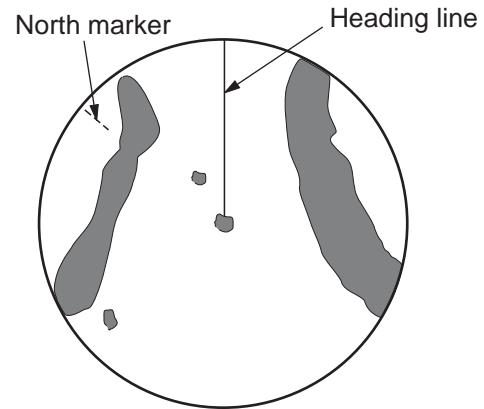

Course-up mode

The radar picture is stabilized and displayed with the currently selected course at the top of the screen. When you change the heading, the heading line moves with the course selected. If you select a new course, select the course-up mode again to display the new course at the top of the display.

Targets are shown at their measured distances and their directions relative to the set course, which is at the 0-degree position. The heading line moves according to the yawing and any course change.

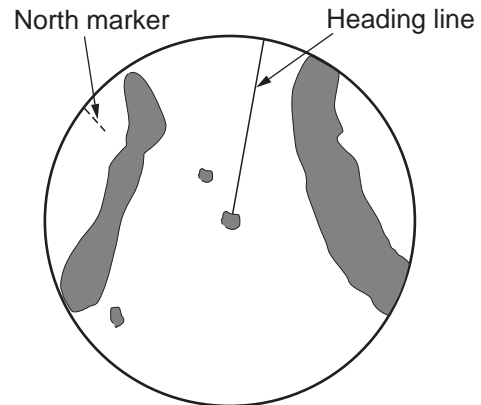

North-up mode

Targets are shown at their measured distances and their true (compass) directions from your ship. North is at the top of the screen. The heading line changes its direction according to your heading.

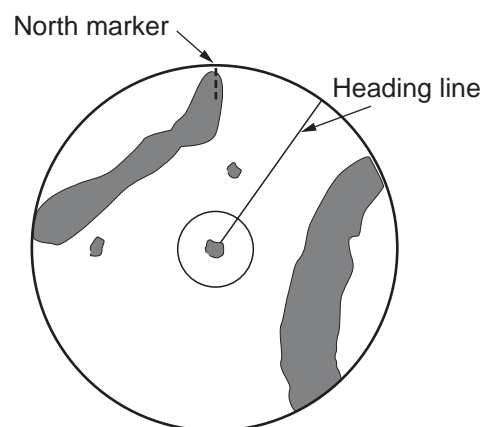

True motion mode

Your ship and other objects in motion move with their true courses and speed. All fixed targets, like landmasses, appear as fixed echoes in ground stabilized TM.

When your ship reaches a point that is 75% of the radius of the display, the position is reset. The ship appears at 75% radius opposite to the extension of the heading line on the display center. You can manually reset your ship symbol if you press the **OFF CENTER** key.

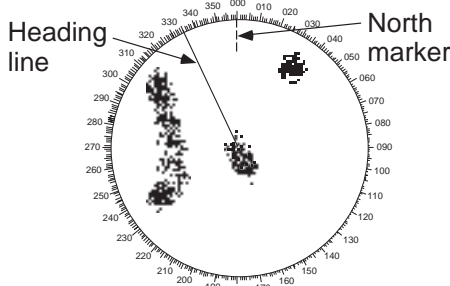
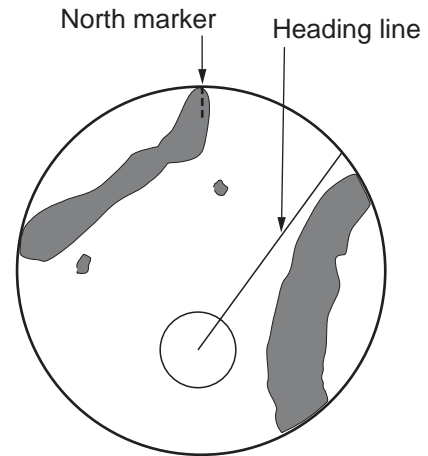

(a) True motion is selected

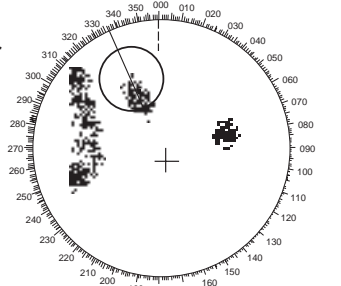

(b) Your ship has reached a point 75% of display radius

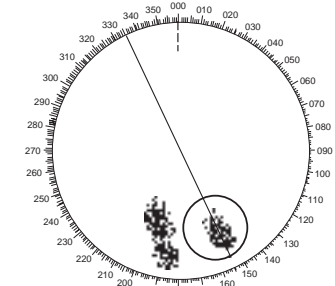

(c) Your ship is automatically reset to 75% of display radius

Automatic reset of your ship marker in true motion mode

True view mode

The echoes move in real time depending on the change of the heading of your ship. Heading line is at the top of the screen. When the heading signal is lost, this function is not available and the display mode automatically changes to the head-up mode. The [Wiper] is not available in this mode (see section 1.31).

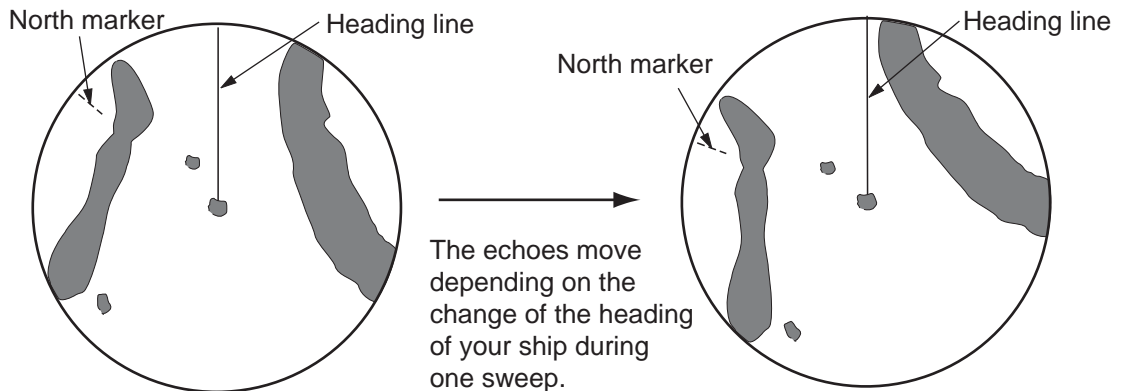

1.8 How to Select a Range Scale

The selected range scale, range ring interval and pulselength are shown at the upper-left corner on the screen. When an objective target comes closer, reduce the range scale so that a target appears in 50-90% of the display radius.

Use the **RANGE** key to select range. Press the "+" part of the key to raise the range; the "-" part to lower the range.

1.9 How to Adjust the Gain (sensitivity)

The gain functions to adjust the sensitivity of the receiver for the best reception. The gain can be adjusted automatically or manually.

1. Press the **MENU** key to open the menu.
2. Use the Cursorpad (▲ or ▼) to select [Echo] and press the **ENTER** key.
3. Use the Cursorpad (▲ or ▼) to select [Gain Mode] and press the **ENTER** key.



Gain Mode options

4. Use the Cursorpad (▲ or ▼) to select [Auto] or [Manual] then press the **ENTER** key. The window for Gain/Sea/Rain indicator shown below appears. This window closes automatically in the [River] or [Sea] mode when there is no menu operation for three seconds. [Auto] is for adjusting the gain automatically. For [Manual], go to **Manual mode** below.

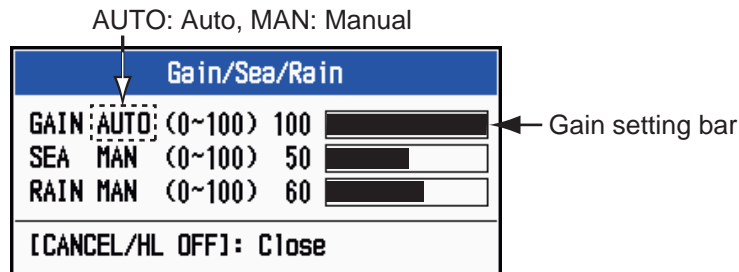

Gain/Sea/Rain indicator

5. Press the **CANCEL/HL OFF** key to close the window.
6. Press the **MENU** key to close the menu.

Note: When you want to adjust the gain finely in [Auto] mode, rotate the **GAIN** knob. The confirmation message appears. If you select [Yes], the mode changes to [Manual] mode. Rotate the **GAIN** knob to adjust the gain.

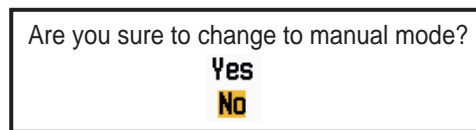

Confirmation message

Manual mode

1. Rotate the **GAIN** knob to adjust the gain so that weak noise appears on all of the screen. If the gain is too low, weak echoes are erased. If the gain is too high, the background noise hides weak targets.
2. Press the **CANCEL/HL OFF** key to close the window.

1.10 How to Reduce the Sea Clutter

The reflected echoes from the waves appear around your ship and have the name "sea clutter". The sea clutter extends according to the height of waves and antenna above the water. When the sea clutter hides the targets, use the **A/C SEA** control to reduce the clutter, either manually or automatically.

1. Press the **MENU** key to open the menu.
2. Use the Cursorpad (▲ or ▼) to select [Echo] and press the **ENTER** key.
3. Use the Cursorpad (▲ or ▼) to select [Sea Mode] and press the **ENTER** key.
4. Use the Cursorpad (▲ or ▼) to select [Auto] or [Manual] then press the **ENTER** key. The window for Gain/Sea/Rain indicator appears (refer to the illustration at step 4 in section 1.9). If you selected [Auto], go to step 5. For [Manual], go to **Manual mode** below.
5. Press the **CANCEL/HL OFF** key to close the window. [Auto] is for reducing the sea clutter automatically. If the sea clutter is strong while cruising along a coastline in the [Auto] mode, go to step 6. If not, go to step 9.
6. Use the Cursorpad (▲ or ▼) to select [Auto Sea] and press the **ENTER** key.



Auto Sea options

7. Use the Cursorpad (▲ or ▼) to select [Coastal] or [Advanced] then press the **ENTER** key. The window for Gain/Sea/Rain indicator appears for confirmation.
 - [Coastal]:** Suppress both land and sea clutter. For cruising along a coastline.
 - [Advanced]:** Automatically discriminate land echoes from sea reflections to suppress only sea reflections. Use this mode for general use.
8. Press the **CANCEL/HL OFF** key to close the window.
9. Press the **MENU** key to close the menu.

Note: When you want to adjust the sea clutter finely in [Auto] mode, rotate the **A/C SEA** knob. The confirmation message appears. If you select [Yes], the mode changes to [Manual] mode. Rotate the **A/C SEA** knob to adjust the sea clutter.



Confirmation message

Manual mode

1. Rotate the **A/C SEA** knob to reduce the sea clutter.
 - Note:** When the setting of the **A/C SEA** control is correct, the clutter is broken into small dots, and small targets become identified. If the setting is not enough, targets are hidden in the clutter. If the setting is higher than necessary, both sea clutter and targets disappear from the display. Normally adjust the control until the clutter has disappeared to leeward, but a small amount of the clutter is visible windward.

1. DESCRIPTION OF OPERATION

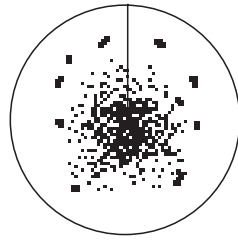

Sea clutter at
screen center

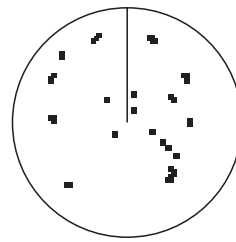

A/C SEA control adjusted;
sea clutter reduced

Sea clutter

2. Press the **CANCEL/HL OFF** key to close the window.

1.11 How to Reduce the Rain Clutter

The reflections from the rain or snow appear on the screen. These reflections have the name "rain clutter". When the rain clutter is strong, targets in the rain clutter are hidden in the clutter. Reflections from the rain clutter are easily identified from true targets by their wool-like appearance.

The **A/C RAIN** control, like the **A/C SEA** control, adjusts the receiver sensitivity, but in longer range. If the setting is high, the rain clutter is more reduced. The rain control breaks the continuous display of rain or snow reflections into a random pattern. When the rain clutter hides the targets, adjust the rain control (automatic or manual) to reduce the clutter.

1. Press the **MENU** key to open the menu.
2. Use the Cursorpad (▲ or ▼) to select [Echo] and press the **ENTER** key.
3. Use the Cursorpad (▲ or ▼) to select [Rain Mode] and press the **ENTER** key.
4. Use the Cursorpad (▲ or ▼) to select [Auto] or [Manual] then press the **ENTER** key. The window for Gain/Sea/Rain indicator appears (refer to the illustration of step 4 at section 1.9). If you selected [Auto], go to step 5. For [Manual], go to **Manual mode** below.
5. Press the **CANCEL/HL OFF** key to close the window.
6. Use the Cursorpad (▲ or ▼) to select [Auto Rain] and press the **ENTER** key.



Auto Rain options

7. Use the Cursorpad (▲ or ▼) to select [Calm], [Moderate] or [Rough] then press the **ENTER** key. The window for Gain/Sea/Rain indicator appears for confirmation.
[Calm]: For light rain
[Moderate]: When you can not reduce the rain clutter with [Calm] mode
[Rough]: For heavy rain
8. Press the **CANCEL/HL OFF** key to close the window.
9. Press the **MENU** key to close the menu.

Note: When you want to adjust the rain clutter finely in [Auto] mode, rotate the **A/C RAIN** knob. The confirmation message appears. If you select [Yes], the mode changes to [Manual] mode. Rotate the **A/C RAIN** knob to adjust the rain clutter.



Confirmation message

Manual mode

1. Rotate the **A/C RAIN** knob to reduce the rain clutter.
2. Press the **CANCEL/HL OFF** key to close the window.

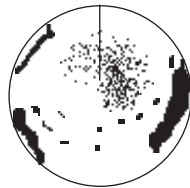

Rain clutter at screen center

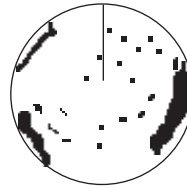

A/C RAIN control adjusted; rain clutter reduced

Rain clutter

1.12 Automatic Adjustments of Sea and Rain Clutters

When you can not correctly reduce the sea clutter or rain clutter with related control, turn on the automatic anti-clutter feature. When this feature is turned on, "A/C AUTO" appears at the lower-right corner.

1. Press the **MENU** key to open the menu.
2. Use the Cursorpad (▲ or ▼) to select [Echo] and press the **ENTER** key.
3. Use the Cursorpad (▲ or ▼) to select [A/C Auto] and press the **ENTER** key.
4. Use the Cursorpad (▲ or ▼) to select [Off] or [On] then press the **ENTER** key.
5. Press the **MENU** key to close the menu.

Caution on use

- [A/C Auto] can lower an echo which covers a wide area, like land or an island.
- When [A/C Auto] is active, the strength of a target in sea clutter or rain clutter can be lower than actual strength. In this case change to manual A/C Sea and manual A/C Rain and adjust the picture.

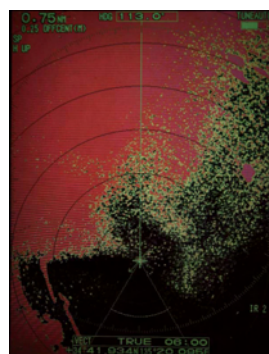

A/C Auto: Off

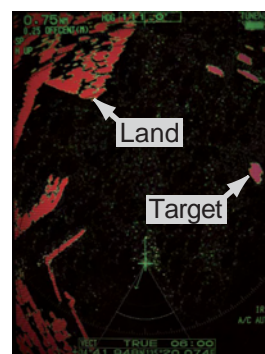

A/C Auto: On

1.13 Cursor

The cursor functions to find the range and bearing (default function) to a target or the latitude and longitude position of a target. Use the Cursorpad to position the cursor and read the cursor data at the screen bottom.

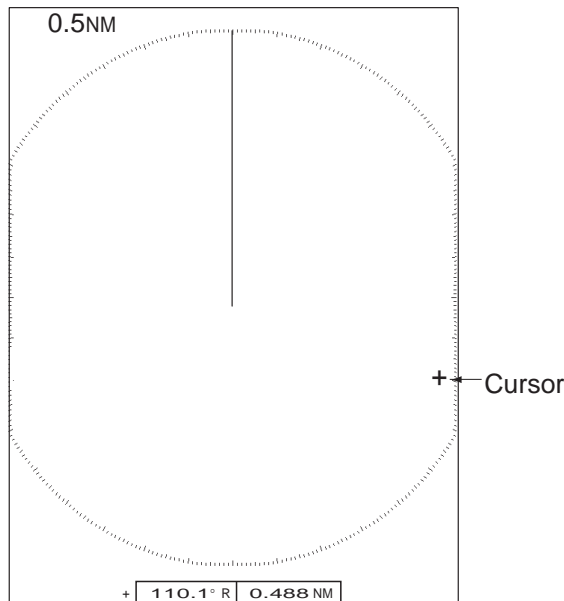

Cursor data
(range and bearing,
or latitude and longitude)

Cursor data

Cursor data

You can show the cursor data as range and bearing (from your ship to the cursor) or latitude and longitude. Position and heading signal are required.

1. Press the **MENU** key to open the menu.
2. Use the Cursorpad (▲ or ▼) to select [Others] and press the **ENTER** key.

Menu	Others
Brill/Color	F1 Setup : Gain Mode
Display	F2 Setup : Sea Mode
Echo	F3 Setup : A/C Auto
Custom 1	WPT Mark : Off
Custom 2	EBL Reference : Relative
Custom 3	VRM Unit : NM
Alarm	Cursor Position : Rng/Brg
Target Trails	
Tuning	
Others	
Target	
[ENTER]: Enter [CANCEL/HL OFF]: Back [MENU]: Exit	
Choosing the function assigned to [F1]	

Others menu

- Use the Cursorpad (▲ or ▼) to select [Cursor Position] and press the **ENTER** key.



Cursor Position options

- Use the Cursorpad (▲ or ▼) to select [Rng/Brg] or [Lat/Lon] then press the **ENTER** key. (When the navigation data is displayed, cursor latitude and longitude position cannot be displayed.)
- Press the **MENU** key to close the menu.

1.14 Interference Rejector

The radar interference can occur when your ship is near the radar of another ship that operates on the same frequency band with your radar. The interference shows on the screen as many bright dots. The dots can be random or in the shape of dotted lines that run from the center to the edge of the display. You can identify the interference from the normal echoes, because the interference does not appear in the same location at the next antenna rotation. When this feature is turned on, "IR 1", "IR 2" or "IR 3" appears at the lower-right corner.

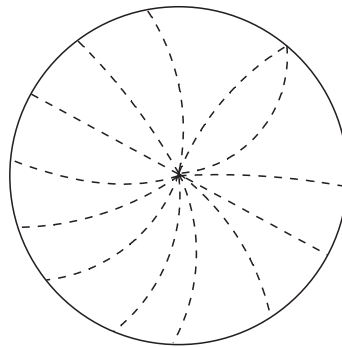

Interference

- Press the **MENU** key to open the menu.
- Use the Cursorpad (▲ or ▼) to select [Echo] and press the **ENTER** key.
- Use the Cursorpad (▲ or ▼) to select [Int Rejector] and press the **ENTER** key.

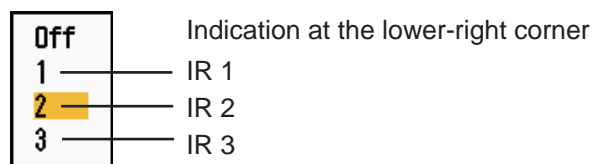

Int Rejector options

- Use the Cursorpad (▲ or ▼) to select [Off], [1], [2] or [3] then press the **ENTER** key. [3] removes the interference the most.
- Press the **MENU** key to close the menu.

Note: When there is no interference, turn off the interference rejector so you do not miss the small targets.

1.15 How to Measure the Range to a Target

You can measure the range to a target in three methods. You can use the fixed range rings, the cursor (if set to measure range and bearing), and the VRM (Variable Range Marker).

Use the fixed range rings to get a rough estimate of the range to a target. The fixed range rings are the concentric solid circles about your ship. The number of rings changes with the selected range scale. The interval of the range ring is displayed at the upper-left corner of the screen. Count the number of rings between the center of the display and the target. Check the range ring interval and measure the distance of the echo from the nearest ring.

1.15.1 How to adjust range ring brilliance

1. Press the **MENU** key to open the menu.
2. Use the Cursorpad (**▲** or **▼**) to select [Brill/Color] and press the **ENTER** key.

Menu	Brill/Color
Brill/Color	Echo Brill : 8
Display	Rings Brill : 4
Echo	Mark Brill : 4
Custom 1	HL Brill : 4
Custom 2	Character Brill : 4
Custom 3	View Position : Center
Alarm	Display Color : Custom
Target Trails	Echo Color : Yellow
Tuning	Background Color : Black
Others	[ENTER]: Enter [CANCEL/HL OFF]: Back
Target	[MENU]: Exit

Adjusting echo brilliance

Brill/Color menu

3. Use the Cursorpad (**▲** or **▼**) to select [Rings Brill] and press the **ENTER** key.

Off
1
2
3
4

Rings Brill options

4. Use the Cursorpad (**▲** or **▼**) to select an option and press the **ENTER** key. [4] is the brightest. [Off] turns off the range rings.
5. Press the **MENU** key to close the menu.

1.15.2 How to measure the range with a VRM

There are two VRMs, No. 1 and No. 2. The VRMs are dashed rings so that you can identify the rings from the fixed range rings. You can identify VRM 1 from VRM 2 by different lengths of dashes. The dashes of the No. 1 VRM are shorter than those of the No. 2 VRM.

1. Press the **VRM** key to display either of the VRMs. Press the **VRM** key to change the active VRM between No. 1 and No. 2. The indication of the currently active VRM is in a rectangle.
2. Use the Cursorpad to align the Variable Range Marker with the inner edge of the target. Read the distance at the lower-right corner of the screen. Each VRM remains at the same geographical distance when you operate the **RANGE** key. The size of the VRM ring changes in proportion to the selected range scale.
3. Press the **ENTER** key to anchor the VRM.
4. To erase a VRM, press the **VRM** key to activate the VRM and press the **CANCEL/HL OFF** key.

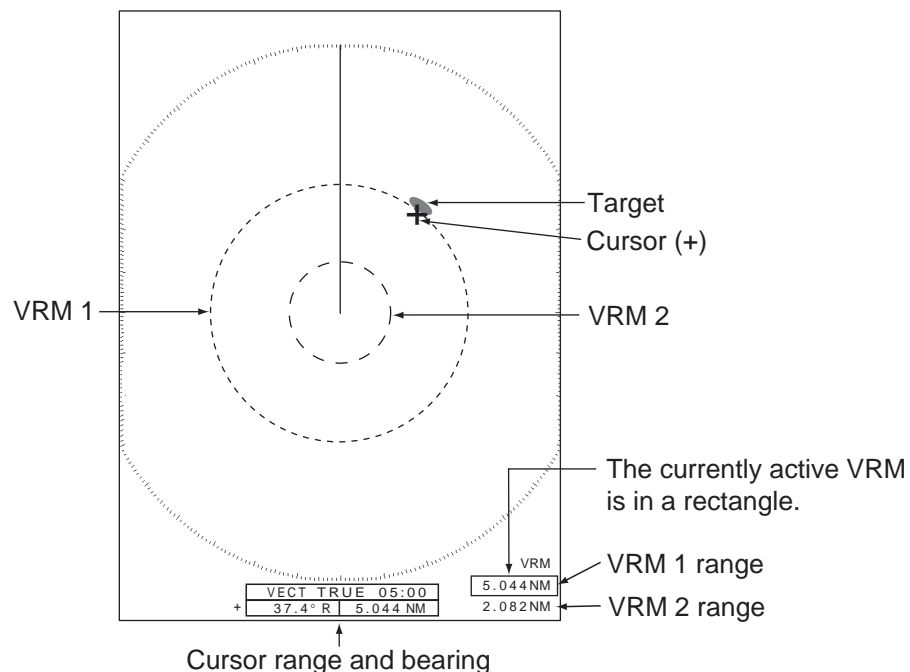

How to measure the range with the VRM

1.15.3 How to select VRM unit

You can select the unit of measurement used by the VRM. The selections are nautical miles (NM), kilometers (KM), statute miles (SM) or kiloyard (KYD). The cursor range unit is also changed when the VRM unit is changed.

1. Press the **MENU** key to open the menu.
2. Use the Cursorpad (**▲** or **▼**) to select [Others] and press the **ENTER** key.

1. DESCRIPTION OF OPERATION

- Use the Cursorpad (▲ or ▼) to select [VRM Unit] and press the **ENTER** key.

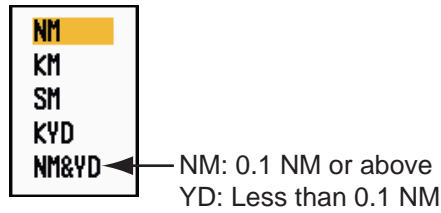

VRM Unit options

- Use the Cursorpad (▲ or ▼) to select the unit and press the **ENTER** key.
- Press the **MENU** key to close the menu.

1.16 How to Measure the Bearing to a Target

Use the Electronic Bearing Line (EBL) to take a bearing of a target. There are two EBLs, No. 1 and No. 2. Each EBL is a straight dashed line from the center of the screen to the edge. The dashes of the No. 1 EBL are shorter than those of the No. 2 EBL.

1.16.1 How to measure the bearing with an EBL

- Press the **EBL** key to display either of the EBLs. Press the **EBL** key to change the active EBL between No. 1 and No. 2. The indication of the currently active EBL is in a rectangle.
- Use the Cursorpad to put the EBL on the center of the target. Read the bearing at the lower-left corner of the screen.
- Press the **ENTER** key to anchor the EBL.
- To erase an EBL, press the **EBL** key to activate the EBL and press the **CANCEL/HL OFF** key.

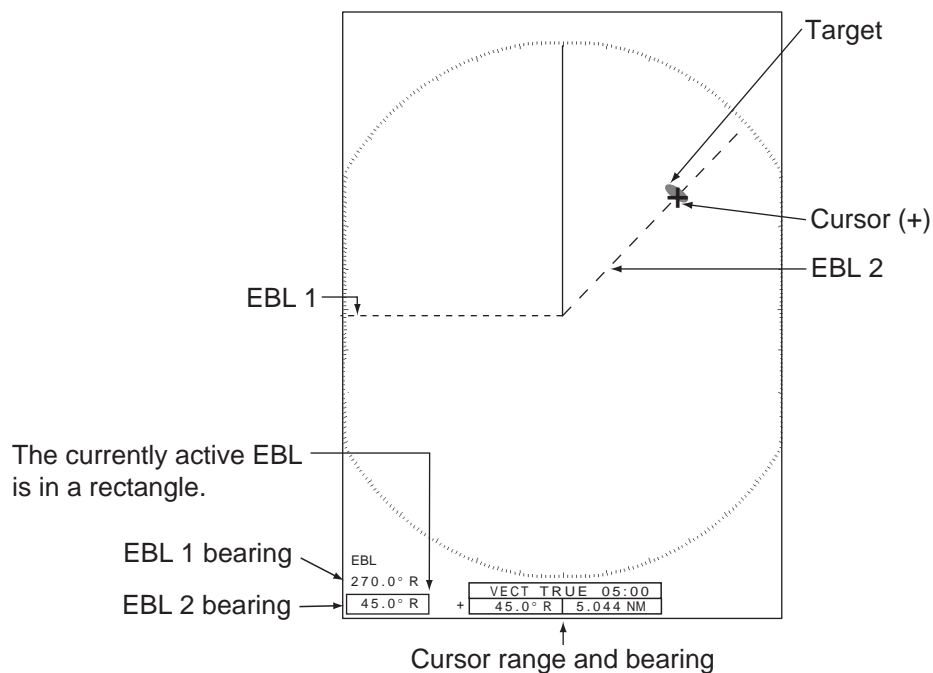

How to measure the bearing with the EBL

1.16.2 EBL reference

"R" (relative) follows the EBL indication if the bearing is relative to the heading of your ship. "T" (true) follows the EBL indication if the bearing is in reference to the north. You can select relative or true in the head-up and true view modes. The bearing indication is true in all other modes. True bearing requires a heading sensor.

1. Press the **MENU** key to open the menu.
2. Use the Cursorpad (▲ or ▼) to select [Others] and press the **ENTER** key.
3. Use the Cursorpad (▲ or ▼) to select [EBL Reference] and press the **ENTER** key.

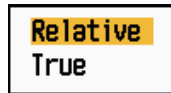

EBL Reference options

4. Use the Cursorpad (▲ or ▼) to select [Relative] or [True] then press the **ENTER** key.
5. Press the **MENU** key to close the menu.

1.17 How to Measure the Range and Bearing Between Two Targets

You can move the origin of the EBL to measure the range and bearing between two targets.

1. Press the **EBL** key to select the bearing indication of EBL 1 or EBL 2. The indication of the currently active EBL is in a rectangle.
2. Use the Cursorpad to put the cursor on the center of the target A.
3. Press the **OFF CENTER** key to move the origin of the EBL to the location selected at step 2.
4. Use the Cursorpad to put the cursor on the center of the target B.
5. Press the **VRM** key to display the VRM having the same number as the EBL activated at step 1. The indication of the currently active VRM is in a rectangle.
6. Use the Cursorpad to set the VRM on the inner edge of the target B.

1. DESCRIPTION OF OPERATION

7. Read the bearing and range indications at the bottom of the screen.

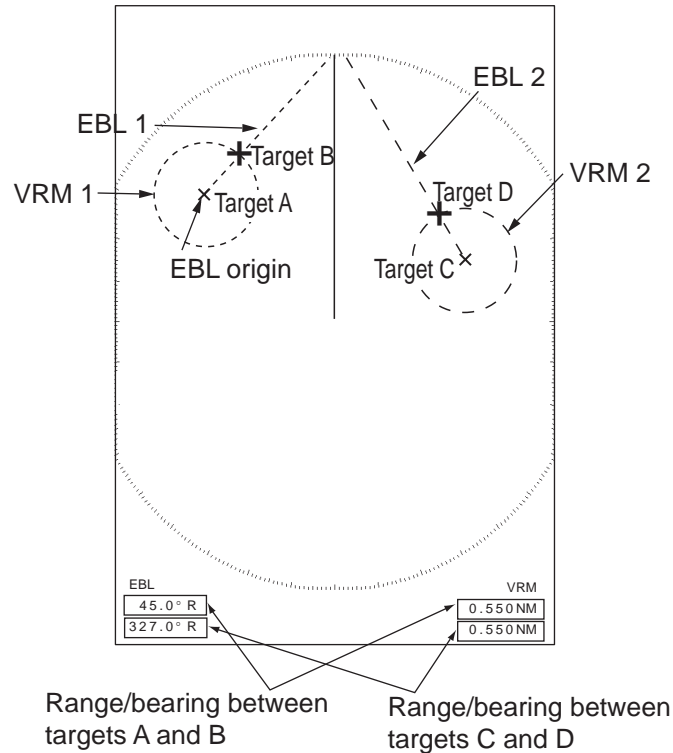

How to measure the range and bearing between two targets

When you press the **OFF CENTER** key in EBL operation, the origin of an EBL moves between the screen center and cursor location. To return the origin of an EBL to the screen center, press the **ENTER** key when the origin of an EBL is on the screen center.

1.18 How to Select a Pulselength

The pulselength in use appears at the upper-left position on the screen. The pulselengths are set to each range scale and custom setup. You can change the pulselength on the 1.5 nm, 1.6 nm, 3 nm or 3.2 nm range with the following procedure. Pulselength cannot be changed on other ranges. (You can change the pulselength on the 2 nm or 4 nm range in the [Russian-River] mode.) Use a longer pulse when your purpose is long range detection. Use a shorter pulse when the resolution is important.

Note: Press the **CUSTOM** key several times to activate the [Echo] menu until the CS 1 (2, 3) indication (custom setting) disappears from the screen. See the illustration in section 1.3.

1. Press the **MENU** key to open the menu.

- Use the Cursorpad (▲ or ▼) to select [Echo] and press the **ENTER** key.

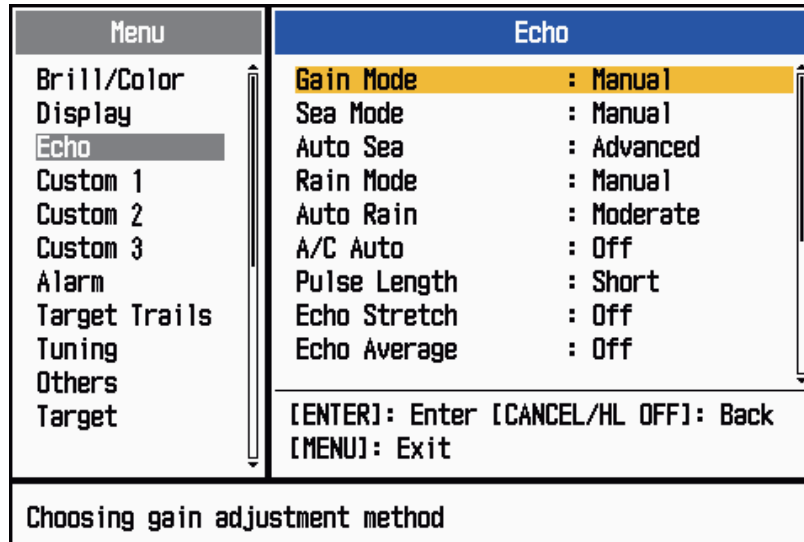

Echo menu

- Use the Cursorpad (▲ or ▼) to select [Pulse Length] and press the **ENTER** key.



Pulse Length options

- Use the Cursorpad (▲ or ▼) to select [Short] or [Long] then press the **ENTER** key. The pulselength indication at the upper-left corner changes according to your selection as shown below.
 1.5 nm or 1.6 nm (or 2 nm in the [Russian-River] mode): "SP" for [Short] pulse, "MP" for [Long] pulse
 3 nm or 3.2 nm (or 4 nm in the [Russian-River] mode): "MP" for [Short] pulse, "LP" for [Long] pulse
- Press the **MENU** key to close the menu.

1.19 Target Alarm

The target alarm looks for targets (ship, landmass, etc.) in the area you set. Audiovisual alarms are released when a target enters (or exits) the alarm area.

 CAUTION
<p>Do not depend on the alarm as the only means to detect possible collision situations.</p> <p>Adjust the A/C SEA, A/C RAIN and GAIN controls correctly so that the alarm system does not miss the target echoes.</p>

1. DESCRIPTION OF OPERATION

1.19.1 How to set a target alarm zone

The following procedure shows you how to set a target alarm zone.

1. Press the **TARGET ALARM** key to activate ALARM 1 or ALARM 2. Press the **TARGET ALARM** key to change the active ALARM between No. 1 and No. 2. The indication of the currently active ALARM is in a rectangle at the upper-right corner of the screen.
2. Use the Cursorpad to move the cursor to the position A and press the **ENTER** key.
3. Move the cursor to the position B and press the **ENTER** key. The rectangle that shows alarm status indication at the upper-right corner of the screen disappears.

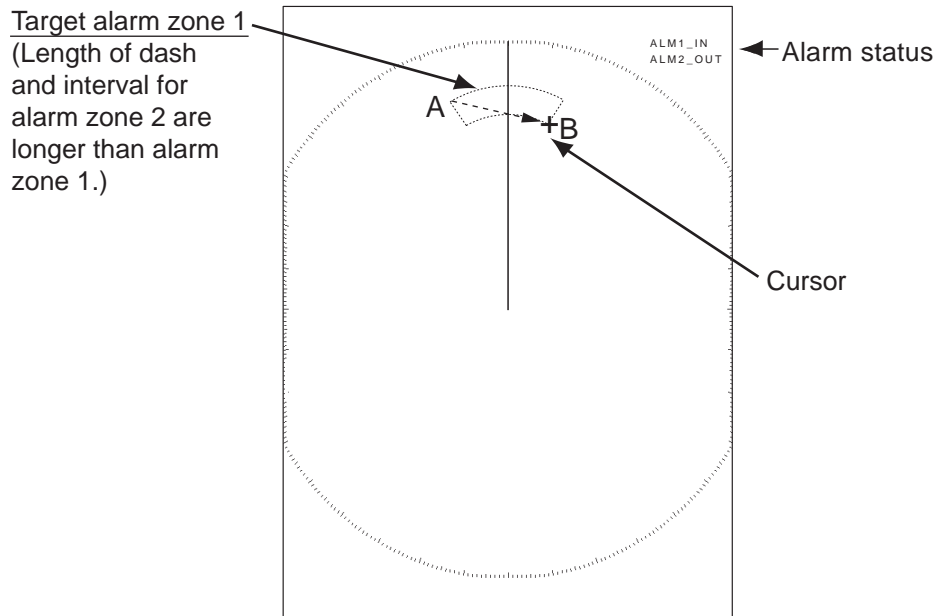

How to set a target alarm zone

Note 1: To set a 360-degree guard zone, set the position B in the same bearing as the position A.

Note 2: When the target alarm zone is not within the range in use, the indication "ALM1(or 2)_RNG" replaces "ALM1(or 2)_IN(or OUT)" in the alarm status area. (When the target alarm zone is within the range of full off-centering, the indication does not change.) Select a range which displays the target alarm zone.

1.19.2 How to stop the audio alarm

When a target enters (or exits) the target alarm zone, the target flashes and the alarm sounds. The alarm message appears at the bottom of the screen. To stop the audio alarm, press any key. When the target enters (or exits) the target alarm zone again, the audio alarm sounds.

1.19.3 How to select the alarm type

You can set the target alarm to activate against targets entering or exiting the alarm zone.

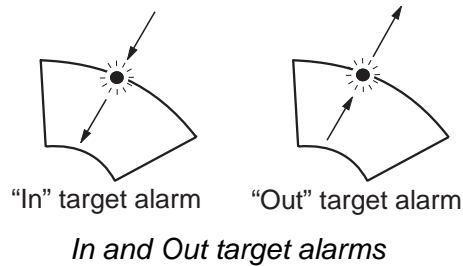

1. Press the **MENU** key to open the menu.
2. Use the Cursorpad (▲ or ▼) to select [Alarm] and press the **ENTER** key.

Menu	Alarm
Brill/Color	Target Alarm 1 : In
Display	Target Alarm 2 : In
Echo	Alarm Level : Med
Custom 1	Watchman : Off
Custom 2	Panel Buzzer : On
Custom 3	External Buzzer : On
Alarm	Alarm Status
Target Trails	
Tuning	
Others	
Target	
[ENTER]: Enter [CANCEL/HL OFF]: Back [MENU]: Exit	
Choosing the type (in/out) of target alarm 1	

Alarm menu

3. Use the Cursorpad (▲ or ▼) to select [Target Alarm 1] or [Target Alarm 2] then press the **ENTER** key.



Target Alarm options

4. Use the Cursorpad (▲ or ▼) to select [In] or [Out].
[In]: When the targets enter a target alarm zone, the alarm sounds.
[Out]: When the targets exit a target alarm zone, the alarm sounds.
5. Press the **ENTER** key followed by the **MENU** key.

1.19.4 How to sleep a target alarm temporarily

When you do not require a target alarm temporarily, you can sleep the target alarm. The alarm zone remains on the screen, but any targets that enter (or exit) the alarm zone do not trigger the audio and visual alarms.

1. Press the **TARGET ALARM** key to select the ALARM 1 or ALARM 2 indication at the upper-right corner on the screen. The selected indication is in a rectangle.

1. DESCRIPTION OF OPERATION

2. Press the **CANCEL/HL OFF** key. The alarm indication now shows "ALM1(or 2)_ACK".

To activate a sleeping target alarm zone, press the **TARGET ALARM** key to select the ALARM 1 or ALARM 2 and press the **ENTER** key. The alarm indication then changes to "ALM1(or 2)_IN(or OUT)".

1.19.5 How to deactivate a target alarm

1. Press the **TARGET ALARM** key to select the ALARM 1 or ALARM 2 indication at the upper-right corner on the screen. The selected indication is in a rectangle.
2. Press the **CANCEL/HL OFF** key. The alarm indication now shows "ALM1(or 2)_ACK".
3. Press the **TARGET ALARM** key. The alarm indication "ALM1(or 2)_ACK" is shown in a dashed-line rectangle.
4. Press the **CANCEL/HL OFF** key. The target alarm zone and the alarm indication are erased from the screen.

1.19.6 How to select the target strength which triggers a target alarm

You can select the target strength which triggers the target alarm as follows:

1. Press the **MENU** key to open the menu.
2. Use the Cursorpad (▲ or ▼) to select [Alarm] and press the **ENTER** key.
3. Use the Cursorpad (▲ or ▼) to select [Alarm Level] and press the **ENTER** key.



Alarm Level options

4. Use the Cursorpad (▲ or ▼) to select the echo strength level.
5. Press the **ENTER** key followed by the **MENU** key.

1.19.7 How to turn the buzzer on/off

You can turn on/off the panel buzzer or external buzzer for target alarms. The panel buzzer is for this equipment. The external buzzer is for the optional buzzer, which is connected to this equipment to give the target alarm at a remote location.

1. Press the **MENU** key to open the menu.
2. Use the Cursorpad (▲ or ▼) to select [Alarm] and press the **ENTER** key.
3. Use the Cursorpad (▲ or ▼) to select [Panel Buzzer] (or [External Buzzer] for optional buzzer) and press the **ENTER** key.



Panel Buzzer and External Buzzer options

4. Use the Cursorpad (▲ or ▼) to select [On] or [Off] then press the **ENTER** key.
5. Press the **MENU** key to close the menu.

1.20 How to Off-center the Display

You can off-center your ship position to expand the view field without selecting a larger range scale. The display can be off-centered manually, or automatically according to speed of the ship.

Note: Off-centering is not available in the true motion mode.

1.20.1 How to select the off-center mode

1. Press the **MENU** key to open the menu.
2. Use the Cursorpad (▲ or ▼) to select [Display] and press the **ENTER** key.
3. Use the Cursorpad (▲ or ▼) to select [Offcenter Mode] and press the **ENTER** key.

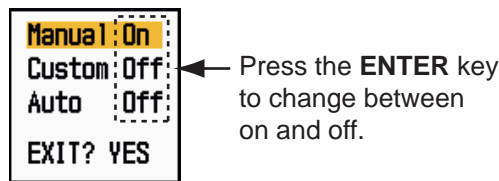

Offcenter Mode options

4. Use the Cursorpad (▲ or ▼) to select [Manual], [Custom] or [Auto] then press the **ENTER** key. Press the **ENTER** key to change between on and off.
5. After setting all options, use the Cursorpad (▼) to select [EXIT? YES] and press the **ENTER** key.
6. Press the **MENU** key to close the menu.

1.20.2 Off-center the display

Press the **OFF CENTER** key to move your ship position. When you press the **OFF CENTER** key continuously, the mode changes in the sequence of OFF → Manual → Custom → Auto → OFF → Manual → ... (the options available depend on setting selected at step 4 in section 1.20.1). When off-centering is active, "OFFCENT(M)", "OFFCENT(C)" or "OFFCENT(A)" appears at the upper-left corner on the display.

Note: Off-center is not available on the 64 nm range scale.

Manual (Indication: "OFFCENT(M)")

You can move your ship position to the current cursor position on all modes except true motion, within 75% of the available display area.

1. Press the **OFF CENTER** key several times until the off-center indication disappears.
2. Put the cursor on the position where to off-center the display.
3. Press the **OFF CENTER** key several times until the indication "OFFCENT(M)" appears.

1. DESCRIPTION OF OPERATION

Custom (Indication: "OFFCENT(C)")

You can move your ship position to the position which you pre-set. Follow the procedure shown below to register the cursor position.

1. Press the **OFF CENTER** key several times until the off-center indication disappears.
2. Put the cursor on the position where to off-center the display.
3. Press the **OFF CENTER** key several times until the indication "OFFCENT(M)" appears.
4. Press the **MENU** key to open the menu.
5. Use the Cursorpad (▲ or ▼) to select [Display] and press the **ENTER** key.
6. Use the Cursorpad (▲ or ▼) to select [Save Offcenter] and press the **ENTER** key. The message "Complete" appears.
7. Press any key to close the message window.
8. Press the **MENU** key to close the menu.

To change the mode to custom, press the **OFF CENTER** key several times until the indication "OFFCENT(C)" appears.

Auto (Indication: "OFFCENT(A)")

The amount of automatic move is calculated according to speed of the ship. The maximum amount is 75% of the range in use. The formula to calculate automatic shift is shown below.

$$\frac{\text{Speed of ship}}{\text{Offcenter speed setting}} \times 0.75 = \text{Amount of move (\%)}$$

If the offcenter speed setting is 15 knots and the speed of the ship is 10 knots, for example, the amount of move at the stern of your ship will be 50% of the available display area.

How to select offcenter speed

1. Press the **MENU** key to open the menu.
2. Use the Cursorpad (▲ or ▼) to select [Initial] sub menu in [System] menu and press the **ENTER** key.
3. Use the Cursorpad (▲ or ▼) to select [Offcenter Speed] and press the **ENTER** key.

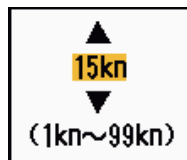

Offcenter Speed setting window

4. Use the Cursorpad (▲ or ▼) to select the speed to use and press the **ENTER** key.
5. Press the **MENU** key to close the menu.

1.21 Zoom

The zoom function expands the length and width of a selected target as much as twice its normal size, in the zoom window. You select the target to zoom with the zoom cursor. The selected target is zoomed in the zoom window.

ARPA and AIS symbols can be displayed in the zoom window, but are not zoomed. You can process ARPA and AIS targets that are in the zoom window, in the same method as on the normal radar display.

There are three types of zoom.

[Relative]: The zoom cursor is fixed to the range and bearing from your ship.

[True]: The zoom cursor is fixed to set geographical position.

[Target]: The zoom cursor is fixed to the zoomed AIS or ARPA target.

1.21.1 Zoom mode

You can select the zoom mode from [Relative], [True] or [Target].

1. Press the **MENU** key to open the menu.
2. Use the Cursorpad (▲ or ▼) to select [Display] and press the **ENTER** key.
3. Use the Cursorpad (▲ or ▼) to select [Zoom Mode] and press the **ENTER** key.

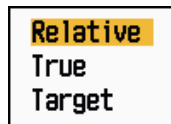

Zoom Mode options

4. Use the Cursorpad (▲ or ▼) to select [Relative], [True] or [Target] then press the **ENTER** key.

Note: True zoom mode requires a heading signal and position data.
5. Press the **MENU** key to close the menu.

1.21.2 How to zoom

Relative or True zoom mode

1. Use the Cursorpad to put the cursor on the position desired.
2. Press the **MENU** key to open the menu.
3. Use the Cursorpad (▲ or ▼) to select [Display] and press the **ENTER** key.
4. Use the Cursorpad (▲ or ▼) to select [Zoom] and press the **ENTER** key.



Zoom options

5. Use the Cursorpad (▲ or ▼) to select [On] and press the **ENTER** key.

The ZOOM indication appears at the upper-left corner on the screen. The zoom window and the zoom cursor also appear (see the illustration on the next page). To quit the zoom, select [Off] instead of [On] and press the **ENTER** key.
6. Press the **MENU** key to close the menu.

1. DESCRIPTION OF OPERATION

Target zoom mode

The ARPA or AIS target as below can be displayed in the zoom window:

ARPA: The symbol is enlarged twice its normal size.

AIS: The symbol is enclosed in a broken square. (The symbol is not enlarged.)

The zoom cursor moves with the ARPA or AIS target.

Note: If neither ARPA nor AIS targets are selected, the message "NO TARGET." appears. Press any key to erase the message.

1. Press the **MENU** key to open the menu.
2. Use the Cursorpad (▲ or ▼) to select [Display] and press the **ENTER** key.
3. Use the Cursorpad (▲ or ▼) to select [Zoom] and press the **ENTER** key.
4. Use the Cursorpad (▲ or ▼) to select [On] and press the **ENTER** key.
The ZOOM indication appears at the upper-left corner on the screen. The zoom window and the zoom cursor also appear (see the following illustration). To quit the zoom, select [Off] instead of [On] and press the **ENTER** key.
5. Press the **MENU** key to close the menu.

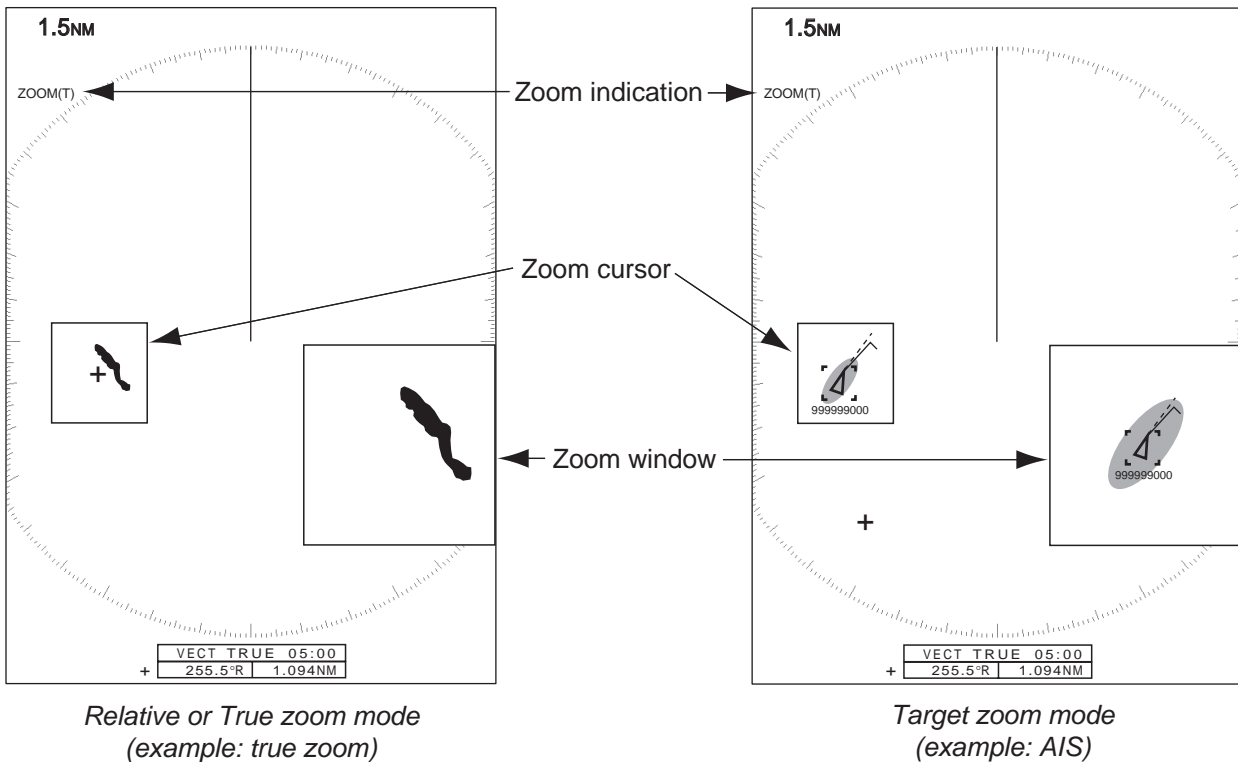

1.22 Echo Stretch

The echo stretch feature enlarges the targets in the range and bearing directions to make the targets easier to see. This feature is available on any range. There are three levels of echo stretch, [1], [2] and [3]. [3] enlarges the targets the most.

Note: The echo stretch magnifies the targets, sea and rain clutters, and radar interference. Correctly adjust the sea clutter, rain clutter and radar interference before you activate the echo stretch.

1. Press the **MENU** key to open the menu.
2. Use the Cursorpad (▲ or ▼) to select [Echo] and press the **ENTER** key.
3. Use the Cursorpad (▲ or ▼) to select [Echo Stretch] and press the **ENTER** key.

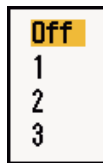

Echo Stretch options

4. Use the Cursorpad (▲ or ▼) to select an echo stretch option and press the **ENTER** key.
5. Press the **MENU** key to close the menu. When the echo stretch is active, "ES 1 (2, or 3)" appears at the lower-left corner on the display.

1.23 Echo Average

To identify true target echoes from the sea clutter, echoes are averaged over successive picture frames. If an echo is solid and stable, the echo is shown in its normal intensity. The brilliance of sea clutter is reduced to easily identify true targets from the sea clutter.

Note 1: Do not use the echo average function under heavy pitching and rolling. You can lose a target.

Note 2: This feature requires a heading signal and position data. When either signal becomes lost, echo average is deactivated.

To correctly use the echo average function, first reduce the sea clutter with the **A/C SEA** control, then do as follows:

1. Press the **MENU** key to open the menu.
2. Use the Cursorpad (▲ or ▼) to select [Echo] and press the **ENTER** key.
3. Use the Cursorpad (▲ or ▼) to select [Echo Average] and press the **ENTER** key.

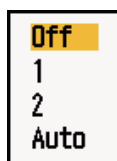

Echo Average options

1. DESCRIPTION OF OPERATION

- Use the Cursorpad (▲ or ▼) to select an echo averaging option and press the **ENTER** key.
[Off]: Deactivate the echo average.
[1]: Identify true targets from the sea clutter and reduce the brilliance of unstable echoes.
[2]: Identify true targets from the sea clutter that you cannot reduce the brilliance with setting 1.
[Auto]: Identify true targets from the sea clutter. Detect far and unstable targets.
- Press the **MENU** key to close the menu. The selected echo average ("EAV 1", "EAV 2" or "EAV(A)") appears at the lower-left corner of the display.

1.24 Target Trails

The trails of the radar targets can be shown simulated in afterglow to check target movement. The target trails are selected for either relative or true. True motion trails require a heading signal and position data.

1.24.1 Trail time

- Press the **MENU** key to open the menu.
- Use the Cursorpad (▲ or ▼) to select [Target Trails] and press the **ENTER** key.
- Use the Cursorpad (▲ or ▼) to select [Time] and press the **ENTER** key.

15s	On
30s	On
1min	On
3min	On
6min	On
15min	On
30min	On
Continuous	On
EXIT? YES	

← Press the **ENTER** key to change between on and off.

Time options

- Use the Cursorpad (▲ or ▼) to select time and press the **ENTER** key. Press the **ENTER** key to change between on and off.
- After setting all options, use the Cursorpad (▼) to select [EXIT? YES] and press the **ENTER** key.
- Press the **MENU** key to close the menu.

1.24.2 How to start, stop the trails

1. Press the **TRAILS** key to start the trails and select the trail time. The selected time with the trail mode is shown at the upper-right corner as in the figure shown below. The available trail time with the **TRAILS** key changes according to trail times, which you turn on in section 1.24.1.

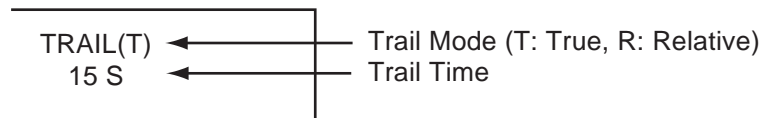

Trail indications

2. To change the trail time, press the **TRAILS** key until the desired trail time is displayed. The trail lengthens with the trail time.

Note 1: To erase the trails, press and hold the **TRAILS** key until a beep sounds, or select [All Cancel] on the [Target Trails].

Note 2: To deactivate the trails, press the **TRAILS** key several times until the trail indications disappear from the display.

1.24.3 Trail mode

You can display the echo trails in true or relative motion.

True mode

The true trails show true target movements according to their over-the-ground speeds and courses. The stationary targets do not show the trails. The true trails require a heading signal and position data.

Relative mode

The relative trails show other ships' movements relative to your ship. The stationary targets also show the trails.

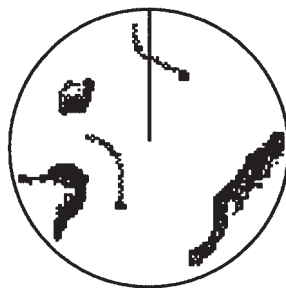

True target trails

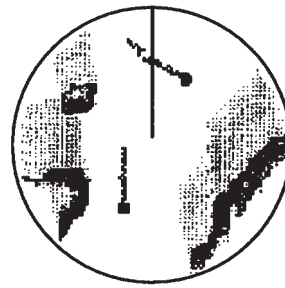

Relative target trails

True trails and relative trails

To select the trail mode, do the following:

1. Press the **MENU** key to open the menu.
2. Use the Cursorpad (▲ or ▼) to select [Target Trails] and press the **ENTER** key.

1. DESCRIPTION OF OPERATION

- Use the Cursorpad (▲ or ▼) to select [Mode] and press the **ENTER** key.



Mode options

- Use the Cursorpad (▲ or ▼) to select [Relative] or [True] then press the **ENTER** key.
- Press the **MENU** key to close the menu.

1.24.4 Trail gradation

Trails can be shown in single or multiple gradation. Multiple gradation fades the gradation over time.

- Press the **MENU** key to open the menu.
- Use the Cursorpad (▲ or ▼) to select [Target Trails] and press the **ENTER** key.
- Use the Cursorpad (▲ or ▼) to select [Gradation] and press the **ENTER** key.

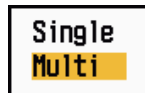

Gradation options

- Use the Cursorpad (▲ or ▼) to select [Single] or [Multi] then press the **ENTER** key.

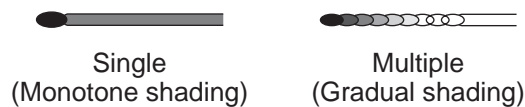

Trail gradation

- Press the **MENU** key to close the menu.

1.24.5 Trail color

You can select the color for trails as follows:

- Press the **MENU** key to open the menu.
- Use the Cursorpad (▲ or ▼) to select [Target Trails] and press the **ENTER** key.
- Use the Cursorpad (▲ or ▼) to select [Color] and press the **ENTER** key.



Color options

- Use the Cursorpad (▲ or ▼) to select a color and press the **ENTER** key.
- Press the **MENU** key to close the menu.

1.24.6 Trail level

You can select which target strength to display.

1. Press the **MENU** key to open the menu.
2. Use the Cursorpad (▲ or ▼) to select [Target Trails] and press the **ENTER** key.
3. Use the Cursorpad (▲ or ▼) to select [Level] and press the **ENTER** key.



Level options

4. Use the Cursorpad (▲ or ▼) to select [1], [2] or [3] then press the **ENTER** key.
 - [1]**: Display the trails for all targets (including weak targets).
 - [2]**: Display the trails for medium-to-strong level targets.
 - [3]**: Display the trails for only strong targets.
5. Press the **MENU** key to close the menu.

1.24.7 How to restart, stop the trails

When the range is changed while the trail feature is active, trails within the previous range scale can be stopped and restarted.

1. Press the **MENU** key to open the menu.
2. Use the Cursorpad (▲ or ▼) to select [Target Trails] and press the **ENTER** key.
3. Use the Cursorpad (▲ or ▼) to select [Restart] and press the **ENTER** key.



Restart options

4. Use the Cursorpad (▲ or ▼) to select [Off] or [On] then press the **ENTER** key.
 - [Off]**: The previous trails data are saved when the range is changed. The trails are not restarted and the saved trails are not updated. When you return the range scale to the previous range scale, the saved trails are displayed and updated.
 - [On]**: The previous trails are zoomed in or out depending on the changed scale and updated.

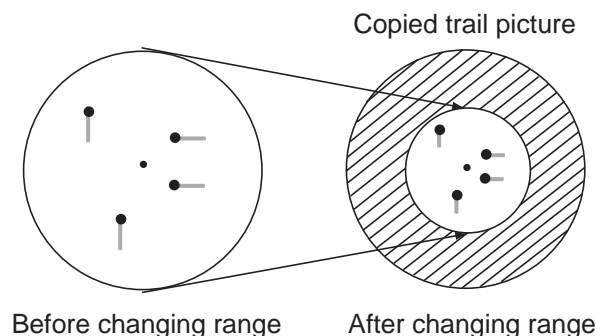

How trail copy operates

1. DESCRIPTION OF OPERATION

Note: If the newly selected range is less than or equal to 1/4 of the previous range, trails are erased. If the newly selected range is longer than the previous range, the previous trails are left to be displayed.

5. Press the **MENU** key to close the menu.

1.24.8 Narrow trails

You can display the target trails in thin trails. When there are many targets on the screen, you can separate trails close to one another with this function.

1. Press the **MENU** key to open the menu.
2. Use the Cursorpad (▲ or ▼) to select [Target Trails] and press the **ENTER** key.
3. Use the Cursorpad (▲ or ▼) to select [Narrow] and press the **ENTER** key.



Narrow options

4. Use the Cursorpad (▲ or ▼) to select [Off] or [On] then press the **ENTER** key.
5. Press the **MENU** key to close the menu.

1.24.9 Your ship trail

You can show the trail of your ship as follows:

1. Press the **MENU** key to open the menu.
2. Use the Cursorpad (▲ or ▼) to select [Target Trails] and press the **ENTER** key.
3. Use the Cursorpad (▲ or ▼) to select [Own Ship] and press the **ENTER** key.

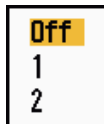

Own Ship options

4. Use the Cursorpad (▲ or ▼) to select [Off], [1] or [2] then press the **ENTER** key.
[Off]: Hide the trail of your ship.
[1]: Show the trail of your ship.
[2]: Show the trail of your ship, but hide the trail of sea clutter near your ship.
5. Press the **MENU** key to close the menu.

1.25 How to Send the Target Position and Enter the Origin Mark

The **TLL** key functions to send the cursor position to a chart plotter and put an origin mark (P) at the cursor position on the radar. Use the Cursorpad to put the cursor on a target and press the **TLL** key. You can enter up to 20 origin marks on the radar display. When the capacity for origin marks is reached, the oldest mark is erased to make room for the latest mark, to keep a maximum of 20 marks. To erase a mark, put the cursor on the mark and press the **CANCEL/HL OFF** key.

TLL key mode

You can select how to handle TLL position.

1. Press the **MENU** key to open the menu.
2. Use the Cursorpad (▲ or ▼) to select [Others] and press the **ENTER** key.
3. Use the Cursorpad (▲ or ▼) to select [TLL Key Mode] and press the **ENTER** key.



TLL Key Mode options

4. Use the Cursorpad (▲ or ▼) to select [TLL Output], [Origin Mark] or [Both] then press the **ENTER** key.
 - [TLL Output]:** Send the latitude and longitude of the cursor position to a chart plotter. (Position and heading signal are required.)
 - [Origin Mark]:** Enter an origin mark at the cursor position on the radar display. (Position and heading signal are required.)
 - [Both]:** Send the target position to a chart plotter and enter an origin mark on the radar display.
5. Press the **MENU** key to close the menu.

Note: When you turn off the power, all origin marks are deleted and not saved.

1.26 How to Hide the Heading Line Temporarily

The heading line indicates the heading of your ship in all display modes. The heading line is a line from your ship position to the outer edge of the radar display area. The heading line appears at zero degrees on the bearing scale in head-up and true view modes. The heading line changes the orientation depending on the ship orientation in north-up and true motion modes and when the course is changed in the course-up mode.

To hide the heading line (and all marks for River and Sea purpose) and display only targets, press and hold the **CANCEL/HL OFF** key. To display the heading line again, release the key.

1.27 Presentation Brilliance

You can adjust the brilliance for the following menu items from the [Brill/Color] menu.

[Echo Brill]: Brilliance for the echoes (setting range: 1 - 8)

[Rings Brill]: Brilliance for the range rings (setting range: Off, 1 - 4)

[Mark Brill]: Brilliance for the marks (EBL, VRM, etc.) (setting range: 1 - 4)

[HL Brill]: Brilliance for the heading line (setting range: 1 - 4)

[Character Brill]: Brilliance for the characters (setting range: 1 - 4)

1.28 Custom Setup

1.28.1 About custom setup

When your navigating environment or task changes, you must adjust the radar. Instead of changing radar settings case by case, you can assign the **CUSTOM** key to provide best settings for common conditions.

There are three default custom setups for the internal computer of the radar (see the table on the next page). You can adjust these settings on the [Custom 1], [Custom 2] and [Custom 3] menus to meet your navigation needs.

To activate a custom setup, press the **CUSTOM** key. The **CUSTOM** key switches between Custom 1, Custom 2 or Custom 3 each time you press the key. (Custom setup numbers which are turned off are ignored.) The selected custom setup name is shown at the upper-left corner. To escape from custom setup, operate any control.

1.28.2 Description of custom setup items

Description of custom setup items

Menu item	Available settings	See section
[Custom1(2 or 3)]	Turn on/off each custom program.	
[Copy]	Copy settings from the [Echo] menu. The message "Complete" appears after the copying is completed.	
[Gain Mode]	[Auto]: Automatic gain adjustment according to noise level [Manual]: Manual gain adjustment	1.9
[Manual Gain]	Copy the current position of the GAIN knob when you do [Copy]. This item is for read-only.	
[Sea Mode]	[Auto]: Automatic sea clutter adjustment according to sea state [Manual]: Manual sea clutter adjustment	1.10
[Auto Sea]	[Coastal]: Suppress both land and sea clutter. [Advanced]: Automatically discriminate land echoes from sea reflections to suppress only sea reflections.	1.10
[Manual Sea]	Copy the current position of the A/C SEA knob when you do [Copy]. This item is for read-only.	
[Rain Mode]	[Auto]: Automatic rain clutter adjustment according to rain cloud [Manual]: Manual rain clutter adjustment	1.11
[Auto Rain]	[Calm]: For light rain [Moderate]: When you can not reduce the rain clutter with [Calm] mode [Rough]: For heavy rain	1.11
[Manual Rain]	Copy the current position of the A/C RAIN knob when you do [Copy]. This item is for read-only.	
[A/C Auto]	[Off], [On]	1.12