

4. AIS OPERATION

4. Use the Cursorpad (▲) to select [Yes] and press the **ENTER** key. All lost targets symbols are erased from the screen and the long beep sounds.
5. Press the **MENU** key to close the menu.

4.15 Symbol Color

You can select the AIS symbol color among Green, Red (unavailable in the [IEC] or [Russian-River] purpose), Blue, White or Black.

1. Press the **MENU** key to open the menu.
2. Use the Cursorpad (▲ or ▼) to select [AIS] and press the **ENTER** key.
3. Use the Cursorpad (▲ or ▼) to select [Color] and press the **ENTER** key.



Color options

4. Use the Cursorpad (▲ or ▼) to select the color and press the **ENTER** key.
5. Press the **MENU** key to close the menu.

Note: Symbols can not be shown in the same color as the background color.

4.16 How to Ignore Slow Targets

You can prevent activation of the CPA/TCPA alarm against AIS targets that are traveling at a speed lower than set here. The AIS symbols are not affected by this setting.

1. Press the **MENU** key to open the menu.
2. Use the Cursorpad (▲ or ▼) to select [AIS] and press the **ENTER** key.
3. Use the Cursorpad (▲ or ▼) to select [Ignore Slow Targets] and press the **ENTER** key.

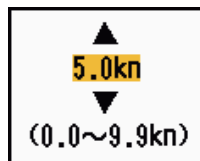

Ignore Slow Targets setting window

4. Use the Cursorpad (▲ or ▼) to select speed (0.0 - 9.9 kn) and press the **ENTER** key.
5. Press the **MENU** key to close the menu.

5. GPS OPERATION

If the FURUNO GPS Navigator GP-320B is connected to this radar, you can set GP-320B from this radar.

5.1 Navigator Mode

1. Press the **MENU** key to open the menu.
2. Use the Cursorpad (▲ or ▼) to select [GPS] and press the **ENTER** key.
3. Use the Cursorpad (▲ or ▼) to select [Mode] and press the **ENTER** key.



Mode options

4. Use the Cursorpad (▲ or ▼) to select [GPS] or [WAAS] then press the **ENTER** key.
5. Press the **MENU** key to close the menu.

5.2 Datum

Select the type of datum which matches the paper charts you use for navigation. Select [WGS-84] if the radar is connected to an AIS Transponder.

1. Press the **MENU** key to open the menu.
2. Use the Cursorpad (▲ or ▼) to select [GPS] and press the **ENTER** key.
3. Use the Cursorpad (▲ or ▼) to select [Datum] and press the **ENTER** key.



Datum options

4. Use the Cursorpad (▲ or ▼) to select the type of datum and press the **ENTER** key. If you select [WGS-84] or [Tokyo], go to step 7. If you select [Other], go to the next step.
5. Use the Cursorpad (▲ or ▼) to select [Datum No] and press the **ENTER** key.



Datum No setting window

6. Use the Cursorpad (▲ or ▼) to select the datum number and press the **ENTER** key. (The setting range is 001 - 192 and 201 - 254. Refer to the appendix 2 "GEO-DETTIC CHART LIST".)
7. Press the **MENU** key to close the menu.

5.3 WAAS Setup

Geostationary satellites, the type used with WAAS, provide more accurate position data when compared to GPS. These satellites can be tracked automatically or manually. Auto tracking automatically searches for the best geostationary satellite from your current position.

1. Press the **MENU** key to open the menu.
2. Use the Cursorpad (▲ or ▼) to select [GPS] and press the **ENTER** key.
3. Use the Cursorpad (▲ or ▼) to select [WAAS] and press the **ENTER** key.



WAAS options

4. Use the Cursorpad (▲ or ▼) to select [Auto] or [Manual] then press the **ENTER** key. If you select [Auto], go to step 7. If you select [Manual], go to the next step.
5. Use the Cursorpad (▲ or ▼) to select [WAAS No] and press the **ENTER** key.



WAAS No setting window

6. Use the Cursorpad (▲ or ▼) to select WAAS number and press the **ENTER** key. (The setting range is 120 - 158. Refer to the following table.)
7. Press the **MENU** key to close the menu.

Provider	Satellite type	Longitude	Satellite No.
WAAS	Inmarsat-3-F4 (AOR-W)	142°W	122
	Inmarsat-3-F3 (POR)	178°E	134
	Intelsat Galaxy XV	133°W	135
	TeleSat Anik F1R	107.3°W	138
EGNOS	Inmarsat-3-F2 (AOR-E)	15.5°W	120
	Artemis	21.5°E	124
	Inmarsat-3-F5 (IOR-W)	25°E	126
MSAS	MTSAT-1R	140°E	129
	MTSAT-2	145°E	137

5.4 Satellite Monitor

The Satellite Monitor provides the information about GPS and WAAS satellites. See your GPS navigator's owner's manual for detailed information.

1. Press the **MENU** key to open the menu.
2. Use the Cursorpad (**▲** or **▼**) to select [GPS] and press the **ENTER** key.
3. Use the Cursorpad (**▲** or **▼**) to select [Satellite Monitor] and press the **ENTER** key.

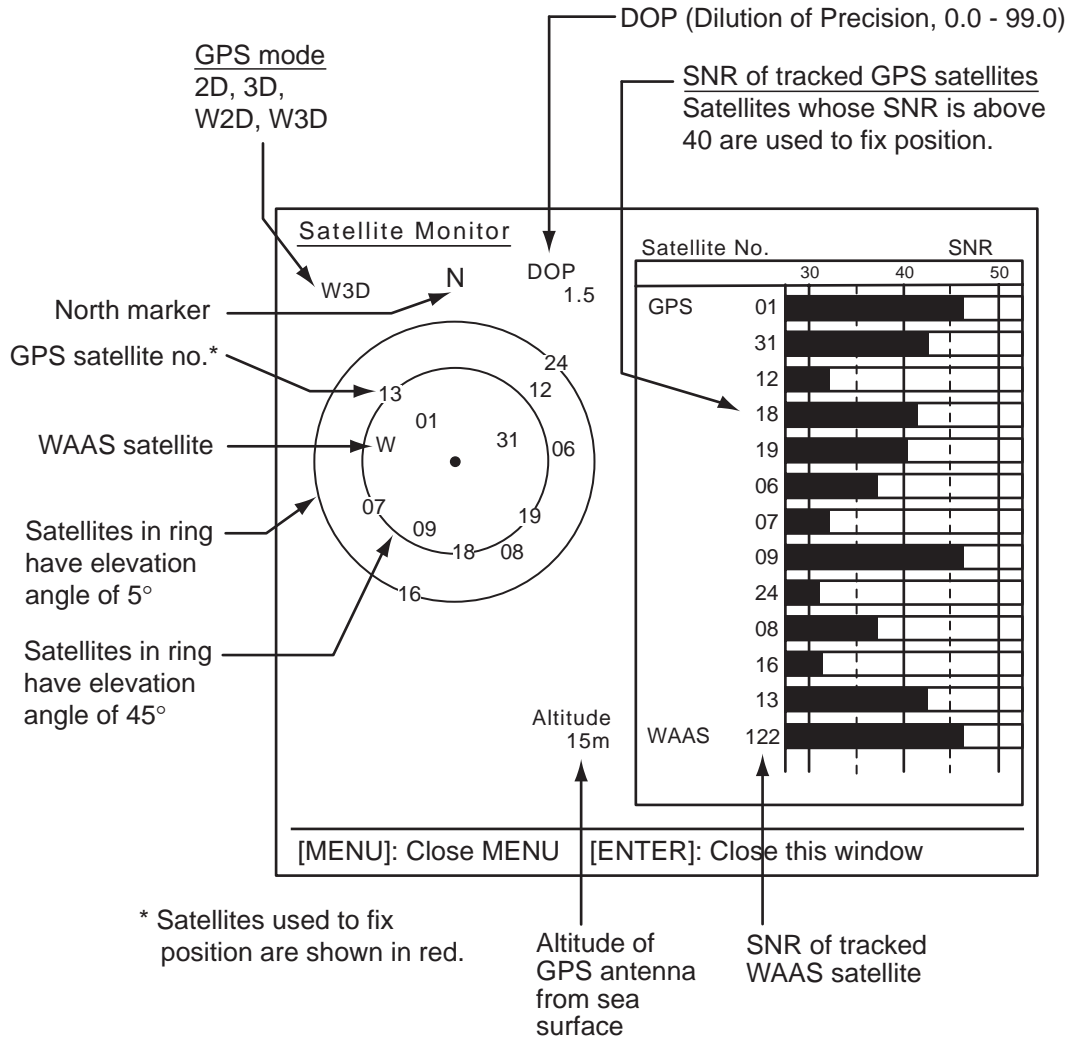

Satellite monitor

4. Press the **ENTER** key to close only the satellite monitor display.

5.5 Cold Start

Cold start, which clears the Almanac from the GPS receiver, can be necessary in the following conditions:

- If you have turned off the power of the GPS receiver for a long time.
- The ship has moved far away from the previous fixing position (e.g., more than 500 km).
- Other reason that prevents the receiver from finding its position within five minutes after you turn on the power.

To do cold start, do the following:

1. Press the **MENU** key to open the menu.
2. Use the Cursorpad (▲ or ▼) to select [GPS] and press the **ENTER** key.
3. Use the Cursorpad (▲ or ▼) to select [Cold Start] and press the **ENTER** key.

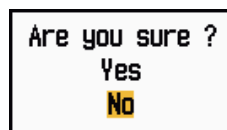





Cold Start options

4. Use the Cursorpad (▲) to select [Yes] and press the **ENTER** key. After processing cold start, the long beep sounds. (To stop cold start, press the **CANCEL/HL OFF** key instead of the **ENTER** key.)
5. Press the **MENU** key to close the menu.

6. MAINTENANCE, TROUBLE-SHOOTING

This chapter has information about maintenance and troubleshooting that the user can follow to care for the equipment.

 WARNING	
	ELECTRICAL SHOCK HAZARD Do not open the equipment. Only qualified personnel can work inside the equipment.
	Turn off the power before you service the antenna unit. Post a warning sign near the power switch not to turn on the power while you service the antenna unit.
	Prevent the potential risk of being struck by the rotating antenna and exposure to RF radiation hazard.
	When you work on the antenna unit, wear a safety belt and hard hat. Serious injury or death can result if a person falls from the radar antenna mast.

NOTICE
Do not apply paint, anti-corrosive sealant or contact spray to plastic parts or equipment coating. Those items contain products that can damage plastic parts and equipment coating.

6.1 Preventive Maintenance

Regular maintenance helps keep your equipment in good condition and prevents future problems. Check the items shown in the table below to help keep your equipment in good condition for years to come.

Maintenance

Interval	Item	Check point	Remedy
When necessary	LCD	Dust on the LCD	Remove the dust from the LCD with the tissue paper and an LCD cleaner. To remove dirt or salt, use the LCD cleaner. Change the tissue paper often so as not to scratch the LCD.
3 to 6 months	Ground terminal on display unit	Check for tight connection and rust.	Tighten or replace as necessary.
	Display unit connectors	Check for tight connection.	Tighten if the connectors are loosened.
	Exposed nuts and bolts on the antenna unit	Check for corroded or loosened bolts.	Clean and repaint as necessary. Use sealing compound instead of paint.
	Antenna radiator	Check for dirt and cracks on the radiator surface.	Clean radiator surface with fresh-water-moistened cloth. Do not use plastic solvents to clean.

6.2 Fuse Replacement

The fuse on the power cable protects the equipment from overcurrent and equipment fault. If the fuse blows, find the cause before you replace the fuse. Use the correct fuse. A wrong fuse can damage the equipment.

WARNING

Use the correct fuse.

A wrong fuse can damage the equipment and cause fire.

Unit	Type	Code No.	Remarks
Display unit (fitted on power cable)	FGB0 125V 10A PBF	000-155-826-10	12 VDC
	FGB0-A 125V 5A PBF	000-155-853-10	24 VDC

6.3 Magnetron Life

When the life of the magnetron is reached, the targets do not appear on the display. If long-range performance appears to have decreased, contact a FURUNO agent or dealer about replacement of the magnetron.

Model	Magnetron type	Code No.	Estimated life
MODEL 1937	E3571	001-087-300	Approx. 2,000 hours

6.4 LCD Backlight Life

The life of the LCD backlight, which provides illumination for the LCD, is approximately 4,800 hours at 25°C (ambient temperature). The display brilliance cannot be raised when the backlight has worn out. When brilliance cannot be raised, have a qualified technician replace the backlight.

Name	Type	Code No.
Lamp holder complete set	104LHS46	000-160-949-10

6.5 Simple Troubleshooting

This section provides simple troubleshooting procedures which the user can follow to restore normal operation. If you cannot restore normal operation, do not check inside the unit. Have a qualified technician check the equipment.

Simple troubleshooting

Problem	Remedy
You cannot turn on the power.	<ul style="list-style-type: none"> • Check for blown fuse. • Check that the power connector is fastened. • Check for corrosion on the power cable connector. • Check for damaged power cable. • Check battery for correct voltage output.
There is no response when a key is pressed.	Turn off and on the power. If you do not get a response, the key is damaged. Contact your dealer for instructions.
The power is on and you operated the STBY/TX key to transmit. The marks and letters appear, but no echo appears.	Check that the antenna cable is fastened.
Tuning is correctly adjusted, but sensitivity is poor.	Replace the magnetron. Contact your dealer.
The range is changed, but radar picture does not change.	<ul style="list-style-type: none"> • Try to hit the RANGE key again. • Turn off and on the display unit.
Poor discrimination in range because of many echoes from the waves.	Adjust A/C SEA control.
The true motion presentation is not working correctly.	<ul style="list-style-type: none"> • Check that the setting of [Display Mode] in the [Display] menu is set to [True Motion]. • Check if the heading and position data are input and correct.
The range rings are not displayed.	Check that the setting of [Rings Brill] in the [Brill/Color] menu is set to other than [Off].
Target is not tracked correctly because of sea clutter.	Adjust A/C SEA and A/C RAIN controls.

6.6 Advanced-level Troubleshooting

This section describes how to cure hardware and software troubles which the qualified service persons must do.

Advanced-level troubleshooting

Problem	Probable cause or check points	Remedy
Power cannot be turned on.	1) Mains voltage/polarity 2) Power supply board	1) Correct the wiring and input voltage. 2) Replace power supply board.
Brilliance adjusted but no picture.	1) SPU Board	1) Replace SPU board.
Antenna not rotating.	1) Antenna drive mechanism	1) Replace the antenna drive mechanism.
Data and marks not displayed in transmit.	1) SPU board	1) Replace SPU board.
Set GAIN to maximum with A/C SEA set at minimum. Marks and indications appear but no noise or echo.	1) Signal cable between antenna and display unit 2) IF amplifier 3) Video amplifier board	1) Check continuity and isolation of coaxial cable. 2) Replace IF amplifier. 3) Check coax line for fasten connection. If connection is good, replace SPU board.
Marks, indications and noise appear but no echo. (Transmission leak representing your ship position is absent.)	1) Magnetron 2) Modulator board 3) SPU board	1) Check magnetron current. 2) Replace modulator board. 3) Replace SPU board.
Picture not updated or picture freeze-up.	1) Bearing signal generator 2) SPU board 3) Video freeze-up	1) Check that signal cables are fastened. 2) Replace SPU board. 3) Turn off and on the radar.

6. MAINTENANCE, TROUBLESHOOTING

Problem	Probable cause or check points	Remedy
Radar is correctly tuned but sensitivity is poor.	1) [2nd Echo Rejector] is [On] 2) Dirt on radiator face 3) Deteriorated magnetron 4) Detuned MIC	1) Turn off the [2nd Echo Rejector], from the [Echo] menu. 2) Clean radiator. 3) Check the magnetron current with the radar transmitting on 48 nm range. If the current is below normal, magnetron may be defective. Replace the magnetron. 4) Check MIC detecting current. If MIC detecting current is below normal value, MIC may have become detuned.
Range changed but radar picture does not change.	1) RANGE key has faults 2) SPU board 3) Video freeze-up	1) Try to operate the RANGE key. If you can not operate the RANGE key, replace the keypad. 2) Replace SPU board. 3) Turn off and on radar.
Range rings are not displayed.	1) Adjust their brilliance on the [Brill/Color] menu. 2) SPU Board	1) Replace associated circuit board if unsuccessful. 2) Replace SPU Board.

6.7 Diagnostic Test

The diagnostic test checks the system for correct operation. This test is for use by service technicians, but the user can do this test to provide the service technician with information.

1. Press the **MENU** key to open the menu.
2. Use the Cursorpad (▲ or ▼) to select [Tests] and press the **ENTER** key.
3. Use the Cursorpad (▲ or ▼) to select [Self Test] and press the **ENTER** key.

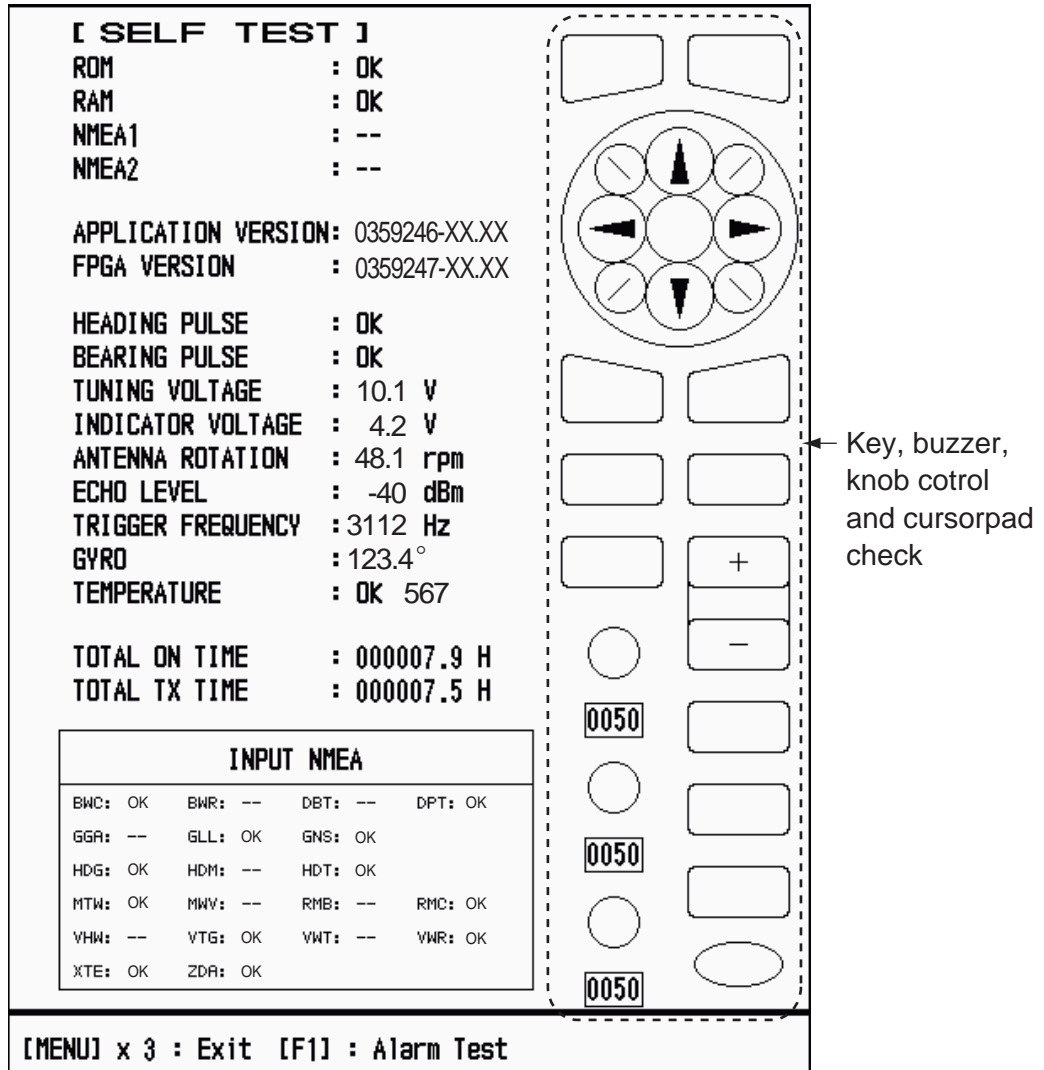

XX: Program version no.

Self Test screen

Test results

- ROM, RAM: The results of the ROM and RAM test are displayed as OK or NG (No Good).
- NMEA1, NMEA2: The results of the ports NMEA1 and NMEA2 are displayed as OK or "-". Ports NMEA1 and NMEA2 require a special connector to test them. When a special connector is not connected, "-" is shown. If "-" is displayed with a special connector, contact your dealer for instruction.
- APPLICATION VERSION, FPGA VERSION: The program numbers and program version numbers (XX) are displayed.

6. MAINTENANCE, TROUBLESHOOTING

- **HEADING PULSE, BEARING PULSE:** The results of the pulse input are displayed as OK or NG. When [Antenna Rotation] is set to [Stop], or [Watchman] is set to [Off] in the STBY mode, this test is skipped and "- -" is shown for both heading and bearing.
- **TUNING VOLTAGE, INDICATOR VOLTAGE, ANTENNA ROTATION, ECHO LEVEL, TRIGGER FREQUENCY:** The results of measurement are displayed.
- **GYRO:** The current gyrocompass reading is displayed.
- **TEMPERATURE:** The result of the temperature test is displayed as OK or NG and the temperature is measured and shown.
- **TOTAL ON TIME, TOTAL TX TIME:** The total number of hours, for which the radar has been powered and transmitted, are displayed.
- **INPUT NMEA window:** The condition of all the NMEA sentences being input to this radar are displayed as OK or "- -". "- -" means no data input. Sentences are updated every second.

Key check

Press each key one by one. A key's on-screen location becomes green if the key is normal.

Buzzer check

The **F1** key tests on/off for the panel buzzer or external buzzer. To stop the buzzer, press the **F1** key again.

Knob control check

Rotate each control knob. The four digits below the on-screen location for the **GAIN**, **A/C SEA** and **A/C RAIN** knob controls show the control position. Press each knob. The knob corresponding on-screen circle changes in green if the knob is normal.

Cursorpad check

Press each arrow and diagonal dot one by one. The on-screen location changes in green if the key is normal.

4. Press the **MENU** key three times to escape from the test.
5. Press the **MENU** key to close the menu.

6.8 LCD Test

1. Press the **MENU** key to open the menu.
2. Use the Cursorpad (▲ or ▼) to select [Tests] and press the **ENTER** key.
3. Use the Cursorpad (▲ or ▼) to select [LCD Pattern] and press the **ENTER** key.

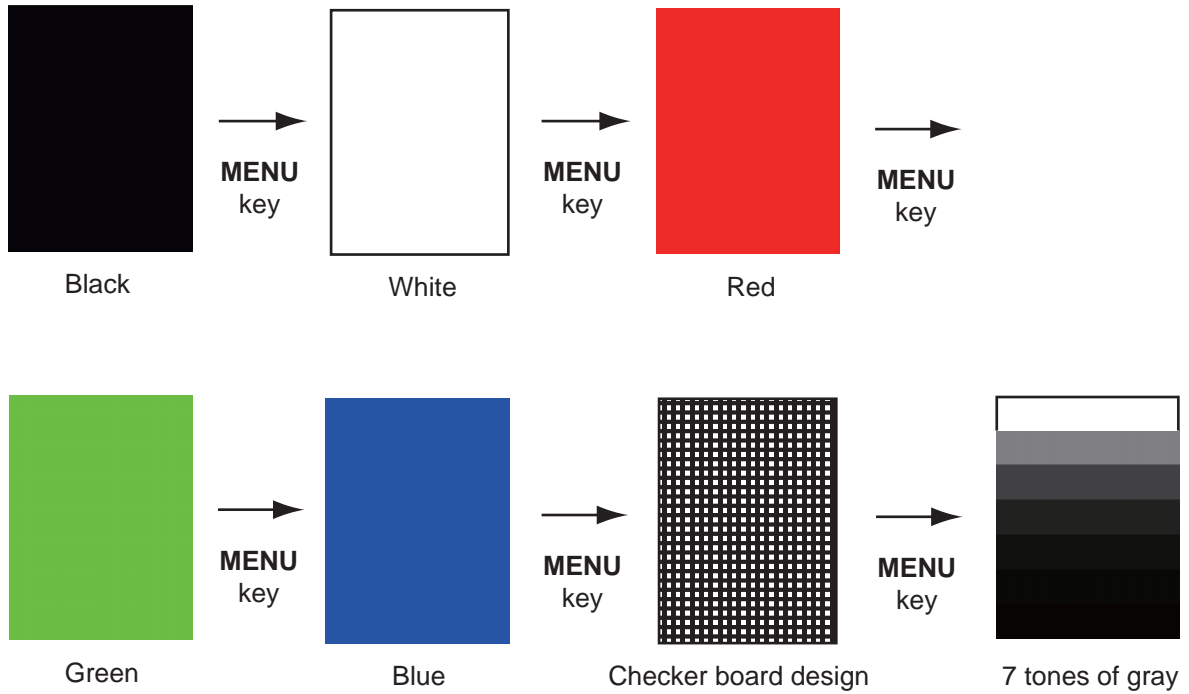

4. Press the **MENU** key several times to close the menu.

Note 1: You can cancel the test at any time when you press the **CANCEL/HL OFF** key.

Note 2: You can adjust the screen brilliance with the  key during the test.

6.9 ARPA Test

If the optional ARPA board is installed, its program number and test results (OK or NG) are shown on the screen. [ARPA Test] menu item is inoperative with no ARPA board. The radar must be transmitting to test ARPA function.

1. Press the **MENU** key to open the menu.
2. Use the Cursorpad (▲ or ▼) to select [Tests] and press the **ENTER** key.
3. Use the Cursorpad (▲ or ▼) to select [ARPA Test] and press the **ENTER** key.

[ARPA TEST]			
ROM	:	OK	
RAM	:	OK	
ARPA VERSION	:	1859127XXX	
SPEED	:	OK	12.3KN
COURSE	:	OK	287.6°
TRIGGER	:	OK	
VIDEO	:	OK	
BEARING PULSE	:	OK	
HEADING PULSE	:	OK	
MIN-HIT	:	0012	
SCAN-TIME	:	0250	
MANUAL-ACQ	:	03	
AUTO-ACQ	:	05	
FE-DATA1	:	0217	
FE-DATA2	:	0023	
ECHO NUMBER			
[No. 1]	0123	[No. 2]	0321
[No. 3]	0084	[No. 4]	0234
[No. 5]	0110	[No. 6]	0219
[No. 7]	0073	[No. 8]	0145
[MENU] x 3 : Exit			

XXX: Program version no.

ARPA test

4. Press the **MENU** key three times to close the menu.

6.10 GPS Test

You can check the FURUNO GPS receiver GP-320B interfaced with this radar for correct operation as follows:

1. Press the **MENU** key to open the menu.
2. Use the Cursorpad (▲ or ▼) to select [GPS] and press the **ENTER** key.
3. Use the Cursorpad (▲ or ▼) to select [Self Test] and press the **ENTER** key. The program no. and result of the test are shown, as OK or NG (No Good). When NG appears, check the GPS receiver.

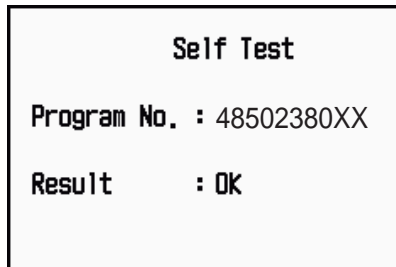

XX: Program version no. varies according to equipment connected.

GPS-Self Test screen

4. Press any key to close the test screen.
5. Press the **MENU** key to close the menu.

6. MAINTENANCE, TROUBLESHOOTING

This page is intentionally left blank.

APPENDIX 1 MENU TREE

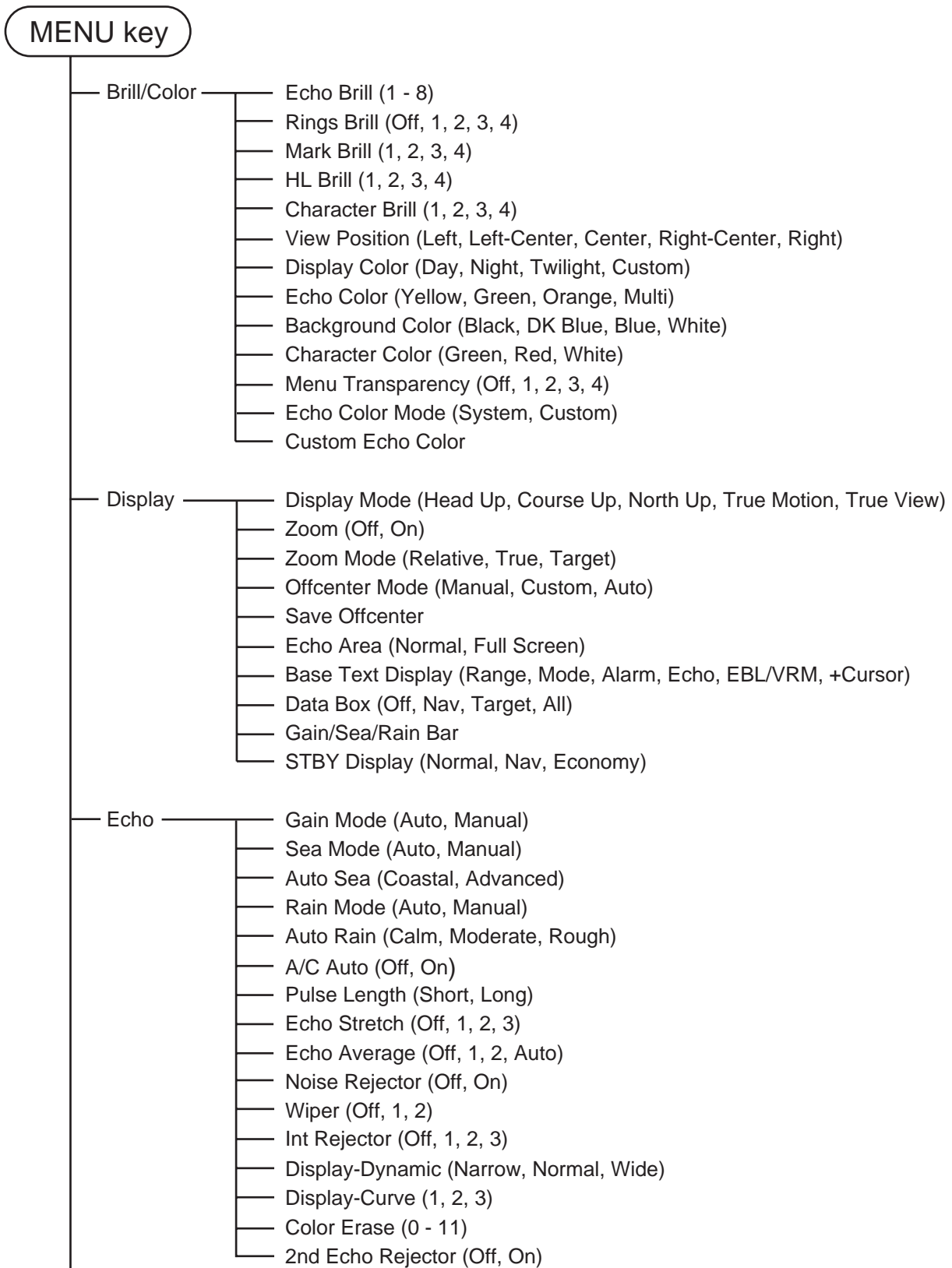

(Continued on next Page)

APPENDIX 1 MENU TREE

(Continued from previous page)

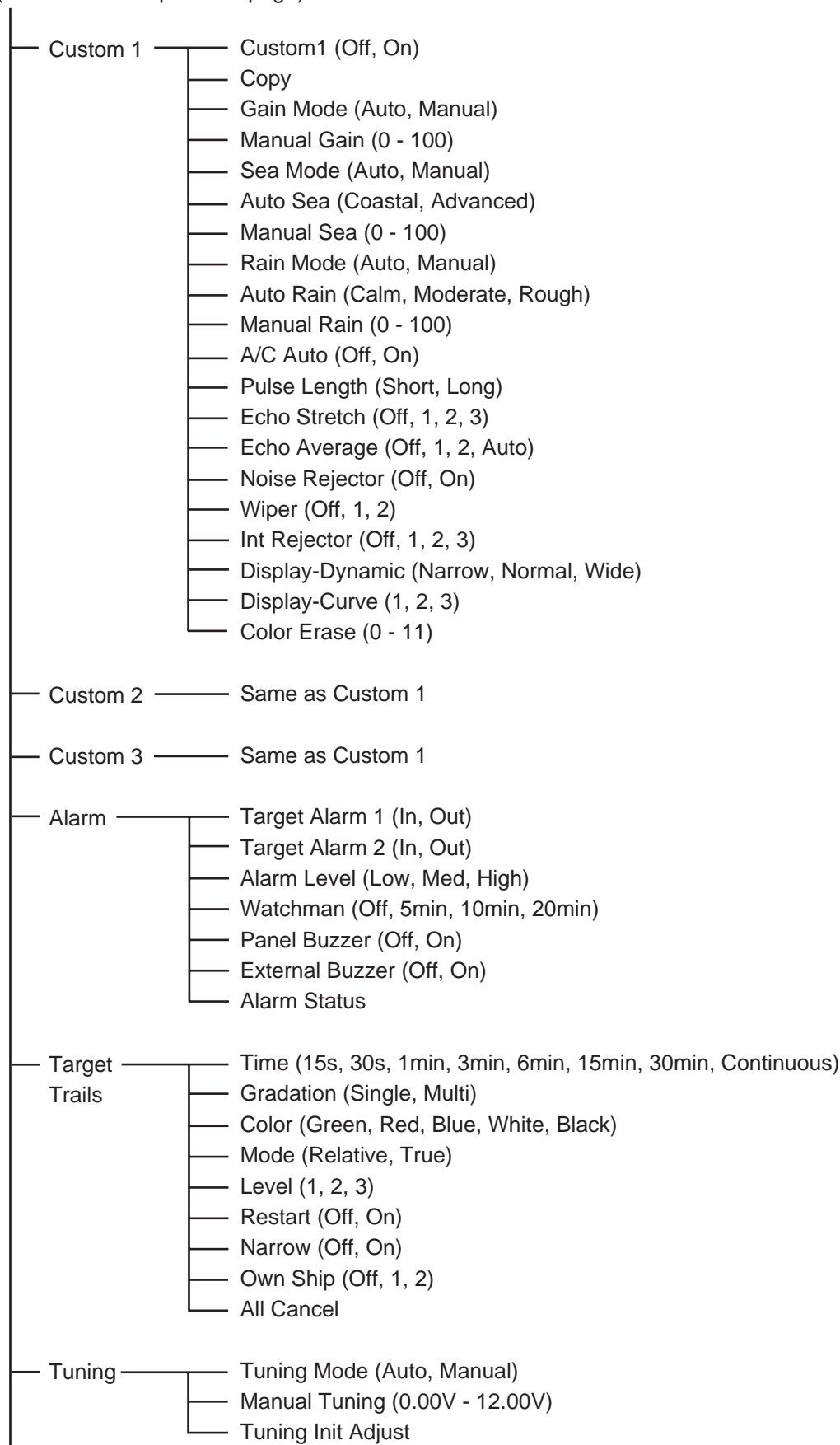

(Continued on next page)

(Continued from previous page)

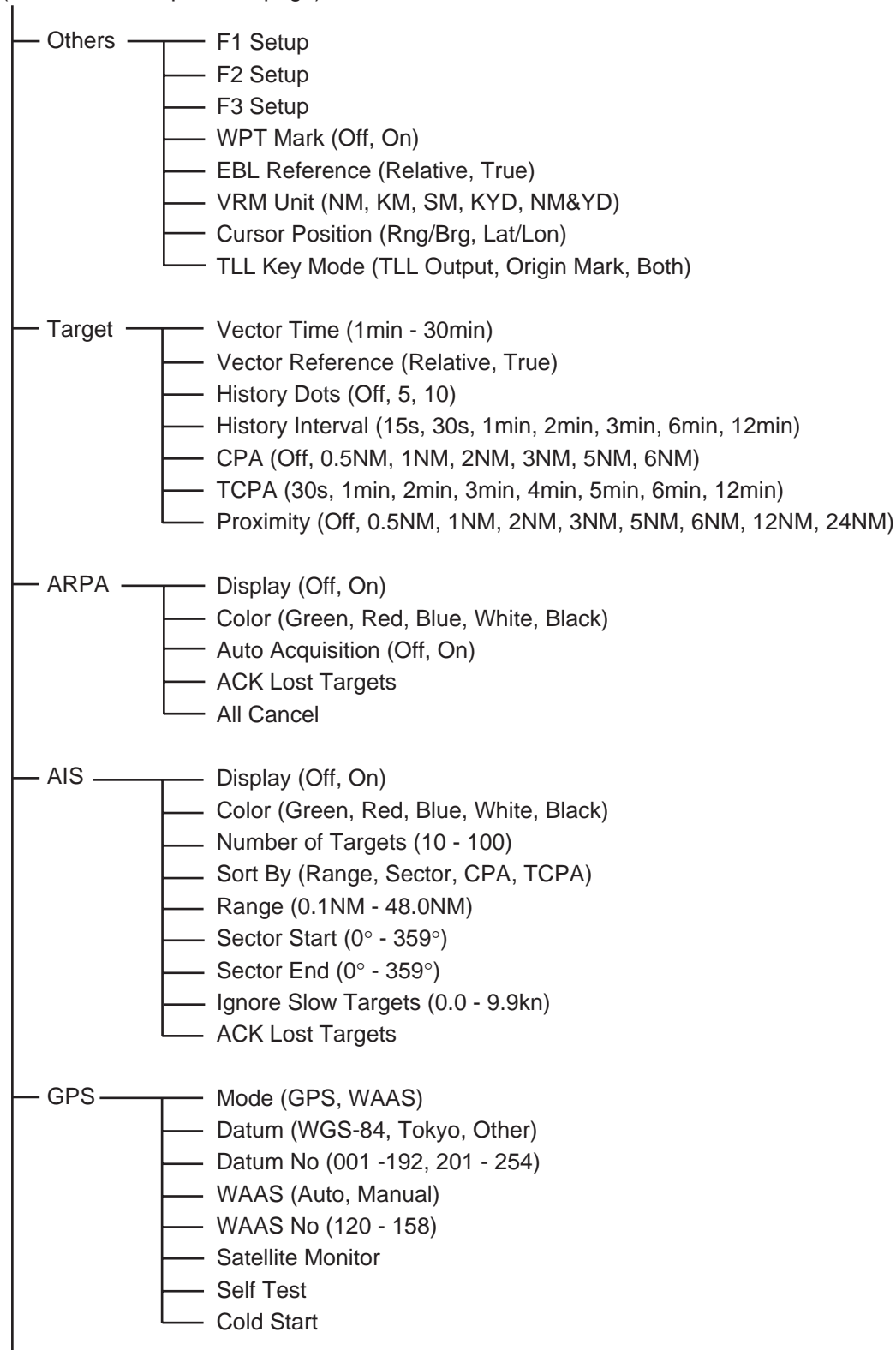

(Continued on next page)

APPENDIX 1 MENU TREE

(Continued from previous page)

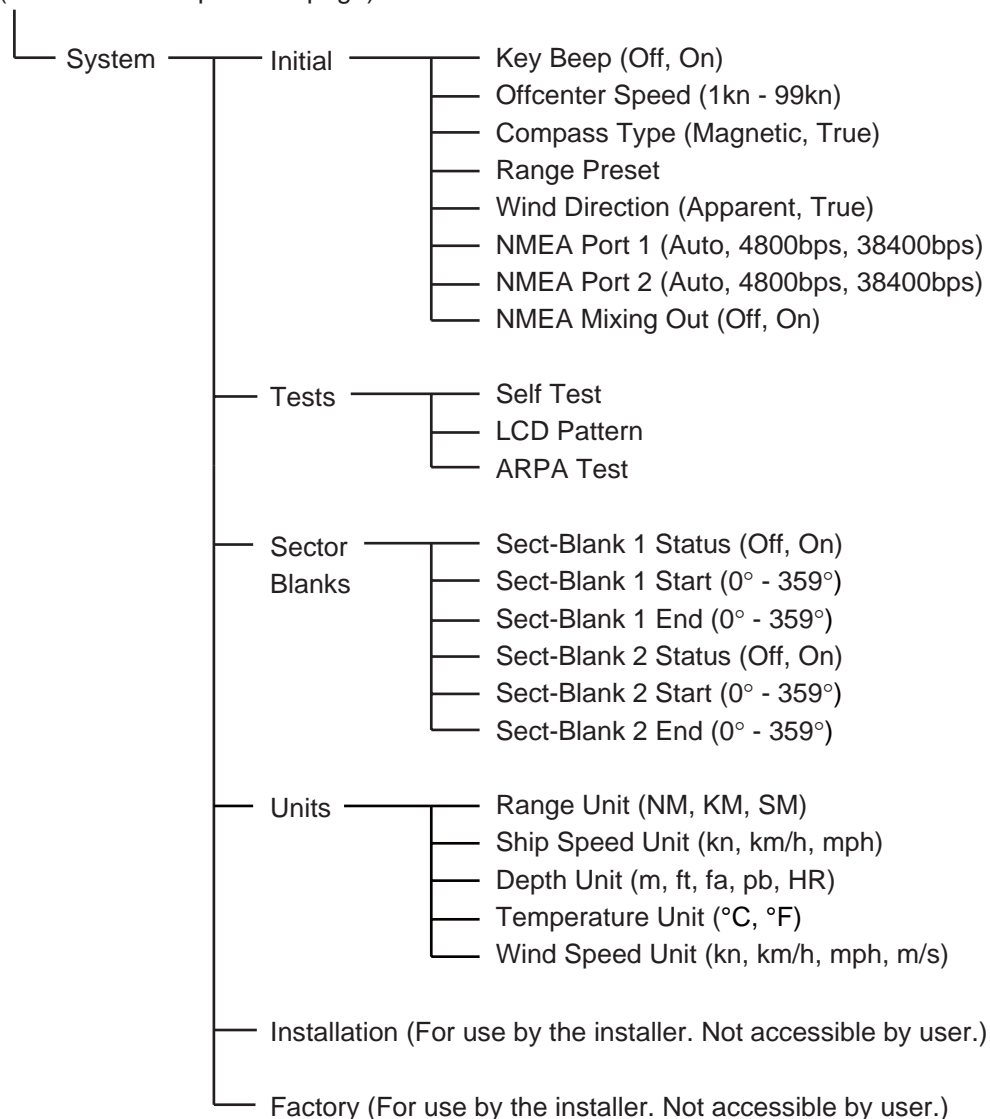

APPENDIX 2 GEODETIC CHART LIST

001: WGS84		
002: WGS72		
003: TOKYO		
004: NORTH AMERICAN 1927	: Mean Value (Japan, Korea & Okinawa)	
005: EUROPEAN 1950	: Mean Value (CONUS)	
006: AUSTRALIAN GEODETIC 1984	: Mean Value	
007: ADINDAN-MN	: Australia & Tasmania	
008: ADINDAN-E	: Mean Value (Ethiopia & Sudan)	
009: ADINDAN-MA	: Ethiopia	
010: ADINDAN-SE	: Mali	
011: ADINDAN-SU	: Senegal	
012: AFG	: Sudan	
013: AIN EL ABD 1970	: Somalia	
014: ANNA 1 ASTRO 1965	: Bahrain Is.	
015: ARC 1950-MN	: Cocos Is.	
016: ARC 1950-B	: Mean Value	
017: ARC 1950-L	: Botswana	
018: ARC 1950-M	: Lesotho	
019: ARC 1950-S	: Malawi	
020: ARC 1950-ZR	: Swaziland	
021: ARC 1950-ZM	: Zaire	
022: ARC 1950-ZB	: Zambia	
023: ARC 1960-MN	: Zimbabwe	
024: ARC 1960-K	: Mean Value (Kenya & Tanzania)	
025: ARC 1960-T	: Kenya	
026: ASCENSION IS. 1958	: Tanzania	
027: ASTRO BEACON "E"	: Ascension Is.	
028: ASTRO B4 SOR. ATOLL	: Iwo Jima Is.	
029: ASTRO POS 71/4	: Tern Is.	
030: ASTRONOMIC STATION 1952	: St. Helena Is.	
031: AUSTRALIAN GEODETIC 1966	: Marcus Is.	
032: BELLEVUE (IGN)	: Australia & Tasmania	
033: BERMUDA 1957	: Efate & Erromango Is.	
034: BOGOTA OBSERVATORY	: Bermuda Is.	
035: CAMPO INCHAUSPE	: Columbia	
036: CANTON IS. 1966	: Argentina	
037: CAPE	: Phoenix Is.	
038: CAPE CANAVERAL	: South Africa	
039: CARTHAGE	: Mean Value (Florida & Bahama Is.)	
040: CHATHAM 1971	: Tunisia	
041: CHUA ASTRO	: Chatham Is. (New Zealand)	
042: CORREGO ALEGRE	: Paraguay	
043: DJAKARTA (BATAVIA)	: Brazil	
044: DOS 1968	: Sumatra Is. (Indonesia)	
045: EASTER IS. 1967	: Gizo Is. (New Georgia Is.)	
046: EUROPEAN 1950-W	: Easter Is.	
047: EUROPEAN 1950-CY	: Western Europe	
048: EUROPEAN 1950-EG	: Cyprus	
049: EUROPEAN 1950-ESC	: Egypt	
050: EUROPEAN 1950-EIS	: England, Scotland, Channel & Shetland Is.	
051: EUROPEAN 1950-GR	: England, Ireland, Scotland & Shetland Is.	
052: EUROPEAN 1950-IR	: Greece	
053: EUROPEAN 1950-SA	: Italy, Sardinia	
054: EUROPEAN 1950-SI	: Italy, Sicily	
055: EUROPEAN 1950-NF	: Norway & Finland	
056: EUROPEAN 1950-PS	: Portugal & Spain	
057: EUROPEAN 1979	: Mean Value	
058: GANDAJIKA BASE	: Republic of Maldives	
059: GEODETIC DATUM 1949	: New Zealand	
060: GUAM 1963	: Guam Is.	
061: GUX 1 ASTRO	: Guadalcanal Is.	
062: HJORSEY 1955	: Iceland	
063: HONG KONG 1963	: Hong Kong	
064: INDIAN-TV	: Thailand & Vietnam	
065: INDIAN-BIN	: Bangladesh, India & Nepal	
066: IRELAND 1965	: Ireland	
067: ISTS 073 ASTRO 1969	: Diego Garcia	
068: JOHNSTON IS. 1961	: Johnston Is.	
069: KANDAWALA	: Sri Lanka	
070: KERGUELEN IS.	: Kerguelen Is.	
071: KERTAUI 1948	: West Malaysia & Singapore	
072: LA REUNION	: Mascarene Is.	
073: L. C. 5 ASTRO	: Cayman Brac Is.	
074: LIBERIA 1964	: Liberia	
075: LUZON	: Philippines (excl. Mindanao Is.)	
076: LUZON-M	: Mindanao Is.	
077: MAHE 1971	: Mahe Is.	
078: MARCO ASTRO	: Salvage Islands	
079: MASSAWA	: Eritrea (Ethiopia)	
080: MERCHICH	: Morocco	
081: MIDWAY ASTRO 1961	: Midway Is.	
082: MINNA	: Nigeria	
083: NAHRWAN-O	: Masirah Is. (Oman)	
084: NAHRWAN-UAE	: United Arab Emirates	
085: NAHRWAN-SA	: Saudi Arabia	
086: NAMIBIA	: Namibia	
087: MAPARIMA, BWI	: Trinidad & Tobago	
088: NORTH AMERICAN 1927WU	: Western United States	
089: NORTH AMERICAN 1927EU	: Eastern United States	
090: NORTH AMERICAN 1927AK	: Alaska	
091: NORTH AMERICAN 1927BH	: Bahamas (excl. San Salvador Is.)	
092: NORTH AMERICAN 1927SS	: Bahamas, San Salvador Is.	
093: NORTH AMERICAN 1927CN	: Canada (incl. Newfoundland Is.)	
094: NORTH AMERICAN 1927AB	: Alberta & British Columbia	
095: NORTH AMERICAN 1927EC	: East Canada	
096: NORTH AMERICAN 1927MO	: Manitoba & Ontario	
097: NORTH AMERICAN 1927NE	: Northwest Territories & Saskatchewan	
098: NORTH AMERICAN 1927YK	: Yukon	
099: NORTH AMERICAN 1927CZ	: Canal Zone	
100: NORTH AMERICAN 1927CR	: Caribbean	
101: NORTH AMERICAN 1927CA	: Central America	
102: NORTH AMERICAN 1927CU	: Cuba	
103: NORTH AMERICAN 1927GR	: Greenland	
104: NORTH AMERICAN 1927MX	: Mexico	
105: NORTH AMERICAN 1983AK	: Alaska	
106: NORTH AMERICAN 1983CN	: Canada	
107: NORTH AMERICAN 1983CS	: CONUS	
108: NORTH AMERICAN 1983MX	: Mexico, Central America	
109: OBSERVATORIO 1966	: Corvo & Flores Is. (Azores)	
110: OLD EGYPTIAN 1930	: Egypt	
111: OLD HAWAIIAN-MN	: Mean Value	
112: OLD HAWAIIAN-HW	: Hawaii	
113: OLD HAWAIIAN-KA	: Kauai	
114: OLD HAWAIIAN-MA	: Maui	
115: OLD HAWAIIAN-OA	: Oahu	
116: OMAN	: Oman	
117: ORDNANCE SURVEY OF GREAT BRITAIN 1936-NM	: Mean Value	
118: ORDNANCE SURVEY OF GREAT BRITAIN 1936-E	: England	
119: ORDNANCE SURVEY OF GREAT BRITAIN 1936-IM	: England, Isle of Man & Wales	
120: ORDNANCE SURVEY OF GREAT BRITAIN 1936-SSI	: Scotland & Shetland Is.	
121: ORDNANCE SURVEY OF GREAT BRITAIN 1936-WL	: Wales	
122: PICO DE LAS NIVIES	: Canary Is.	
123: PITCAIRN ASTRO 1967	: Pitcairn Is.	
124: PROVISIONS SOUTH CHILEAN 1963: South Chile (near 53°S)		
125: PROVISIONAL SOUTH AMERICAN 1956MN: Mean Value		
126: PROVISIONAL SOUTH AMERICAN 1956BO: Bolivia		
127: PROVISIONAL SOUTH AMERICAN 1956NC: Chile-Northern Chile (near 19°S)		
128: PROVISIONAL SOUTH AMERICAN 1956SC: Chile-Southern Chile (near 43°S)		
129: PROVISIONAL SOUTH AMERICAN 1956CO: Columbia		
130: PROVISIONAL SOUTH AMERICAN 1956EC: Ecuador		
131: PROVISIONAL SOUTH AMERICAN 1956GY: Guyana		
132: PROVISIONAL SOUTH AMERICAN 1956PR: Peru		
133: PROVISIONAL SOUTH AMERICAN 1956VN: Venezuela		
134: PUERTO RICO	: Puerto Rico & Virgin Is.	
135: QATAR NATIONAL	: Qatar	
136: QORNOQ	: South Greenland	
137: ROME 1940	: Sardinia Is.	
138: SANTA BRAZ	: Sao Miguel, Santa Maria Is. (Azores)	
139: SANTO (DOS)	: Espiritu Santo Is.	
140: SAPPER HILL 1943	: East Falkland Is.	
141: SOUTH AMERICAN 1969MN	: Mean Value	
142: SOUTH AMERICAN 1969AG	: Argentina	
143: SOUTH AMERICAN 1969BO	: Bolivia	
144: SOUTH AMERICAN 1969BR	: Brazil	
145: SOUTH AMERICAN 1969CH	: Chile	
146: SOUTH AMERICAN 1969CO	: Columbia	
147: SOUTH AMERICAN 1969EC	: Ecuador	
148: SOUTH AMERICAN 1969GY	: Guyana	
149: SOUTH AMERICAN 1969PA	: Paraguay	
150: SOUTH AMERICAN 1969PR	: Peru	
151: SOUTH AMERICAN 1969TT	: Trinidad & Tobago	
152: SOUTH AMERICAN 1969VZ	: Venezuela	
153: SOUTH ASIA	: Singapore	
154: SOUTHEAST BASE	: Porto Santo & Madeira Is.	
155: SOUTHWEST BASE	: Faial, Graciosa, Pico, Sao Jorge & Terceira Is.	
156: TIMBALAI 1948	: Brunei & East Malaysia (Sarawak & Sabah)	
157: TOKYO JP	: Japan	
158: TOKYO KP	: Korea	
159: TOKYO OK	: Okinawa	
160: TRISTAN ASTRO 1968	: Tristan da Cunha	
161: VITI LEVU 1916	: Viti Levu Is. (Fiji Is.)	
162: WAKE-ENIWETOK 1960	: Marshall Is.	
163: ZANDERIJ	: Surinam	
164: BUKIT RIMPAH	: Bangka & Belitung Is. (Indonesia)	
165: CAMP AREA ASTRO	: Camp Marmora Area, Antarctica	
166: G. SEGARA	: Kalimantan Is. (Indonesia)	
167: HERAT NORTH	: Afghanistan	
168: HU-TZU-SHAN	: Taiwan	
169: TANANARIVE OBSERVATORY 1925	: Madagascar	
170: YACARE	: Uruguay	
171: RT-90	: Sweden	
172: TOKYO	: Mean Value (Japan, Korea & Okinawa)	
173: AIN EL ABD 1970	: Bahrain Is.	
174: ARC 1960	: Mean Value (Kenya, Tanzania)	
175: ARS-A	: Kenya	

APPENDIX 2 GEODETIC CHART LIST

176: ARS-B	: Tanzania	221: INDIAN 1960	: Con Son Is. (Vietnam)
177: ASCENSION IS. 1958	: Ascension Is.	222: INDIAN 1975	: Thailand
178: CAPE CANAVERAL	: Mean Value (Florida & Bahama Is.)	223: INDONESIAN 1974	: Indonesia
179: EASTER IS. 1967	: Easter Is.	224: CO-ORDINATE SYSTEM 1937 OF ESTONIA	: Estonia
180: EUROPEAN 1950	: Portugal & Spain	225: EUROPEAN 1950	: Malta
181: JHONSTON IS. 1961	: Jhonston Is.	226: EUROPEAN 1950	: Tunisia
182: NAHRWAN	: Saudi Arabia	227: S-42 (PULKOVO 1942)	: Hungary
183: NAPARIMA, BWI	: Trinidad & Tobago	228: S-42 (PULKOVO 1942)	: Poland
184: NORTH AMERICAN 1927	: Caribbean	229: S-42 (PULKOVO 1942)	: Czechoslovakia
185: OLD HAWAIIAN	: Oahu	230: S-42 (PULKOVO 1942)	: Latvia
186: SAPPER HILL 1943	: East Falkland Is.	231: S-42 (PULKOVO 1942)	: Kazakhstan
187: TIMBALAI 1948	: Brunei & East Malaysia (Sarawak & Sabah)	232: S-42 (PULKOVO 1942)	: Albania
188: TOKYO	: Japan	233: S-42 (PULKOVO 1942)	: Romania
189: TOKYO	: South Korea	234: S-JTSK	: Czechoslovakia
190: TOKYO	: Okinawa	235: NORTH AMERICAN 1927	: East of 180W
191: WAKE-ENIWETOK 1960	: Marshall Is.	236: NORTH AMERICAN 1927	: West of 180W
192: HU-TZU-SHAN	: Taiwan	237: NORTH AMERICAN 1983	: Aleutian Is.
201: ADINDAN	: Burkina Faso	238: NORTH AMERICAN 1983	: Hawaii
202: ADINDAN	: Cameroon	239: SOUTH AMERICAN 1969	: Baltra, Galapagos Is.
203: ARC 1950	: Burundi	240: ANTIGUA IS. ASTRO 1943	: Antigua, Leeward Is.
204: AYABELLE LIGHTHOUSE	: Djibouti	241: DECEPTION IS.	: Deception Is., Antarctica
205: BISSAU	: Guinea-Bissau	242: FORT THOMAS 1955	: Nevis, St. Kitts, Leeward Is.
206: DABOLA	: Guinea	243: ISTS 061 ASTRO 1968	: South Georgia Is.
207: EUROPEAN 1950	: Tunisia	244: MONTSERRAT IS. ASTRO 1958	: Montserrat, Leeward Is.
208: LEIGON	: Ghana	245: FEUNION	: Mascarene Is.
209: MINNA	: Cameroon	246: AMERICAN SAMOA 1962	: American Samoa Is.
210: M' PORALOKO	: Gabon	247: INDONESIAN 1974	: Indonesia
211: NORTH SAHARA 1959	: Algeria	248: KUSAIE ASTRO 1951	: Caroline Is., Fed. States of Micronesia
212: POINT58	: Mean Solution (Burkina Faso & Niger)	249: WAKE Is. ASTRO 1952	: Wake Atoll
213: POINTE NOIRE 1948	: Congo	250: EUROPEAN 1950	: Iraq, Israel, Jordan, Kuwait, Lebanon, Saudi Arabia, and Syria
214: SIERRA LEONE 1960	: Sierra Leone	251: HERMANNSKOGEL	: Yugoslavia (Prior to 1990) Slovenia, Croatia Bosnia and Herzegovina Serbia
215: VOIROL 1960	: Algeria	252: INDIAN	: Pakistan
216: AIN EL ABD 1970	: Saudi Arabia	253: PULKOVO 1942	: Russia
217: INDIAN	: Bangladesh	254: VOIROL 1874	: Tunisia/Algeria
218: INDIAN	: India & Nepal		
219: INDIAN 1954	: Thailand		
220: INDIAN 1960	: Vietnam (near 16N)		

**SPECIFICATIONS OF MARINE RADAR
MODEL 1937**

1 GENERAL

1.1 Range scale, pulselength (PL) and Pulse repetition rate (PRR)

Range scale (NM)	PL (μs)	PRR (Hz approx.)
0.0625 to 1.6	0.06	2100
1.5 to 2	0.3	1200
3 to 48	0.8	600

- 1.2 Range discrimination 15 m
- 1.3 Minimum range 16 m
- 1.4 Bearing resolution 1.9°
- 1.5 Bearing accuracy ±1°
- 1.6 Range ring accuracy 0.9% of range in use or 8 m, whichever is greater

2 ANTENNA UNIT

- 2.1 Radiator type Slotted waveguide array
- 2.2 Radiator length 120 cm
- 2.3 Horizontal beamwidth 1.9°
- 2.4 Vertical beamwidth 22°
- 2.5 Sidelobe Within ±20° of main lobe: -24dB
Outside ±20° of main lobe: -30dB
- 2.6 Polarization Horizontal
- 2.7 Antenna rotation speed 48 rpm
- 2.8 Wind resistance Relative wind speed 70 kn

3 TRANSCEIVER MODULE (CONTAINED IN ANTENNA UNIT)

- 3.1 Radiation type P0N
- 3.2 Frequency 9410 MHz±30MHz
- 3.3 Peak output power 4 kW
- 3.4 Duplexer Circulator with diode limiter
- 3.5 Modulator switching FET
- 3.6 IF amplifier Log-amplifier
- 3.7 IF frequency 60 MHz
- 3.8 Tuning Automatic or manual
- 3.9 Warm-up time 90 s

4 DISPLAY UNIT

4.1 Screen type 10.4-inch color LCD, 640 (V) x 480 (H) dots, VGA

4.2 Effective radar diameter 158 mm

4.3 Range scales and Ring interval

Range scale (NM)	0.0625	0.125	0.25	0.5	0.75	1	1.5	1.6	2	3	3.2	4	6	8	12	16	24	32	36	48
Ring interval (NM)	0.03125	0.0625	0.125	0.125	0.25	0.25	0.5	0.4	0.5	1	0.8	1	2	2	3	4	6	8	12	12
Number of rings	2	2	2	4	3	4	3	4	4	3	4	4	3	4	4	4	4	4	3	4

4.4 Marks Heading line, Bearing scale, Range ring, Tuning indicator, Cursor, North mark, Variable range marker (VRM), Electric bearing line (EBL), Target alarm zone, Zoom window, Waypoint mark*, Origin mark*

4.5 Alphanumeric indication Range, Range ring interval, Pulselength (SP/MP/LP), Display mode (H UP/C UP/N UP/TM/TRU VIEW), Off-centre (OFFCENT (M/A/C)), Heading data*, Target trails, Tuning indicator, Target alarms, Echo stretch (ES), Echo average (EAV), Electric bearing line (EBL), Vector time*, Range and bearing to cursor or cursor position*, Interference rejecter (IR), Auto anti-clutter (A/C Auto), Variable range marker (VRM), Navigation data*(position, speed, course), ARPA/AIS target data*

*: external data required

5 INTERFACE

5.1 Heading signal AD-10 format or NMEA0183

5.2 NMEA 2 ports, NMEA0183 Ver-1.5/2.0/3.0

5.3 Remote display/ Ext. buzzer 1 port (option)

5.4 USB 1 port, USB2.0 for maintenance

5.5 Input data sentences BWC, BWR, DBT, DPT, GGA, GLL, GNS, HDG, HDT, HDM, MTW, MWV, RMB, RMC, VHW, VTG, VWR, VWT, XTE, ZDA

5.6 Output data sentences RSD, TLL, TTM

6 POWER SUPPLY

6.1 MODEL 1937 12-24 VDC: 8.1-3.8 A

6.2 Rectifier (RU-3423, option) 100/110/115/220/230 VAC, 1 phase, 50/60Hz

7 ENVIRONMENTAL CONDITION

7.1	Ambient temperature	
	Antenna unit	-25°C to +55°C
	Display unit	-15°C to +55°C
7.2	Relative humidity	93% at 40°C
7.3	Degree of protection	
	Antenna unit	IP26
	Display unit	IP55
7.4	Vibration	IEC 60945

8 COATING COLOR

8.1	Antenna unit	N9.5
8.2	Display unit	N2.5

9 COMPASS SAFE DISTANCE

9.1	Antenna unit	Standard: 1.00 m	Steering: 0.75 m
9.2	Display unit	Standard: 0.45 m	Steering: 0.30 m

This page is intentionally left blank.

INDEX

A

- A/C RAIN control 1-12
- A/C SEA control 1-11
- AIS
 - activating targets 4-2
 - controls for 4-1
 - display on/off 4-1
 - display range 4-4
 - sleeping targets 4-2
 - sorting targets 4-4
 - symbols 4-2
 - target data 4-3
- Alarm message 1-46
- Anti-clutter 1-13
- ARPA
 - acquiring targets 3-2
 - controls for 3-1
 - CPA/TCPA alarm 3-8, 4-8
 - display on/off 3-2
 - display sector 4-5
 - history display 3-6, 4-7
 - lost target 3-10, 4-9
 - number of targets 4-5
 - precautions for use 3-1
 - proximity alarm 3-9, 4-9
 - stopping tracking of targets 3-3
 - symbol color 3-10, 4-10
 - target data 3-7
 - test 6-10
 - vector 3-4, 4-6

B

- Background color 1-42
- Brilliance 1-35

C

- CANCEL/HL OFF key 1-35
- Characteristics curve 1-45
- Color selections 1-41
- Controls 1-1
- Course-up mode 1-8
- CPA/TCPA alarm
 - AIS 4-8
 - ARPA 3-8
- Cursor 1-14
- CUSTOM key 1-36
- Custom setup
 - description 1-36
 - setting 1-37

D

- Depth unit 1-51
- Display indications 1-3

Display mode

- course-up 1-8
 - head-up 1-8
 - north-up 1-8
 - true motion 1-9
 - true view 1-9
- Dynamic range 1-44

E

- EBL
 - measuring bearing by 1-18
 - reference 1-19
- EBL key 1-18
- Echo area 1-48
- Echo average 1-29
- Echo stretch 1-29

F

- F1, F2, F3 key 1-38
- False echoes 2-3
- Function keys 1-38
- Fuse replacement 6-3

G

- GAIN control 1-10
- GPS
 - cold start 5-4
 - datum 5-1
 - navigator mode 5-1
 - satellite monitor 5-3
 - test 6-11
 - WAAS 5-2

H

- Heading line 1-35
- Head-up mode 1-8
- History display
 - AIS 4-7
 - ARPA 3-6

I

- Initial sub menu 1-49
- Interference rejector 1-15

L

- LCD backlight life 6-3
- Lost target
 - AIS 4-9
 - ARPA 3-10

M

- Magnetron life 6-3
- Maintenance
 - fuse replacement 6-3
 - LCD backlight life 6-3
 - magnetron life 6-3
 - preventive 6-2

INDEX

- Menu 1-4
- MENU key 1-4
- Multiple echoes 2-3
- N**
- Navigation data
 - at screen bottom 1-43
 - standby 1-43
- Noise rejector 1-39
- North-up mode 1-8
- O**
- OFF CENTER key 1-25
- Off-centering the display 1-25
- P**
- POWER/BRILL key 1-2, 1-4
- Proximity alarm
 - AIS 4-9
 - ARPA 3-9
- Pulselength 1-20
- Q**
- Quick start 1-2
- R**
- RACON 2-8
- Range and bearing between two targets . 1-19
- RANGE key 1-9
- Range measurement 1-16
- Range preset 1-50
- Range ring brilliance 1-16
- Range unit 1-51
- Remote display 1-56
- S**
- SART 2-6
- Second-trace echoes 1-40
- Sector blank 1-51
- Shadow sector 2-5
- Ship speed unit 1-51
- Sidelobe echoes 2-4
- STBY/TX key 1-2
- System configuration xii
- T**
- Target alarm
 - alarm type 1-23
 - deactivating 1-23, 1-24
 - setting 1-22
 - stopping 1-22
 - strength level 1-24
- TARGET ALARM key 1-22
- Target trails
 - color 1-32
 - gradation 1-32
 - level 1-33
 - mode 1-31
 - narrow trails 1-34
 - restarting 1-33
 - starting 1-31
 - stopping 1-31
 - trail copy 1-33
 - your ship trail 1-34
- Temperature unit 1-51
- Test
 - ARPA 6-10
 - diagnostic 6-7
 - GPS 6-11
 - LCD 6-9
- TLL key 1-34
- TRAILS key 1-31
- Troubleshooting
 - advanced-level 6-5
 - simple 6-4
- True motion mode 1-9
- True view mode 1-9
- Tuning 1-6
- V**
- Virtual image 2-4
- VRM
 - measuring range by 1-17
 - unit of range measurement 1-17
- VRM key 1-17
- W**
- Watchman 1-40
- Waypoint marker 1-46
- Wind direction 1-50
- Wind speed unit 1-51
- Wiper 1-39
- Z**
- Zoom 1-27

Declaration of Conformity

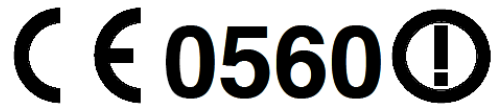

We **FURUNO ELECTRIC CO., LTD.**

(Manufacturer)

9-52 Ashihara-Cho, Nishinomiya City, 662-8580, Hyogo, Japan

(Address)

declare under our sole responsibility that the product

10.5 inch color LCD radar equipment Model 1835 Series, types Model 1835 (36 NM, 4 kW, 24 rpm), Model 1935 (48 NM, 4 kW, 24/48 rpm), Model 1937 (48 NM, 4 kW, 48 rpm) and Model 1945 (64 NM, 6 kW, 24/48 rpm)

(Model name, type number)

are in conformity with the essential requirements as described in the Directive 1999/5/EC of the European Parliament and of the Council of 9 March 1999 on radio equipment and telecommunications terminal equipment (R&TTE Directive) and satisfies all the technical regulations applicable to the product within this Directive

IEC 60945 Fourth edition: 2002-08, IEC 60950-1 First edition: 2001-10

ITU-R M.1177-3: 2003-06, SM.1539-1: 2002-11, SM.1541-2: 2006-05, SM.329-10: 2003-02

(title and/or number and date of issue of the standard(s) or other normative document(s))

For assessment, see

- Statement of Opinion N^o 09214003/AA/00 of 30 January 2009 issued by Telefication bv, The Netherlands
- Test reports K03-17-164 and -165 of 19 November 2003, K03-17-173, -174, -175, -176, -177 and -188 of 05 January 2004 prepared by Furuno Electric Co., Ltd., Japan
- Test reports FLI 12-08-074 of 27 December 2008, FLI 12-08-075 Rev.1 of 22 January 2009 and FLI 12-08-076 of 27 December 2009 prepared by Furuno Labotech International Co., Ltd., Japan

On behalf of Furuno Electric Co., Ltd.

Hiroaki Komatsu
Manager,
International Rules and Regulations

Nishinomiya City, Japan
February 4, 2009

(Place and date of issue)

(name and signature or equivalent marking of authorized person)

