

FURUNO

OPERATOR'S MANUAL

FACSIMILE RECEIVER

MODEL FAX-30



FURUNO ELECTRIC CO., LTD.
NISHINOMIYA, JAPAN

© **FURUNO ELECTRIC CO., LTD.**

9-52, Ashihara-cho,
Nishinomiya, Japan

Telephone: 0798-65-2111
Telefax: 0798-65-4200

•Your Local Agent/Dealer

All rights reserved. Printed in Japan

FIRST EDITION : AUG. 2002
D1 : JAN. 22, 2003

(DAMI) PUB. No. OME-62600
FAX-30



* 00080937500 *



* OME62600D10 *



SAFETY INSTRUCTIONS

Safety Instructions for the Operator



WARNING



ELECTRICAL SHOCK HAZARD
Do not open the equipment.

Only qualified personnel should work inside the equipment.

Immediately turn off the power at the switchboard if water leaks into the equipment or something is dropped in the equipment.

Continued use of the equipment can cause fire or electrical shock. Contact a FURUNO agent for service.

Do not disassemble or modify the equipment.

Fire, electrical shock or serious injury can result.

Do not place liquid-filled containers on the top of the equipment.

Fire or electrical shock can result if a liquid spills into the equipment.

Immediately turn off the power at the switchboard if the equipment is emitting smoke or fire.

Continued use of the equipment can cause fire or electrical shock. Contact a FURUNO agent for service.

Make sure no rain or water splash leaks into the equipment.

Fire or electrical shock can result if water leaks in the equipment.



CAUTION

Use the proper fuse.

Use of a wrong fuse may cause serious damage to the equipment and void the warranty.

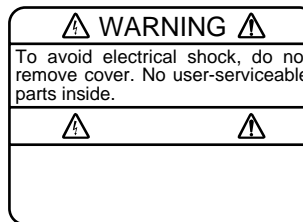

WARNING LABEL

A warning label is attached to the facsimile receiver. Do not remove the label. If the label is missing or illegible, contact a FURUNO agent or dealer about replacement.



Name: Warning Label (1)
Type: 86-003-1011-1
Code No.: 100-236-231

Safety Instructions for the Installer

 WARNING	
	ELECTRICAL SHOCK HAZARD Do not open the equipment unless totally familiar with electrical circuits and service manual. Only qualified personnel should work inside the equipment.
Turn off the power at the switchboard before beginning the installation. Fire or electrical shock can result if the power is left on.	
Do not install the equipment where it may get wet from rain or water splash. Water in the equipment can result in fire, electrical shock or damage the equipment.	
Be sure that the power supply is compatible with the voltage rating of the equipment. Connection of an incorrect power supply can cause fire or damage the equipment.	

 CAUTION		
Observe the following compass safe distances to prevent interference to a magnetic compass:		
	Standard compass	Steering compass
Facsimile Receiver	0.9 m	0.6 m

TABLE OF CONTENTS

FOREWORD	vi
SYSTEM CONFIGURATION	ix
EQUIPMENT LISTS	xi
1. OVERVIEW, SETUP	1-1
1.1 Overview, Setup: NavNet.....	1-1
1.1.1 Controls	1-1
1.1.2 Preparations for using the FAX-30	1-2
1.1.3 Accessing the FAX mode	1-3
1.1.4 Choosing the receive mode.....	1-4
1.1.5 Receive notification	1-5
1.2 Overview, Setup: PC.....	1-6
1.2.1 Accessing the FAX-30 top display.....	1-6
1.2.2 Choosing the receive mode.....	1-8
1.2.3 Logging out.....	1-8
2. FAX OPERATION: NAVNET.....	2-1
2.1 Automatic Receiving	2-1
2.1.1 Choosing channel.....	2-1
2.1.2 Previewing image being received.....	2-4
2.1.3 Stopping automatic receiving	2-4
2.2 Manually Starting, Stopping Receiving	2-5
2.2.1 Manually starting receiving	2-5
2.2.2 Manually stopping receiving	2-6
2.3 Timer Receiving	2-7
2.3.1 Setting timer receiving schedule	2-7
2.3.2 Turning on/off specific timer programs	2-11
2.3.4 Clearing all timer programs	2-11
2.4 Displaying Facsimile Images	2-12
2.5 Processing Facsimile Images	2-13
2.5.1 Phase mismatch	2-13
2.5.2 Phasing signal out of synchronization.....	2-14
2.5.3 Noise rejection.....	2-14
2.5.4 Image color	2-15
2.5.5 Image format.....	2-15
2.5.6 Zooming images	2-16
2.5.7 Rotating images.....	2-16
2.6 Erasing Facsimile Images.....	2-16
2.7 Preventing Erasure of Facsimile Images.....	2-17
2.8 Adding Facsimile Channels	2-18
3. FAX OPERATION: PC	3-1
3.1 Automatic Receiving	3-1
3.1.1 Starting receiving	3-1
3.1.2 Stopping receiving	3-1
3.2 Timer Receiving	3-2
3.2.1 Setting, changing timer receiving schedule.....	3-2

3.2.3	Turning on/off specific timer programs	3-4
3.2.4	Clearing all timer programs	3-4
3.3	Displaying Facsimile Images	3-5
3.4	Processing Facsimile Images	3-6
3.4.1	Phase mismatch	3-6
3.4.2	Phasing signal out of synchronization	3-7
3.4.3	Noise rejection	3-7
3.4.4	Image color	3-8
3.4.5	Image format	3-8
3.4.6	Rotating images	3-9
3.4.7	Zooming images	3-9
3.4.8	Saving images	3-9
3.5	Erasing Facsimile Images	3-9
3.6	Preventing Erasure of Facsimile Images	3-10
3.7	Adding Facsimile Channels	3-11
4.	NAVTEX OPERATION: NAVNET	4-1
4.1	About Navtex Messages	4-1
4.1.1	Message categories	4-1
4.1.2	Receiving navtex messages	4-1
4.2	Setting Up Navtex Stations, Messages, Alarms	4-2
4.3	Previewing Incoming Navtex Messages	4-5
4.4	Displaying Navtex Messages	4-6
4.4.1	Displaying navtex messages	4-6
4.4.2	Remarks on navtex messages	4-7
4.5	Displaying the Navtex Station List	4-8
4.6	Adding Navtex Stations	4-9
5.	NAVTEX OPERATION: PC	5-1
5.1	About Navtex Messages	5-1
5.1.1	Message categories	5-1
5.1.2	Receiving navtex messages	5-1
5.2	Setting Up Navtex Stations, Messages	5-2
5.3	Displaying Navtex Messages	5-3
5.4	Displaying the Navtex Station List	5-4
5.5	Adding Navtex Stations	5-5
5.6	Editing Navtex Stations	5-6
5.7	Deleting Navtex Stations	5-7
6.	MAINTENANCE, TROUBLESHOOTING	6-1
6.1	Maintenance	6-1
6.2	Replacement of Fuse	6-2
6.3	Troubleshooting	6-2
6.4	Diagnostics: NavNet	6-3
6.5	Diagnostics: PC	6-4
6.6	Clearing Data: NavNet	6-5
6.7	Clearing Data: PC	6-6
6.8	All Clear (for technicians only)	6-7
6.9	Simulation Mode	6-8
6.9.1	Accessing the simulation mode through NavNet	6-8
6.9.2	Accessing the simulation mode through PC	6-9

7. INSTALLATION.....	7-1
7.1 Facsimile Receiver.....	7-1
7.2 Antenna Unit	7-2
7.2.1 General antenna connection	7-2
7.2.2 Wire antenna or whip antenna	7-2
7.2.3 Installation of preamp unit FAX-5 (option).....	7-3
7.3 Wiring	7-4
7.4 Supplying Power to the Preamp Unit.....	7-6
7.5 Browser, PC Settings.....	7-7
7.5.1 Browser settings	7-7
7.5.2 PC settings	7-8
 APPENDIX	 AP-1
Facsimile Stations	AP-1
Navtex Stations	AP-4
Menu Tree.....	AP-9
 SPECIFICATIONS	 SP-1
 PACKING LIST	
OUTLINE DRAWINGS	
INTERCONNECTION DIAGRAM	
SCHEMATIC DIAGRAM	
 INDEX.....	 IN-1

FOREWORD

A Word to the Owner of the FAX-30

FURUNO Electric Company thanks you for purchasing the FURUNO FAX-30 Facsimile Receiver. We are confident you will discover why the FURUNO name has become synonymous with quality and reliability.

For over 50 years FURUNO Electric Company has enjoyed an enviable reputation for quality and reliability throughout the world. This dedication to excellence is furthered by our extensive global network of agents and dealers.

Your equipment is designed and constructed to meet the rigorous demands of the marine environment. However, no machine can perform its intended function unless properly installed and maintained. Please carefully read and follow the operation, installation and maintenance procedures set forth in this manual.

We would appreciate feedback from you, the end-user, about whether we are achieving our purposes.

Thank you for considering and purchasing FURUNO.

Features

Connected to a 10.4-inch NavNet series display unit or a PC, the FAX-30 receives facsimile images and navtex messages, transmitted from facsimile and navtex stations.

- Programmed with all existing facsimile stations and frequencies. User may program 320 channels.
- Fully automatic facsimile operation with built-in schedule timer. Storage for 30 timer programs.
- Fully automatic selection of speed, IOC, phase alignment and frequency. Manual selection also available.
- Connection to printer via a PC to print facsimile images and navtex messages.
- Facsimile images in monochrome, gray scale (8 tones) or color (three patterns).
- Built in navtex receiver. (The receiver does not conform to GMDSS regulations.)

Operational Characteristics

General

- The equipment receives one facsimile image or naxtex message at a time. Thus, a navtex message cannot be received when a facsimile image is being received and vice versa, regardless of navtex message category.
- Three receiving modes are available, facsimile, navtex, and facsimile(timer) & navtex. When using the facsimile(timer) and navtex, the order of priority is
Facsimile(timer) (highest priority) → Navtex (lowest priority)
- The FAX-30 does not have an internal clock, so time is input from the NavNet display or the PC. (For PC-only configuration, time data is read when the browser accesses the FAX-30. Therefore, turn on the FAX-30 before accessing it from the PC to allow for input of time data, which is necessary for facsimile timer recording.) To receive time data, do the following:
NavNet: Output the date and time data sentence ZDA through the NavNet network.
PC: Set the PC's clock to the correct time.
- If both a NavNet series unit and a PC are used, it is recommended to operate the FAX-30 from the PC because of the two different communication protocols. (Use the NavNet series unit to feed navigation data to the PC.)
- Navigation data must be fed through the network to use the automatic navtex mode. Therefore, this mode is not available in the PC-only configuration.

NavNet

- The FAX-30 cannot be accessed from the NavNet for 15 seconds after the FAX-30 has been turned on.
- NavNet requirements:
Navionics: Ver. 15, Boot Ver. 2 (1950006002)
C-MAP: Ver. 11, Boot Ver. 2 (1950006002)

PC

- The FAX-30 cannot be accessed from the PC while the FAX-30 is loading data at start up. Wait until the POWER LED flashing interval changes from 0.4 to two seconds before accessing the FAX-30.
- Most operating procedures in this manual are written for use with the Internet Explorer. Menu items, control button names, etc. may be different on the Netscape Navigator.
- PC requirements:
OS: Windows 98, 2000, XP
Memory: Min. 128 MB
CPU: Min. 600 MHz
Resolution: 1024x768 pixels

- Browser requirements:
Internet Explorer: Ver.5.01/5.5/6.0
Netscape Navigator: Ver.4.78/6.2/7.0

- OS and browser compatibility

	Internet Explorer			Netscape Navigator		
	Ver. 5.01	Ver. 5.5	Ver 6.0	Ver. 4.78	Ver. 6.2	Ver. 7.0
Windows 98	OK	OK	#	*1, *2	*2	NO, *3
Windows 2000	OK	OK	OK	*1	#	OK
Windows XP	#	#	OK	#	#	OK

- *1 A facsimile image may not be updated after it has been processed (noise limiter, zoom, etc.). To update the image, click the right button on the mouse while holding down the [SHIFT] key and then choose Reload.
- *2 Connection is occasionally interrupted. In case of 4.78 + Win 98, the message “A network error occurred: unable to connect to server (TCP Error: Not enough memory). The server may be down or unreachable. Try connecting again later.” is displayed. To restore the connection, press [Ctrl]+[Alt]+[Delete] to force quit Netscape. Then, reopen Netscape and try to connect again.
- *3 Connection is frequently interrupted and cannot be restored.
- # Not verified.

- Use of older OS with recent browser will result in extremely slow operation.
- If the browser goes into timeout while an image is being received, access to the FAX-30 may be interrupted. In this case, click the right button on the mouse and click Refresh.
- Most PC operations are done with the left button on the mouse. The exception is saving a facsimile image which is done with the right button.
- The FAX-30 cannot be simultaneously accessed by multiple PCs. For this reason, be sure to use the logout feature to logout a PC from the FAX-30 when its use is not required.
- If the FAX-30 appears to be abnormal, the browser version may not be compatible or browser settings may be wrong. See the browser requirements on the previous page, the browser and OS compatibility table above and the browser settings in paragraph 7.5.1.
- The FAX-30's HTTP and HTML versions are as below.
HTTP: Ver. 1.0
HTML: Ver. 4.01

SYSTEM CONFIGURATION

Network installation

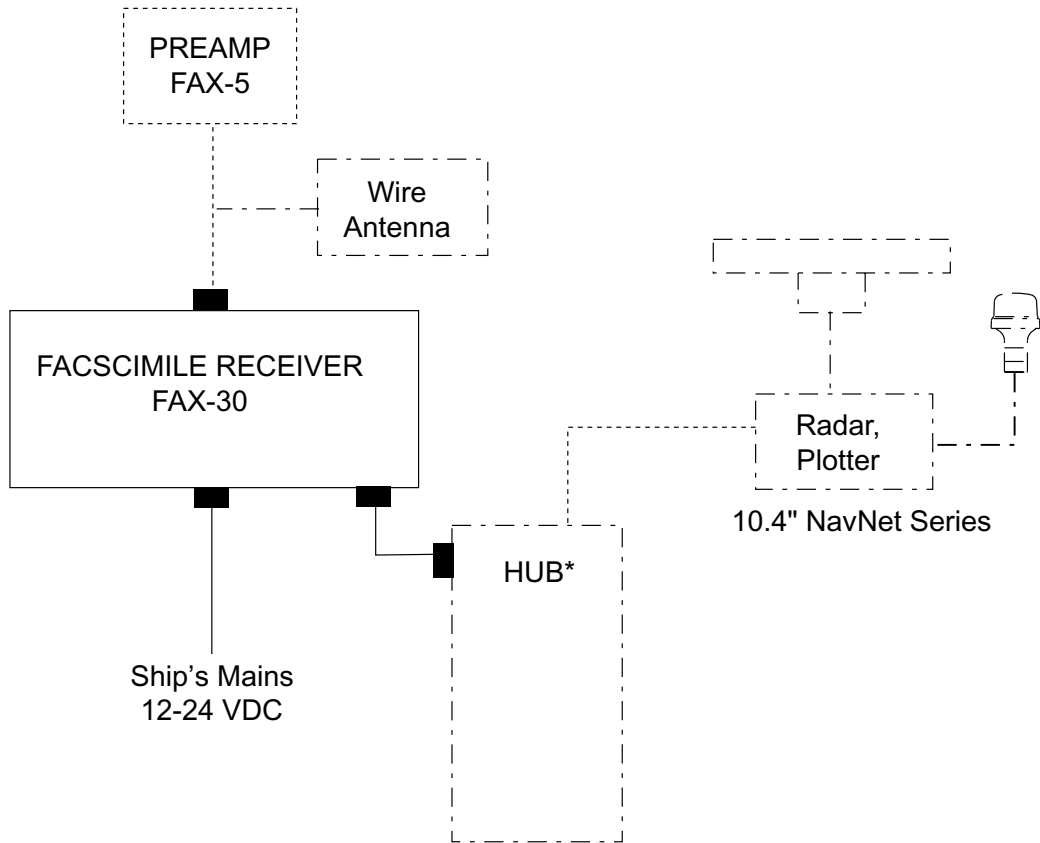

- : Standard
- : Option
- : User Supply

* = HUB is not required to connect NavNet display unit directly.

Network installation

PC installation

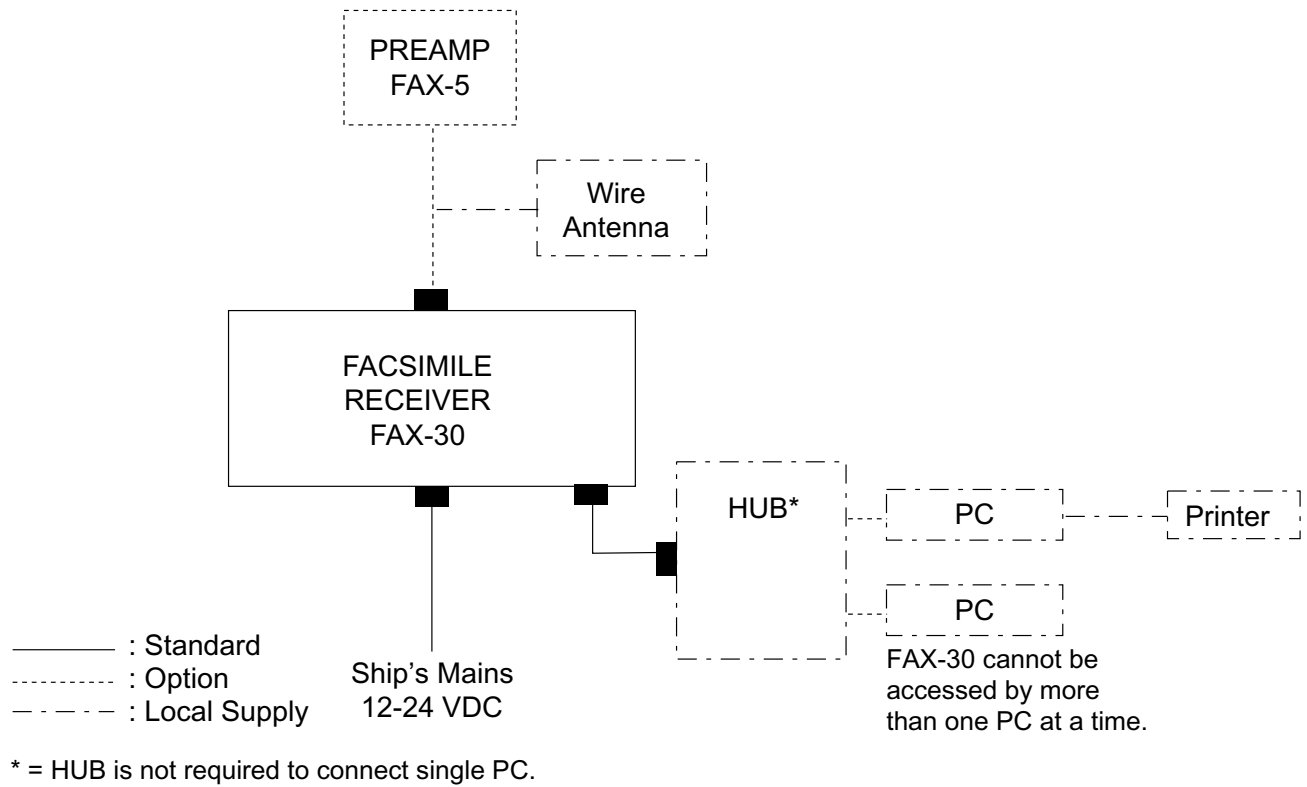

EQUIPMENT LISTS

Standard supply

Name	Type	Code No.	Qty	Remarks
Facsimile Receiver	FAX-30-E-AN	—	Select one	With Net cable
	FAX-30-E-AP	—		With PC cable
	FAX-30-E-N	—		No connection cable
Spare Parts	SP08-01901	005-952-780	1 set	Fuse, 2 pcs.
Installation Materials	CP08-01700	000-057-103	Choose one	<ul style="list-style-type: none"> • <u>Power Cable</u> MJ-A3SPF0024-035 • <u>Net Cable</u> MJ-A6SPF0014-050 • Tapping screw (5 X 20)
	CP08-01710	000-057-104		<ul style="list-style-type: none"> • <u>Power Cable</u> MJ-A3SPF0024-035 • <u>PC Cable</u> MJ-A6SPF/TM11AP8C050 • Tapping screw (5X20)
	CP08-01720	000-057-105		<ul style="list-style-type: none"> • <u>Power Cable</u> MJ-A3SPF0024-035 • Tapping screw (5X20)

Optional supply

Name	Type	Code No.	Remarks	
Preamp Unit	FAX-5	000-075-016	w/15 m cable	
Hose Clamp	OP08-11	005-946-960	For fixing FAX-5 to a mast	
Whip Antenna	04S4176	000-112-845	2.6 m, for FAX-5	
Extension Cable Kit	OP-04-2 *10*	000-041-174	M-connector at both ends	
	OP-04-2 *20*	000-041-175		
	OP-04-2 *30*	000-041-176		
	OP-04-2 *40*	000-041-177		
	OP-04-2 *50*	000-041-178		
Cable Assy.	MJA6SRMD/TM11AP8-005	000-144-463	Net conversion cable, for HUB, NavNet	
Cable Assy.	MJ-A6SPF/TM11AP8C050	000-146-289	Net conversion cable, for HUB, PC	
Coaxial Plug	FM-MP-7	000-108-859	For cable 7C2V, RG8/U, etc.	
Adaptor	MP-M3A	000-108-860	For cable 3C2V, 3D2V, etc.	
Adaptor	MP-M5A	000-108-861	For cable 5C2V, 5D2V, etc.	
Cable Assy. MJ	MJ-A6SPF0014-010	000-144-421	1 m	Net cable
	MJ-A6SPF0014-050	000-144-422	5 m	
	MJ-A6SPF0014-100	000-144-423	10 m	
	MJ-A6SPF0014-200	000-144-424	20 m	
	MJ-A6SPF0014-300	000-144-425	30 m	

1. OVERVIEW, SETUP

1.1 Overview, Setup: NavNet

1.1.1 Controls

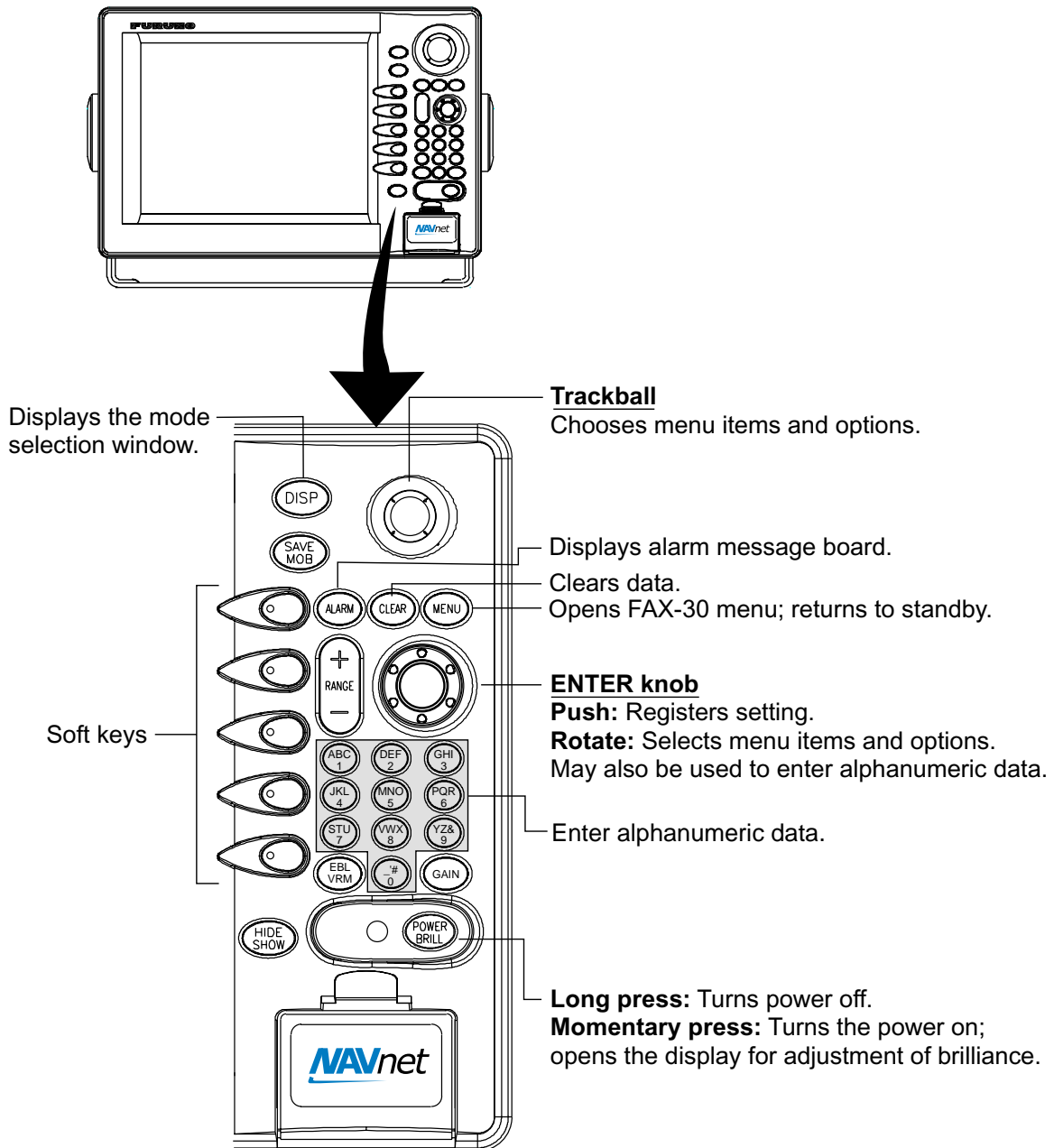

Controls

Note 1: For NavNet operating procedures, see the operator's manual of the NavNet display unit.

Note 2: The example screens shown in this manual may not match the screens you see. The screen you see depends on your equipment settings and system configuration.

1.1.2 Preparations for using the FAX-30

The NavNet series display unit must output the date and time data sentence ZDA through the network in order to use the facsimile timer recording feature. Further, automatic navtex requires the geographical position data sentence GGA (GPS position fix data) or GLL (geographic position, latitude/longitude). Output appropriate data sentences from the NavNet display unit to the FAX-30 as follows:

1. Turn on the NavNet display unit. From the radar, plotter or echo sounder display, press the [MENU] key.
2. Press the SYSTEM CONFIGURATION soft key.
3. Press the SYSTEM SETUP soft key.
4. Press the PORT SETUP soft key.
5. Press the OUTPUT THROUGH NETWORK soft key.

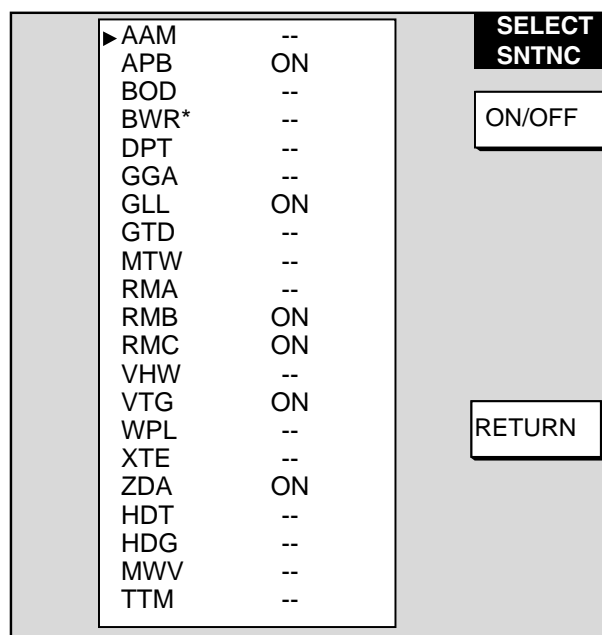

*: BWR: Rhumb line
 BWC: Great circle

Select sentence window

6. Rotate the [ENTER] knob to choose GGA, GLL or ZDA.
7. Press the ON/OFF soft key to display ON.
8. Repeat steps 6 and 7 to set the other two sentences to ON.
9. Press the [MENU] key to close the menu.

1.1.3 Accessing the FAX mode

1. Turn on the FAX-30 at the ship's mains switchboard. The FAX-30 proceeds in the following sequence:
 - a) The FAX-30 starts initial set up, which takes about 15 seconds.
 - b) The FAX-30 transfers (loads) data from the ROM to the RAM. At this time the LED flashes every 0.4 seconds.
 - c) After all data has been loaded, which takes about two minutes, the LED flashes every two seconds, indicating the FAX-30 is ready for operation.

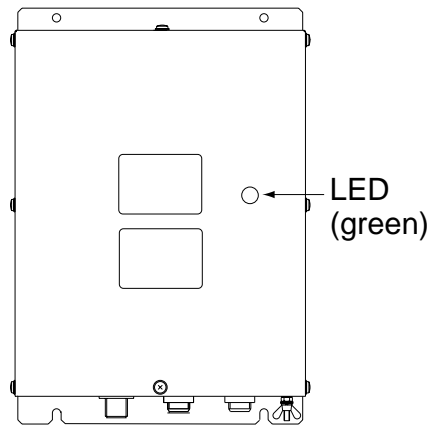

FAX-30, top view

2. Press the [DISP] key to show the display selection window.

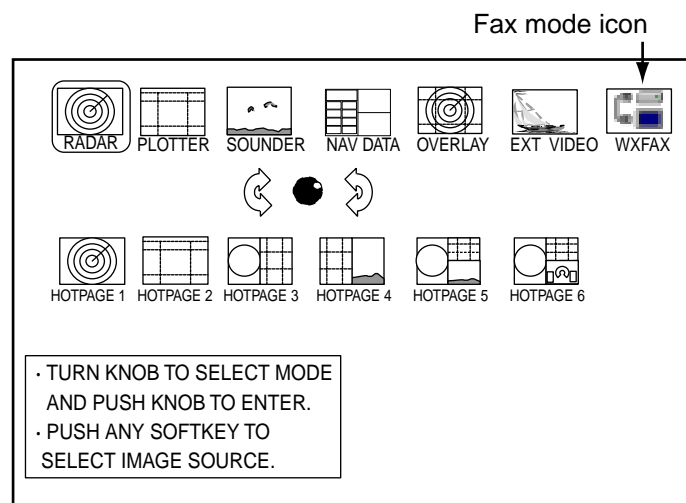

Display selection window

3. Rotate the [ENTER] knob to choose the WXFAX icon.
4. Push the [ENTER] knob to show the fax standby display.

Note 1: The FAX-30 cannot be accessed during the 15-second start up period which occurs after the power has been turned on.

Note 2: If the FAX-30 is not connected to the NavNet display unit when the display unit is powered, the message "AUX SOURCE IS DISCONNECTED. PUSH ENT KNOB TO EXIT." appears. Check connections between the FAX-30 and the NavNet display unit.

Note 3: "LOAD IMAGES" is displayed while the FAX-30 is loading data.

1. OVERVIEW, SETUP

The standby display is where you begin all facsimile and navtex operations. If a facsimile image has been received, the latest facsimile image is displayed.

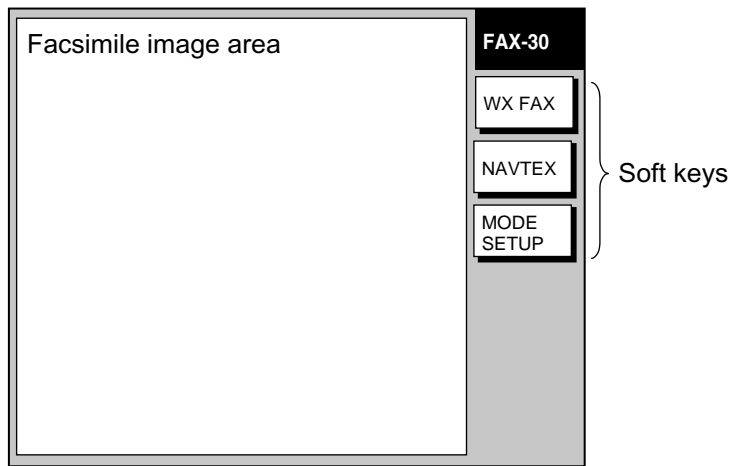

Standby display

1.1.4 Choosing the receive mode

The FAX-30 has three modes: facsimile only, navtex only, and facsimile (timer) & navtex. Choose desired mode as follows:

1. At the facsimile standby display, press the MODE SETUP soft key.

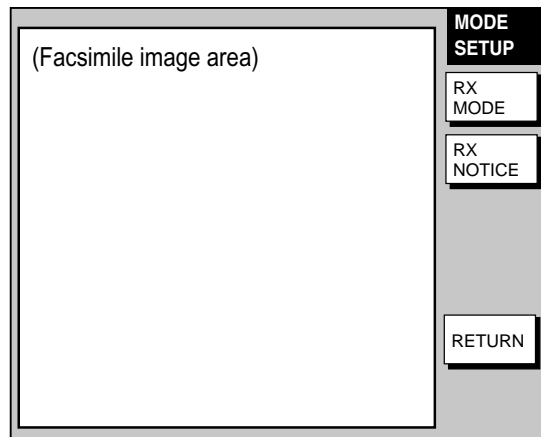

Receive mode setup screen

2. Press the RX MODE soft key.

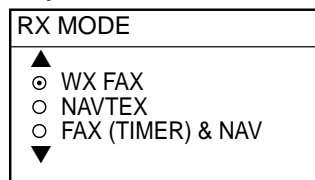

RX mode options

3. Rotate the [ENTER] knob to choose receive mode desired and press the ENTER soft key.

1.1.5 Receive notification

You may wish to be notified after a facsimile image or navtex message arrives. Notification is done by showing the “fax/navtex received” icon () at the left-hand side of the screen in display modes other than the fax mode.

1. At the facsimile standby display, press the MODE SETUP soft key.
2. Press the RX NOTICE soft key.

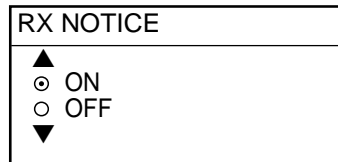

RX notice options

3. Rotate the [ENTER] knob to choose ON or OFF as appropriate.
4. Press the ENTER soft key.

1.2 Overview, Setup: PC

1.2.1 Accessing the FAX-30 top display

1. Turn on the FAX-30 at the mains switchboard. The FAX-30 proceeds in the following sequence:
 - a) The FAX-30 starts initial set up, which takes about 15 seconds.
 - b) The FAX-30 transfers (loads) data from the ROM to the RAM. At this time the LED flashes every 0.4 seconds.
 - c) After all data has been loaded, which takes about two minutes, the LED flashes every two seconds, indicating the FAX-30 is ready for operation.
2. Start up the browser software.
3. After the LED on the FAX-30 starts flashing every two seconds, type in the FAX-30's URL <http://172.31.8.1> and then press the [Enter] key. The facsimile receiver top display appears. (For one-touch access to the FAX-30 make a bookmark.)



Facsimile receiver top display

4. Click WX FAX for facsimile or NAVTEX for navtex to show the corresponding standby display, which is where you begin all facsimile (or navtex) operations.

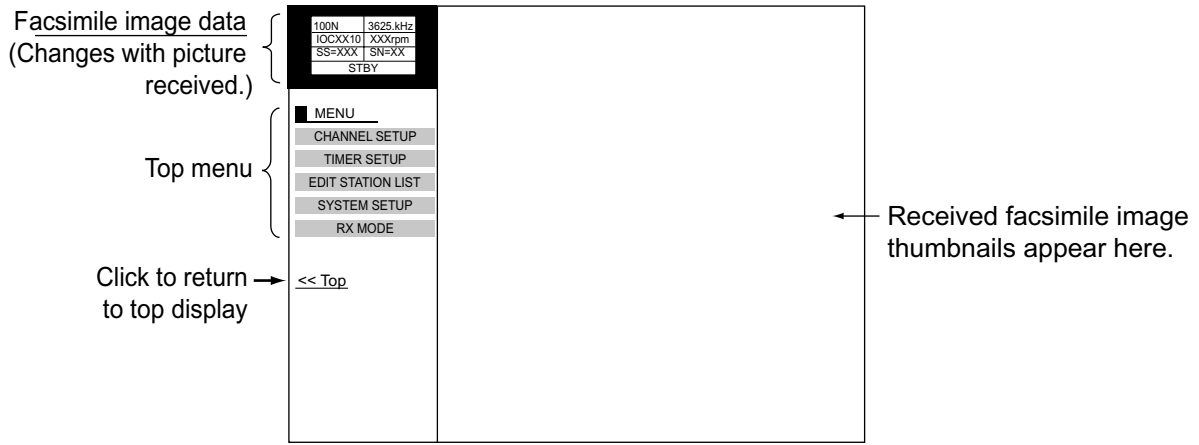

Fax standby display

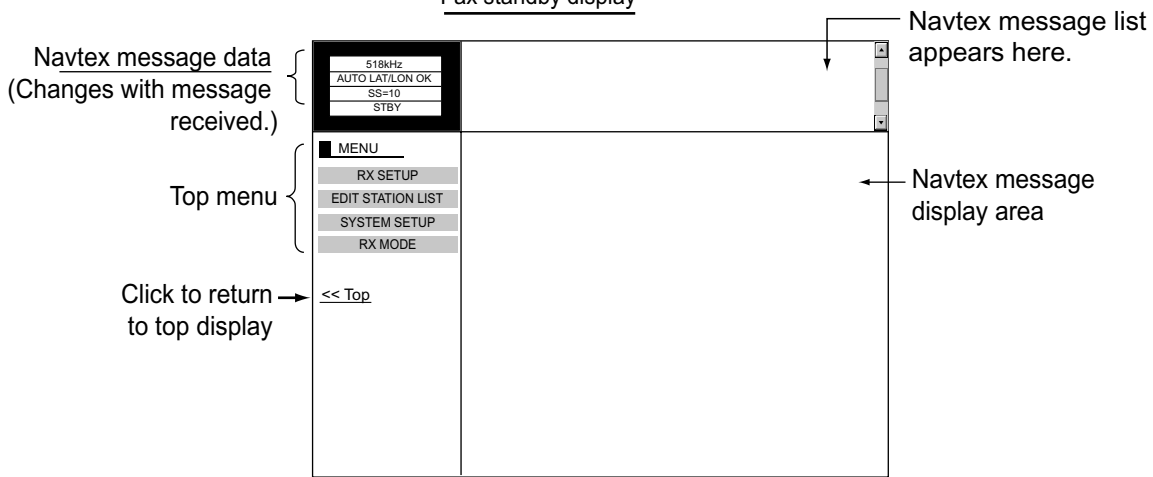

Navtex standby display

Standby displays

After you are in a standby display time data is transferred from the PC to the FAX-30.

Note 1: After turning on the FAX-30 be sure to access it from the PC. Then, even if the PC is turned off, time data is stored in the FAX-30, for use with timer recording.

Note 2: The example screens shown in this manual may not match the screens you see. The screen you see depends on your equipment settings and system configuration.

1.2.2 Choosing the receive mode

The FAX-30 has three modes: facsimile only, navtex only, and facsimile (timer) & navtex. Choose desired mode as follows.

1. At the facsimile or navtex standby display, click RX MODE.

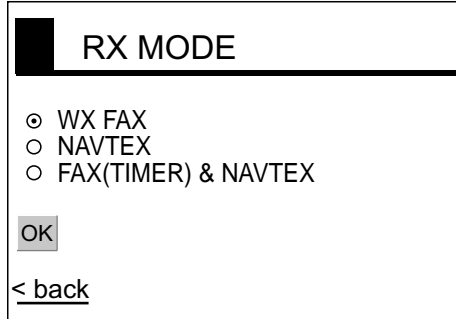

RX mode options

2. Click receive mode desired and then click OK.
3. Click "<back" or Back button to return to the top menu.

1.2.3 Logging out

The FAX-30 cannot be accessed simultaneously by multiple PCs. For this reason, log out a PC from the FAX-30 when its use is not required.

1. At the facsimile or navtex menu display, click "<Top" to return to the facsimile receiver top display. (See the illustration at the top of the previous page.)
2. Click LOGOUT to logout the PC from FAX-30.

2. FAX OPERATION: NAVNET

2.1 Automatic Receiving

Once you choose the facsimile station from which to receive, the system goes into standby to await the start signal from the facsimile station.

2.1.1 Choosing channel

1. At the standby display, press the WX FAX soft key. Thumbnails of received images are shown.

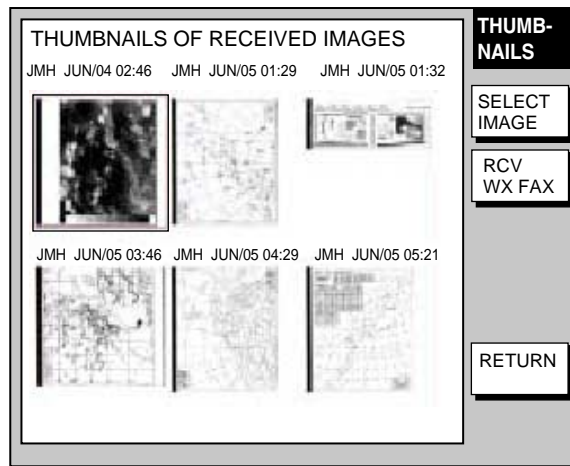

Thumbnails of received images

2. Press the RCV WX FAX soft key.

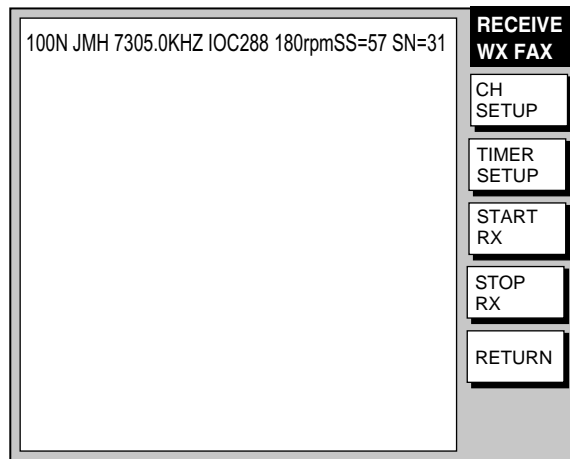

RECEIVE WX FAX display

2. FAX OPERATION: NAVNET

3. Press the CH SETUP soft key.

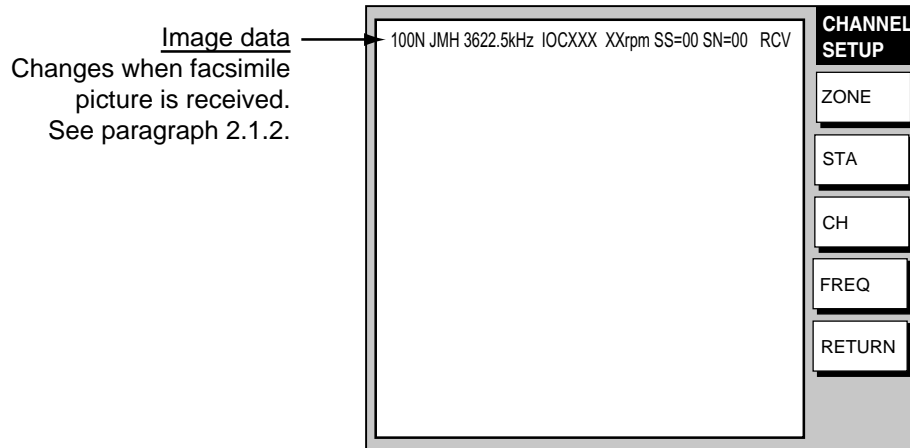

Fax channel setup window

4. Press the ZONE soft key to display the ZONE options.

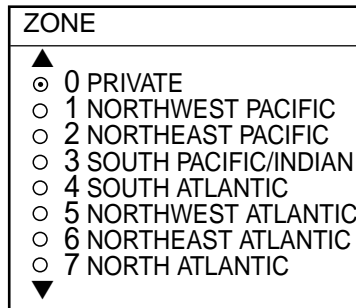

Zone options

5. Rotate the [ENTER] knob to choose zone desired and push the ENTER soft key. (Zone 0 and 9 are for user-set zones.)
6. Press the STATION soft key to show the STATION options. If the ZONE chosen at step 5 is "1 NORTHWEST PACIFIC," for example, the STATION options are as below.

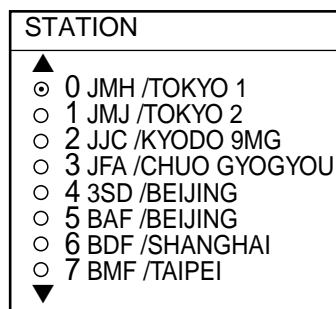

Station options (Example: stations of northwest pacific)

7. Rotate the [ENTER] knob to choose desired station and press the ENTER soft key.

8. Press the CHANNEL soft key to show the CHANNEL options. If you have chosen "0 JMH/TOKYO 1" at step 7, for example, the CHANNEL options are as below.

CHANNEL	
▲	
⊙	AUTO
○	0 03622.5 kHz
○	1 04902.0 kHz
○	2 07305.0 kHz
○	3 09970.0 kHz
○	4 13597.0 kHz
○	5 18220.0 kHz
○	6 23522.9 kHz
▼	

Channel options (Example: JMH/Tokyo)

9. Rotate the [ENTER] knob to choose channel desired and press the ENTER soft key.
10. If necessary you may fine tune the frequency. Press the FREQ soft key.

FREQUENCY
03622.5 kHz

Frequency entry window

11. Use the alphanumeric keys or the [ENTER] knob to enter appropriate frequency and press the ENTER soft key. (You may choose the location where to enter data by operating the trackball.)
12. Press the RETURN soft key several times to return to the standby display.

Then, the FAX-30 will receive the next scheduled broadcast from the station selected. When the FAX-30 receives the start signal from the facsimile station it automatically adjusts itself to match speed, IOC (Index of Cooperation) and phase of the station's transmitter. Facsimile images are received line by line, taking 30-40 minutes to receive depending on the size of the image and rotation speed of the drum at the facsimile transmitter. After a facsimile image is received it is compressed and stored in image memory and then posted on the "Thumbnails of received images" screen (see paragraph 2.4). This process takes from three to five minutes. You can see the image being received by pressing the WX FAX soft key on the fax standby display and then hitting the RCV WX FAX soft key.

2.1.2 Previewing image being received

To preview an image while it is being received, do the following:

1. At the fax standby display, press the WX FAX soft key.
2. Press the RCV WX FAX soft key.

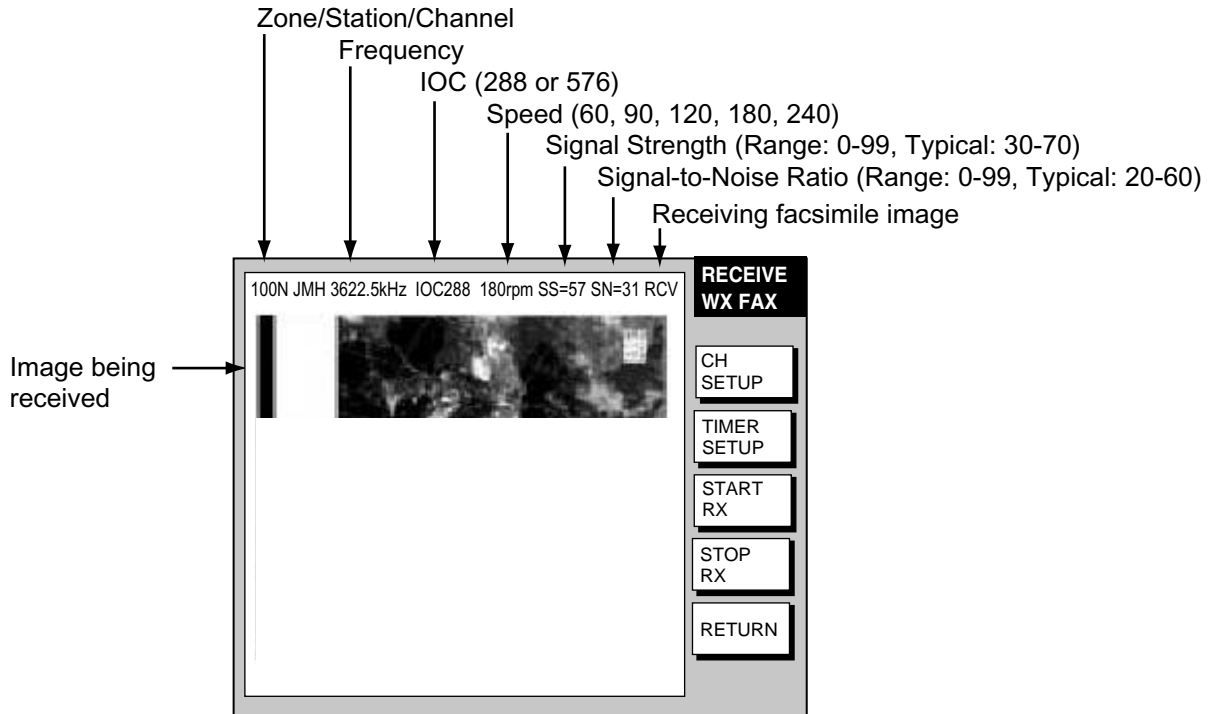

Facsimile receiving display

2.1.3 Stopping automatic receiving

You can stop automatic receiving at any time by doing the following:

1. At the standby display, press the WX FAX soft key.
2. Press the RCV WX FAX soft key.
3. Press the STOP RX soft key. The indication "RCV" is replaced with "STBY."
4. Press the RETURN soft key.

2.2 Manually Starting, Stopping Receiving

2.2.1 Manually starting receiving

This section shows you to manually receive a facsimile broadcast. For example, you may want to receive a facsimile broadcast already in progress or receive from a facsimile station that does not use start and stop signals. Further, you may wish to stop reception to receive an image from a different station.

To manually receive a facsimile, you will first need to set a channel, referring to paragraph 2.1. Then, do the following:

1. At the standby display, press the WX FAX soft key.
2. Press the RCV WX FAX soft key.
3. Press the START RX soft key.

The options shown are IOC (Index of Cooperation)/speed.

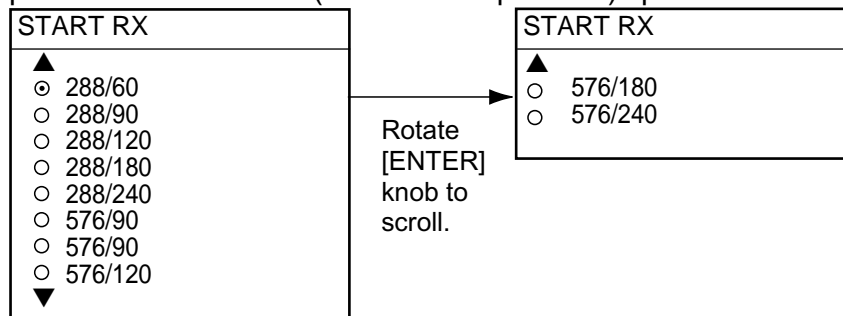

Start RX options

4. Rotate the [ENTER] knob to choose the correct combination of IOC and speed of the facsimile transmitting station. IOC is the line density standard assigned by WMO: IOC 576, high density, IOC 288, low density. Speed is the rotation speed of the drum (on which the original image is fitted) at the facsimile transmitter: 60, 90, 120, 180 or 240 rpm.
5. Press the ENTER soft key.
6. Press the RETURN soft key.

Then, the FAX-30 will receive the current broadcast from the station selected. Facsimile images are received line by line, taking 30-40 minutes to receive depending on the size of the image and drum rotation speed at the facsimile station. After a facsimile image is received it is compressed and stored in the image memory and then posted on the "Thumbnails of received images" screen (see paragraph 2.4). This process takes 3-5 minutes. You can see the image being received by pressing the WX FAX soft key on the fax standby display and then hitting the RCV WX FAX soft key.

2. FAX OPERATION: NAVNET

Be sure to choose the correct speed and IOC, otherwise the image will be received as shown in the illustration below. You may change the IOC and speed while the image is being received.

Wrong Speed or IOC and Image

Wrong speed: "60" chosen instead of "120"

Two images are displayed.

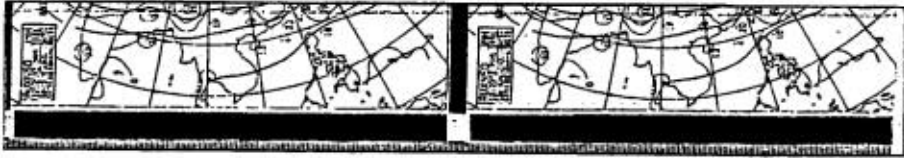

Wrong speed: "120" chosen instead of "60"

Overlapped image appears.



Wrong IOC

The image will be extended (or foreshortened) when "288" (or 576) is selected for transmission with the IOC of "576 (or 288)."



Wrong speed or IOC and image

2.2.2 Manually stopping receiving

1. At the standby display, press the WX FAX soft key.
2. Press the RCV WX FAX soft key.
3. Press the STOP RX soft key.
4. Press the RETURN soft key.

2.3 Timer Receiving

Most facsimile stations transmit facsimiles in accordance with a schedule issued by relative meteorological observatory. (You can find facsimile schedules in the publication “Meteorological Facsimile Broadcasts,” available through meteorological observatory bodies.) If you wish to receive a certain facsimile broadcast on a daily basis, therefore, the timer receiving mode will virtually allow you “hands-off” automatic operation. 30 timer programs may be set.

2.3.1 Setting timer receiving schedule

Note that the data sentence ZDA must be output through the network for the timer to function.

1. At the standby display, press the WX FAX soft key.
2. Press the RCV WX FAX soft key.
3. Press the TIMER SETUP soft key.

Timer schedule, in time order from closest to furthest. Only the latest 10 programs are displayed.

TIMER SETUP	
No. 05	10:30-14:05 100N JMH 3662.5 kHz
No. 06	14:30-16:40 100N JMH 3662.5 kHz
No. 07	16:40-19:00 100N JMH 3662.5 kHz
No. 01	19:05-19:15 100N JMH 3662.5 kHz

START TIMER
PROG LIST
RETURN

Timer setup screen

4. Press the PROG LIST soft key.

	Start, end time	Zone/Station/Channel	Facsimile station	Timer ON	
▶ No.01	12:30-14:00	100N JMH	JMH	ON	
No.02	NOT PROGRAMMED				EDIT
No.03	NOT PROGRAMMED				ON/OFF
No.04	NOT PROGRAMMED				CLEAR ALL
No.05	NOT PROGRAMMED				
No.06	NOT PROGRAMMED				
No.07	NOT PROGRAMMED				
No.08	NOT PROGRAMMED				
No.09	NOT PROGRAMMED				
No.10	NOT PROGRAMMED				RETURN
NEXT PAGE					

PROGRAM LIST

Timer schedule list

2. FAX OPERATION: NAVNET

5. Rotate the [ENTER] knob to choose program number desired and then press the EDIT soft key.

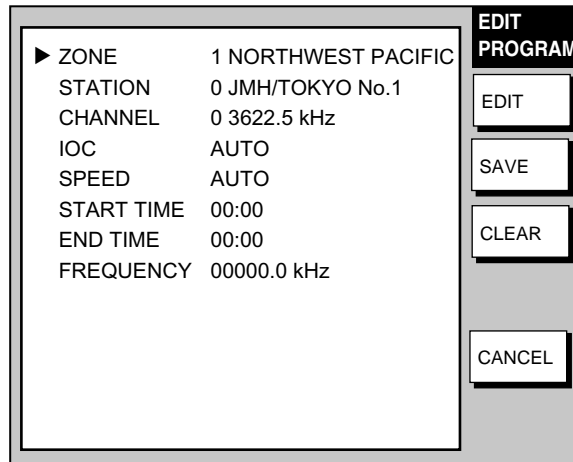

Timer schedule menu

6. ZONE is selected; press the EDIT soft key.

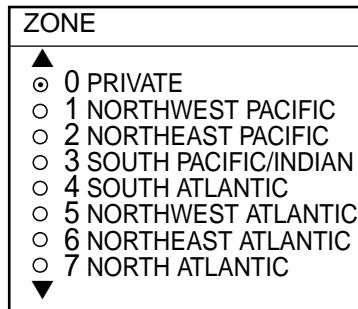

Zone options

7. Rotate the [ENTER] knob to choose zone desired and press the ENTER soft key.
8. Rotate the [ENTER] knob to choose STATION and press the EDIT soft key. If you have chosen "1 NORTHWEST PACIFIC" at step 7, for example, the STATION options are as below.

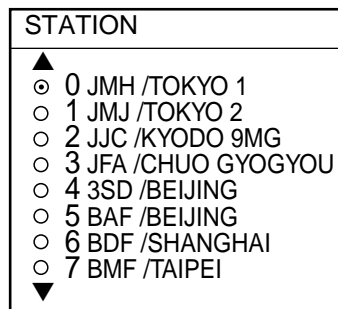

Station options (Example: N Pacific W Part)

9. Rotate the [ENTER] knob to choose desired station and press the ENTER soft key.

10. Rotate the [ENTER] knob to choose CHANNEL and press the EDIT soft key. If you have chosen "0 JMH/TOKYO 1" at step 9, for example, the CHANNEL display looks as below.

CHANNEL	
▲	
<input checked="" type="radio"/>	AUTO
<input type="radio"/>	0 03622.5 kHz
<input type="radio"/>	1 04902.0 kHz
<input type="radio"/>	2 07305.0 kHz
<input type="radio"/>	3 09970.0 kHz
<input type="radio"/>	4 13597.0 kHz
<input type="radio"/>	5 18220.0 kHz
<input type="radio"/>	6 23522.9 kHz
▼	

Channel options (Example: station JMH)

11. Rotate the [ENTER] knob to choose channel desired and press the ENTER soft key. Choose AUTO for automatic selection of channel. (Most stations transmit the same message over several frequencies, so if you are unsure of the channel choose AUTO.)
12. Rotate the [ENTER] knob to choose IOC and press the EDIT soft key.

IOC	
▲	
<input checked="" type="radio"/>	AUTO
<input type="radio"/>	288
<input type="radio"/>	576
▼	

IOC options

13. Rotate the [ENTER] knob to choose the IOC of the facsimile station and press the ENTER soft key. If you are unsure of the IOC, choose AUTO for automatic selection of IOC.
14. Rotate the [ENTER] knob to choose SPEED and press the EDIT soft key.

SPEED	
▲	
<input checked="" type="radio"/>	AUTO
<input type="radio"/>	60
<input type="radio"/>	90
<input type="radio"/>	120
<input type="radio"/>	180
<input type="radio"/>	240
▼	

Drum speed options

15. Rotate the [ENTER] knob to choose drum rotating speed at the facsimile station and press the ENTER soft key. If you are unsure of the speed, choose AUTO for automatic selection of speed.
16. Rotate the [ENTER] knob to choose START TIME and press the EDIT soft key.

START TIME	
00:00	

Start time entry window

2. FAX OPERATION: NAVNET

17. Enter a start time in 24-hour notation, about two minutes earlier than actual start time to allow for detection of the start signal and press the ENTER soft key.
18. Rotate the [ENTER] knob to choose END TIME and press the EDIT soft key.

END TIME
<input checked="" type="radio"/> 0:00

End time entry window

19. Enter end time in 24-hour notation about two minutes later than actual end time to allow for detection of the stop signal, and press the ENTER soft key.
Note: Two programs which overlap each other will cause the program having the later start time to be disregarded. For example, if the start and end times of program no. 1 are 01:00 and 02:00 and those of program no. 2 are 01:30 to 3:00, program no. 2 will be disregarded.
20. If necessary you may fine tune the receive frequency. Rotate the [ENTER] knob to choose FREQUENCY and press the EDIT soft key. The frequency selected at step 10 appears.

FREQUENCY
<input checked="" type="radio"/> 3522.5 kHz

Frequency entry window

21. Enter frequency with the numeric keys and press the ENTER soft key.
22. Press the SAVE soft key.

SAVE
<input checked="" type="radio"/> YES
<input type="radio"/> NO

Save window

23. Rotate the [ENTER] knob to choose YES and push the [ENTER] knob.
24. Repeat steps 4-23 to set other timer schedules.
25. Press the RETURN soft key.
26. Press the START TIMER soft key.

START TIMER
<input type="radio"/> START
<input checked="" type="radio"/> STOP

Start timer options

26. Rotate the [ENTER] knob to choose START and press the ENTER soft key.
27. Press the RETURN soft key.

Then, the FAX-30 will receive facsimile broadcasts according to the timer schedule. Facsimile images are received line by line, taking 30-40 minutes to receive depending on the size of the image and drum rotation speed at the facsimile station. After a facsimile image is received it is compressed and stored in the image memory and then posted on the facsimile standby display screen. This process takes 3-5 minutes. You can see the image being received by pressing the WX FAX soft key on the fax standby display and then hitting the RCV WX FAX soft key.

Note: To disable all timer programs do the following:

1. At the standby display, press the WX FAX soft key.
2. Press the RCV WX FAX soft key.
3. Press the TIMER SETUP soft key.
4. Rotate the [ENTER] knob to choose STOP.
5. Press the ENTER soft key.
6. Press the RETURN soft key.

2.3.2 Turning on/off specific timer programs

You may turn specific timer programs on or off as appropriate as follows:

1. At the standby display, press the WX FAX soft key.
2. Press the RCV WX FAX soft key.
3. Press the TIMER SETUP soft key.
4. Press the PROG LIST soft key.
5. Rotate the [ENTER] knob to choose a timer receiving schedule.
6. Press the ON/OFF soft key to display ON or OFF next to timer program data.
7. Press the RETURN soft key several times to return to the standby display.

2.3.4 Clearing all timer programs

You may clear all timer programs as follows:

1. At the standby display, press the WX FAX soft key.
2. Press the RCV WX FAX soft key.
3. Press the TIMER SETUP soft key.
4. Press the PROG LIST soft key.
5. Press the CLEAR ALL soft key.

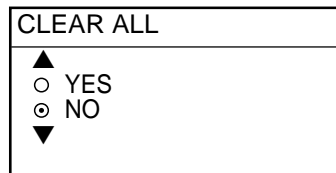

Clear all options

6. Rotate the [ENTER] knob to choose YES and push the ENTER knob.
All timer programs disappear.
7. Press the RETURN soft key several times to return to the standby display.

2.4 Displaying Facsimile Images

- At the standby display, press the WX FAX soft key. Thumbnails of images received are shown on the display. The equipment stores as many as 12 images, on two pages. If more than six images are stored, PREV PAGE and NEXT PAGE soft keys appear in order to navigate between pages. When the image storage capacity is exceeded, the oldest image is automatically deleted to make room for the latest.

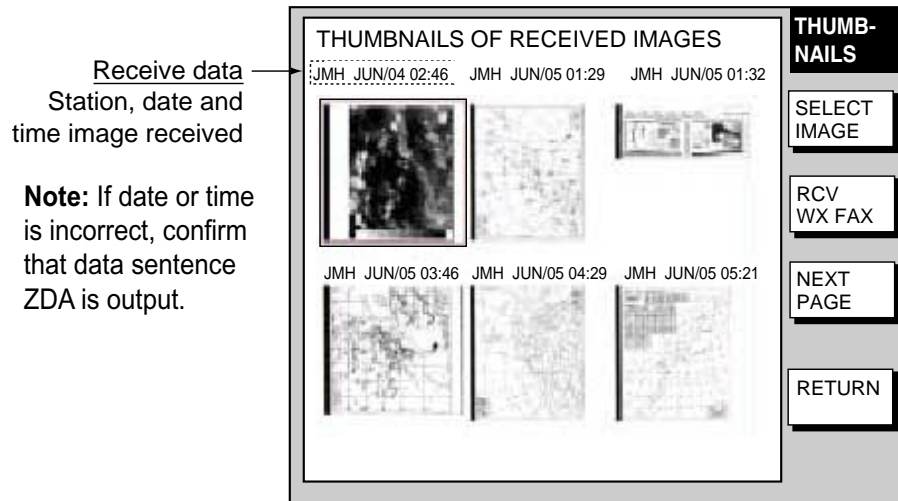

Thumbnails of received images

- Use the [ENTER] knob to select the facsimile image to process and then press the SELECT IMAGE soft key or push the [ENTER] knob. You can scroll the image with the trackball.

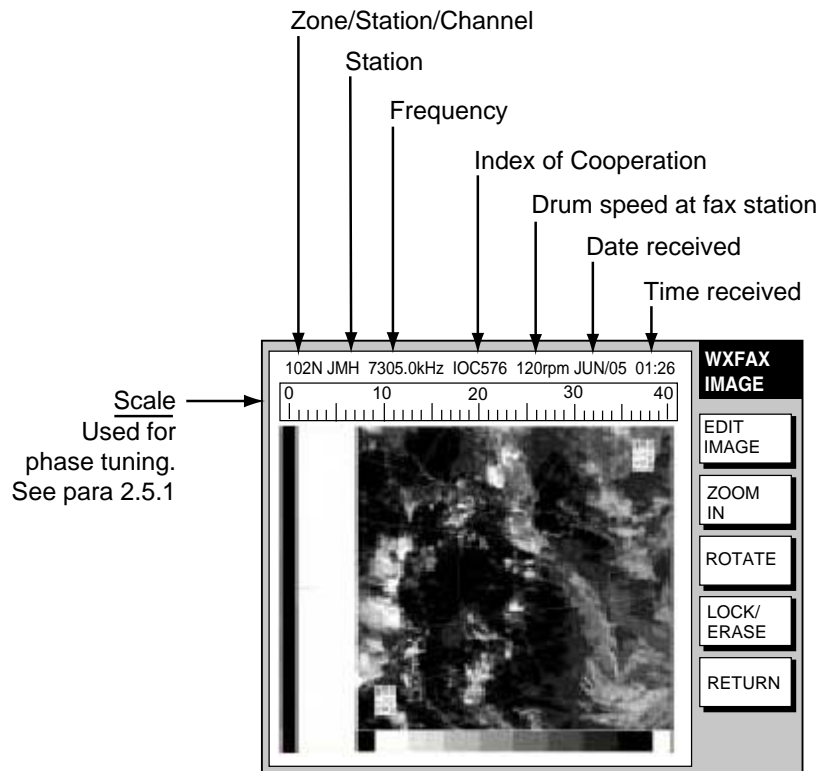

Facsimile image

2.5 Processing Facsimile Images

2.5.1 Phase mismatch

When the FAX-30 starts receiving a broadcast already in progress, or noise prevents detection of the phasing signal, the image may be divided into two parts by a thick black (or white) stripe called a dead sector. This phenomenon is due to phase mismatching. When this occurs, correct phase mismatching, after the facsimile has been received.

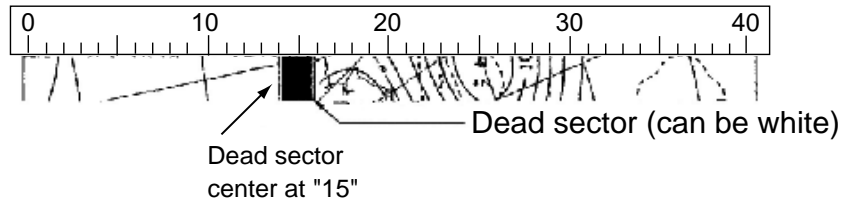

Example of phase mismatching

1. With a facsimile image displayed (see paragraph 2.4), press the EDIT IMAGE soft key.

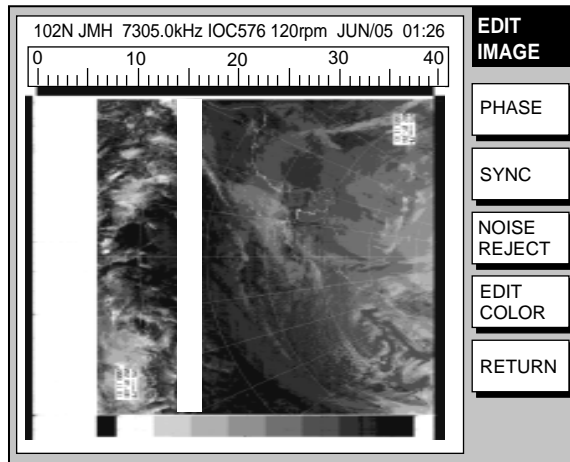

Facsimile image with dead sector

2. Press the PHASE soft key.

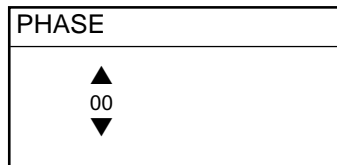

Phase entry window

3. Read the scale to find the center of the dead sector and enter it in the phase entry window. For example, in the illustration above the dead sector is centered at "15" on the scale, so you would enter "15". The setting range is 00 to 40.
4. Press the ENTER soft key.
5. Press the RETURN soft key several times to return to the standby display.

2.5.2 Phasing signal out of synchronization

The SYNC soft key functions to fine tune the phasing signal. If the dead sector is plotted at an angle even when the phase is properly selected, adjust the synchronization to display the dead sector straightly.

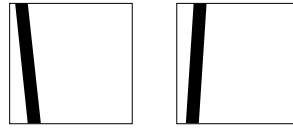

Example of phasing signal out of synchronization

1. With a facsimile image displayed (see paragraph 2.4), press the EDIT IMAGE soft key.
2. Press the SYNC soft key.

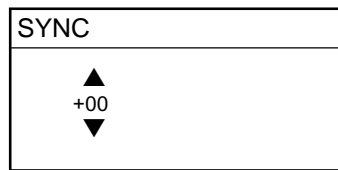

Sync entry window

3. Enter a sync value that displays the dead sector straightly. If the dead sectors appears as in the left-hand figure in example of phasing signals in the illustration above, enter a larger value and for the right-hand figure, enter a smaller value. The setting range is -50 to +50.
4. Press the ENTER soft key.
5. Press the RETURN soft key several times to return to the standby display.

2.5.3 Noise rejection

If noise speckles appear on the image, turn on the noise rejector as below to remove the noise.

1. With a facsimile image displayed (see paragraph 2.4), press the EDIT IMAGE soft key.
2. Press the NOISE REJECT soft key.

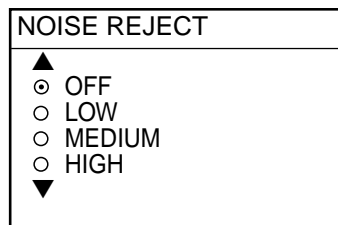

Noise rejector options

3. Rotate the [ENTER] knob to choose the noise rejection level desired. HIGH provides the greatest degree of noise rejection.
4. Press the ENTER soft key.
5. Press the RETURN soft key several times to return to the standby display.

2.5.4 Image color

The facsimile image is transmitted in monochrome (black and white) or gray scale (16 gradations). After an image has been received, you can choose the color arrangement among monochrome, gray scale and color (three patterns).

1. With a facsimile image displayed (see paragraph 2.4), press the EDIT IMAGE soft key.
2. Press the EDIT COLOR soft key.
3. Press the COLOR soft key.

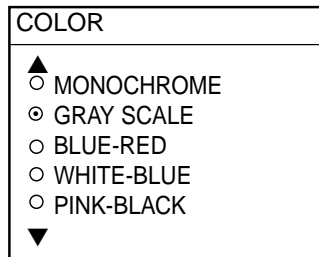

Color options

4. Rotate the [ENTER] knob to choose MONOCHROME, GRAY SCALE, BLUE-RED, WHITE-BLUE or PINK-BLACK as appropriate.

MONOCHROME: Monochrome black and white

GRAY SCALE: 16 gray tones

BLUE-RED: Shades of blue to red

WHITE-BLUE: Shades of white to blue

PINK-BLACK: Shades of pink to black

5. Press the ENTER soft key.
6. Press the RETURN soft keys several times to return to the standby display.

2.5.5 Image format

The facsimile image is usually transmitted with black text on a white background. Some stations, however, print white characters on a black background. If, for some reason, the image received cannot be read in its transmitted image format you may change it as follows:

1. With a facsimile image displayed (see paragraph 2.4), press the EDIT IMAGE soft key.
2. Press the EDIT COLOR soft key.
3. Press the REVERSE IMAGE soft key.

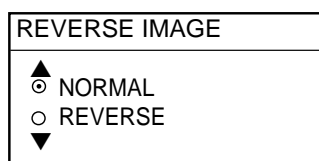

Reverse image options

4. Rotate the [ENTER] knob to choose NORMAL or REVERSE as appropriate.
5. Press the ENTER soft key.
6. Press the RETURN soft key several times to return to the standby display.

2.5.6 Zooming images

You may double the size of a facsimile image as follows:

1. Display the facsimile image you wish to process, referring to paragraph 2.4.
2. Press the ZOOM IN soft key.

To restore the normal size image, press the ZOOM OUT key.

2.5.7 Rotating images

You may rotate facsimile images as follows:

1. Display the facsimile image you wish to process, referring to paragraph 2.4.
2. Press the ROTATE soft key.
3. Press the CW (Clockwise) soft key to rotate the image 90° clockwise; CCW (Counterclockwise) soft key to rotate it 90° counterclockwise.

2.6 Erasing Facsimile Images

You may erase facsimile images as below.

1. Press the WX FAX key at the standby display.
2. Rotate the [ENTER] knob to select an image.
3. Push the [ENTER] knob or press the SELECT IMAGE soft key.

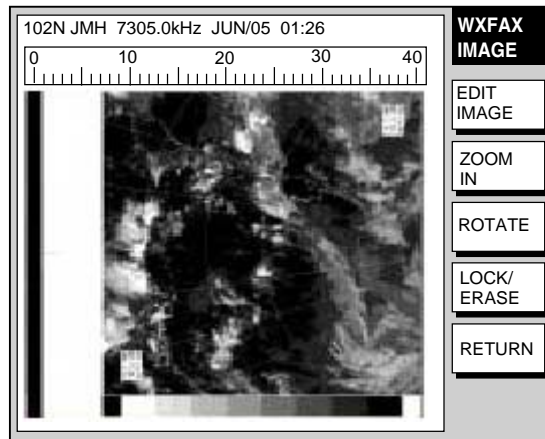

Facsimile image

4. Press the LOCK/ERASE soft key followed by the ERASE IMAGE soft key.

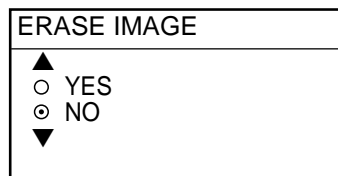

Erase image options

5. Rotate the [ENTER] knob to choose YES and press the ENTER soft key.
6. Press the RETURN soft key several times to return to the standby display.

2.7 Preventing Erasure of Facsimile Images

When facsimile image storage capacity is exceeded, the oldest facsimile image is erased to make room for the latest. If you have an image which you want to keep, you can prevent its erasure by using the “lock image” feature. You can lock all images, however you may not be able to receive a new image if there is not sufficient memory remaining to store the new image.

1. Press the WX FAX key at the standby display.
2. Rotate the [ENTER] knob to select an image and then push the [ENTER] knob or press the SELECT IMAGE soft key.
3. Press the LOCK/ERASE soft key followed by the LOCK IMAGE soft key.
4. Rotate the [ENTER] knob to choose ON and press the ENTER soft key.
5. Press the RETURN soft key several times to return to the standby display.

The locked image's data appears in red at the THUMBNAILS OF RECEIVED IMAGES screen. To release the lock image feature for a particular image, choose OFF at the step 4 in the above procedure.

2.8 Adding Facsimile Channels

The FAX-30 provides a free memory for the user to store 320 channels.

1. Press the [MENU] key to show the FAX-30 menu.

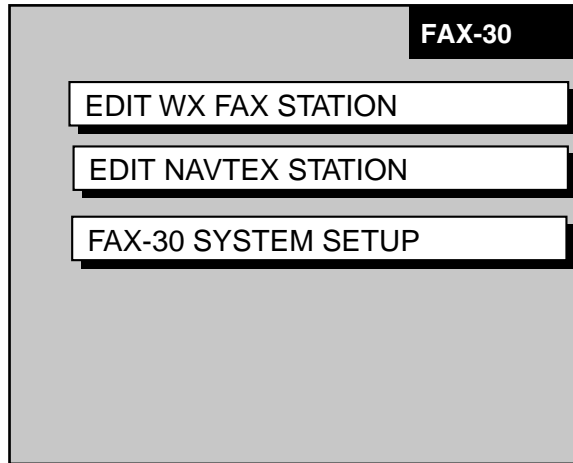

FAX-30 top

2. Press the EDIT WX FAX STATION soft key.

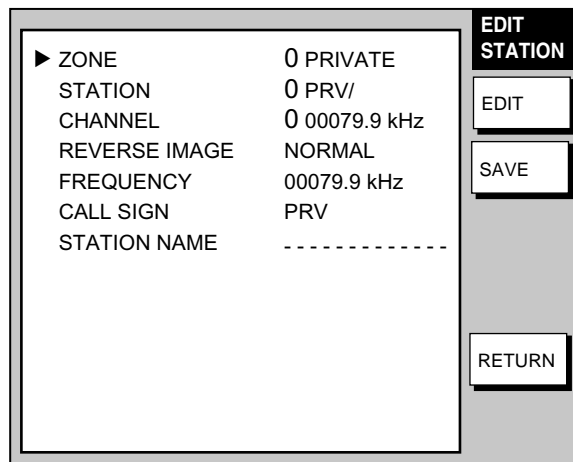

Edit facsimile station menu

3. ZONE is selected; press the EDIT soft key.

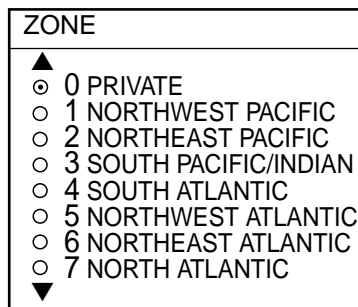

Zone options

4. Rotate the [ENTER] knob to choose a zone and push the EDIT soft key. (Zone 0 and 9 are for user zones.)

5. Rotate the [ENTER] knob to choose STATION and press the EDIT soft key. If the ZONE chosen at step 4 is "1 NORTHWEST PACIFIC," for example, the STATION options are as below.

STATION	
▲	
⊙	0 JMH /TOKYO 1
○	1 JMJ /TOKYO 2
○	2 JJC /KYODO 9MG
○	3 JFA /CHUO GYOGYOU
○	4 3SD /BEIJING
○	5 BAF /BEIJING
○	6 BDF /SHANGHAI
○	7 BMF /TAIPEI
▼	

Station options (Example: stations of northwest pacific)

6. Rotate the [ENTER] knob to choose a station and press the ENTER soft key.
 7. Rotate the [ENTER] knob to choose CHANNEL and press the EDIT soft key.
 If the station chosen at step 8 is "0 JMH/TOKYO No.1," for example, the CHANNEL options are as below.

CHANNEL	
▲	
⊙	AUTO
○	0 03622.5 kHz
○	1 04902.0 kHz
○	2 07305.0 kHz
○	3 09970.0 kHz
○	4 13597.0 kHz
○	5 18220.0 kHz
○	6 23522.9 kHz
▼	

Channel options (Example: JMH/Tokyo)

8. Rotate the [ENTER] knob to choose a channel and press the ENTER soft key.
 9. Rotate the [ENTER] knob to choose REVERSE IMAGE and press the EDIT soft key.

REVERSE IMAGE	
▲	
⊙	NORMAL
○	REVERSE
▼	

Reverse image options

10. The normal facsimile image format has black text on a white background. Some stations, however, print white characters on a black background. This information is programmed into the memory thus you need not designate image format. However, if you are entering frequency data of a newly established station whose image format is reverse of the normal image, rotate the [ENTER] knob to choose REVERSE. Press the ENTER soft key after making your selection.

2. FAX OPERATION: NAVNET

11. If you want to enter a frequency, call sign or station name other than that shown at CHANNEL and STATION, respectively, rotate the [ENTER] knob to choose FREQUENCY, CALL SIGN or STATION NAME as appropriate and press the EDIT soft key. One of the following displays appears depending on your selection.

FREQUENCY	CALL SIGN	STATION NAME
00003.4 kHz	JMH	TOKYO
Frequency	Call Sign	Station Name

Frequency, call sign and station name entry windows

12. Use the alphanumeric keys or the [ENTER] knob to enter appropriate data and press the ENTER soft key. You can shift the cursor by rotating the trackball.
13. Press the SAVE soft key.
14. Rotate the trackball to choose YES and then push the [ENTER] knob.
15. Press the [MENU] key to close the menu.

3. FAX OPERATION: PC

3.1 Automatic Receiving

3.1.1 Starting receiving

1. At the facsimile standby display, click CHANNEL SETUP on the top menu.

The screenshot shows a menu titled "CHANNEL SETUP" with the following fields and options:

- ZONE: 1: NORTHWEST PACIFIC (dropdown menu)
- STATION: 0: JMH/TOKYO 1 (dropdown menu)
- CHANNEL: AUTO (dropdown menu)
- FREQUENCY: 03622.5 kHz (text input field)
- Buttons: OK, RCV STOP, < back

Channel setup menu

2. Click the arrow button on ZONE and choose desired zone.
3. Click the arrow button on STATION and choose desired station. See page AP-2 for station number.
4. Click the arrow button on CHANNEL and choose desired channel. Choose AUTO if you are unsure of channel. (Most stations transmit the same message over several frequencies, so if you are unsure of the channel choose AUTO.)
5. If necessary you may fine tune the frequency. Click anywhere inside the FREQUENCY box and enter frequency.
6. Click OK and then click "<back" or Back button to return to the top menu.

Then, the FAX-30 will receive the next scheduled broadcast from the station selected. When the FAX-30 receives the start signal from the facsimile station it automatically adjusts itself to match speed, IOC (Index of Cooperation) and phase of the station's transmitter. After a facsimile image is received it is compressed and stored in the image memory and then posted on the facsimile standby display screen. This process takes 3-5 minutes.

3.1.2 Stopping receiving

You may stop receiving at any time by doing the following:

1. At the facsimile standby display, click CHANNEL SETUP on the top menu.
2. Click RCV STOP.

3.2 Timer Receiving

Most facsimile stations transmit facsimile signals in accordance with a schedule issued by relative meteorological observatory. (You can find facsimile schedules in the publication “Meteorological Facsimile Broadcasts,” available through meteorological observatory bodies.) If you wish to receive a certain facsimile broadcast on a daily basis, therefore, the timer receiving mode will virtually allow you “hands-off” automatic operation. 30 timer programs may be set.

3.2.1 Setting, changing timer receiving schedule

1. At the facsimile standby display, click TIMER SETUP followed by PROGRAM LIST to show the timer schedule.

No.	Start, end time	Facsimile station	TX frequency of facsimile station	Index Of Cooperation	Drum rotation speed at facsimile station	ON/OFF
1	12:30-14:00	JMH	3662.5kHz	IOC288	60rpm	ON
2	NOT PROGRAMMED					OFF
3	NOT PROGRAMMED					OFF
4	NOT PROGRAMMED					OFF
5	NOT PROGRAMMED					OFF
6	NOT PROGRAMMED					OFF
7	NOT PROGRAMMED					OFF
8	NOT PROGRAMMED					OFF
9	NOT PROGRAMMED					OFF
10	NOT PROGRAMMED					OFF
11	NOT PROGRAMMED					OFF
12	NOT PROGRAMMED					OFF
13	NOT PROGRAMMED					OFF
14	NOT PROGRAMMED					OFF
15	NOT PROGRAMMED					OFF
16	NOT PROGRAMMED					OFF
17	NOT PROGRAMMED					OFF
18	NOT PROGRAMMED					OFF
19	NOT PROGRAMMED					OFF
20	NOT PROGRAMMED					OFF
21	NOT PROGRAMMED					OFF
22	NOT PROGRAMMED					OFF
23	NOT PROGRAMMED					OFF
24	NOT PROGRAMMED					OFF
25	NOT PROGRAMMED					OFF
26	NOT PROGRAMMED					OFF
27	NOT PROGRAMMED					OFF
28	NOT PROGRAMMED					OFF
29	NOT PROGRAMMED					OFF
30	NOT PROGRAMMED					OFF

Timer program list

2. Click the location in the center column of the timer program list corresponding to the timer program no. you want to set. For example, click the center column of No.2. The following timer program menu appears.

TIMER PROGRAM No.2

ZONE 1: NORTHWEST PACIFIC ▼

STATION 0: JMH/TOKYO 1 ▼

CHANNEL AUTO ▼

IOC AUTO ▼

SPEED AUTO ▼

START TIME 00 00

END TIME 00 00

FREQUENCY 00000.0 kHz

ON OFF

[< back](#)

Timer program menu

3. Click the arrow button on ZONE and choose desired zone.
4. Click the arrow button on STATION and choose desired station.
5. Click the arrow button on CHANNEL and choose desired channel. (Most stations transmit the same message over several frequencies, so if you are unsure of the channel choose AUTO.)
6. Click the arrow button on IOC and choose desired IOC. IOC stands Index of Cooperation and is the line density standard assigned by WMO: IOC 576, high density, IOC 288, low density. If you are unsure of the IOC, choose AUTO for automatic selection of IOC.
7. Click the arrow button on SPEED and choose desired speed. This is the drum rotating speed at the facsimile station. If you are unsure of the speed, choose AUTO for automatic selection of speed.
8. Key in the start time in 24-hour notation. Key in a start time about two minutes earlier than actual start time to allow for detection of the start signal and press the ENTER soft key.
9. Key in the end time in 24-hour notation and press the ENTER soft key. Key in an end time about two minutes later than actual end time to allow for detection of the stop signal.

Note: Two programs which overlap each other will cause the program having the later start time to be disregarded. For example, if the start and end times of program no. 1 are 01:00 and 02:00 and those of program no. 2 are 01:30 to 3:00, program no. 2 will be disregarded.

10. If necessary you may fine tune the frequency at FREQUENCY.

3. FAX OPERATION: PC

11. Click ON below FREQUENCY.
12. Click OK.
13. Click "<back" or Back button several times to return to the top menu.
14. Repeat steps 1-13 to set other timer schedule.
15. At the facsimile standby display, click TIMER SETUP.
16. Click PROGRAM LIST.
17. Click START.
18. Click OK.
19. Click "<back" or Back button to return to the top menu.

Then, the FAX-30 will receive facsimile broadcasts according to the timer schedule. Facsimile images are received line by line, taking 30-40 minutes to receive depending on the size of the image and drum rotation speed at the facsimile station. After a facsimile image is received it is compressed and stored in the image memory and then posted on the facsimile standby display screen. This process takes 3-5 minutes.

3.2.3 Turning on/off specific timer programs

1. At the facsimile standby display, click TIMER SETUP.
2. Click PROGRAM LIST.
3. Click the center column of the program no. you want to turn on or off.
4. Click ON or OFF as appropriate.
5. Click OK.
6. Click "<back" or Back button to return to the top menu.

3.2.4 Clearing all timer programs

You may clear all timer programs as follows:

1. At the facsimile standby display, click TIMER SETUP.
2. Click PROGRAM LIST.
3. Click CLEAR ALL at the top of the screen.
4. You are asked "Are you sure to clear all?"
5. Click Yes to reset; Cancel to escape.
6. Click "<back" or Back button to return to the top menu.

3.3 Displaying Facsimile Images

1. Show the facsimile standby display. Thumbnails of images received are shown on the display. The equipment stores as many as 12 images, on two pages. When the image storage capacity is exceeded, the oldest image is automatically deleted to make room for the latest.

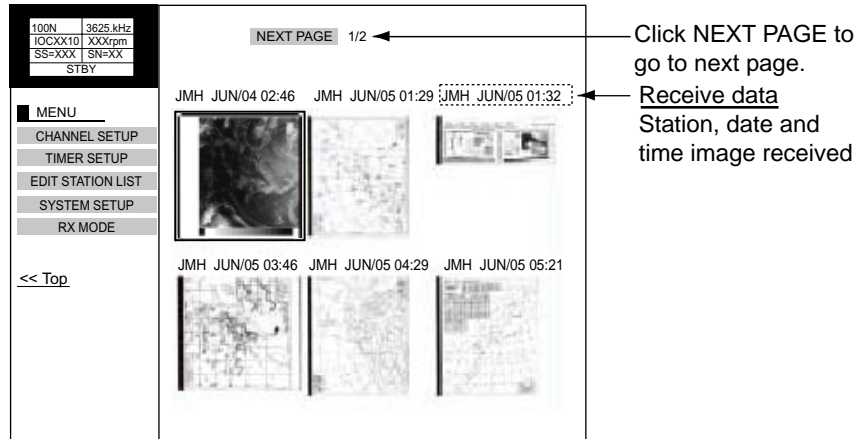

Facsimile standby display

2. Click desired image.

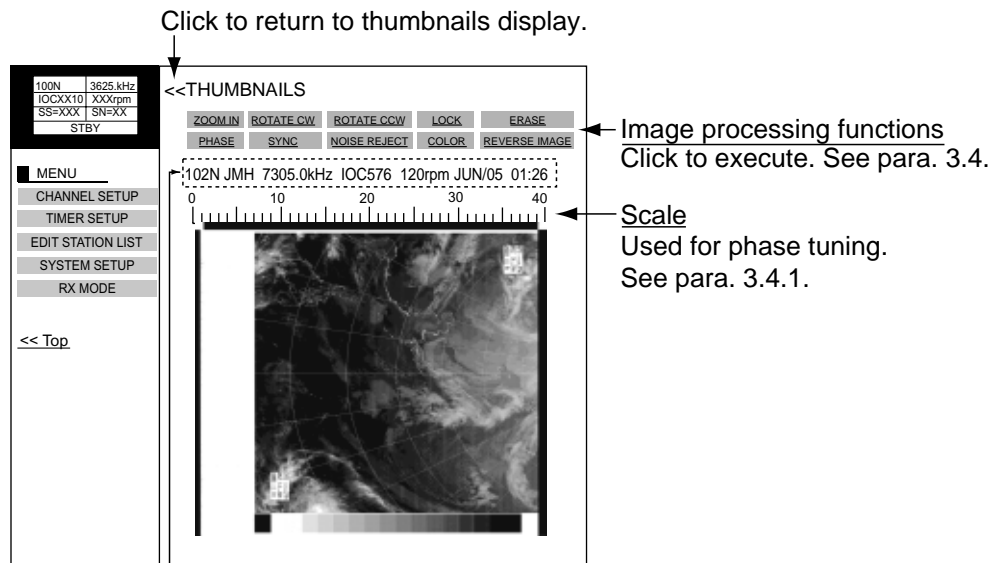

Image data
 102N: Zone
 JMH: Station
 7305.0 kHz: Channel
 IOC576: Index of Cooperation
 120 rpm: Drum speed at fax station
 JUN/05: Date received
 01:26: Time received

Facsimile image

Note: If the FAX-30 is not accessed from the PC after it has been turned on, time data is not sent to the FAX-30. The timer recording feature may receive a facsimile image using incorrect time data, however the image may not be correctly stored.

3.4 Processing Facsimile Images

3.4.1 Phase mismatch

When the FAX-30 starts receiving a broadcast already in progress, or noise prevents detection of the phasing signal, the image may be divided into two parts by a thick black (or white) stripe called a dead sector. This phenomenon is due to phase mismatching. When this occurs, correct phase mismatching, after the facsimile has been received.

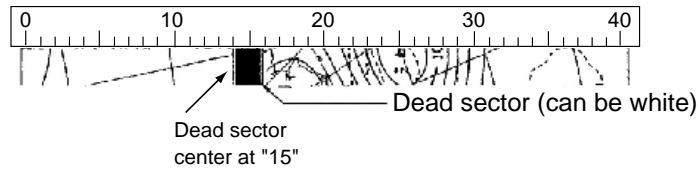

Example of phase mismatching

1. With a facsimile image displayed, click PHASE.

A rectangular window titled 'PHASE' with a black header bar. Below the header is a dropdown menu showing '0'. At the bottom of the window are two buttons: 'OK' and '< back'.

Phase entry window

2. Read the scale to find the center of the dead sector and enter it in the phase entry window. For example, if dead sector is centered at "15" on the scale, as in the illustration at the top of the page, enter "15". The setting range is 00 to 40.
3. Click OK and then click "<back" or Back button to return to the top menu.

3.4.2 Phasing signal out of synchronization

The SYNC soft key functions to fine tune the phasing signal. If the dead sector is plotted at an angle even when the phase is properly selected, adjust the synchronization to display the dead sector straightly.

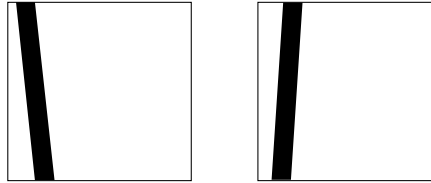

Example of phasing signal out of synchronization

1. With a facsimile image displayed, click SYNC.

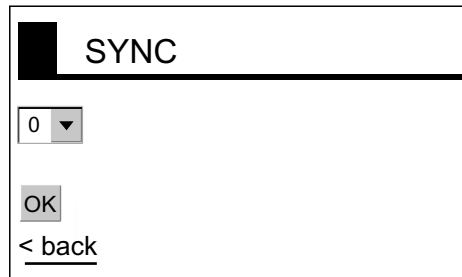

Sync options

2. Enter a sync value that displays the dead sector straightly and then click OK. If the dead sectors appears as in the left-hand figure above, enter a larger value and for the right-hand figure, enter a smaller value. The setting range is –50 to +50.
3. Click OK and then “<back” or Back button to return to the top menu.

3.4.3 Noise rejection

If noise speckles appear on the image, turn on the noise rejector as below to remove the noise.

1. With a facsimile image displayed, click NOISE REJECT.

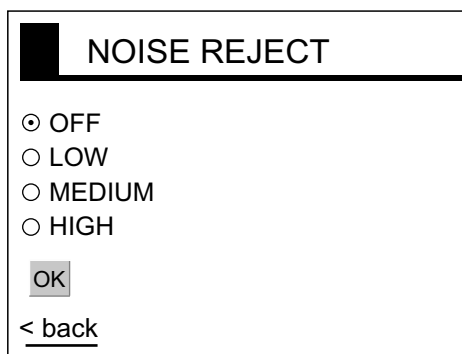

Noise rejector options

2. Click the noise rejection level desired and then click OK. HIGH provides the greatest degree of noise rejection.
3. Click OK and then “<back” or Back button to return to the top menu.

3.4.4 Image color

The facsimile image is transmitted in monochrome (black and white) or gray scale (16 gradations). After an image has been received, you can choose the color arrangement among monochrome, gray scale and color (three patterns).

1. With a facsimile image displayed, click COLOR.

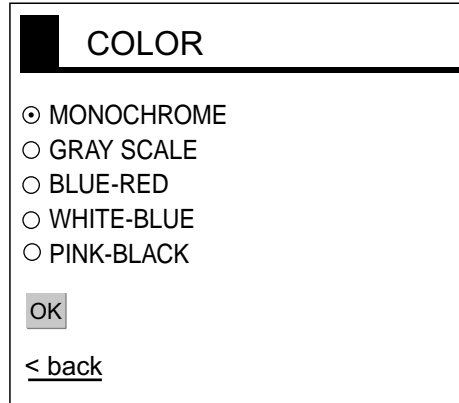

Color options

2. Click MONOCHROME, GRAY SCALE, BLUE-RED, WHITE-BLUE or PINK-BLACK as appropriate.
MONOCHROME: Monochrome black and white
GRAY SCALE: 16 gray tones (eight gray tones when power is turned off and on again)
BLUE-RED: Shades of blue to red
WHITE-BLUE: Shades of white to blue
PINK-BLACK: Shades of pink to black
3. Click OK and then click "<back" or Back button to return to the top menu.

3.4.5 Image format

The facsimile image is usually transmitted with black text on a white background. Some stations, however, print white characters on a black background. If, for some reason, the image received cannot be read in its transmitted image format you may change it as follows:

1. With a facsimile image displayed, click REVERSE IMAGE.

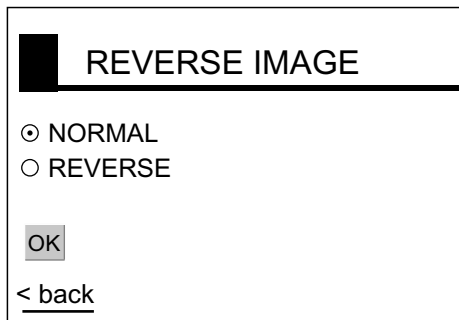

Reverse image options

2. Click NORMAL or REVERSE as appropriate.
3. Click OK and then click "<back" or Back button to return to the top menu.

3.4.6 Rotating images

With a facsimile image displayed, click ROTATE CW or ROTATE CCW as appropriate. The image is rotated 90° in the direction selected.

3.4.7 Zooming images

You may double the size of a facsimile image as follows:

1. Display the facsimile image you wish to process.
2. Click ZOOM IN.

To restore the normal size image, click ZOOM OUT.

3.4.8 Saving images

You may save images to your PC for future reference.

1. At the thumbnails display, click the facsimile image you wish to save.
2. Click ZOOM IN to enlarge the image. (The image is too small if not enlarged.)
3. Place the cursor on the facsimile image and click the right button on the mouse.
4. Click the "Save Picture As..." The "Save" window appears.
5. Choose directory, enter file name and click the Save button.

3.5 Erasing Facsimile Images

You may erase facsimile images as below.

1. Display the facsimile image you wish to erase.
2. Click ERASE.
3. You are asked if you are sure to erase the image. Click OK to erase the image; Cancel to escape.

3.6 Preventing Erasure of Facsimile Images

When facsimile image storage capacity is exceeded, the oldest facsimile image is erased to make room for the latest. If you have an image which you want to keep, you can prevent its erasure by using the “lock” feature. You can lock all images, however you may not be able to receive a new image if there is not sufficient memory remaining to store the new image.

1. Display the facsimile image you want to lock.
2. Click LOCK.

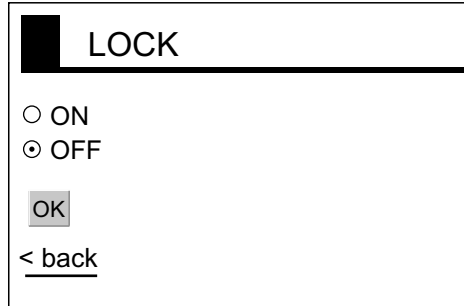

Lock options

3. Choose ON.
4. Click OK and then click “<back” or Back button to return to the top menu.

The locked image’s data appears in red, at the facsimile standby display. To release the lock feature for a particular image, choose OFF at the step 3 in the above procedure.

3.7 Adding Facsimile Channels

The FAX-30 provides a free memory for the user to store 320 channels.

1. At the standby display, click EDIT STATION LIST.

EDIT STATION LIST

ZONE	0: PRIVATE ▼
STATION	0: PRV/ ▼
CHANNEL	0: 79.9 kHz ▼
REVERSE IMAGE	NORMAL ▼
FREQUENCY	79.9 kHz
CALL SIGN	PRV
STATION NAME	

[< back](#)

Edit station list menu

2. Click the arrow button on ZONE and choose desired zone.
3. Click the arrow button on STATION and choose desired station.
4. Click the arrow button on CHANNEL and choose desired image format.
5. The normal facsimile image format has black text on a white background. Some stations, however, print white characters on a black background. This information is programmed into the memory thus you need not designate image format. However, if you are entering frequency data of a newly established station whose image format is reverse of the normal image, choose REVERSE.
6. If necessary, you may fine tune the frequency shown in FREQUENCY.
7. Enter station's CALL SIGN.
8. Enter STATION'S NAME.
9. Click OK.
9. Click "<back" or Back button to return to the top menu.

3. FAX OPERATION: PC

(This page intentionally left blank.)

4. NAVTEX OPERATION: NAVNET

4.1 About Navtex Messages

4.1.1 Message categories

Navtex stations throughout the world provide mariners with weather and navigational navtex messages. These messages carry a four character header code which identifies transmitting station, category of message, and message number, numbered from 00 to 99. Message number 00 is reserved for important emergency messages. The categories of messages available in the navtex system are as below.

A: Coastal navigational warning	H: Loran message
B: Meteorological warning	I: Omega message
C: Ice report	J: Differential Omega message
D: Search and Rescue Alert	K: Other electronic navigator system message
E: Meteorological forecast	L: Navarea warnings
F: Pilot message	V to Y: No category allocated
G: Decca message	Z: QRU (no message on hand)

The user may select which message categories to receive and the stations from which to receive them.

Note: It is recommended to minimally receive categories A, B, D and L because they are important for navigation.

4.1.2 Receiving navtex messages

To receive navtex messages, set the receive mode for “navtex only” or “fax(timer) & navtex”, referring to paragraph 1.1.3 for the procedure.

4.2 Setting Up Navtex Stations, Messages, Alarms

You may freely select the navtex stations from which to receive and the messages categories to receive. Further, you may enable or disable received message alarms.

1. At the standby display, press the NAVTEX soft key. If you have received some navtex messages, their data are shown as below.

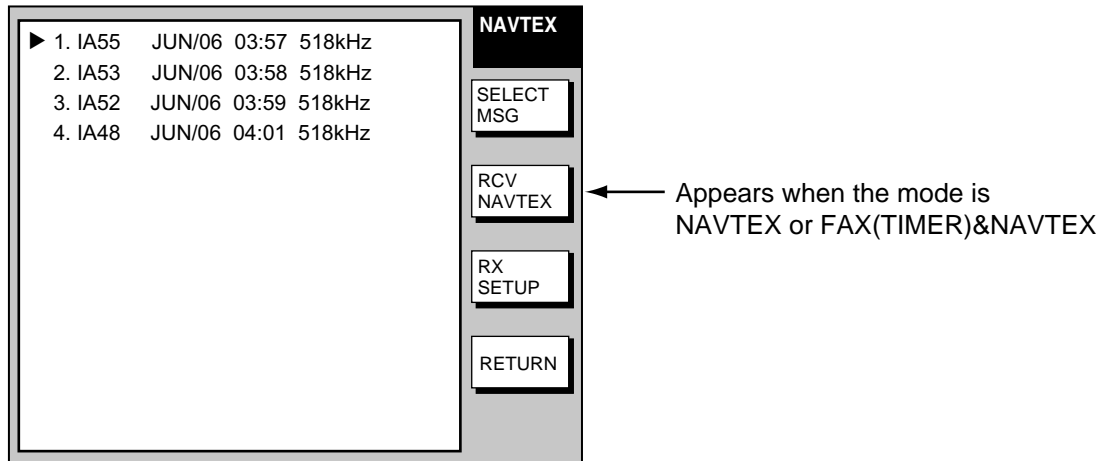

Navtex message data display

2. Press the RX SETUP soft key.

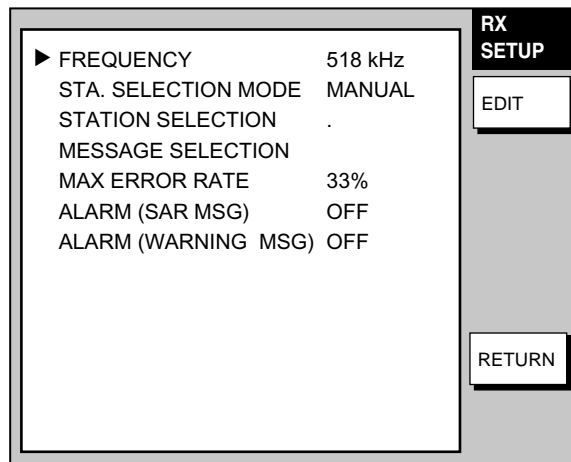

RX setup menu

3. FREQUENCY is selected, press the EDIT soft key.

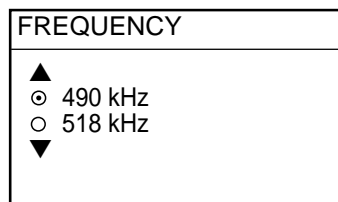

Navtex frequency options

4. Rotate the [ENTER] knob to choose 490 kHz or 518 kHz depending on the station and press the ENTER soft key.

- Rotate the [ENTER] knob to choose STA. SELECTION MODE and press the EDIT soft key.

STA. SELECTION MODE	
▲	
○	MANUAL
◉	AUTO
▼	

Navtex station mode options

- Rotate the [ENTER] knob to choose navtex station selection method and press the [ENTER] soft key. AUTO requires position data, output through the network using the data sentence GGA or GLL. (See page 1-2.)
- If you selected MANUAL at step 6, rotate the [ENTER] knob to choose STATION SELECTION and press the EDIT soft key, to choose station(s) from which to receive. For AUTO, go to step 9.

STATION SELECTION	
▲	
<input checked="" type="checkbox"/>	A
<input checked="" type="checkbox"/>	B
<input checked="" type="checkbox"/>	C
<input checked="" type="checkbox"/>	D
<input checked="" type="checkbox"/>	E
<input checked="" type="checkbox"/>	F
<input checked="" type="checkbox"/>	G
<input checked="" type="checkbox"/>	H
▼	

Navtex station options

- Select or deselect stations as desired: Rotate [ENTER] knob to choose station and push it to select or deselect. Check mark indicates station is selected; no check mark means deselected.
- Press the ENTER soft key to return the RX SETUP menu.
- Rotate the [ENTER] knob to choose MESSAGE SELECTION and press the EDIT soft key.

MESSAGE SELECTION	
▲	
<input checked="" type="checkbox"/>	A NAVIGATIONAL WARNING
<input checked="" type="checkbox"/>	B METEOR. WARNING
<input checked="" type="checkbox"/>	C ICE REPORT
<input checked="" type="checkbox"/>	D SAR INFORMATION
<input checked="" type="checkbox"/>	E METEOR. FORECAST
<input checked="" type="checkbox"/>	F PILOT MESSAGE
<input checked="" type="checkbox"/>	G DECCA MESSAGE
<input checked="" type="checkbox"/>	H LORAN MESSAGE
▼	

Navtex message options

- Select or deselect message categories as desired: Rotate [ENTER] knob to choose message category and push it to select or deselect. Check mark indicates message is selected; no check mark means deselected.
- Press the ENTER soft key.
- Rotate the [ENTER] knob to choose MAX ERROR RATE and press the EDIT soft key.

4. NAVTEX OPERATION: NAVNET

MAX ERROR RATE
33%

Max error rate entry window

14. Rotate the [ENTER] knob to enter maximum allowable error rate to use. The setting range is 0-33%. Any message with an error rate higher than that entered here will be rejected.
15. Press the ENTER soft key.
16. Rotate the [ENTER] knob to choose ALARM (SAR MSG) and press the EDIT soft key.

ALARM (SAR MSG)
▲ <input type="radio"/> ON <input checked="" type="radio"/> OFF ▼

Alarm (SAR MSG) options

17. Rotate the [ENTER] knob to choose ON to get the audio alarm when an SAR (Search and Rescue) message is received, or OFF for no audio alarm when an SAR message is received.

Note: Message category D must be selected to get the audio alarm.

18. Press the ENTER soft key.
19. Rotate the [ENTER] knob to choose ALARM (WARNING MSG) and press the EDIT soft key.

ALARM (WARNING MSG)
▲ <input type="radio"/> ON <input checked="" type="radio"/> OFF ▼

Alarm (warning msg) options

20. Rotate the [ENTER] knob to choose ON to get the audio alarm when an A, B, or L category message is received, or choose OFF for no audio alarm.

Note: Message category A, B or L must be selected to get the audio alarm.

21. Press the [RETURN] soft key.

Note: When the above alarms are enabled, the audio alarm sounds and the speaker icon (🔊) appears when an SAR message or category A, B, D or L message is received. Press the [CLEAR] key to silence the audio alarm. You can see which type of message you have received by pressing the [ALARM] key to display the alarm message board.

4.3 Previewing Incoming Navtex Messages

If you want to view a navtex message while it is being received, do the following:

1. At the standby display, press the NAVTEX soft key. If no messages have been received the display shows "NO RECEIVED MESSAGES AVAILABLE."

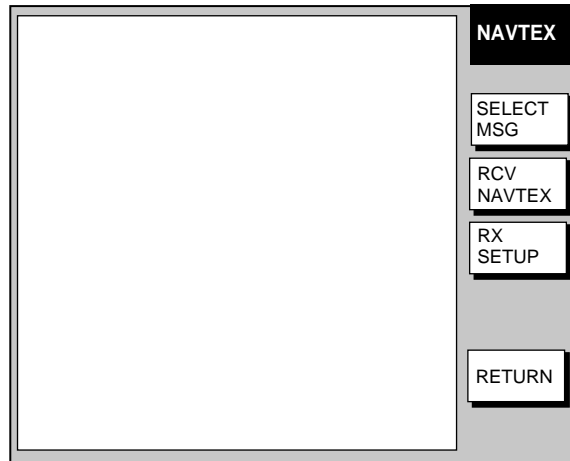

Navtex message selection screen

2. Press the RCV NAVTEX soft key.

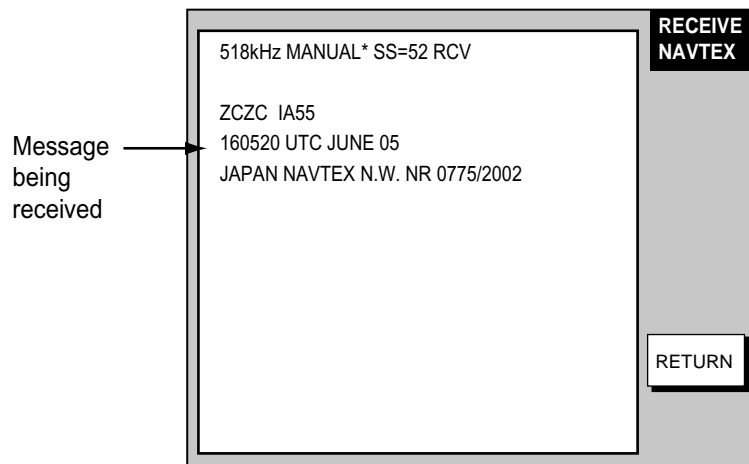

* = "AUTO LAT/LON" and OK or NG (No Good) shown in automatic reception.

Navtex message preview display

3. Press the RETURN soft key several times to return to standby display.

4.4 Displaying Navtex Messages

4.4.1 Displaying navtex messages

- At the standby display, press the NAVTEX soft key.

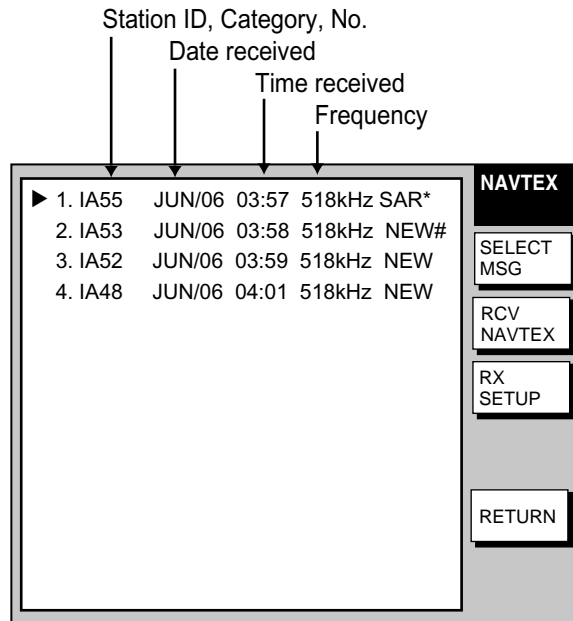

* = "SAR" denotes SAR message.

= NEW means unread message, and it disappears when the power is turned off.

Navtex message selection screen

- Rotate the [ENTER] knob to choose the message to display.
- Press the SELECT MSG soft key or push the [ENTER] knob.

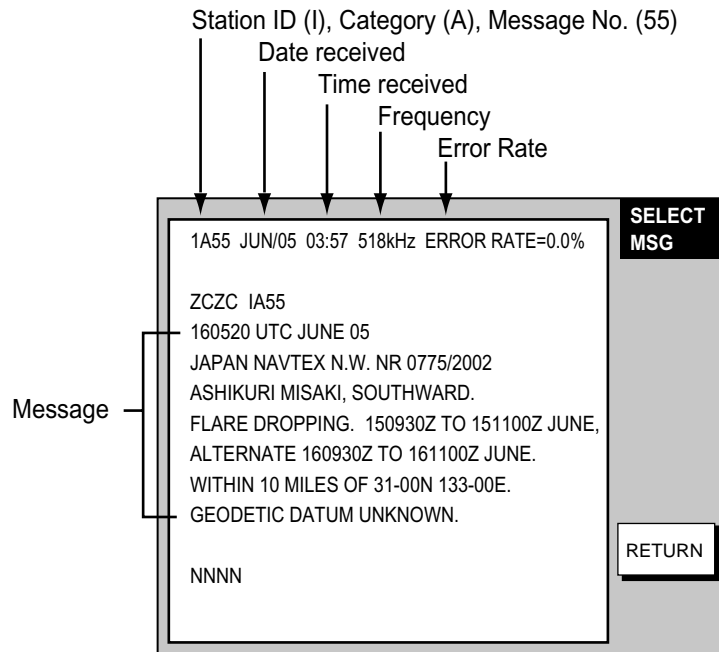

Sample navtex message

- Press the RETURN soft key several times to return to the standby display.

4.4.2 Remarks on navtex messages

- All navtex messages begin with “ZCZC” (navtex message ID) and end with “NNNN”. Immediately following ZCZC, the transmitting station ID, message category and message number are shown. In the example illustration at the bottom of the previous page this data is “IA55.”

I = Transmitting station's ID

A = Message category

55 = Message number

- An asterisk (*) is displayed in place of actual character when the character could not be read.
- Message number 00 contains important emergency information.
- The FAX-30 holds 130 navtex messages. When the navtex message storage capacity is exceeded, the oldest navtex message is automatically deleted to make room for the latest.

4.5 Displaying the Navtex Station List

You may display the navtex stations stored in the FAX-30, as follows:

1. Press the [MENU] key to open the FAX-30 menu.
2. Press the EDIT NAVTEX STATION soft key.
3. Press the 490 kHz STATION LIST soft key or the 518 kHz STATION LIST soft key as appropriate. The illustration below shows the nav areas for 490 kHz.

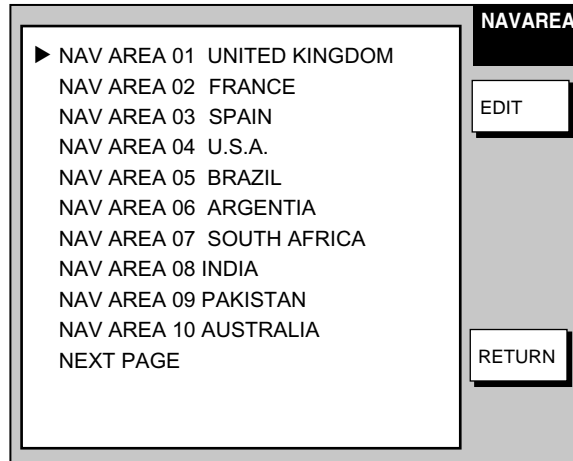

Nav areas for 490 kHz navtex stations

4. Choose nav area desired and push the [ENTER] knob. For example, choose nav area 01 of 490 kHz to show the 490 kHz station list.
(To choose nav area 11 to 16, choose NEXT PAGE and push the [ENTER] knob.)

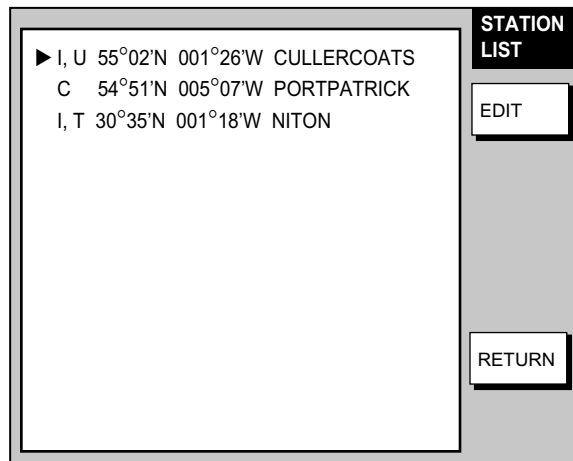

490 kHz stations of nav area 1

5. If you want to view or edit the contents of a navtex station, rotate the [ENTER] knob to choose a station and press EDIT soft key. Follow the instructions in the previous paragraph to edit a station.
6. Press the [MENU] key to return to the standby screen.

4.6 Adding Navtex Stations

You may add newly established navtex stations to the navtex station list as follows:

1. Press the [MENU] key to open the FAX-30 menu.
2. Press the EDIT NAVTEX STATION soft key.

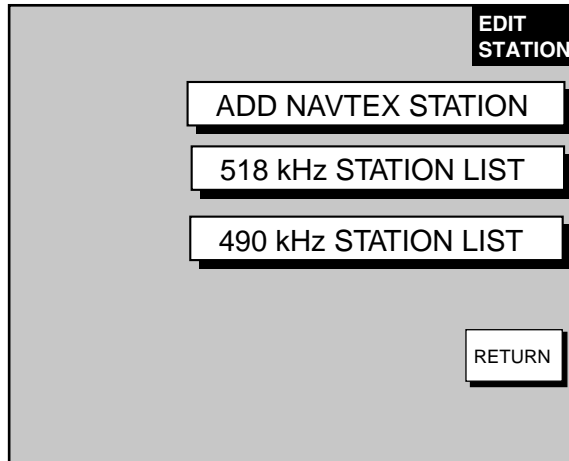

Edit station menu

3. Press the ADD NAVTEX STATION soft key.

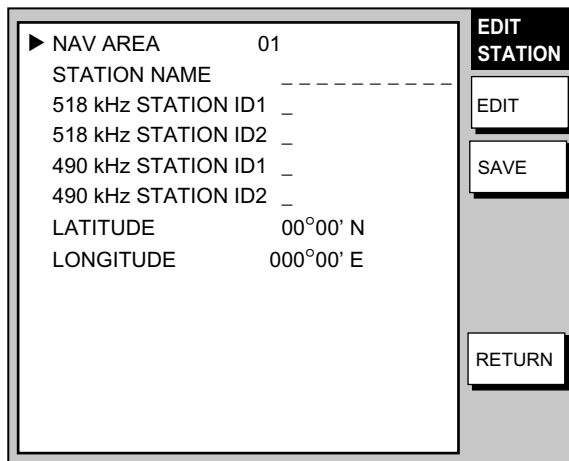

Edit navtex station menu

4. NAV AREA is selected; press the EDIT soft key.

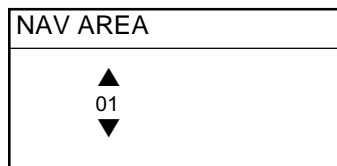

Nav area selection window

5. Choose appropriate area, referring to the navtex station map in the Appendix, and press the ENTER soft key.

4. NAVTEX OPERATION: NAVNET

6. Rotate the [ENTER] knob to choose STATION NAME and press the EDIT soft key.

STATION NAME
■-----

Station name entry window

7. Enter station name with the alphanumeric keys and trackball and then press the ENTER soft key.
8. Rotate the [ENTER] knob to choose 518 STATION ID1 or 490 STATION ID1 as appropriate and press the EDIT soft key.

518 kHz STATION ID1
■

Station ID1 entry window

9. Enter station ID (A-Z) and press the ENTER soft key.
10. If there are multiple stations, enter station ID in 518 kHz STATION ID2 or 490 kHz STATION ID2 as appropriate.
11. Rotate the [ENTER] knob to choose LATITUDE and press the EDIT soft key.

LATITUDE
00°00' N

Latitude entry window

12. Enter the latitude of the station and press the ENTER soft key. Use the [N↔S] soft key to switch from North latitude to South latitude and vice versa.
13. Rotate the [ENTER] knob to choose LONGITUDE and press the EDIT soft key. Enter longitude of the station similar to how you entered latitude. Use the [W↔E] soft key to switch from West longitude to East longitude and vice versa.
14. Press the SAVE soft key.
15. Rotate the [ENTER] knob to choose YES and then push the [ENTER] knob.
16. Press the [MENU] key to close the menu.

5. NAVTEX OPERATION: PC

5.1 About Navtex Messages

5.1.1 Message categories

Navtex stations throughout the world provide mariners with weather and navigational navtex messages. These messages carry a four character header code which identifies transmitting station, category of message, and message number, numbered from 00 to 99. Message number 00 is reserved for important emergency messages. The categories of messages available in the navtex system are as below.

A: Coastal navigational warning	H: Loran message
B: Meteorological warning	I: Omega message
C: Ice report	J: Differential Omega message
D: Search and Rescue Alert	K: Other electronic navigator system message
E: Meteorological forecast	L: Navarea warnings
F: Pilot message	V to Y: No category allocated
G: Decca message	Z: QRU (no message on hand)

The user may select which message categories to receive and the stations from which to receive them.

Note 1: It is recommended to minimally receive categories A, B, D and L because they are important for navigation.

Note 2: To learn more about navtex messages, see paragraph 4.4.2.

5.1.2 Receiving navtex messages

To receive navtex messages, set the receive mode for “navtex only” or “fax & navtex”, referring to paragraph 1.2.2 for the procedure.

5.2 Setting Up Navtex Stations, Messages

You may freely select the navtex stations from which to receive and the messages categories to receive as follows:

1. At the navtex top menu, click RX SETUP.

█
RX SETUP

FREQUENCY 518 kHz ▾

STATION SELECTION MODE MANUAL ▾

STATION ID SELECTION

A B C D

E F G H

I J K L

M N O P

Q R S T

U V W X

Y Z

490 kHz STATION LIST

518 kHz STATION LIST

MESSAGE ID SELECTION

A B C D

E F G H

I J K L

M N O P

Q R S T

U V W X

Y Z

MESSAGE LIST

MAX. ERROR RATE (0- 33 % 33%)

OK

[< back](#)

RX setup menu

2. Click the arrow button on FREQUENCY and choose desired frequency.
3. Click the arrow button on STATION SELECTION MODE and choose desired mode, AUTO or MANUAL.

AUTO requires connection to the NavNet network and is not available in the PC-only configuration. The FAX-30 requires position data (data sentence GGA or GLL) and time data (data sentence ZDA), fed through the NavNet network.

4. Click desired stations in STATION ID SELECTION. Check mark indicates item is selected. (If you need help with station selection, click 490 kHz STATION LIST or 518 kHz STATION LIST for details.)
5. Check desired messages in MESSAGE ID SELECTION. Check mark indicates item is selected. (If you need help with message selection, click MESSAGE LIST for details.)
6. At MAX. ERROR RATE, enter the maximum allowable error rate to use. The setting range is 0-33 (%). Any message with an error rate higher than entered here will be rejected.
7. Click OK and then click "<back" or Back button to return to the top menu.

5.3 Displaying Navtex Messages

At the navtex standby display, click the desired message number at the top of the display.

Received messages (click to display)

Use scroll bar to scroll list.

Navtex message data
 1A55: Station ID (I), Category (A),
 Message No. (55)
 06/05: Date received
 03:57: Time received
 518kHz: Frequency
 Error rate

Text of message

Navtex standby display

5.4 Displaying the Navtex Station List

You may display the navtex stations stored in the FAX-30 as follows:

1. At the navtex top menu, click EDIT STATION LIST.
2. Click 490 kHz STATION LIST or 518 kHz STATION LIST as appropriate. The illustration below shows the 490 kHz list.

490kHz STATION LIST

NAVAREA ▼

STATION LIST	
I, U	55° 02'N 001° 26'W CULLERCOATS
S	54° 51'N 005° 07'W PORTPATRICK
I, T	50° 35'N 001° 18'W NITON

Navtex station list

3. Pull down the arrow button on NAVAREA to choose nav area desired.

5.5 Adding Navtex Stations

You may add newly established navtex stations to the navtex station list as follows:

1. At the navtex standby display, click EDIT STATION LIST.

|
EDIT STATION LIST

NAVAREA	<input type="text" value="1"/>	<input type="button" value="▼"/>
STATION NAME	<input style="width: 100%;" type="text"/>	
518kHz STATION ID1	<input style="width: 100%;" type="text"/>	
518kHz STATION ID2	<input style="width: 100%;" type="text"/>	
490kHz STATION ID1	<input style="width: 100%;" type="text"/>	
490kHz STATION ID2	<input style="width: 100%;" type="text"/>	
LATITUDE	<input style="width: 20px;" type="text" value="00"/>	<input style="width: 20px;" type="text" value="00"/> <input type="button" value="N"/> <input type="button" value="▼"/>
LONGITUDE	<input style="width: 20px;" type="text" value="000"/>	<input style="width: 20px;" type="text" value="00"/> <input type="button" value="E"/> <input type="button" value="▼"/>

490 kHz STATION LIST

518 kHz STATION LIST

< back

Edit station list

2. Click the arrow button on NAVAREA and choose desired navarea.
3. Enter the station name in STATION NAME.
4. Enter station ID (A-Z) in STATION ID1 (and STATION ID2 if it has two IDs).
5. Enter latitude and longitude position of station.
6. Click ADD to register data entered.
7. To register another station, click NEW and repeat steps 2-6.
8. Click "<back" or Back button to return to the navtex top menu.

5.6 Editing Navtex Stations

You may edit navtex stations as follows:

1. At the navtex standby display, click EDIT STATION LIST.
2. Click 490 kHz STATION LIST or 518 kHz STATION LIST, whichever you want to process. For example, click 490 kHz STATION LIST.
3. Click the arrow button on NAVAREA and choose desired navarea. For example, choose UNITED KINGDOM.
4. In the station list, click the station to process. For example, click CULLERCOATS.

If you want to register a new station from this screen, click NEW. The screen shown on page 5-5 appears. Follow the procedure on page 5-5.

E
EDIT STATION LIST

NAVAREA

STATION NAME

518kHz STATION ID1

518kHz STATION ID2

490kHz STATION ID1

490kHz STATION ID2

LATITUDE

LONGITUDE

[< back](#)

Edit station list

5. Edit the data.
6. Click SAVE to save data.
7. Click "<back" or Back button to return to the navtex top menu.

5.7 Deleting Navtex Stations

You may delete navtex stations from the navtex station list as below.

1. At the navtex standby display, click EDIT STATION LIST.
2. Click 490 kHz STATION LIST or 518 kHz STATION LIST, whichever you want to process.
3. Click the arrow button on NAVAREA and choose desired navarea.
4. In the station list, click the station to process.
5. Click ERASE.
6. Click OK to erase the station, or the Cancel button to escape.
7. Click "<back" or Back button to return to the navtex top menu.

5. NAVTEX OPERATION: PC

(This page intentionally left blank.)

6. MAINTENANCE, TROUBLESHOOTING

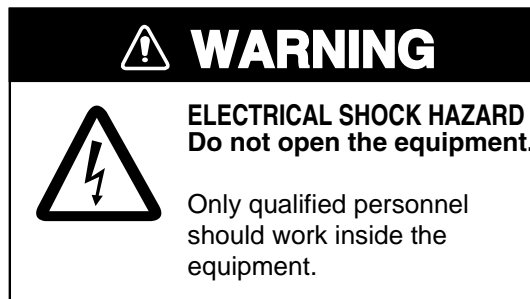

6.1 Maintenance

This unit is designed and manufactured to provide many years of trouble-free performance. However, no machine can perform to the utmost of its ability unless properly maintained. A maintenance program should be established and it should include the items listed in the table below.

Maintenance points

Check Point	Action
Whip antenna	Check for damage. Replace if damaged.
Antenna wire	Check for damage. Replace if damaged.
Junction between whip antenna and preamp (option)	Check for corrosion and tight connection. Clean and waterproof with sealing compound if necessary.
Coaxial cable	Check for damage and tight connection. Replace if damaged.
Power cable	Check for tight connection at battery and FAX-30.
Ground terminal	Check for tight connection and corrosion. Replace if corroded.
Unit cleanliness	Dust and dirt should be removed with a soft cloth. Do not use solvents such as benzene and toluene to clean the unit – they can remove paint and markings or deform the equipment.

6.2 Replacement of Fuse

The 2A fuse in the power cable protects the equipment from equipment fault and reverse polarity of the ship's mains. If the fuse blows find the cause before replacing it. If it blows again after replacement, contact your dealer for advice.

 CAUTION
Use the proper fuse.
Use of a wrong fuse may cause serious damage to the equipment and void the warranty.

6.3 Troubleshooting

This section provides simple troubleshooting that the user may follow to restore normal operation.

Troubleshooting

Trouble	Problem	Remedy
NavNet display unit freezes	<ul style="list-style-type: none"> • Jumbled memory 	<ul style="list-style-type: none"> • Turn the NavNet display unit off and on again.
Command from NavNet display unit not accepted	<ul style="list-style-type: none"> • Network not connected 	<ul style="list-style-type: none"> • Reselect the FAX mode.
Cannot read characters	<ul style="list-style-type: none"> • Corrupted memory 	<ul style="list-style-type: none"> • Clear memory.
Noise but no signal	<ul style="list-style-type: none"> • Loosened antenna connector • Coaxial cable in antenna cable is shorted or damaged. 	<ul style="list-style-type: none"> • Fasten antenna connector. • Replace antenna cable.
Multiple or overlapped image	<ul style="list-style-type: none"> • Wrong speed setting 	<ul style="list-style-type: none"> • Set correct speed. Speed may be adjusted when manually receiving an image.
Image is split.	<ul style="list-style-type: none"> • Image is out of phase. 	<ul style="list-style-type: none"> • Set phase manually.
Image is shrunk (or enlarged) vertically.	<ul style="list-style-type: none"> • Wrong IOC 	<ul style="list-style-type: none"> • Change IOC. IOC may be adjusted when manually receiving an image.
Image is filled with noise.	<ul style="list-style-type: none"> • Noise 	<ul style="list-style-type: none"> • Use the noise rejector to remove noise.
Timer schedule does not start as scheduled.	<ul style="list-style-type: none"> • Improper setting of schedule 	<ul style="list-style-type: none"> • Review schedule.
Cannot access FAX-30 from PC.	<ul style="list-style-type: none"> • Incorrect IP address or subnet mask set on PC. 	<ul style="list-style-type: none"> • Check setting referring to page 7-8.

6.4 Diagnostics: NavNet

The diagnostics test displays program no. and tests the ROMs, RAM, receive ability, signal strength, signal-to-noise ratio and position data. The test results are displayed as OK or NG (No Good) for ROM, RAM, receive ability and position data. For any NG or abnormal value, contact your dealer for advice.

1. Press the [MENU] key to show the FAX-30 menu.

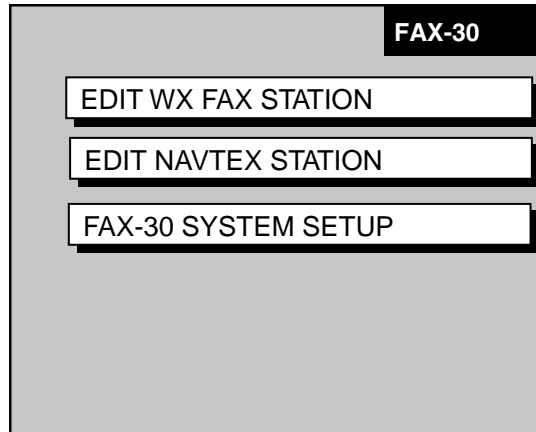

FAX-30 menu

2. Press the FAX-30 SYSTEM SETUP soft key.

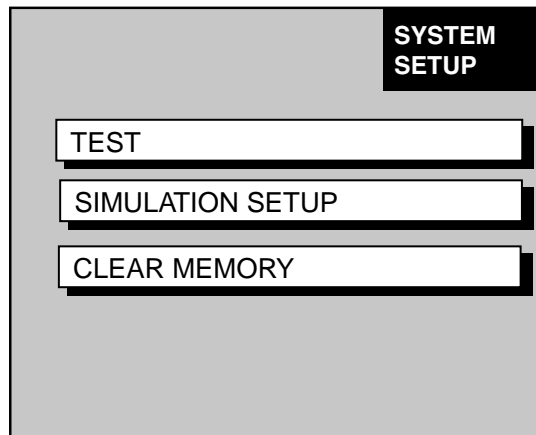

System setup menu

- Press the TEST soft key to start the test. The test results appears as shown below.

Asterisk marks item currently being tested

PROGRAM NO.	0850188-XX
	0850189-XX
* ROM1	: OK
ROM2	: OK
SDRAM	: OK
RECEIVE UNLOCK	: OK
SS*1	: 60
SN*2	: 60
LAT/LON*3	: OK

TEST

XX = Version no.

*1 SS = Signal Strength
Display Range: 0-99
Typical Reading: 30-70

*2 SN = Signal-to-Noise Ratio
Display Range: 0-99
Typical Reading: 20-60

*3 Requires data sentence
GGA or GLL, output
through the network.

RETURN

Diagnostic test results

- Press the RETURN key to escape from the test.

6.5 Diagnostics: PC

The diagnostics test displays program no. and tests the ROMs and RAM, receive ability and position data. The test results are displayed as OK or NG (No Good). For any NG or abnormal value, contact your dealer for advice.

- At the facsimile or navtex standby display, click FAX-30 SYSTEM SETUP.
- Click TEST. The test results appears as shown below.

PROGRAM NO.	0850188-XX.XX	XX.XX = Program Version No.
	0850189-XX.XX	
ROM1	OK	
ROM2	OK	
SDRAM	OK	
RECEIVE UNLOCK	OK	
LAT/LON*	OK	* = Requires data sentence GGA or GLL.

Diagnostic test results

- Click STOP TEST to stop the test and restore normal operation and enable receiving.
- Click "<back" or Back button several times to return to the top menu.

6.6 Clearing Data: NavNet

You may clear all facsimile images, navtex messages and the entire memory contents to start afresh.

1. Press the [MENU] key to open the FAX-30 menu.
2. Press the FAX-30 SYSTEM SETUP soft key.
3. Press the CLEAR MEMORY soft key.

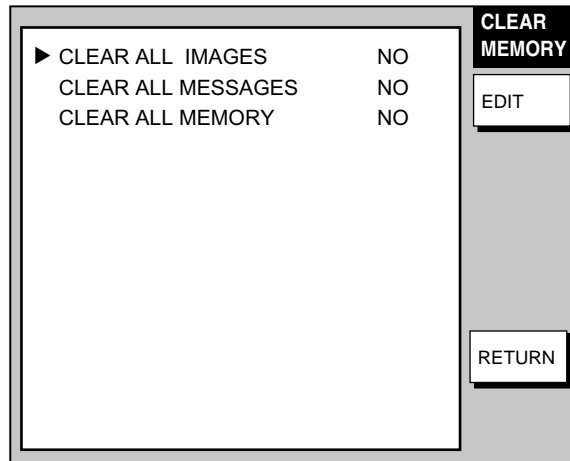

Clear memory menu

4. Rotate the [ENTER] knob to choose the item you wish to clear and press the EDIT soft key. (Clearing all memories erases all fax images, navtex messages and all setting data (for example, user-set stations)).

For example, choose CLEAR ALL IMAGES and press the EDIT soft key to clear all facsimile images.

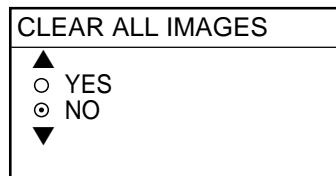

Clear all images options

5. Rotate the [ENTER] knob to choose YES and push the [ENTER] knob.
6. Press the RETURN soft key to close the menu and return to the standby display.

6.7 Clearing Data: PC

You may clear all facsimile images, navtex messages and the entire memory contents to start afresh.

1. At the facsimile or navtex standby display, click SYSTEM SETUP.
2. Click CLEAR MEMORY.

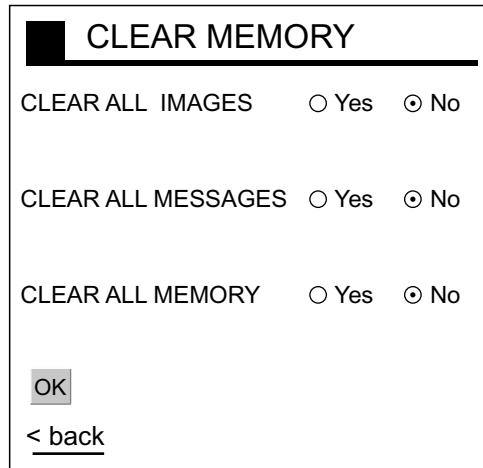

The screenshot shows a menu titled "CLEAR MEMORY" with three options, each with radio buttons for "Yes" and "No". The "No" option is selected for all three. At the bottom, there is an "OK" button and a "< back" option.

Option	Yes	No
CLEAR ALL IMAGES	<input type="radio"/>	<input checked="" type="radio"/>
CLEAR ALL MESSAGES	<input type="radio"/>	<input checked="" type="radio"/>
CLEAR ALL MEMORY	<input type="radio"/>	<input checked="" type="radio"/>

OK
< back

Clear memory options

3. Click Yes for the memory(s) to clear.
Note: Clearing all memories erases all fax images, navtex messages and all setting data (for example, user-set stations).
4. Click OK.
5. You are asked if you are sure to clear the memory(s) selected. Click OK to clear; Cancel to escape.
6. Click "<back" or Back button several times to return to the top menu.

6.8 All Clear (for technicians only)

If the FAX-30 cannot be operated from the NavNet display unit, do the following:

1. Unplug the power connector from the FAX-30.
2. Open the cover.

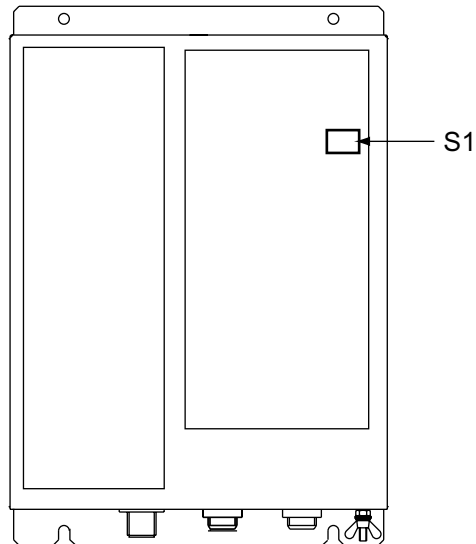

FAX-30, cover opened

3. Turn on the #1 segment of S1 on the MAIN board (08P3218).
4. Connect the power connector and turn on the NavNet display unit.
5. Confirm that the LED on the FAX-30 is flashing.
6. Turn off the NavNet display unit and disconnect the FAX-30's power cable.
7. Turn off the #1 segment of S1.
8. Close the cover and reconnect the power cable.

6.9 Simulation Mode

The simulation mode provides simulated operation of the equipment, using an internally generated fax image and navtex message. The fax image may be processed as desired. This mode is mainly used for exhibition purposes.

Note: All current fax images and navtex messages will be erased when activating the simulation mode.

6.9.1 Accessing the simulation mode through NavNet

1. At the facsimile standby display, press the [MENU] key.
2. Press the FAX-30 SYSTEM SETUP soft key.
3. Press the SIMULATION SETUP soft key.

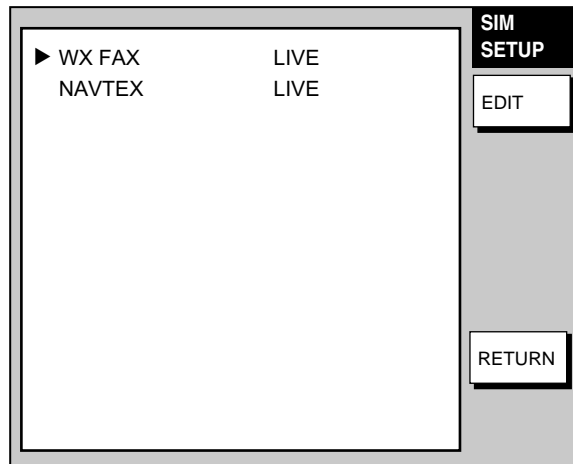

Simulation setup menu

4. Choose WX FAX or NAVTEX as appropriate and press the EDIT soft key. The illustration below shows the dialog box for WX FAX; the dialog box for NAVTEX is similar.

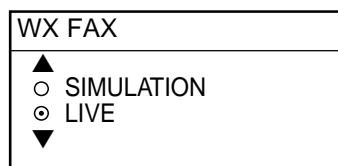

5. Rotate the [ENTER] knob to choose SIMULATION and press the ENTER soft key.

The fax image and navtex message will then be posted to the respective standby display.

6.9.2 Accessing the simulation mode through PC

1. At the facsimile or navtex standby display, click SYSTEM SETUP.
2. Click SIMULATION SETUP.

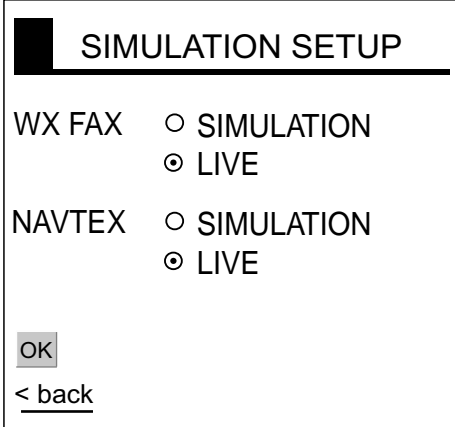

SIMULATION SETUP

WX FAX SIMULATION
 LIVE

NAVTEX SIMULATION
 LIVE

OK

< back

Simulation setup menu

3. Choose SIMULATION for WX FAX and/or NAVTEX as appropriate.
4. Click OK.
5. Click "<back" or Back button to return to the top.

The fax image and navtex message will then be posted to respective standby display.

6. MAINTENANCE, TROUBLESHOOTING

(This page intentionally left blank.)

7. INSTALLATION

7.1 Facsimile Receiver

The facsimile receiver may be mounted on the deck or a bulkhead. When selecting a mounting location, keep in mind the following points:

- Locate the unit out of direct sunlight because of heat that can build up inside the cabinet.
- Select a location where the connectors can be easily accessed.
- Leave sufficient space around the unit for servicing and maintenance. See the outline drawing for recommended servicing space.
- For mounting on a bulkhead, be sure the mounting location is strong enough to support the weight of the unit.
- Locate the unit away from areas subject to water splash and rain.
- A magnetic compass will be disturbed if the FAX-30 is placed too close to it. Separate the FAX-30 from a magnetic compass by the distances below to prevent interference to a magnetic compass.

Steering compass, 0.9 m, Standard compass, 0.6 m.

- Fix the receiver to the mounting location with four 5 X 20 tapping screws (supplied).

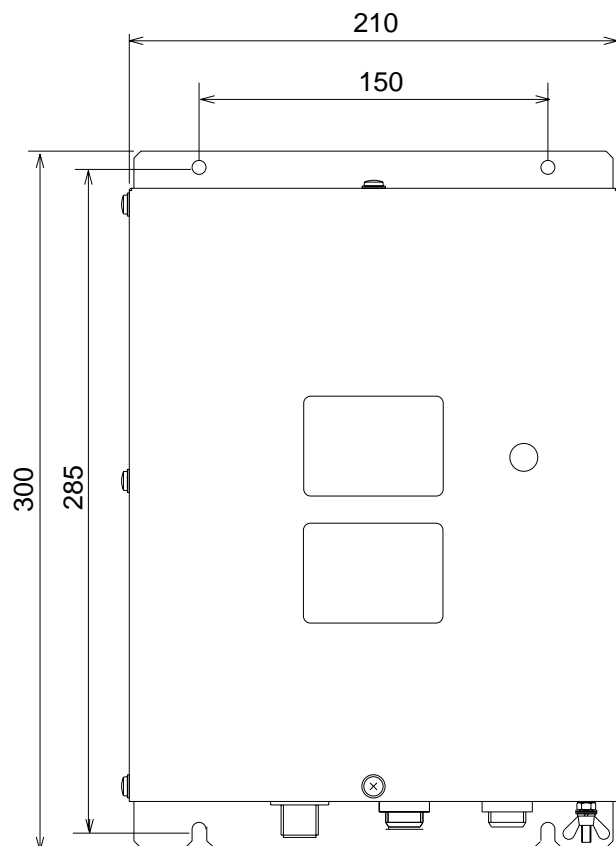

Mounting dimensions of facsimile receiver FAX-30

7.2 Antenna Unit

The performance of the facsimile receiver is directly related to the antenna installation. In general, the antenna should be installed as high as possible on the vessel, free from the influence of nearby antennas, rigging and masts. Be sure to locate the antenna well away from TX antennas and noise generating equipment. Pay particular attention to the antennas of MF and HF radio equipment - they can damage the facsimile receiver through induction. (For better protection against induction, use the preamp unit.)

7.2.1 General antenna connection

Connect the antenna to the facsimile receiver as shown below. If the preamp unit is installed, set jumper block J23 on the RCV Board (in the FAX-30) to the "ACTIVE" position. See paragraph 7.4.

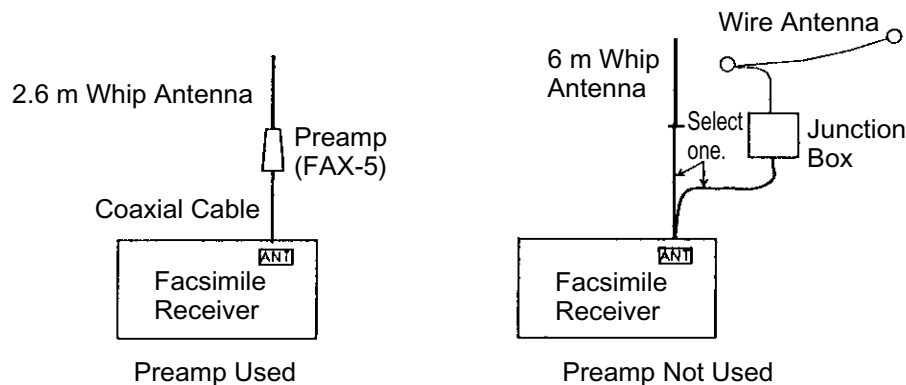

Antenna wiring and preamp status

7.2.2 Wire antenna or whip antenna

- Either a long wire or whip antenna may be used. A wire antenna should be 15 meters or longer including the vertical section. A whip antenna should be 6 meters long.
- The antenna can be shared with other receivers; use an antenna switch or junction box.
- Connect the antenna to the facsimile receiver with a coaxial cable of which the diameter is larger than coaxial cable type 5D-2V. (5D-2V is a JIS (Japan Industry Standard) Cable. Use equivalent cable, referring to the table in paragraph 7.3.
- If sensitivity of the wire antenna is low, use the preamp unit.

7.2.3 Installation of preamp unit FAX-5 (option)

Small boats may not afford the space to install a long wire antenna. In this case it is recommended to install the preamp unit with 2.6 meter whip antenna. The preamp unit can be installed two ways:

- The base of the preamp unit is designed to accept a threaded extension of one-inch diameter. The pitch of the thread should be 14 threads per inch. The mast itself should be no longer than 1.5 meters to prevent flexing in heavy winds.
 - Attach the preamp unit to a post with stainless steel hose clamps (option).
1. Fix the preamp unit to the mounting location.
 2. Screw the whip antenna onto the preamp unit.
 3. If the mast is metallic, run a ground wire (local supply) between the mast and the ground terminal on the preamp unit.
 4. Waterproof the junction and other exposed metallic parts with silicone sealant.

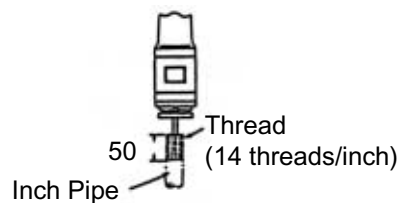

INCH PIPE

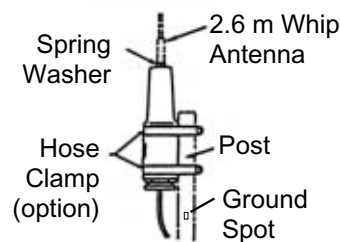

HOSE CLAMP (option) ON POST

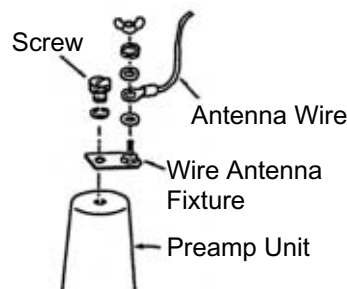

WIRE ANTENNA

How to mount the preamp unit FAX-5

Note 1: An antenna wire several meters in length can be connected instead of the whip antenna. In this case, install the wire antenna fixture (supplied with preamp unit) between the antenna wire and the preamp unit as illustrated above.

Note 2: The preamp unit is powered by the facsimile receiver. To power the preamp unit, set J23 on the RCV Board (in the FAX-30) to the "ACTIVE" position. See paragraph 7.4.

7.3 Wiring

Four cables are connected to the facsimile receiver: antenna cable, Net Cable (or PC cable), power cable, ground wire. Connect them as shown in the figure below. For detailed information, see the interconnection diagram on page S-1.

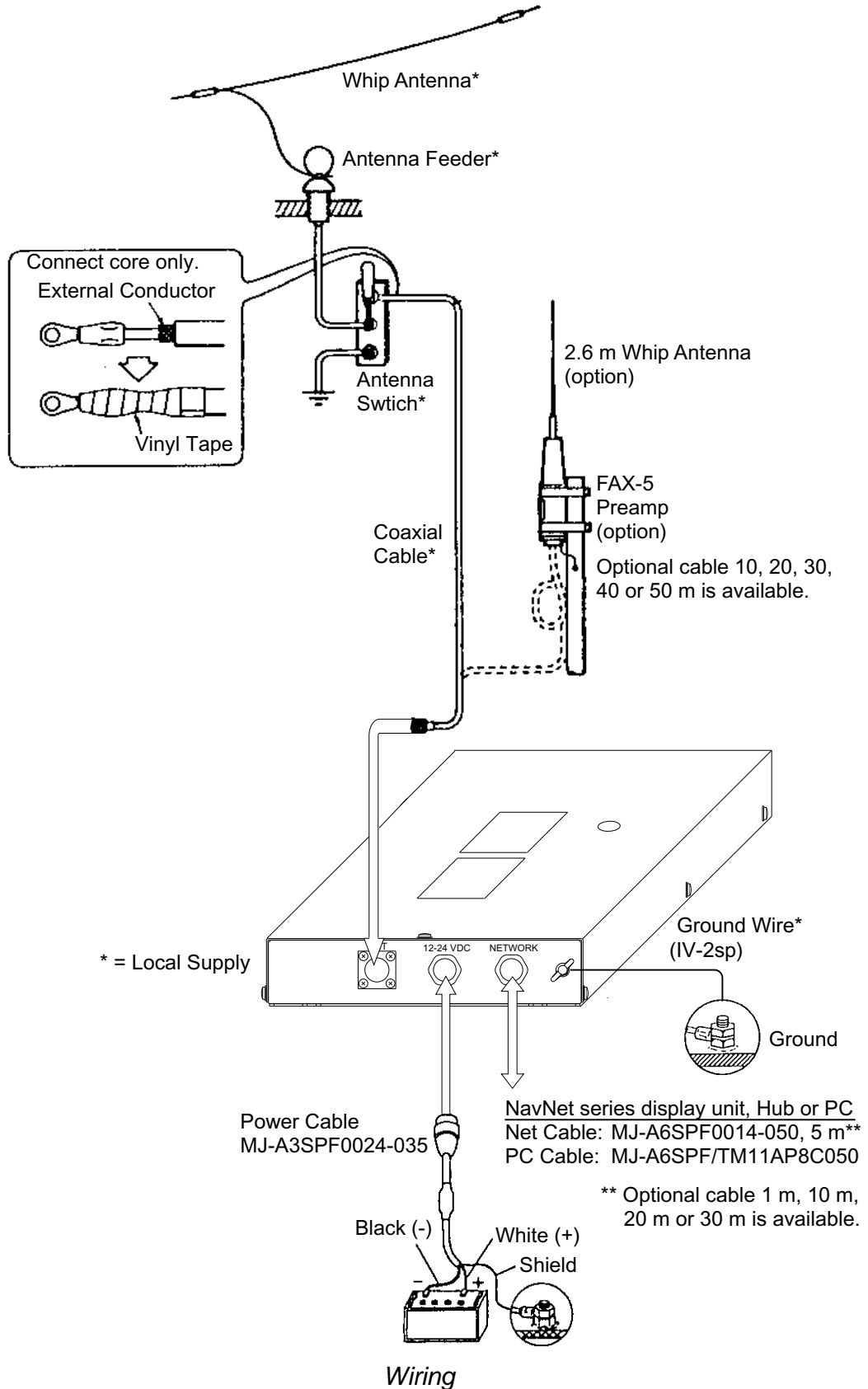

Power cable

Connect the power cable (supplied) to the power source; white wire to positive [+] terminal and black wire to negative [-] terminal.

Ground wire

Ground the equipment to prevent noise and interference and enable reception of weak signals. Run the ground wire (local supply) between the ground terminal on the facsimile receiver and the ship's grounding bus.

Preamp unit

Connect its coaxial cable directly to the antenna connector on the FAX-30. Note that an extension cable kit (option) is available, in lengths of 10, 20, 30, 40 and 50 m.

Wire or whip antenna

A junction box or antenna switch (local supply) is required since the connection at the FAX-30 is made with a coaxial cable. Connect a feeder wire between the antenna and the junction box or antenna switch. Attach coaxial connector (option) to a 50 ohm coaxial cable as below and connect the cable between the junction box and the FAX-30. If the connector does not fit the cable, use appropriate adaptor (option).

Cable type 7C-2V, RG-8/U, RG-213/U, etc.

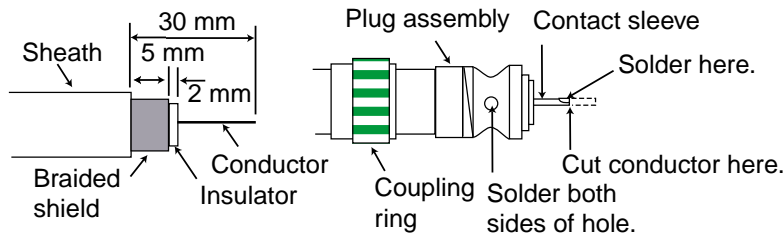

Cable type 5D-2V, 5C-2V, RG-5/U, 3C-2V, RG-58/U, etc.

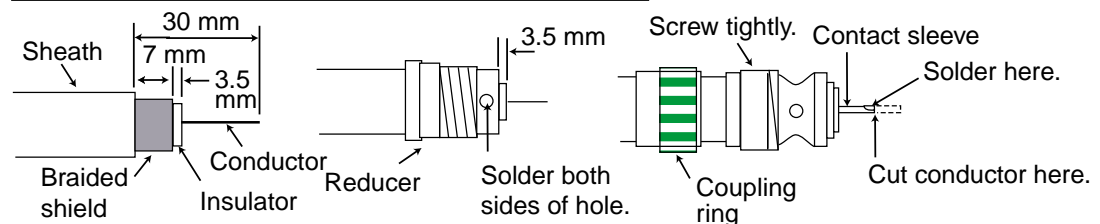
*Attachment of antenna connector*

Note: The cables 3C-2V, 5C-2V, 5D-2V and 7C-2V are JIS (Japan Industry Standard) cables. If these are not available use equivalent cables, referring to the table on the next page for specifications.

7. INSTALLATION

JIS cable specifications

Type	Inner Conductor		Insulation		Outer Conductor		Jacket			Cond. resistance (Max.) (20°C) (Ω/km)	Nominal attenuation 10 MHz (dB/km)	Capacitance (pF/m)	Approx. mass (kg/km)
	Stranding (No./mm)	Dia. (mm)	Thick (mm)	Dia (mm)	Braid		Dia. (mm)	Thick (mm)	Dia. (mm)				
					Dia./	Pitch							
3C-2V	1/0.5	0.5	1.3	3.1	0.14/5/24	26	3.8	0.8	5.4±0.5	91.4	42	67±3	42
5C-2V	1/0.8	0.8	2.05	4.9	0.14/7/24	42	5.7	0.9	7.4±0.5	35.9	27	67±3	74
7C-2V	7/0.4	1.2	3.05	7.3	0.18//8/24	45	8.2	1.1	10.4±0.5	20.7	22	67±3	140
5D-2V	1/1.4	1.4	1.7	4.8	0.14/7/24	42	5.5	0.9	7.3±0.5	11.7	27	100±4	80

7.4 Supplying Power to the Preamp Unit

The preamp unit is powered with 12 VDC power fed from the facsimile receiver. To power the preamp unit, do the following:

1. Disconnect the power cable from the FAX-30.
2. Unfasten eight screws marked with the arrows below to remove the cover.

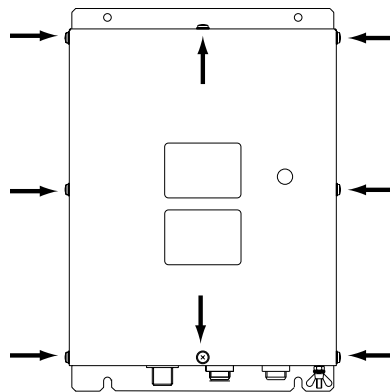

FAX-30, top view

3. Set the jumper block J23 in the “ACT(IVE)” position. See the figure below for the “ACT” position.

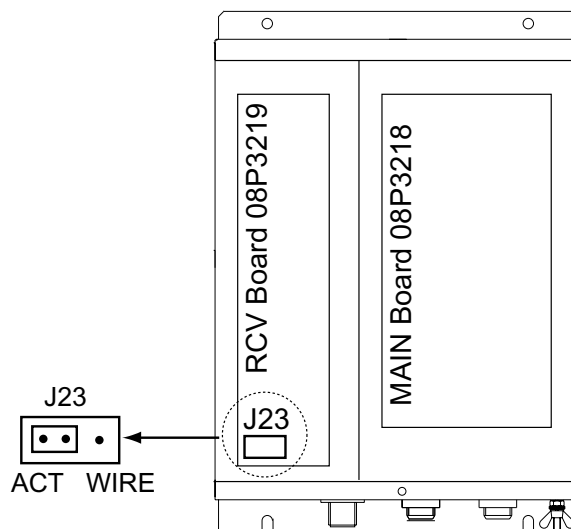

FAX-30, top view, cover removed

4. Close the cover and connect the power cable.

7.5 Browser, PC Settings

7.5.1 Browser settings

Set your browser as shown in the procedures below. The procedure may be different depending on browser version.

Internet Explorer (Version 5.5)

1. Start up the Internet Explorer.
2. Click Tools on the menu bar.
3. Click Internet Options.
4. General is selected; click "Settings" at "Temporary Internet files."
5. Click the radio button "Every visit to the page" at "Check for newer versions of stored pages."
6. Click OK.
7. Click Security tab.
8. Click Custom Level button.
9. At the item Scripting, click Enable for both "Active scripting" and "Scripting of Java Applets."
10. Click OK.
11. Click Connections tab.
12. Click LAN Settings button.
13. Uncheck "Use a proxy server" at "Proxy server."
14. Click OK.
15. Click OK again.

Netscape Navigator (Version 4.78)

1. Start up the Netscape Navigator.
2. Click the Edit menu.
3. Click Preferences.
3. Open the Advanced menu.
4. Check "Automatically load images and other data types," "Enable Java," "Enable Java script" and "Enable style sheets."
5. Click "Cache" at Advanced.
6. Choose "Every time" in "Page in cache is compared to page on network."
7. Click "Proxies" at Advanced.
8. Choose "Direct connection to internet."
9. Click OK.

7.5.2 PC settings

The PC communicates with the FAX-30 via Internet protocol TCP/IP. Therefore, set IP address on the PC as below.

1. Start up the PC and open the Control Panel folder.
2. Open the Network and Dial-up Connections folder.
3. Double-click Local Area Connection.
4. Click Properties.
5. Check Internet Protocol (TCP/IP).
6. Click Properties.
7. Choose "Use the following IP address."
8. Set the IP address for 172.31.100.100.
9. Set the Subnet mask for 255.255.0.0.

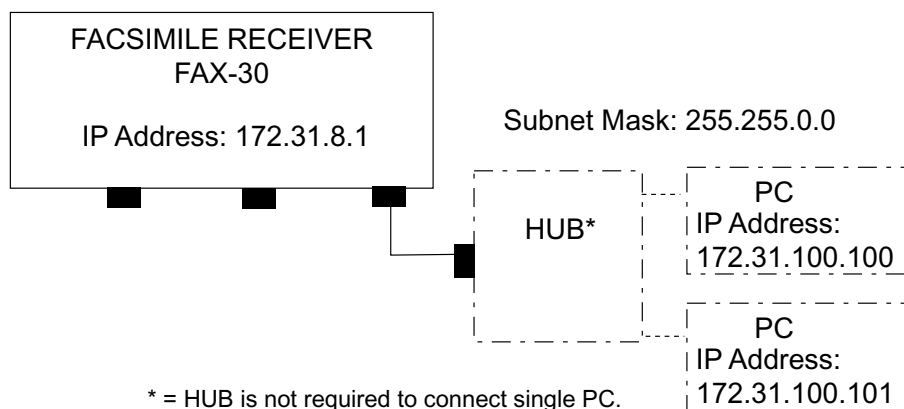

IP address

10. Click OK.
11. Click OK.
12. Click Close button.
13. Turn the PC off and on again.
14. Start up the browser.
15. Enter the FAX-30's URL: <http://172.31.8.1> and press the [Enter] key.

The facsimile receiver top display should appear. If it does not appear, recheck above settings.



Facsimile receiver top display

APPENDIX

Facsimile Stations

Facsimile station map

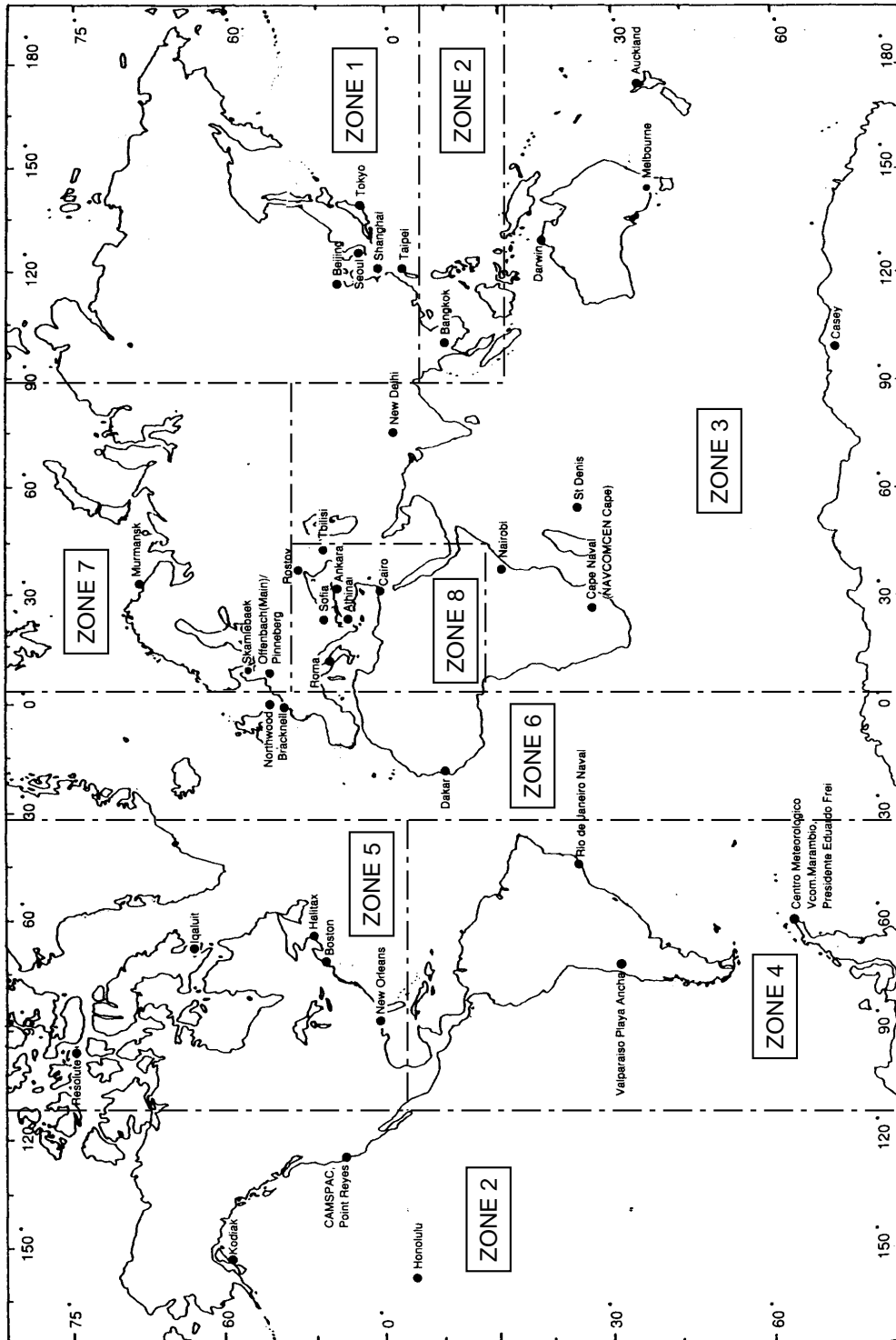

Location of facsimile stations

Facsimile station list (by zone)

ZONE 7		NORTH ATLANTIC OCEAN NORTHERN PART	
STA-TION	CALL SIGN	TRANSMITTED FROM	TRANSMITTED FROM
0	DCX	Offenbach	GERMANY
1	DDK	Offenbach	GERMANY
	DDH *		
2	OXT	Copenhagen	DENMARK
3	OLT	Praha-Modrany	CZECHOSLOVAKIA
4	SMA	Norrkoping	SWEDEN
5	RBW	Murmansk	RUSSIA
6	OFA	Helsinki	FINLAND
7	OFW	Vaasa	FINLAND
8	NOV		
9	AUX		

ZONE 4		SOUTH ATLANTIC OCEAN	
STA-TION	CALL SIGN	TRANSMITTED FROM	TRANSMITTED FROM
0	CLX	Casablanca	CUBA
1	FFP	Fort de France	MARTINIQUE
2	GYA		
3	LOR	Puerto Brelgrano	ARGENTINA
4	PWZ	Rio de Janeiro	BRASIL
	PRO *	Orinda	BRASIL
5	LRO	Buenos Aires	ARGENTINA
6	VLM	Casey	ANTARCTICA
7	CAN	CMIRL FREI	South Shetland Is.
8	LSB	CNURLMARAMBIO	ANTARCTIC
9	CBV	Valparaiso	CHILE

ZONE 1		NORTH PACIFIC OCEAN WESTERN PART	
STA-TION	CALL SIGN	TRANSMITTED FROM	TRANSMITTED FROM
0	JMH	Tokyo	JAPAN
1	JMJ	Tokyo	JAPAN
	JJC	Tokyo	JAPAN
2	9MG *	Tokyo	Via MALAYSIA
3	JFA	Tokyo	CHINA
4	3SD	Beijing	CHINA
5	BAF	Beijing	CHINA
6	BDF	Shanghai	TAIWAN
7	BMF	Taipei	KOREA
8	HLL	Seoul	
9	AUX		

ZONE 8		MEDITERRANEAN SEA	
STA-TION	CALL SIGN	TRANSMITTED FROM	TRANSMITTED FROM
0	IMB	Rome	ITALY
1	SVJ	Athens	GREECE
2	YZZ	Beograd	YUGOSLAVIA
3	LZJ2	Sofia	BULGARIA
4	YMA	Ankara	TURKEY
5	RBV	Tashkent 1	UZBEKISTAN
6	RBX	Tashkent 2	UZBEKISTAN
7	SUU	Cairo	EGYPT
8	JED	Jeddah	SAUDI ARABIA
9	RIS	Tbilisi	GRUZIIA

ZONE 5		NORTH ATLANTIC OCEAN WESTERN PART	
STA-TION	CALL SIGN	TRANSMITTED FROM	TRANSMITTED FROM
0	NMG	New Orleans	USA
1	NMF	Boston	USA
2	NIK	Boston	USA
3	CFH	Halifax	CANADA
4	VFF	RESOLUTE	CANADA
5	OXT	Skamlebaek	GREENLAND
6	AUX		
7	AUX		
8	AUX		
9	AUX		

ZONE 2		NORTH PACIFIC OCEAN EASTERN PART	
STA-TION	CALL SIGN	TRANSMITTED FROM	TRANSMITTED FROM
0	NPN	Guam	MARIANA IS.
1	NPO	Sanglay Point	PHILIPPINES
2	HSW	Bangkok	THAILAND
3	NPM	Pearl Harbor	USA
4	KVM	Honolulu	USA
5	NOJ	Kodiak, Alaska	USA
6	CKN	Esquimalt	CANADA
7	NMC	California	USA
8	ELK	Nebraska	USA
9	AUX		

ZONE 6		NORTH ATLANTIC OCEAN EASTERN PART	
STA-TION	CALL SIGN	TRANSMITTED FROM	TRANSMITTED FROM
0	GYA	Northwood	UK
1	AOK	Rota	SPAIN
2	MAD	Madrid	SPAIN
3	NHY	Kenitora	MOROCCO
4	6VU	Dakar	SENEGAL
5	AUX		
6	AUX		
7	AUX		
8	AUX		
9	AUX		

ZONE 3		SOUTH PACIFIC OCEAN, INDIAN OCEAN, PERSIAN GULF	
STA-TION	CALL SIGN	TRANSMITTED FROM	TRANSMITTED FROM
0	VWV	Australia west	AUSTRALIA
1	VMC	Australia east	AUSTRALIA
2	ZKLF	Auckland	NEW ZEALAND
3	NPN	Guam	Via AUSTRALIA
		Guam	Via JAPAN
4	ATA	New Delhi	INDIA
5	EPD	Teheran	IRAN
6	5YE	Nairobi	KENYA
7	ZSJ	CAPE NAVAL	SOUTH AFRICA
8	HXP	Denis METEO	MAURITIUS
9	RUZU	Molodezhnaya	RUSSIA

FACSIMILE STATION LIST

ZONE [0] and [9] are allocated for private channels.
(10 channels each for 12 stations)
*: Callsign not displayed.

Facsimile station list (alphabetical order)

	Nation	City	Zone No.	Station No.	Call sign	Remarks
A	ANTARCTIC	Casey	4	6	VLM	
		Meteorologic.	4	8	LSB	
	ARGENTINE	Buenos Aires	4	5	LRO	
		Puerto Belgrano	4	3	LOR	
	AUSTRALIA	Darwin	3	0	AXI	
		Melbourne	3	1	AXM	
B	BRAZIL	Olinda	4	4	PPO	
		Rio de Janeiro	4	4	PWZ	
	BULGARIA	Sofia	8	3	LZJ2	
C	CANADA	Iqaluit	5	4	VFF	
		Esquimalt	2	6	CKN	
		Halifax	5	3	CFH	
	CHILE	Valparaiso	4	9	CBV	
	CHINA	Beijing	1	4	3SD	
		Beijing	1	5	BAF	
		Shanghai	1	6	BDF	
	CUBA	Casablanca	4	0	CLX	
	CZECHOSLOVAKIA	Praha-Modrany	7	3	OLT	
D	DENMARK	Copenhagen	7	2	OXT	
E	EGYPT	Cairo	8	7	SUU	
F	FINLAND	Helsinki	7	6	OFA	
		Vaasa	7	7	OFW	
G	GREECE	Athens	8	1	SVJ	
	GREENLAND	Skamlebeak	5	5	OXT	
I	INDIA	New Delhi	3	4	ATA	
	IRAN	Teheran	3	5	EPD	
	ITALY	Rome	8	0	IMB	
J	JAPAN	Tokyo	1	0	JMH	No.1
		Tokyo	1	1	JMJ	No.2
		Tokyo	1	2	JJC	JMSA & Kyodo
		Tokyo	1	3	9VF	
		Tokyo	1	3	JFA	Chuo Gyogyo
K	KENYA	Nairobi	3	6	5YE	
	KOREA	Seoul	1	8	HLL	
M	MARIANA IS.	Guam	2	0	NPN	US Navy
			3	3	NPN	Via Australia
			3	3	NPN	Via Japan
	MARTINIQUE	Fort de France	4	1	FFP	
	MAURITIUS	Sain Denis	3	8	HXP	
	MOROCCO	Kenitora	6	3	NHY	
N	NEW ZEALAND	Auckland	3	2	ZKLF	
P	PHILIPPINES	Sanglay Point	2	1	NPO	US Navy
S	SENEGAL	Dakar	6	4	6VU	
	SAUDI ARABIA	Jeddah	8	8	JED	
	SOUTH AFRICA	Pretoria	3	7	ZRO	
	SOUTH SHETLAND IS.	Meteorologic	4	7	CAN	
	SPAIN	Rota	6	1	AOK	US Navy
		Madrid	6	2	MAD	
	SWEDEN	Norrkoping	7	4	SMA	
T	TAIWAN	Taipei	1	7	BMF	
	THAILAND	Bangkok	2	2	HSW	
	TURKEY	Ankara	8	4	YMA	
U	UK	Northwood	6	0	GYA	For S.A.
	USA	Boston	5	2	NIK	
		Boston	5	1	NMF	
		Honolulu	2	4	KVM	
		Kodiak Alaska	2	5	NOJ	
		Nebraska	2	8	ELK	
		New Orleans	5	0	NMG	
		Pearl Harbor	2	3	NPM	US Navy
		San Francisco	2	7	NMC	
	UZBEKISTAN	Tashkent 1	8	5	RBV	
		Tashkent 2	8	6	RBX	
	RUSSIA	Molodezhnaya	3	9	RUZU	
		Murmansk	7	5	RBW	
W	GERMANY	Hamburg	7	1	DDK	
		Offenbach	7	0	DDH	
			7	0	DCF	
Y	YUGOSLAVIA	Belgrade	8	2	YZZ	

Navtex Stations

Navtex stations map

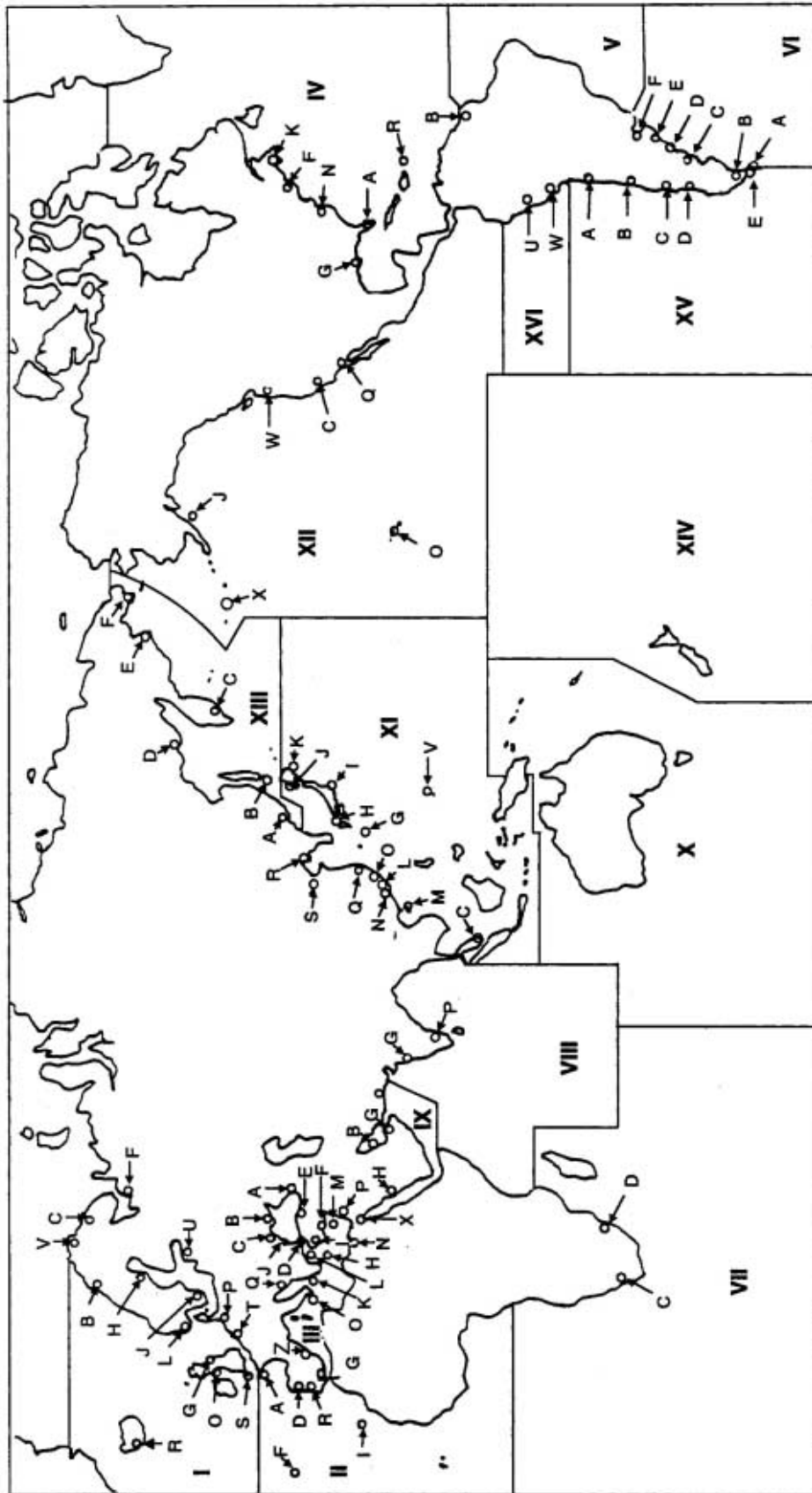

Location of navtex stations

Navtex stations list

Nav area	Country	Station	Station	Latitude	Longitude	518 kHz	490 kHz
I	Belgium	Oostende	Oostende	51 11N	02 48E	M, T	
	Estonia	Tallinn	Tallinn	59 30N	24 30E	E, U	
	Iceland	Reykjavik Radio	Reykjavik	64 05N	21 51W	R, X	
	Ireland	Valencia	Valencia	51 56N	10 21W	W	
		Malin Head	Malin Head	55 22N	07 21W	Q	
	Netherlands	Netherlands Coast Guard	Netherlands	52 06N	04 15E	P	
	Norway	Bodo Radio	Bodo	67 16N	14 23E	B	
		Rogaland Radio	Rogaland	58 39N	05 36E	L	
		Vardoe Radio	Vardoe	70 22N	31 06E	V	
		Svalbard	Svalbard	78 02N	13 40E	A	
	Sweden	Harnosand	Harnosand	64 28N	21 36E	H	
		Karlskrona	Karlskrona	55 29N	14 19E	J	
		Stockholm Radio	Stockholm	59 16N	18 43E	U, D	
	United Kingdom	Cullercoats	Cullercoats	55 02N	01 26W	G	I, U
		Portpatrick	Portpatrick	54 51N	05 07W	O	C
		Niton	Niton	50 35N	01 18W	K, S	I, T
	Russian Federation	Murmansk	Murmansk	68 58N	33 05E	C	
Archangel		Archangel	64 33N	40 32E	F		
II	Cameroon	Douala	Douala	No info		No info	
	Cape Verde	Sao Vicente Radio	Sao Vicente	No info		No info	
	France	Cross Corsen	Cross Corsen	48 28N	05 03E	A	E
	Mauritania	Nouadhibou Radio	Nouadhibou	No info		No info	
	Morocco	Casablanca Radio	Casablanca	33 36N	07 38W	M	
	Portugal	Horta Radio	Horta Radio	38 32N	28 38W	F	J
		Monsanto Radio	Monsanto	38 44N	09 11W	R	G
	Spain	Corunna	Corunna	42 54N	09 16W	D	
		Tarifa	Tarifa	36 01N	05 34W	G	
Las Palmas		Las Palmas	28 10N	15 25W	I		
III	Bulgaria	Varna	Varna	43 04N	27 46E	J	
	Croatia	Split	Split	43 30N	16 29E	Q	
	Cyprus	Cyprus	Cyprus	35 03N	33 17E	M	
	Egypt	Serapeum	Serapeum	30 28N	32 22E	X	
		Alexandria	Alexandria	31 12N	29 52E	N	
	France	Cross La Garde	La Garde	43 06N	05 59E	W	S
	Greece	Heraklion	Heraklion	35 20N	25 07E	H	
		Corfu	Corfu	39 37N	19 55E	K	
		Lemnos	Lemnos	39 52N	25 04E	L	
Israel	Haifa	Haifa	32 49N	35 00E	P		

APPENDIX

Nav area	Country	Station	Station	Latitude	Longitude	518 kHz	490 kHz
III	Italy	Roma	Roma	41 37N	12 29E	R	
		Augusta	Augusta	37 14N	15 14E	S, V	
		Cagliari	Cagliari	39 13N	09 14E	T	
		Trieste	Trieste	45 40N	13 46E	U	
	Malta	Malta	Malta	35 49N	14 32E	O	
	Russian Federation	Novorossiysk	Novorossiysk	44 42N	37 44E	A	
		Astrakhan	Astrakhan	46 18N	47 58E	W	
	Spain	Cabo de la Nao	Cabo la Nao	38 43N	00 09E	X	
	Turkey	Istanbul	Istanbul	41 04N	28 57E	D	
		Samsun	Samsun	41 17N	36 20E	E	
		Antalya	Antalya	36 53N	30 42E	F	
		Izmir	Izmir	38 22N	26 36E	I	
	Ukraine	Mariupol	Mariupol	47 06N	37 33E	B	
		Odessa	Odessa	46 29N	30 44E	C	
IV	Bermuda(UK)	Bermuda	Bermuda	32 23N	64 41W	B	
	Canada	Iqaluit	Iqaluit	63 44N	68 33W	T	S
		Sept Iles	Sept Iles	50 12N	66 07W	C, D	
		Prescott	Prescott	44 56N	81 14W	H	
		St. Johns	St. Johns	47 37N	52 40W	O	
		Thunder Bay	Thunder Bay	48 34N	88 39W	P	
		Sydney, Nova Scotia	Nova Scotia	46 11N	59 54W	Q, J	
		Fundy	Fundy	43 44N	66 07W	U, V	
		Montreal	Montreal	45 41N	73 16W	W, T	
	Labrador	Labrador	53 42N	57 02W	X		
	Denmark(Greenland-West Coast)	Godthaab (Nuuk)	Nuuk	64 04N	52 01W	W	
	United States	Miami	Miami	25 37N	80 23W	A	
		Boston	Boston	41 39N	70 33W	F	
		New Orleans	New Orleans	29 53N	89 57W	G	
		Chesapeake	Chesapeake	36 35N	76 01W	N	
		San Juan	San Juan	18 28N	67 07W	R	
	Netherlands Antilles	Curacao	Curacao	12 10N	68 52W	H	
V	Uruguay	Colonia	Colonia	No info		No info	
		Laguna del Sauce	Laguna Sauce	No info		No info	
		La Paloma	La Paloma	34 40S	54 09W	F	A
		Montevideo	Montevideo	No info		No info	
		Punta del Este	Punta del Este	No info		No info	
		Salto	Salto	No info		No info	
VI	Argentina	Ushaia	Ushaia	54 48S	68 08W	A, M	
		Rio Gallegos	Rio Gallegos	51 37S	65 03W	B, N	
		Comodoro Rivadavia	Comodoro Rivadavia	45 51S	67 25W	C, O	
		Bahia Blanca	Bahia Blanca	38 43S	62 06W	D, P	

Nav area	Country	Station	Station	Latitude	Longitude	518 kHz	490 kHz
VI	Argentina	Mar del Plata	Mar del Plata	38 03S	57 32W	E, Q	
		Buenos Aires	Buenos Aires	34 36S	58 22W	F, R	
VII	Namibia	Walvis Bay	Walvis Bay	23 03S	14 37E	B	
	South Africa	Cape Town	Cape Town	33 40S	18 43E	C	
		Port Elizabeth	Port Elizabeth	34 02S	25 33E	I	
		Durban	Durban	30 00S	31 30E	O	
VIII	India	Bombay	Bombay	19 05N	72 50E	G	
		Madras	Madras	13 05N	80 17E	P	
	Mauritius	Mauritius Radio	Mauritius	20 26S	57 41E	C	
IX	Bahrain	Hamala	Hamala	26 09N	50 28E	B	
	Egypt	Serapeum (Ismailia)	Serapeum	30 28N	32 22E	X	
	Iran	Bushehr	Bushehr	28 59N	50 50E	A	
		Bandar Abbas	Bandar Abbas	27 07N	56 04E	F	
	Saudi Arabia	Dammam	Dammam	26 26N	50 06E	G	
		Jeddah	Jeddah	21 23N	39 10E	H	
	Oman	Muscat	Muscat	23 36N	58 30E	M	
Pakistan	Karachi	Karachi	24 51N	67 03E	P		
X						NONE	
XI	China	Sanya	Sanya	18 15N	109 30E	M	
		Guangzhou	Guangzhou	23 09N	113 29E	N	
		Fuzhou	Fuzhou	26 02N	119 18E	O	
		Shanghai	Shanghai	31 07N	121 33E	Q	
		Dalian	Dalian	38 51N	121 31E	R	
	Indonesia	Jayapura	Jayapura	02 31S	140 43E	A	
		Ambon	Ambon	03 42S	128 12E	B	
		Makassar	Makassar	05 06S	119 26E	D	
		Jakarta	Jakarta	06 06S	106 54E	E	
	Japan	Otaru	Otaru	43 19N	140 27E	J	
		Kushiro	Kushiro	42 57N	144 36E	K	
		Yokohama	Yokohama	35 14N	139 55E	I	
		Moji	Moji	34 01N	130 56E	H	
		Naha	Naha	26 05N	127 40E	G	
	Korea, Republic of	Chukpyun	Chukpyun	37 03N	129 25E	V	
		Pyonsan	Pyonsan	35 36N	126 29E	W	
	Malaysia	Penang	Penang	05 25N	100 24E	U	
		Miri	Miri	04 25N	114 01E	T	
		Sandakan	Sandakan	05 54N	118 00E	S	
	Philippines	Manila	Manila	14 35N	121 03E	J	
		Puerto Princesa	P.Princesa	09 44N	118 43E	I	
		Davao	Davao	07 04N	125 36E	K	
	Singapore	Singapore	Singapore	01 25N	103 52E	C	
	Thailand	Bangkok Radio	Bangkok	13 44N	100 34E	F	
	United States	Guam	Guam	13 29N	144 50E	V	

APPENDIX

Nav area	Country	Station	Station	Latitude	Longitude	518 kHz	490 kHz
XI	Vietnam	Ho Chi Minh	Ho Chi Minh	10 47N	106 40E	X	
		Haiphong	Haiphong	20 44N	106 44E	P	W
		Danang	Danang	16 05N	108 13E	W, K	
	Taiwan	Chilung	Chilung	25 09N	121 44E	P	
	Associate Member of IMO	Hong Kong	Hong Kong	22 13N	114 15E	L	
XII	Canada	Prince Rupert	Prince Rupert	54 18N	130 25W	D	
		Tofino	Tofino	48 55N	125 33W	H	
	United States	San Francisco	San Francisco	37 56N	122 44W	C	
		Kodiak	Kodiak	57 46N	152 34W	J, X	
		Honolulu	Honolulu	21 16N	158 09W	O	
		Cambria	Cambria	35 31N	121 03W	Q	
		Astoria	Astoria	46 12N	123 57W	W	
Adak	Adak	51 54N	176 38W	X			
XIII	Russian Federation	Vladivostok	Vladivostok	43 07N	131 53E	A	
		Kholmsk	Kholmsk	47 02N	142 03E	B	
		Petropavlovsk	Petropavlovsk	53 00N	158 40E	C	
		Magadan	Magadan	59 40N	151 01E	D	
		Beringovskiy	Beringovskiy	63 03N	179 20E	E	
		Provideniya	Provideniya	64 40N	173 10W	F	
		Astrakhan	Astrakhan	44 20N	48 02W	W	
XIV						NONE	
XV	Chile	Antofagasta	Antofagasta	23 39S	70 25W	A, H	
		Valparaiso	Valparaiso	32 48S	71 29W	B, I	
		Talcahuano	Talcahuano	36 43S	73 06W	C, J	
		Puerto Montt	Puerto Montt	41 30S	72 58W	D, K	
		Punta Arenas	Punta Arenas	53 12S	70 56W	E, L	
		Isla de Pascua	Isla de Pascua	27 09S	109 25W	F, G	
XVI	Peru	Paita	Paita	05 05S	81 07W	S	
		Callao	Callao	12 03S	77 09W	U	
		Mollendo	Mollendo	17 01S	72 01W	W	
	Ecuador	Guayaquil	Guayaquil	02 17S	79 52W	M	

Menu Tree

NavNet menu tree

Soft keys

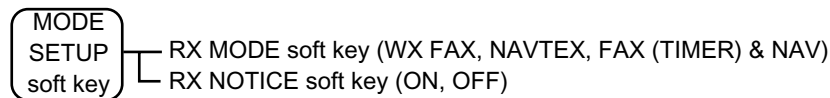
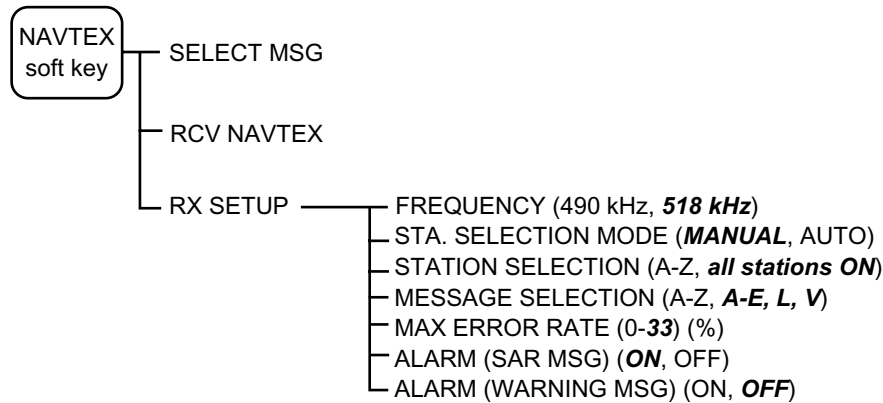
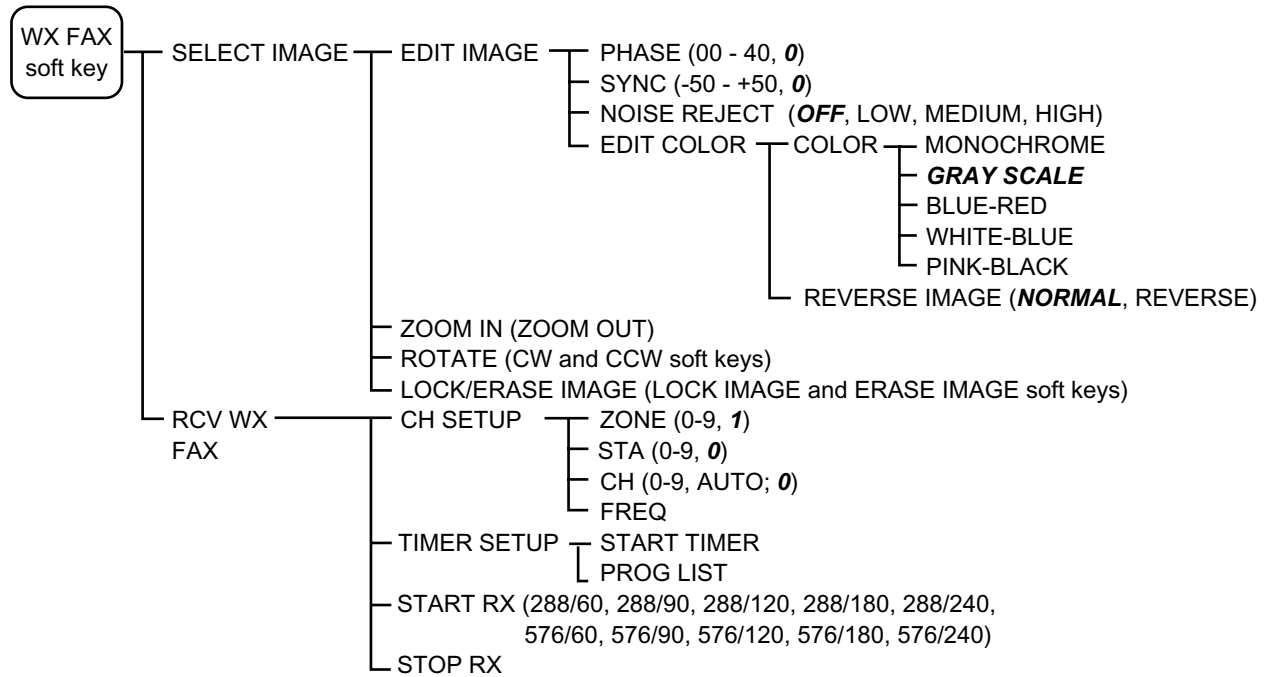

MENU key

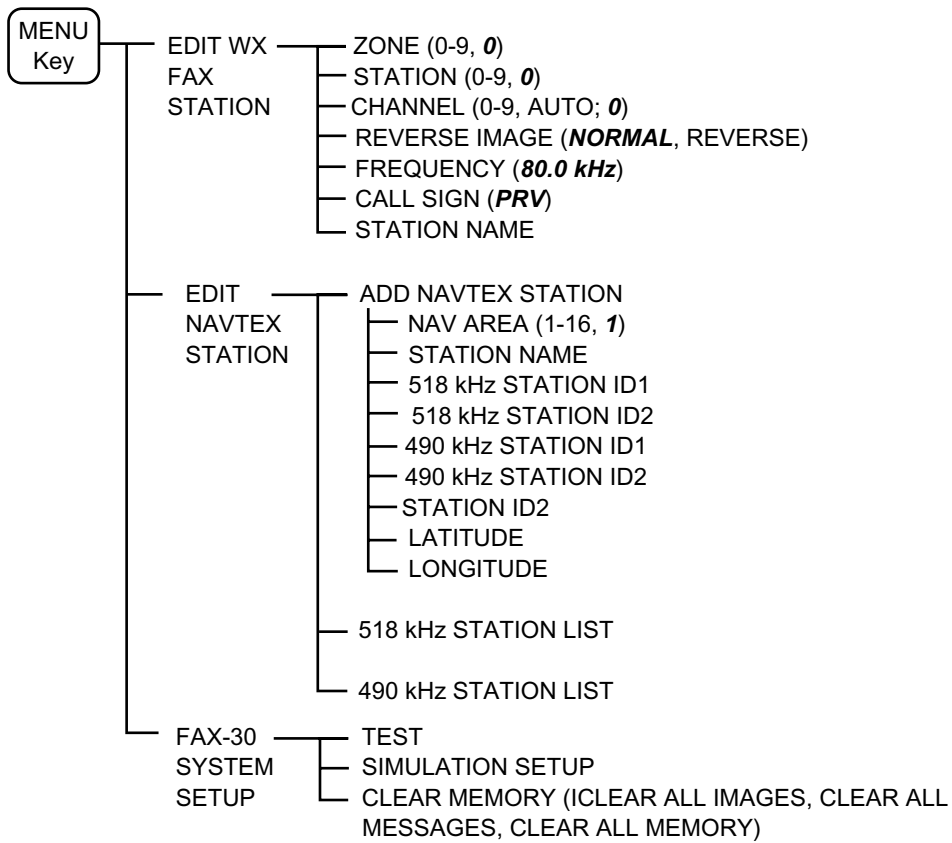

PC Menu tree

Facsimile menu tree

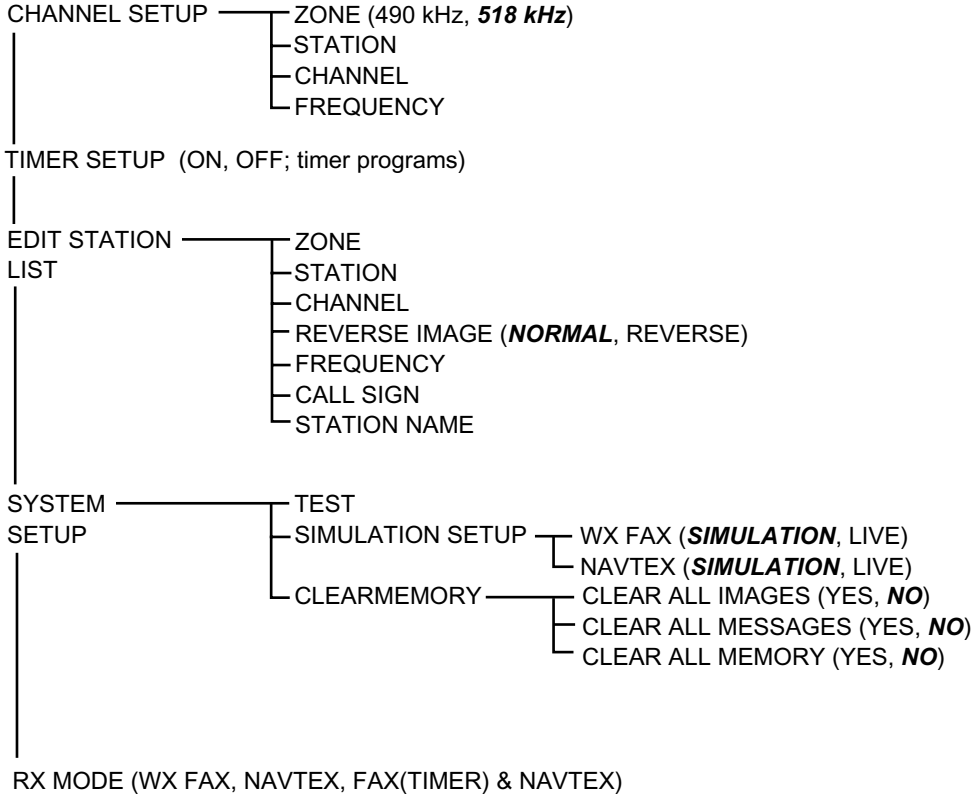

APPENDIX

Navtex menu tree

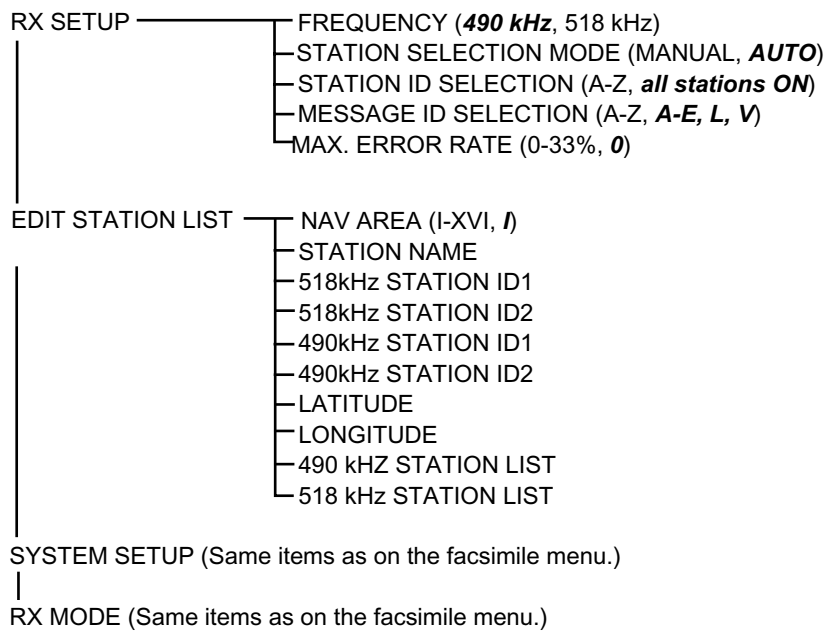

SPECIFICATIONS OF FACSIMILE RECEIVER FAX-30

1 GENERAL

- | | | |
|-----|--------------------|---------------------------|
| 1.1 | Frequency | |
| | FAX LF | 80-160 kHz |
| | MF/HF | 2-25 MHz |
| | NAVTEX | 490 kHz, 518 kHz |
| 1.2 | Number of Channels | 1000 |
| 1.3 | Receiving System | Double super heterodyne |
| 1.4 | Class of Emission | FAX: F3C/J3C, NAVTEX: F1B |
| 1.5 | Network Interface | Ethernet 10 BASE-T TCP/IP |

2 POWER SUPPLY

12-24 VDC: 1.0-0.5 A

3 ENVIRONMENTAL CONDITION

- | | | |
|-----|---------------------|----------------|
| 3.1 | Ambient Temperature | -15°C to +55°C |
| 3.2 | Relative Humidity | 95% at +40°C |
| 3.3 | Waterproof | IPX2 |
| 3.4 | Vibration | IEC 60945 |



4 COATING COLOR

N3.0

This page is intentionally left blank.

PACKING LIST

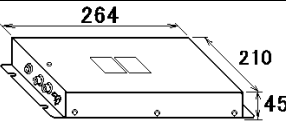
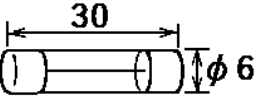
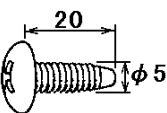
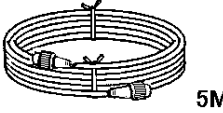

FAX-30-J/E-AN

NAME	OUTLINE	DESCRIPTION/CODE No.	Q'TY
ユニット UNIT			
ファクシミリ受画装置 FACSIMILE RECEIVER		FAX-30 000-057-102	1
予備品 SPARE PARTS SP08-01901			
ヒューズ FUSE		FGB0 2A AC250V 000-549-020	2
工事材料 INSTALLATION MATERIALS CP08-01701			
+トラスタッピングネジ +TAPPING SCREW		5X20 SUS304 1ヶ 000-802-081	4
その他工材 OTHER INSTALLATION MATERIALS			
ケーブル組品MJ CABLE ASSY.		MJ-A6SPF0014-050 *5M* 000-144-422	1
ケーブル組品MJ CABLE ASSY.		MJ-A3SPF0024-035 000-146-470	1

(略図の寸法は、参考値です。 DIMENSIONS IN DRAWING FOR REFERENCE ONLY.)

P A C K I N G L I S T

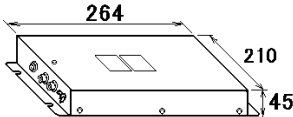
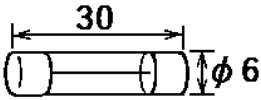
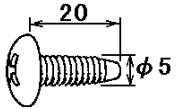
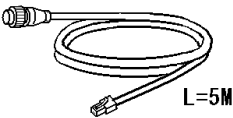
FAX-30-J/E-AP

N A M E	O U T L I N E	DESCRIPTION/CODE No.	Q' TY
ユニット UNIT			
ファクシミリ受画装置 FACSIMILE RECEIVER		FAX-30 000-057-102	1
予備品 SPARE PARTS		SP08-01901	
ヒューズ FUSE		FGB0 2A AC250V 000-549-020	2
工事材料 INSTALLATION MATERIALS		CP08-01701	
+トラスタッピングネジ +TAPPING SCREW		5X20 SUS304 1ヶ 000-802-081	4
その他工材 OTHER INSTALLATION MATERIALS			
ケーブル組品 CABLE ASSY.		MJ-A6SPF/TM11AP8C050 000-146-289	1
ケーブル組品MJ CABLE ASSY.		MJ-A3SPF0024-035 000-146-470	1

(略図の寸法は、参考値です。 DIMENSIONS IN DRAWING FOR REFERENCE ONLY.)

P A C K I N G L I S T

FAX-30-J/E-N

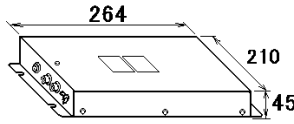
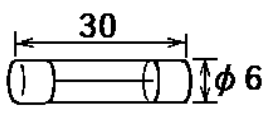
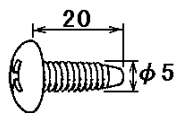
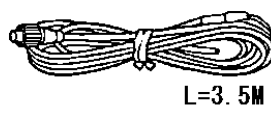
N A M E	O U T L I N E	DESCRIPTION/CODE No.	Q' TY
ユニット UNIT			
ファクシミリ受画装置 FACSIMILE RECEIVER		FAX-30 000-057-102	1
予備品 SPARE PARTS SP08-01901			
ヒューズ FUSE		FGB0 2A AC250V 000-549-020	2
工事材料 INSTALLATION MATERIALS CP08-01701			
+トラスタップピンネジ +TAPPING SCREW		5X20 SUS304 1ヶ 000-802-081	4
その他工材 OTHER INSTALLATION MATERIALS			
ケーブル組品MJ CABLE ASSY.		MJ-A3SPF0024-035 000-146-470	1

(略図の寸法は、参考値です。 DIMENSIONS IN DRAWING FOR REFERENCE ONLY.)

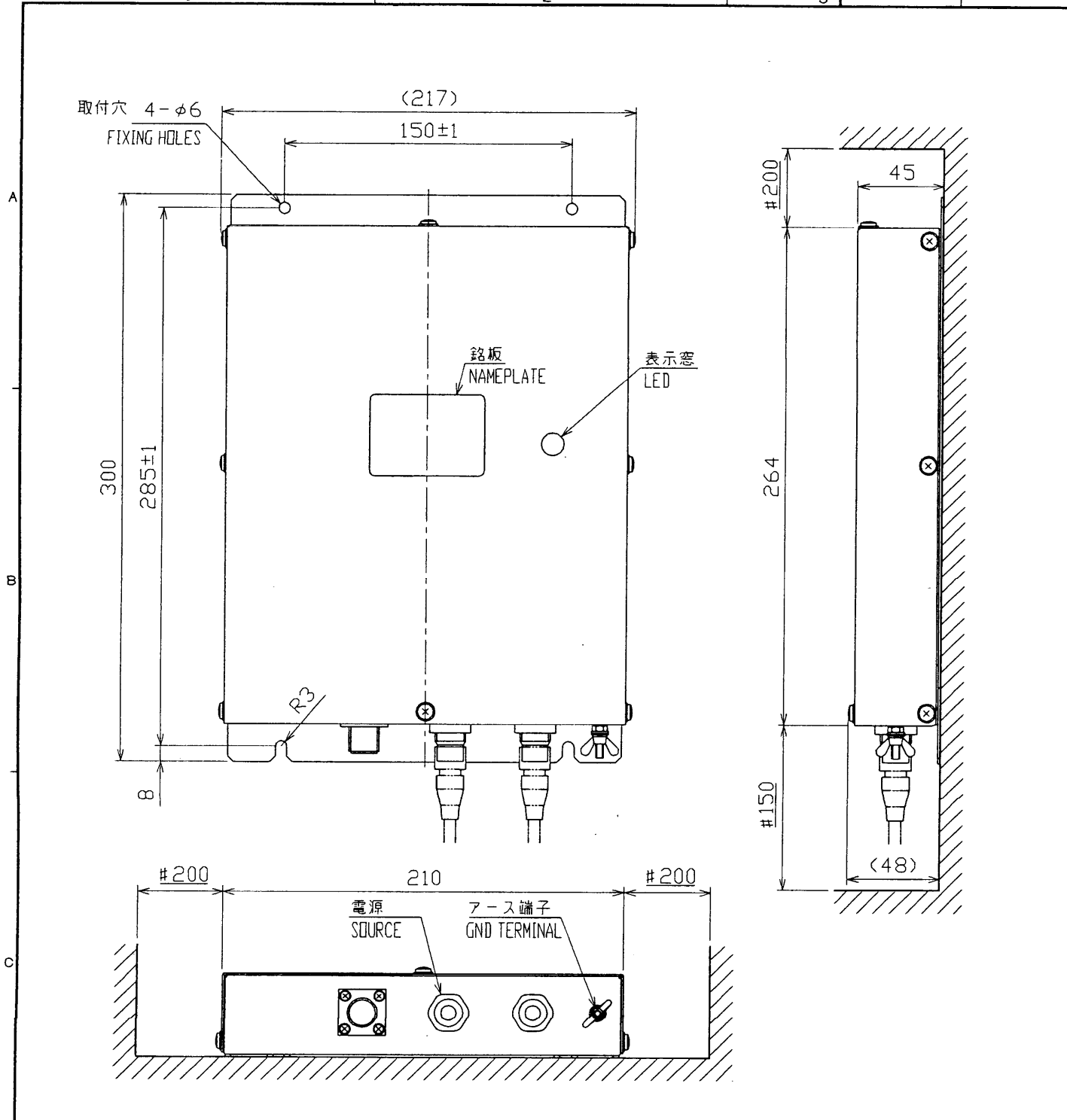

注 記 1) #印寸法は最小サービス空間寸法とする。
 2) 指定外の寸法公差は表1による。
 3) 取付用ネジは+トラスタップピンネジ呼び径5×20を使用。

NOTE 1. #: RECOMMENDED SERVICE CLEARANCE.
 2. TABLE 1 INDICATES TOLERANCE OF DIMENSIONS.
 3. USE TAPPING SCREWS 5x20 FOR FIXING THE UNIT.

寸法区分 (mm) DIMENSION	公差 (mm) TOLERANCE
L ≤ 50	± 1.5
50 < L ≤ 100	± 2.5
100 < L ≤ 500	± 3

表 1 TABLE 1

DRAWN July 5 '02 T.YAMASAKI	TITLE FAX-30
CHECKED July 5 '02 Y.KI	名称 ファクシミリ受画装置
APPROVED July 5 '02 Y.KI	外寸図
SCALE 1/3 MASS 2.0 ±10% kg	NAME FACSIMILE RECEIVER UNIT
C6260-G01-A	08-022-100G-0
OUTLINE DRAWING	

2

3

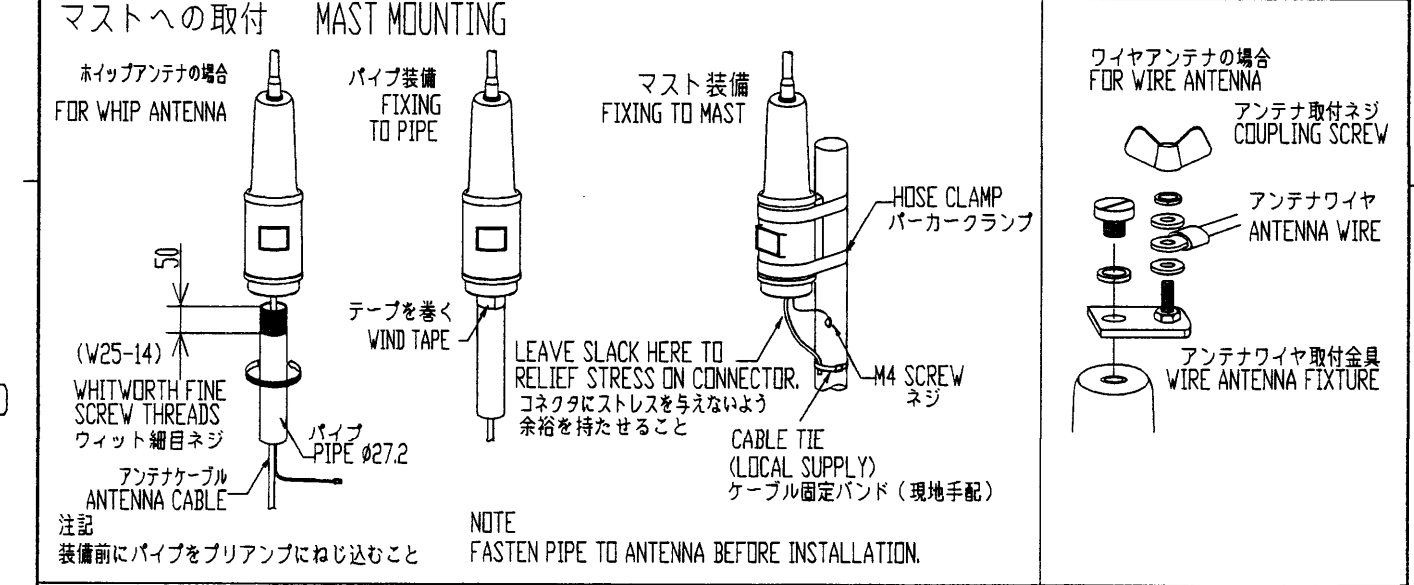
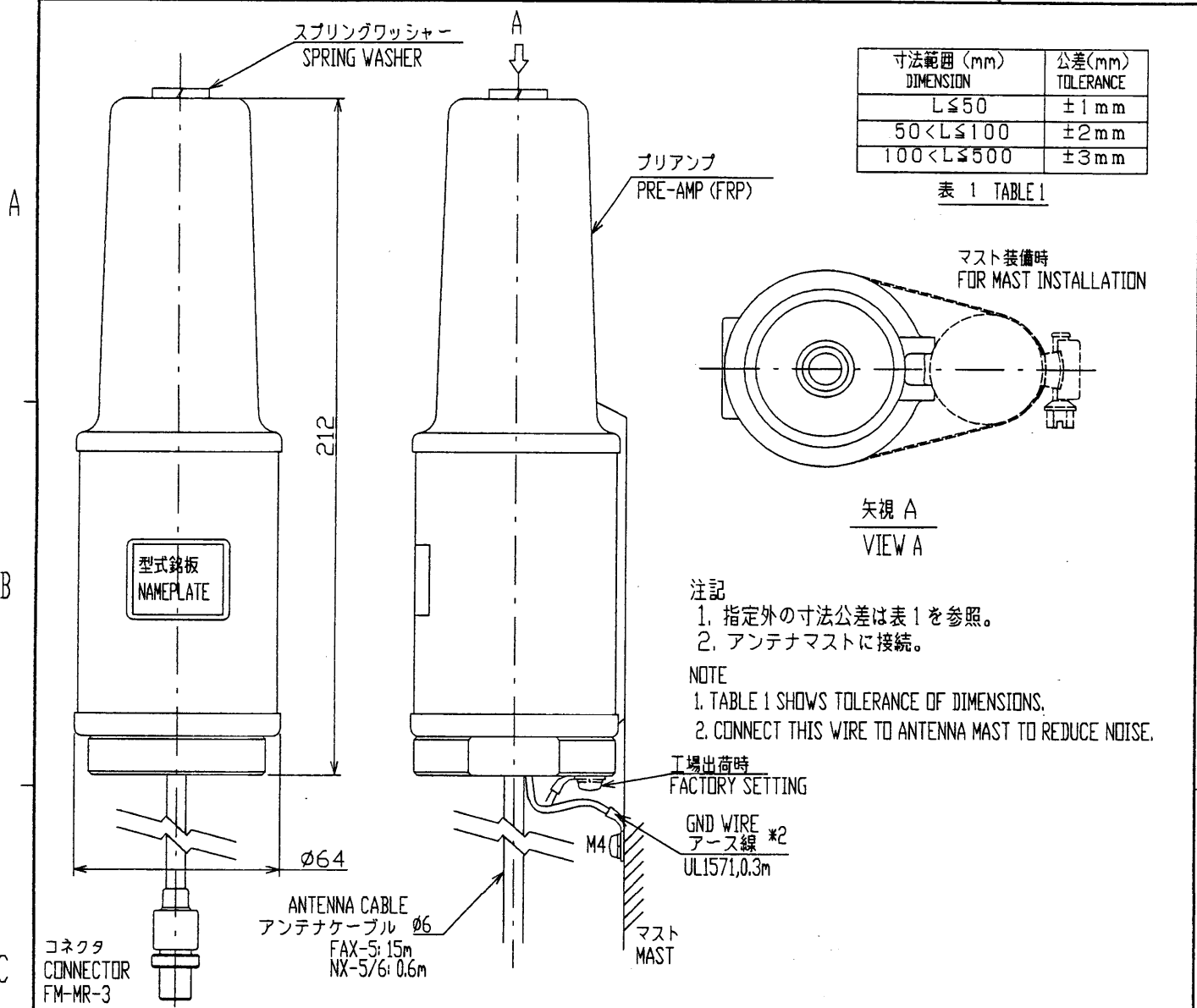

DRAWN Aug. 23 '02 T. YAMASAKI	TITLE FAX-5, NX-5/6
CHECKED Aug. 26 '02 Y. K.	名称 プリアンプ
APPROVED Aug. 26 '02 Y. K.	外寸図
SCALE 1/2	NAME PRE-AMP UNIT
MASS 0.6 $\pm 10\%$ kg	OUTLINE DRAWING
DWG.No. C6244-003-K	

質量はケーブルを含みます。
MASS W/O CABLE.

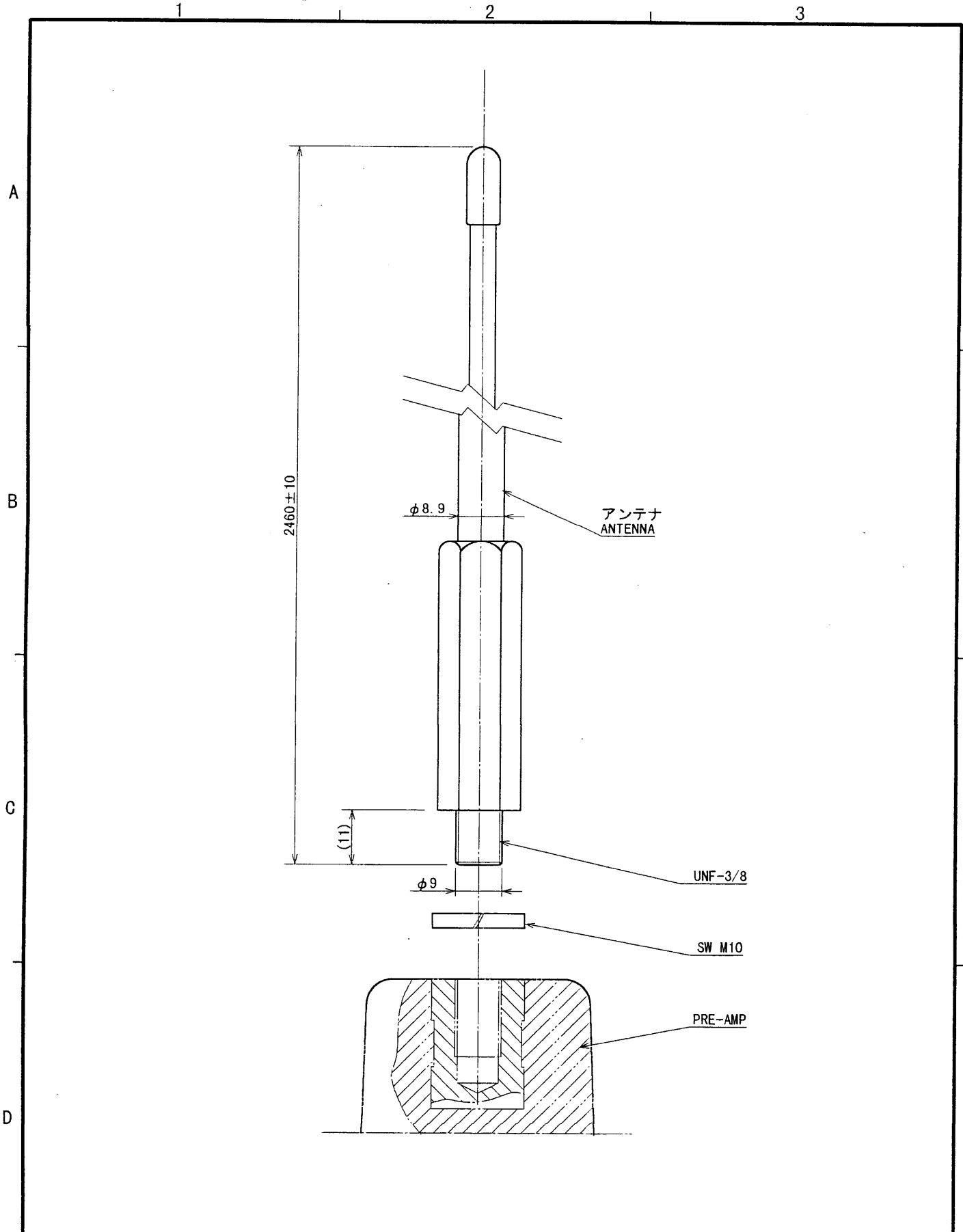

DRAWN June 27 '60 T. YAMASAKI		TITLE 04S4176-1
CHECKED June 27 '60 Y. Kim		名称 2.6m ホイップアンテナ
APPROVED June 27 '60 Y. Kim		外寸図
SCALE 1/1	MASS 0.5 kg	NAME 2.6m WHIP ANTENNA
DWG. No. C4002-018-F		OUTLINE DRAWING

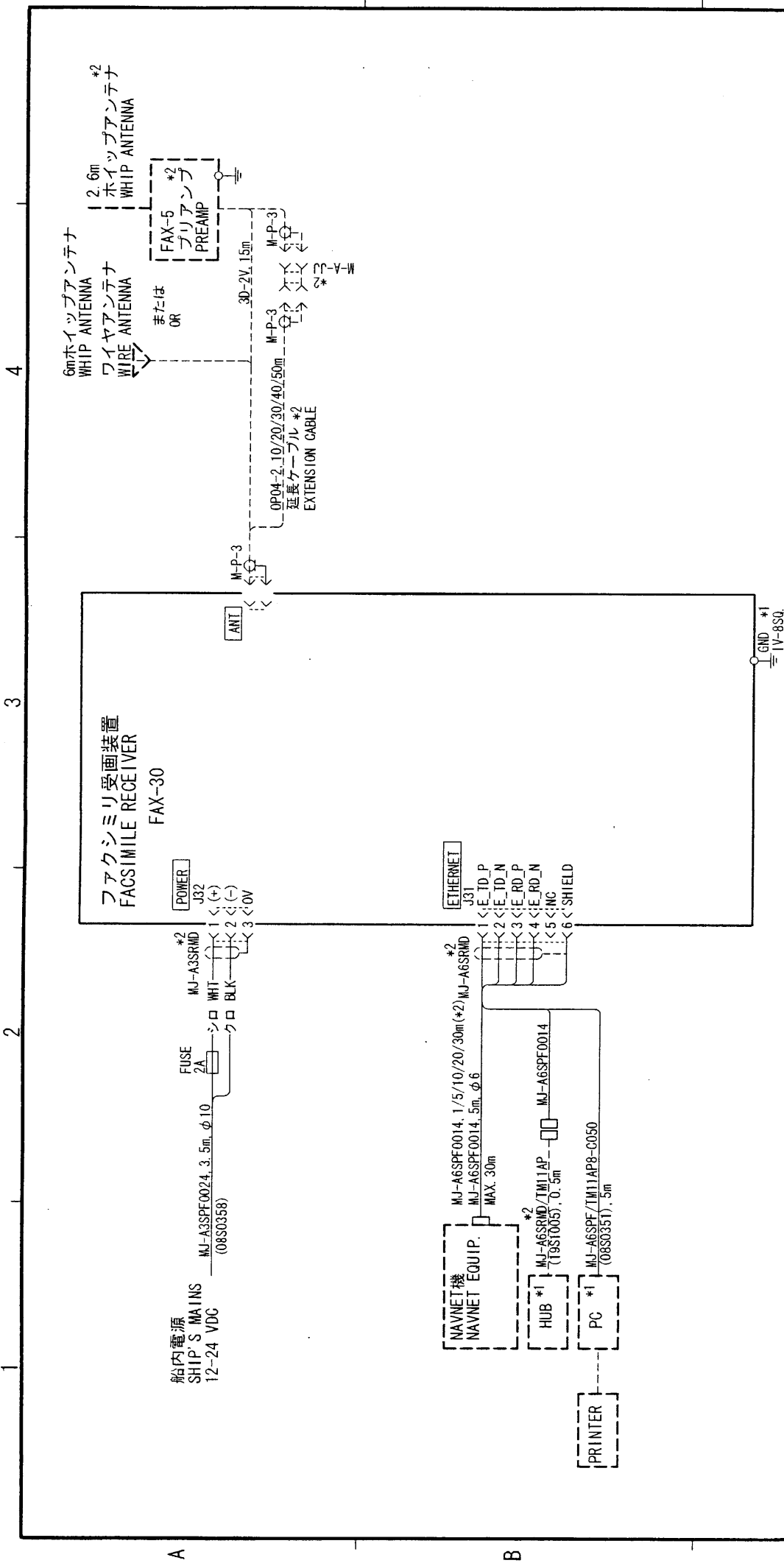

注記

- * 1) 造船所手配。
- * 2) オプション。

NOTE

- *1. SHIPYARD SUPPLY.
- *2. OPTION.

DRAWN	AUG. 5 '02	I. YAMASAKI	TITLE	FAX-30
CHECKED	MAY 5 '02	Y. K.	名称	ファクシミリ受画装置
APPROVED	AUG 5 '02	Y. K.	相互結線図	
SCALE	MASS		NAME	FACSIMILE RECEIVER
DWG. No.	C6260-C01-A		INTERCONNECTION DIAGRAM	

1B4 CHASSIS FAX RECEIVER FAX-30

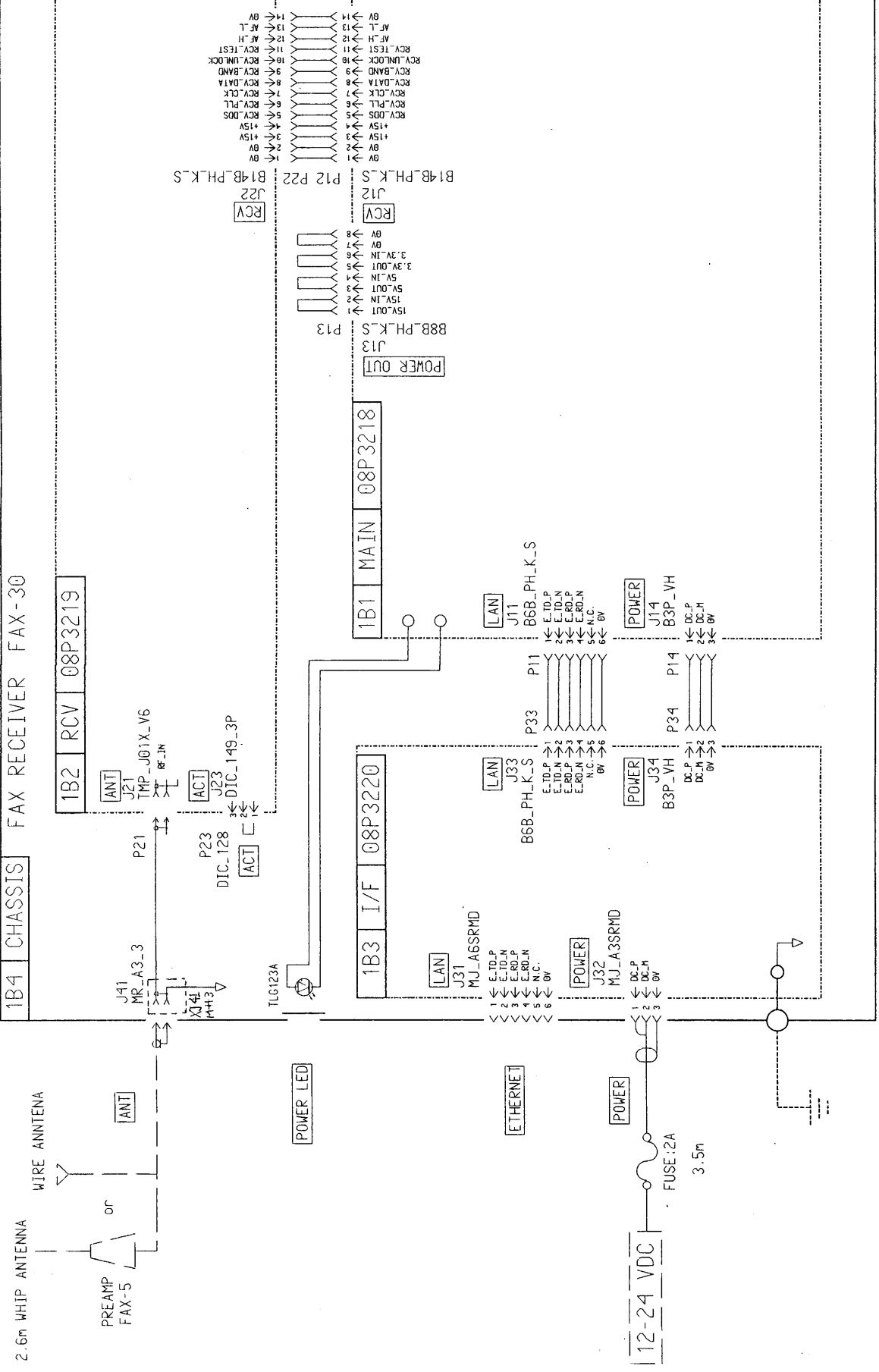

DRAWN 02.07/25 T. YAMASAKI	TYPE FAX-30
CHECKED 02/07/25 Y. KUROKI	名称 ファクシミリ受信装置
APPROVED 02/07/25 Y. KUROKI	回路図
SCALE MASS	MODEL FAX-30
Dwg No. C6260-K01-A	BLOCK No. 1 B4
	NAME FACSIMILE RECEIVER
	SCHEMATIC DIAGRAM
	08-001-3146-2

INDEX

A

Automatic fax receiving	
starting (NavNet).....	2-1
starting (PC).....	3-1
stopping (NavNet).....	2-4
stopping (PC).....	3-1

C

CCW soft key.....	2-16
CH SETUP soft key.....	2-2
CHANNEL soft key.....	2-3
CLEAR ALL soft key.....	2-11
Clearing data	
NavNet.....	6-5
PC.....	6-6
COLOR soft key.....	2-15
Controls (NavNet).....	1-1
CW soft key.....	2-16

D

Diagnostics	
NavNet.....	6-3
PC.....	6-4
DISP key.....	1-3

E

EDIT COLOR soft key.....	2-15
ERASE IMAGE soft key.....	2-16
Erasing fax images	
NavNet.....	2-16
PC.....	3-9
preventing erasure of (NavNet).....	2-17
preventing erasure of (PC).....	3-10

F

Fax channel addition	
NavNet.....	2-18
PC.....	3-11
Fax images	
displaying (NavNet).....	2-12
displaying (PC).....	3-5
erasing (NavNet).....	2-16
erasing (PC).....	3-9
preventing erasure of (NavNet).....	2-17
preventing erasure of (PC).....	3-10
processing (NavNet).....	2-13

processing (PC).....	3-5
saving (PC).....	3-9
FAX mode (NavNet).....	1-3
Fax station list.....	AP-2
Fax station map.....	AP-1

I

Image color	
NavNet.....	2-15
PC.....	3-8
Image format	
NavNet.....	2-15
PC.....	3-8

L

LOCK IMAGE soft key.....	2-17
LOCK/ERASE soft key.....	2-16
Logout.....	1-8

M

Maintenance.....	6-1
Manual fax receiving (NavNet)	
starting.....	2-5
stopping.....	2-6
Menu tree.....	AP-9

N

Navtex messages	
categories.....	4-1
displaying (NavNet).....	4-6
displaying (PC).....	5-3
previewing (NavNet).....	4-5
Navtex setup	
NavNet.....	4-2
PC.....	5-2
Navtex stations	
list of.....	AP-5
map of.....	AP-4
Navtex stations	
addition (NavNet).....	4-9
addition (PC).....	5-5
editing (NavNet).....	4-9
editing (PC).....	5-6
erasing (PC).....	5-7
list (NavNet).....	4-8
list (PC).....	5-4
NOISE REJECT soft key.....	2-14

INDEX

Noise rejection	
NavNet	2-14
PC	3-7

P

Phase	
NavNet	2-13
PC	3-6
PHASE soft key	2-13
PROG LIST soft key	2-11

R

RCV NAVTEX soft key	4-5
Receive mode	
NavNet	1-4
PC	1-8
Receive notification (NavNet)	1-5
REV IMAGE soft key	2-15
ROTATE soft key	2-16
Rotating fax images	
NavNet	2-16
PC	3-9
RX MODE soft key	1-4
RX NOTICE soft key	1-5

S

Saving fax images (PC)	3-9
SELECT IMAGE soft key	2-12
Simulation mode	
NavNet	6-8
PC	6-9
Standby display	
PC	1-6
STATION soft key	2-2
STOP RX soft key	2-4
Sync	
NavNet	2-14
PC	3-7
SYNC soft key	2-14
System configuration	ix

T

Timer operation	
clearing all programs (NavNet)	2-11
clearing all programs (PC)	3-4
setting (NavNet)	2-7
setting (PC)	3-2
turning on/off all program (NavNet)	2-11
turning on/off all programs (PC)	3-4
turning on/off specific	
programs (NavNet)	2-11
turning on/off specific programs (PC)	3-4
TIMER SETUP soft key	2-11
TIMER soft key	2-7

Z

ZONE soft key	2-2
Zoom	
NavNet	2-16
PC	3-9
ZOOM IN soft key	2-16
ZOOM OUT soft key	2-16

FURUNO®

FURUNO ELECTRIC CO., LTD.

9-52 Ashihara-Cho, Nishinomiya City, 662-8580, Hyogo, Japan
Tel: +81 798-65-2111 Fax: +81 798-65-4200

Pub NO. DOC-487

Declaration of Conformity



We FURUNO ELECTRIC CO., LTD.

(Manufacturer)

9-52 Ashihara-Cho, Nishinomiya City, 662-8580, Hyogo, Japan

(Address)

declare under our sole responsibility that the product

Facsimile receiver Model FAX-30

(Model name, serial number)

is in conformity with the essential requirements as described in the Directive 1999/5/EC of the European Parliament and of the Council of 9 March 1999 on radio equipment and telecommunications terminal equipment (R&TTE Directive) and satisfies all the technical regulations applicable to the product within this Directive

EN 60945: 1997-01 (IEC 60945 Third edition: 1996-11)

EN 60950: 2000 (IEC 60950 Third edition: 1999-04)

(title and/or number and date of issue of the standard(s) or other normative document(s))

For assessment, see

- Statement of Opinion N° 02214145/AA/00 of 30 July 2002 issued by Telefication, The Netherlands
- EMC Test Report FLI 12-02-029 of 26 July 2002 prepared by Furuno Labotech International Co., Ltd.
- Safety Test Report FLI 12-02-030 of 25 July 2002 prepared by Furuno Labotech International Co., Ltd.

On behalf of Furuno Electric Co., Ltd.

Hiroaki Komatsu
Manager,
International Rules and Regulations

Nishinomiya City, Japan
August 12, 2002

(Place and date of issue)

(name and signature or equivalent marking of authorized person)