

# FURUNO

## OPERATOR'S MANUAL

COLOR VIDEO SOUNDER

MODEL FCV-292



**FURUNO ELECTRIC CO., LTD.**  
NISHINOMIYA, JAPAN

© **FURUNO ELECTRIC CO., LTD.**

9-52 Ashihara-cho,  
Nishinomiya, Japan

Telephone : 0798-65-2111  
fax : 0798-65-4200

Your Local Agent/Dealer

All rights reserved.

Printed in Japan

PUB.No. OME-23520

( TENI ) FCV-292

FIRST EDITION : OCT. 1994

L1 : DEC. 24,2003



\* 00080637800 \*

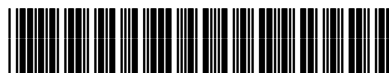

\* OME23520L10 \*



# SAFETY INSTRUCTIONS

"**DANGER**", "**WARNING**" and "**CAUTION**" notices appear throughout this manual. It is the responsibility of the operator and installer of the equipment to read, understand and follow these notices. If you have any questions regarding these safety instructions, please contact a FURUNO agent or dealer.



**DANGER**

This notice indicates a potentially hazardous situation which, if not avoided, will result in death or serious injury.



**WARNING**

This notice indicates a potentially hazardous situation which, if not avoided, could result in death or serious injury.



**CAUTION**

This notice indicates a potentially hazardous situation which, if not avoided, could result in minor or moderate injury, or property damage.



# SAFETY INFORMATION FOR THE OPERATOR

---



## WARNING



**Do not open the cover of the equipment.**

This equipment uses high voltage electricity which can shock, burn, or cause death. Only qualified personnel should work inside the equipment.

**Do not disassemble or modify the equipment.**

Fire, electrical shock or serious injury can result.

**Immediately turn off the power at the ship's mains switchboard if water or foreign object falls into the equipment or the equipment is emitting smoke or fire.**

Continued use of the equipment can cause fire, electrical shock or serious injury.



## CAUTION

**Do not place liquid-filled containers on the top of the equipment.**

Fire or electrical shock can result if a liquid spills into the equipment.

**Do not place heater near the equipment.**

Heat can melt the power cord, which can result in fire or electrical shock.

**Do not operate the unit with wet hands.**

Electrical shock can result.

**Use the correct fuse.**

Use of the wrong fuse can cause fire or equipment damage.

*(Continued on next page)*

# NOTICE

**Do not use the equipment for other than its intended purpose.**

Use of the equipment as a chair or a shelf, for example, can cause equipment damage.

**Immediately turn off the power whenever you feel the equipment is abnormal.**

Continued use can cause equipment damage.

**The useable temperature range is 0°C to 50°C.**

Use out of the range can cause equipment damage.

**Keep magnets and magnetic fields (speaker, transformer, etc.) away from the equipment.**

Magnets and magnetic fields can cause equipment malfunction.

**Do not place objects near the equipment.**

Objects near the equipment can cause overheating.

**Handle the equipment carefully.**

Rough handling can cause corrosion.

**Do not use chemical cleaners to clean the equipment.**

Chemical cleaners can remove paint and markings.



# SAFETY INFORMATION FOR THE INSTALLER



## WARNING



Only qualified personnel should work inside the equipment.

This equipment uses high voltage electricity which can shock, burn, or cause death.

**Turn off the power at the ship's mains switchboard before beginning the installation. Post a warning sign near the switchboard to ensure that the power will not be applied while the equipment is being installed.**

Serious injury or death can result if the power is not turned off, or is applied while the equipment is being installed.



## CAUTION



Ground the equipment to prevent electrical shock and mutual interference.

Ungrounded equipment can give off or receive electro-magnetic interference or cause electrical shock.

**Confirm that the power supply voltage is compatible with the voltage rating of the equipment.**

Connection to the wrong power supply can cause fire or equipment damage. The voltage rating appears on the label at the rear of the equipment.

## NOTICE

**The mounting location must satisfy the following conditions:**

- Away from rain and water splash
- Out of direct sunlight
- Away from air conditioner vents
- Away from magnets and magnetic fields
- Moderate and stable in temperature and humidity

# A Word To Furuno FCV-292 Owners:

---

Congratulations on your choice of the FURUNO FCV-292 Color Video Sounder! We are confident that you will enjoy many years of operation with this fine piece of equipment.

For over 40 years Furuno Electric Company has enjoyed an enviable reputation for quality and reliability throughout the world. This dedication to excellence is furthered by our extensive global network of agents and dealers.

The FCV-292 Color Video Sounder is just one of the many Furuno developments in the field of echo sounding. The compact, lightweight but rugged unit is easy to install and operate and is suitable for both fresh and salt water applications.

This unit is designed and constructed to give the user many years of trouble-free operation. However, to obtain optimum performance from this unit, you should carefully read and follow the recommended procedures for installation, operation and maintenance. No machine can perform to the utmost of its ability unless it is installed and maintained properly.

We would appreciate feedback from you, the end-user, about whether we are achieving our purposes.

Thank you for considering and purchasing Furuno equipment.

## Features

The FCV-292 is a dual-frequency color video sounder which has a large variety of functions, all contained in a splash-proof rugged aluminum case that is compact to fit small size boats.

- Thought of user-friendly design have brought a simple operation.
- A wide variety of presentation modes (incl. marker zoom, bottom-lock expansion, marker zoom, bottom zoom and bottom discrimination display), using potent 1 kW transceiver, and NAV data display are available.
- 8 or 16-color presentation (including background), on a 10" diagonal CRT, gives you detailed information on fish density and the nature of the bottom.
- AUTO function permits unattended range and gain setting operations. The range scale and gain change automatically so that the bottom is displayed in reddish brown on the lower half of the screen.
- A-scope presentation especially useful for bottom trawler and lobster/crab potter is incorporated.

- Digital display of navigational data, ship's speed and water temperatures in addition to water depth ensures finding of best fishing ground and safe navigation.
- Alarm may be activated. The operator is alerted when bottom or fish echoes enter into the preset alarm zone.
- Pulselengths from 0.1 to 2.0 msec. for excellent performance on both shallow and deep ranges.
- Universal 10.5-20.0 VDC or 18.0-40.0 VDC power supply drawing 45 W of power.

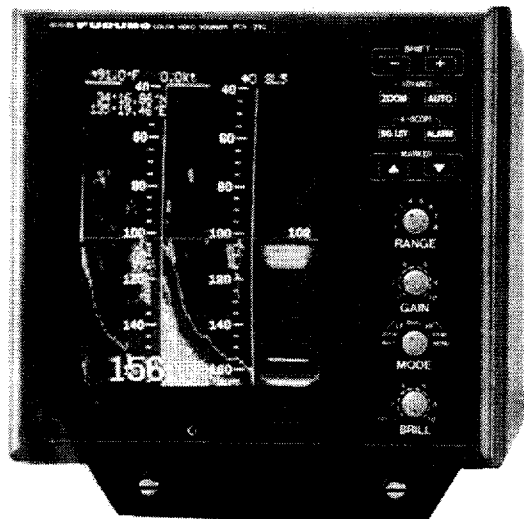



# Table of Contents

---

<b>A Word To Furuno FCV-292 Owners:</b> .....	<b>i</b>
Features .....	i
<b>1.HANDLING PRECAUTION .....</b>	<b>1</b>
<b>2.SYSTEM CONFIGURATION .....</b>	<b>2</b>
<b>3.PRINCIPLE OF OPERATION .....</b>	<b>3</b>
<b>4.OPERATING CONTROLS .....</b>	<b>4</b>
<b>5.BASIC OPERATION .....</b>	<b>6</b>
Power ON/OFF and Brilliance Control.....	6
Demonstration Picture.....	6
Presentation Mode Selection .....	6
Zoom Picture Selection.....	9
Automatic Operation .....	12
Manual Operation .....	12
Picture Advance Speed Selection .....	14
Eliminating Low Intensity Echoes.....	15
Turning on A-Scope Presentation .....	15
Measuring Depth to Fish School .....	15
<b>6.FISH AND BOTTOM ALARMS.....</b>	<b>16</b>
<b>7.ADJUSTING PICTURE BY MENU .....</b>	<b>18</b>
Eliminating Interference (NOISE LIMITER) .....	18
Eliminating Low Level Noise (CLUTTER LEVEL).....	19
Adjusting Preset Gain .....	19
Selecting Background Color and Echo Color (HUE SELECTION).....	20
<b>8.DISPLAYS .....</b>	<b>21</b>
Video Sounder Picture .....	21
Navigation Data .....	24
<b>9.INTERPRETING THE DISPLAY .....</b>	<b>25</b>
Frequency.....	25
Detecting Area .....	25
Zero Line .....	26
Fish School Echoes .....	27
Bottom Echo .....	27
Surface Noise/Aeration .....	28

<b>10.MAINTENANCE .....</b>	<b>29</b>
Fuse Replacement .....	29
Cleaning .....	29
Maintenance of Transducer .....	30
<b>11.TROUBLESHOOTING .....</b>	<b>31</b>
Basic Troubleshooting .....	31
Diagnostic Self-Check .....	33
Transducer Check .....	34
Speed/Temperature Sensor (Option) Check .....	34
<b>12.INSTALLATION .....</b>	<b>35</b>
Display Unit Installation .....	35
Transducer Installation .....	37
Transducer Preparation and Painting .....	37
Speed/Temperature Sensor .....	38
Cable Connections .....	39
<b>13.SYSTEM MENU SETTING .....</b>	<b>41</b>
Operation Procedure .....	41
Description of System Menu Item .....	42
Restoring Factory Settings .....	44
<b>14.SPECIFICATIONS .....</b>	<b>45</b>
Complete Set .....	47
Installation Materials .....	48
Accessories .....	48
Spare Parts .....	48
Option .....	48
Transducer & Hull Bottom Installation Materials .....	49
<b>APPENDIX</b>	
1. Changing Transducer Output Power Setting .....	A-1
2. Changing Transducer Frequency Specifications .....	A-2
3. Adjustment After Replacement of MAIN or AMP Board (entering amplifier gain offset) .....	A-4
4. Transducer 50BL-12/50BL-24H .....	A-6
5. New BLT Transducers .....	A-7
<b>OUTLINE DRAWING .....</b>	<b>D-1</b>
<b>INTERCONNECTION DIAGRAM .....</b>	<b>S-1</b>

# 1. HANDLING PRECAUTION

- Moderate screen brightness to extend life of CRT.
- Do not remove display unit cover. High voltage exists inside.

\* Observe the following points to keep your FCV-292 in top condition for many years.

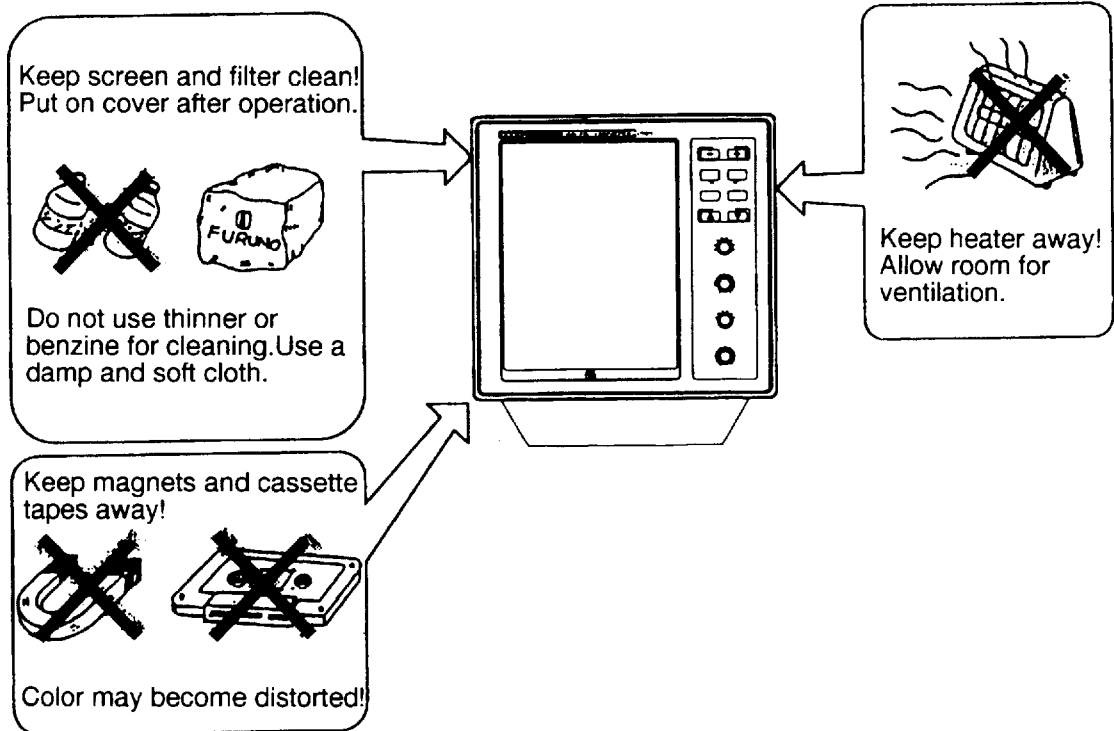

# 2. SYSTEM CONFIGURATION

The FCV-292 consists of the following units.

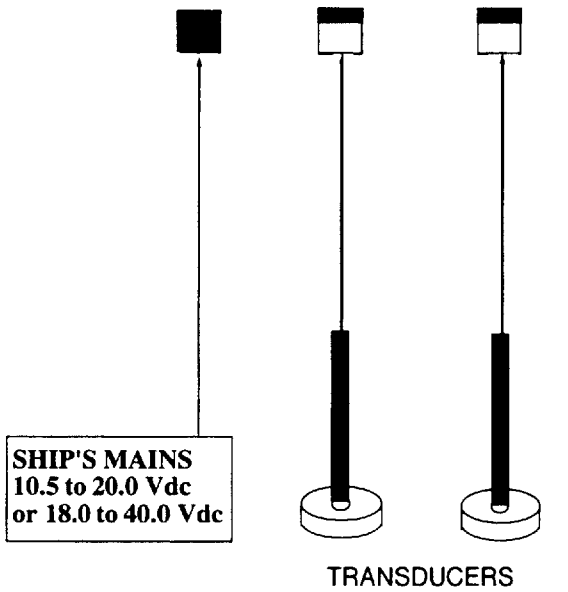
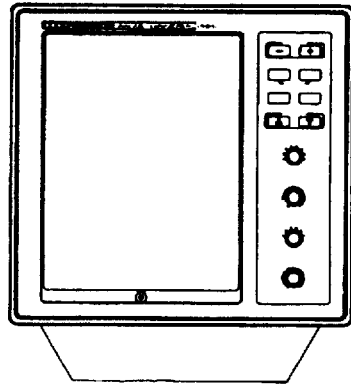

## DISPLAY UNIT FCV-292

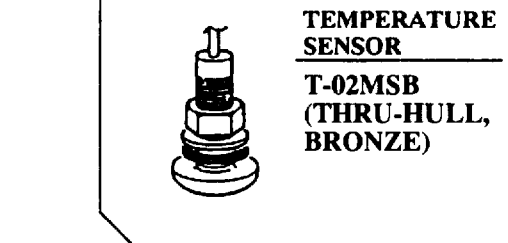
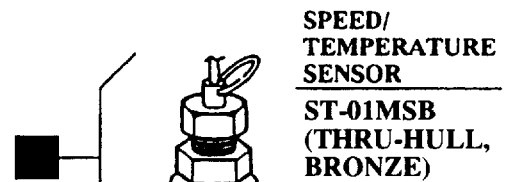

(STANDARD SUPPLY)



(OPTIONAL SUPPLY)

-  Connector fitted at factory
-  Connector to be fitted at installation

### 3. PRINCIPLE OF OPERATION

The FCV-292 Color Video Sounder determines the distance between its transducer and underwater objects such as fish, lake bottom or seabed and displays the results on a 10" color screen. It does this by utilizing the fact that an ultrasonic wave transmitted through water travels at a nearly constant speed of 4800 feet (1500 m) per second. When a sound wave strikes an underwater object such as fish or sea bottom, part of the sound wave is reflected back toward the source. Thus by calculating the time difference between the transmission of a sound wave and the reception of the reflected sound wave, the depth to the object can be determined. In a sense an echo sounder can be thought of as being an extremely sophisticated and quick timer, since it is capable of resolving time differences shorter than one thousandth of a second.

The entire process begins in the display unit. Transmitter power is sent to the transducer as a short pulse of electrical energy. The electrical signal produced by the transmitter is converted into an ultrasonic signal by the transducer and transmitted into the water. Any reflected signals from intervening objects (such as a fish school) are received by the transducer and converted back into an electrical signal. It is then amplified in the amplifier section, and finally, displayed on the screen.

The picture displayed by the FCV-292 is made up of a series of vertical scan lines, one for each transmission. Each line represents a "snapshot" of what has occurred beneath the boat. The series of snapshots are accumulated side by side across the screen, and the resulting contours of the bottom and fish between the bottom and surface are displayed. The amount of history of objects that have passed beneath the boat over a series of transmission varies from less than a minute to a few minutes, depending on how you adjust the unit.

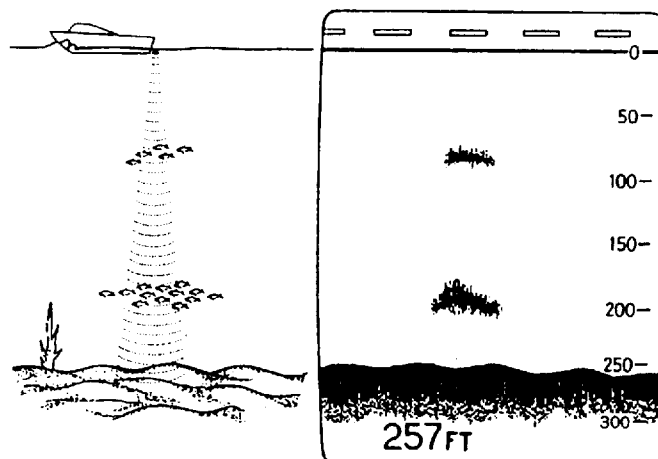

## 4. OPERATING CONTROLS

The equipment is so designed that even a first time user can quickly become acquainted with the operating procedure. Pressing of each touchpad key is acknowledged by a beep sound, and keying sequence is smartly organized and acknowledged by alphanumeric/symbolic indicators on the screen.



KEY/CONTROL	FUNCTION
	Changes start depth of the picture. Selects desired parameters on the menu page.
	With the <b>MODE</b> switch set to <b>ZOOM</b> position, pressing this key selects one of three expansion pictures; marker zoom, bottom-lock expansion, bottom zoom and bottom discrimination.
	Turns on/off the <b>AUTO</b> function in which appropriate gain setting and range scale are automatically selected the computer according to intensity of received echoes and depth of seabed. Two types of <b>AUTO</b> functions are available; <b>AUTO-1</b> suitable for searching fish school and <b>AUTO-2</b> suitable for tracking seabed.



**ZOOM** and **AUTO** keys pressed simultaneously select picture advance speed.



Eliminates low intensity echoes in two or five steps up to light blue color echoes.



Turns on/off the alarm function.  
Selects alarm mode: Fish or Bottom alarm.

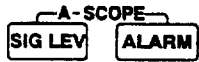

**SIG LEV** and **ALARM** keys pressed simultaneously display A-scope picture on the right 1/4 of the screen. To turn it off, press the two keys again.



Move the variable range marker and the position of the white color bar. These are also used to set the alarm zone or to change the MENU items.

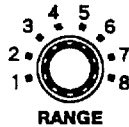

Sets the basic range of the picture.



Adjusts picture sensitivity.

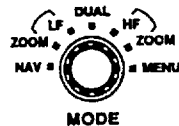

Selects presentation mode.

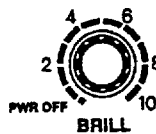

Turns on/off the unit and adjusts screen brilliance.

# 5. BASIC OPERATION

## Power ON/OFF and Brilliance Control

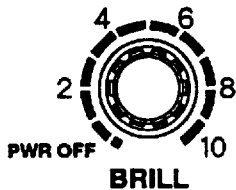

**ON** ..... Turn the **BRILL** control clockwise until a click sound is heard and a proper picture brilliance is obtained.

The unit starts with the settings used before it was turned off.

*Note:*

1. There is a few second delay prior to display of the picture until the CRT warms up.
2. Keep the moderate brilliance to extend the life of the CRT.

**OFF** .... Turn the **BRILL** control fully counterclockwise.

### Demonstration Picture

A convenient demonstration picture is incorporated for a self-study of the operation without connecting the transducer.

#### Procedure

1. Turn the unit on while pressing one of the keys, and the option mode menu appears.
2. Press **MARKER** [▼] key, and the demonstration picture will be displayed.
3. Operate any keys and controls described as follows for study.
4. Turn the unit off/on to return to the normal display.

## Presentation Mode Selection

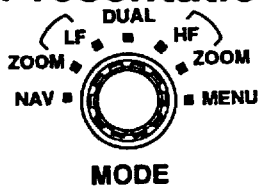

Seven presentation modes are available and you may select one of them with the **MODE** switch.



MODE	FUNCTION
NAV	displays navigation data such as ship's position (L/L), ship's speed, water temperature on full screen.
(LF) ZOOM	displays normal picture for low frequency on right half and its zoom picture on left half of screen.
LF	displays normal picture for low frequency on full screen.
DUAL	displays normal picture for high frequency on right half and that for low frequency on left half of screen.
HF	Same as LF except that frequency is different.
(HF) ZOOM	Same as (LF) ZOOM except that frequency is different.
MENU	displays menu on which unfrequently altered parameters are preset.

## LF or HF

This is a basic presentation mode for observing fish schools and seabed.

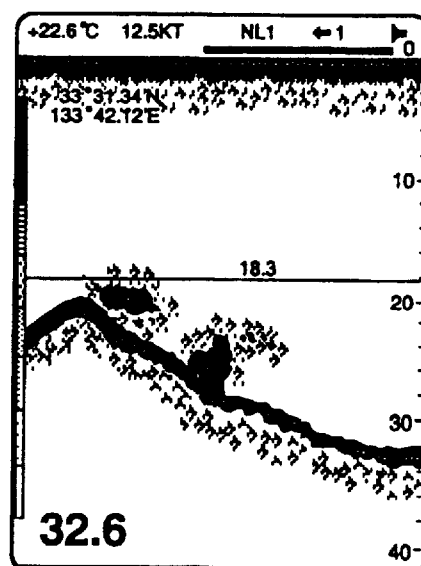

## DUAL

This mode is useful for detecting fish school which has different reflection characteristics with frequency. For example, school of tiny fish like minnow returns stronger echoes on a high frequency compared to a low frequency.

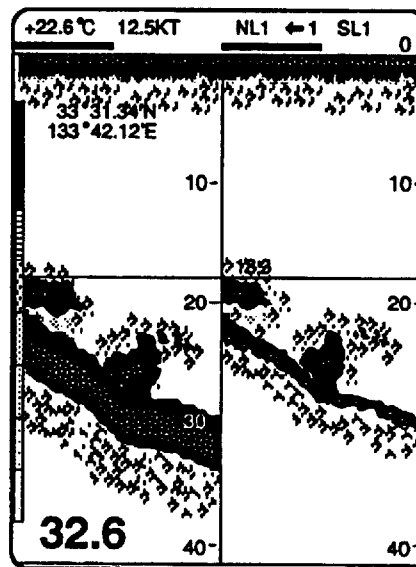

Low Frequency      High Frequency

## ZOOM

Refer to the next paragraph Zoom Picture Selection.

## NAV

On this NAV mode, the navigation data are digitally displayed on the entire screen as shown below. See page 24 for further information.

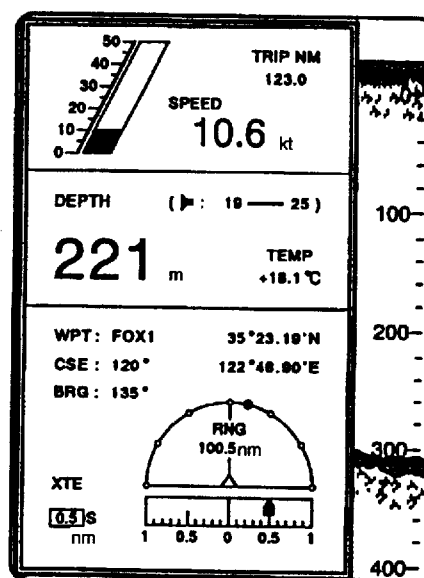

# Zoom Picture Selection

**ZOOM**

Four types of the zoom pictures are available: bottom-lock expansion, bottom zoom, bottom discrimination and marker zoom. To select one of them, press the **ZOOM** key with the **MODE** switch set to the **ZOOM** position.

*NOTE :*

- 1. For the bottom-lock expansion, bottom zoom and bottom discrimination presentations, the depth must be steadily read out at the lower left corner of the screen.*
- 2. The zoom marker can be turned off on the system menu [1]. See page 44.*

## Bottom-Lock Expansion

The bottom-lock expansion provides a compressed normal picture on the upper 2/3 of the screen and a 10 m - 200 m (user-settable) wide layer in contact with the seabed is expanded onto the rest of the screen with the seabed contour displayed by a straight line at the screen bottom. The range of expansion can be easily recognized on the normal picture because it is marked with a yellow color as illustrated below. This mode of presentation offers an excellent bottom fish discrimination which is indispensable for bottom trawlers.

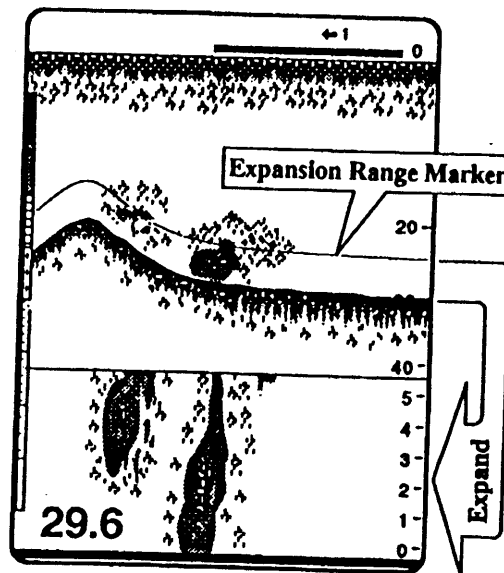

*NOTE: The bottom-lock expansion range can be selected on the system menu [3]. See page 44.*

## Bottom Zoom

The bottom zoom expands bottom and bottom fish echoes 2 to 5 times to full vertical size of the screen. The zone expanded is indicated by a zoom range markers on the normal picture display.

The zone automatically moves so that the bottom echoes are located on the lower half screen.

This mode may be advantageous for observing hardness of the bottom closely together with bottom fish. Many fishermen find the place where bottom fish are likely to be, from the shape of bottom profile and length of tail of bottom echoes. Some fish may live on soft sandy bottom which is displayed with short tails and some fish on hard bottom displayed with long echo tails. In addition, as you become acquainted with this mode, you may find a small school of bottom fish which may be overlooked even on the bottom-lock expansion picture

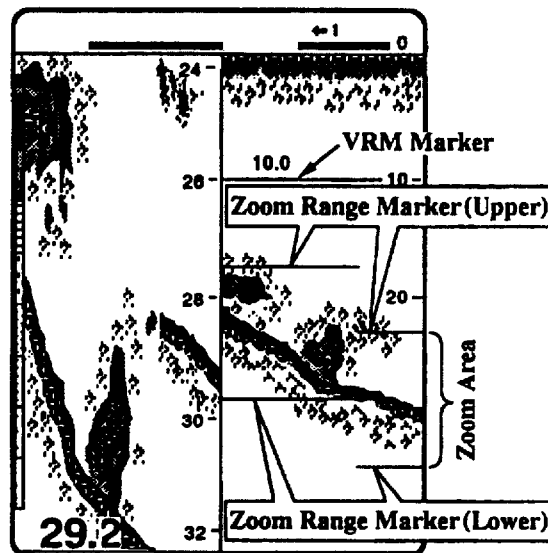

*NOTE: The zoom range can be selected on the system menu [3]. See page 44.*

## Bottom Discrimination

In this mode, a bottom contour appears in a straight line at the screen center. The upper part of the screen displays fish echoes expanded like a bottom-lock picture and the lower part, bottom reflections below a bottom contour with a normal range scale.

This mode will enable you to readily find bottom nature on the same screen.

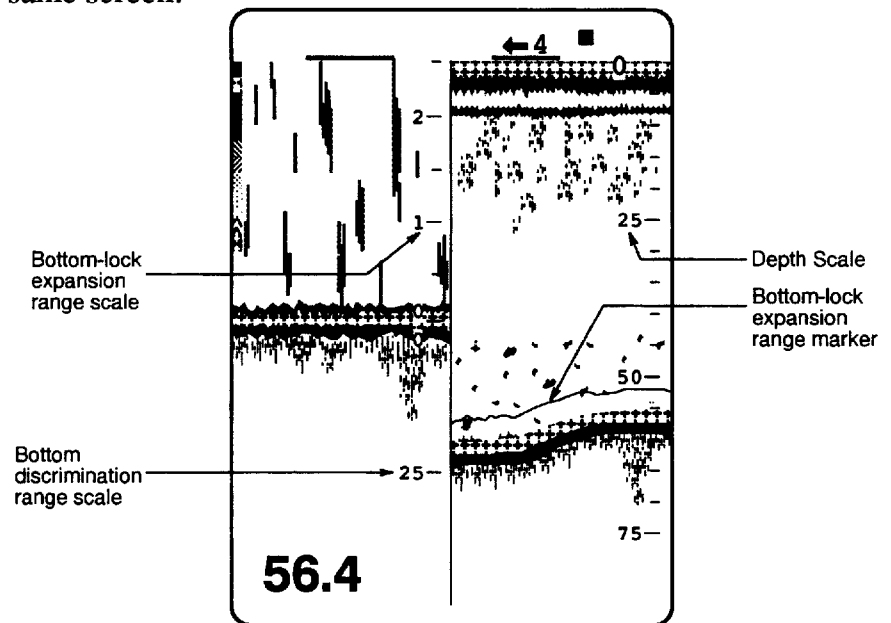

## Marker Zoom

This mode expands anywhere of the normal picture to full vertical size of the screen on the left half window of the screen. You may specify the portion to be expanded with **MARKER** [▲] or [▼] key. The segment between the VRM and zoom range markers are expanded. The length of the segment is equal to one division of the depth scale.

*NOTE: The zoom range can be selected on the system menu [3]. See page 44.*

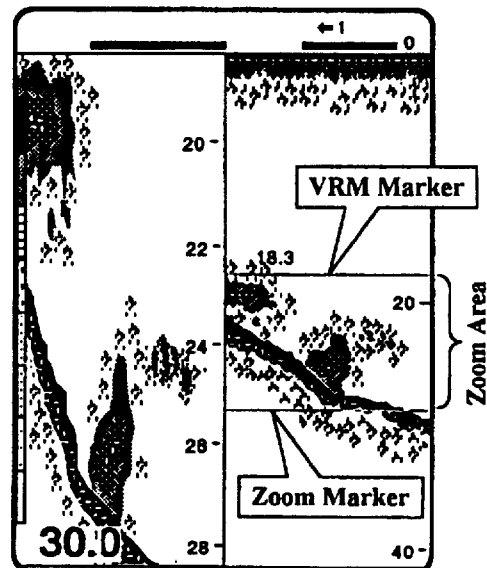

## Automatic Operation

The video sounder can be operated either automatically or manually. Automatic operation is useful when you are preoccupied with other tasks and do not have the time to adjust the display.

In the AUTOMATIC operation, the gain and the range scale are automatically selected by the computer. You may use this function virtually all the times. How it actually works is as follows;

- Range changes automatically to locate the bottom on the lower half of the screen. It jumps to one step shallower range when bottom echoes reach a half way point of the full scale from the top and to one step deeper range when they come to the lower edge of the screen.
- The gain is automatically adjusted to display the bottom echo in reddish brown.

### Procedure

**AUTO**

1. Press the **AUTO** key to select automatic mode desired.

There are two types of AUTO function:

**AUTO-1:** fish mode suitable for searching fish schools.

**AUTO-2:** cruising mode for tracking a seabed.

Since AUTO-2 uses a higher clutter setting than AUTO-1, small and weak fish echoes may be eliminated.

#### *NOTE:*

*1. The AUTO function stops working when bottom echoes go deeper than the depth range 8. Factory settings are 500 m (250 fa, 1500 ft).*

*2. In the AUTO function, the CLUTTER and GAIN ADJUST on the menu are automatically set to AUTO (A).*

## Manual Operation

Manual operation (**AUTO OFF**) is useful for observing fish schools and the seabed using fixed gain, range and shift settings.

### Procedure

**AUTO**

1. Press the **AUTO** key several times to select **AUTO OFF**.

#### Normal Picture Range Selection

The Basic Range and Range Shifting functions used together give you the means to select the depth you can observe directly under the boat. The Basic Range can be thought of as providing a window into the water column.

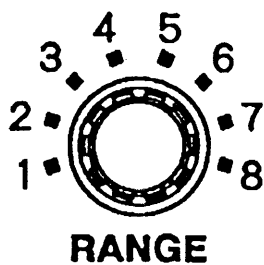
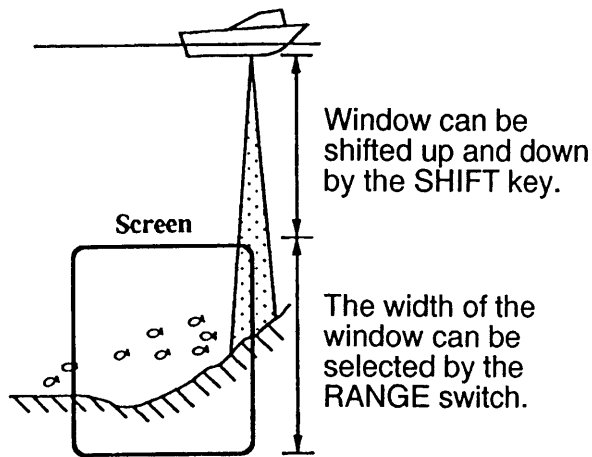

### Basic Range Selection

The Basic Range is selected with **RANGE** switch from 8 ranges shown in the table.

Range No.	1	2	3	4	5	6	7	8
Meters (m)	5	10	20	40	80	150	300	500
Feet (Ft)	15	30	60	120	200	400	1000	1500
Fathoms (FA)	3	5	10	20	40	80	150	250
Passi/Braza(P/B)	3	5	10	30	50	100	200	300

*NOTE:*

*The ranges are user reprogrammable on the system menu [3]. See page 44.*

### Range Shifting

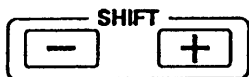

The basic range (window) selected may be shifted up and down by pressing **SHIFT [-]** or **[+]** key. The amount of range shifting, i.e., the depth at the upper limit of the window, is digitally indicated at the top right corner of the screen.

*NOTE: When the AUTO function is turned on by pressing the AUTO key, the manual range setting mentioned above is not operative.*

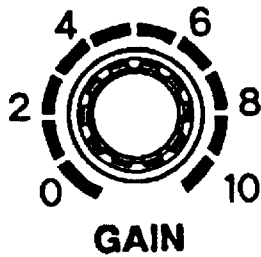

### Gain Control Setting

The **GAIN** control adjusts the sensitivity of the receiver. Normally, the gain is set to the point just below where excessive noise appears on the screen. As a general rule of thumb, use a higher gain setting for greater depths and a lower setting for shallower waters.

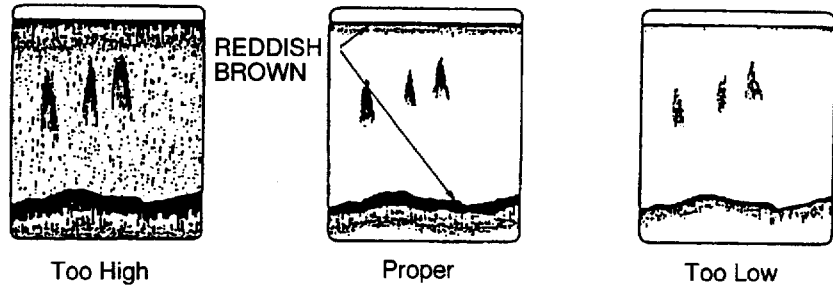

Gain Control Adjustment

*NOTE: The GAIN control adjusts the sensitivity for both low and high frequency pictures. If you wish to change it only for either of the frequencies, open the menu. See page 19.*

### Picture Advance Speed Selection:



Press **ZOOM** and **AUTO** keys simultaneously to set the picture advance speed. Every pressing changes the on-screen indication as well as the advance speed.

The fractions in the table below correspond to how many transmissions are necessary to construct one scan line.

If the advance rate is set to **0**, the display will remain frozen indefinitely.

Item Indicator	0	1	2	3	4	5	6
Scan Line/ Transmissions	Stop	1/16	1/8	1/4	1/2	1/1	2/1

When selecting an advance speed, keep in mind that a fast advance speed will expand the size of the fish school horizontally on the screen and a slow advance speed will contract it.



## Eliminating Low Intensity Echoes

**SIG LEV**

When you wish to display fish schools above certain level or wish to eliminate a small noise over the entire screen, press **SIG LEV** key. Every pressing eliminates the weakest color echoes on the screen, up to light blue echoes with two (8 color presentation) or five (16 color presentation) key strokes. The echoes eliminated can be identified with the color bar whose color is eliminated in the same order.

## Turning on A-Scope Presentation



To display the A-SCOPE picture, press **SIG LEV** and **ALARM** keys simultaneously. Echoes at each transmission are displayed with amplitudes and colors proportional to their intensities on the right 1/4 of the screen. This will enable close observation of small fish and fish near the bottom.

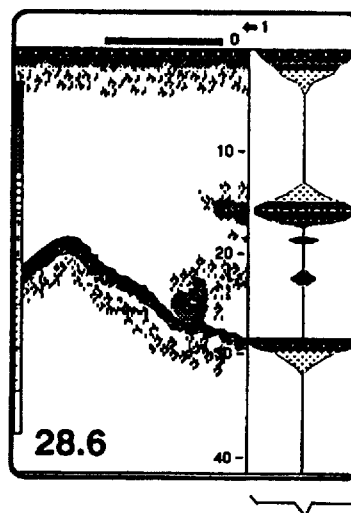

A-Scope Presentation

## Measuring Depth to a Fish School



Move the VRM marker onto a fish school with **MARKER [▲]** [**▼**] keys, and the depth to the fish school is digitally read out at the right-hand side on the marker.

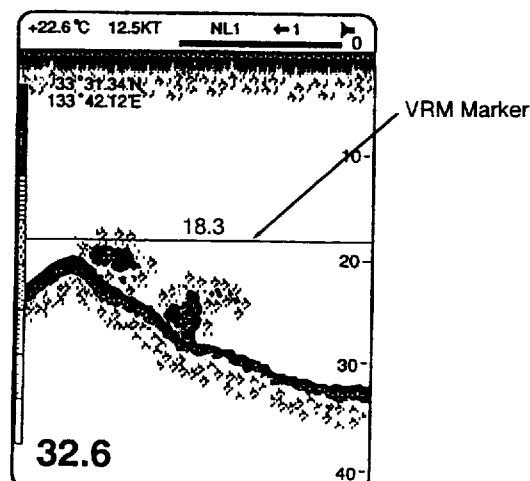

## 6. FISH AND BOTTOM ALARMS

### Fish Alarm

This alarm alerts you when a fish echo is within the preset alarm range. The alarm sounds and the "▶ F" on the upper right of the screen is highlighted while releasing the alarm.

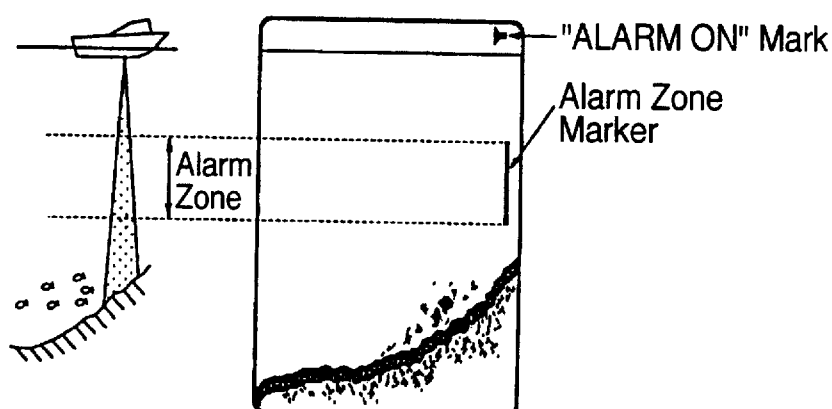

*NOTE: Weak fish echo cannot trigger the alarm. Select proper fish echo level (F/A LEVEL) referring to page 42.*

### Bottom Alarm

This alarm alerts you to the seabed entered into the specified alarm zone. This ALARM ON mark is "▶ B".

*NOTE: To activate the bottom alarm, the seabed depth should be digitally displayed on the left bottom of the screen.*

### Activating/Deactivating Alarm

1. Press **ALARM** key one or two times to turn on the bottom alarm or fish alarm. The alarm ON mark and message appear on the screen.
2. While the alarm message is being displayed, move the alarm zone marker to the desired depth with **MARKER [▲] [▼]** keys.
3. To turn off the alarm, press **ALARM** key.

### Silencing the Aural Alarm

Press any key to silence the aural alarm. The alarm will be released the next time the alarm setting is violated.

## Changing Alarm Zone Marker Width

1. Set **MODE** switch to **MENU**.
2. Select the **ALARM ZONE** item with **MARKER** [▲] [▼] keys and set alarm zone width with **SHIFT** [-] [+] keys.

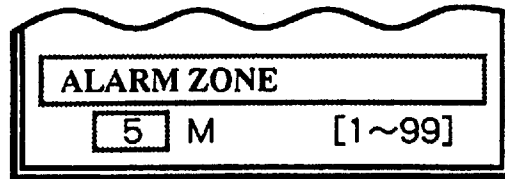

Set width of alarm zone.

3. Set **MODE** switch to the desired mode.

---

## Changing White Bar Position

Any color on the screen can be changed to white by using the procedure below. For example, the seabed can be displayed in white instead of reddish brown.

1. Press [▼] and [▲] at the same time.
  2. Move the white bar by pressing [▼] or [▲].
  3. Press [▼] and [▲] at the same time.
-

# 7. ADJUSTING PICTURE BY MENU

The menu screen appears when the **MODE** switch is set to the **MENU** position. You may set or select the followings that are not frequently altered in daily use if they have been once preset according to your fishing conditions and preferences.

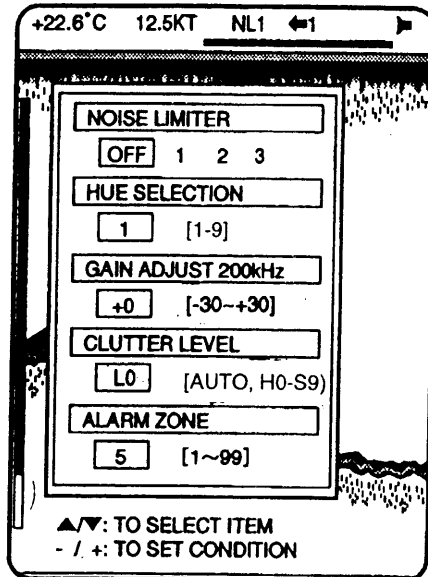

## Eliminating Interference (NOISE LIMITER)

When interference from other acoustic equipment operating nearby or other electric equipment is seen on the screen, use the **NOISE LIMITER** function on the menu screen.

Interference from nearby echo sounder

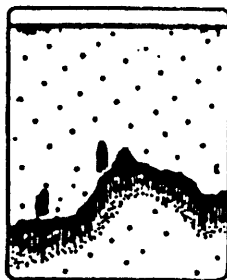

Interference from other electric devices

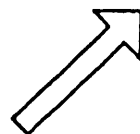
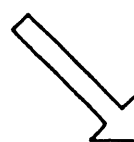
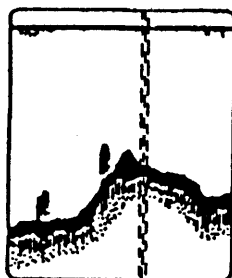

Status of noise limiter

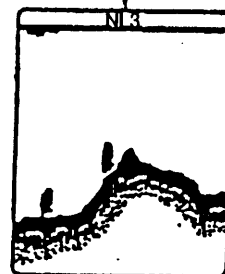

Position 3 offers the highest degree of noise rejection. The status of the noise limiter, NL1, NL2 or NL3, is indicated at the top of the echo sounder picture.

*NOTE: Turn off the noise limiter when no interference exists otherwise weak targets may be missed.*

## Eliminating Low Level Noise (CLUTTER LEVEL)

When blue dots appear on the whole screen mainly due to contaminated water, use the CLUTTER LEVEL function to eliminate them. The CLUTTER LEVEL function can be set on the menu.

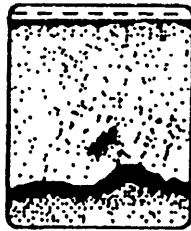

Normally, use the AUTO setting where the clutter rejection level is automatically adjusted considering current clutter level. Use the following settings depending on the circumstances:

**H0-H9:** Use to discriminate individual fish echo from clutter.

**L0-L9:** Use to discriminate small targets (plankton, etc.) from clutter.

**S0-S9:** Use to discriminate large echoes located between the surface layer and mid layer from clutter.

The higher the number the greater the degree of suppression.

## Adjusting Preset Gain

You may adjust the preset gain for individual frequencies when you wish to have a higher or lower gain on either of the two frequencies. Changing the setting on this item by 10 corresponds to changing setting of front panel **GAIN** control by 1.

# Selecting Background Color and Echo Color (HUE SELECTION)

Depending on your preferences, you may select the echo color gradations and the background color as shown below on the menu.

Hue	Hue1	Hue2	Hue3	Hue4	Hue5
No. of colors	16	8	16	8	16
Color bar	RB R O-group Y-group G-group LB-group Deep Blu (bkgnd)	RB R O Y G LB Blu Deep Blu (bkgnd)	RB R-group Y-group G-group W LB-group Deep Blu (bkgnd)	RB R O Y G W LB Deep Blu (bkgnd)	RB R-group Y-group G-group W LB-group Deep Blu (bkgnd)
Hue	Hue6	Hue7	Hue8	Hue9	
No. of colors	8	16	8	8	
Color Bar	RB R O Y G W LB Deep Blu (bkgnd)	RB R-group Y-group O-group G-group LB-group Deep Blu (bkgnd)	RB R Y O Y-G G LB Deep Blu (bkgnd)	Monochrome	

Blk: Black, Blu: Blue, G: Green, LB: Light-Blue, O: Orange, R: Red, RB: Reddish-brown, W: White, Y: Yellow

## Procedure

1. Set **MODE** switch to the **MENU** position.
2. Select the desired item with **MARKER** [▼] / [▲] keys. The selected item is highlighted in yellow.
3. Set the desired parameter with **SHIFT** [-] / [+] keys.
4. Turn **MODE** switch to other position to restore the normal picture.

See page 17 to change "White Bar Position."

# 8. DISPLAYS

## Video Sounder Picture

### HF or LF

\* Position fixing equipment and/or temperature speed sensor is required.

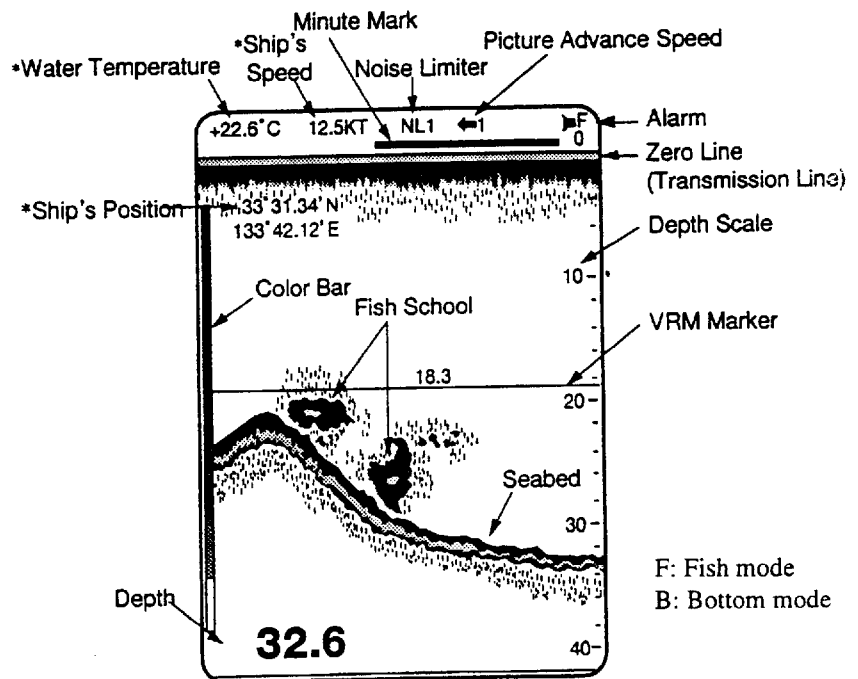

### DUAL

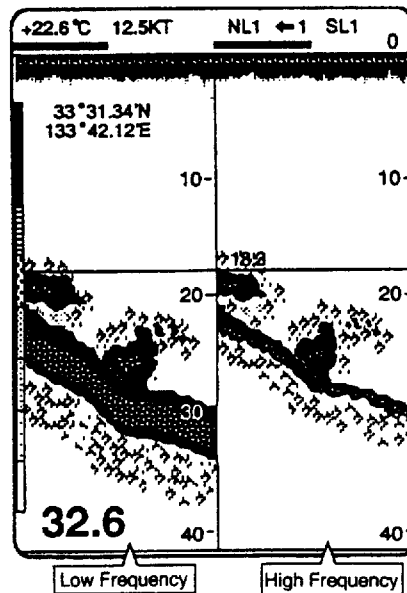

## HF (or LF) + Bottom-Lock Expansion

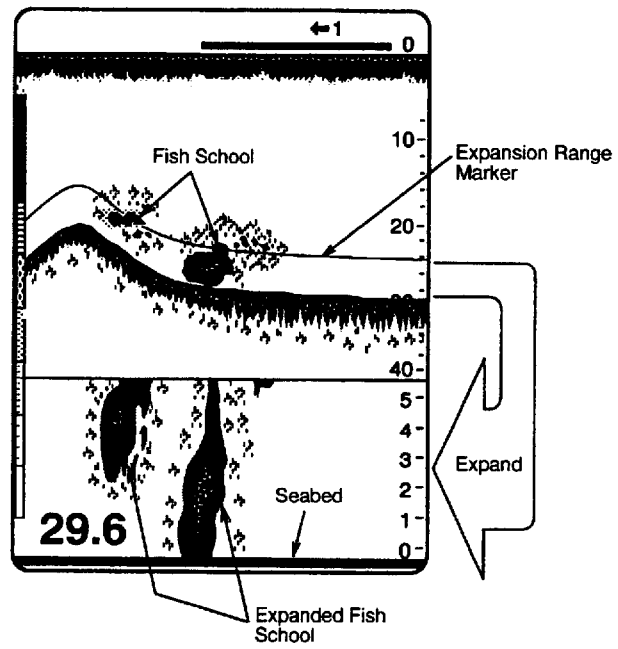

## HF (or LF) + Bottom Zoom

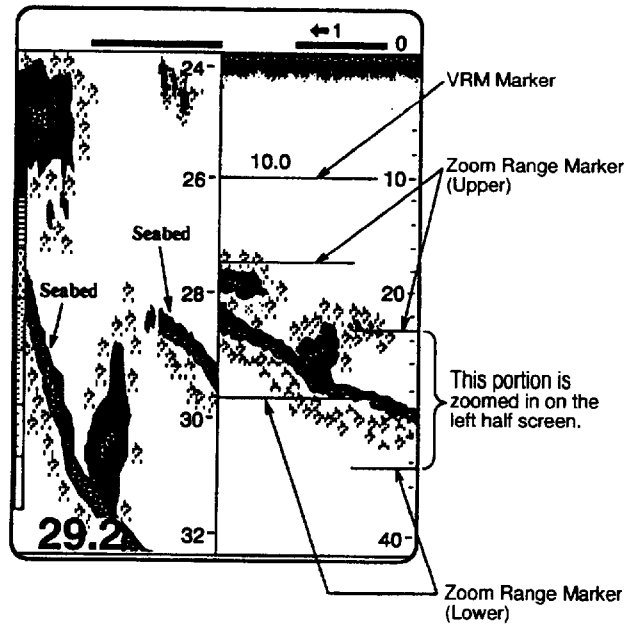



## HF (or LF) + Bottom Discrimination

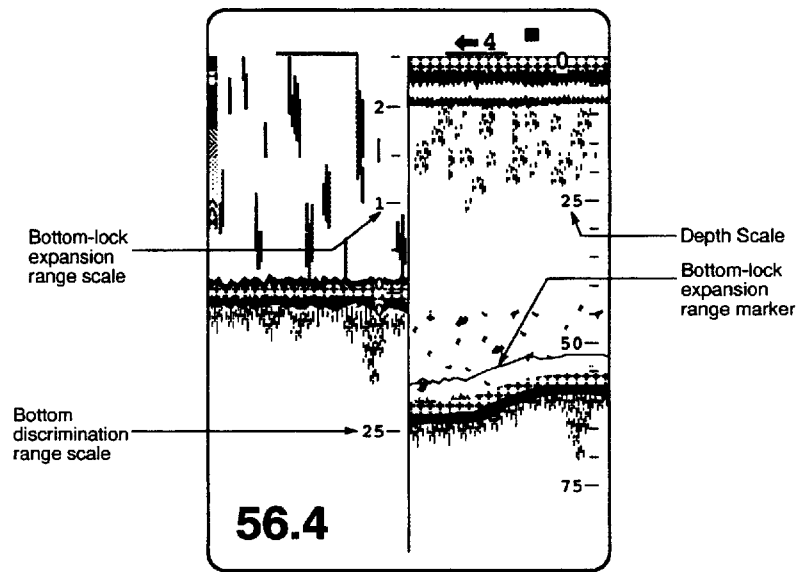

## HF (or LF) + Marker Zoom

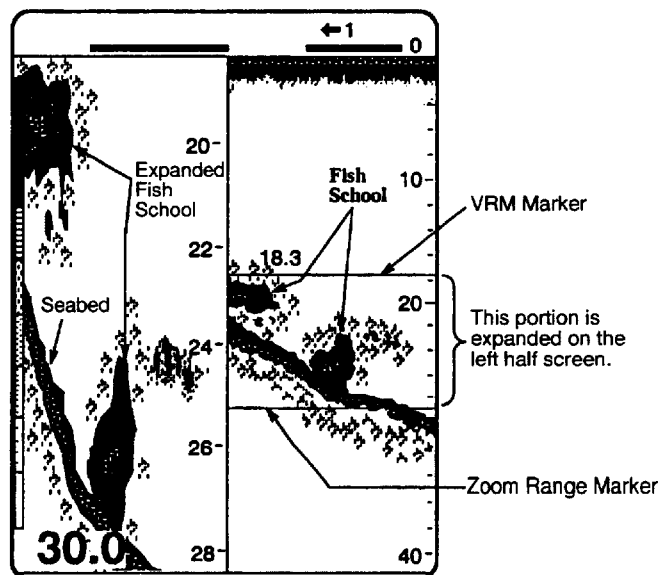

# Navigation Data

## Graph

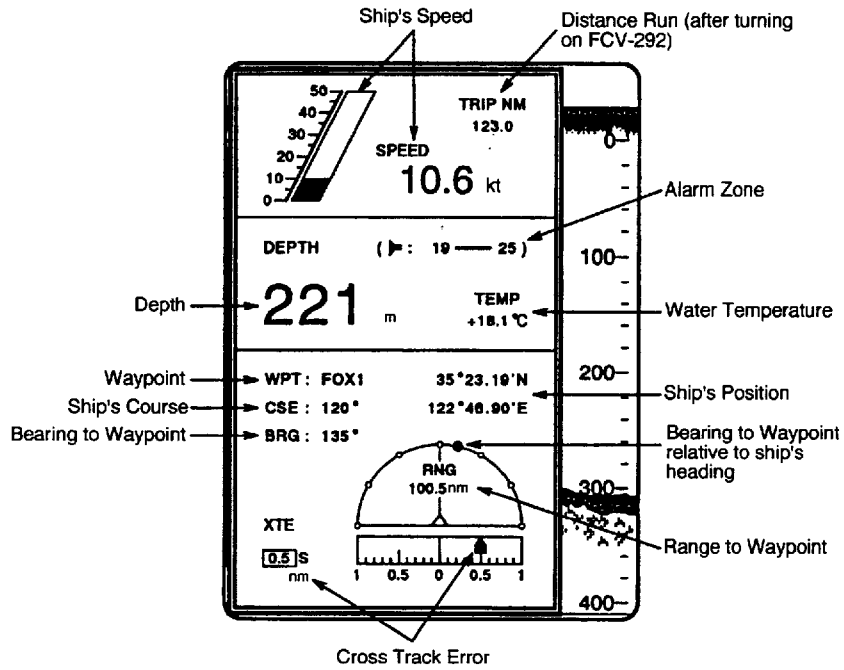

## Digital Display

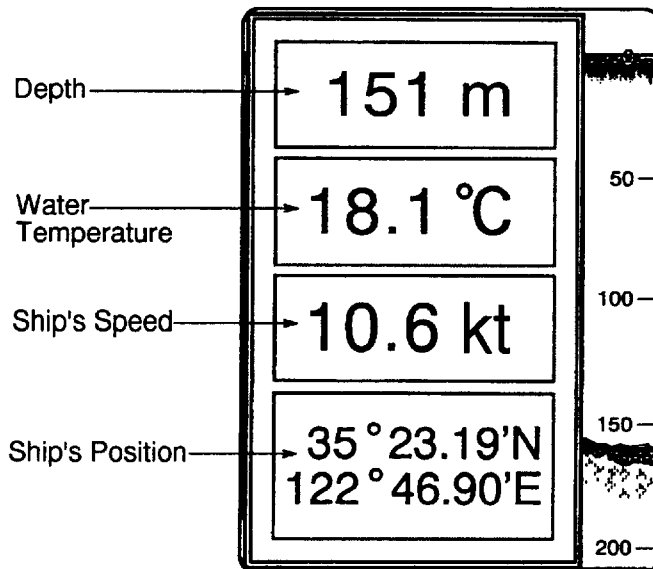

*NOTE: To display data except for depth and alarm zone, the temperature/speed sensor and position fixing equipment should be connected.*

# 9. INTERPRETING THE DISPLAY

---

As mentioned before both fish echoes and bottom contour echoes are composed of a series of vertical scan lines moving right to left across the screen. It is possible for the same object to be recorded on the display with a variety of shapes depending on the distance to the object, the angle at which the object is struck by the transmitted pulse, echo strength, etc.

## Frequency

With the FCV-292, you have two frequencies. There are advantages and disadvantages to both frequencies and you should use the frequency best suited to your needs.

- High frequency is useful to detect species which do not have air bladders or which are very small and do not readily reflect the echo.
- When the sea is rough, noise (reddish color) heavily covers the surface layer, and sounding is easily interrupted by aerated water which passes below the transducer. It should be noted that a high frequency is less influenced by rough sea when compared with a low frequency. However, in the application where observation of DSL (plankton layer) is first essential, use low frequency since such scattering objects are clearly plotted.
- To watch the seabed condition in the bottom trawling, a low frequency is preferable because the seabed is plotted thickly and changes of the width can be easily noticed. A wide seabed trace indicates a hard seabed and a narrow trace, a soft seabed.
- Though a high frequency offers a sharp, clear-cut picture, its use should be limited to shallow water fishing because it is easily attenuated in the water.

## Detecting Area

The detecting area varies depending on the main beamwidth of the transducer, as shown on the next page. Objects out of the main beam but close to the beam will be presented less densely, smaller in size, and at a lower intensity.

Generally, beamwidth depends on transmission frequency; a narrower beamwidth is usually obtained at the higher frequency.

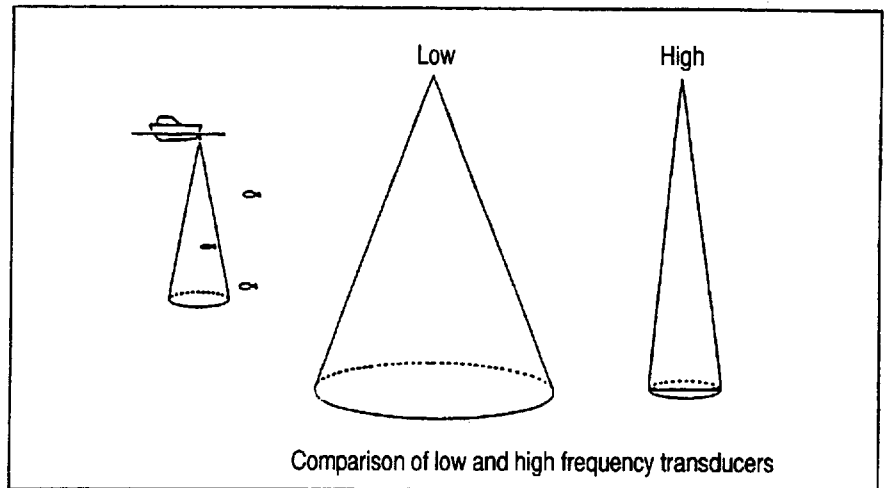

Because the beam width of the high frequency transducer is narrow, the operator has the advantage of higher resolution. In addition, the effects of cruising noise and air bubbles are greatly reduced, since air bubbles resonate at a frequency between 15 and 100 kHz. On the minus side, a narrow beamwidth transducer will display even the smoothest bottom contour in a sawtooth pattern if the boat is moving up and down due to pitching and rolling of the boat.

Because of the limited coverage area, a narrow beamwidth tends to overlook catchable fish at the sides of the boat.

## Zero Line

The zero line (sometimes referred to as the transmission line) represents the transducer's position, and moves off the screen when a deep phased range is used.

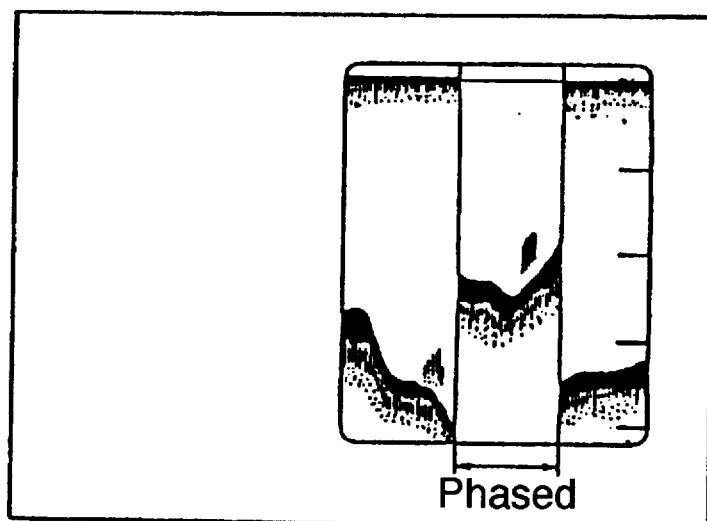

## Fish School Echoes

Fish school echoes will generally be plotted between the zero line and the bottom. Usually the fish school/fish echo is weaker than bottom echo because the reflection property is much smaller than compared to the bottom. The size of the fish school can be ascertained from the density of the display.

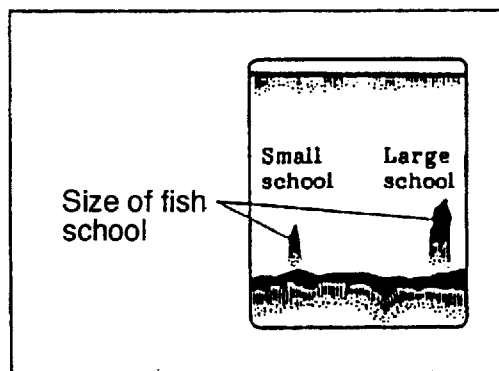

## Bottom Echo

Echoes from the bottom are normally the strongest and are displayed in the reddish brown color but the color and width will vary with bottom composition, water depth, frequency, sensitivity, etc.

In a comparatively shallow depth, a high gain setting and strong bottom echo will cause a second or sometimes a third or a fourth echo to be displayed at the same interval between them below the first echo trace. This is because the echo travels between the bottom and the surface twice or more in shallow depths.

The color of the bottom echo can be used to help determine the density of the bottom materials (soft or hard). The harder the bottom, the wider the trace. If the gain is set to show only a single bottom echo on mud, rocky bottom will show a second or third bottom return. The Basic Range chosen should be set to show the first and second bottom echoes when bottom hardness is being determined.

In rough waters, the bottom is recorded in a zig-zag pattern, similar to the teeth of a saw. This is caused by the heavy pitching and rolling of the boat causing the sounding direction to fluctuate and the distance to the bottom to vary.

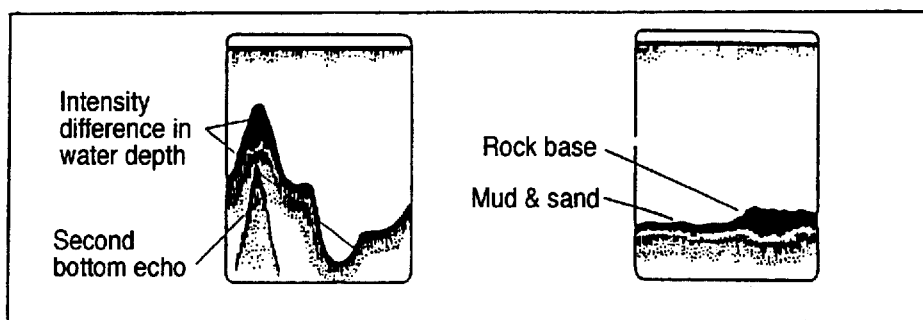

## Surface Noise/Aeration

When the waters are rough or the boat passes over a wake, surface noise may appear near the zero line. As surface turbulence is acoustically equivalent to running into a brick wall, the bottom echo will be displayed intermittently. Similar noise sometimes appears when a water temperature difference (thermocline) exists. Different species of fish tend to prefer different temperature zone, so thermocline information may be useful to help identify target fish. 200 kHz tends to show shallow thermoclines better than 50 kHz.

In rough waters the display is occasionally interrupted due to below-the-ship air bubbles obstructing the sound path. This also occurs when the boat makes a quick turn or reverses movement. However, reconsideration of the transducer installation may be necessary if the interruption occurs frequently in good weather conditions.

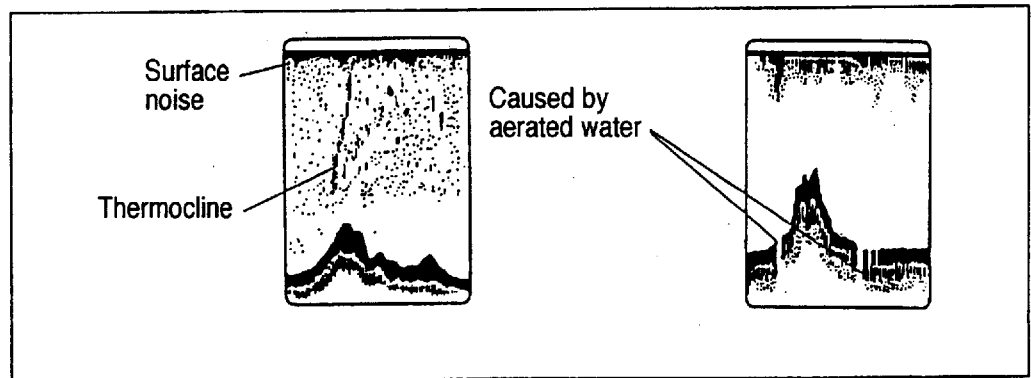

# 10. MAINTENANCE

The equipment will maintain optimum performance for a long period. However, continued performance cannot be expected without periodic inspection and maintenance. Important hints to be checked from time to time are tabulated below.

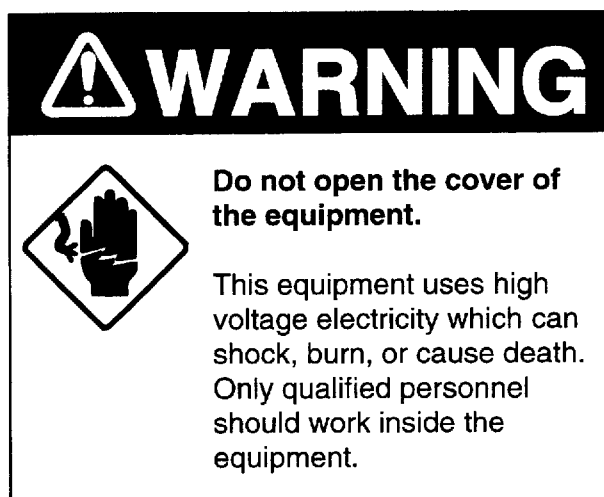

Check Item	Action
Cable run	If conductors are exposed, replace cable.
Power cable plug/ transducer cable plug	If loosened, secure it firmly.
Display unit grounding	If corroded, clean it.
Ship's mains voltage (10.5 to 20.0 VDC or 18.0 to 40.0 VDC)	If out of ratings, correct problem.

## Fuse Replacement

To protect the equipment from serious damage, a fuse is provided on the power cable, as illustrated. The fuse protects against overvoltage/reverse polarity of the ship's mains or internal fault of the equipment. If the fuse has blown, first find the cause of the problem before replacing it with a new one. A fuse rated for more than 5A (12 Vdc ship's mains) or 3A (24/32 Vdc ship's mains) should not be used, since it may cause serious damage to the equipment.



## CAUTION

### Use the correct fuse.

Use of the wrong fuse can cause fire or equipment damage.

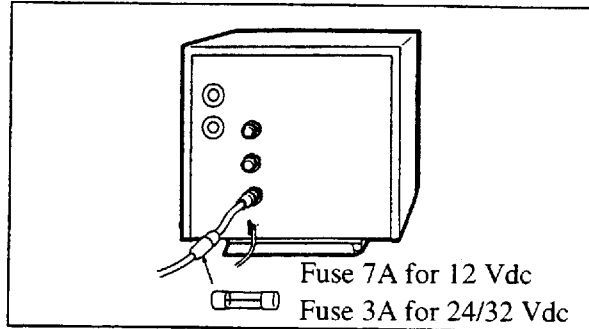

## Cleaning

Keep the equipment clean and dry at all times. Dust or dirt should be wiped off with a soft, dry cloth. To remove heavy dirt, use mild detergent and water on a cotton tipped swab or soft cloth.

## CAUTION

*Never apply plastic solvent, such as thinner or acetone, for cleaning and lubrication. It may dissolve paint coating/markings on the front panel.*

## Maintenance of the Transducer

Underwater growth on the transducer face will result in a gradual decrease in the sensitivity. Check the transducer face each time the boat is dry-docked. If any barnacles or seaweed growth is found, remove them very carefully with a piece of wood or sandpaper, taking care not to damage the transducer face.



# 11. TROUBLESHOOTING

---

If something appears wrong with your unit, check the equipment referring to the **Basic Troubleshooting** and **Diagnostic Self-check**. In case the trouble isn't found after performing these checks, and the unit still appears faulty, call your electronics technician for service.

## Basic Troubleshooting

Note that the number listed on each possible cause corresponds to that of the illustration on the next page.

### Neither echo nor fixed range scale

- \* Is the battery dead? ----- 1
- \* Is the fuse blown? ----- 2
  - Supply voltage is normal?
  - Corrosion on battery terminal? ----- 1
- \* Poor contact of power cable? ----- 1

### No echo but fixed range scale shows

- \* Is the picture advance rate set to **0** (Stop)? ----- 3
- \* Transducer plug is loose? ----- 4

### Echo appears but no zero line

- \* Is the range shifting operative? ----- 5

### Low sensitivity

- \* Is the gain setting too low? ----- 6
- \* Air bubbles or underwater growth (barnacle, seaweed, etc.) attached to the transducer face? ----- 7
- \* Highly sedimented water? ----- 8
- \* Soft bottom? ----- 9

### No water depth readout

- \* Bottom is not displayed on the screen? ----- 10

### Heavy noise or interference

- \* Is the transducer/cable located too near the engine? ----- 11
- \* Is the unit grounded? ----- 12
- \* Are other echosounders of the same frequency operating nearby? ----- 13

**No or unrealistic speed/temperature indication**

\* Sensor plug is loose?----- 14

**No or unrealistic ship's position indication**

\* Plug for the position fixing equipment is loose? ----- 15

\* The position fixing equipment itself  
is operating normally? ----- 16

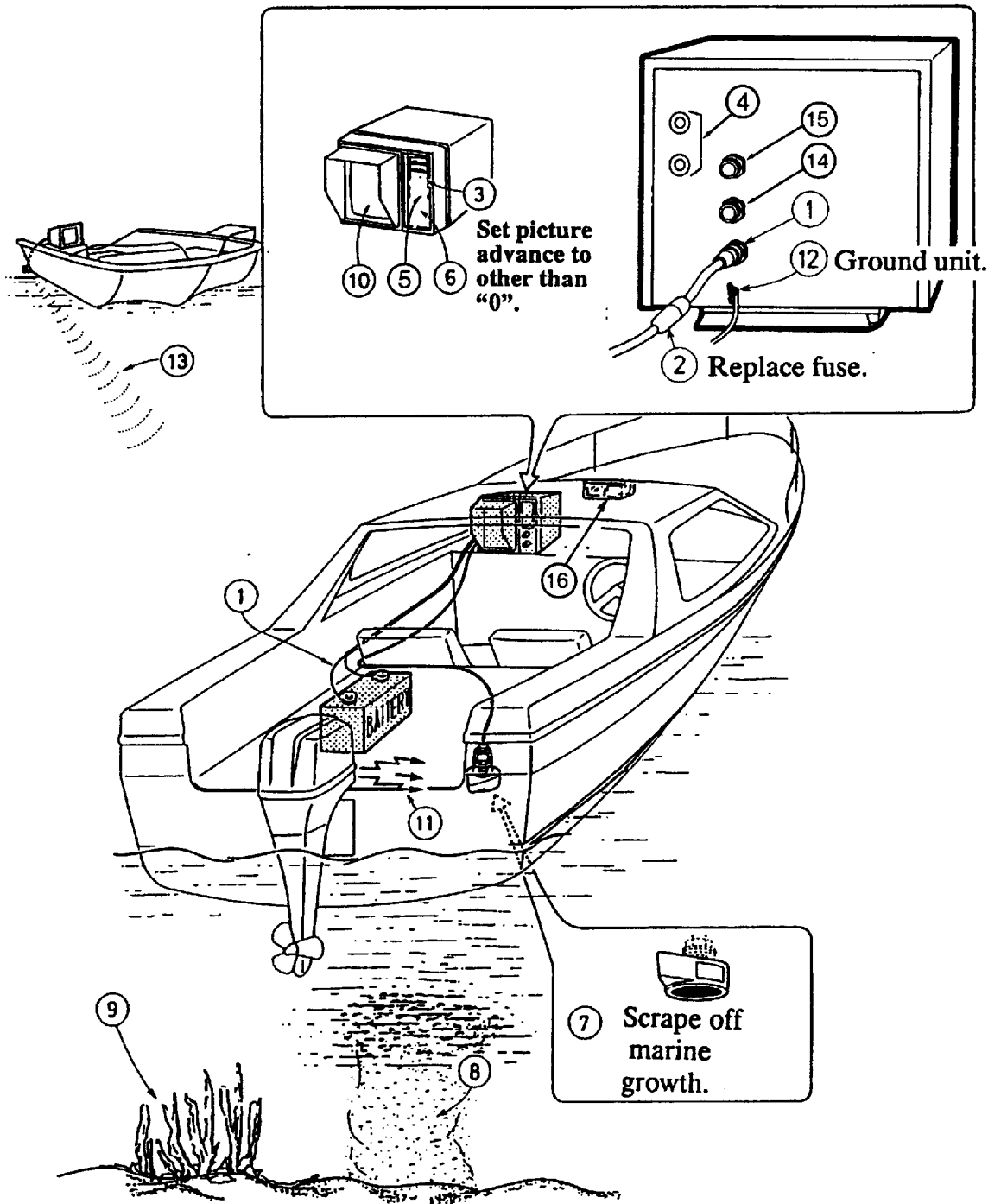

- ⑪ Try to mount a large electrolytic capacitor right at the output terminals of the alternator as close as possible. The capacitor must be rated for the nominal output voltage of the alternator, plus a 50% safety factor and capacity should be about 10,000 microfarads or so. The positive lead of the capacitor is connected to the output terminal of the alternator in parallel with the heavy lead going to the battery bank. The negative terminal of the capacitor should go to a mounting bolt used to secure the alternator to its mounting frame. Be careful to observe polarity of the capacitor. Reverse polarity will destroy the capacitor, and could damage the charging system as well.

*NOTE: Do not connect the capacitor to the field terminal of the alternator, as it may damage the alternator itself.*

## Diagnostic Self-Check

### Introduction

The FCV-292 incorporates diagnostic self-check facilities, enabling to find a faulty pc board. If no trouble is found through the basic troubleshooting, perform the following self-checks.

### Procedure

1. Turn the unit on while pressing one of the keys.
2. Press **SHIFT [-]** key. The self-check screen is displayed and the check results will appear in a few seconds.

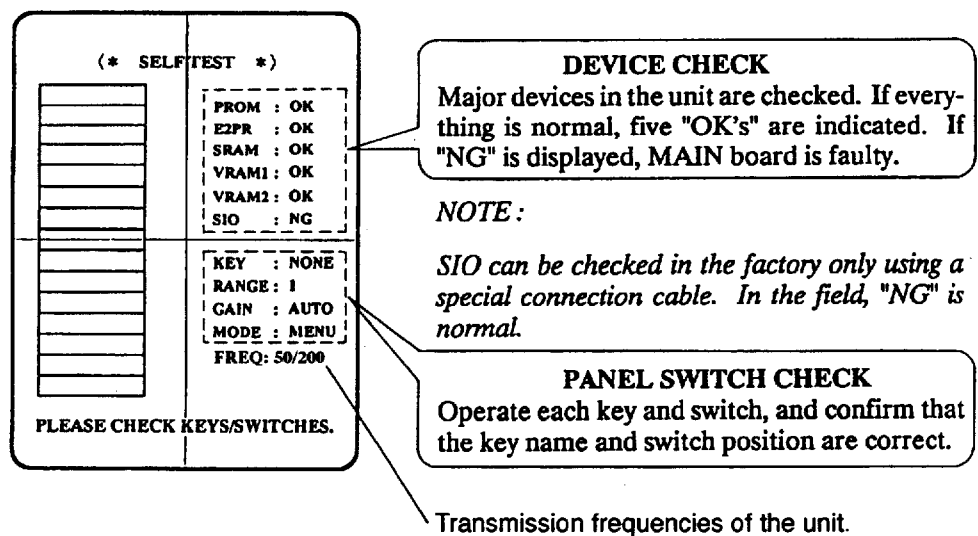

3. To terminate the self-check, turn the unit off.

## **Transducer Check**

A simple and reliable check of the transducer is to temporarily substitute a new transducer instead of the existing one to the display unit. If the picture sensitivity is considerably improved through this change, the transducer is considered to be faulty. This method is especially useful for through-hull installation.

## **Speed/temperature Sensor (Option) Check**

The idea of transducer check can apply to this case, too; temporarily substitute a new sensor instead of the existing one to the display unit. If the speed/temperature indications become normal through this exchange, the sensor is considered to be faulty.

Unless a new sensor is available, try the following checks.

First, unplug the sensor connector from the display rear panel. If the speed is indicated "00" and the temperature indicate nothing, the display unit will be all right.

Next, turn the water wheel with a finger. If the sensor is normal, the speed indication will be 2 to 3 knots when the wheel is turned at a normal speed and will be 7 to 8 knots when turned more quickly. As for the temperature, the reading should change when you touch the thermosensor.

# 12. INSTALLATION

## Display Unit Installation

The display unit permits a table-top or overhead mounting. It has been assembled for the table-top mounting at the factory but you may easily reassemble it for the overhead mounting at installation.

### Mounting Procedure (Table-top Mounting)

1. Detach the mounting cradle by unscrewing two bolts (M8x40) on the lower front of the display unit.
2. Drill four  $\phi 11$  mm bolt holes on the table referring to the fixing holes on the mounting cradle.
3. Fix the mounting cradle onto the table with bolts, washers and nuts.
4. Put the display unit on the mounting cradle and fix it with bolts (M8x40).
5. Put on caps (supplied as an accessory) on the bolt head to conceal the bolts.

*NOTE:  $\phi 9$  mm self-tapping screws can be used instead of M10 bolts to fix the mounting cradle.*

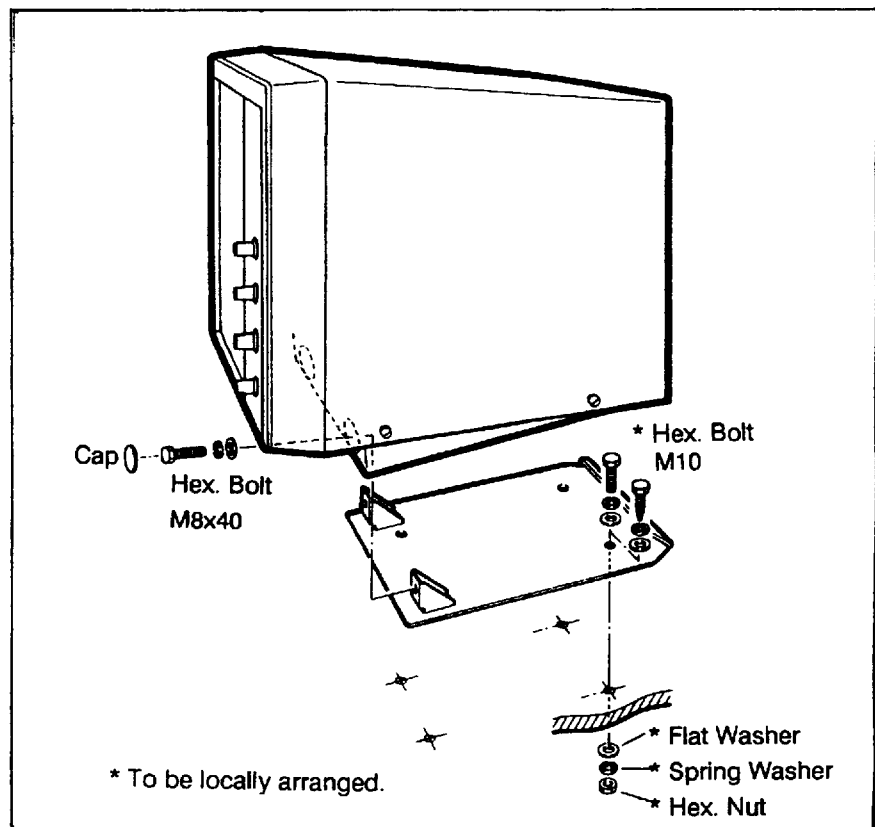

## Overhead Mounting

1. Remove display unit top cover by unscrewing eight screws.
2. Detach the mounting cradle by unscrewing two bolts (M8x40) on the lower front of the unit.
3. Dismount the ramp base by unscrewing four bolts (M6x16) on the bottom of the unit.
4. Put the ramp base on top of the unit and fix it with four bolts (M6x16).
5. Put back the display unit top cover.

*NOTE: Do not use self-tapping screws to fix the mounting cradle. Use bolts and nuts.*

*2. Display unit weighs 11 kg. Reinforce the ceiling.*

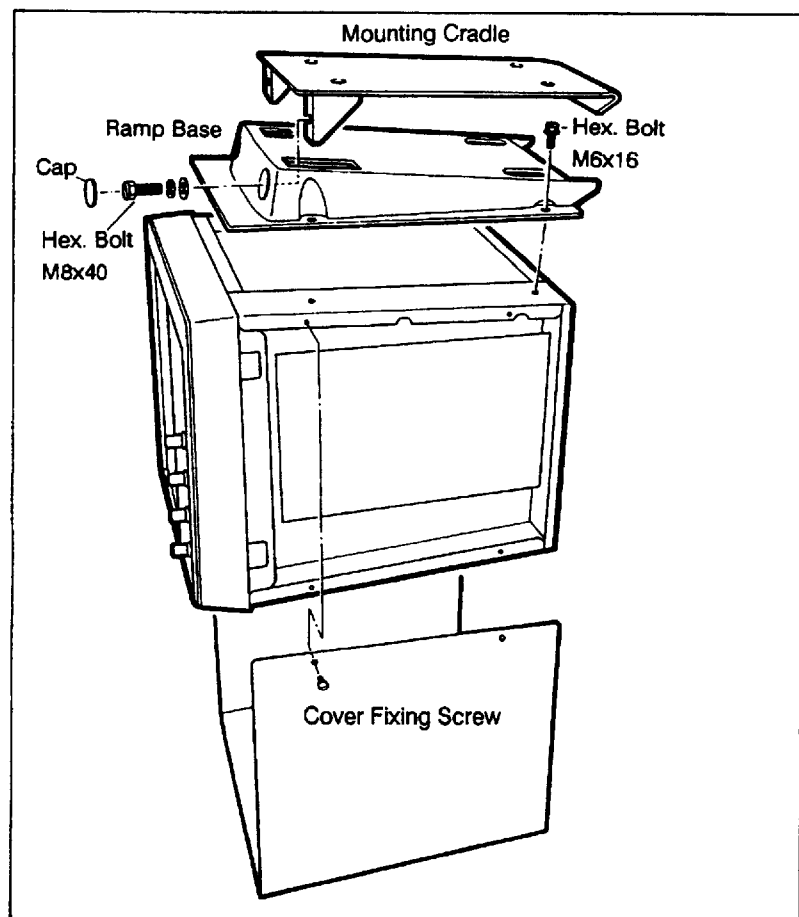

# Transducer Installation

## Location

The performance of the video sounder is directly related to the mounting location of the transducer, especially for high-speed cruising. The installation should be planned in advance, keeping a length of transducer cable and the following factors in mind.

- Air bubbles and turbulence caused by movement of the boat seriously degrade the sounding capability of the transducer. The transducer should, therefore, be located in a position where water flow is the smoothest. Noise from the propellers also adversely affects performance and the transducer should not be mounted nearby. The lifting strakes are notorious for creating acoustic noise.
- The transducer must always remain submerged, even when the boat is rolling, pitching or up on a plane at high speed.
- For displacement hulls, a practical choice would be somewhere between 1/3 and 1/2 of the boat's length from the stern. For planing hulls, a practical location is generally rather far astern, so that the transducer is always in the water regardless of the planing attitude.

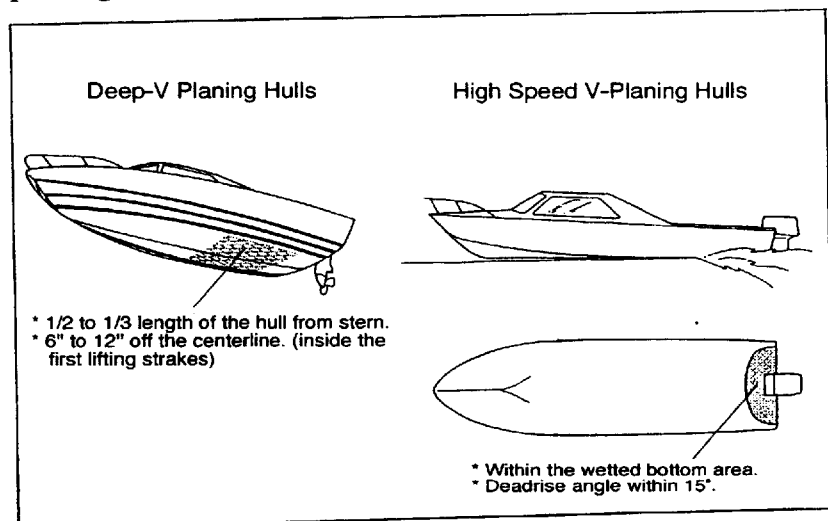

## Transducer Preparation and Painting

Just prior to putting your boat into the water, the face of the transducer should be thoroughly wiped with a detergent liquid soap. This will lessen the time necessary for the transducer to establish good contact with the water. Eliminating this will lengthen the time required for complete saturation and will reduce the performance of the unit.

To maintain the sensitivity of the transducer, do not coat the face with heavy pigmented antifouling paints, i.e., cuprous oxide types. Use only a light, thin coat of a vinyl based antifouling paint, like International Paint's TRI-LUX No.67 or No.68.

# Speed/ Temperature Sensor

## Thru-Hull Mount Temperature Sensor (T-02MSB)

### Mounting Location

- Select a mid-boat flat position. The sensor does not have to be installed perfectly perpendicular. The sensor must not be damaged in dry-docking operation.
- Select a place apart from equipment generating heat.
- Select a place in forward direction viewing from the drain hole for cooling water.
- Select a place free from vibration.

### Mounting Procedure

- 1) Dry-dock the boat.
- 2) Make a hole of approx. 21mm dia. on the hull bottom.
- 3) Run the sensor cable through the hole.
- 4) Apply high grade sealant to the flange of the sensor.
- 5) Pass the cable through the rubber packing, washer and the locknut as shown below.
- 6) Tighten the locknut. Do not tighten the nut excessively. (59N. m max.)
- 7) After launching, check for water leakage around the sensor.

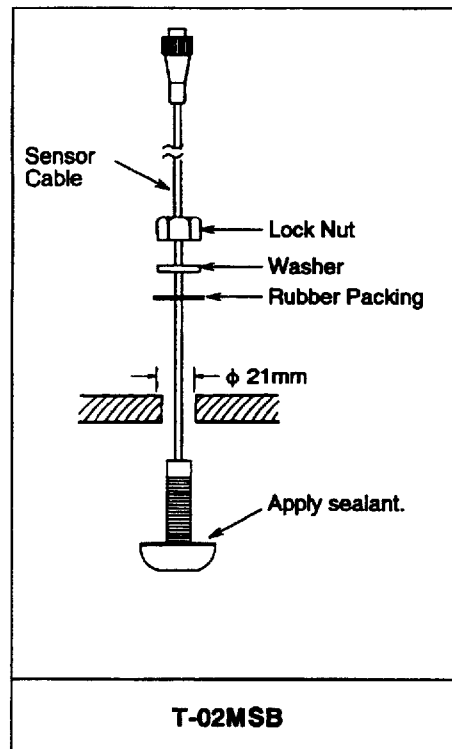

## Through-Hull Mount Speed/ Temperature Sensor (ST-01MSB)

Refer to the installation manual attached to the sensor.



# Cable Connections

Cable connections to the FCV-292 display unit are made at the connectors located at the rear of the unit. The figure below shows the wiring instructions.

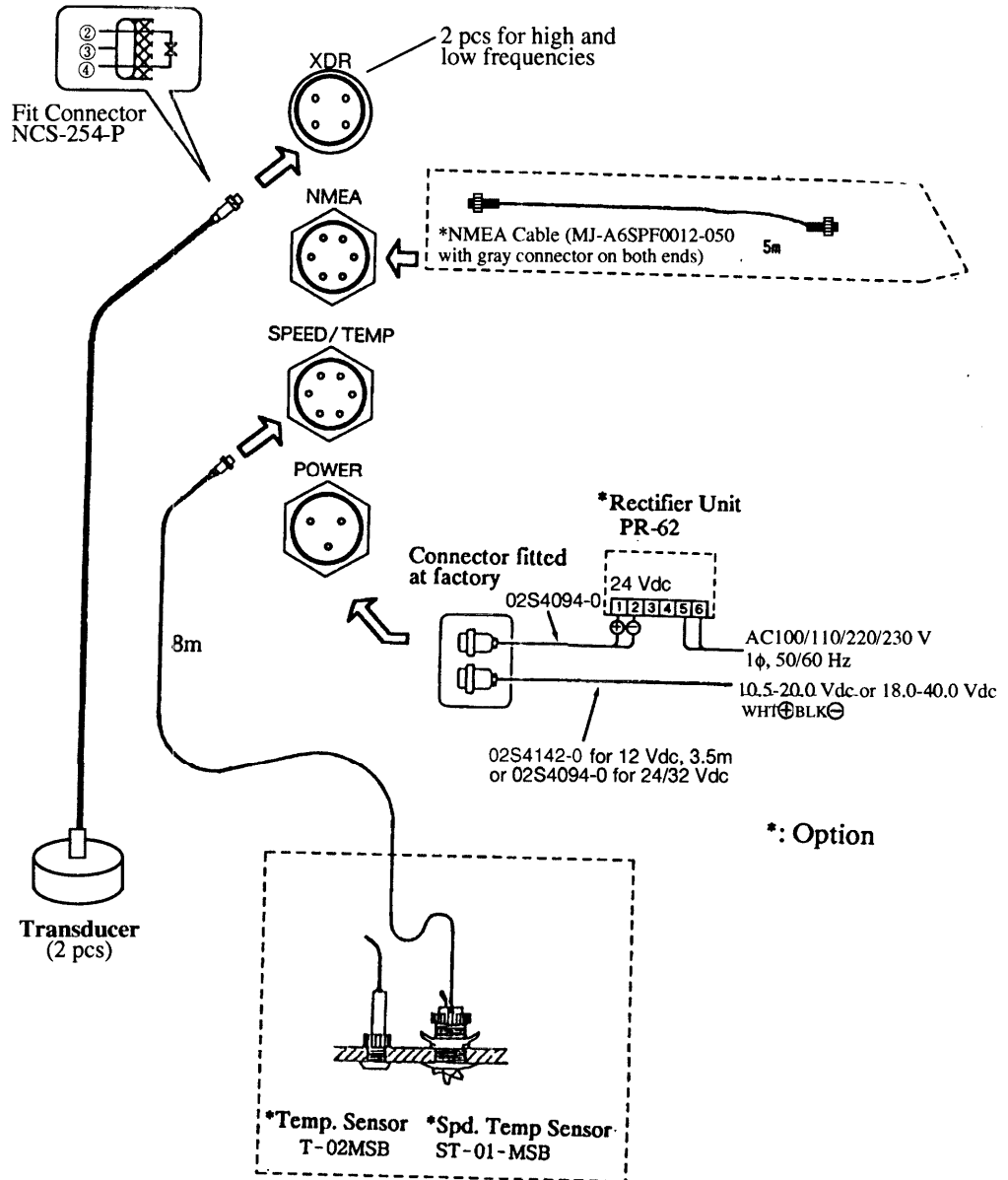

## Transducer Cable Connection

In order to minimize the chance of picking up electrical interference, avoid where possible routing the transducer cable near other on-board electrical equipment. Also avoid running the cable in parallel with power cables.

## Power Cable Connection

The FCV-292 is designed to operate normally at a voltage of 10.5 to 20.0 Vdc or 18.0 to 40.0 Vdc. The power should be directly taken from the distribution board or breaker panel.

Connect the white lead of the cable to the positive (+) terminal of the battery and the black lead to the negative (-) terminal.

### **CAUTION**

Reversing the polarity will result in blowing the fuse and may very well damage internal components

## Connection to Position Fixing Equipment

To connect the FCV-292 with the position fixing equipment, the NMEA cable assembly (type MJ-A6SPF0012-050, code no. 000-134-424) is optionally required.

The FCV-292 can accept Furuno CIF or NMEA #0183 versions 1.5 and 2.0 format data. Refer to page 47 for the NMEA sentences which are accepted by the FCV-292. Set the system menu [2], according to the data format. See page 43.

## Grounding

The FCV-292 is designed to operate normally without grounding the display unit, provided that the cable routing precautions stated before are taken. However in some cases, interference may show up at high gain settings, and it may become necessary to ground the unit to the boat's grounding bus to eliminate the problem. In such cases, run a heavy duty ground wire from the grounding terminal on the rear bottom of the display unit to the nearest grounding point on the boat.

On a fiberglass boat, it is best to install a ground plate that measures about 20 cm by 30 cm (0.8 feet by 1.0 feet) on the outside of the hull bottom to provide a ground point. If this is not practical, the engine block can be used.

# 13. SYSTEM MENU SETTING

Three system menus are provided to allow custom tailoring of the unit to specific uses, such as user's preference, combined navigation equipment, etc.

## Operation Procedure

1. Turn on the unit while pressing one of the key switches.
2. Press **SHIFT** [**+**] key to display a system menu.

(\* SYSTEM MENU [1] \*)

MENU SELECT : [1] [2] [3]

DEPTH UNIT : m ft fa PB

SPEED UNIT : kt MPH KPH

TEMP UNIT : °C °F

TX OUTPUT : MAX MIN

ZOOM MARKER : OFF ON

F/A : WEAK MED STRG

PULSE : AUTO [AUTO, 0.1 ~ 3.6]

NAV MODE : GRPH DATA

BEARING : TRUE MAG

▲/▼ : TO SELECT ITEM  
-/+ : TO SET CONDITION

(\* SYSTEM MENU [2] \*)

MENU SELECT : [1] [2] [3]

NAV DATA DSP : OFF L/L R/B CSE

DATA FORMAT : NMEA CIF

SPD SENS SEL : OFF OWN NMEA

TMP SENS SEL : OFF OWN NMEA

SPD SENS ADJ : +0 % [-50~+50]

TMP SENS ADJ : +0.0 °F [-20~+20]

(ADJUSTABLE ONLY OWN SENSOR)

OWN SENSOR SPEED      OWN SENSOR TEMPERATURE

0.0 KT      10.0 °F

▲/▼ : TO SELECT ITEM  
-/+ : TO SET CONDITION

(\* SYSTEM MENU [3] \*)

MENU SELECT : [1] [2] [3]

BASIC RANGE 1 : 15 (15 to 9000)

RANGE 2 : 30

RANGE 3 : 60

RANGE 4 : 120

RANGE 5 : 200

RANGE 6 : 400

RANGE 7 : 1000

RANGE 8 : 1500

ZOOM RANGE : 60 (30~250)

B/L RANGE : 6 10 20

▲/▼ : TO SELECT ITEM  
-/+ : TO SET CONDITION

3. To display another system menu, change selection on MENU SELECT item with **SHIFT** [**-**] [**+**] keys.
4. To change settings, select the desired item with **MARKER** [**▲**] [**▼**] keys and set the desired parameter with **SHIFT** [**-**] [**+**] keys.
5. To return to the normal display, turn the unit off and on.

# Description of System Menu Item

## System Menu [1]

\*: Factory setting

ITEM	PARAMETER	FUNCTION
DEPTH UNIT	m *ft fa PB	Select unit of depth readout.
SPEED UNIT	*kt MPH KPH	Select unit of speed readout.
TEMP UNIT	° C *° F	Select unit of temperature readout.
TX OUTPUT	*MAX MIN	Select transmission output power.
ZOOM MARKER	OFF *ON	Turn on/off zoom range and expansion range markers.
F/A LEVEL	WEAK *MED STRONG	Select echo strength which triggers fish alarm.
PULSE	*AUTO, 1.0-3.6 μs	Select pulselength.
NAV MODE	*GRPH DATA	Select display mode of navigation data.
BEARING	*TRUE MAG	Select bearing mode, True or Magnetic.

*NOTE: If DEPTH UNIT is changed, all basic range settings on system menu [3] are reset to default settings (factory settings).*

## System Menu [2]

\*: Factory setting

ITEM	PARAMETER	FUNCTION
NAV DATA DSP	OFF	Select digital data to be displayed on top left of the screen.
	*L/L	: Ship's position in latitude/longitude
	R/B	: Range and bearing to waypoint
	CSE	: Ship's course
DATA FORMAT	*NMEA	Select communication data format with external device.
	CIF	: Standard data format of Furuno equipment.
SPD SENS SEL	OFF	Select speed data source.
	*OWN	: For optional speed sensor.
	NMEA	: For external data input.
	(CIF)	
TEMP SENS SEL	OFF	Select temperature data source.
	*OWN	: For optional temperature sensor.
	NMEA	: For external data input.
	(CIF)	
SPD SENS ADJ	*0%(-50 to +50)	Speed correction for optional speed sensor.
<i>Note that speed data fed from external device can not be corrected.</i>		
TMP SENS ADJ	*0°(-20 to +20)	Temperature correction for optional water temperature sensor.
<i>Note that temperature data fed from external device can not be corrected.</i>		

## System Menu [3]

\*: Factory setting

ITEM	PARAMETER	FUNCTION
BASIC RANGE	5 to 4000 m	Set basic ranges when factory-set range shown on page 13 are undesirable.
	15 to 9000 ft	
	3 to 2000 fa	
	3 to 200 PB	
<i>NOTE: Ranges should be set in order from shallow to deep ranges: range 1 shallowest, range 8 deepest.</i>		
ZOOM RANGE	*60, 30-250	Sets range for zoom displays.
B/L RANGE	2 m (5 ft, 1 fa 1 PB)	Select range for bottom lock
	5 m (10 ft, 2 fa, 2 pB)	
	*10 m (20 ft, 5 fa, 5 PB)	

## Restoring Factory Settings

When you wish to restore all factory settings on the front panel keys and the menus:

1. Turn on the unit while pressing one of the keys. The option mode window will be displayed.
2. Press **MARKER [▲]** key, and the settings on the keys and the menus are reset to factory settings.

# 14. SPECIFICATIONS

1. Display 10" diagonal CRT
2. Echo Color 8 or 16 colors depending on echo intensity. Monochrome presentation is also available. The background color is selectable from blue, light blue and black.

## 3. Basic Range

Range No.	1	2	3	4	5	6	7	8
Meters	5	10	20	40	80	150	300	500
Feet	15	30	60	120	200	400	1000	1500
Fathoms	3	5	10	20	40	80	150	250
Passi/Braza	3	5	10	30	50	100	200	300

The basic ranges are user-reprogrammable.

4. Range Shift Display start depth can be shifted in 1, 10 or 100 m (ft, fa, PB) steps up to 4000 m (9000 ft, 2000 fa, 2000 PB).
5. Zoom Range 30-250 ft, 10-200 m, 1-100 fa, 1-200 PB

## 6. Bottom Lock Expansion Range

Meters	Feet	Fathoms	Passi/Braza
2	5	1	1
5	10	2	2
10	20	5	5

7. Auto Mode Automatically changes depth range and sensitivity depending on the depth of the water and echo intensity.

## 8. Presentation Mode

HF	High Frequency
LF	Low Frequency

DUAL	High Frequency + Low Frequency (1/2 + 1/2)
ZOOM	High or Low Frequency + Zoom (1/2 + 1/2)
NAV	Graphical and digital displays of water depth, water temperature, ship's speed, L/L data, etc.

\* A-scope presentation is also available.

9. Zoom Display

Marker Zoom  
 Bottom Zoom  
 Bottom-lock Expansion  
 Bottom Discrimination

10. Picture Advance

Speed Setting	0	1	2	3	4	5	6
Lines/TX	Stop	1/16	1/8	1/4	1/2	1/1	2/1

11. TX Frequency/ Output Power

Two frequencies (28/50, 28/68, 28/88, 28/200, 50/68, 50/200, 68/88, 68/200, 88/200, 38/50, 38/200 kHz) alternately transmitted), 1 kWrms.

12. Pulselength, Tx Rate      0.1 - 3.6 ms, Max. 740/minute

13. Interference Rejector      Rejects unwanted signals by comparing last and present echoes in strength.

14. Alarm      Alarm sounds when fish or bottom echo comes into the alarm zone.



## 15. Input/Output Data (NMEA #0183 versions 1.5/2.0 or Furuno CIF Format)

### NMEA #0183 Format Input/Output Sentence

Input	RMB, BWC, RMC, RMA, GLL, VTG, VHW, MTW, XTE
Output	SDDBT, SDDPT (depth), YCMTW* (water temperature), VWVHW* (ship's speed)

### Furuno CIF Format Input Output Data

Input	L/L, Ship's Speed, Course, Waypoint ID, Range to Waypoint, Waypoint Bearing, Water Temperature
Output	Depth, Water Temperature*, Ship's Speed

\* When speed/temperature sensor is connected.

## 16. Environmental Condition

Temperature: 0 - 50 °C

Relative Humidity: Less than 85% (Splashproof structure)

## 17. Power Supply

10.5 Vdc to 20, or 18 to 40 Vdc

4.5 A to 2.4, or 2.7 to 1.3 A, approx. 52W.

## Complete Set

No.	Name	Type	Code No.	Qty	Remarks
1	Display Unit	CV-292		1	
2	Transducer			2	See Transducer & Hull Bottom Installation Materials list, page 49.
3	Installation Materials	CP02-05800 CP02-05810	002-270-430 002-271-310	1 set	For 12 Vdc mains For 24/32 Vdc mains
4	Accessories	FP03-04310	000-084-715	1 set	
5	Spare Parts	SP02-03700 SP02-03400	000-012-368 000-014-889	1 set	For 12 Vdc mains For 24/32 Vdc mains
6	Documents	Operator's Manual		1	

## Installation Materials

No.	Name	Type	Code No.	Qty	Remarks
1	Power Cable Assembly	02S4142-0*3.5 m*	000-140-624	1	For 12 Vdc
		02S4094-0*3.5m*	000-135-397		For 24/32 Vdc
2	Vinyl Wire	KIV 2.0sq, 2 m	000-554-516	1	For grounding
3	Connector	NCS-254-P	000-506-505	2	For transducers

## Accessories

No.	Name	Type	Code No.	Qty	Remarks
1	Cap	FP03-04310	008-411-810	2	For concealing bolt heads on mounting cradle

## Spare Parts

No.	Name	Type	Code No.	Qty	Remarks
1	Fuse	FGBO 7A	000-549-013	3	For 12 Vdc
		FGBO-A 3A	000-549-063	3	For 24/32 Vdc

## Option

No.	Name	Type	Code No.	Remarks
1	Speed/Temperature	ST-01MSB	000-019-505	Thru-hull, Bronze
2	Temperature Sensor	T-02MSB	000-040-044	Thru-hull, Bronze
3	EMI Filter	FP02-03900	001-390-010	To reduce radio interference
4	NMEA Cable	MJ-A6SPF0012-050	000-134-424	For external data input
5	Rectifier	PR-62,100VAC	000-013-484	24 Vdc output for AC mains
		PR-62,110VAC	000-013-485	
		PR-62, 220VAC	000-013-486	
		PR-62, 230VAC	000-013-487	

## 1. Changing Transducer Output Power Setting

The default transducer output power setting is 1 kW. For use of the 2 kW or 3 kW transducer do the following;

1. Turn off the power.
2. Referring to the appropriate table on page A-3, change the location of the jumper blocks (one pair per jumper) of jumper(s) on the MAIN Board (02P6204) according to transducer output power;

### Jumpers

- FCV-291: JP10
- FCV-292: JP10 (for high freq.) and JP11 (for low freq.)

**Note:** Transducer output power setting must be correct. Incorrect setting may damage transducer and display unit and void the warranty.

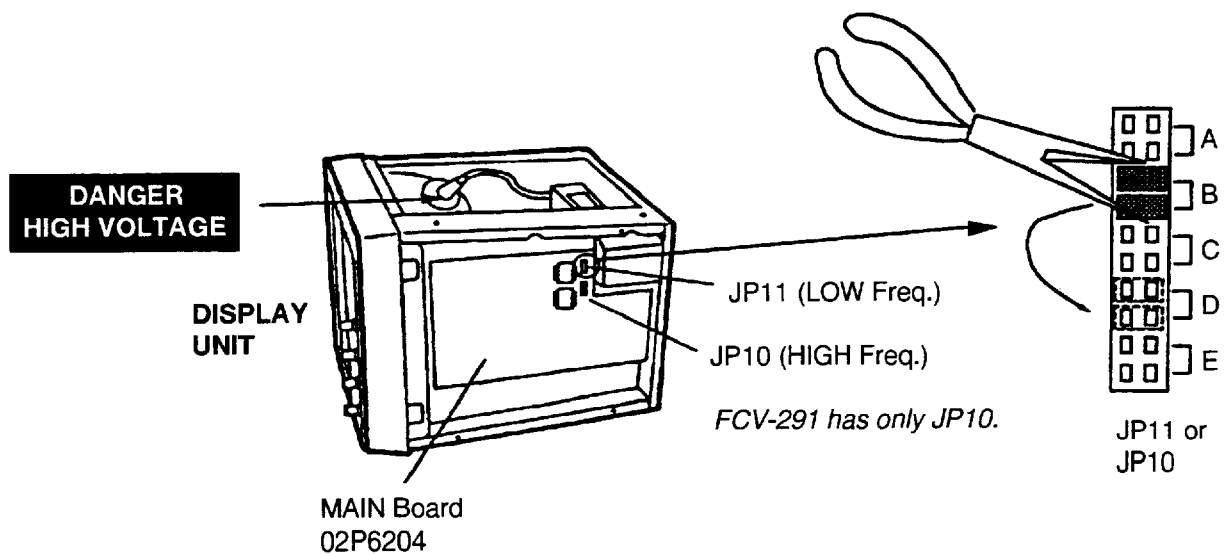

## 2. Changing Transducer Frequency Specifications

Transducer frequency specification may be changed with DIP switch S1 on the MAIN Board (02P6204) as follows;

1. Turn off the power.
2. Referring to the appropriate table on page A-3, set DIP switch S1 according to transducer frequency and change the location of the jumper blocks (one pair per jumper) of jumper(s) on the MAIN Board according to transducer output power;

### Jumpers

- FCV-291: JP10
- FCV-292: JP10 (for high freq.) and JP11 (for low freq.)

**Note:** Transducer frequency setting must be correct. Incorrect setting may damage transducer and display unit and void the warranty.

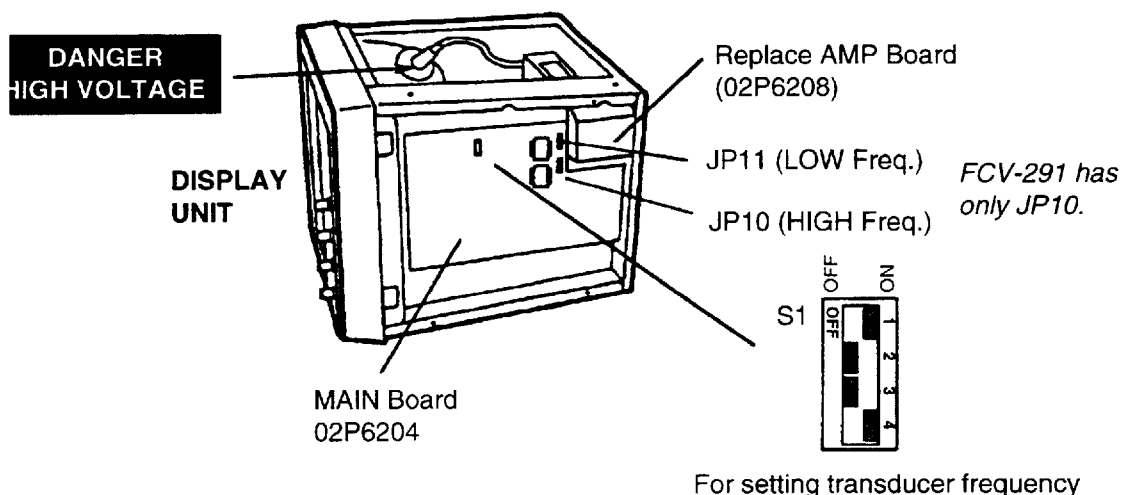

3. Replace AMP Board (02P6208).
4. Enter amplifier gain offset for the AMP Board following the instructions on page A-4.

**Note:** If you replace the MAIN board to a new one, confirm the transducer frequencies. The factory setting of the MAIN board supplied for maintenance is 50/200 kHz. Set DIP switch S1 according to transducer frequency.

Setting transducer output power and transducer frequency on MAIN Board in FCV-291

Freq. (kHz)	Output (kW)	Transducer	Jumper JP10	DIP switch S1			
				1	2	3	4
28	1	28F-8	B	ON	ON	ON	ON
	2	28F-18	C				
	3	28F-24H	B				
38	1		A	ON	OFF	ON	OFF
	2		C				
50	1	50B-6	A	ON	ON	ON	OFF
	1	50B-9	A				
	2	50B-12	E				
	3	50F-24H	D				
88	1	88B-8	E	ON	ON	OFF	OFF
	2	88B-10	C				
	3	88F-126H	D				
200	1	200B-8B	A	ON	OFF	ON	ON
	2	200B-B	C				
	3	200B-12H	D				

Setting transducer output power and transducer frequency on MAIN Board in FCV-292

Freq. (kHz)	Output (kW)	Transducer	Jumper JP10/JP11
28	1	28F-8	B
	2	28F-18	C
	3	28F-24H	B
50	1	50B-6	A
	1	50B-9	A
	2	50B-12	E
	3	50F-24H	D
88	1	88B-8	E
	2	88B-10	C
	3	88F-126H	D
200	1	200B-8B	A
	2	200B-8	C
	3	200B-12H	D

Freq. (kHz)	DIP switch S1			
	1	2	3	4
28/50	ON	ON	ON	ON
28/88	ON	ON	OFF	ON
28/200	ON	ON	OFF	OFF
50/88	ON	OFF	ON	OFF
50/200	ON	OFF	OFF	ON
88/200	OFF	ON	ON	OFF
Not defined	ON	OFF	OFF	ON

### 3. Adjustment After Replacement of MAIN or AMP Board (entering amplifier gain offset)

Whenever the MAIN or AMP Board is replaced the amplifier gain of the AMP Board must be offset to equalize it with that of the MAIN Board. This is done with switches on the front panel.

The amplifier gain of the MAIN and AMP boards is ranked in three levels according to output level and the ranking is labeled on these boards as A, B or C. When the equipment is shipped from the factory the MAIN and AMP Boards have the same amplifier gain.

Be sure to confirm and enter amplifier gain offset whenever one of these boards is replaced, otherwise sensitivity may too high or too low.

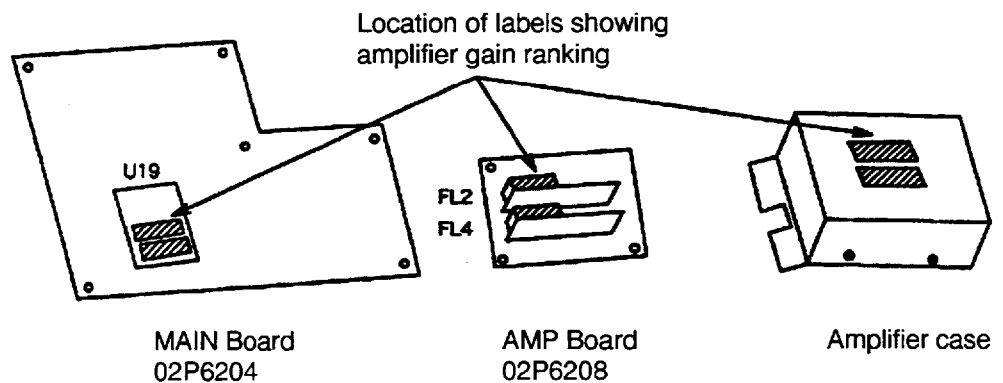

## Entering amplifier gain offset

### When replacing the MAIN Board

1. Check the label on the amplifier case or AMP Board (02P6208) to confirm its amplifier output ranking (A, B or C).
2. Install MAIN Board (02P6204).
3. Enter offset according to the AMP Board's amplifier output ranking as follows;
  - a) Press any key while turning on the power, to set the equipment in the option mode.
  - b) Press the [SIG LEV] key five times to display the "echo offset" display.
  - c) Enter offset according to the amplifier output ranking of the AMP Board referring to the table below. For the FCV-291 enter offset for both low and high frequencies.

Setting		Operation	
Ranking	Offset	FCV-291	FCV-292
A	+10	▲ ▼	HIGH ▲ ▼
B	0		LOW +-
C	-10		

**Note:** The setting range is -20 to +20, however use only +10, 0, or -10.

### When replacing the AMP Board

1. Check the label on the AMP Board (02P6208) to confirm its amplifier output ranking (A, B or C).
2. Install AMP Board.
3. Enter amplifier gain offset according to the AMP Board's amplifier output ranking, following step 3 in "When replacing the MAIN Board."

### When replacing both the AMP and MAIN boards

Amplifier gain of these boards is equal when they are shipped from the factory, however check the label on each board to confirm their amplifier output ranking. If amplifier output rankings are not the same, apply offset to the AMP Board following step 3 in "When replacing the MAIN Board."

## 4. Transducer 50BL-12/50BL-24H

When using the transducer 50BL-12/50BL-24H, see this section.

50BL-12 code no.: 000-015-013

50BL-24H code no.: 000-015-040

### Transducer, thru-hull pipe and tank list

Frequency (kHz)	Transducer (Code No.)	Hull Material	Tank (Code No.)	Fasten inside hull (Code No.)	Fasten outside hull (Code No.)
50	50BL-12	Steel	T-702 (000-015-041)	TFB-5000 (000-015-206)	-
		FRP	T-702F (000-015-240)	TRB-1000 (000-015-215)	-
	50BL-24H	Steel	T-694 (000-015-046)	TFB-5000 (000-015-206)	TFB-4000 (000-015-205)
		FRP	T-694F (000-015-242)	TRB-1000 (000-015-215)	-
50/200	50BL-12/200B-8B	Steel	T-693 (000-015-044)	TWB-6000 (000-015-207)	TWB-7000 (000-015-209)
		FRP	T-693F (000-015-241)	TRB-1100 (000-015-218)	-
28/50	28F-24H/50BL-24H	Steel	T-696 (000-015-048)	TWB-6000 (000-015-207)	TFB-7000 (000-015-209)
		FRP	T-696F (000-015-244)	TWB-1100 (000-015-218)	-
50/88	50BL-24H/88F-126H	Steel	T-697 (000-015-239)	TWB-6000 (000-015-207)	TFB-7000 (000-015-209)
		FRP	T-697F (000-015-245)	TWB-1100 (000-015-218)	-
50/200	50BL-24H/200B-12H	Steel	T-695 (000-015-047)	TWB-6000 (000-015-207)	TFB-7000 (000-015-209)
		FRP	T-695F (000-015-243)	TRB-1100 (000-015-218)	-

### Setting

For the locations of JP10 and JP11, see page A-1.

Board	Frequency (kHz)	Output (kW)	Transducer	JP10 and JP11 setting
02P6204 MAIN	50	2	5BL-12	B
		3	50BL-24H	D

Board	Frequency (kHz)	S1			
		1	2	3	4
02P6204 MAIN	28/50	ON	ON	ON	ON
	50/88	ON	OFF	ON	OFF
	50/200	ON	OFF	OFF	ON



## 5.New BLT Transducers

A new type BLT transducer (Bolt-clamp Langevin Transducer) has been developed for this echo sounder. The BLT transducer has large bandwidth, good sound efficiency, compact structure and is reinforced for protection against slamming.

28BL-6HR code no.: 000-015-081

28BL-12HR code no.: 000-015-082

38BL-9HR code no.: 000-015-083

38BL-15HR code no.: 000-015-092

50BL-12HR code no.: 000-015-093

50BL-24HR code no.: 000-015-094

### Transducer, thru-hull pipe and tank list

Frequency (kHz)	Transducer	Hull Material	Tank (Code No.)	Fasten inside hull (Code No.)	Fasten outside hull (Code No.)
28/200	28BL-6HR/200B-8B	Steel	T-693 (000-015-044)	TWB-6000 (2) (000-015-207)	TFB-7000 (2) (000-015-209)
		FRP	T-693F (000-015-241)	TRB-1100 (2) (000-015-219)	-
38/200	38BL-9HR/200B-8B	Steel	T-693 (000-015-044)	TWB-6000 (2) (000-015-207)	TFB-7000 (2) (000-015-209)
		FRP	T-693F (000-015-241)	TRB-1100 (2) (000-015-219)	-
50/200	50BL-12HR/200B-8B	Steel	T-693 (000-015-044)	TWB-6000 (2) (000-015-207)	TFB-7000 (2) (000-015-209)
		FRP	T-693F (000-015-241)	TRB-1100 (2) (000-015-219)	-
28/38	28BL-12HR/38BL-15HR	Steel	T-681 (000-015-849)	TWB-6000 (2) (000-015-207)	TFB-7000 (2) (000-015-209)
		FRP	T-681F (000-015-850)	TRB-1100 (2) (000-015-219)	-
28/50	28BL-12HR/50BL-24HR	Steel	T-681 (000-015-849)	TWB-6000 (2) (000-015-207)	TFB-7000 (2) (000-015-209)
		FRP	T-681F (000-015-850)	TRB-1100 (2) (000-015-219)	-
38/50	38BL-15HR/50BL-24HR	Steel	T-681 (000-015-849)	TWB-6000 (2) (000-015-207)	TFB-7000 (2) (000-015-209)
		FRP	T-681F (000-015-850)	TRB-1100 (2) (000-015-219)	-
28/88	28BL-12HR/88F-126H	Steel	T-682 (000-015-851)	TWB-6000 (2) (000-015-207)	TFB-7000 (2) (000-015-209)
		FRP	T-682F (000-015-852)	TRB-1100 (2) (000-015-219)	-

NEW BLT TRANSDUCERS

38/88	38BL-15HR/88F-126H	Steel	T-682 (000-015-851)	TWB-6000 (2) (000-015-207)	TFB-7000 (2) (000-015-209)
		FRP	T-682F (000-015-852)	TRB-1100 (2) (000-015-219)	-
50/88	50BL-24HR/88-126H	Steel	T-682 (000-015-851)	TWB-6000 (2) (000-015-207)	TFB-7000 (2) (000-015-209)
		FRP	T-682F (000-015-852)	TRB-1100 (2) (000-015-219)	-
28/200	28BL-12HR/200B-12H	Steel	T-683 (000-015-853)	TWB-6000 (2) (000-015-207)	TFB-7000 (2) (000-015-209)
		FRP	T-683F (000-015-854)	TRB-1100 (2) (000-015-219)	-
38/200	38BL-15HR/200B-12H	Steel	T-683 (000-015-853)	TWB-6000 (2) (000-015-207)	TFB-7000 (2) (000-015-209)
		FRP	T-683F (000-015-854)	TRB-1100 (2) (000-015-219)	-
50/200	50BL-24HR/200B-12H	Steel	T-683 (000-015-853)	TWB-6000 (2) (000-015-207)	TFB-7000 (2) (000-015-209)
		FRP	T-683F (000-015-854)	TRB-1100 (2) (000-015-219)	-
28/150	28BL-12HR/150B-12H	Steel	T-683 (000-015-853)	TWB-6000 (2) (000-015-207)	TFB-7000 (2) (000-015-209)
		FRP	T-683F (000-015-854)	TRB-1100 (2) (000-015-219)	-
38/150	38BL-15HR/150-12H	Steel	T-683 (000-015-853)	TWB-6000 (2) (000-015-207)	TFB-7000 (2) (000-015-209)
		FRP	T-683F (000-015-854)	TRB-1100 (2) (000-015-219)	-
38/150	50BL-24HR/156-12H	Steel	T-683 (000-015-853)	TWB-6000 (2) (000-015-207)	TFB-7000 (2) (000-015-209)
		FRP	T-683F (000-015-854)	TRB-1100 (2) (000-015-219)	-

**Setting**

For the locations of JP10 and JP11, see page A-1.

Board	Frequency (kHz)	Output (kW)	Transducer	JP10 and JP11 setting
02P6204 MAIN	28	2	28BL-6HR	B
		3	28BL-12HR	C
	38	2	38BL-9HR	C
		3	38BL-15HR	E
	50	2	50BL-12HR	D
		3	50BL-24HR	E

Board	Frequency (kHz)	S1			
		1	2	3	4
02P6204 MAIN	28/50	ON	ON	ON	ON
	38/50	OFF	ON	ON	ON
	50/88	ON	OFF	ON	OFF
	50/200	ON	OFF	OFF	ON

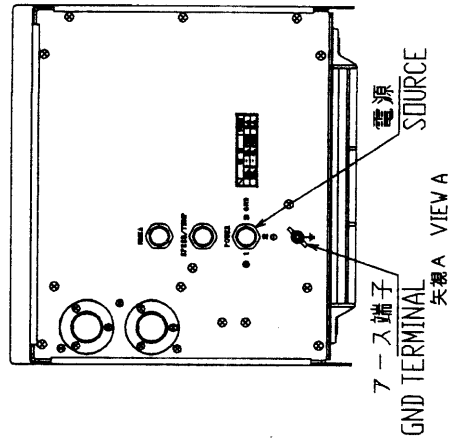
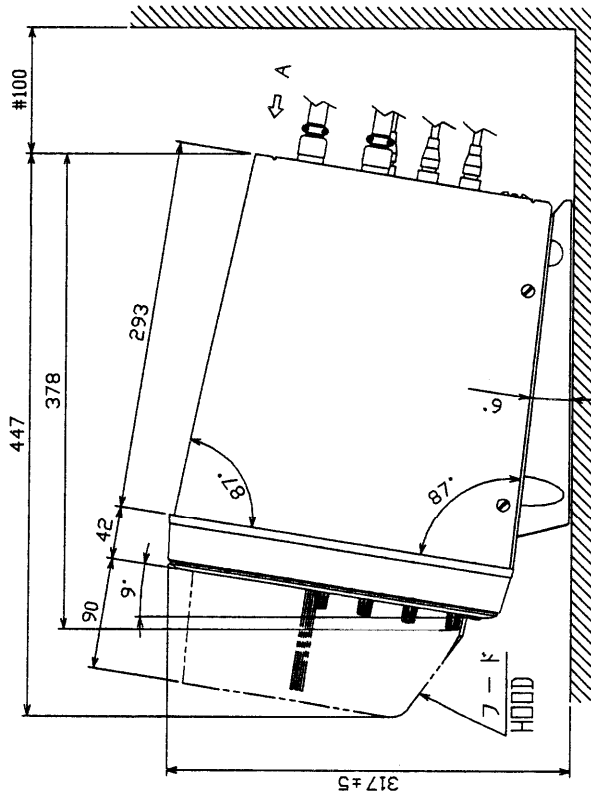
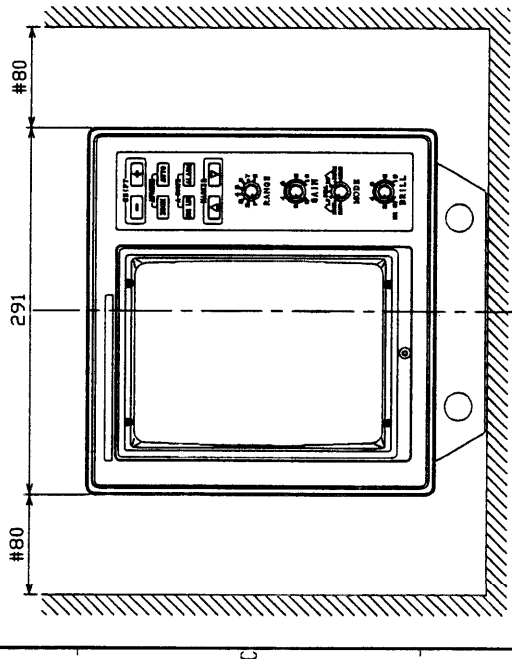
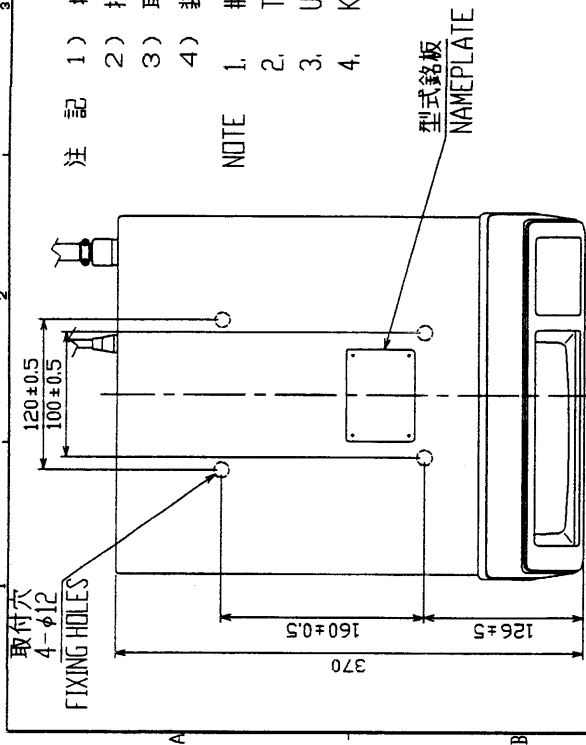

- 注記
- 1) #印寸法は最小サービス空間寸法とする。
  - 2) 指定外の寸法公差は表1による。
  - 3) 取付用ネジはM10ボルト、またはコーチボルト呼び径9を使用のこと。
  - 4) 装備ケーブルはサービス時、本体を十分引き出せるように余裕を持たせること。

- NOTE
1. # RECOMMENDED SERVICE CLEARANCE.
  2. TABLE 1 INDICATES TOLERANCE OF DIMENSIONS.
  3. USE M10 BOLTS OR COACH SCREWS  $\phi 9$  FOR FIXING THE UNIT.
  4. KEEP SUFFICIENT CABLE LENGTH BEHIND THE UNIT FOR MAINTENANCE.

寸法区分 (mm)	公差 (mm)
DIMENSION	TOLERANCE
$L \leq 50$	$\pm 1.5$
$50 < L \leq 100$	$\pm 2.5$
$100 < L \leq 500$	$\pm 3$

表 1 TABLE 1

DRAWN	Apr. 27 '81	T. YAMASAKI	TITLE	CV-292
CHECKED			名称	指示器
APPROVED			外寸図	
SCALE	1/6	MASS 12 kg	NAME	DISPLAY UNIT
DWG No.	C2352-G01-D			OUTLINE DRAWING

A

B

C

D

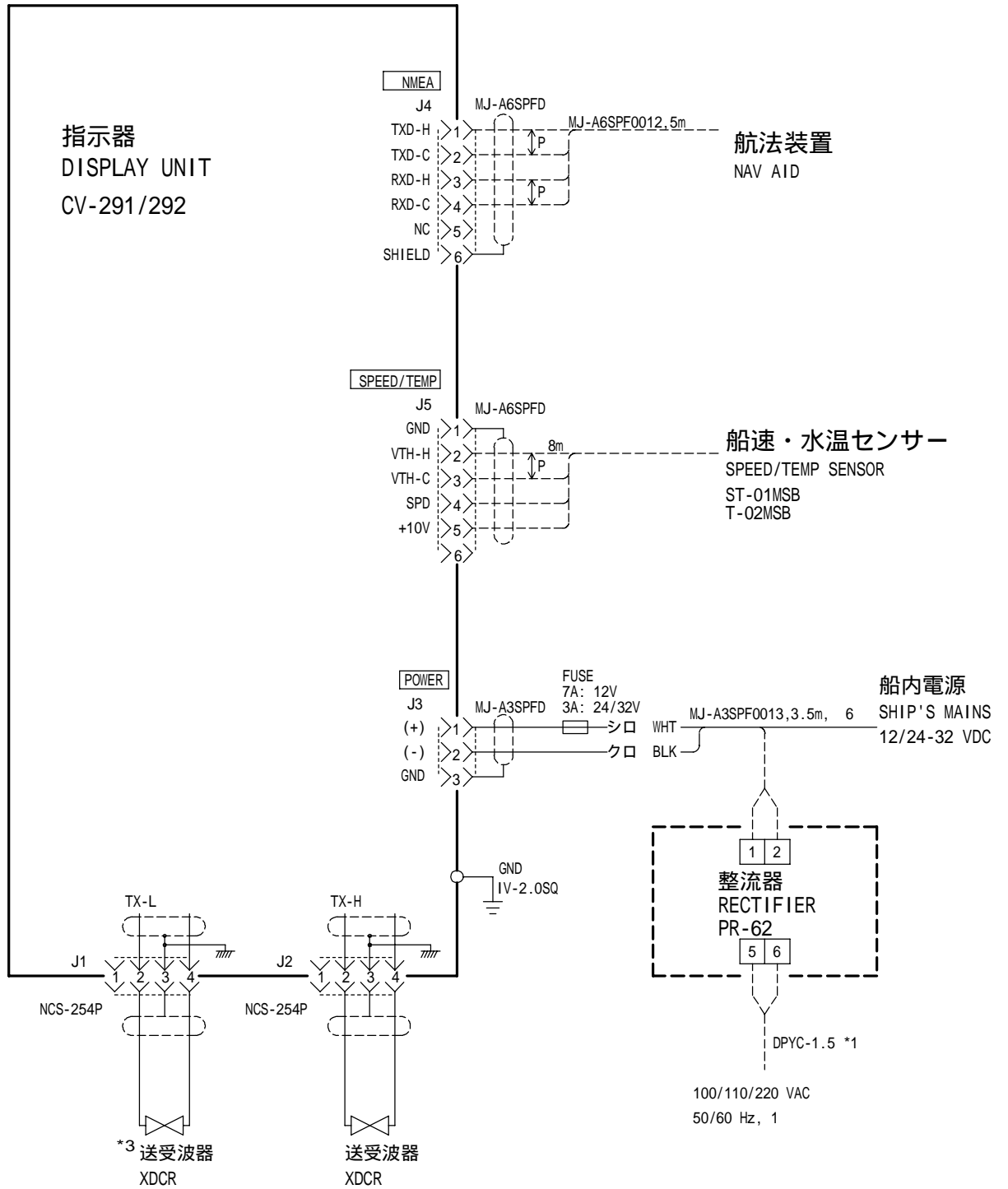

**注記**

- \* 1 ) 造船所手配
- \* 2 ) 工場にて接続済み
- \* 3 ) FCV-292のみ

**NOTE**

- \*1: SHIPYARD SUPPLY.
- \*2: FITTED AT FACTORY.
- \*3: ONLY FOR FCV-292.

DRAWN Sep. 30 '02 T. YAMASAKI		TITLE FCV-291/292
CHECKED Oct. 1 '02 Y. KIMURA		名称 カラー魚群探知機
APPROVED Oct. 1, '02 <i>Y. Kimura</i>		相互結線図
SCALE MASS kg		NAME COLOR VIDEO SOUNDER
DWG. No. C2351-C01- F		INTERCONNECTION DIAGRAM