

R7018SB

◆ FASSTest-2.4GHz Bidirectional Communication System / FASST-Multi-ch 2.4GHz
 ◆ Dual Battery ◆ S.BUS2 / S.BUS Port and 18 Channels for Conventional System Receiver

Thank you for purchasing a Futaba R7018SB FASSTest-2.4GHz compatible receiver. The R7018SB receiver features bi-directional communication with a FASSTest Futaba transmitter using the S.BUS2 port. Using the S.BUS2 port an impressive array of telemetry sensors may be utilized. It also includes both standard PWM output ports and S.BUS output ports.

The R7018SB has a **Dual Battery System**. Multiple servos can be driven by connecting 2 large capacity batteries. Even if the voltage of one battery drops, the other battery allows safe flight. The R7018SB can also be switched the FASST-Multi-ch System.

● **Applicable systems: Futaba FASSTest-2.4GHz / FASST-Multi-ch system transmitter**

Usage precaution

- Analog servos cannot be used with the R7018SB in the FASSTest 12CH mode.
- When the FASST Multi-ch High-speed Mode is used, analog servos cannot be used at the CH1 ~ 6 outputs for convention systems. However, in other than the FASSTest 12CH mode, analog servos can be used at CH7 ~ 16, DG1 and DG2 at any time.
- Don't connect to Extra Voltage Telemetry Port before turning on a receiver.

⚠ WARNING

❗ **Changes or modification not especially approved by the party responsible for compliance could void the user's authority to operate the equipment.**

❗ **When the model is not being used, always remove or disconnect the battery.**

■ When the switch is off, a slight amount of current still flows. Unless the switch and battery are disconnected, the battery will be damaged from excessive discharge.

❗ **The R7018SB receiver should be protected from vibration by foam rubber, Velcro, or similar mounting methods. Protect from moisture.**

❗ **Keep away from conductive materials to avoid short circuits.**

❗ **When only one battery is connected, always insulate the unused connector.**

Antenna installation precaution

- ⊘ Do not cut or bundle the receiver antenna wire.
- ⊘ Do not bend the coaxial cable. It causes damage.
- ❗ The antennas must be mounted in such a way to assure they are strain relieved.

❗ **Keep the antenna as far away from the motor, ESC and other noise sources as you possibly can.**

❗ **Be sure that the two antennas are placed at 90 degrees to each other.**

■ The R7018SB has two antennas. In order to maximize signal reception and promote safe modeling Futaba has adopted a diversity antenna system. This allows the receiver to obtain RF signals on both antennas and fly problem-free.

Antenna installation for carbon fuselage

❗ **You must leave 30mm at the tip of the antenna fully exposed. The exposed antenna should be secured so that it cannot move around or back inside of your aircraft.**

Be careful of connector insertion

- ⊘ Don't connect an S.BUS servo / gyro to S.BUS2 connector.
- ⊘ Do not connect the power supply battery to other than the power supply connector.
- There is the danger of ignition, explosion, or burning.

Link precaution

⊘ Do not perform the linking procedure while the motor's main power connected or the engine is operating as it may result in serious injury.

❗ **When the linking is complete, please cycle the receiver power and ensure the receiver is properly linked to the transmitter.**

❗ **Please power up your system in this order. Transmitter first, followed by the receiver.**

❗ **If the R7018SB receiver was previously linked to another transmitter, make sure that transmitter is not operating while linking the receiver to the new transmitter.**

CONTENTS

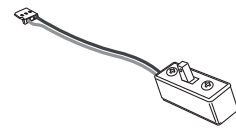
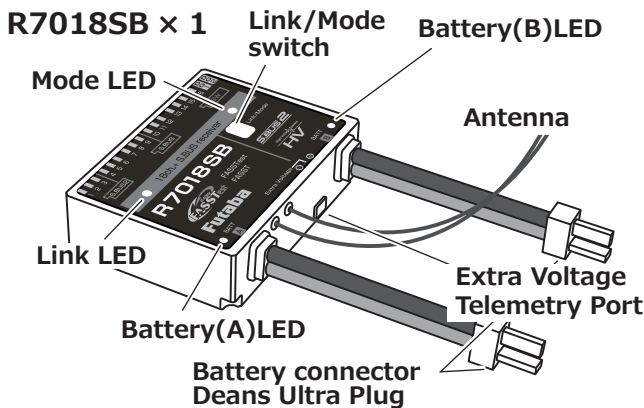

Exclusive switch x 1

Ordinary switches (SSW-J, HSW-J, HSW-L, etc.) cannot be used.

Female Deans Ultra Plug x 2

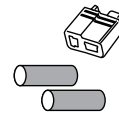

Heatshrink tube

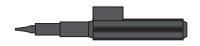

Mini driver x 1

Use a Deans Ultra Plug with the R7018SB power supply battery. Batteries of this connector cannot be used.

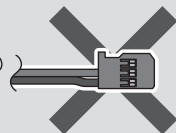

ESC (motor controller) that supplies power from the drive battery (BEC- Battery Eliminator Circuit) to the receiver cannot be used.

Compliance Information Statement (for U.S.A.)

This device, trade name Futaba Corporation, model number R7018SB, complies with part15 of the FCC Rules. Operation is subject to the following two conditions:

- (1) This device may not cause harmful interference, and
- (2) This device must accept any interference received, including interference that may cause undesired operation.
- (3) This module meets the requirements for a mobile device that may be used at separation distances of more than 20cm from human body.

To meet the RF exposure requirements of the FCC this device shall not be co-located with another transmitting device.

The responsible party of this device compliance is:

Futaba Service Center
 3002 N Apollo Drive Suite 1, Champaign, IL 61822 U.S.A.
 TEL (217)398-8970 or E-mail: support@futaba-rc.com (Support)

Connection

Do not use a battery of the wrong rated voltage and type (Li-po, Li-Fe, etc.).

When the receiver is not in use, always disconnect the battery.

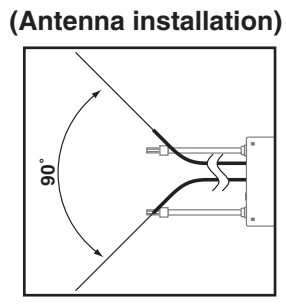
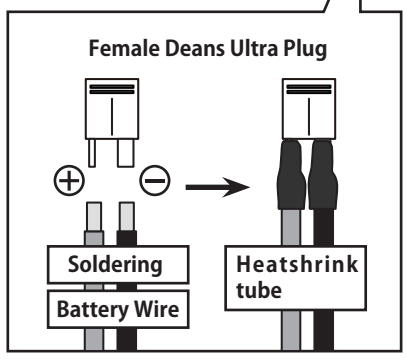
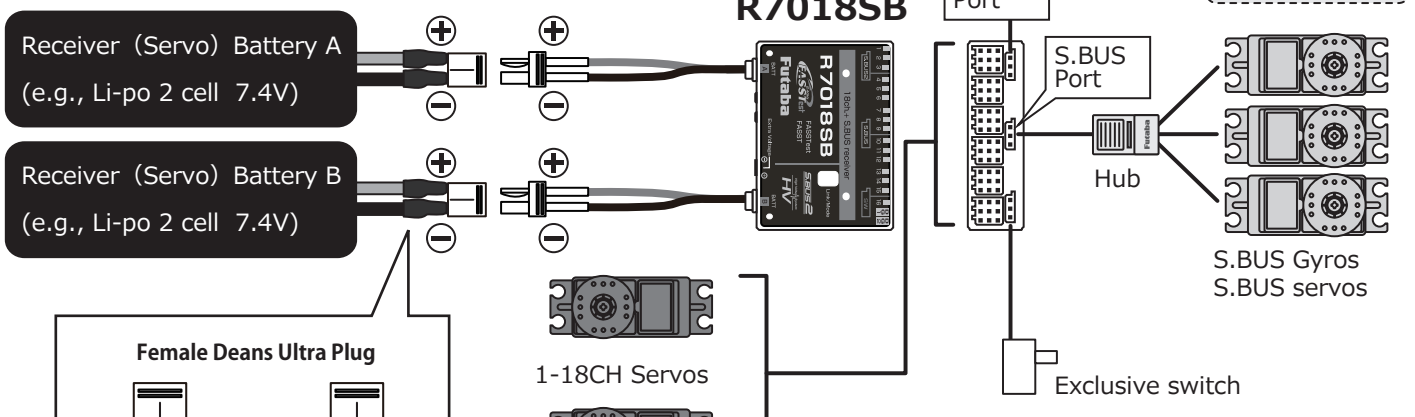

⚠ WARNING

- ❗ **Never reverse the battery polarity.**
 - A reverse connection the battery terminals may cause abnormal heating, fire and burns.
- ⚡ **Do not short circuit the battery terminals.**
 - A short circuit across the battery terminals may cause abnormal heating, fire and burns.
- ❗ **Be careful when soldering to the plug; don't overheat the plug with your soldering iron and take great care to avoid short-circuits on the plug.**
 - Such a overheat and short-circuit would destroy the plug.

LED Indication

System	Mode LED	Status	Link LED
FASSTest	Green Solid	No signal reception	Red Solid
		Receiving signals	Green Solid
		Waiting for link	Start → 2second later → Red Blink (1second)
FASST	Off	No signal reception	Red Solid
		Receiving signals	Green Solid
		Receiving signals but ID is unmatched	Green Blink
		Waiting for link	Red Blink
FASSTest FASST	—	Unrecoverable error (EEPROM, etc.)	Alternate blink

Connector

The direction of the connectors of the bottom 3 ports is different by 90°.

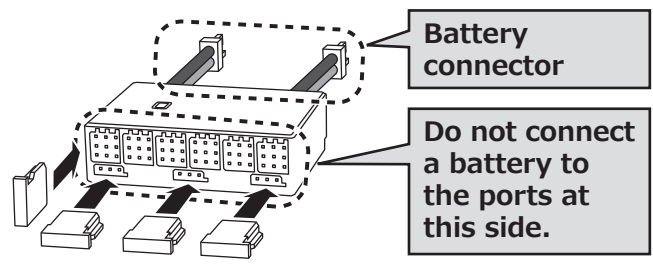

FASSTest ↔ FASST (Normal-High-speed) Change method

1. Turn on the receiver. (Transmitter OFF)
2. Press and hold the Link/Mode button for more then 5 second.
3. When the LED begins to blink green/red the button may be released.

4. The LED should now be blinking red in one of the patterns described by the chart below.
(Default : FASSTest)
5. Each press of the Mode/Link button advances the receiver to the next mode.
6. When you reach the mode that you wish to operate in, press and hold the Mode/Link button for more than 2 seconds.
7. Once locked into the correct mode the LED will change to a solid color.
8. Please cycle the receiver(s) power off and back on again after changing the Channel Mode.

Red LED blink	System
1 time	FASSTest
2 time	FASST Multi-ch Normal mode
3 time	FASST Multi-ch High-speed mode

*Fixed at neutral if a servo is connected to a port other than a usable transmitter channel.
*The telemetry and Extra Voltage ports cannot be used with the FASST system.

Dual Battery System

Two power supply batteries can be connected to the **R7018SB**. Power is supplied from the battery with the highest voltage. The operating time is the total time of the 2 batteries. For example, even if the voltage of one battery drops, power can be supplied from the other battery. Even one battery can be used, but safer flight is possible if 2 batteries are used.

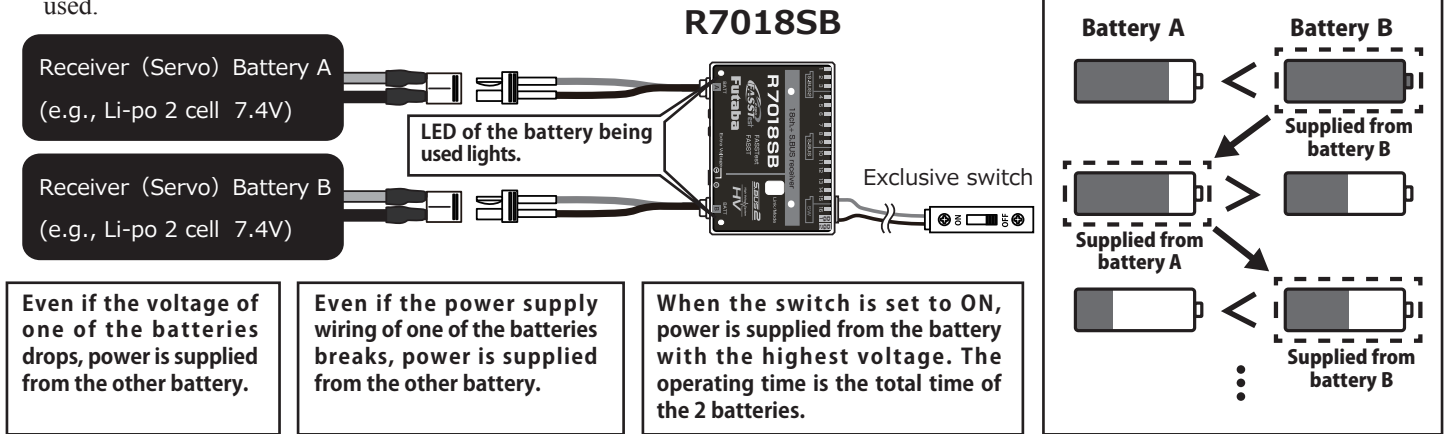

This receiver employs an electronic switching (current is controlled by an FET circuit) system. When the exclusive switch is set to ON or is pulled, the power is turned on. Switches other than the exclusive switch cannot be used. In addition, since a very small current flows even when the power is off, always disconnect the battery from the connector when the receiver is not in use.

One or 2 batteries can be connected. When 2 batteries are connected, the battery with the highest voltage is used. When only one battery is connected, always insulate the unused connector. The battery can be connected to either side.

In addition, since this receiver does not have a built-in voltage regulator, use batteries with sufficient capacity for the specifications and number of servo motors to be used.

FASSTest

FASSTest

FASSTest is a bidirectional communication system between the **R7018SB** receiver and **FASSTest** capable transmitters. Multiple optional telemetry sensors may be connected to the **S.BUS2** on the receiver and that data is in turn displayed on the transmitter.

*Please see your transmitters operation manual to configure transmitter to operate with telemetry sensors.

Link to the transmitter : FASSTest

- 1 Bring the transmitter and the receiver close to each other, within 20 inches (half meter).
- 2 Turn on the transmitter. Place the transmitter into the receiver linking mode.
- 3 Turn on the receiver.
- 4 The receiver will wait for the linking process to begin for 2 seconds. Following that it will return to the normal operation mode.
- 5 When the LED of the receiver changes from blinking red to solid green, linking is complete.

(A link waiting state is ended in 1 second.)

- Refer to the transmitters operation manual for complete details on how to place the transmitter into the linking mode.
- If there are many FASSTest systems turned on in close proximity, your receiver might have difficulty establishing a link to your transmitter. This is a rare occurrence. However, should another FASSTest transmitter/receiver be linking at the same time, your receiver could link to the wrong transmitter. This is very dangerous if you do not notice this situation. In order to avoid the problem, we strongly recommend you to double check whether your receiver is really under control by your transmitter.
- If the System Type of the transmitter is changed, the receiver will need to be re-linked to the transmitter.

Receiver voltage transmitter display

The voltage displayed at the transmitter is only that of the battery currently in use (battery with the highest voltage).

*The voltage of the 2 batteries cannot be displayed individually.

S.BUS2

S.BUS2 extends **S.BUS** and supports bidirectional communication. Sensors are connected to the **S.BUS2** port.

*Only S.Bus2 capable devices may be connected to the S.Bus2 port. Standard S.Bus servos and gyros should not be connected to the S.Bus2 port.

Extra Voltage Telemetry port

It connects with the battery for power, etc.

External voltage input cable (CA-RVIN-700) of an option is used. The voltage of the battery can be displayed with a transmitter.

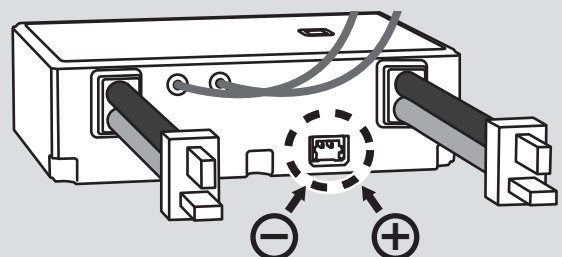

When a telemetry adapter (TMA-1) is used : FASSTest only

When using a TMA-1 (sold separately), change the settings by the following method.

The TMA-1 is a device for viewing the telemetry data on a smartphone or tablet.

R7018SB and TMA-1 linking method

1. Switch the receiver to FASSTest system.
2. Link the transmitter and receiver, and after confirming operation, turn off the power.

3. Turn on the receiver power. (Transmitter power off)
4. Press the Link/Mode switch for at least 10 seconds.
5. After the LED blinks red and changes to red/green simultaneous rapid blinking, release the switch.
6. The receiver enters the linked with TMA-1 mode, and the LED begins red/green simultaneous rapid blinking.
7. Press the TMA-1 link switch until the LED starts to blink and wait for the TMA-1 to link.
8. When TMA-1 linking is complete, the TMA-1 LED changes from red to green for a moment.
9. When linking is complete, turn on the receiver power and check the operation of all the devices.

FASST

When switched, the R7018SB can use the FASST-Multi-ch mode. When the FASST system is used, the telemetry and Extra Voltage ports cannot be used. The FASST system has a Normal mode and a High-speed mode. However, in the High-speed mode, analog servos cannot be used at CH1 ~ 6.

Link to the transmitter : FASST

1. Bring the transmitter and the receiver close to each other, within 20 inches (half meter).
2. Turn on the transmitter and receiver.
3. Link operation is performed by the Link/Mode switch.

• When using TM-8 module, it's possible to set F/S position (only 3CH).

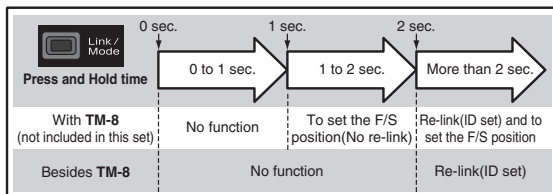

*Refer to the instruction manual of the transmitter or module used for a description of the linking operation, F/S position setting methods and other details.

When using Multi prop (MPDX-1)

The MPDX-1 can be used with FASSTest by merely setting the corresponding transmitter. (Refer to the instruction manual of the corresponding transmitter.) When using the MPDX-1 Multi Prop Decoder (sold separately) with the FASST system, change the setting by the following method.

Enable the MPDX-1 at channels 11 and 12. (Initial value: OFF)

Channels 11 and 12 cannot be used individually for MPDX-1 output.

The MPDX-1 extends 1 channel to 8 channels. However, since the response speed becomes slower and there are functional restrictions, use it at simple switch operation and other applications that require numerous channels.

Multi prop mode Change method

1. Switch the receiver to the FASST system (Normal or High-speed).
2. Turn on the receiver power. (Transmitter power off)
3. Press the Link/Mode switch for at least 10 seconds.
4. When the LED blinks red and changes to red/green simultaneous rapid blinking, release the switch.
5. The receiver enters the multi prop mode and the LED of the current mode blinks. (Initial value: OFF)
6. Each time the switch is pressed, the mode changes.
7. When the receiver was switched to the desired mode, press the Link/Mode switch for at least 2 seconds.
8. When the LED switches to red/green simultaneous rapid blinking, mode switching is complete. Release the switch.
9. When switching is complete, turn on the power. When the power is turned on, the receiver switches to the new mode.

Green LED blink	Mode
1 time	Multi prop mode OFF
2 time	Multi prop mode ON

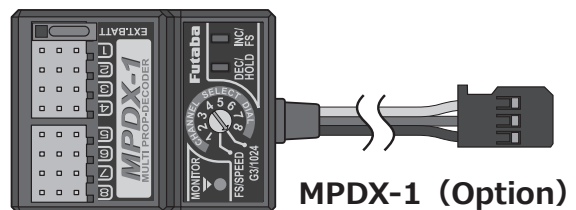

R7018SB Specifications

FASSTest-2.4GHz system (18CH/12CH mode) FASST-2.4GHz system (Multi-ch mode)

S.BUS2 and S.BUS port and Linear 16 ch + Digital 2 ch for conventional system receiver

- Dual antenna diversity
- Size: 2.15 x 1.59 x 0.64 in. (54.6x40.4x16.3mm)
- Weight: 1.48 oz. (42g)
- Power requirement: 6.0V to 7.4V (Voltage range: 4.8 to 8.4V)

- Battery F/S Voltage: It sets up with a transmitter (F/S can't be used in case of FASST.)
- Extra Voltage port: 0 ~ 70V DC

本產品符合低功率電波輻射性電機管理辦法第十二條、第十四條等條文規定
 1. 經型式認證合格之低功率射頻電機，非經許可，公司、商號或使用者均不得擅自變更頻率、加大功率或變更原設計之特性及功能。
 2. 低功率射頻電機之使用不得影響飛航安全及干擾合法通信；經發現有干擾現象時，應立即停用，並改善至無干擾時方得繼續使用。前項合法通信，指依電信法規定作業之無線電通信。低功率射頻電機須忍受合法通信或工業、科學及醫療用電波輻射性電機設備之干擾。