

Thank you for purchasing a Futaba 3PM.  
Before using your 3PM, read this manual carefully and use your R/C set safely.  
After reading this manual, store it in a safe place.

## Application, Export, and Modification

1. This product may be used for models only. It is not intended for use in any application other than the control of models for hobby and recreational purposes. The product is subject to regulations of the Ministry of Radio/Telecommunications and is restricted under Japanese law to such purposes.

2. Exportation precautions:

(a) When this product is exported from the country of manufacture, its use is to be approved by the laws governing the country of destination which govern devices that emit radio frequencies. If this product is then re-exported to other countries, it may be subject to restrictions on such export. Prior approval of the appropriate government authorities may be required. If you have purchased this product from an exporter outside your country, and not the authorized Futaba distributor in your country, please contact the seller immediately to determine if such export regulations have been met.

(b) Use of this product with other than models may be restricted by Export and Trade Control Regulations, and an application for export approval must be submitted. In the US, use of 72MHz (aircraft only), 75MHz (ground models only) and 27MHz (both) frequency bands are strictly regulated by the FCC. This equipment must not be utilized to operate equipment other than radio controlled models. Similarly, other frequencies (except 50MHz, for HAM operators) must not be used to operate models.

3. Modification, adjustment, and replacement of parts: Futaba is not responsible for unauthorized modification, adjustment, and replacement of parts on this product. Any such changes may void the warranty.

## Compliance Information Statement (for U.S.A.)

This device, trade name Futaba Corporation of America, model number R133F and R303FS comply with part 15 of the FCC Rules. Operation is subject to the following two conditions:

- (1) This device may not cause harmful interference, and
- (2) This device must accept any interference received, including interference that may cause undesired operation.

The responsible party of this device compliance is;  
Futaba Corporation of America  
2865 Wall Triana Highway, Huntsville, Alabama 35824, U.S.A.  
TEL (256) 461 - 7348

## Battery Recycling (for U.S.A.)



The RBRC™ SEAL on the (easily removable) nickel-cadmium battery contained in Futaba products indicates that Futaba Corporation of America is voluntarily participating in an industry program to collect and recycle these batteries at the end of their useful lives, when taken out of service within the United States. The RBRC™ program provides a convenient alternative to placing used nickel-cadmium batteries into the trash or municipal waste system, which is illegal in some areas.

You may contact your local recycling center for information on where to return the spent battery. Please call 1-800-8-BATTERY for information on Ni-Cd battery recycling in your area. Futaba Corporation of America's involvement in this program is part of its commitment to protecting our environment and conserving natural resources.

**NOTE:** Our instruction manuals encourage our customers to return spent batteries to a local recycling center in order to keep a healthy environment.

RBRC™ is a trademark of the Rechargeable Battery Recycling Corporation.

**Warning: This product contains a chemical known to cause cancer and birth defects (or other reproductive harm).**

- 
- No part of this manual may be reproduced in any form without prior permission.
  - The contents of this manual are subject to change without prior notice.
  - This manual has been carefully written. Please write to Futaba if you feel that any corrections or clarifications should be made.
  - Futaba is not responsible for the use of this product.

**For Your Safety As Well As That Of Others ..... 6**

Explanation of Symbols .....	6
High Response System (H.R.S) Precautions .....	6
Operation Precautions .....	7
NiCd Battery Handling Precautions .....	9
Storage and Disposal Precautions .....	10
Other Precautions .....	11

**Before Using ..... 12**

Features .....	12
Set Contents .....	14
Nomenclature (Transmitter/Receiver/Servo) .....	15

**Installation ..... 22**

Receiver and Servo Connections .....	22
Installation Safety Precautions .....	23

**Initial Set-Up ..... 24**

Preparations (Transmitter) .....	24
----------------------------------	----

**Function Map ..... 28**

(Function Selection) .....	28
----------------------------	----

**Functions ..... 30**

End Point Adjuster .....	30
Steering Speed .....	33
Steering EXP / Throttle EXP .....	34
A.B.S. Function .....	36
Throttle Acceleration.....	38
Brake Mixing .....	40
Programmable Mixing .....	41
Fail Safe/Battery Fail Safe (HRS System Only) .....	42
Trim .....	43
Steering D/R .....	44
ATL Function .....	44
Channel 3 Position .....	45
Subtrim .....	46
Channel Reverse .....	47

Model Select .....	48
Timer .....	49
<b>(System Functions)</b>	
Frequency Selection (T3PM-FS only) .....	51
Model Copy .....	51
Model Reset .....	52
Model Name .....	52
HRS/PPM Select .....	53
Function Select Switch .....	54
Function Select Lever .....	55
Condition 2 Selection .....	56
LED Mode Selection .....	56

**Reference ..... 57**

Ratings .....	57
Optional Parts .....	58
Troubleshooting .....	59
Error Displays .....	60
When requesting repair .....	61

**For Your Safety  
As Well As  
That Of Others**

**Before  
Using**

**Installation**

**Initial  
Set-Up**

**Function  
Map**

**Functions**



**Reference**

Use this product in a safe manner. Please observe the following safety precautions at all times.

### Explanation of Symbols

The parts of this manual indicated by the following symbols are extremely important and must be observed.

For Your Safety As Well As That Of Others

Symbols	Explanation
 <b>Danger</b>	Indicates a procedure which could lead to a dangerous situation and may cause death or serious injury if ignored and not performed properly.
 <b>Warning</b>	Indicates procedures which may lead to dangerous situations and could cause death or serious injury as well as superficial injury and physical damage.
 <b>Caution</b>	Indicates procedures that may not cause serious injury, but could lead to physical damage.

Symbols:



; Prohibited

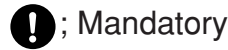

; Mandatory

### High Response System (H.R.S) Precautions

(Only when R203HF is used)

#### **Caution**

#### Mandatory Procedures

 In case of the High Response System (H.R.S) receiver R203HF, always use only the following conditions:

**Servo; 6V type Digital Servo only**

**Power supply; 6V Nicd battery**

**Transmitter setting; "HRS" mode**

If the conditions are different, control is impossible.

And **Fail Safe Unit (FSUI)** is not available.

# Operation Precautions

## Warning

### Prohibited Procedures

-  Do not operate two or more models on the same frequency at the same time.

Operating two or more models at same time on the same frequency will cause interference and loss of control of both models.

AM, FM (PPM) PCM and HRS are different methods of modulation. Nonetheless the same frequency can not be used at the same point in time, regardless of the signal format.

-  Do not operate in the following places.

- Near other sites where other radio control activity may occur.
- Near people or roads.
- On any pond when boats are present.
- Near high tension power lines or communication broadcasting antennas.

Interference could cause loss of control. Improper installation of your Radio Control System in your model could result in serious injury.

-  Do not operate outdoors on rainy days, run through puddles of water or when visibility is limited.

Should any type of moisture (water or snow) enter any component of the system, erratic operation and loss of control may occur.

-  Do not operate this R/C system when you are tired, not feeling well or under the influence of alcohol or drugs.

Your judgment is impaired and could result in a dangerous situation that may cause serious injury to yourself as well as others.

### Mandatory Procedures

-  Extend the transmitter antenna to its full length.

If the transmitter antenna is not fully extended the operating range of the radio will be reduced.

-  Check the transmitter antenna to be sure it is not loose.

If the transmitter antenna works loose, or is disconnected while the model is running signal transmission will be lost. This will cause you to lose control of the model.

-  Always perform an operating range check prior to use.

Problems with the radio control system as well as improper installation in a model could cause loss of control.

(Simple range test method)

Have a friend hold the model, or clamp it down or place it where the wheels or prop can not come in contact with any object. Walk away and check to see if the servos follow the movement of the controls on the transmitter. Should you notice any abnormal operation, Do not operate the model. Also check to be sure the model memory matches the model in use.

For Your Safety As Well As That Of Others

## **Caution**

### Prohibited Procedures

-  Do not touch the engine, motor, speed control or any part of the model that will generate heat while the model is operating or immediately after its use.

These parts may be very hot and can cause serious burns.

### Mandatory Procedures

#### **(Turning on the power switches)**

-  Always check the throttle trigger on the transmitter to be sure it is at the neutral position.

1. Turn on the transmitter power switch.
2. Turn on the receiver or speed control power switch.

#### **(Turning off the power switches)**

-  Always be sure the engine is not running or the motor is stopped.

1. Turn off the receiver or speed control power switch.
2. Then turn off the transmitter power switch.

If the power switches are turned off in the opposite order the model may unexpectedly run out of control and cause a very dangerous situation.

-  When making adjustments to the model do so with the engine not running or the motor disconnected.

You may unexpectedly lose control and create a dangerous situation.

-  When operating your model always display a frequency flag on your transmitter antenna.

#### **(Fail safe function) ---H.R.S mode only**

-  Before running (cruising), check the fail safe function.

Check Method;

Before starting the engine, check the fail safe function as follows:

- 1) Turn on the transmitter and receiver power switches.
- 2) Wait at least one minute, then turn off the transmitter power switch. (The transmitter automatically transfers the fail safe data to the receiver every minute.)
- 3) Check if the fail safe function moves the servos to the preset position when reception fails.

The fail safe function is a safety feature that minimizes set damage by moving the servos to a preset position when reception fails. However, if set to a dangerous position, it has the opposite effect.

Setting example: Throttle idle or brake position

For Your Safety As Well As That Of Others

# NiCd Battery Handling Precautions

(Only when NiCd batteries are used)

## Warning

### Mandatory Procedures

- Always check to be sure your batteries have been charged prior to operating the model.

Should the battery go dead while the model is operating, loss of control will occur and create a very dangerous situation.

- When the model is not being used, always remove or disconnect the NiCd battery.

Should the battery be left connected this could create a dangerous situation if someone accidentally turns on the receiver power switch. Loss of control would occur.

- To recharge the transmitter NiCd, use the special charger made for this purpose.

Overcharging could cause the NiCd battery to overheat, leak or explode. This may lead to fire, burns, loss of sight and many other types of injuries.



## Caution

### Prohibited Items

- Do not use commercial AA size NiCd batteries.

Quick charging may cause the battery contacts to overheat and damage the battery holder.

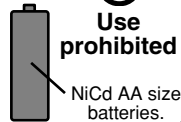

- Do not short circuit the NiCd battery terminals.

Causing a short circuit across the battery terminals may cause abnormal heating, fire and burns.

- Do not drop the NiCd battery or expose it to strong shocks or vibrations.

The battery may short circuit and overheat, electrolyte may leak out and cause burns or chemical damage.



For Your Safety As Well As That Of Others



## Storage and Disposal Precautions

For Your Safety As Well As That Of Others

### Warning

#### — Prohibited Procedures —

-  Do not leave the radio system or models within the reach of small children.

A small child may accidentally operate the system. This could cause a dangerous situation and injuries. NiCd batteries can be very dangerous when mis-handled and cause chemical damage.

-  Do not throw NiCd batteries into a fire. Do not expose NiCd batteries to extreme heat. Also do not disassemble or modify a NiCd battery pack.

Overheating and breakage will cause the electrolyte to leak from the cells and cause skin burns, loss of sight as well as other injuries.

#### — Mandatory Procedures —

-  When the system will not be used for any length of time store the system with batteries in a discharged state. Be sure to recharge the batteries prior to the next time the system is used.

If the batteries are repeatedly recharged in a slightly discharged state the memory effect of the NiCd battery may considerably reduce the capacity. A reduction in operating time will occur even when the batteries are charged for the recommended time.

### <NiCd Battery Electrolyte>

The electrolyte in NiCd batteries is a strong alkali. Should you get even the smallest amount of the electrolyte in your eyes, DO NOT RUB. Wash immediately with water and seek medical attention at once. The electrolyte can cause blindness. If electrolyte comes in contact with your skin or clothes, wash with water immediately.

### Caution

#### — Prohibited Procedures —

-  Do not store your R/C system in the following places.
  - Where it is extremely hot or cold.
  - Where the system will be exposed to direct sunlight.
  - Where the humidity is high.
  - Where vibration is prevalent.
  - Where dust is prevalent.
  - Where the system would be exposed to steam and condensation.

Storing your R/C system under adverse conditions could cause deformation and numerous problems with operations.

#### — Mandatory Procedure —

-  If the system will not be used for a long period of time remove the batteries from the transmitter and model and store in a cool dry place.

If the batteries are left in the transmitter electrolyte may leak and damage the transmitter. This applies to the model also. Remove the batteries from it also to prevent damage.

### <NiCd Battery Recycling>

A used NiCd battery is valuable resource. Insulate the battery terminals and dispose the battery by taking it to a battery recycling center.

## Other Precautions

### Caution

#### — Prohibited Procedures —

 Do not expose plastic parts to fuel, motor spray, waste oil or exhaust.

The fuel, motor spray, waste oil and exhaust will penetrate and damage the plastic.

#### — Mandatory Procedures —

 Always use only genuine Futaba transmitters, receivers, servos, FET amps (electronic speed controls), NiCd batteries and other optional accessories.

Futaba will not be responsible for problems caused by the use of other than Futaba genuine parts. Use the parts specified in the instruction manual and catalog.

For Your Safety As Well As That Of Others

## Features

- **PLL Synthesizer System** (Transmitter T3PM-FS and Receiver R303FS only)  
3PM PLL synthesizer system is easy to change the frequency only by selecting a desired frequency on a transmitter LCD screen and adjusting the two dials equipped on a receiver respectively.

- **High Response System (H.R.S.)** (Receiver R203HF only)

When used with the H.R.S. system, a speed of triple that of an FM system at average response is realized. (Comparison with other Futaba products)

- **Simple segment type LCD display and four edit keys for easy data setup**

- **10 models memory**

Model names can use up to 3 letters, numbers, and symbols so that easily understood names can be set. Model copy function simplifies creation of a model memory with different fine setups.

- **Two function groups:** Frequently used functions / System functions

Frequently used functions can be easily called from the initial screen with Select Key (SEL).

- **Brake mixing for large cars (BMX)**

Brake mixing of the front and rear wheels of 1/5GP cars, etc. has balance adjustment functions.

- **Steering dual rate (D/R-ST)**

Steering angle can be adjusted with digital trim lever.

- **Anti-skid Braking System (ABS)**

This function applies the brakes so that the tires of gasoline engine cars, etc. do not lose their grip on the road even when braking at corners.

- **Throttle acceleration (ACC)**

Gasoline engine cars have a time lag before the clutch and brakes are connected. The ACC function minimizes this time lag.

- **Steering speed (SPD)**

When you sense that the steering servo is too fast, etc., the servo operating speed (direction that suppresses the maximum speed) can be adjusted.

- **Racing timer (TIMER)** : Up timer or Down timer can be selected.

A lap time can record 100 lap times and the total time. The timer can also be started automatically by trigger operation. The race time can be set.

- **Digital trim:** Steering trim, Throttle trim, Steering D/R

The current position is displayed on the LCD screen for about three seconds when each digital trim is operated.

- **Function select lever function (FNC-DT1/DT2/DT3/DT4)**

This function assigns a function to levers (digital trims, grip levers). Trim positioning at each model call is unnecessary because all the levers are digital.

**- Function select switch function (FNC-SW1/SW2)**

This function assigns a function to the two installed switches.

**- Condition 2 Selection**

In specific functions, two rates can be set up, and switched with SW1 switch simultaneously during a run.

**- NEW design considers operability and weight balance**

**- Tension adjustment function**

The wheel tension can be adjusted from the outside.

**- Trigger stopper function (Mechanical ATL)**

**- High luminosity blue LED pilot lamp**

You can select your desired brightness of the pilot lamp. (Four steps)



**Before Using**

## Set Contents

After opening the box, first check if the contents conform to the following. The contents depend on the set as shown below.

	3PM HRS system	3PM FM system		3PM Synthesizer system	
<b>Transmitter</b>	T3PM-FM			T3PM-FS	
<b>Receiver</b>	R203HF	R133F		R303FS	
<b>Servo</b>	-----	-----	S3003x2 or S3305x1	-----	S3003x2 or S3305x1
<b>Miscellaneous</b>	Receiver switch and Battery holder (w/servo set only) Servo mounting hardware and servo horns (w/servo set only) Instruction manual				

Before Using

- If any of the set contents are missing, or you have any questions, please contact the dealer where the unit was purchased.

### Caution

 In case of the High Response System (H.R.S) receiver R203HF, always use only the following conditions:

**Servo; 6V type Digital Servo only**  
**Power supply; 6V Nicd battery**  
**Transmitter setting; "HRS" mode**

If the conditions are different, control is impossible.

And **Fail Safe Unit (FSUI)** is not available.

### Caution

 Always use only genuine Futaba transmitter, receiver, FET amp, NiCd battery and other optional parts.

Futaba will not be responsible for damage caused by other than genuine Futaba parts and components. Use only the genuine Futaba parts and components listed in the instruction manual and catalog.

# Transmitter T3PM

## Nomenclature



Before Using



\*The switches and levers in the figure are shown in the initial setting position.

### Precautions when turning the power switch on and off.

When the data was changed using the edit keys or trim levers, wait at least two seconds before turning off the power. If the power is turned off within two seconds after the data was changed, the new data will not be written to memory.

## Digital Trim Operation

(Initial settings: DT1: Steering trim, DT2: Throttle trim)

Push the lever to the left or right (up or down).

The current position is displayed on the LCD screen for about three seconds when each digital trim is operated.

Before Using

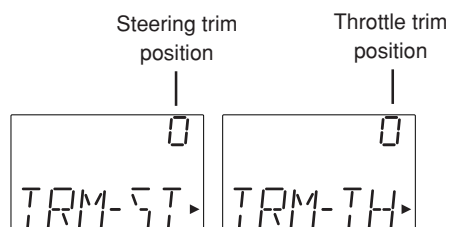
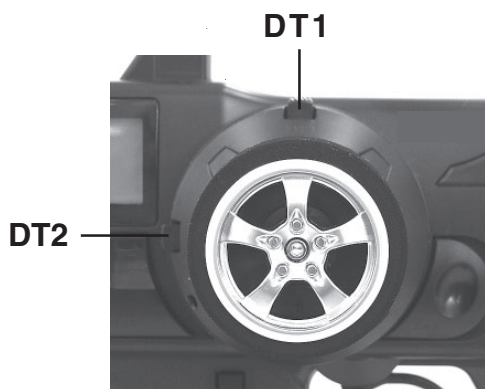

- Each step is indicated by a tone.
- When the trim exceeds the maximum trim adjustment range, the tone will change pitch and the lever will not move any farther.

### Trim Operation

With the digital trim feature, trim adjustments have no effect on the maximum servo travel. This prevents the linkages from binding when adjustments are made.

## Grip lever operation

(Initial settings: DT3=Steering D/R, DT4=Throttle ATL)

Push the lever to the left or right. The current set value is displayed on the LCD screen for about three seconds when each lever is operated.

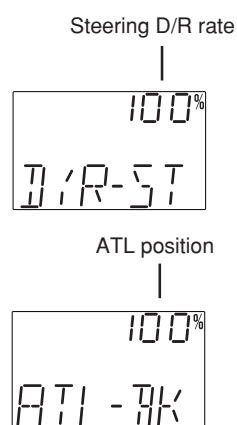
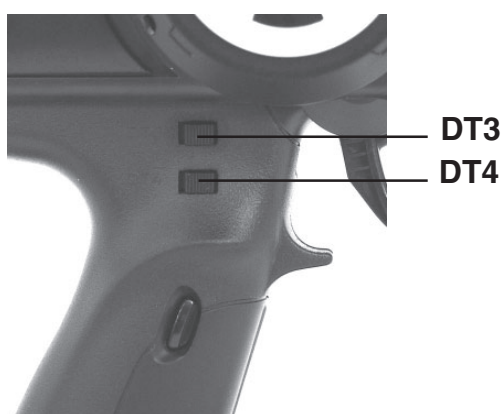

- A click sound is made at each step.
- When the maximum position is reached at each side, the tone of the click changes. Thereafter, the set value does not change.

## Mechanical ATL Adjustment

Make this adjustment when you want to make the throttle trigger brake (reverse) side stroke narrower.

### Adjustment

Using a Phillips screwdriver, adjust the trigger brake (reverse) side stroke by turning the screw through the adjusting hole indicated by the arrow in the figure. (The screw moves the throttle trigger stopper.)

- When the adjusting screw is turned clockwise, the stroke becomes narrower.

Mechanical ATL  
adjustingscrew

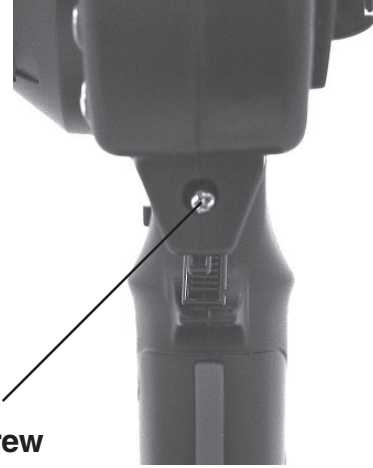

### Caution

When the stroke is adjusted, the throttle servo travel must be adjusted by data setting.

Before Using

## Wheel Tension Adjustment

Make this adjustment when you want to change the steering wheel spring tension.

### Adjustment

Turn the screw inside the adjusting hole using a Phillips screwdriver.

- Turning the adjusting screw clockwise increases the spring tension.

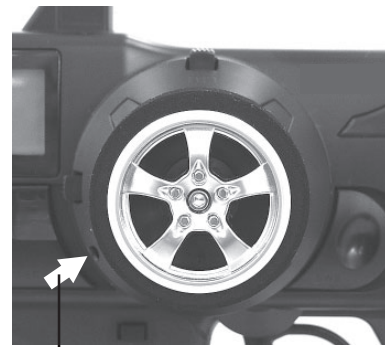

Tension adjusting screw

### Caution

If turned too far counterclockwise, the adjusting screw may fall out.



## Battery Replacement

### For dry cell battery system

Load the eight batteries in accordance with the polarity markings on the battery holder. (8 AA Size Batteries)

(Battery Replacement Method)

- 1 Remove the battery cover from the transmitter by sliding it in the direction of the arrow in the figure.
- 2 Remove the used batteries.
- 3 Load the new AA size batteries . Pay very close attention to the polarity markings and reinsert accordingly.
- 4 Slide the battery cover back onto the case.

Before Using

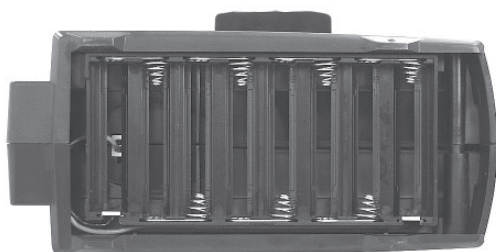

### Caution

! Always be sure you reinsert the batteries in the correct polarity order. If the batteries are loaded incorrectly, the transmitter may be damaged.

! When the transmitter will not be used for any short or long period of time, always remove the batteries. If the batteries do happen to leak, clean the battery case and contacts thoroughly. Make sure the contacts are free of corrosion.

### Check:

Turn the power switch on the transmitter to the ON position. Check the battery voltage display on the LCD screen.

If the voltage is low, check the batteries for insufficient contact in the case or incorrect battery polarity.

### Low Battery Alarm:

If the transmitter battery voltage drops below 8.5V an alarm will sound and "LOW BT" will be displayed on the LCD screen.

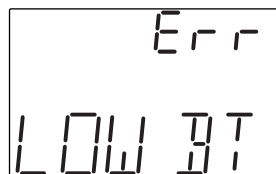

The low battery alarm is meant to be a safety feature only. Do NOT operate your radio below 9V. Always shut your radio off as soon as possible after the low battery warning tone to avoid loss of control.

## For NiCd battery system

The NiCd battery is connected by a connector so it can be easily removed when the transmitter is not being used for an extended amount of time.

- Always use an NT8F700B NiCd battery.

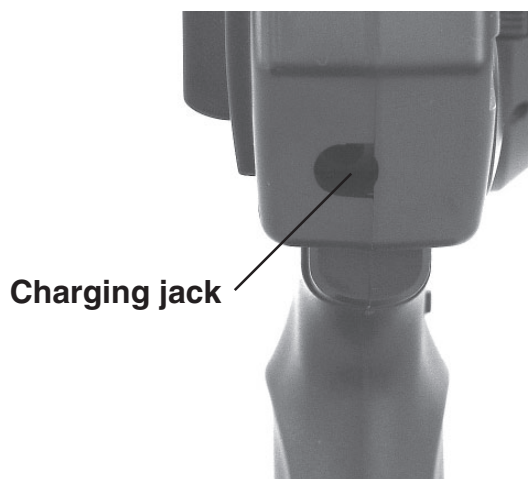

Before Using

## Charging the NiCd Battery

### Charging

1. Plug the transmitter cord of the special charger into the charging jack on the side of the transmitter.
2. Plug the charger into an AC outlet.
3. Check that the charging LED lights.

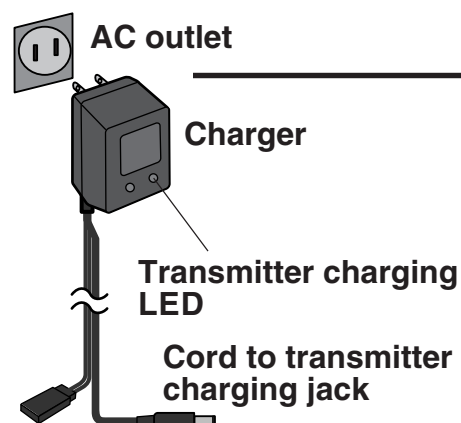

When charging the NT8F700B NiCd battery with the special charger, allow about 15 hours for charging. If the transmitter has not been used for some time, cycle the battery by charging and discharging it two or three times.

### Over current protection

The transmitter charging circuit is equipped with an over current protection circuits. If the battery is charged with a quick charger for other than digital proportional R/C sets, it may not be fully charged.

## Warning

Never plug it into an outlet other than indicated voltage.

Plugging the charger into the wrong outlet may result in an explosion, sparking, or fire.

Do not insert and remove the charger when your hands are wet.

It may cause an electric shock.

Always use the special charger or a quick charger for digital proportional R/C sets to charge a digital proportional R/C set NiCd battery.

Overcharging a NiCd battery can result in burns, fire, injuries, or loss of sight due to overheating, breakage, or electrolyte leakage.



Use the special charger.

## Caution

Never try to recharge a dry cell battery.

The transmitter may be damaged or the battery electrolyte may leak or the battery may break.

When the charger is not in use, disconnect it from the AC outlet.

Do this to prevent accidents and to avoid overheating.

## Set data backup

The set data of each function of the 3PM transmitter is stored in a memory element that does not require a backup battery. Therefore, the 3PM transmitter can be used without paying attention to the backup battery life.

## Receiver

### Nomenclature



When changing the frequency, use the specified Futaba crystal set.

**R133F**  
receiver

### Connectors

3: CH3 servo (CH3)  
2: Throttle servo (CH2)  
1: Steering servo (CH1)  
B/C: Power connector/DSC connector

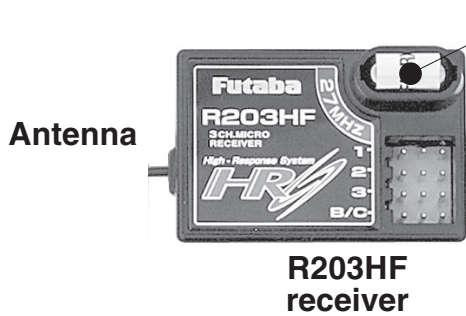

**Crystal**  
When changing the frequency, use the specified Futaba crystal set.

- Connectors**
- 1: Steering servo (CH1)
  - 2: Throttle servo (CH2)
  - 3: CH3 servo (CH3)
  - B/C: Power connector/DSC connector



- Connectors**
- 1: Steering servo (CH1)
  - 2: Throttle servo (CH2)
  - 3: CH3 servo (CH3)
  - B/C: Power connector/DSC connector

**Channel Selection**

When changing the frequency, adjust the two dials on R303FS.  
Refer to the channel - frequency table attached.

For the receiver, servos, and other connections, see page 22.

**Before Using**

**Servo**

**Nomenclature**

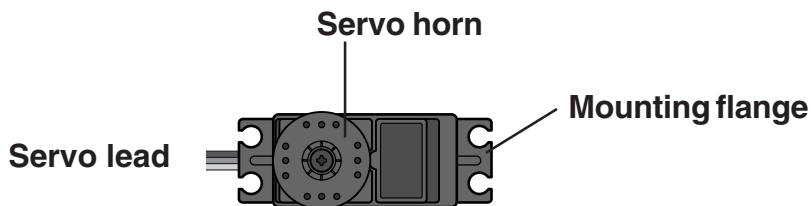

**<Accessory>**

- The following items are provided for setting:
- Spare servo horn
  - Parts for servo installation
- (For the installation precautions, see page 23.)

## Receiver and Servo Connections

When connecting and installing the receiver and servos, read the “Installation Safety Precautions” on the next page.

### Installation When An FET Amp Is Used (MC800CFET Amp)

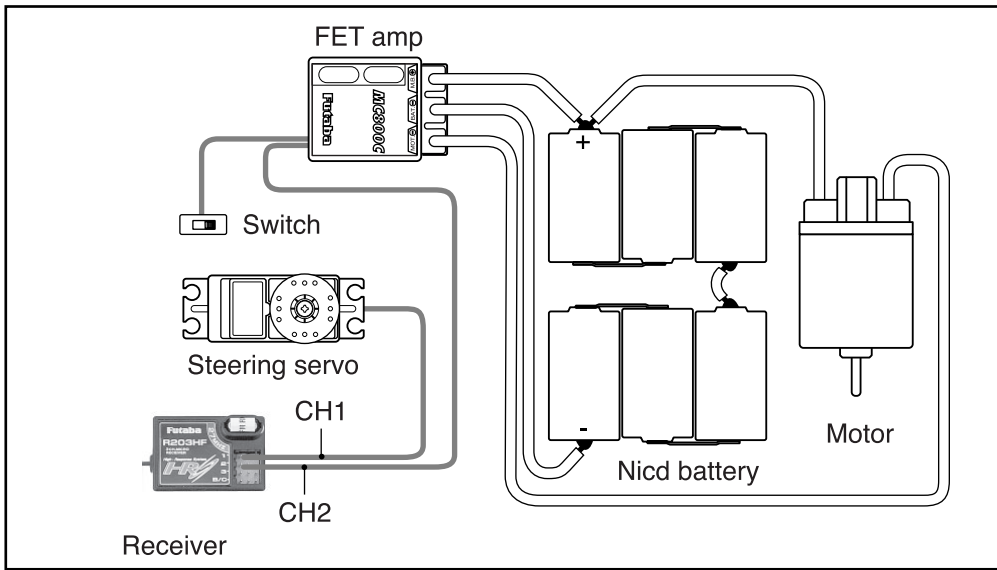

Installation

### Installation For Gas Powered Models

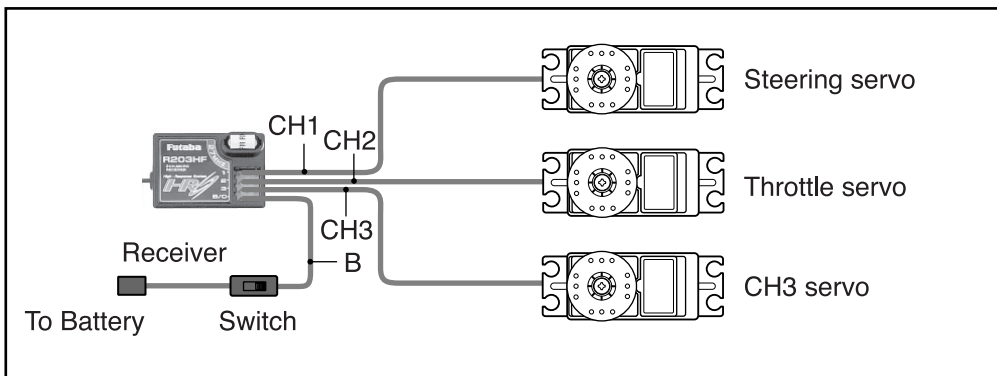

# Installation Safety Precautions

## Warning

### Connector Connections

-  Be sure the receiver, servo, crystal and connectors are fully and firmly connected.

If vibration from the model causes a connector to work loose while the model is in operation, you may lose control.

### Receiver Vibration Damping and Waterproofing

(Car)



-  Dampen the vibration to the receiver by mounting to the chassis or mounting plate with thick double sided tape in electric powered models. In gas powered models wrap the receiver in foam and mount it where the vibration is the least prevalent.

(Boat)

-  Dampen the vibration to the receiver by wrapping it in foam. Waterproof by placing it in a plastic bag or watertight the radio box in your model.

If the receiver is subjected to strong vibration or shock erratic or loss of control may occur. If any moisture comes in contact the receiver and servos you may experience the same result as well as damage to the system.

### Receiver Antenna

-  Do not cut or bundle the receiver antenna.
-  Do not bundle the receiver antenna together with the servo lead wires.
-  Keep the receiver antenna at least 1 inch away from the motor and battery and wires that handle heavy current loads.

Cutting, bundling or routing the receiver antenna near any device that produces noise will reduce the operating range of the system and result in loss of control.

\*Also route the receiver antenna away from metal, carbon fiber and other parts that conduct electricity. These parts can transmit high frequency noise.

### Electronic speed control

-  Install the heat sinks where they will not come in contact with aluminum, carbon fiber or other parts that conduct electricity.

If the FET Amp (Electronic speed control) heat sinks touch other materials that conduct electricity a short circuit could occur. This could result in loss of control and damage to the system.

### Servo Throw

-  Operate each servo over its full stroke and be sure the linkage does not bind or is loose.

The continuous application of unreasonable force to a servo may cause damage and excessive battery drain.

### Servo Installation

-  When you install the servos always use the rubber grommets provided in servo hardware bags. Mount the servos so they do not directly come in contact with the mount.

If the servo case comes in direct contact with the mount, vibration will be directly transmitted to the servo.

If this condition continues for a long time the servo may be damaged and control will be lost.

### Motor Noise Suppression

-  Always install capacitors to suppress noise when electric motors are used.

If capacitors are not properly installed you could experience erratic operation and reduced range as well as loss of control.

### Other Noise Suppression Methods

-  Be sure there are no metal parts in your model which under vibration could come in contact with other metal parts.

Metal to metal contacts under vibration will emit a high frequency noise that will affect the receiver's performance. You could experience erratic operation and reduced range as well as loss of control.

## Preparations (Transmitter)

Before setting the transmitter functions, check and set items 1 to 2 below.

**(Display when power switch is turned on)**

Turn on the transmitter power.

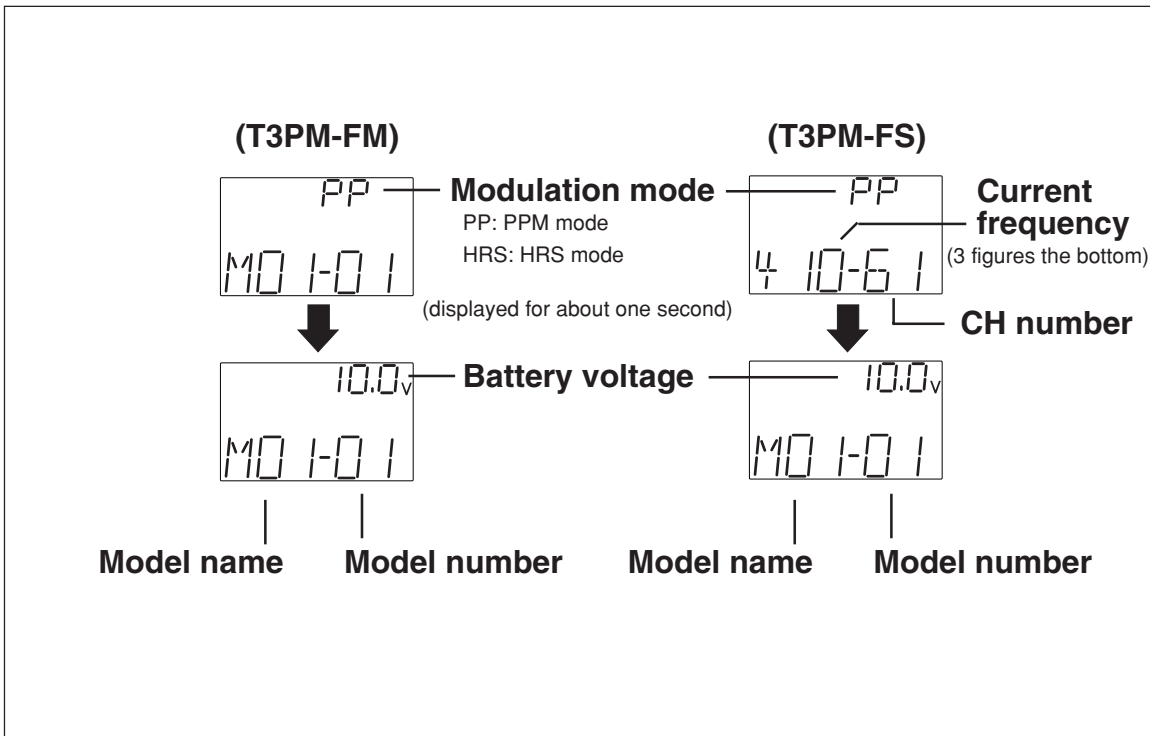

Initial Set-Up

### 1. Model Number Check

When the power switch is turned on, the current selected model number is displayed. Check if this number is the model number you want to set-up. To change the model number, use the Model Select function (page48).

## 2. Modulation Mode Check

The T3PM transmitter output signal format can be changed to match the type of receiver. Check if the modulation mode is set to match the receiver used.

When using an FM receiver (e.g., R133F, R303FS), the modulation mode must be set to "PP" (PPM). When using a H.R.S receiver (e.g., R203HF), the modulation mode must be set to "HrS" (HRS). If this setting is incorrect, change it with the HRS/PPM Select function (page53).

## 3. Trims Initial Set-Up

### - Steering trim (DT1) check

At initial set-up, steering trim is assigned to digital trim DT1 above the steering wheel. Operate the DT1 lever and check if the steering trim value on the screen changes. After checking the trim, set the trim value to the center (0) position.

Steering trim position

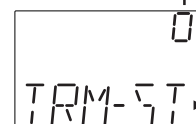

### - Throttle trim (DT2) check

At initial set-up, throttle trim is assigned to digital trim DT2 at the left side of the steering wheel. Operate the DT2 lever and check if the throttle trim value on the screen changes. After checking the trim, set the trim value to the center (0) position.

Throttle trim position

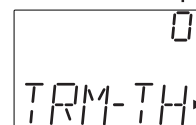

Initial Set-Up

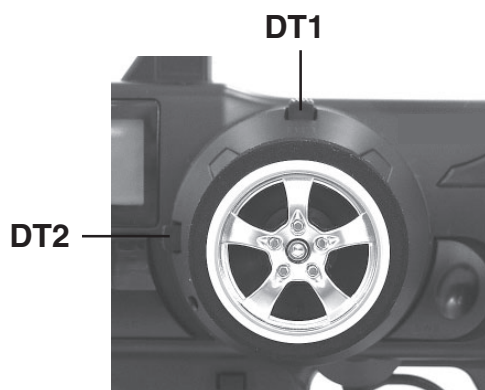



### - Steering dual rate (DT3) check

At initial set-up, steering dual rate is assigned to grip lever DT3 (upper) at the grip of the transmitter. Operate the DT3 lever and check if the D/R value displayed on the screen changes. After checking D/R, set the steering dual rate to 100%.

Steering D/R  
value

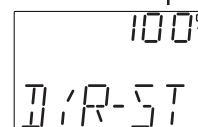

### - Throttle ATL (DT4) check

At initial setting, throttle ATL is assigned to grip lever DT4 (lower) at the grip of the transmitter. Operate the DT4 lever and check if the ATL value displayed on the screen changes. After checking ATL, set throttle ATL to 100%.

Throttle ATL  
position

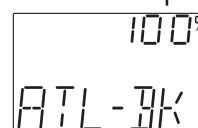

Initial Set-Up



## (Set-Up Procedure When Installed In a Car)

When installing the servos in a car, performing function set-up in the following order is recommended.

1. Set up the servo trims (page 23).
2. Set the servo direction of operation using the Reverse function. (Page47)  
The servo installation method and linkage direction depend on the kit. Therefore, the servo operation direction may have to be reversed relative to transmitter operation. Before installing the servo, check the operating direction and set it using the Reverse function.
3. Set the subtrim and adjust the servo neutral point. (Page46)
4. Set the trigger travel by adjusting the throttle trigger mechanical ATL to your liking. (Page17)
5. Set EPA of each channel and adjust the servo throw (travel). (Pages30)

Initial Set-Up

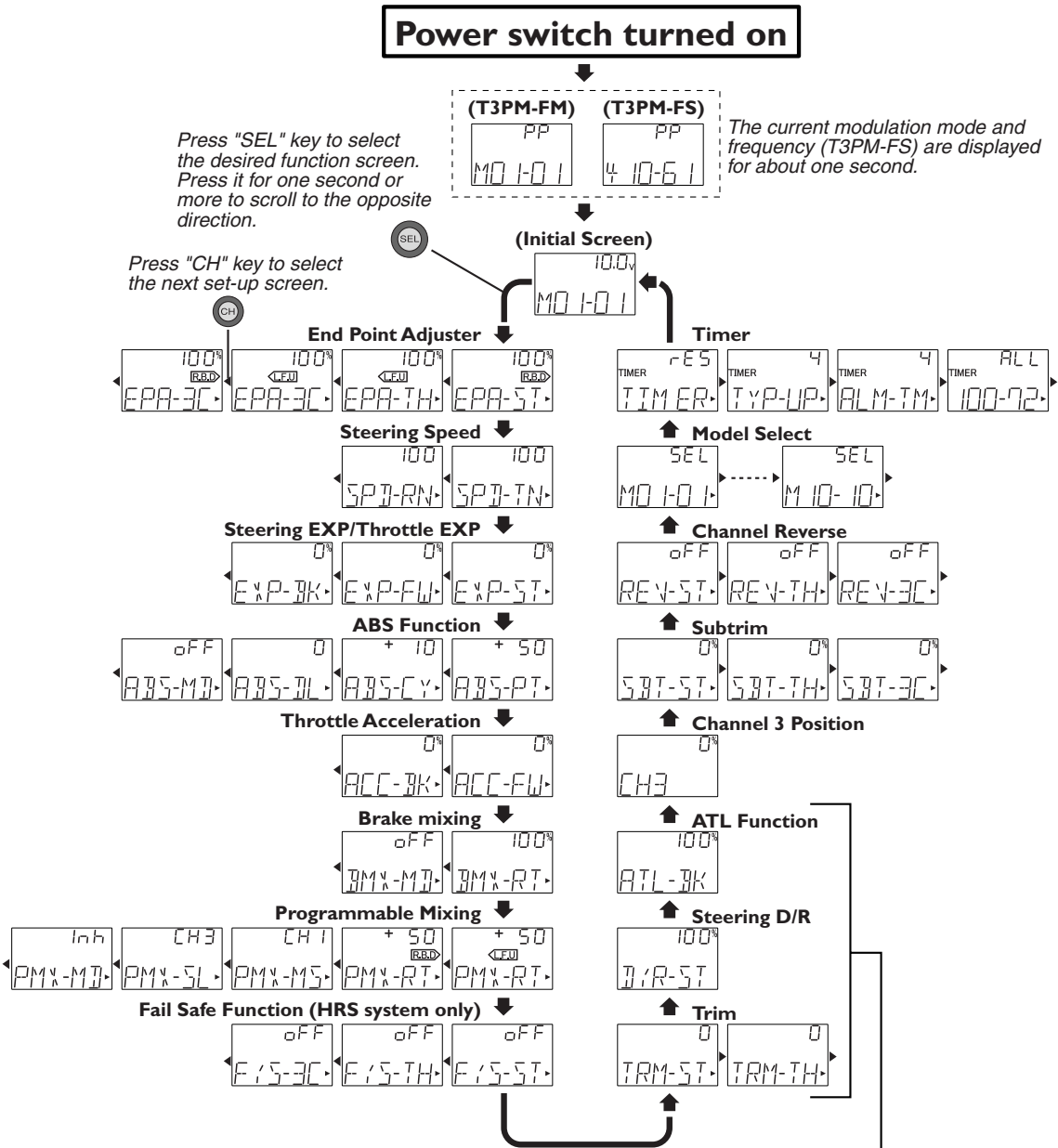

**Digital trim DT1 - DT4 display**  
 The current position is displayed on the LCD screen for about two seconds when each digital trim is operated.

## System Functions

Turn on the power switch while pressing "SEL" key.

Press "SEL" key to select the desired function screen. Press it for one second or more to scroll to the opposite direction.

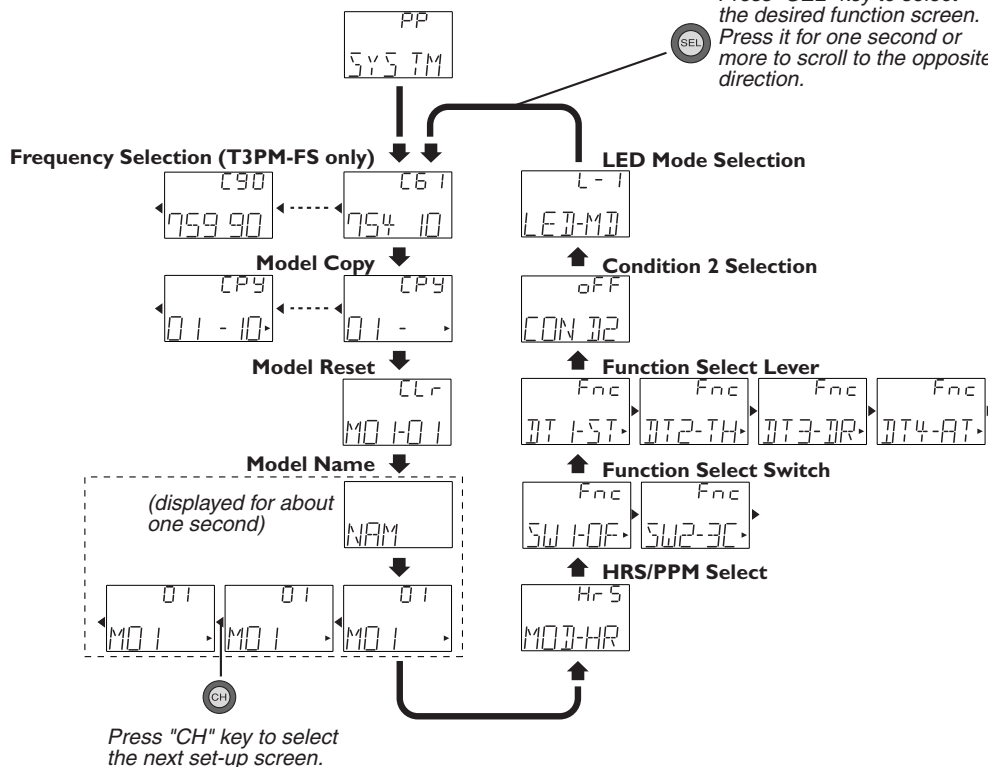

Function Map

## End point adjuster/EPA

Use this when performing left and right steering angle adjustments, throttle high side/brake side operation amount adjustment, and channel 3 servo up side/down side operation amount adjustment during linkage.

- Corrects the maximum steering angle and left and right steering angles when there is a difference in the turning radius due to the characteristics, etc. of the vehicle.

### Maximum steering angle

The EPA function basically determines the maximum steering angle of each channel. The functions shown below may have been adjusted, or the operating range set by EPA function may be exceeded. Check the linkage each time the following functions are adjusted.

- Sub trim (all channels)
- Throttle Acceleration (Brake side)
- Brake mixing rate
- Program mixing slave side (all channels)

### ATL trim

ATL trim allows adjustment of the brake side operation amount during operation. Therefore, when the operating angle is adjusted with throttle EPA, ATL trim must also be taken into account.

## Warning

- ! Make sure that the knuckle stopper is not contacted during steering operation and that unreasonable force is not applied to the servo during other channel operation.

If unreasonable force is applied to the servo horn at the knuckle stopper during steering operation, the servo may malfunction and the model may run out of control.



Decide the EPA value at the contact point.

### Calling the setup screen

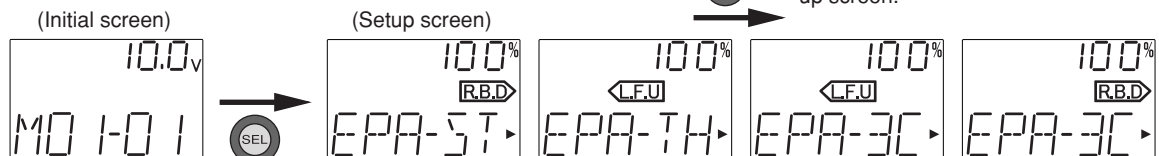

Press "SEL" key to select the desired function screen.

#### Setup items

- ST-L.F.U : Steering (left side)
- ST-R.B.D : Steering (right side)
- TH-L.F.U : Throttle (forward side)
- TH-R.B.D : Throttle (brake side)
- 3C-L.F.U : 3rd channel (up side)
- 3C-R.B.D : 3rd channel (down side)

#### Adjustment range

0~120% (each channel, each direction)

#### Adjustment buttons

- Use the (+) and (-) keys to make adjustments.
- Return to the initial value by pressing the (+) and (-) buttons simultaneously (approx. 1 sec).

## Steering (EPA) adjustment

(Preparation)

- Before setting up the steering wheel EPA, set the steering D/R lever (initial setup: DT3) to the maximum steering angle position 100%.
- Select setup item "ST" and make the following adjustments:

### 1 Steering (left side) adjustment

Turn the steering wheel fully to the left and use the (+) and (-) buttons to adjust the steering angle.

### 2 Steering (right side) adjustment

Turn the steering wheel fully to the right and use the (+) and (-) buttons to adjust the steering angle.

- 3** When adjusting the EPA of another channel immediately after this, see the adjustment method for that channel. When ending adjustment, return to the initial screen by pressing the (SEL) button.

## Throttle (EPA) adjustment

(Preparation)

- Before setting the throttle EPA, set the throttle ATL lever (initial setup: DT4) to the maximum steering angle position 100%.
- Select setup item "TH" and make the following adjustments:

### 1 Throttle (forward side) adjustment

Pull the throttle trigger fully to the high side and use the (+) and (-) buttons to adjust the steering angle. However, when using an FET amp, set to 100%.

## **2** Throttle (brake side/reverse side) adjustment

Push the throttle trigger fully to the brake side and use the (+) and (-) buttons to adjust the steering angle. However, when using an FET amp, set to 100%.

**3** When adjusting the EPA of another channel immediately after this, see the adjustment method for that channel. When ending adjustment, return to the initial screen by pressing the (SEL) button.

### **3rd channel servo (EPA) adjustment**

(Preparation)

- Select setup item "3C-L.F.U" and make the following adjustments:

(3rd channel initial setup: SW2)

#### **1** 3rd channel servo (up side) adjustment

Use the (+) and (-) buttons to adjust the steering angle.

#### **2** 3rd channel servo (down side) adjustment

Select setup item "3C-R.B.D" and use the (+) and (-) buttons to adjust the steering angle.

**3** When adjusting the EPA of another channel immediately after this, see the adjustment method for that channel. When ending adjustment, return to the initial screen by pressing the (SEL) button.

# Steering Speed/SPD

Quick steering operation will cause momentary understeering, loss of speed, or spinning. This function is effective in such cases.

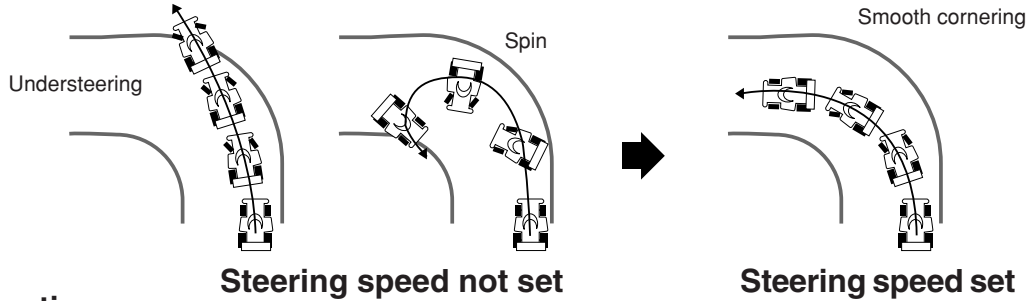

## Operation

- This function limits the maximum speed of the steering servo. (Delay function)
- The steering speed when the steering wheel is operated (TN direction) and returned (RN direction) can be independently set.
- If the steering wheel is turned slower than the set speed, the steering servo is not affected.

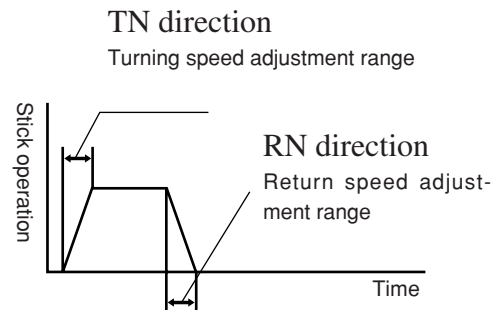

## Calling the setup screen

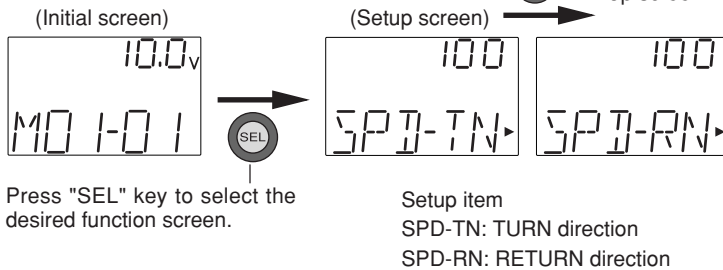

Press "SEL" key to select the desired function screen.

Setup item  
 SPD-TN: TURN direction  
 SPD-RN: RETURN direction

Press "CH" key to select the next set-up screen.

- Adjustment range  
 0~100% (each direction)  
 Adjustment buttons  
 - Use the (+) and (-) buttons to make adjustments.  
 - Return to the initial value by pressing the (+) and (-) buttons simultaneously (approx. 1 sec).

## Steering Speed (SPD) adjustment

(Preparation)

- Select setup item "SPD-TN" and make the following adjustments:

### 1 "TN" direction adjustment

Use the (+) and (-) buttons to adjust the delay amount.

### 2 "RN" direction adjustment

Select setup item "SPD-RN" and use the (+) and (-) buttons to adjust the delay amount.

### 3 When ending adjustment, return to the initial screen by pressing the (SEL) button.

Setting range: 1~100%  
 At 100%, there is no delay.  
 At 1%, the delay is approximately 1.5 seconds.

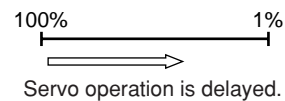



## Steering EXP, Throttle EXP / EXP

This function is used to change the sensitivity of the steering servo around the neutral position and makes throttle trigger high side and brake side direction servo operation quicker or milder. It has no effect on the maximum servo travel.

### Racers Tip

When the setting is not determined, or the characteristics of the model are unknown, start with 0%. (When EXP is set to 0%, servo movement is linear.)

### Advice (Throttle EXP)

When the course conditions are good and there is no sense of torque at the power unit, set each curve to the + side (quick side). When the road surface is slippery and the drive wheels do not grip it, set each curve to the - minus (mild) side.

#### Calling the setup screen

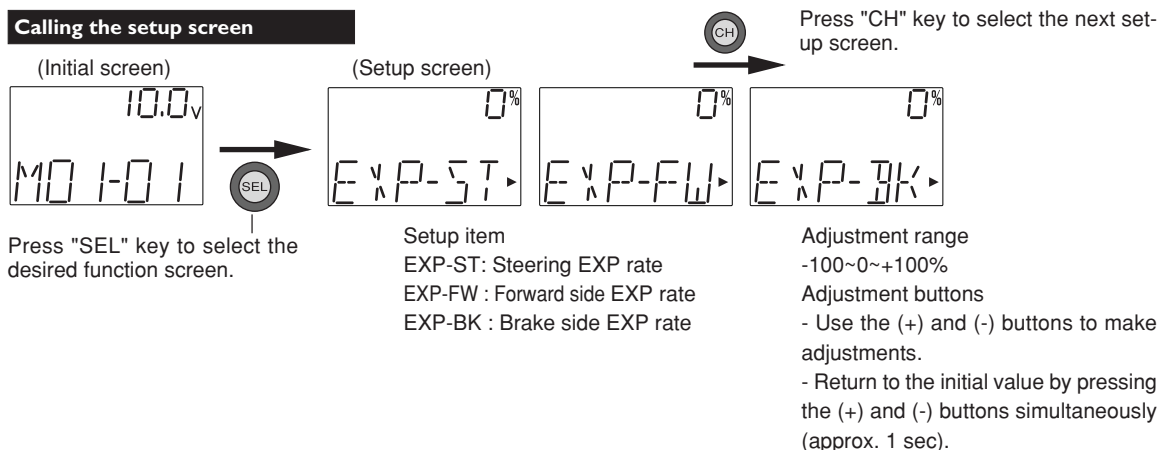

### Steering EXP adjustment

(Preparation)

- Select setup item "EXP-ST" and make the following adjustments:

- 1 When you want to quicken steering operation, use the (+) button to adjust the + side. When you want to make steering operation milder, use the (-) button to adjust the - side.
- 2 When adjusting the EXP rates of another channel immediately after this, see the adjustment method for that channel. When ending adjustment, return to the initial screen by pressing the (SEL) button.

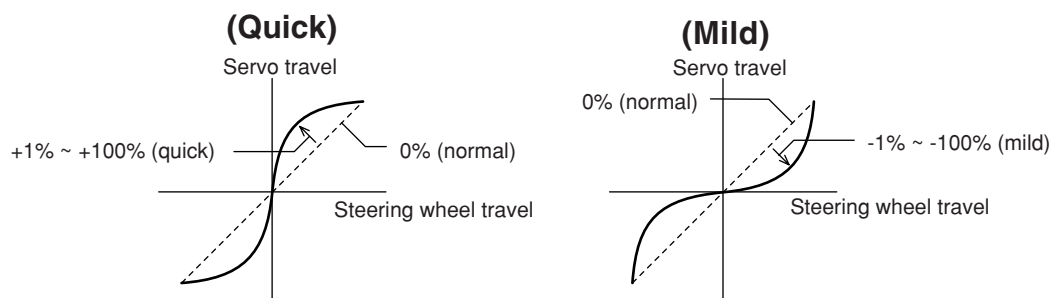

## Throttle EXP Adjustment

(Preparation)

- Select setup item "EXP-FW" and make the following adjustments:

### 1 Forward side adjustment

Use the (+) button to adjust the + side when you want to quicken the rise and use the (-) button to adjust the - side when you want to make the rise milder.

### 2 Brake side adjustment

Select setup item "EXP-BK" and use the (+) button to adjust the + side when you want to quicken the rise and use the (-) button to adjust the - side when you want to make the rise milder.

**3** When adjusting the EXP rates of another channel immediately after this, see the adjustment method for that channel. When ending adjustment, return to the initial screen by pressing the (SEL) button.

## A.B.S. Function

When the brakes are applied while cornering with a 4 Wheel Drive or other type of vehicle, understeer may occur. The generation of understeer can be eliminated and corners can be smoothly cleared by using this function.

### Operation

- When the brakes are applied, the throttle servo will pulse intermittently. This will have the same effect as pumping the brakes in a full size car.
- The brake return amount, pumping cycle, and delay amount can be adjusted.

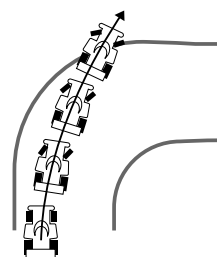

Without A.B.S.  
With A.B.S.

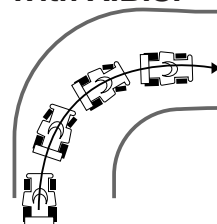

### Operation Display

When the A.B.S. function is activated, the LED flashes.

### Fail Safe Unit

When the 3PM is used with the Futaba fail safe unit (FSU-1), it will operate as described below.

- When the FSU-1 is connected to the throttle channel, and the A.B.S. function has been activated, the FSU-1 LED will flash each time the servo operates. The reason for this is that the FSU-1 responds to sudden data changes caused by A.B.S. function pumping operation. It does not mean that the fail safe function is activated. The servo will not be affected.

### Calling the setup screen

(Initial screen)



Press "SEL" key to select the desired function screen.

(Setup screen)

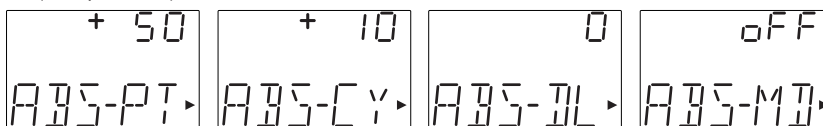

Press "CH" key to select the next set-up screen.

#### Setup items

- ABS-PT : Brake return amount
- ABS-CY : Cycle speed
- ABS-DL : Delay amount
- ABS-MD : Function ON/Off

#### Adjustment buttons

- Use the (+) and (-) buttons to make adjustments.
- Return to the initial value by pressing the (+) and (-) buttons simultaneously (approx. 1 sec).

#### Brake return amount:

- 0 ~ 50 ~ 100
- Initial value; 50
- Cycle speed:
- 1~ 30
- Initial value; 10
- Delay amount:
- 0 ~ 100
- Initial value; 0

## A.B.S function adjustment

(Preparation)

- Select setup item "ABS-MD" and make the following adjustments:

### 1 (Function ON/OFF)

Set the function to the active state by pressing the (+) or (-) button.

OFF : Function OFF

ON : Function ON

### 2 (Brake return amount adjustment)

Select setup item "ABS-PT" and use the (+) and (-) buttons to adjust the return amount.

"0" : No return

"50" : Return to the 50% position of the brake operation amount

"100" : Return to the neutral position.

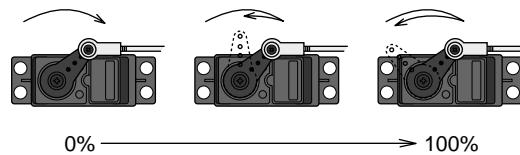

### 3 (Cycle speed adjustment)

Select setup item "ABS-CY" and use the (+) and (-) buttons to adjust the speed.

- The lower the set value, the faster the cycle speed.

### 4 (Delay amount setup)

Select setup item "ABS-DL" and use the (+) and (-) buttons to adjust the delay amount.

"0" : A.B.S. function performed without any delay

"50" : A.B.S function performed after an approximate 0.7 sec delay.

"100" : A.B.S. function performed after an approximate 1.4 secs delay.

5 When ending adjustment, return to the initial screen by pressing the (SEL) button.

## Throttle acceleration / ACC

Gasoline engine cars have a small time lag at both the forward side and brake side because a certain clearance is necessary at the linkage. Reducing this time lag at the transmitter side provides the same sharp response as electric motor cars.

A slight clearance is required at the linkage, but the throttle acceleration function acts to reduce the time lag caused by this clearance.

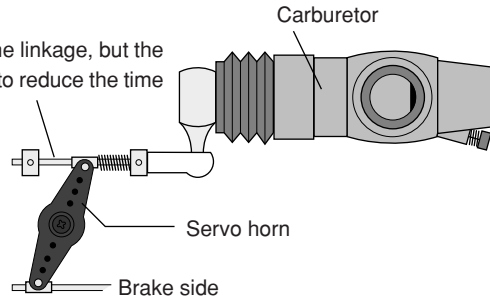

### Operation

- Operation near the throttle trigger neutral position becomes a sharp rise.
- The forward and brake sides can be set separately.

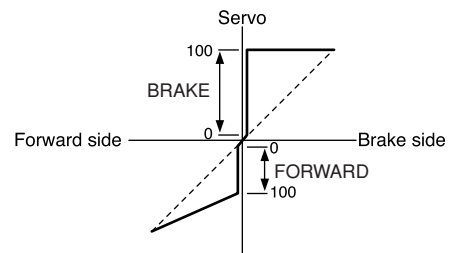

### Set value

The standard value (100% point) of this setup effects the operation amount set by throttle EPA function.

#### Calling the setup screen

(Initial screen)



Press "SEL" key to select the desired function screen.

(Setup screen)

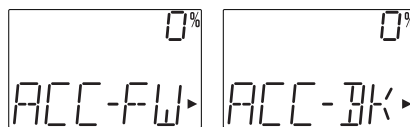

Setup items

ACC-FW : Forward side acceleration amount

ACC-BK : Brake side acceleration amount

Press "CH" key to select the next set-up screen.

Forward acceleration amount

0~100

Initial value: 0

Brake side acceleration amount

0~100

Initial value: 0

Adjustment buttons

- Use the (+) and (-) buttons to make adjustments.

- Press the (+) and (-) buttons simultaneously (approx. 1 sec) to return to the initial screen.

## Throttle acceleration adjustment

(Preparation)

- Select setup item "ACC-FW" and make the following adjustments.

### 1 (Forward acceleration amount adjustment)

Use the (+) and (-) buttons to adjust the acceleration amount.

"0": No acceleration

"100": Maximum acceleration (Approximately 1/2 of the forward side steering angle)

### 2 (Brake side acceleration amount adjustment)

Select setup item "ACC-BK" and use the (+) and (-) buttons to adjust the acceleration amount.

"0": No acceleration

"100": Maximum acceleration (Brake side maximum steering angle)

### 3 When ending adjustment, return to the initial screen by pressing the (SEL) button.

## Brake mixing / BMX

Use this mixing when the front and rear brakes must be adjusted independently such as 1/5GP cars, etc. This mixing uses the 2nd channel to control the rear brakes and the 3rd channel to control the front brakes.

### Operation

- When braking, mixing is applied to 2nd channel to 3rd channel.
- Mixing rate setting are possible.
- The set value of A.B.S. functions is reflected.

#### Calling the setup screen

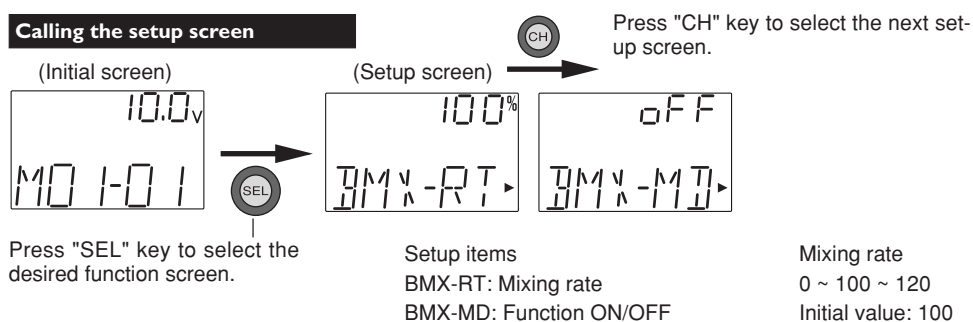

Adjustment buttons

- Use the (+) and (-) buttons to make adjustments.
- Press the (+) and (-) buttons simultaneously (approx. 1 sec) to return to the initial screen.

### Brake mixing adjustment

(Preparation)

- Select setup item "BMXMD" and make the following adjustments.

#### 1 (Function ON/OFF)

Set the function to the "ON" state by pressing the (+) or (-) button.

OFF: Function OFF  
ON: Function ON

#### 2 (Mixing amount adjustment)

Select setup item "BMX-RT" and use the (+) and (-) buttons to adjust the mixing amount.

- Mixing amount can be adjusted within the 0~120% range.

#### 3 When ending adjustment, return to the initial screen by pressing the (SEL) button.

## Programmable Mixing / PMX

This function allows you to apply mixing between the steering, throttle, and channel 3 channels.

### Calling the setup screen

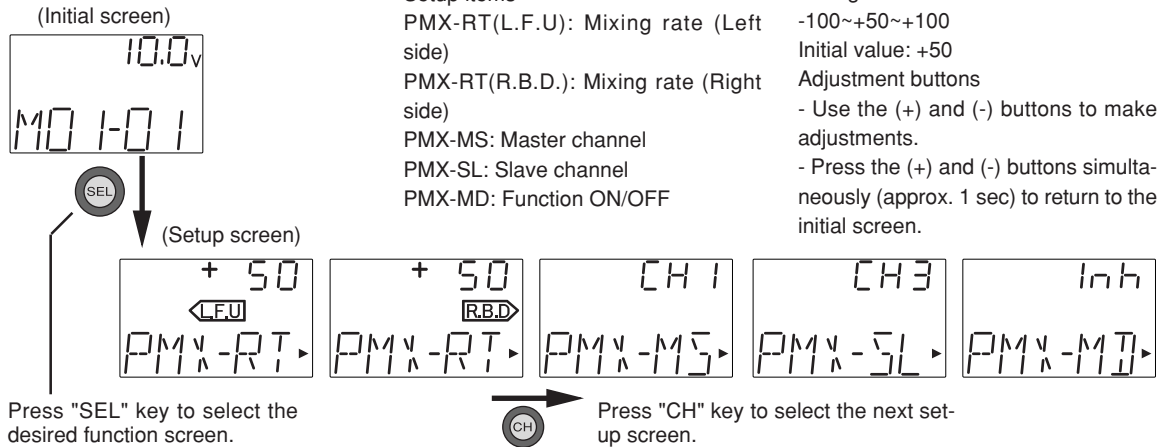

#### Setup items

PMX-RT(L.F.U): Mixing rate (Left side)  
 PMX-RT(R.B.D.): Mixing rate (Right side)  
 PMX-MS: Master channel  
 PMX-SL: Slave channel  
 PMX-MD: Function ON/OFF

#### Mixing amount

-100~+50~+100  
 Initial value: +50  
 Adjustment buttons  
 - Use the (+) and (-) buttons to make adjustments.  
 - Press the (+) and (-) buttons simultaneously (approx. 1 sec) to return to the initial screen.

### Program mixing adjustment

(Preparation)

- Use the function select switch function (page??) to select the switch. (as desired)
- Select setup item "PMX-MD" and make the following adjustments.

#### 1 (Function ON/OFF)

Set the function to the "ON" state by pressing the (+) or (-) button.

"INH": Function OFF, "ON": Function ON, "OFF": Switch OFF

#### 2 (Master channel)

Select setup item "PMX-MS" and select the master channel by pressing the (+) or (-) button.

#### 3 (Slave channel)

Select setup item "PMX-SL" and select the slave channel by pressing the (+) or (-) button.

#### 4 (Mixing amount adjustment)---upper item

Select setup item "PMX-RT(L.F.U)" and use the (+) and (-) buttons to adjust the mixing amount.

#### 5 (Mixing amount adjustment)---lower item

Select setup item "PMX-RT(R.B.D)" and use the (+) and (-) buttons to adjust the mixing amount.

#### 6 When ending adjustment, return to the initial screen by pressing the (SEL) button.



## Fail safe function/FAIL SAFE

(This function can only be used with HRS system receivers.)

### Fail safe function

This function moves the steering, throttle and channel 3 servos to a preset position when the receiver cannot receive the signal from the transmitter for some reason. When the servo operation position is not set, this function operates so that the servos remain in the position they were in immediately before reception was lost. When the signal from the transmitter can be received again, this function automatically resets.

- For gasoline engine cars, it is recommended that the throttle channel be set to the direction that applies the brakes.
- When the transmitter power is turned on, the transmitter transfers the fail safe data to the receiver and continues to transfer the data every minute thereafter. Note that data for about 1 minute after the receiver power is turned on is not transferred because usually, the transmitter power is turned on first and the receiver power is turned on next.

### Battery fail safe function

When the receiver battery voltage drops to a certain voltage or less, this function moves the throttle servo to the position set by fail safe function. When the voltage recovers, this function automatically resets.

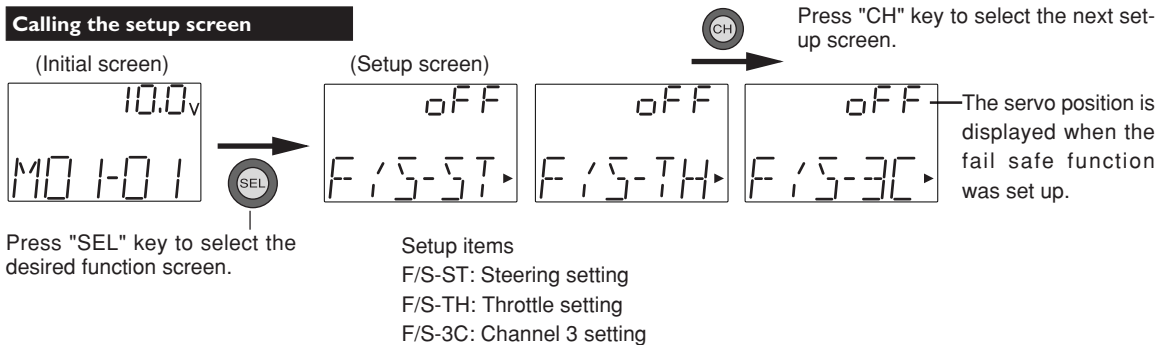

## Fail safe function setup

(Preparation)

- Select the desired channel setup item and make the following adjustments.

### 1 (Servo position setup)

When the fail safe function operates, the steering wheel, the throttle trigger or channel 3 lever remains in the desired operation position. When the (+) and (-) buttons are pressed simultaneously for about 1 second, the servo position is displayed and you can confirm that the function was set.

When you want to release the setting, press the (+) or (-) button. "OFF" is displayed.

(Each channel can be set similarly.)

### 2 When ending adjustment, return to the initial screen by pressing the (SEL).

## Steering Trim, Throttle Trim / TRM

Steering neutral adjustments and throttle neutral adjustments during a run can be made by moving the trim lever to the left or right (the up or down). This setting is linked to transmitter digital trim lever DT1 and DT2. When DT1 or DT2 is assigned to another function, set the trim function with this screen.

### When Trim usage is extreme

If it takes most of your trim movement to get a servo to the neutral position, reposition the servo horn or servo saver on the servo and inspect your linkage installation.

**Calling the setup screen**

(Initial screen) (Setup screen)

Press "SEL" key to select the desired function screen. Press "CH" key to select the next set-up screen.

Trim position  
L.F.U 100% ~ 0 ~ R.B.D 100%  
Initial value: 0%

Adjustment buttons  
- Use the (+) and (-) buttons to make adjustments.  
- Press the (+) and (-) buttons simultaneously (approx. 1 sec) to return to the initial screen.

Setup Item  
TRM-ST: Steering trim position  
TRM-TH: Throttle trim position

### Trim adjustment

(Preparation)

- Select the desired setup item and make the following adjustments.

#### 1 (Position adjustment)

Use the (+) and (-) buttons to adjust the trim position.

- This position is linked with the digital trim (DT1 or DT2).

**2** When ending adjustment, return to the initial screen by pressing the (SEL) button.

## Steering Dual Rate / D/R-ST

When the steering angle is too small at under steering at corners while running, increase the rate and when the steering angle is too large at over steering, decrease the rate. The setup here is linked with transmitter grip lever DT3. Adjustments can be made at this screen even if DT3 is assigned to another function.

### Operation

- The steering servo left and right steering angles are adjusted simultaneously.

#### Calling the setup screen

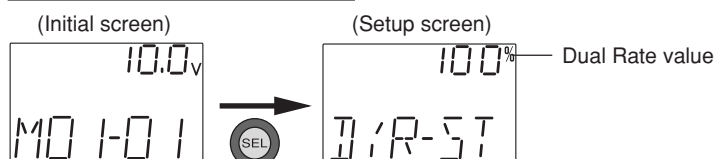

Press "SEL" key to select the desired function screen.

Setup Item  
D/R: Steering D/R value

D/R value  
0 ~ 100%

Initial value: 100%

When Dual Rate lever is operated, the "D/R-ST" screen is displayed automatically for about three seconds.

#### Adjustment buttons

- Use the (+) and (-) buttons to make adjustments.  
- Press the (+) and (-) buttons simultaneously (approx. 1 sec) to return to the initial screen.

### Steering D/R adjustment

#### 1 (D/R value adjustment)

Use the (+) and (-) buttons to adjust the D/R value.

- This position is linked with the grip lever (DT3).

#### 2 When ending adjustment, return to the initial screen by pressing the (SEL) button.

## Throttle ATL Function / ATL-BK

This function adjusts the - side when the braking effect is strong and the + side when the braking effect is weak. This setting is linked to transmitter grip lever DT4. When DT4 is assigned to another function, set the ATL function with this screen.

### Operation

The throttle brake side (when the throttle trigger is pushed forward) brake amount can be adjusted.

#### Calling the setup screen

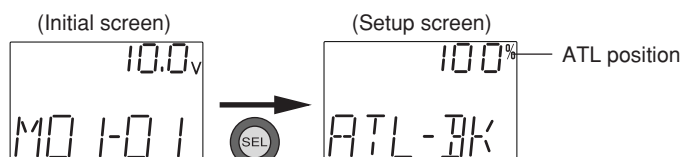

Press "SEL" key to select the desired function screen.

When ATL lever is operated, the "ATL-BK" screen is displayed automatically for about three seconds.

Setup Item  
 ATL-BK: Throttle ATL position  
 ATL position  
 0 ~ 100%  
 Initial value: 100%

Adjustment buttons  
 - Use the (+) and (-) buttons to make adjustments.  
 - Press the (+) and (-) buttons simultaneously (approx. 1 sec) to return to the initial screen.

## Throttle ATL adjustment

### 1 (ATL position adjustment)

Use the (+) and (-) buttons to adjust the ATL position.

- This position is linked with the grip lever (DT4).

### 2 When ending adjustment, return to the initial screen by pressing the (SEL) button.

## Channel 3 Position / CH3

Use this function to set the servo position of the channel 3.

This setting is linked to transmitter switch (SW2). When the switch is assigned to another function, set the channel 3 position with this screen.

### Calling the setup screen

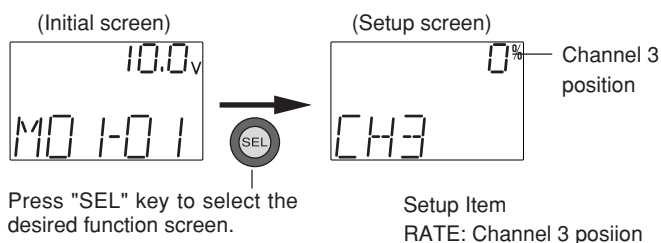

When channel 3 switch is operated, the "CH3" screen is displayed automatically for about three seconds.

Channel 3 position  
 L.F.U 100% ~ 0 ~ R.B.D 100%  
 Initial value: 0%

## Channel 3 adjustment

(Preparation)

- Select setup item "CH3" and make the following adjustments.

### 1 (Position adjustment)

Use the (+) and (-) buttons to adjust the channel 3 position.

- This position is linked with the switch (SW2).

### 2 When ending adjustment, return to the initial screen by pressing the (SEL) button.

Adjustment buttons  
 - Use the (+) and (-) buttons to make adjustments.  
 - Press the (+) and (-) buttons simultaneously (approx. 1 sec) to return to the initial screen.

Functions

## Subtrim / SBT

Use this function to adjust the neutral position of the steering, throttle and channel 3 servos.

Subtrim shifts the entire servo travel range in the set direction.

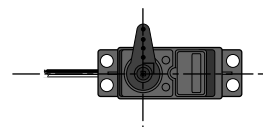

Use to adjust the neutral position

### Calling the setup screen

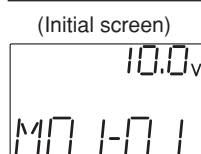

Press "SEL" key to select the desired function screen.

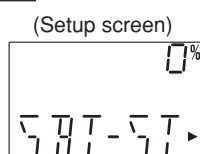

Setup Item  
 SBT-ST : Steering  
 SBT-TH : Throttle  
 SBT-3C : Channel 3



Press "CH" key to select the next set-up screen.

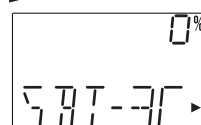
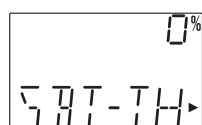

Subtrim position  
 L.F.U 100% ~ 0 ~ R.B.D 100%  
 Initial value: 0%

#### Adjustment buttons

- Use the (+) and (-) buttons to make adjustments.
- Press the (+) and (-) buttons simultaneously (approx. 1 sec) to return to the initial screen.

## Subtrim adjustment

(Preparation)

-Set the steering and throttle digital trims to the neutral "0" position. Set CH3 to the center "0" position.

- Preselect setup channel "ST", "TH", or "3C".

### 1 (Subtrim adjustment)

Use the (+) or (-) button to adjust the center.

(Each channel can be set similarly.)

**2** When ending adjustment, return to the initial screen by pressing the (SEL) button.

## Servo Reverse / REV

This function reverses the direction of operation of the servos related to transmitter steering, throttle, and channel 3 operation.

However, when the position set by trim or subtrim shifts from the center, the center becomes the opposite side.

### Calling the setup screen

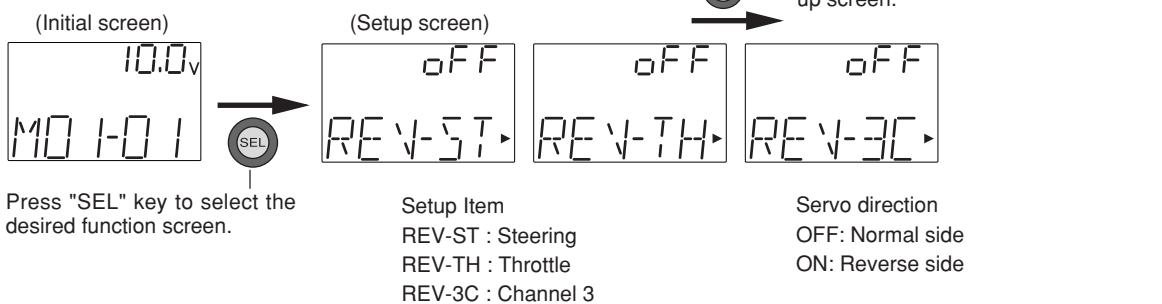

### Servo Reverse Function Setting

(Preparation)

- Preselect setup channel "ST", "TH", or "3C".

#### 1 (Servo reverse setting)

Use the (+) or (-) button to reverse the servo operation direction.

(Each channel can be set similarly.)

**2** When ending adjustment, return to the initial screen by pressing the (SEL) button.

## Model Select / SEL

Use this function to call a new model number, or to change a set model number, to set new model data. The T3PM transmitter can store the model data for ten R/C cars.

### Calling model memories of different modulation modes (HRS, PPM)

After the new model is called, signals are still output in the old model modulation mode until the transmitter power is turned off. Before using the new modulation mode, turn the power off and on. (See page 53 for the HRS/PPM mode selection.)

#### Calling the setup screen

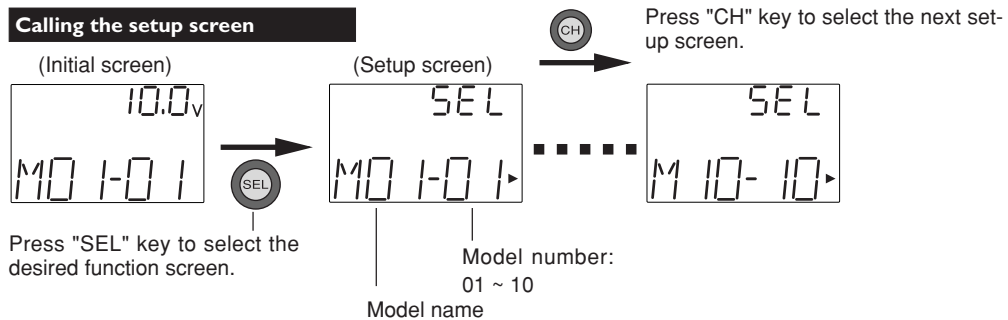

### Model Select

#### 1 (Model No. selection)

Use the (CH) button to select the model No.

#### 2 (Select execution)

Press the (+) and (-) buttons simultaneously for about 1 second.

#### 3 When ending adjustment, return to the initial screen by pressing the (SEL) button.

## Timer / TIMER

Use the timer by selecting from UP Timer or DOWN timer.

### UP TIMER function

- The UP TIMER can be used to count the time between start and stop.
- The timer repeatedly starts and stops each time the switch is operated and accumulates the time between each start and stop.
- The first start operation can be linked to the throttle trigger.
- An alarm sound can be set.

### DOWN TIMER function

- The DOWN TIMER can be used to count the time between start and stop. (The time remaining is displayed.)
- Start and stop are repeated at each switch operation and the time between each start and stop is counted down and displayed. The start time becomes the alarm set time. (When the count reaches 00 minute 00 second, the down timer operates like an up timer.)
- The first start operation can be linked with the throttle trigger.
- An alarm sound can be set.

#### Calling the setup screen

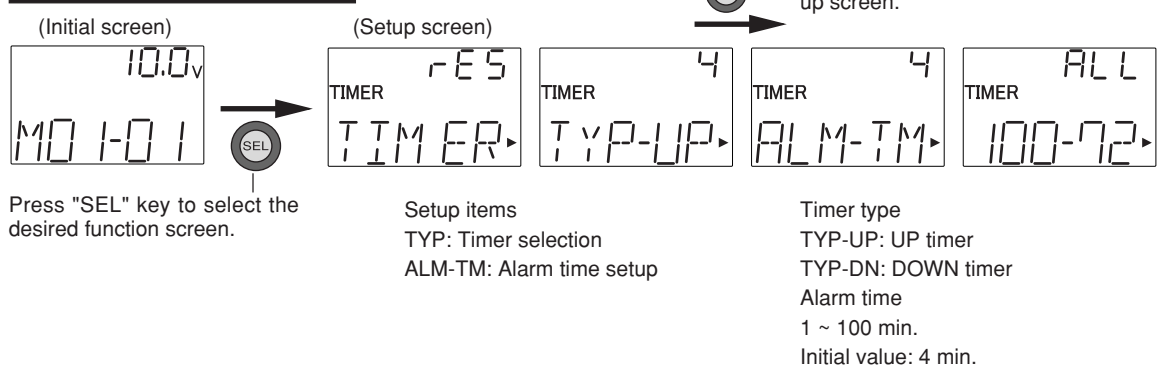

### Timer setup

(Preparation)

- Use the function select switch function (page??) to select the switch. (SW1: Select the "TM" in the above function.)

#### 1 (Timer selection)

Select setup item "TYP" and use the (+) and (-) buttons to select the timer type.

#### 2 (Alarm time setup)

Select setup item "ALM-TM" and use the (+) and (-) buttons to set the alarm time.



### 3 (Linking start with the trigger)

Select setup item "TIMER" and press the (+) and (-) buttons simultaneously for about 1 second. A beeping sound is generated and "RDY" displays at the timer display and the system enters the RDY state. Trigger operation starts the timer.

#### **(Timer start/stop operation)**

The switch SW1 preset by function select switch function (page??) starts the timer. Only starting can be linked with the throttle trigger.

#### **(LAP memory operation)**

This timer can memorize each lap time of each switch (SW1) operation. (100 laps) Switch operation after the set time by alarm has elapsed automatically stops the timer. Each lap time is memorized in a lap memory. The lap times are written sequentially. When the timer is stopped, the final lap is memorized and the total time is automatically written. The lap times are memorized to a next start and can be checked at the lap time screen.

### Checking the lap times

- 1 Select the lap time screen "ALL" and check the total time.
- 2 Use the (+) and (-) buttons to scroll each lap screen and check each lap time.

## Frequency Selection (T3PM-FS only)

T3PM-FS transmitter (PLL synthesizer system) allows easy frequency changes simply by selecting a desired frequency on a transmitter LCD screen.

### Calling the setup screen

1. Turn on the power switch while pressing "SEL" key.

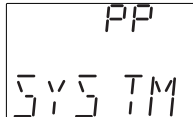

2. Next, use "SEL" key to select the desired function screen.

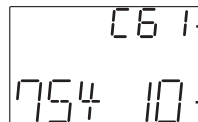

Channel No.: CH61

Frequency: 75.410MHz

### Frequency selection

- 1 Use the (CH) buttons to select the desired frequency.
- 2 When ending selection, once turn off the power switch before use.

Refer to the attached frequency list before setup.

## Model Copy / CPY

This function copies the entire contents of the currently called model memory to another model memory.

### Calling the setup screen

1. Turn on the power switch while pressing "SEL" key.

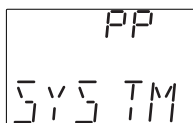

2. Next, use "SEL" key to select the desired function screen.

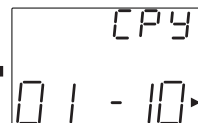
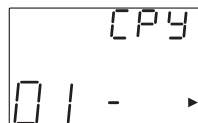

Current model No.

Copy destination model No.

### Model Copy

- 1 (Copy destination selection)
  - Use the (CH) button to select the copy destination model No.
- 2 (Copy execution)
  - Press the (+) and (-) buttons simultaneously for about 1 second.
- 3 When ending adjustment, turn off the power switch before use.

## Model Reset / CLR

This functions resets the contents of the currently called model memory to the initial value. However, it does not reset the lap time memory, HRS/PPM select, and LED mode selection.

### Calling the setup screen

1. Turn on the power switch while pressing "SEL" key.



2. Next, use "SEL" key to select the desired function screen.

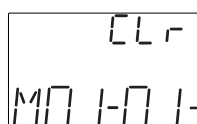
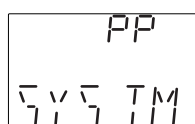

Current model No.

### Model Reset

1 (Reset execution)

Press the (+) and (-) buttons simultaneously for about 1 second.

2 When ending adjustment, once turn off the power switch before use.

## Model Name / NAM

This function allows you to assign a three character name to each model memory. (Number and alphabet can be used.)

### Calling the setup screen

1. Turn on the power switch while pressing "SEL" key.



2. Next, use "SEL" key to select the desired function screen.

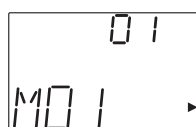
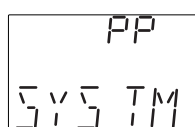

Model name

### Model Name

1 Move the cursor (blinking) to the column you want to change using the (CH) button.

2 Change the character using the (+) or (-) button.

(Set the model name by repeating steps 1 and 2 above. )

3 When ending adjustment, turn off the power switch before use.

## HRS/PPM Select / MOD

The signal mode output from the transmitter can be changed. (PPM/HRS)

### Receiver

When using an FM receiver set to the PPM side and when using an HRS receiver set to the HRS side.

**- When the mode was changed and when a model of a different mode was selected, signals are output in the mode set at the point at which the transmitter power was turned back on.**

#### Calling the setup screen

1. Turn on the power switch while pressing "SEL" key.

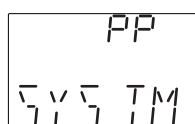

2. Next, use "SEL" key to select the desired function screen.

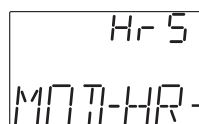

Signal mode  
HR: HRS mode  
PP: PPM mode

### HRS/PPM mode selection

1 (Mode selection)

Use the (+) or (-) button to select the mode.

2 When ending adjustment, turn off the power switch before use.

## Function Select Switch / FNC-SW

This function allows selection of the function to be performed by the switches (SW1/SW2).

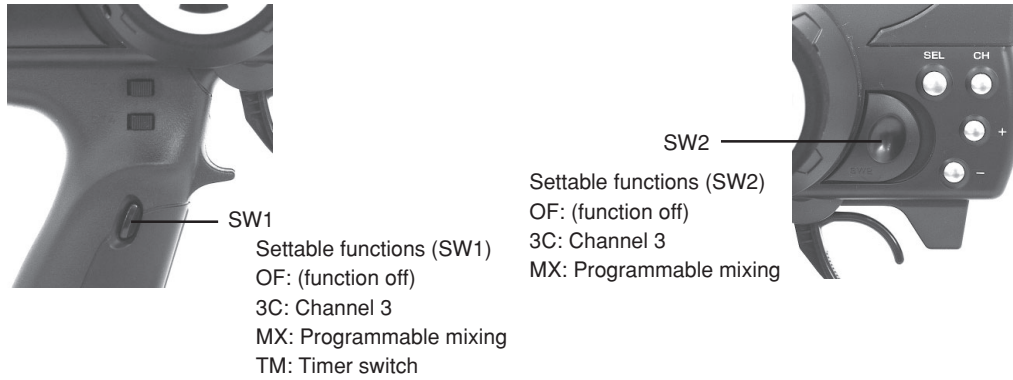

### Calling the setup screen

1. Turn on the power switch while pressing "SEL" key.

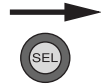
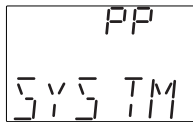

2. Next, use "SEL" key to select the desired function screen.

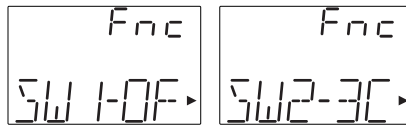

Press "CH" key to select the next set-up screen.

### Function select switch setup

#### 1 (Setup item selection)

Use the (CH) button to select the item to be set.

#### 2 (When changing the function)

Use the (+) or (-) button to select the function.

3 When ending adjustment, turn off the power switch before use.

## Function Select Lever / FNC-DT

This function allows selection of the function performed by the grip lever (DT3/DT4) and digital trim (DT1/DT2).

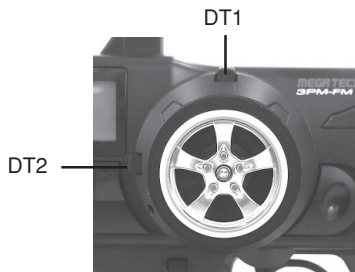

Initially set functions  
 DT1: Steering trim  
 DT2: Throttle trim  
 DT3: Dual rate function  
 DT4: ATL function

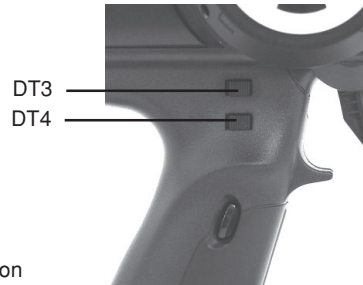

Settable functions  
 ST: Steering trim  
 TH: Throttle trim  
 DR: Steering D/R  
 AT: Throttle ATL  
 E1: Steering EXP  
 BK: Brake mixing rate  
 3C: Channel 3  
 OF: (function off)

### Calling the setup screen

1. Turn on the power switch while pressing "SEL" key.

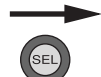
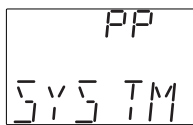

2. Next, use "SEL" key to select the desired function screen.

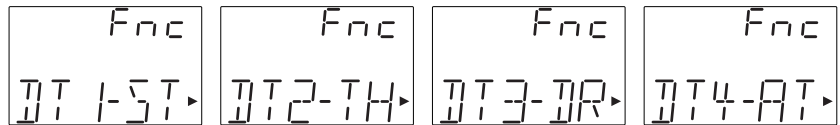

Press "CH" key to select the next set-up screen.

### Function select lever setup

1 (Setup item selection)

Use the (CH) button to select the item to be set.

2 (When changing the function)

Use the (+) or (-) button to select the function.

3 When ending adjustment, turn off the power switch before use.

Functions

## Condition 2 Selection / COND2

### Condition 2 Selection

In specific functions, two rates can be set up, and switched with the switch (SW1) simultaneously during a run.

If this function is activated, SW1 is used only for this function, and it becomes impossible to use it for other functions automatically.

When the switch (SW1) is operated, Condition 2 on/off state changes by turn. When this function is turned on, the beep sounds and the pilot lamp blinks.

Related functions:  
 Steering speed  
 Steering EXP  
 Throttle EXP  
 ABS return amount  
 Brake mixing rate  
 Programmable mixing  
 Steering trim  
 Throttle trim  
 Steering D/R  
 Throttle ATL

#### Calling the setup screen

1. Turn on the power switch while pressing "SEL" key.
2. Next, use "SEL" key to select the desired function screen.

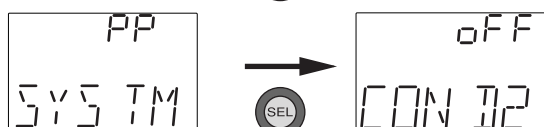

### Condition 2 selection

- 1 Use the (+) or (-) buttons to select the on/off state.
- 2 When ending selection, turn off the power switch before use.

## LED Mode Selection / LED-MD

You can select your desired brightness of the pilot lamp. (Four steps)

#### Calling the setup screen

1. Turn on the power switch while pressing "SEL" key.
2. Next, use "SEL" key to select the desired function screen.

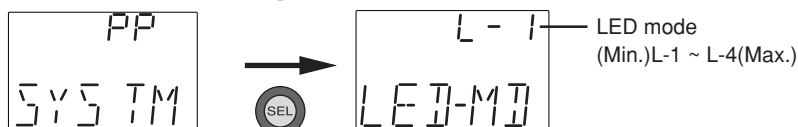

Functions

### LED mode selection

- 1 Use the (+) or (-) buttons to select the brightness of the pilot lamp.
- 2 When ending selection, once turn off the power switch before use.

## Ratings

\*Specifications and ratings are subject to change without prior notice.

### Transmitter T3PM

- (Wheel system, 3 channels)
- Transmitting frequencies 27, 29, 40, 41 or 75MHz band
  - Modulation FM  
(HRS/PPM switching possible)
  - Power requirement  
(NiCd battery)  
NT8F700B NiCd battery (9.6V)  
(Dry cell battery)  
Penlight x 8 (12V)
  - Current drain 250mA or less

### Servo S3003

- (Standard servo)
- Output torque 4.1kg-cm (56.9oz-in)
  - Speed 0.19 sec/60 degree
  - Power requirement 4.8V or 6V
  - Size 40.4x19.8x36mm  
(1.59x0.78x1.42in)
  - Weight 37.2g (1.31oz)

### Servo S3305

- (Heavy duty metal gear servo)
- Output torque 8.9kg-cm (124oz-in)
  - Speed 0.2 sec/60 degree
  - Power requirement 4.8V or 6V
  - Size 40x20x38.1mm  
(1.57x0.79x1.50in)
  - Weight 46.5g (1.64oz)

### Receiver R133F

- (3 channels, FM receiver)
- Receiving frequencies 27, 29, 40, 41 or 75MHz band
  - Intermediate frequency 455kHz
  - Power requirement 4.8V or 6V  
(shared with servos)
  - Current drain 18mA

- Size 25.6x37.6x13.8mm  
(1.01x1.48x0.54in.)
- Weight 14.6g (0.52oz.)

### Receiver R303FS

- (3 channels, FM, PLL synthesizer receiver)
- Receiving frequencies 27, 29, 40, 41 or 75MHz band
  - Intermediate frequency 455kHz
  - Power requirement 4.8V or 6V  
(shared with servos)
  - Current drain 35mA
  - Size 28.5x42.7x13mm  
(1.12x1.68x0.51in.)
  - Weight 18.8g (0.66oz.)

### Receiver R203HF

- (3 channels, HRS receiver)
- Receiving frequencies 27, 29, 40, 41 or 75MHz band
  - Intermediate frequency 455kHz
  - Power requirement 6.0V  
(shared with servos)
  - Current drain 14mA
  - Size 25.6x37.7x14.3mm  
(1.01x1.48x0.56in.)
  - Weight 17g (0.6oz.)

## ⚠ Caution

! In case of the High Response System (H.R.S) receiver R203HF, always use only the following conditions:

**Servo; 6V type Digital Servo only  
Power supply; 6V Nicd battery  
Transmitter setting; "HRS" mode**

If the conditions are different, control is impossible.  
And **Fail Safe Unit (FSU)** is not available.



## Optional Parts

The following parts are available as 3PM options. Purchase them to match your application. For other optional parts, refer to our catalog.

### Crystal Set

#### <Types of Crystals>

There are crystals for FM and AM, depending on the modulation mode, and crystals for single conversion and dual conversion, depending on the receiver circuitry. Use FM and single conversion crystal sets with R133F/R203HF.

#### Warning

 Use only genuine Futaba crystal.

The use of other than Futaba crystal will result in decrease of range as well as loss of control.

### Transmitter NiCd Battery

When purchasing a transmitter NiCd battery as a spare, etc., use the following:

#### Part name

NT8F700B



(9.6V/700mAh)

Reference

# Troubleshooting

If your system fails to operate or you experience a short range problem or erratic control, check the table below for possible causes. If after you have followed the suggestions listed, the problem is not corrected, return the system to our service department for inspection, and repair.

## (Item Check)

### Transmitter

#### Battery

Dead battery -> Change the batteries. Charge the NiCd

Batteries inserted incorrectly. -> Reload the batteries in accordance with the polarity markings

Faulty contact -> Check to see if the contacts are bent and not making good contact

Dirty contacts -> Clean the contacts and check for corrosion.

#### Antenna

Loose -> Be sure the antenna is screwed in tightly

Not fully extended -> Fully extend the antenna

### Receiver

#### Battery

Dead battery -> Replace or recharge

Wrong polarity -> Check connections

#### Antenna

Near other wiring -> Move away from wiring

Was antenna cut -> Request repair

Is the antenna bundled or coiled -> Keep the antenna straight and as much in the air as possible

#### Crystal

Loose -> Push in firmly

Wrong brand -> Be sure the frequencies match in transmitter and receiver

### Connector connections

Wiring incorrect -> Insert all connectors firmly

Loose connections -> Push the connector in firmly

### Linkage

Binding or loose -> Adjust the linkage in model

Is movement stiff -> Adjust linkage in model

### Motor (Electric powered)

Noise problems -> Install capacitors on motor

Reference

## Error Displays

### Low Battery Alarm

If the transmitter battery voltage drops to 8.5V or less, an audible alarm will sound and "LOW BT" will be displayed on the LCD screen.

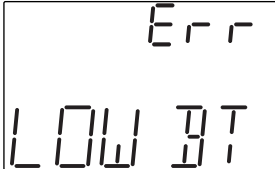
LCD screen: 

**Audible alarm:**  
Continuous tone.

### Warning

 When a low battery alarm is generated, cease operation immediately and retrieve the model.

If the battery goes dead while in operation, you will lose control.

### Backup Error

If the data is lost for an unknown reason, an audible alarm will sound and "BCK UP" will be displayed on the LCD screen.

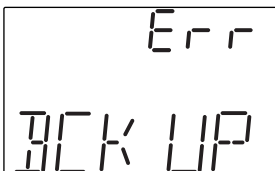
LCD screen: 

**Audible alarm:**  
Tone will sound (9 times), then repeat.

### Warning

 When a backup error is generated, immediately stop using the system and request repair from the Futaba Service Center.

If you continue to use the system, the transmitter may malfunction and cause loss of control.

## When requesting repair

Before requesting repair read this instruction again recheck your system. Should the problems continue request as follows.

### **(Information needed for repair)**

Describe the problem in as much detail as possible and send the letter along with the system in question.

- Symptom (Including the conditions and when the problem occurred)
- R/C System (Send transmitter, receiver and servos)
- Model (Type of model, brand name and model number or kit name)
- Detailed packing list (Make a list of all items sent in for repair)
- Your name, address and telephone number.

### **(Warranty)**

Read the Warranty card.

- When requesting warranty service, send the card or some type of dated proof purchase.

Reference



---

### **Hobby Services (U.S. only)**

3002 N. Apollo Drive, Suite 1  
Champaign, IL 61822 U.S.A.  
(217) 398-0007  
[www.hobbyservices.com](http://www.hobbyservices.com)