

Futaba®

4EX



INSTRUCTION MANUAL
for Futaba 4EX 4-channel,
FM radio control system for aircraft

Futaba Corporation

Technical updates available at: <http://www.futaba-rc.com>



TABLE OF CONTENTS

Introduction.....	2	Trims.....	11
Service	2	Exponentials.....	11
Contents and specifications	3	V-tail mixing	12
Glossary.....	3	Elevon mixing	12
Introduction to the 4EX system	4	Flow chart.....	13
Transmitter controls and descriptions	4	Other T4EX functions.....	14
Radio installation	5	Trainer switch	14
Receiver and servo connections	7	Adjustable-length control sticks.....	14
Charging the Ni-Cd batteries	7	Changing the stick mode.....	14
LCD and Programming controls.....	8	Flying safety guidelines	15
Programming the T4EX radio	9	Flight preparation.....	16
Model select / Data reset.....	10	Model Data Recording Sheets	17
Servo reversing	10	Futaba Accessories	20
End Point Adjustments.....	11		

INTRODUCTION

Thank you for purchasing the Futaba® 4EX digital proportional R/C aircraft system. If this is your first “computer” radio, rest assured that it is designed to make initial setup and field-tuning of your airplane easier and more accurate than would be if using a “non-computer” radio. Although this is a **beginner** or **sport** system with the requirements of those flyers in mind, in order to make the best use of your Futaba 4EX and to operate it safely, **you must carefully read all of the instructions.**

Suggestion: If, while reading the instructions, you are unclear of some of the procedures or functions and become “stuck,” continue to read on anyway. Often, the function or procedure will be explained again later in a different way providing another perspective from which to understand it. Another suggestion is to connect the battery, switch and servos to the receiver and actually operate the radio on your workbench as you make programming changes. Then, you’ll be able to see the effects of your programming inputs.

SERVICE

(in USA)

If any difficulties are encountered while setting up or operating your system, please consult the instruction manual first. For further assistance you may also refer to your hobby dealer, or contact the Futaba Service Center at the web site, fax number or telephone number below:

www.futaba-rc.com

Fax: (217) 398-7721

Telephone (8:00 am to 5:00 pm Central time Monday through Friday): (217) 398-8970, extension 2

If unable to resolve the problem, pack the system in its original container with a note enclosed and a **thorough, accurate** description of the problem(s). Include the following in your note:

- Symptoms.
- Any unusual mounting conditions.
- An inventory of items enclosed.
- The items that require repair.
- Your name, address, and telephone number.
- Include the warranty card if warranty service is requested.

Send your system to the authorized Futaba R/C Service Center at the address below:

**Futaba Service Center
3002 N Apollo Drive Suite 1
Champaign, IL 61822**



This product is to be used for sport and recreational flying of radio-control models only. Futaba is not responsible for the results of use of this product by the customer or for any alteration of this product, including modification or incorporation into other devices by third parties. Modification will void any warranty and is done at the owner’s risk.

(USA only)

Protect the environment by disposing of rechargeable batteries responsibly. Throwing rechargeable batteries into the trash or municipal waste system is illegal in some areas. Call 1-800-8-BATTERY for information about Ni-Cd battery recycling in your area.

CONTENTS AND SPECIFICATIONS

Transmitter: T4EX

T4EX Transmitter with 4-model memory.
Transmitting on 29, 35, 36, 40, 41, 72 or 75 MHz band.
Operating system: 2-stick, 4-channel system
Modulation: FM(Frequency modulation)
Power supply: 9.6V NT8S600B Ni-Cd battery or 12V alkaline battery
Current drain: 250mA

Receiver: R127DF, R136F, R124F, or R114F

R127DF FM Dual conversion 7 channel receiver.
R136F FM 6 channel receiver.
R124F/R114F FM 4 channel micro receiver.
Receiving on 29, 35, 36, 40, 41, 72 or 75 MHz band.
Intermediate frequencies: 455kHz (R127DF- 10.7MHz/455kHz)
Power requirement: 4.8V or 6V (R124F/R114F- 4.8V)
Current drain: 9.5mA @ 4.8V (R124F/R114F- 6mA @ 4.8V)
Size: R127DF- 1.39x2.52x0.82" (35.3x64.0x20.8mm)/
R136F- 1.31x1.98x0.71" (33.4x50.3x18.1mm)/
R124F- 1.31x0.64x0.62" (33.2x16.2x15.7mm)/
R136F- 0.86x1.25x0.53" (21.8x31.7x13.5mm)/
Weight: R127DF- 1.5oz (42.5g) / R136F- 0.98oz (27.8g) /
R124F- 0.30oz (8.5g) / R114F- 0.38oz (10.9g)

Servos: S3004, S3003, S3109M, or S3108

S3004 ball bearing/S3003 standard servo
S3109M/S3108 micro servo
With mounting hardware and servo arm assortment.
Control system: Pulse width control, 1.52ms neutral
Power requirement: 4.8 or 6V from receiver (S3109M/S3108- 4.8V)
Output torque: S3004/S3003- 44.4oz-in [3.2kg-cm] @4.8V
S3109M- 6.25oz-in [0.45kg-cm] @4.8V
S3108- 16.7oz-in [1.2kg-cm] @4.8V
Operating speed: S3004/S3003- 0.23sec/60° @4.8V
S3109M- 0.14sec/60° @4.8V
S3108- 0.12sec/60° @4.8V
Size: S3004/S3003- 1.59x0.78x1.41" [40.4x19.8x36mm]
S3109M/S3108- 0.86x0.43x0.78" [21.8x11x19.8mm]
Weight: S3004- 1.3oz (37.2g) / S3003- 1.3oz (38.0g) /
S3109M- 0.22oz (6.3g) / S3108- 0.27oz (7.6g)

Other components:

Switch harness
9"[200mm]aileron extension cord (to facilitate quick connecting and disconnecting of aileron servo with removable wing)
Instruction manual

*Specifications and ratings are subject to change without notice

GLOSSARY

It will be helpful to understand the following terms **before** reading the rest of the manual. The terms are not in alphabetical order, but are in a logical order that prepares the reader for understanding the next term.

Reversing (servo reversing) - A function that allows the user to determine the direction of response of each servo. If, after hooking up the servos, a control on the model responds in the wrong direction, the user may change the servo's direction so the control responds correctly.

Throw - When speaking of a control surface (such as an elevator or aileron), the throw is the distance the surface moves. Control surface throw is usually measured at the trailing edge of the surface and is expressed in inches or millimeters. The model in the diagram has 1/2" [13mm] of up elevator throw. Throw can also refer to the distance a servo arm (or wheel) travels.

End point adjustment (E.P.A.) - Sets the overall, maximum distance the servo rotates in either direction.

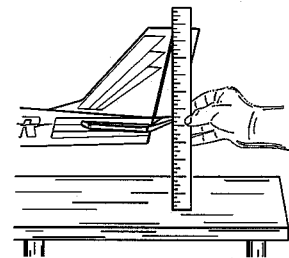

Exponential - Normally, servos respond proportionally to control stick input from the transmitter (e.g., if the stick is moved halfway, the servo will move halfway). However, with "exponential," the servo can be made to move more or less than initial stick movement (less servo movement is more common). Exponentials are commonly used to "soften," or decrease initial servo travel for the ailerons, elevators and rudder. This way, initial control stick inputs from the pilot result in small servo movement for a smoother flying airplane.

Mixing - Two (or more) servos can be made to operate together either by mechanically joining the wires (with a Y-connector) or by electronically "joining" them through programming functions (WING mixing) in the transmitter. When servos are electronically joined via programming, they are said to be "mixed." Each servo's end points can be independently set.

INTRODUCTION TO THE 4EX SYSTEM

IMPORTANT! Always turn on the transmitter first, then the receiver. When turning off the system, always turn off the receiver first. The object is never to have the receiver on by itself. Otherwise, the servos or control surfaces could be damaged, or in the case of electric-powered models, the motor may unexpectedly turn on causing severe injury.

IMPORTANT! Never collapse the transmitter antenna by pushing down from the top. If one of the segments becomes momentarily stuck you may damage the antenna. Instead, collapse the antenna from the bottom, drawing in one segment at a time.

Transmitter

The liquid-crystal display (LCD) on the face of the compact, ergonomically-designed case is easy to read and allows rapid data input. The system also holds independent memories for four different models. The new, adjustable-length control sticks provide an improved feel. External switches operate trainer cord or "buddy-box" capabilities. Programming features include servo reversing and E.P.A on all channels, exponentials. Additionally, any one of three, factory-set, preprogrammed "wing-type" mixers including V-tail, elevon mixing may be selected.

Transmitter controls

The diagram and explanations briefly describe the functions of the Futaba T4EX transmitter. Full instructions on how to operate the controls are provided beginning on page 9.

NOTE: The diagram shows a Mode 2 system as supplied. (More on flight modes on page 14).

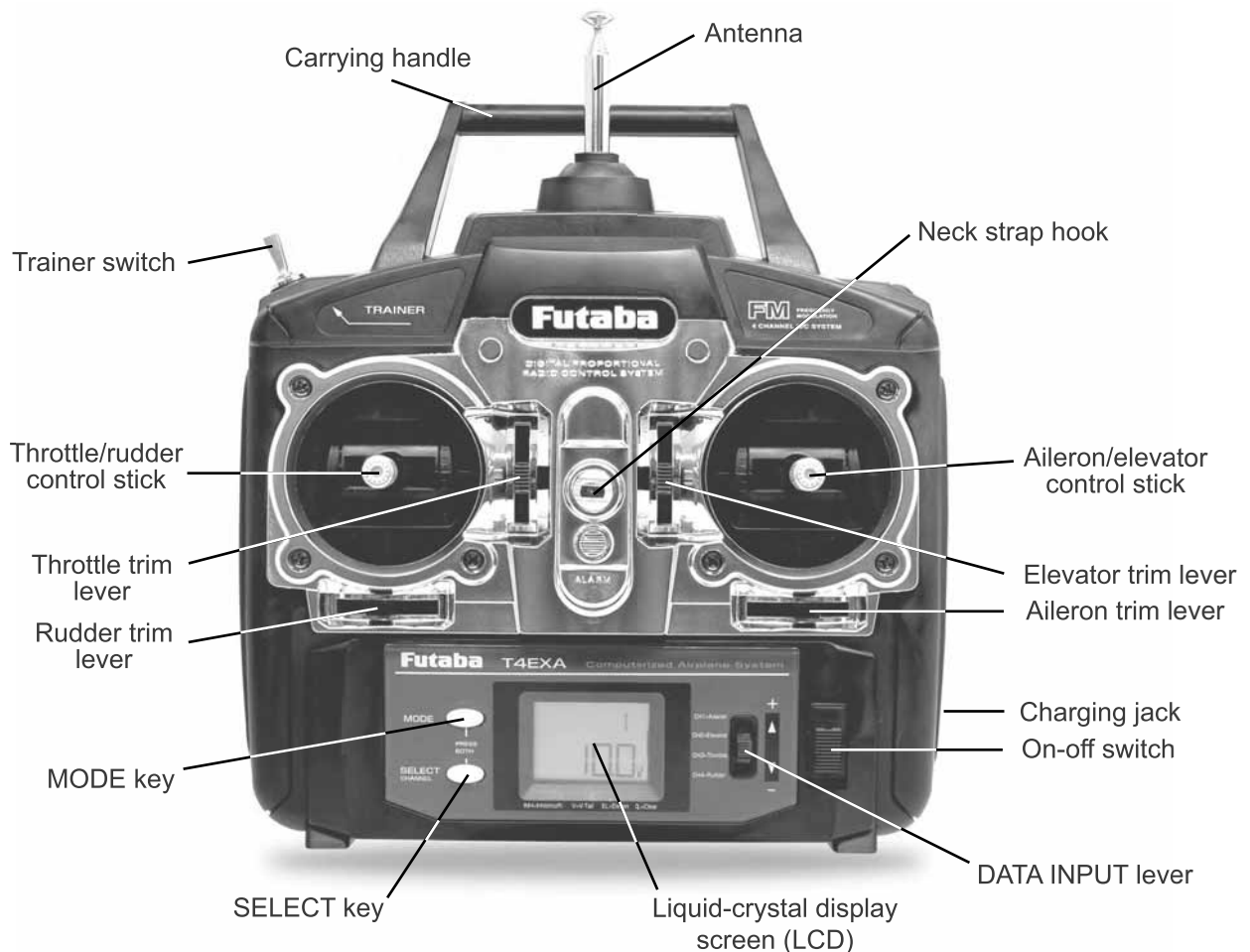

DESCRIPTIONS:

Neck strap hook - Mounting point for optional neck strap.

Aileron/elevator control stick - Operates the servos connected to channel 1 (aileron) and channel 2 (elevator) in the receiver.

Trim levers (all) - Used to shift the neutral or center position of each servo as labeled in the diagram.

NOTE: Changing the trims affect the overall settings. When trim usage is extreme, recheck your installation for maximum travel.

Charging jack - Port for charging the transmitter batteries with the included battery charger.

On-off switch

DATA INPUT lever - Used to change the values of the various functions displayed on the LCD screen.

Liquid-crystal display screen (LCD) - Displays programming modes and values entered.

MODE key - Used to scroll through and display the seven different functions.

SELECT key - Used to display the values for the current function.

Throttle/rudder control stick - Operates the servos connected to channel 3 (throttle) and channel 4 (rudder) in the receiver.

Trainer switch - Operates the trainer functions. To operate as a trainer switch the transmitter must be connected to another transmitter via a trainer cord (available separately).

Antenna - Radiates signals to the receiver. Never fly a model without fully extending the antenna or you may create interference to other modelers and decrease operational signal range of the transmitter. The antenna may be removed and replaced with another in case it is inadvertently broken.

RADIO INSTALLATION

Follow these guidelines to properly mount the servos, receiver and battery.

- Make certain the **alignment tab** on the battery, switch and servo connectors is oriented correctly and “keys” into the corresponding notch in the receiver or connectors before plugging them in. When unplugging connectors, never pull on the wires. Always pull on the plastic connector instead.
- If any servo wires are not long enough to reach the receiver, servo extension wires (available separately) may be used.
- Always mount the servos with the supplied **rubber grommets**. Do not over tighten the screws. No part of the servo casing should contact the mounting rails, servo tray or any other part of the airplane structure. Otherwise, vibration will be transmitted to the servo causing premature wear and/or servo failure.

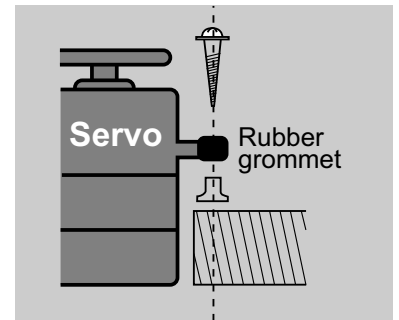

- Note the small numbers (1, 2, 3, 4) molded into each arm on the Futaba 4-arm servo arms. The numbers indicate how many degrees each arm is “off” from 90 degrees to correct for minute manufacturing deviations from servo to servo.

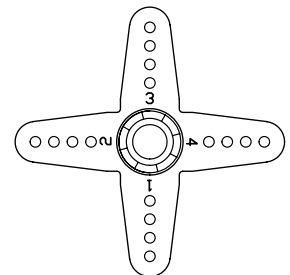

THE TRIMS ON THE RADIO SHOULD BE CENTERED.

- To center the servos, connect them to the receiver and turn on the transmitter and receiver. Center the trims on the transmitter, then find the arm that will be perpendicular to the pushrod when placed on the servo.

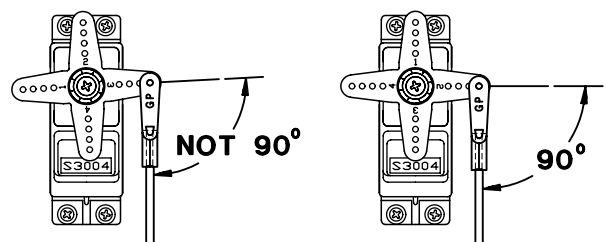

- After the servos are installed, operate each servo over its full travel and check that the pushrods and servo arms do not bind or contact each other. Also make sure the controls do not require excess force to operate. If there is an objectionable buzzing sound coming from a servo, there is probably too much resistance in the control. Find and correct the problem. Even if there is no servo damage, excess battery drain will result.
- Use the **mounting plate** from the receiver on/off switch as a template for the cutout and screw holes. Mount the switch on the side of the fuselage opposite the engine exhaust, and where it won't be inadvertently turned on or off during handling or storage. Be certain the switch moves without restriction and "snaps" from ON to OFF, and that the cutout allows **full motion** of the switch in **both** directions.
- **IMPORTANT: NEVER** cut the receiver antenna or mount it in the model folded back on itself. Doing so will change its electrical length, possibly reducing the distance from the pilot that the model can be controlled ("range").
- The receiver antenna may be mounted inside or outside the model:

Internal antenna mounting:

The antenna may be routed down through the inside of the fuselage, or through any **non-metallic** housing or tube within the fuselage. Keep the antenna away from metal pushrods, wires and cables; otherwise, range may be decreased. Always perform a range check before flying (see page 16).

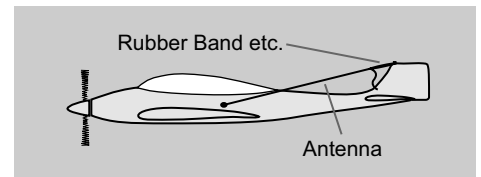

External antenna mounting:

A. Use a cut off servo arm as a **"stop"** or **strain relief** inside the fuselage to keep tension off the solder joint holding the antenna to the receiver. Guide the antenna through a hole in the fuselage. (If possible, insulate the hole with a rubber grommet or a small piece of rubber tubing.)

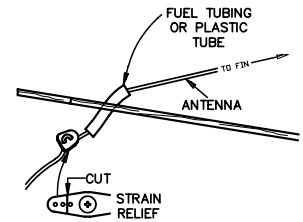

B. Make a **hook** from another cut off servo arm. Insert the end of the antenna through two holes, then connect the hook to a rubber band around a pin inserted into the vertical stabilizer. Allow any excess antenna length to trail behind the hook.

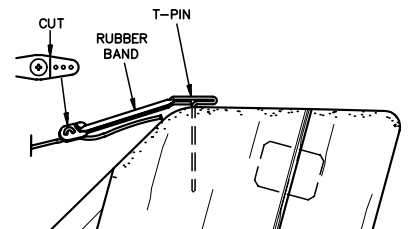

- The receiver contains precision electronic parts. It is the most delicate (and expensive) radio component on-board the model and should be protected from vibration, shock and temperature extremes. To protect the receiver, wrap it in R/C foam rubber or other vibration-absorbing material. If appropriate, waterproof the receiver by placing it in a plastic bag and closing the open end with a rubber band before wrapping it in foam. If moisture enters the receiver, intermittent operation or a failure may result. Wrapping the receiver in a plastic bag also protects it from fuel and exhaust residue which, in some models, can work its way into the fuselage.

Mounting the frequency clip: (for USA)

- To announce your frequency and avoid potential interference problems, the frequency number should always be displayed on the transmitter antenna while flying. Peel the backing from the numbers and apply them to both sides of the clip. Snap the end of the clip that fits best to the base of the antenna as shown. You may cut off the other end of the clip.

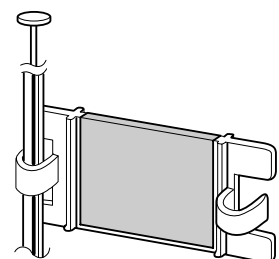

RECEIVER AND SERVO CONNECTIONS

Connect the servos to the receiver to perform the functions indicated:

Receiver output channel	Function
1	Aileron -or- left elevon (for tailless models)
2	Elevator -or- left ruddervator (for V-tail models) -or- right elevon (for tailless models)
3	Throttle
4	Rudder -or- right ruddervator (for V-tail models)
5	(Not used)
6	(Not used)
7	(Not used)
B	Receiver on/off switch (the plug colored red goes into the receiver)

The diagram shown is for aircraft models only. Additional servos may have to be purchased separately.

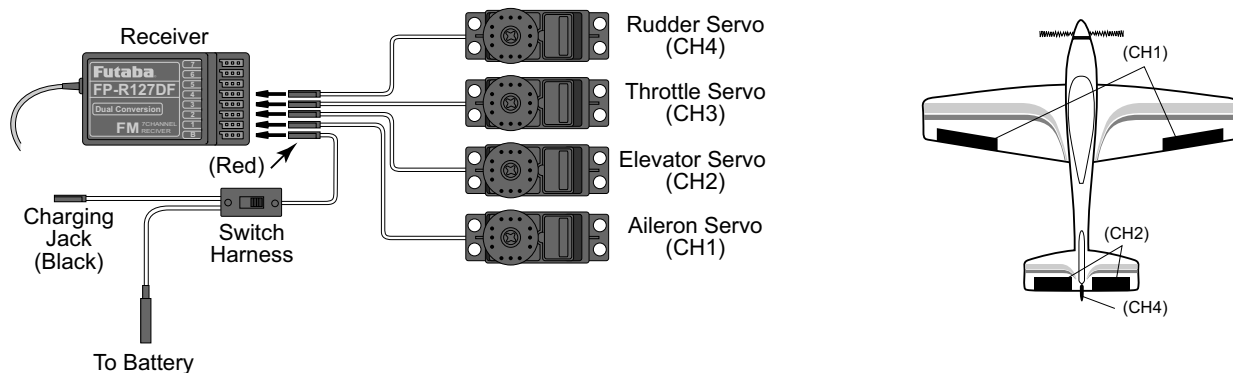

CHARGING THE Ni-Cd BATTERIES

The transmitter and receiver batteries included with your 4EX system are rechargeable, Ni-Cd (nickel-cadmium, pronounced ni-kad) batteries. Ni-Cd batteries require special care and charging. **Read the charging instructions carefully.**

NOTE: The batteries are partially charged, but will require a full, overnight charge before the model may be flown.

1. Connect the **transmitter charging cord** coming from the A/C wall charger to the charge jack in the right side of the transmitter case. The **receiver charging cord** may be connected to the batteries two different ways: The charge cord may be connected directly to the battery pack, or to the vacant charge connector (black) coming from the on/off switch in the model. Charging "through the switch" is preferred as there will be no need to disconnect the battery.
2. Plug the A/C wall charger into a wall outlet. **Note:** If the wall outlet can be turned off by a switch in the room, be certain the switch remains on after leaving the room. Otherwise, the batteries will not be charged!
3. The LEDs (light-emitting diodes) should light red, indicating that current is flowing and the batteries are being charged. Discharged batteries will take about 15 hours to fully charge. If using an aftermarket fast charger, **be certain to follow the manufacturer's instructions provided with the charger** so you do not overcharge the batteries. **NEVER** charge the batteries at a rate higher than 1,000mA. The batteries should also be discharged periodically to prevent a condition

called “memory.” If, for example, only two flights are made each time you go flying, the batteries will not have “reached” very far down into their full capacity. After doing this several times the batteries will “remember” and eventually “think” they can supply only enough power for two flights. After two flights the batteries may not provide enough power to operate the system, thus causing a crash. To erase any potential memory, cycle the batteries by discharging, then charging them with a commercial battery cycler, or leave the system on and exercise the servos by moving the transmitter sticks until the servos are moving very slowly, indicating that the battery is discharged. Cycling should be done every one to two months, even during the winter or periods of long storage. If using a cycler with a readout, note the capacity after the batteries have been cycled. If there is a noticeable drop in capacity the batteries should be replaced.

Note: Charging your batteries with the included Futaba A/C battery charger is always safe. However, fast-charging with an aftermarket charger is acceptable as long as you know how to properly operate the charger. **NEVER** charge at a rate higher than 1,000 mA (1 Amp). If not done correctly, fast-charging can damage the batteries.

LIQUID CHIP DISPLAY (LCD) & PROGRAMMING CONTROLS

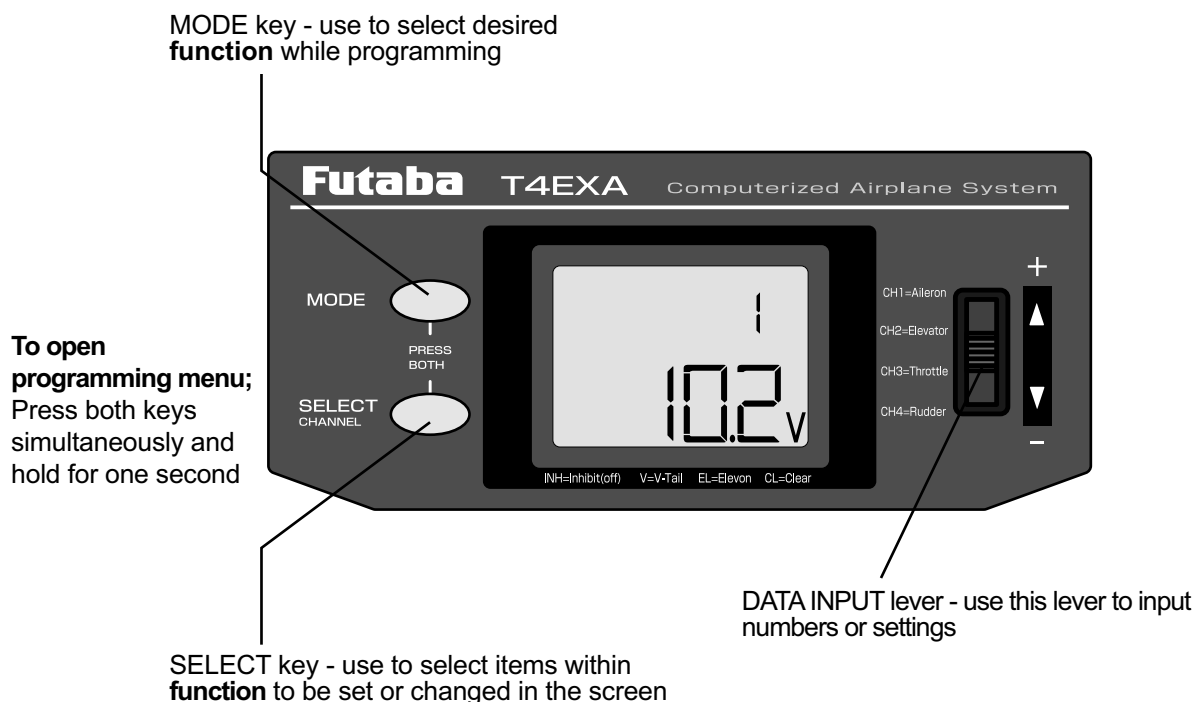

LCD display screen

When the transmitter is **initially** turned on, the **model memory number** and **transmitter battery voltage** are displayed on the LCD screen. When prompted by the user, the functions and settings stored in the memory can also be read on the screen. The user accesses the different functions using the MODE and SELECT keys and changes the values and settings using the DATA INPUT lever. (This is called programming!)

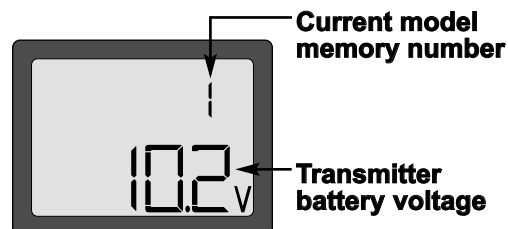

Note: Feel free to explore by scrolling through the programs and viewing the displays using the MODE and SELECT keys. The MODE and SELECT keys only determine what will be displayed on the screen and will not change any of the settings. Only when using the DATA INPUT lever will you be able to change any of the settings.

Model memory number

The Futaba T4EX stores model memories for four models. This means all the data (control throws, end points, etc.) for up to four different models can be stored in the transmitter and activated at any time (depending upon which model you choose to fly that day). This eliminates the requirement for reconfiguring the transmitter each time you decide to fly a different model with it! When the transmitter is turned on the **model number** and the transmitter voltage will be indicated on the LCD screen. Before every flight **BE CERTAIN** that the correct model number for the model you intend to fly appears on the screen. If the transmitter is not operating the correct model, some (or all) of the controls could be reversed and the travels will be wrong.

Flying a model with the wrong program will result in a crash, so always **be certain** the model number in the transmitter is correct. One way to ensure this is to write the corresponding model number directly on the airplane, or attach a list to the bottom or back of the transmitter.

Transmitter battery voltage

In addition to the model number, the LCD screen also displays the **transmitter battery voltage**. When the voltage goes below approximately **8.5 Volts** the “battery” icon will *flash* and the low-battery alarm will continuously “beep” until the transmitter is turned off. When the low-battery alarm sounds you will have approximately four minutes (or less) to land your model before losing control. You should never allow the transmitter voltage to become this low while flying, but if it does, land **immediately**.

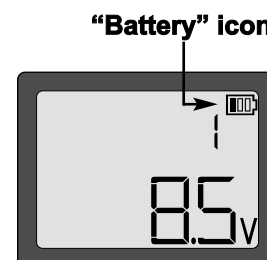

Note: When the transmitter voltage reads **8.9 Volts** you will still have approximately ten minutes (or less) before losing operational range, so this is the recommended **absolute minimum** voltage. If the transmitter ever reaches 8.9 Volts, land as soon as safely possible. A more reasonable margin of safety would be to quit flying for the day (or recharge the batteries) when the transmitter battery is at 9.4 Volts.

SUGGESTED GUIDELINES

- 9.4 Volts - No more flying until recharge.
- 8.9 Volts - Land as soon as safely possible.
- 8.5 Volts - **Emergency- Land immediately!**

PROGRAMMING THE 4EX RADIO

Anytime you wish to **view** or **change** any of the current settings in the transmitter, the programming mode must first be entered by, of course, turning on the power, then by pressing the **“MODE”** and **“SELECT”** keys simultaneously and holding them down for one second. Once “in the program” the MODE key will be used to scroll through each of the seven functions (model number/data reset, reversing, exponentials, end point adjustments, trim memory, “v-tail” mixing, and “elevon” mixing) and the SELECT key will be used to view the settings within the function. When a data change is actually required the **“DATA INPUT”** lever will be used to increase or decrease the value of the item displayed, thus making the change.

You can return to the “home” screen (where the model number and battery voltage is displayed) by pressing the MODE and SELECT keys simultaneously and holding them down for one second.

Note: The functions are listed and described in the order that they appear in the transmitter. Read all the way through the programming instructions before setting up your model (if you won't be using any of the mixing functions for a while you can read those instructions when ready). Refer to the FLOW CHART on page 13 as well.

Model Select/Data Reset

MODEL Model select function

To select model memory:

1. Access the Model Select function in the programming mode (by pressing the MODE and SELECT keys simultaneously and holding them down for one second). The number for the current, active model will be blinking.
2. To activate a different model memory press the DATA INPUT lever for a half second until the desired model number appears.
3. Now the model has been selected. All programming inputs from this point forward will affect only the model number on the screen (until another model number is selected).

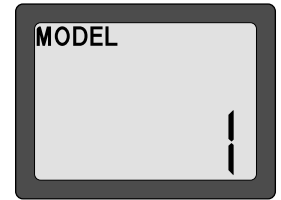

CL Data reset function

All the data for any model memory can be reset to the original factory defaults. Often this function is done to get a “fresh start” and clear the memory before inputting new model settings.

To reset data:

1. Access the Model Select function in the programming mode (by pressing the MODE and SELECT keys simultaneously and holding them down for one second). Use the DATA INPUT lever to select the model memory you wish to reset.
2. Once the desired model number is displayed on the screen, press the SELECT key. A “CL” will appear on the screen.
3. Push DATA INPUT upward or downward for about one second to clear and reset the memory. “CL” blinks first, and then it stops blinking with a sound. Now the model data is reset to the initial setting that is the default value set at the factory.

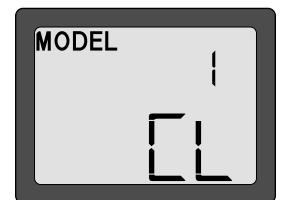

CAUTION: Resetting the current model memory will permanently erase **ALL** programming information for that model. The data cannot be recovered (unless you recorded it on a Model Data Recording Sheet in the back of this manual). Do not reset the model unless **certainly** you want flushing-out that memory and start from scratch.

When actually setting up a model you should have the model in front of you with the power on so you can actually see the effects of your programming inputs and measure the control throws.

REVERSE Servo Reversing

The servo reversing function is used to change the direction that a servo responds to a control input from the transmitter (stick). After using the reversing function, check **all** the controls on the model to **be certain** they are operating in the correct direction and that you did not inadvertently reverse a servo other than the one intended. Reversing the wrong servo (and not checking the response of the controls before each flight) may be the most common cause of a crash!

To reverse a servo:

1. Enter the programming mode and use the MODE key to access the **REVERSE** function.
2. Use the SELECT key to select the channel you wish to reverse.
3. Push the DATA INPUT lever downward to reverse the servo (REV), or push the lever upward to make the servo operate normally (NOR) for a half second. The arrow will indicate the condition of the servo (normal or reversed). In the diagram channel 1 (aileron) is “normal” (not reversed).
4. Use the SELECT key to display other channels to be reversed.

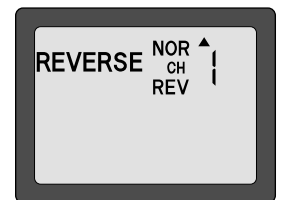

E.P.A End Point Adjustment

The EPA function is designed to “fine tune” the servo throws in cases where changing the pushrod hookup will not achieve the correct throw. The pushrods should first be connected to the servo arms and control horns so the correct, or near correct control surface throw will be achieved. THEN the EPAs may be used to make small changes in the servo throw until the desired control throw is achieved. The control throws should be set up so that the “end points” are as near to 100% as possible. If the EPA values must be set below 70% or above 120% to get the desired throw, you should strongly consider changing the pushrod connections so the values can be set closer to 100%. (When the EPA is set to 100% the maximum servo throw for channels 1, 2, 3 & 4 is approximately 40 °)

To set the end points:

1. Enter the programming mode and use the MODE key to access the “EPA” screen.
2. To change the RIGHT aileron throw move the aileron stick to the right, then push the DATA INPUT lever up or down to change the value and the throw.
3. Move the stick to the left and use the DATA INPUT lever to change the LEFT aileron throw.
4. Use the SELECT key to display the other channels and set the other end points. Notice that moving the stick from one end to the other changes the value displayed and the position of the arrow for that “end” of the control input.

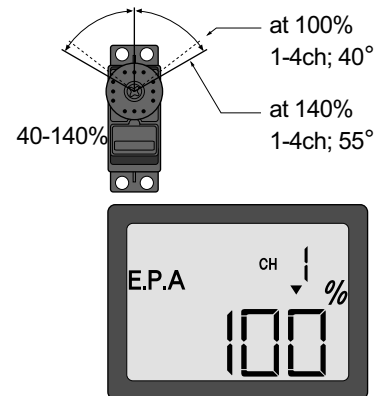

Trim Settings/Trim Memory Function

There are four trim levers (“trims”) on the front of the transmitter. The intended use of the trims is to make small servo adjustments, in flight, to get the model properly “trimmed” (so it will fly straight-and-level).

Center the servos:

1. Turn on the transmitter and receiver. Operate the controls to make sure the servos respond in the correct direction. Use the reversing function to reverse any servos necessary.
2. Center the throttle control stick.
3. Place the servo arms on the servos so they are perpendicular to the pushrods (see page 5). It is okay to cut off any unused servo arms.
4. Connect the pushrods to the control surfaces. Adjust the length of the pushrods until the control surfaces are centered when the servos are centered.

To adjust the trim settings:

Once the servos and control surfaces have been connected and the control throws have been set using the end points, get the model airborne. Adjust the trims as necessary to get the model to fly straight-and-level. If much trim is required on any one control it is a good idea to readjust the pushrods so the trims can be returned to neutral (zero).

TRIM.M - Trim memory function

Since the trims on the 4EX are “mechanical” trim, before changing the model number or turning off the transmitter, perform trim memory operation to save the trim position. The trim positions at the last operation are recalled by operating the trim lever to center.

To save all trim positions:

1. Enter the programming mode and use the MODE key to activate the TRIM.M menu.
2. Push the DATA INPUT lever upward or downward for about one second to save all trim positions.

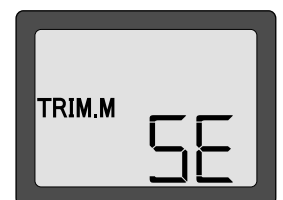

EXP Exponential Settings

Negative exponential (-) decreases initial servo movement. Positive exponential (+) increases initial servo movement. The exponential “curve” may be set anywhere between -100% and +100%.

To set the exponentials:

1. Enter the programming mode. Access the “EXP” screen with the MODE key.
2. Select the channel (1-aileron, 2-elevator, 4-rudder) you wish to set by pressing the SELECT key. The active channel number will be displayed on the screen.
3. Enter the amount of exponential with the DATA INPUT lever.
4. Repeat for the settings on the other channel.

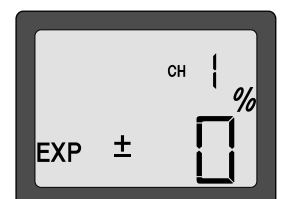

Note: Before programming the exponentials, perform trim memory operation and then set the corresponding trims to center.

Wing Mixing Type Selection

There are two different wing mixing functions to select from:

V-tail mixing

Intended for V-tail aircraft (such as a Beechcraft Bonanza), V-tail mixing allows the ruddervators to operate both as rudders and elevators. V-tail mixing requires that each ruddervator be operated by a separate servo.

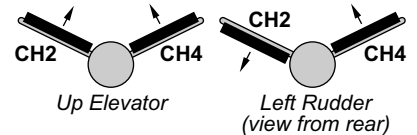

To activate V-tail mixing:

1. Connect the left ruddervator servo to channel 2 (elevator) in the receiver and connect the right ruddervator servo to channel 4 (rudder) in the receiver.

*If necessary, use the Servo Reversing function to achieve the correct direction of servo throws.

2. Enter the programming mode. Access the **“WING”** screen with the MODE key.



3. Push the DATA INPUT lever upward or downward for about a half second to select the V-tail mixing.

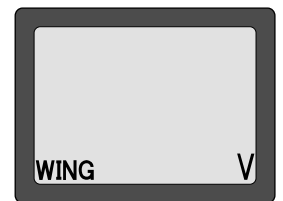

You cannot set **“V-tail”** mixing when **“Elevon”** mixing has already been set.

4. Once this mix has been activated, move the servos to their full extremes to make certain they are not overdriving the controls. If necessary, adjust the linkages to achieve the correct control throws.

Elevon mixing

Intended for tailless, “flying wing” models such as delta wings and flying wings, elevon mixing mixes channel 1 (aileron) to channel 2 (elevator) allowing the elevons to operate in unison (as elevators) or in opposition (as ailerons). This function requires that each elevon be operated by a separate servo.

*If necessary, use the Servo Reversing function to achieve the correct direction of servo throws.

To activate elevon mixing:

1. Connect the servo in the right wing to channel 2 (elevator) in the receiver and connect the servo in the left wing to channel 1 (aileron) in the receiver.

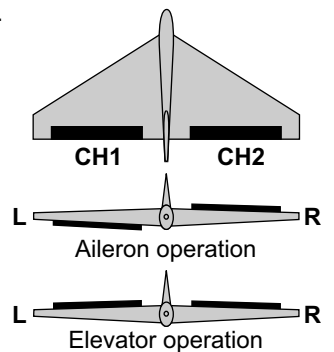

2. Enter the programming mode. Access the **“WING”** screen with the MODE key.



3. Push the DATA INPUT lever upward or downward for about a half second to select the Elevon mixing.



You cannot set **“Elevon”** mixing when **“V-TL”** mixing has already been set.

4. Once this mix has been activated, move the servos to their full extremes to make certain they are not overdriving the controls. If necessary, adjust the linkages to achieve the correct control throws.

FLOW CHART 4EX FUNCTIONS

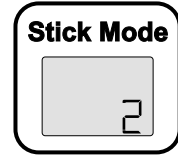

To enter or leave Programming Mode, press **MODE** and **SELECT** keys simultaneously for one second.

To change the Stick Mode, turn on the transmitter holding **MODE** and **SELECT** keys down simultaneously. Use the **DATA INPUT** lever to display the desired stick mode.

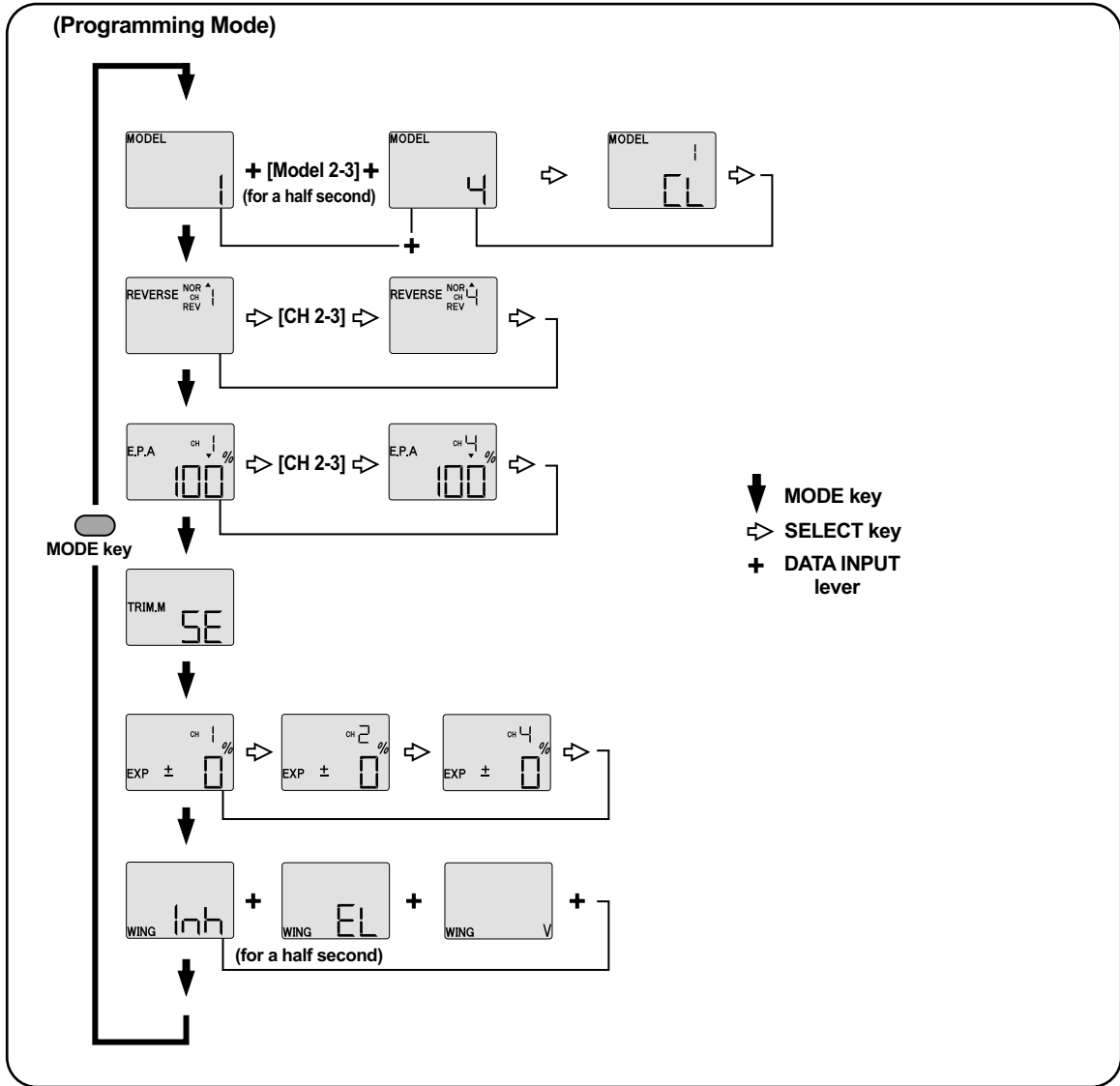

Simultaneously Press the **“MODE”** and **“SELECT”** keys and hold them down for one second to enter the programming mode. Press the keys again (or turn off the transmitter) to exit the programming mode.

OTHER 4EX FUNCTIONS

Trainer switch

To utilize the trainer function, the appropriate trainer cord (available separately) and a second Futaba transmitter (usually provided by your flight instructor or R/C club) will be required. When two radios are connected with the trainer cord, they are both capable of operating the model, but it's usually best for the instructor to hold the radio that has been setup for the plane to be flown (as it is already programmed to fly the model). When the instructor holds the trainer switch on his radio, the student will have control. When the instructor wishes to regain control he simply releases the switch. Then he will have immediate, full control.

If connecting the 4EX to another 4EX with the small, square "micro" trainer jack, use the "Micro to Micro" (MM-TC) trainer cord (FUTM4415). If connecting the 4EX to Futaba radios with the larger, round, "DIN" connector, use "Micro to DIN" (MD-TC) trainer cord (FUTM4420). The T4EX transmitter may be connected to another T4EX, or any 4VF, 6VA Skysport, T6EXA, FF6 - 9, 9Z, or 14MZ series transmitter.

To use the trainer cord:

1. It is best for the instructor to use the transmitter that is already set up for the model to be flown.
2. If the student's radio has PCM/PPM capability, set it to PPM.
3. If the student's radio has a plug-in RF module, remove the module.
4. Collapse the student's antenna and fully extend the instructor's antenna.
5. With the transmitters off, connect the trainer cord to both radios. (On the 4EX the trainer jack is in the center of the rear of the case.) Do not force the plug into the transmitter and note that the plug is "keyed" so it can go in only one way.
6. Turn on the instructor's transmitter. **DO NOT** turn on the student's transmitter it will automatically "power up," but will not transmit a signal. Set the servo reversing and trims of the student's radio to match that of the instructor's.
7. Turn on the receiver switch in the model. Depress the trainer switch on the instructor's radio. Use the student's radio to operate the controls (ailerons, elevator, rudder, etc.) and observe how they respond. Make any adjustments necessary to the student's transmitter to get the controls to respond correctly.
8. Check to see that the trims are in "sync" by toggling the trainer switch back and forth a few times. The controls on the model should remain stationary. If the controls do not remain stationary, this indicates that the trim settings on the student's radio do not match those on the instructor's radio. Adjust the student's trims as necessary.

Trainer Jack



Adjustable-length control sticks

The control stick length is adjustable to make the transmitter more comfortable to hold and operate. To adjust the length, hold the **locking piece (B)** and turn the **stick tip (A)** counterclockwise. Turn the locking piece B up or down to lengthen or shorten the stick. When the length is suitable, lock the stick in position by turning locking piece B counterclockwise.

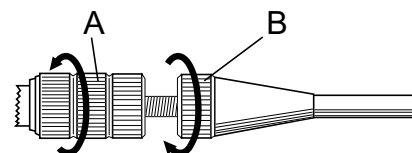

Changing the 4EX stick mode

The transmitter may be operated in four different stick "modes" (1, 2, 3 & 4). The modes determine the functions that will be operated by control sticks. Currently, the transmitter is in "mode 2" and should be left in mode 2 unless you are an experienced flyer and have learned to fly in a different mode. In mode 2, the right control stick operates the aileron and elevator and the left stick operates the rudder and throttle. This is how 99% of Americans fly their models.

To change the mode, simultaneously depress the MODE and SELECT keys, then turn on the power. The current mode will appear on the LCD screen. Push the DATA INPUT lever up or down to change the mode. If a mode is selected that moves the throttle control to the right stick, the throttle detent mechanism will have to be moved as well. This can be done by the Futaba Service Center. (See page 2)

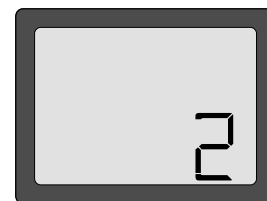

FLYING SAFETY GUIDELINES

Find a suitable flying site (for USA)

If you are a beginning modeler and not yet a member of an R/C club, joining a club and flying at a site specifically intended for R/C model aircraft is **highly recommended**. In addition to joining a club, we strongly recommend joining the AMA (Academy of Model Aeronautics). AMA membership is required to fly at AMA clubs. There are over 2,500 AMA-chartered clubs across the country. Among other benefits, the AMA provides insurance to its members who fly at sanctioned sites and events. Additionally, training programs and instructors are available at AMA club sites to help you get started the right way. Contact the AMA at the address or toll-free phone number below:

Academy of Model Aeronautics

5151 East Memorial Drive

Muncie, IN 47302-9252

Tele. (800) 435-9262

Fax (765) 741-0057

Or via the Internet at: <http://www.modelaircraft.org>



IMPORTANT:

If you do insist on flying on your own, you **must** be aware of your proximity to R/C club sites. If there is an R/C site within six miles of where you are flying, and if you are operating your model on the same frequency as somebody else, there is a **strong** possibility that one or both models will crash due to radio interference. There is **great** potential for an out-of-control model to cause property damage and/or severe personal injury. We **strongly** urge you to fly at an R/C club site where frequency control is in effect so you can be confident you will be the only one flying on your channel.

Charge the batteries

Second to the pilot's flight skills, one of the most important factors that can determine a model's longevity is the state-of-charge of the batteries - especially the on-board receiver pack. Inadequate charging and failing to monitor a battery's voltage may lead to low battery power, causing loss of control and a crash. To avoid this, always charge the batteries the night before you go flying. If ever uncertain how much "charge" is left in a battery, it is wiser to err on the side of caution, rather than trying to get in one last flight! Due to the number of factors that determine receiver battery power consumption (such as the number and type of servos in your model, the type of flying you do, how much resistance is built into the controls, the size of the model, etc.), it is not possible to recommend how many flights one can get on a charge. The best way to monitor battery power and calculate how much flight time you have left is to use a volt meter to check the batteries after each flight. This can be done through the battery charging plug coming from the switch. There are many small, hand-held volt meters available specially intended for R/C use. The Hobbico® Digital Voltmeter MKIII™ (HCAP0356) is one such unit. An on-board volt meter mounted directly on the model (HCAP0330) can also be used.

FLIGHT PREPARATION

Flight preparation is to be done at the flying field.

IMPORTANT: Your radio control system transmits a signal on a certain frequency. Be certain you know what the frequency is. This is expressed as a two-digit number (42, 56, etc.), and can be found on the container the transmitter came in and is also located on the transmitter and receiver. There are several different frequencies, but there is still a chance that someone else at the flying field may be on the same frequency as you. Two models can never be operated at the same time on the same frequency-no matter what the modulation (AM, FM, PCM). If you turn on your transmitter while another person is flying on the same frequency, a crash will result. **NEVER** turn on your transmitter until you have permission from your instructor, and until you have possession of the frequency clip used for frequency control at the flying site.

If you are an inexperienced pilot, be certain your flight instructor performs these following checks with you.

Check the controls

1. Get the frequency clip from the frequency control board at your flying site.
2. Mount the wing to the fuselage. Turn on the transmitter, then the receiver (remember to do this in reverse order when turning off the system). Be certain the correct model memory matching the model you will be flying is the one on the LCD screen.
3. Operate and observe the controls. Look for inadvertent movement and listen for abnormal servo sounds. If problems are noted, correct them before flying. Look for binding pushrods or servo arms or pushrods that interfere with each other.
4. One at a time, operate each control on the airplane using the sticks on the transmitter to make certain each control is responding correctly. This **must** be done before **every** flight. (There are several types of malfunctions that can be discovered by performing this elementary task, thus saving your model!)

Range check the radio

A range check **must** be performed before the **first** flight of a new model. It is not necessary to do a range check before every flight (but is not a bad idea to perform a range check before the first flight of each day). A range check is the final opportunity to reveal any radio malfunctions, and to be certain the system has adequate operational range.

1. Turn on the transmitter, then the receiver. Leave the transmitter antenna all the way down. Walk away from the model while simultaneously operating the controls. Have an assistant stand by the model and signal what the controls are doing to confirm that they operate correctly. You should be able to walk approximately 20 - 30 paces from the model without losing control or seeing "jitter" in the servos.
2. If everything operates correctly, return to the model. Set the transmitter in a safe, yet accessible location so it will be within reach after starting the engine. Be certain the throttle stick is all the way **down**, then start the engine. Perform another range check with your assistant holding the plane and the engine running at various speeds. If the servos jitter or move inadvertently, there may be a problem. **Do not fly** the plane! Look for loose servo connections or binding pushrods. Also be certain you are the only one on your frequency, and that the battery has been fully charged.
3. When ready to fly, remember to fully extend the transmitter antenna. Avoid pointing the antenna directly at the model as the signal is weakest in that direction.

Do not fly in the rain!

Moisture may enter the transmitter through the antenna or stick openings and cause erratic operation or loss of control. If you must fly in wet weather during a contest, be sure to cover the transmitter with a plastic bag or other waterproof cover.

MODEL DATA RECORDING SHEET

After finalizing the programming for each model, fill out the values and settings in the **Model Data Recording Sheets** in the back of the manual. The data sheets will serve as a backup in case a program is ever lost or inadvertently reset, or in case you have to intentionally reset a program to make room for another model. Make additional copies before filling out the sheets.

MODEL DATA RECORDING SHEET

(Make copies before using)

Model name: _____

Model No. 1 • 2 • 3 • 4 Wing Mixing Inh • EL • v

MENU FUNCTION	CH 1	CH 2	CH 3	CH 4
REVERSE Servo Reverse	N • R	N • R	N • R	N • R
E. P. A End Point Adjust	▲ %	▲ %	▲ %	▲ %
	▼ %	▼ %	▼ %	▼ %
EXP Exponential setting				
	%	%		%

Model name: _____

Model No. 1 • 2 • 3 • 4 Wing Mixing Inh • EL • v

MENU FUNCTION	CH 1	CH 2	CH 3	CH 4
REVERSE Servo Reverse	N • R	N • R	N • R	N • R
E. P. A End Point Adjust	▲ %	▲ %	▲ %	▲ %
	▼ %	▼ %	▼ %	▼ %
EXP Exponential setting				
	%	%		%

FUTABA ACCESSORIES AND REPLACEMENT PARTS (for USA)

REPLACEMENT PARTS

ANT-5 Transmitter antenna	FUTM5040	SWH-13 Switch Harness w/charge plug	FUTM4370
NR-4J 4.8 Volt, 600 mAh receiver battery	FUTM1280	FSH-6X Servo arm	FUTM2030
NT-8F 600B 9.6 Volt, 600 mAh Transmitter battery	FUTM1440	FSH-6S Servo arm	FUTM2010
		FSH-32 Servo mounting screws (10)	FUTM2250

ACCESSORIES

FTA-8 Neck strap	FUTM5692	AEC-16 Dual H.D. Servo Extension (Y-connector, for digital servos)	FUTM4135
NR-4K 4.8 Volt, 250 mAh receiver battery	FUTM1210	AEC-13 Dual Servo Extension (Y-connector)....	FUTM4130
NR-4B 4.8 Volt, 1,000 mAh receiver battery	FUTM1380	SR-10 Dual Servo Reverser	FUTM4150
NR-4F 4.8 Volt, 1,500 mAh receiver battery	FUTM1285	Trainer Box transmitter	FUTM4375
AEC-3 8" [200mm] Servo Extension	FUTM3910	(if using with 4EX transmitter use the MD-TC trainer cord)	
AEC-14 8" [200mm] Heavy Duty Servo Extension (for digital servos)	FUTM4140	MD-TC trainer cord	FUTM4420
AEC-11 16" [400mm] Servo Extension	FUTM3955	MM-TC trainer cord	FUTM4415
AEC-15 16" [400mm] H.D. Servo Extension (for digital servos	FUTM4145		

Flight packs since your Futaba 4EX transmitter holds memories for up to four models, there is no need to purchase a complete radio system (including the transmitter) for every model you fly. Available separately, Futaba Flight Packs contain a receiver, servos, switch, battery and all servo mounting hardware. Consult your dealer or the Futaba Service Center for specific contents and order numbers.

Receiver crystals:

The receiver frequency may be changed as long as it remains within the "low" and "high" band frequency range. If your receiver is on any channel from 11 through 35, it is a "low band" receiver and the frequency may be changed to any other channel from 11 through 35 without having to perform any other service. Simply purchase a crystal on the desired channel, then replace the existing crystal in your receiver with the new one. If your receiver is on any channel from 36 through 60, it is a "high band" receiver and the frequency may be changed to any other channel from 36 through 60. To order a receiver crystal, replace the "***" in the order numbers below with the required channel number. (To order a receiver crystal on channel 30, order FUTL5730.)

FM Dual Conversion 72 MHz **low band** (channels 11 - 35) receiver crystal . FUTL57**

FM Dual Conversion 72 MHz **high band** (channels 36 - 60) receiver crystal . FUTL58**

Note: Should you ever wish to change the transmitter frequency, the transmitter must be sent to the Futaba Service Center for retuning.