

Trigger Ratio Check

-The throttle servo travel can be set to 50:50, 70:30 or 100:0 for throttle trigger operation as required by the Trigger function (page 62).

-The throttle brake operation might be close by setting it to "100:0" when the T7PX transmitter with the boat is used.

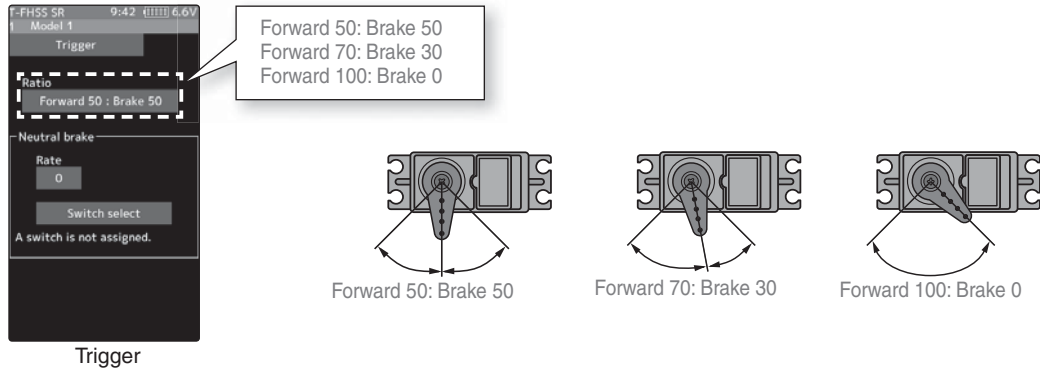

Trims Initial Set-Up

- Steering trim (DT1) check

On the initial set-up, steering trim is assigned to the DT1 trim lever above. Operate the lever and make sure the marker moves on the ST graph. If default has been changed, test steering trim in its new location. After checking the trim, set the trim display to the center (N) position.

- Throttle trim (DT2) check

On the initial set-up, throttle trim is assigned to the DT2 trim lever. Operate the lever and make sure the marker moves on the TH graph. If the default has been changed, test the throttle trim in its new location. After checking the trim, set the trim display to the center (N) position.

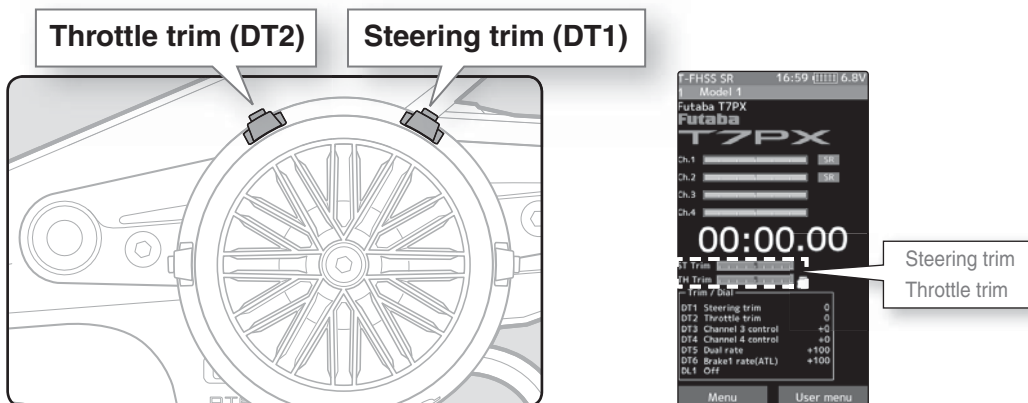

- Steering dual rate (DT5) check

At initial set-up, steering dual rate (D/R) is assigned to DT5 trim lever, at the grip of the transmitter. Operate the DT5 and check if the D/R value displayed on the screen changes. After checking D/R, set the steering dual rate to 100%.

- Brake rate (DT6) check

At initial setting, brake rate (Brake1 rate) is assigned to DT6 trim lever, below DT6. Operate the DT6 and check if the Brake1 rate value displayed on the screen changes. After checking Brake1 rate, set brake rate to 100%.

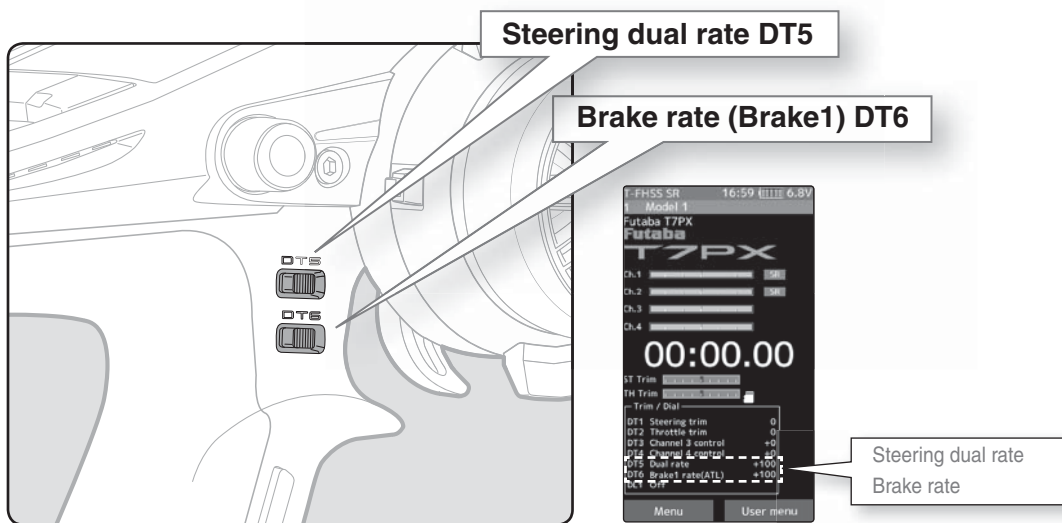

(Set-Up Procedure When Installed In a Car)

When installing the servos in a car, performing function set-up in the following order is recommended.

- 1** Initialize all the trims to zero / dual rate to 100.
- 2** Set the servo direction of operation using the Reverse function. (page 47)
 - The servo installation method and linkage direction depend on the kit. Therefore, the servo operation direction may have to be reversed relative to transmitter operation. Before installing the servo, check the operating direction and set it using the Reverse function.
- 3** Set the subtrim and adjust the servo neutral point. (page 48)
- 4** Set the trigger travel by adjusting the throttle trigger mechanical ATL to your liking. (page 18)
 - When the stroke was adjusted, compensate the throttle by calibration function (page 156).
- 5** Set EPA of each channel and adjust the servo throw (travel). (page 49)

Menu Selection

Use the home button and the LCD screen touch panel to operate the screen.
In this operation manual, the HOME button is indicated by the following symbols.



Push the Home button or tap the touch panel.



Press and hold the Home button.

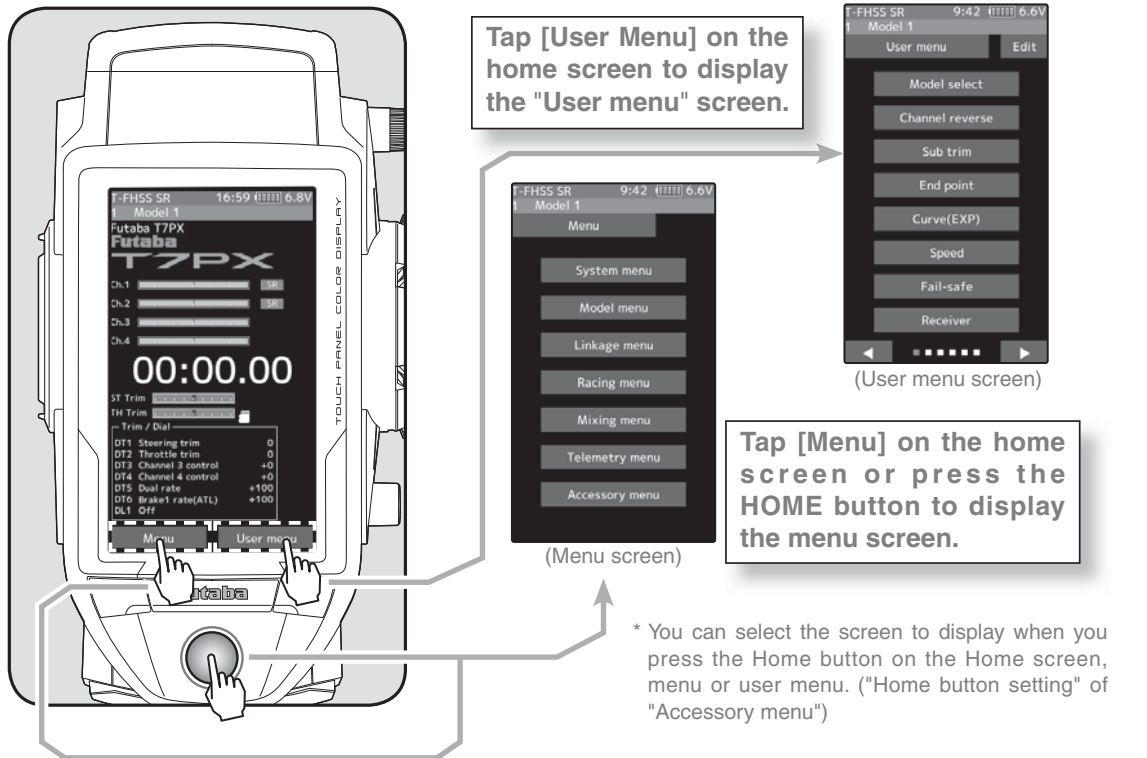

Function Map

It returns to the "Home screen" from the function screen in the following method.

* An example is to return from the "End point" screen to the "Home" screen.

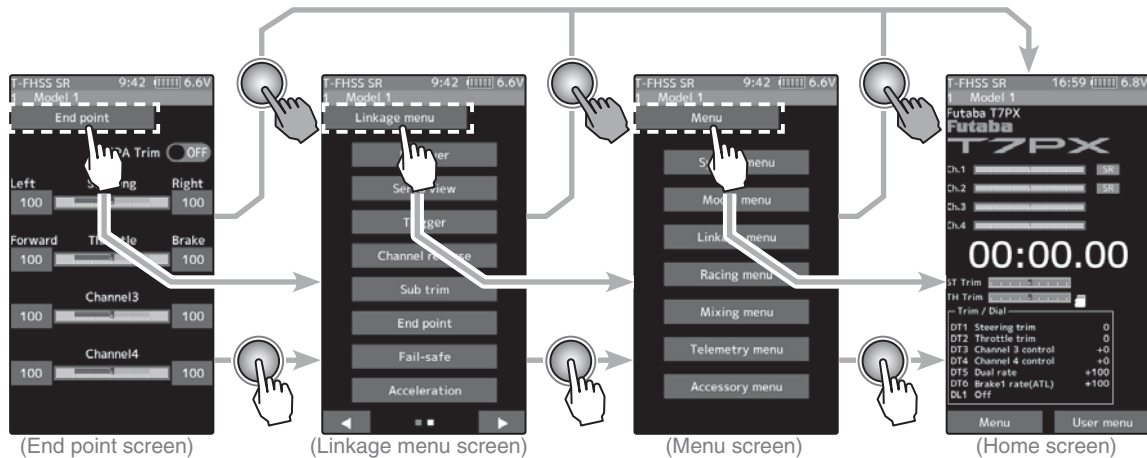

Home Button Setting

When you push the Home button from the home screen, it moves to the menu screen at the factory shipping the home button. Pushing the Home button on the menu screen or each setting screen will return you to the previous screen. Also, if you press and hold the Home button on the Home screen, the trim lock will work and the T7PX can prohibit operations with the digital Trim DT 1 to DT 6 and Dial DL 1 on the main unit. Press and hold the Home button on the menu screen or each setting screen to return to the Home screen. The setting screen moved from the custom menu also moves in the same way and returns to the home screen.

You can select the screen to display when you push the Home button on the Home screen, menu or user menu. You can not change the screen to display by push and holding the Home button from the menu screen or each function screen.

- Push-----Display menu screen or custom menu screen.
- Long press-----Trim lock or display the function screen of your choice.

"Home button setting" of "Accessory menu" (page 151)

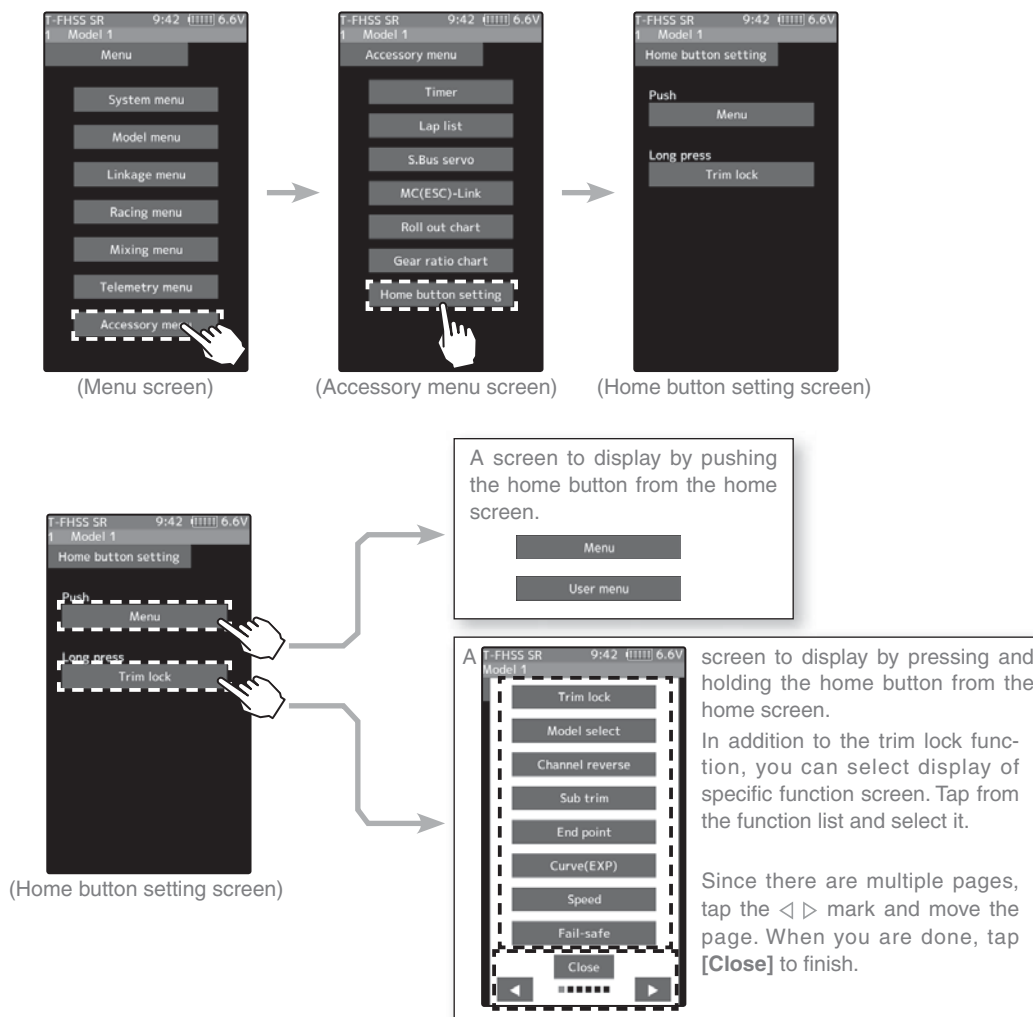

Value Of Each Function And Changing The Set Value

On the setting screen of each function, if you tap the item to be set, [-] [reset] [+] will be displayed at the bottom of the screen, tap the [-] [+] on the panel Set. Tap [Reset] to return to the initial value. There are items with no [reset].

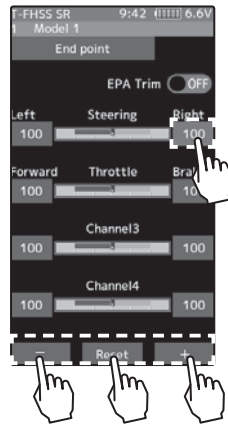

Example: To change the right-hand side steering amount on the end point screen, tap the right of the steering wheel, and when [-] [reset] [+] is displayed at the bottom of the screen, press + To decrease, tap [-] to change the numerical value. If you leave it tapped, the value changes continuously. Tap [Reset] to return to the initial value.

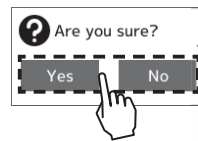

When resetting is executed, a confirmation screen is displayed. To reset, tap [Yes], otherwise tap [No].

The setting of ON / OFF changes when you tap (ON) or (OFF).

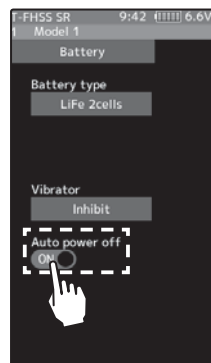

Example: When turning off the auto power off function on the battery setting screen, tap (ON) of auto power off to display (OFF) and the function will be invalid.

To select from multiple items, tap [Item] and tap from the screen of the displayed list to select it.

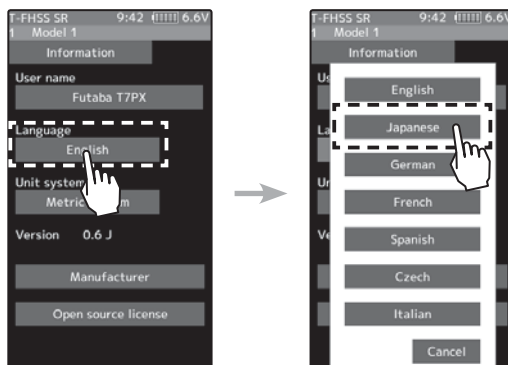

Example: Tap the display language [English] on the system information setting screen, the list screen of available languages will be displayed. To change to German, touch [German], the screen display becomes German. If you do not want to change, tap [Cancel] to close the screen.

* Depending on the function, items may be switched in order by tapping.

User Menu

The T7PX allows you to register your favorite functions in the user menu. You can create a different user menu for each model memory, and the user menu will also be copied by model copy (page 171). (8 types on a page, up to 48 types on 6 pages)

Displaying And Editing The User Menu Screen

On the user menu screen, you can display the user menu screen by tapping [User Menu] on the home screen. (See page 44)

* It is possible to display by pushing the home button with the "Home button setting" function.

Menu assignment

- 1 Touch [Edit] on the user menu screen. A confirmation screen will appear with "User menu setting Are you sure?" To edit, tap [Yes] to display the edit screen. If you do not want to edit it, please tap [No].

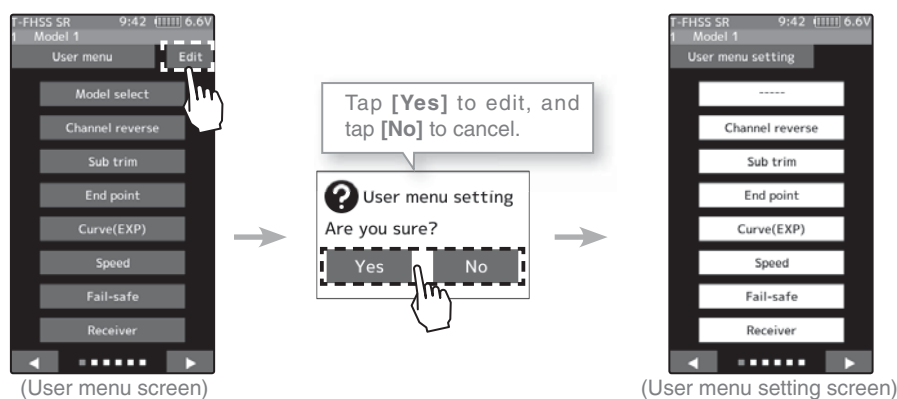

- 2 Tap the place to register the function. A list of the functions that can be selected will be displayed, so if you tap the function you want to register, it will be registered.

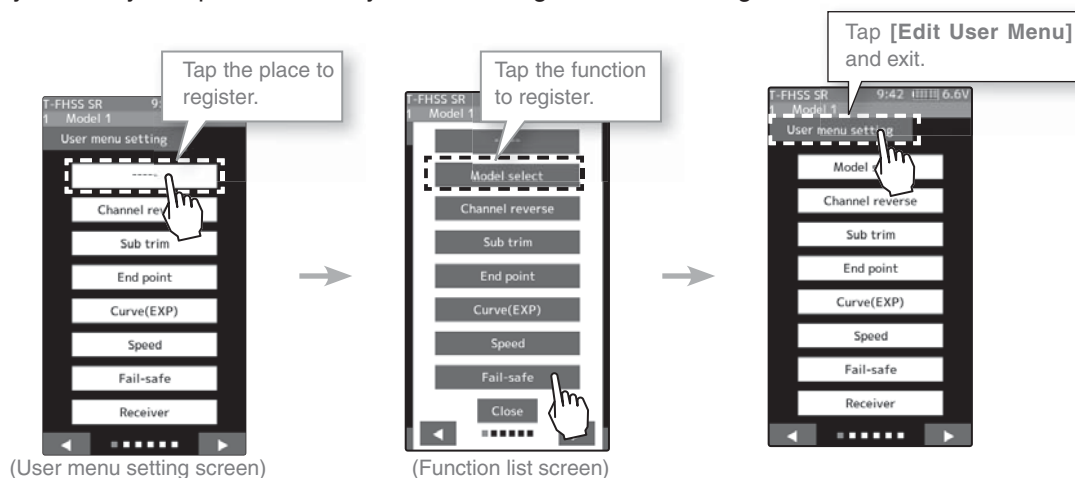

- 3 Tap [Edit User Menu] to exit and return to the user menu screen.

Function List

Function Name	Description Of Function	Page
Display	Backlight brightness setting / dimming time setting / touch panel correction	176
Information	Language setting / version information	178
Sound	Sound setting (telemetry sound, alarm sound, operating sound)	180
Battery	Battery type setting / Auto power off ON / OFF	181
Date and time	Date and time setting / Displaying the time on the home screen or selecting the total timer	182
LED setting	Pilot LED on/off	183
Calibration	Steering wheel and throttle trigger correction	184
Software Update	Updated with terminal app on NFC	186
Model select	Model memory call	170
Model copy	Model memory copy	171
Model name	Model memory name set/modify	173
Model delete	Delete model data in SD card	174
Data reset	Model memory reset (Model, Direct menu, All)	175
Receiver	Receiver system/servo response selection/linking with T-FHSS SR & T-FHSS system receive/ Telemetry ON / OFF	37/52
Servo view	Displays servo operation on a bar graph	64
Trigger	Neutral brake and throttle servo forward side and brake side operation rate setting	62
Channel Reverse	Servo operation reversing	53
Sub Trim	Servo center position fine adjustment	54
End point	End point adjustment	55
Fail safe	Fail safe, battery fail safe	58
Acceleration	Reduces the "lag time" of the throttle from the neutral position.	60
Trim / Dial select	Selection of functions operated by digital dial and digital trim	66
Switch select	Selection of functions operated by push switches	69
Condition	2ND condition	76
Idle up	Idle up at engine start	72
D/R,ATL	Steering angle adjustment while running/ Brake side adjustment	65

Function List		
Function	Description Of Function	Page
Channel limiter	A channel limiter function which limits maximum servo movement.	74
Channel setting	Ability to assign steering or throttle motion to any channel.	75
Curve(EXP)	Steering curve adjustment / Throttle curve adjustment	78
Speed	Steering servo delay / Throttle servo delay	84
Traction control	Pulse throttle operation.	95
A.B.S	Pulse brake	90
Start	Throttle preset at start function	99
Engine cut	Engine cut off by switch	101
Steering mixing	Twin servo mixing of the steering	103
Brake mixing	Front and rear independent brake control for 1/5GP car, etc.	106
Gyro mixing	The sensitivity of Futaba car rate gyros can be adjusted	110
4WS mixing	4-wheel steering mixing	113
Dual ESC	Front and rear ESCs mixing	116
CPS mixing	The CPS-1 of Futaba LED controller can be adjusted.	118
Tank mixing	For Tank mixing	120
Program. mixing 1-5	Programmable mixing between arbitrary channels	122
Tilt mixing	Outboard engine tilt mixing	125
Telemetry	Telemetry data screen	153
Sensor list	Telemetry sensors list	162
Sensor menu	Telemetry sensors setting	164
Timer	Up, down, lap, or lap navigation timer	127
Lap list	Lap timer data (lap time, average lap, best lap time) check	134
S.BUS servo	S.BUS servo Link software setting / SR mode setting	135
MC-Link	MC851C/602C/402CR/950CR/940CR/960CR Link software setting function	140
Roll out chart	For DD car roll out chart	149
Gear ratio chart	Gear ratio calculation function.	150
Home button setting	Change the function of the home button	151

Function map

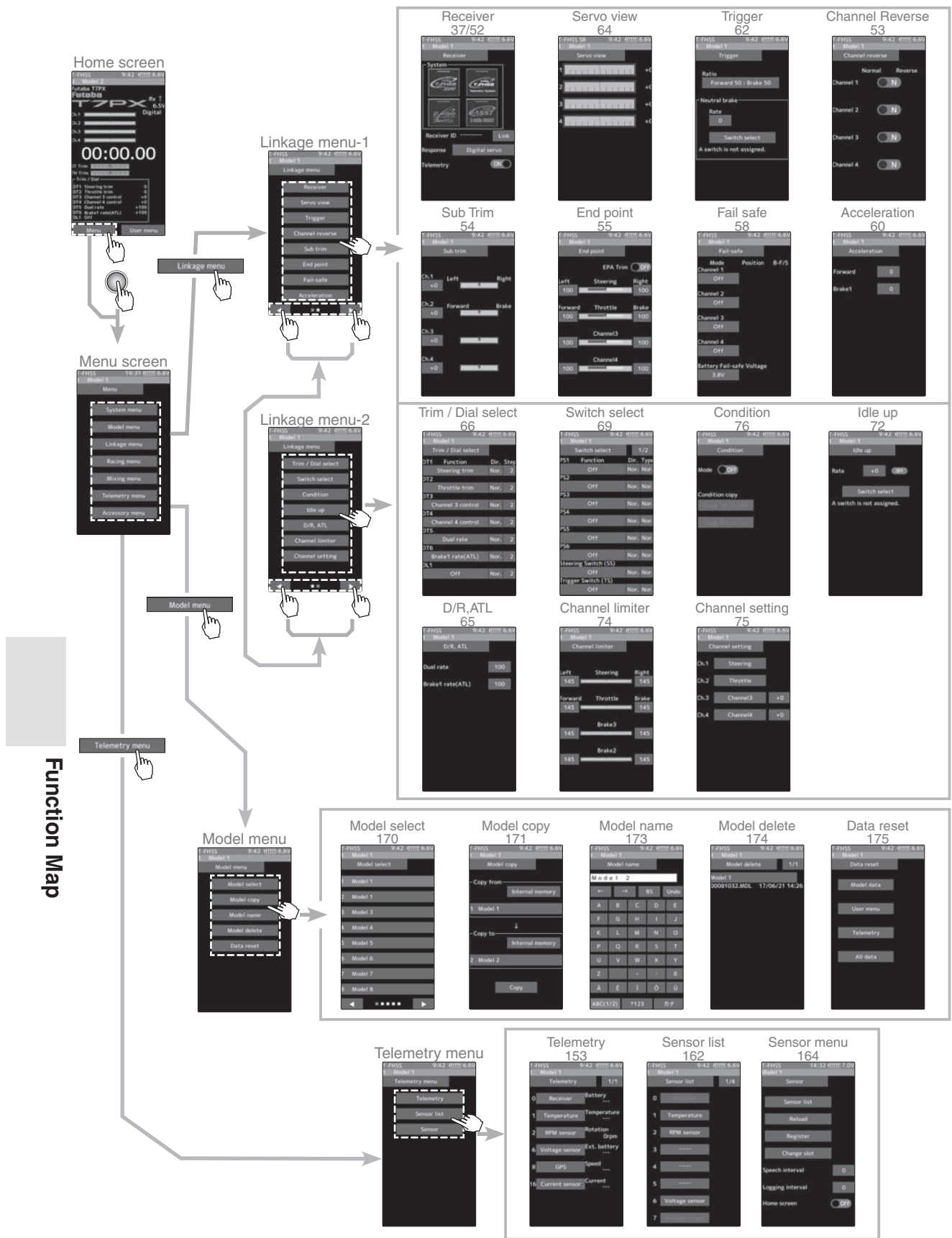

Function Map

Function map

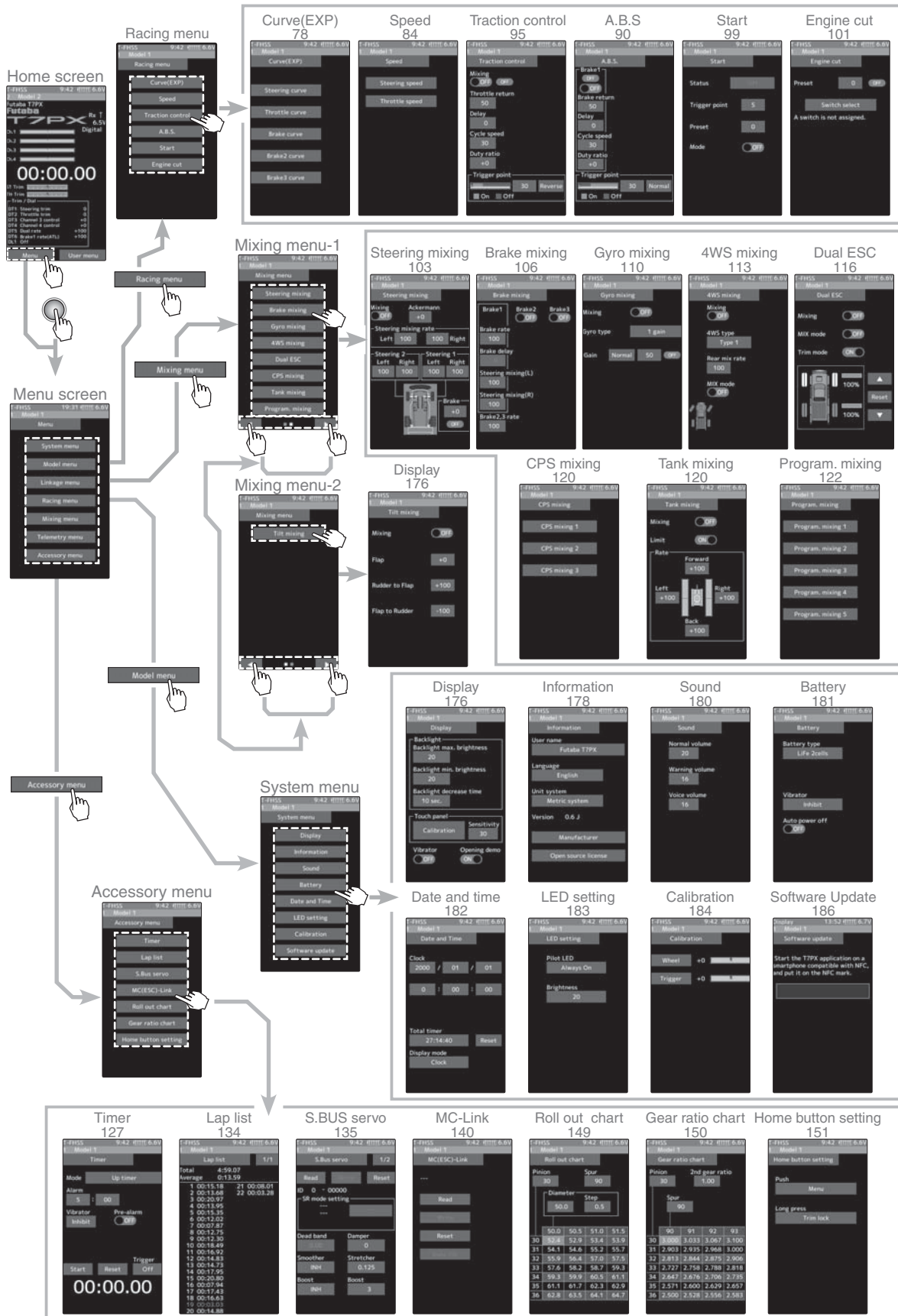

Function Map

Receiver

This menu selects the settings matched to the receiver system used and the type of servo and the items selected at the T7PX, linking of the T7PX with the T-FHSS telemetry system, and ON/OFF.

The receiver setting and selection and linking of the T7PX transmitter with T-FHSS SR, T-FHSS telemetry system receiver are described on page 37~41.

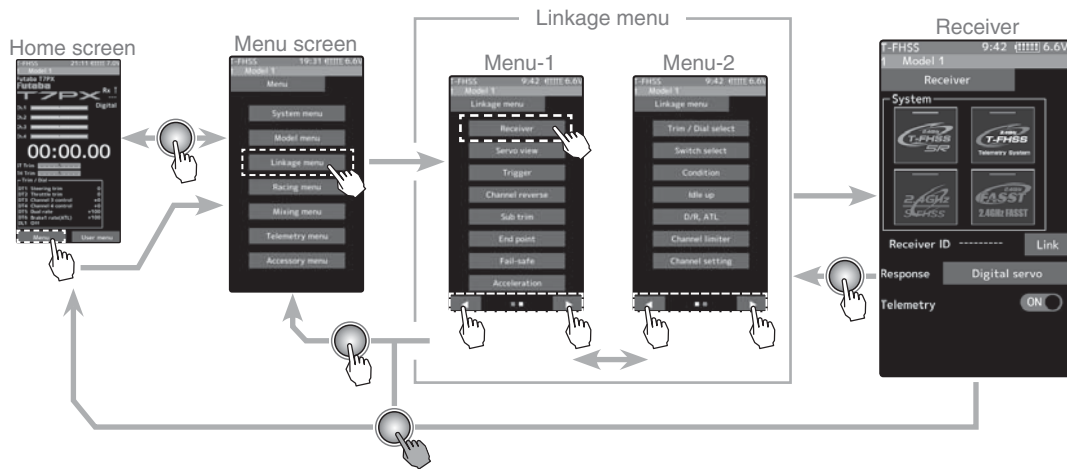

Telemetry function ON/OFF

- 1 (Function ON/OFF)
Tap telemetry (ON) or (OFF) to select ON / OFF.

"OFF" : Telemetry function OFF
"ON" : Telemetry function ON

Setting
- Tap (ON) / (OFF).

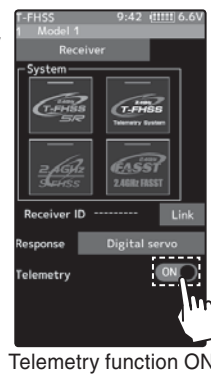

- 2 When finished, return to the Linkage menu screen by pressing the HOME button.

Channel Reverse

This function reverses the direction of operation of the servos related to transmitter steering, throttle, channel 3, and channel 4 operation.

However, when the position set by trim or sub trim shifts from the center, the center becomes the opposite side.

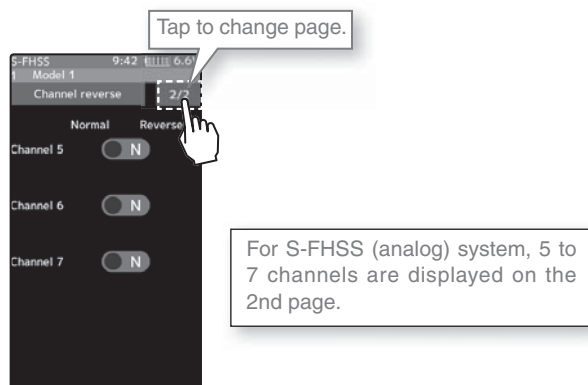
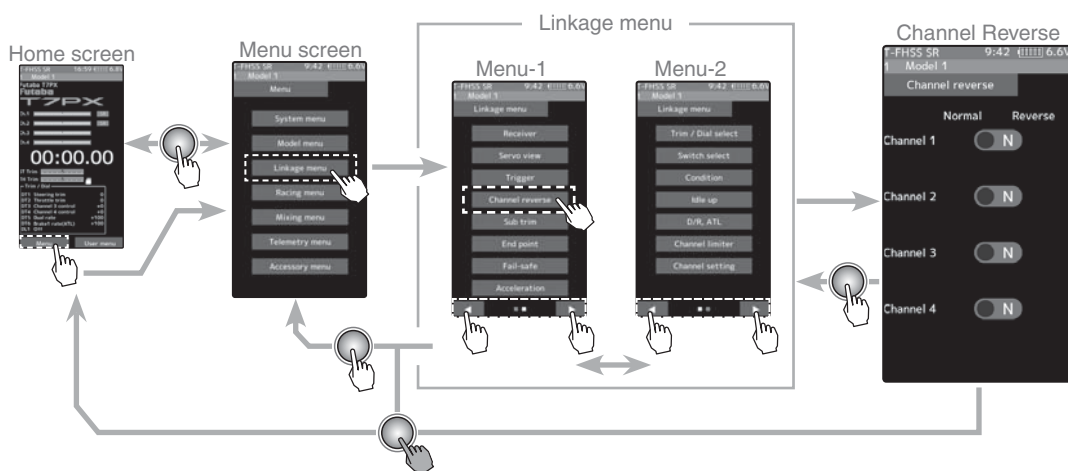

Servo Reverse Function Setting

- 1 (Servo reverse setting)
Tap the desired channel's setting button to choose the proper direction for the servo.
(Each channel can be set similarly.)

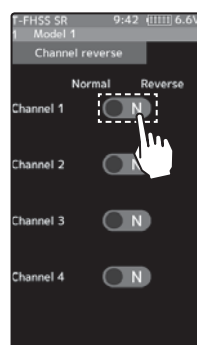

Setting
- Tap (R) / (N).
(N) Normal / (R) Reverse

- 2 When finished, return to the Linkage menu screen by pressing the HOME button.

Sub trim

Use this function to adjust the neutral position of the steering, throttle, channel 3 and channel 4 servos.

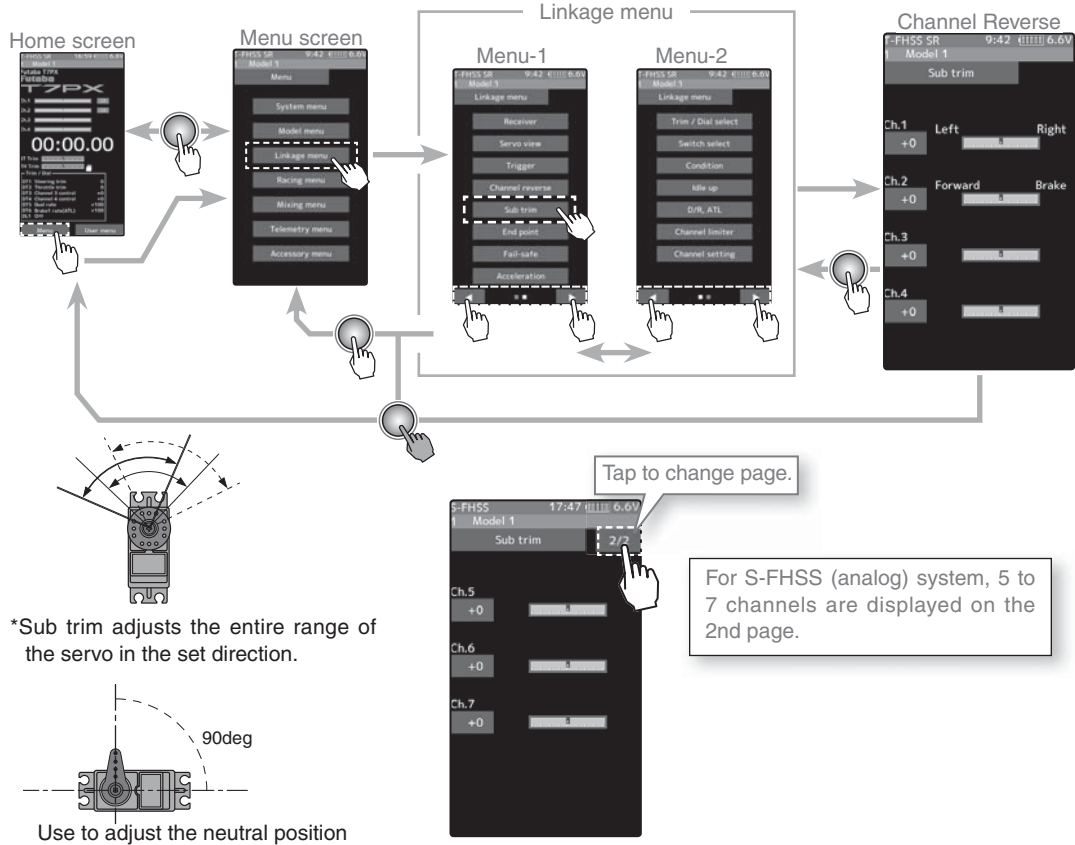

Sub trim adjustment

(Preparation)

- Follow the instructions of the model, install the servo horn and make the next adjustment.
- Set the steering and throttle digital trims to the neutral "0" position. Set auxiliary channels to the center "0" position.
- Tap the trim display part of the channel you want to adjust. Value input buttons appears on the Sub-trim menu screen.

Adjustment buttons

- Adjust with the [+] and [-] buttons.
- Return to the initial value by tapping the [reset] buttons.

Sub trim

-100~+100
Initial value : 0

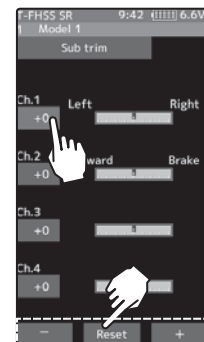

- 1 (Sub trim adjustment)
Use the [+] or [-] button to adjust the center.
(Each channel can be set similarly.)

- 2 When finished, return to the Linkage menu screen by pressing the HOME button.

End Point

Use this when performing left and right end point adjustments, throttle high side/brake side operation amount adjustment, channel 3 and channel 4 servo up side/down side operation amount adjustment.

- Correct the maximum steering angle for left and right steering angles when there is a difference in the turning radius due to the characteristics of the vehicle.

Maximum steering angle

The End point function basically determines the maximum steering angle of each channel.

The functions shown below may have been adjusted or the operating range set by End point function may be exceeded. Check the linkage each time the following functions are adjusted.

- Sub trim (all channels)----- page 54
- Program mixing slave side (all channels) -----page 122
- Idle up (throttle)----- page 72
- Engine Cut (throttle) -----page 101
- Throttle acceleration (throttle) ----- page 60

Brake rate trim

Brake rate trim allows adjustment of the brake side operation amount during operation. Therefore, when the operating angle is adjusted with throttle End point, brake rate trim must also be taken into account.

Warning

- ❗ Operate each servo over its full stroke and be sure the linkage does not bind or is not loose.
The continuous application of unreasonable force to a servo may cause damage and excessive battery drain.

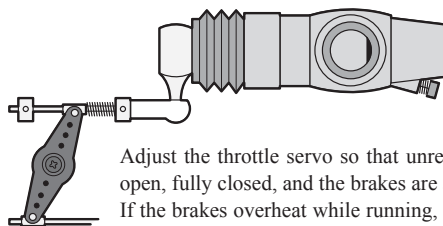
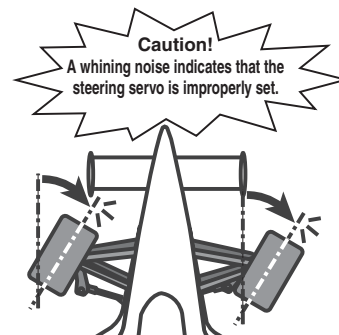

Adjust the steering servo so that unreasonable force is not applied to the servo by the chassis at maximum servo travel.

Decide the End point value at the contact point.

Adjust the throttle servo so that unreasonable force is not applied when the engine carburetor is fully open, fully closed, and the brakes are applied fully.
If the brakes overheat while running, their ability to function properly decreases. Before running, adjust the suitable maximum servo travel so that unreasonable force is not applied even when the servo travel is increased while running.

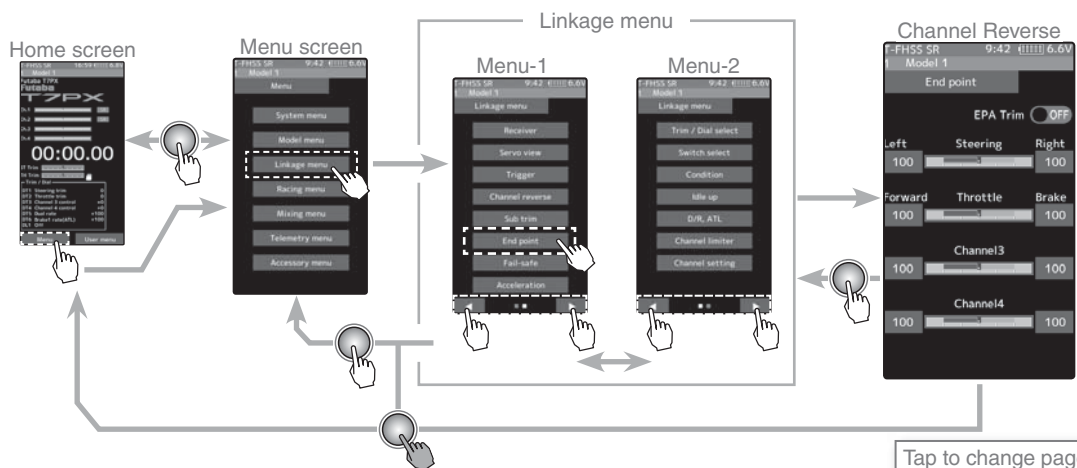

Steering end point adjustment

(Preparation)

- Before setup of the steering end point adjustment, set the steering D/R dial (initial setup: DT5) to the maximum steering angle position 100%.
- Tap the travel button of the [Steering Left]. Value input buttons appear on the screen and make the following adjustments:

1 Steering (left side) adjustment
Turn the steering wheel fully to the left and use the [+] or [-] buttons to adjust the steering angle.



2 Steering (right side) adjustment
Turn the steering wheel fully to the right and use the [+] or [-] buttons to adjust the steering angle.



Note

Step #1 & #2 are done when the receiver is in the on position installed on the chassis. You're watching the wheels reach their maximum end point.

3 When finished, return to the Linkage menu screen by pressing the HOME button.

Tap to change page.

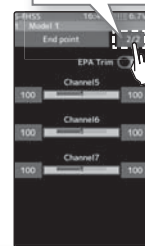

For S-FHSS (analog) system, 5 to 7 channels are displayed on the 2nd page.

Adjustment buttons

Adjust with the [+] and [-] buttons.

- Return to the initial value by tapping the [reset] buttons.

Steering End point :0~140

Initial value :100

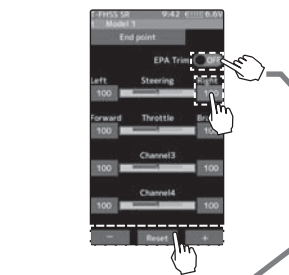

Quick EPA

When EPA trim is turned on, the steering angle (end point) can be adjusted by steering trim set digital trim or dial. (Steering trim initial setting: DT1)

Steering left side adjustment

With the steering wheel turned fully to the left, steering is adjusted by steering trim. Temporarily displayed at this part of the HOME screen as shown in the figure below.

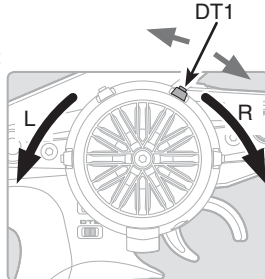

Steering right side adjustment

With the steering wheel turned fully to the right, steering is adjusted by steering trim. Temporarily displayed at this part of the HOME screen as shown in the figure below.

Throttle end point adjustment

(Preparation)

- Before setting the throttle end point adjustment, set the throttle ATL dial (initial setup: DT6) to the maximum throttle angle position 100%.
- Tap the travel button of the [Throttle Forward]. Value input buttons appear on the screen and make the following adjustments:

- 1** Throttle (forward side) adjustment
Pull the throttle trigger fully to the high side and use the [+] or [-] buttons to adjust the throttle angle. However, when using an ESC, set to 100%.



- 2** Throttle (brake side/reverse side) adjustment
Move the throttle trigger fully to the brake side and use the [+] or [-] buttons to adjust the throttle angle. However, when using an ESC, set to 100%.



- 3** When finished, return to the Linkage menu screen by pressing the HOME button.

Adjustment buttons

- Use the [+] and [-] buttons to make adjustments.
- Return to the initial value by tapping the [reset] buttons.
- Please see previous note on page 56.

Throttle End point :0~140
Initial value :100



When Trigger Ratio (page 62) was set to 100:0, brake operation is stopped and the throttle (brake side) cannot be adjusted.

Auxiliary channel servo end point adjustment

(Preparation)

- Tap the travel button of the channel you want to set. Value input buttons appear on the screen.

- 1** Use the [+] or [-] buttons to adjust the servo angle.

Adjustment buttons

- Use the [+] and [-] buttons to make adjustments.
- Return to the initial value by tapping the [reset] buttons.
- Please see previous note on page 56.

Auxiliary channel End point :0~140
Initial value :100

Spare channel display

When a mixing function is set at a spare channel, the display changes.

This is an example of setting dual ESC mixing at the 3rd channel and 4WS mixing at the 4th channel.

Dual ESC mixing :Front ESC
4WS mixing: Rear servo

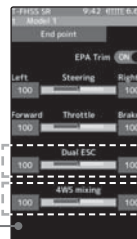

- 2** When finished, return to the menu screen by pressing the (END) button.

Fail-Safe/ Battery Fail-Safe Function

This function sets the servo operation position when transmitter signals cannot be received by the receiver for some reason or the battery voltage has dropped.

-Fail safe mode

This function moves each servo to a preset position when the receiver cannot receive the signals from the transmitter for some reason.

- * The fail safe data is transferred from the transmitter to the receiver 10 seconds after the transmitter power was turned on.
- * The data is transferred every 10 seconds after that. Be careful because normally the transmitter power is turned on first and the receiver power is turned on next and there is no data transfer for about 10 seconds after the receiver power is turned on.
- * For gasoline engine cars, for safety we recommend that this fail safe function be used to set the throttle channel in the direction in which the brakes are applied.

-Hold mode

This function holds the receiver in its position immediately before reception was lost.

-Off mode (OFF)

This function stops output of signals to the servos and places the servos into the free state when the receiver cannot receive.

The F/S, HOLD, and OFF modes are automatically reset when signals from the transmitter can be received again

-Battery fail safe function (B-F/S)

If the receiver battery voltage drops below a certain value when this function is enabled, the throttle servo moves to the position set by fail safe function. When the battery voltage recovers, the battery fail safe function is automatically reset.

- * This function cannot be used when the channel is not set to fail safe.
- * When the receiver setting (page 37) is "FASST", only CH2 (throttle) can use this function.

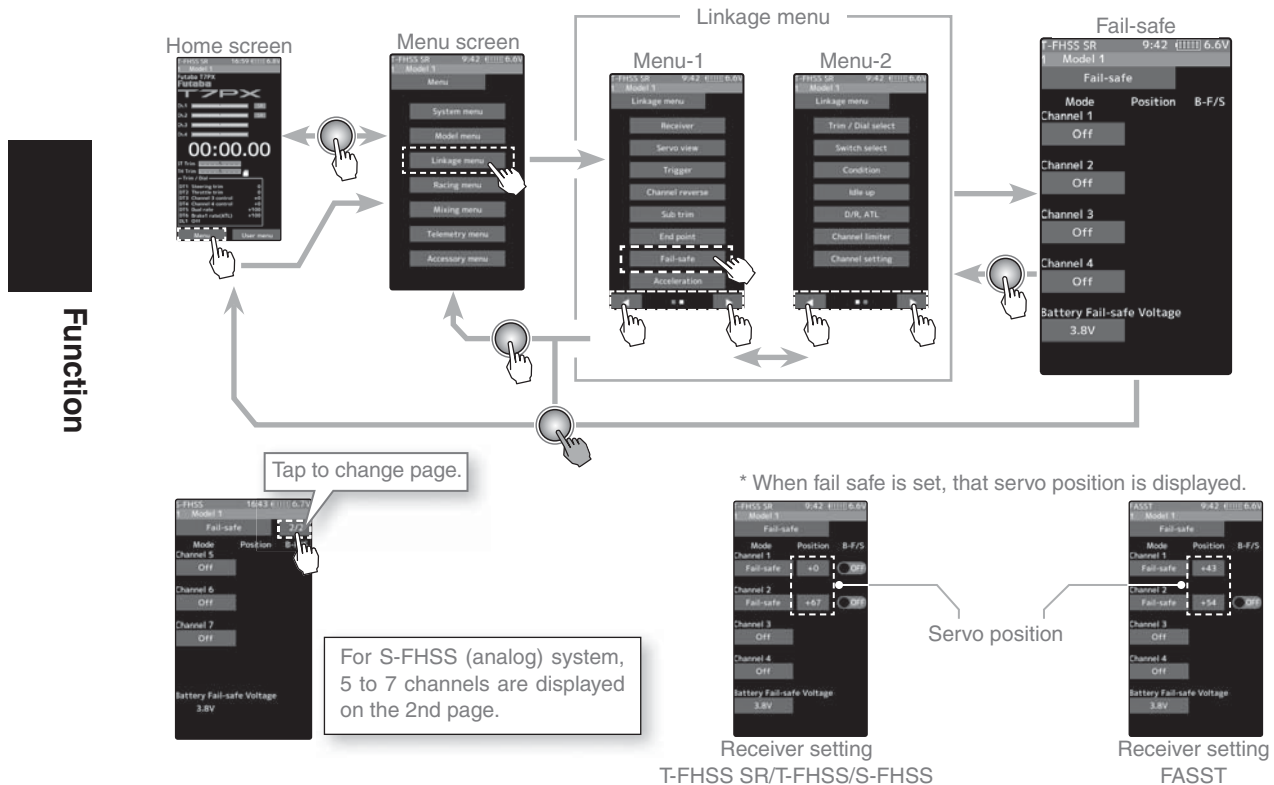

Fail safe mode selection

(Preparation)

- Tap the fail safe part of the channel you want to set. The mode list appears on the Fail-safe menu screen.

1 (Mode selection)

Tap from the list and select the mode. To cancel, tap [Cancel].

(Each channel can be individually set.)

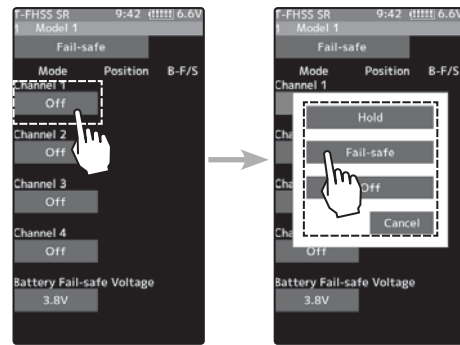

Fail safe mode
Off, Hold, Fail-safe

- ### 2
- When finished with hold or off mode setting, return to the Linkage menu screen by pressing the HOME button. When setting fail safe, set the servo position by the following method.

Fail safe function setup

1 (Servo position setup)

Tap the F/S button of the channel you want to set, and set that channel to the [F/S] mode.

Hold the corresponding steering wheel, throttle trigger, or other control in the position you want the servo to move to when the fail safe function is activated, and tap the F/S position button.

That position is displayed in percentage.

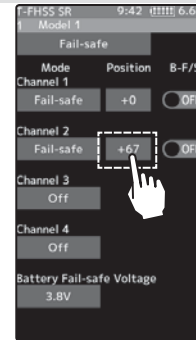

Fail-Safe position setting

While holding the wheel or trigger, tap the Fail-Safe position button.

- ### 2
- When finished, return to the Linkage menu screen by pressing the HOME button.

B-F/S function ON/OFF & Battery Fail-safe voltage setting

1 (Battery fail safe function ON/OFF)

Tap B-F /S (ON) or (OFF) of each channel to select ON / OFF.

2 (Battery fail safe voltage setting)

Tap the voltage display of battery fail safe voltage. Value input buttons appears on the Fail-Sahe menu screen.

Use the [+] or [-] button to select the voltage.

* Voltage setting is not possible with the S - FHSS system fixed at 3.8 V.

* Since FASST R604 Series receivers are not for high voltage use, the use of LiFe and Li-Po batteries is prohibited. Therefore, the 4.75v and 5.5v settings are prohibited. The 5.5 V setting of the FASST system can only be used by the receiver with R614FS (FSE).

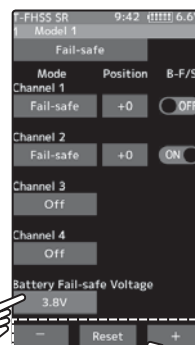

Battery fail safe function

OFF, ON
Initial value: OFF

Battery Fail-safe Voltage

T-FHSS SR/T-FHSS
3.8,4.0,4.2,4.4,4.6,4.8,5.0,
5.3,5.6,5.9,6.2,6.5,6.8,7.1,7.4V
FASST
3.5,3.8,4.4,4.75
5.5V(Only R614)
S-FHSS
Only 3.8V

Example:

Ni-MH /Ni-Cd 4cell---3.8V
Ni-MH /Ni-Cd 6cell---4.4V
LiFe 2cell---4.75/4.8V
Li-Po 2cell---5.5/5.6V

- ### 3
- When finished, return to the Linkage menu screen by pressing the HOME button.

When the receiver power supply of an electric car uses a common power supply from an ESC, we recommend that this function be set to OFF because the voltage supplied to the receiver may drop momentarily and the battery fail safe function may be activated.

Acceleration

The servo will jump to the input position at its maximum possible speed. Unlike exponential, which adjusts the whole throttle movement into a curve, throttle acceleration simply "jumps" away from neutral and then leaves the remaining response linear.

Operation

- Operation near the throttle trigger neutral position becomes a sharp rise.
- The forward and brake sides can be set separately.
- When the brake mixing function (page 80) is set, the auxiliary channel brake can also be set.

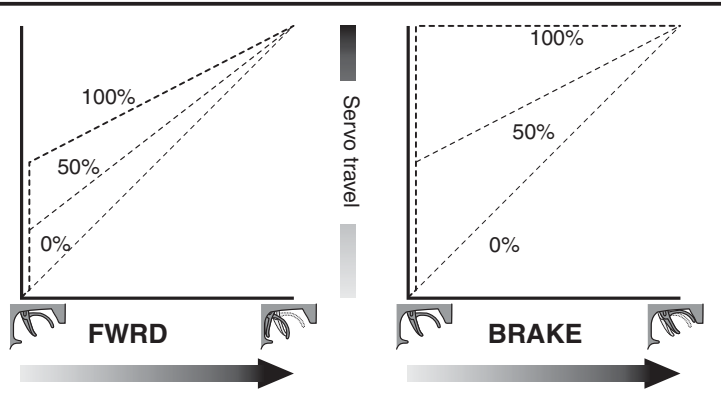

Set value

The standard value (100% point) of this setup affects the operation amount set by throttle end point function.

Convenient usage method

For gasoline engine cars, the linkage must have a clearance because one servo controls the engine carburetor and brake. Thus, there is a noticeable time delay at both the forward and brake sides. Sharp response comparable to that of electric motor cars is obtained by reducing this clearance at the transmitter side.

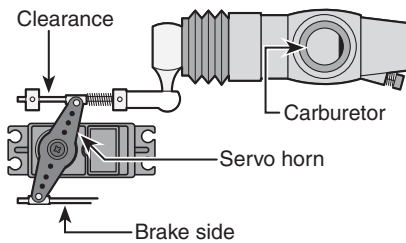

Function

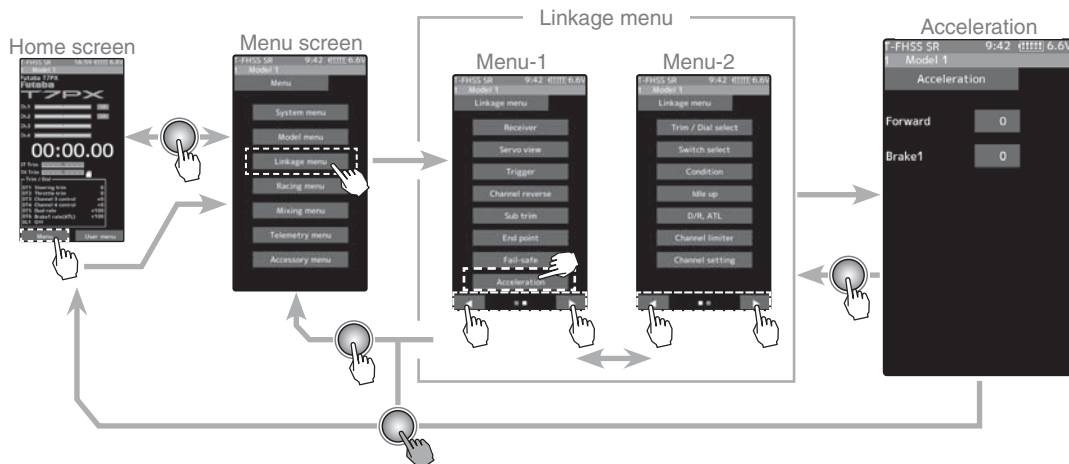

Throttle acceleration adjustment

(Preparation)

- Tap the value button of the [Forward]. Value input buttons appear on the screen and make the following adjustments:

1 (Forward acceleration amount adjustment)

Use the [+] and [-] buttons to adjust the acceleration amount.

"0" :No acceleration

"100" :Maximum acceleration (Approximately 1/2 of the forward side throttle angle)

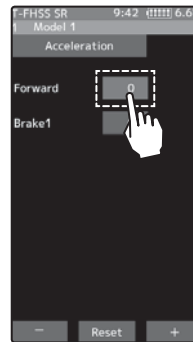

Adjustment buttons

- Adjust with the [+] and [-] buttons.
- Return to the initial value by tapping the [reset] buttons.

Forward acceleration amount (Forward)

0~100
Initial value: 0

2 (Brake side acceleration amount adjustment)

Tap the travel button of the [Brake1]. Value input buttons appear on the screen and use the [+] and [-] buttons to adjust the acceleration amount.

"0" :No acceleration

"100" :Maximum acceleration (Brake side maximum throttle angle)

If the "Brake Mixing Function" (page 106) is being set, the auxiliary channel brake side acceleration will become adjustable.

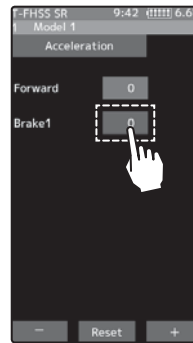

Brake side acceleration amount (Brake1)

0~100
Initial value: 0

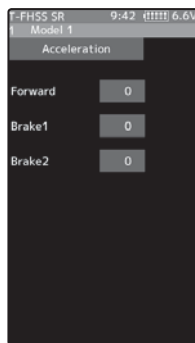

Brake 2

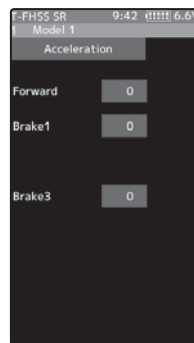

Brake 3

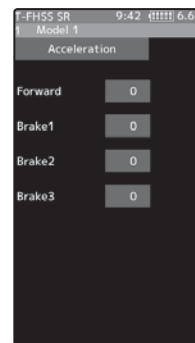

Brake 2&3

3 When finished, return to the Linkage menu screen by pressing the HOME button.

Caution

When Trigger Ratio (page 62) was set to 100:0, brake operation is stopped and the throttle (brake side) cannot be adjusted.

Dial / Trim Setting

The throttle acceleration adjustment amount (Forward), (Brake1), auxiliary channels (Brake2, Brake3) can be controlled with digital trim DT1-DT6 or digital dial DL1 etc. with the dial select function. (page 66)

Trigger

This menu has the following 2 functions:

-Servo neutral mode:

This function allows selection of the forward side and brake (reverse) side operation ratio from 70:30, 50:50 or 100:0 by changing the neutral position of the throttle servo.

-Neutral brake:

This is a function select switch function. The neutral brake function ON/OFF switch must be set (see page 69).

The neutral brake, which applies the brakes at the neutral position of the throttle trigger, can be set. However, when using the MC950CR, MC851C, MC602C, MC402CR, or other Futaba ESC, confirm that the ESC is in the neutral position and the set is in the operation mode before setting the neutral brake function switch to ON.

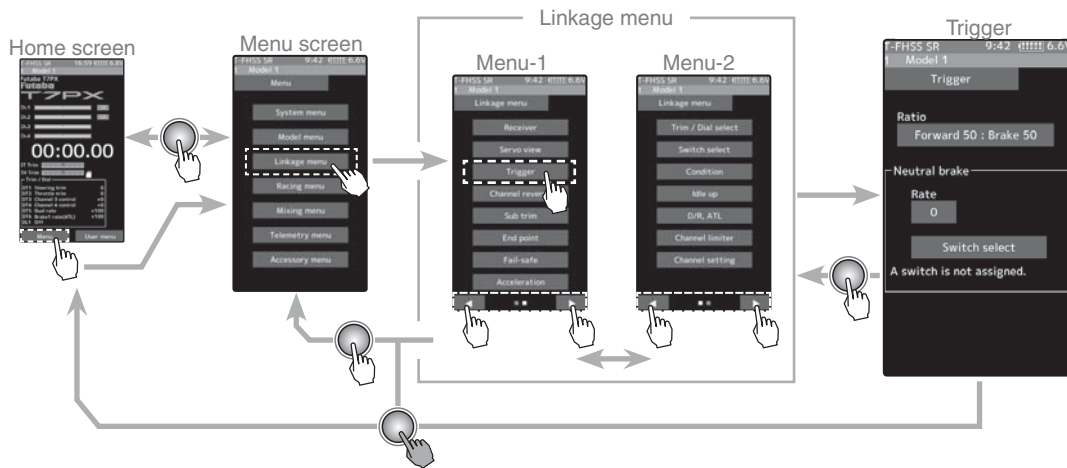

Throttle servo neutral position "Ratio"

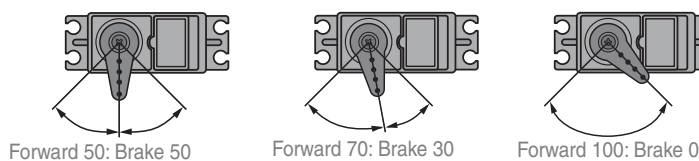

Selecting the trigger ratio

1 (Throttle mode selection)

- Tap the [Ratio] part.

The mode list appears on the Trigger menu screen.

Tap from the list and select the mode. To cancel, tap [Cancel].

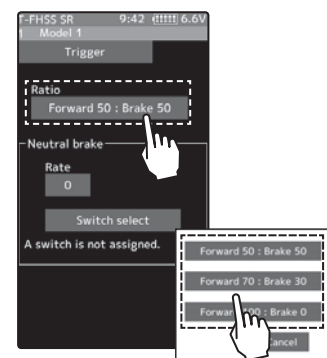

Ratio mode

Forward 50:Brake 50

Forward 70:Brake 30

Forward 100:Brake 0

2 When finished, return to the Linkage menu screen by pressing the HOME button.

Neutral brake "Rate"

Neutral Brake function adjustment

(Preparation)

- Use the switch select function to the "Switch select". (page 69)
When the switch is not set "A switch is not assigned" is displayed. Tap [Switch select] to display the switch selection screen and set the switch.

1 (Neutral brake rate)

Tap the value button of the [Rate]. Value input buttons appear on the screen and use the [+] and [-] buttons to adjust the neutral brake rate amount.

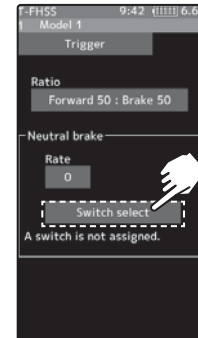
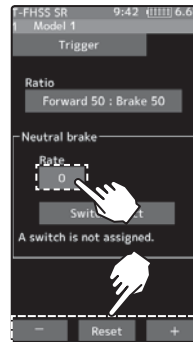

Adjust button

Adjust with the [+] and [-] buttons.

- Return to the initial value by tapping the [reset] buttons.

Neutral Brake

0~100
Initial value: 0

2 When finished, return to the Linkage menu screen by pressing the HOME button.

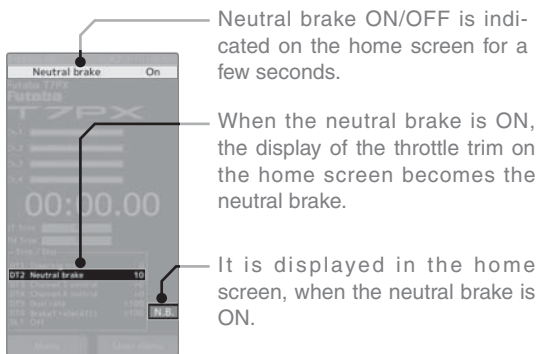

If the power switch is turned on while the neutral brake switch is on, an audible alarm will be heard. Immediately set the neutral brake switch to OFF.

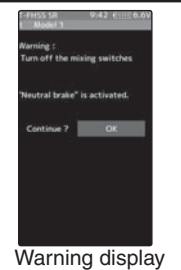

Warning display

Reference

The ESC neutral brake function and T7PX neutral brake function can be used simultaneously. However, when setting is difficult to understand, we recommend that only one neutral brake function be used.

Dial / Trim Setting

When the neutral brake function is "ON", the neutral brake rate adjustment is automatically assigned to the throttle trim (DT1~DT6 or DL1).

Effect of set value of other functions on neutral brake

Throttle side EPA function, or ATL function setting also affects neutral brake side operation. The Idle-up (page 72) or Engine Cut (page 101) function has priority.

Servo view

Servo operation of each channel can be checked. Operation of the steering angle adjustment, when a mixing function was set, etc. can be easily checked.

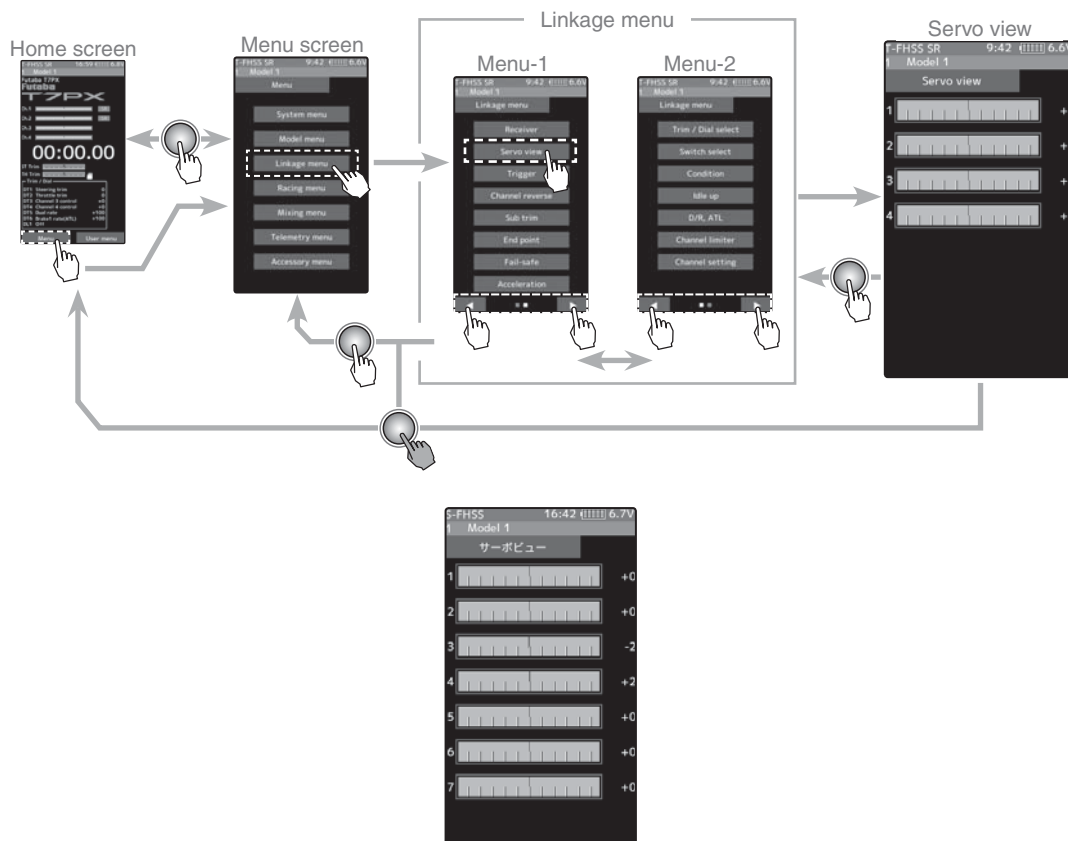

For S-FHSS (analog) system,
1 to 7 channels are displayed.

Confirm operation

- 1 Operating each channel, such as a steering wheel or throttle trigger, the graph works and the servo operation can be confirmed.
- 2 When finished, return to the Linkage menu screen by pressing the HOME button.

D/R, ATL

D/R (Steering dual rate)

The steering left and right servo travels are adjusted simultaneously. This setting is linked to transmitter grip trim DT5. When DT5 is assigned another function, dual rate can be adjusted with this screen.

ATL (Brake1 rate)

This function decreases the set value when the braking effect is strong and increases the set value when the braking effect is weak. This function is linked to transmitter grip trim DT6. When DT6 is assigned another function, this function can be set with this screen.

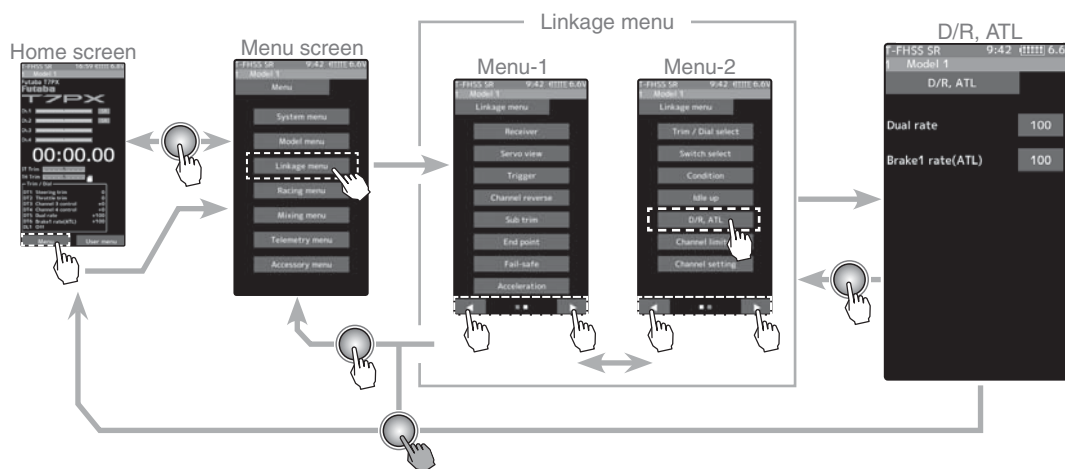

Dual rate adjustment

- 1 Tap the travel button of the [Dual rate]. Value input buttons appear on the screen and use the [+] and [-] buttons to adjust the dual rate amount.

This dual rate servo travel is linked to the grip trim.

When finished, return to the Linkage menu screen by pressing the HOME button.

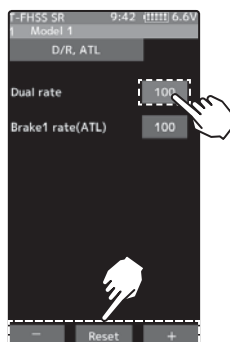

Adjust button

Adjust with the [+] and [-] buttons.

- Return to the initial value by tapping the [reset] buttons.

Dual rate

0~100
Initial value: 0

Brake rate(ATL) adjustment

- 1 Tap the travel button of the [Brake rate(ATL)]. Value input buttons appear on the screen and use the [+] and [-] buttons to adjust the brake rate amount.

This brake rate servo travel is linked to the grip trim.

When finished, return to the Linkage menu screen by pressing the HOME button.

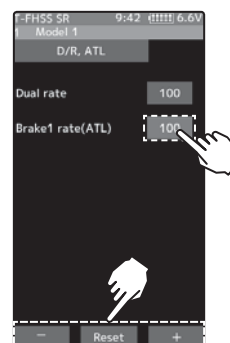

Adjust button

Adjust with the [+] and [-] buttons.

- Return to the initial value by tapping the [reset] buttons.

Brake rate(ATL)

0~100
Initial value: 0

Function

Trim /Dial select

This function allows selection of the function performed by the digital dial DL1 and digital trimmers (DT1 ~ DT6), step amount adjustment, and operating direction reversal.

- The table in page 68 lists the functions that can be assigned to each dial and digital trim. The assigned function is also displayed on the opening screen together with the current adjustment value. They are displayed in DL1 and DT1 ~ DT6 order, from top to bottom.
- The step amount can be adjusted. The table in the following page shows the relationship between set value and step amount.
- The operation direction can be reversed. (Nor/Rev)

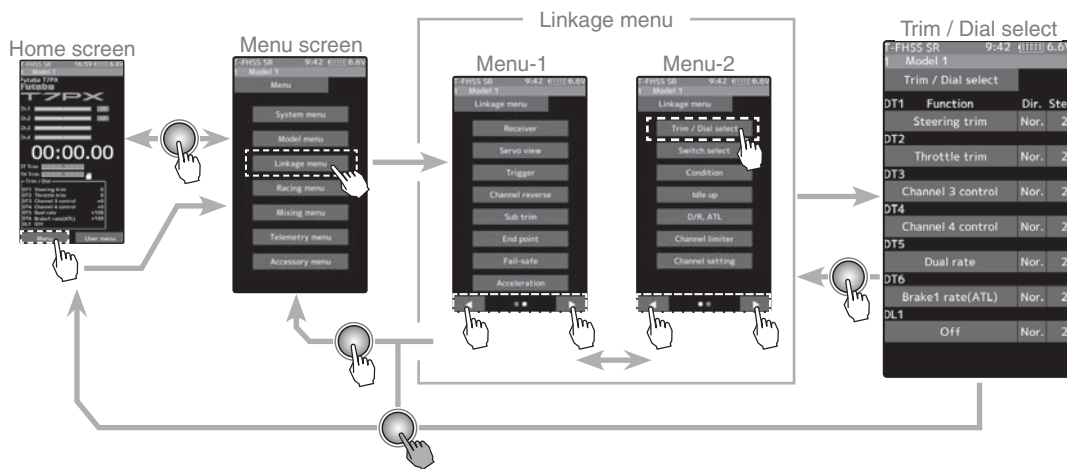

Function select dial setup

1 Tap the trim or dial you want to set.

(DT 1, 2, 3, 4, 5, 6 / DL 1)

The function list appears on the Trim/Dial select menu screen.

Function list
See page 68

2 (Function setup)

Tap and select the function you want to use. To cancel, tap [Close].

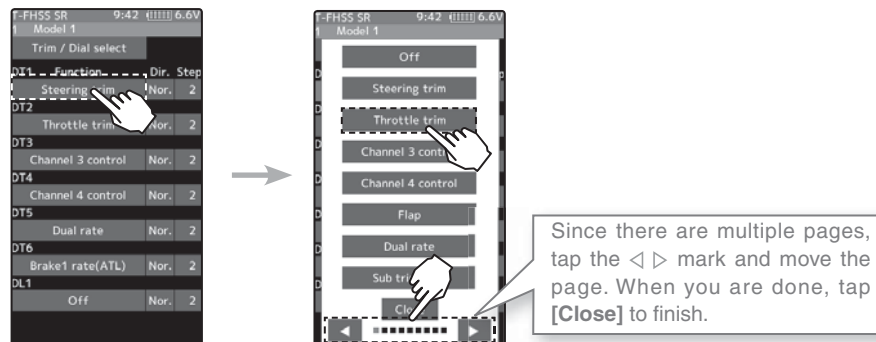

(Changing the operation direction)

Tap [Nor.] or [Rev.] in the direction to set the direction.

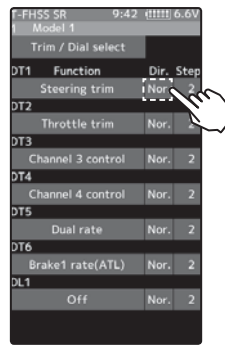

Setting direction

- Tap [Nor.] / [Rev.]
(Nor.) Normal / (Rev.) Reverse

(Changing the operation step amount)

Tap the travel button of the [step]. Value input buttons appear on the screen and use the [+] and [-] buttons to adjust the step amount.

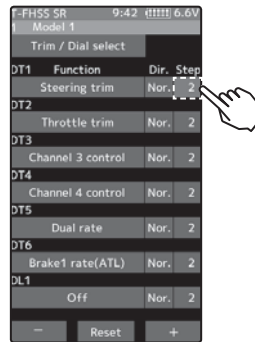

Adjust button

Adjust with the [+] and [-] buttons.
- Return to the initial value by tapping the [reset] buttons.

Step range

1, 2, 5, 10, 20, 30, 40, 50, 100, 200
Initial value: 2

3 When finished, return to the Linkage menu screen by pressing the HOME button.

Relationship between set value and step amount

(Setting range: 1, 2, 5, 10, 20, 30, 40, 50, 100, 200)
 -Steering trim/throttle trim
 When set to the minimum "1", the total trim operating width is 200 clicks. For "100", the total operating width is 2 clicks and for 2PS, the total operating width is 1 click.
 -Rate, etc. setting
 This is the % value which is operated by 1 click relative to the set value of each rate. Since the total operating width of functions having a rate of -100~0~+100 is 200%, when set to "100", the total operating width is 2 clicks. Since the total operating width of functions with a 0~100 rate is 100%, "100" and "200" are operated by 1 click.
 -Auxiliary channel
 When set to the minimum "1", the total operating width of channel 3 is 200 clicks. For "100", the total operating width is 2 clicks and "200" is operated by 1 click.

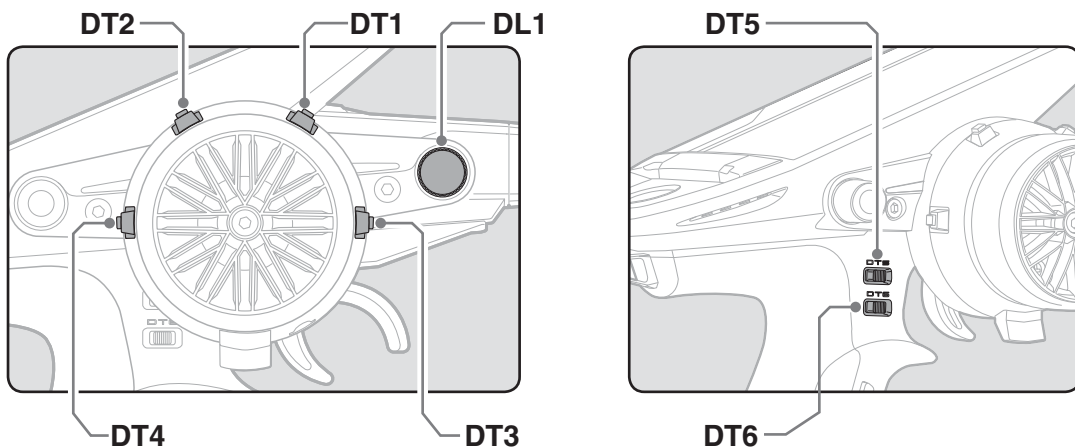

Trim /Dial select

Function

Set table functions (DL1/ DT1, DT2, DT3, DT4, DT5, DT6)

Abbreviation used on setup screen	Abbreviation displayed on opening screen	Function name, etc
Steering trim	Steering trim	Steering trim
Throttle trim	Throttle trim	Throttle trim
Channel 3 to 7 control	Channel 3 to 7 control	Channel 3 to 7 control (Channel 5 to 7 is for S-FHSS analog system only.)
Flap	Flap	Tilt mixing: flap rate
Dual rate	D/R	Dual rate function
Sub trim Ch.1 to 7	Sub trim Ch.1 to 7	Sub trim Ch.1~4
Acceleration(forward)	Acceleration(forward)	Throttle acceleration (Forward side)
Acceleration(brake1)	Acceleration(brake1)	Throttle acceleration (Brake1 side)
Acceleration(brake2)	Acceleration(brake2)	Throttle acceleration (Brake2 side)
Acceleration(brake3)	Acceleration(brake3)	Throttle acceleration (Brake3 side)
Steering curve	Steering curve	Steering curve (EXP) rate
Throttle curve	Throttle curve	Throttle curve (EXP) (Forward side)
Steering speed(turn)	Steering speed(turn)	Steering speed (Turn side)
Steering speed(return)	Steering speed(return)	Steering speed (Return side)
Th speed(turn/high)	Th speed(turn/high)	Throttle speed (High range turn side)
Th speed(turn/middle)	Th speed(turn/middle)	Throttle speed (Middle range turn side)
Th speed(turn/low)	Th speed(turn/low)	Throttle speed (Low range turn side)
Th speed(return/high)	Th speed(return/high)	Throttle speed (High range return side)
Th speed(return/middle)	Th speed(return/middle)	Throttle speed (Middle range return side)
Th speed(return/low)	Th speed(return/low)	Throttle speed (Low range return side)
ABS(return brake1)	ABS(return brake1)	Brake1 A.B.S. function (Return amount)
ABS(delay brake1)	ABS(delay brake1)	Brake1 A.B.S. function (Delay amount)
ABS(cycle brake1)	ABS(cycle brake1)	Brake1 A.B.S. function (cycle speed)
ABS(return brake2)	ABS(return brake2)	Brake2 A.B.S. function (Return amount)
ABS(delay brake2)	ABS(delay brake2)	Brake2 A.B.S. function (Delay amount)
ABS(cycle brake2)	ABS(cycle brake2)	Brake2 A.B.S. function (cycle speed)
ABS(return brake3)	ABS(return brake3)	Brake3 A.B.S. function (Return amount)
ABS(delay brake3)	ABS(delay brake3)	Brake3 A.B.S. function (Delay amount)
ABS(cycle brake3)	ABS(cycle brake3)	Brake3 A.B.S. function (cycle speed)
Traction control(return)	Traction control(return)	Traction control function (Return amount)
Traction control(delay)	Traction control(delay)	Traction control function (Delay amount)
Traction control(cycle)	Traction control(cycle)	Traction control function (Cycle amount)
Brake1 rate(ATL)	Brake1 rate(ATL)	Brake1 rate (ATL)
Brake EXP(brake1)	Brake EXP(brake1)	Throttle EXP (Brake1 side)
Brake delay(brake1)	Brake delay(brake1)	Brake mixing: Brake1 delay
Brake rate(brake2)	Brake2 rate(brake2)	Brake1 rate (Brake2 side)
Brake EXP(brake2)	Brake EXP(brake2)	Throttle EXP (Brake2 side)
Brake delay(brake2)	Brake delay(brake2)	Brake mixing: Brake2 delay
Brake rate(brake3)	Brake2 rate(brake3)	Brake1 rate (Brake3 side)
Brake EXP(brake3)	Brake EXP(brake3)	Throttle EXP (Brake3 side)
Brake delay(brake3)	Brake delay(brake3)	Brake mixing: Brake3 delay
Brake2,3 rate	Brake2,3 rate	Brake mixing: Brake2,3 rate function
Tilt mixing (RUD → FLP)	Tilt mixing (RUD → FLP)	Tilt mixing: rudder to flap rate
Tilt mixing (FLP → RUD)	Tilt mixing (FLP → RUD)	Tilt mixing: flap to rudder rate
Idle up	Idle up	Idle up function rate
Prog. mixing 1~5 A	Prog. mixing 1~5 A	Program mixing: rate A side (Left/Forward/Up sides)
Prog. mixing 1~5 B	Prog. mixing 1~5 B	Program mixing: rate B side (Right/Brake/Down sides)
4WS rear rate	4WS rear rate	4WS mixing: (rear steering rate)
Dual ESC	Dual ESC	Dual ESC mixing (Drive mode select)
Dual ESC ratio	Dual ESC ratio	Dual ESC mixing: drive ratio (front & rear)
Gyro Gain	Gyro	Gyro mixing: (Gain rate)
Ackermann rate	Ackermann	Ackermann mixing: (ackermann rate)
OFF	Off	Not used

Function

Switch select

This function allows selection of the function to be performed by the switches (PS1, PS2, PS3, PS4, PS5, PS6, steering wheel, throttle trigger) and setting of the direction, etc. of operation.

- The table in the page 71 lists the functions that can be assigned to each push switch.
- The push switch PS6 is integrated with the DL 1.
- All switches can be made alternating operations (ON/OFF switched each time SW pressed). (Nor/Alt)
- The ON/OFF direction can be reversed. The reverse select function always starts from the ON state. However, the steering/ trigger switch is different, depending on the position. (Nor/Rev)

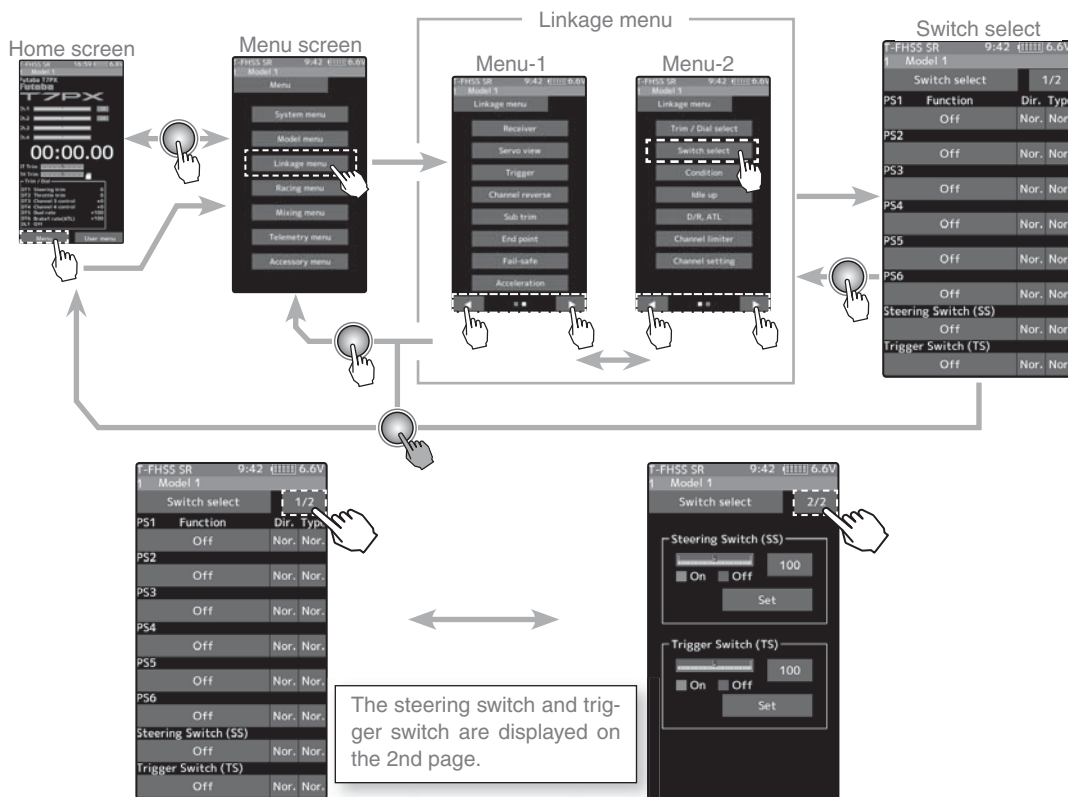

Function select dial setup

- (Function setup)
Tap the switch you want to set.
(PS1, PS2, PS3, PS4, PS5, PS6/ steering wheel, throttle trigger)
The function list appears on the switch select menu screen. Tap and select the function you want to use. To cancel, tap [Close].

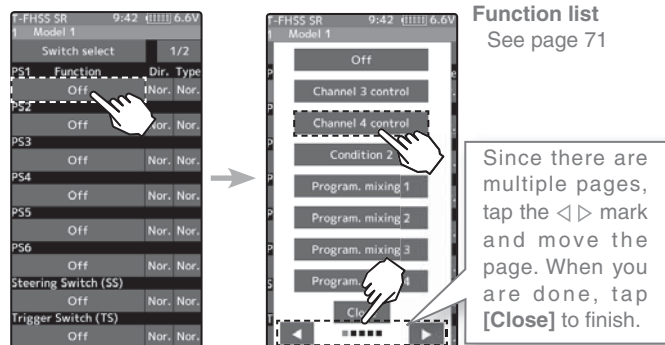

Switch select

Function

2 (Changing the operation direction)

Tap [Nor.] or [Rev.] in the direction to set the direction.

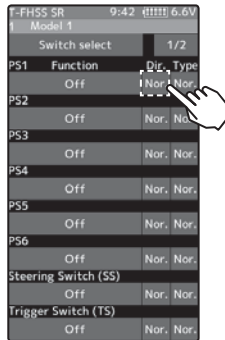

Setting direction

- Tap [Nor.] / [Rev.].
(Nor.) Normal / (Rev.) Reverse

(Changing the the type of operation)

Tap [Nor.] or [Alt.] in the type to set the type.

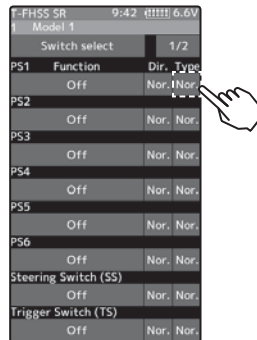

Setting type

- Tap [Nor.] / [Alt.].
(Nor.) Normal / (Alt.) Alternate

3 (Steering / trigger switch setting)

It is a function that uses the steering wheel and the throttle trigger as a switch.

Tap the set value of the position of the steering switch or trigger switch. Value input buttons appear on the screen and use the [+] and [-] buttons to set the switch ON/OFF position. Alternatively, you can set it by holding the steering wheel or throttle trigger at the point where you turn it ON/OFF and tap the [set]. Fine adjustment is possible with [+] and [-].

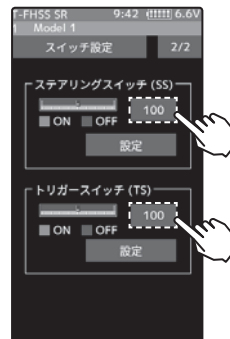

Adjust button

Adjust with the [+] and [-] buttons.
- Return to the initial value by tapping the [reset] buttons.

Brake rate(ATL)

0~100
Initial value:100

The red range of the bar graph is ON.

4 When finished, return to the Linkage menu screen by pressing the HOME button.

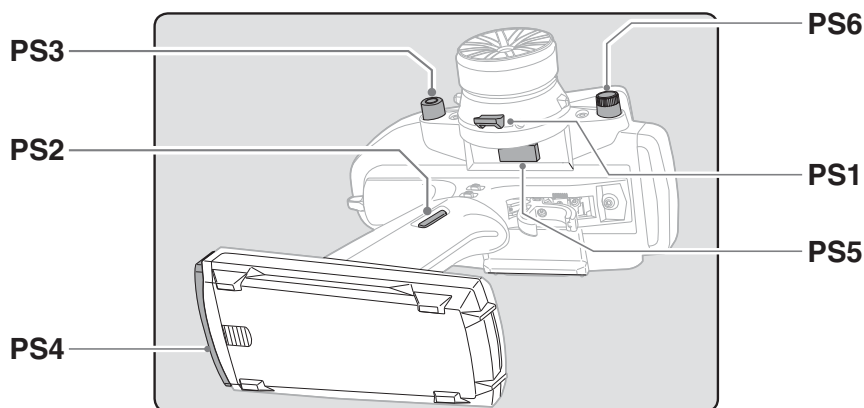

Set table functions (PS1/PS2/PS3/PS4/PS5) & Trigger switch (TS)	
Abbreviation used on setup screen	Function name, etc
Channel 3 to 7 control	Operation of channel 3 to 7 (Channel 5 to 7 is for S-FHSS analog system only.)
Condition 2	2nd condition function ON/OFF
Program mixing(1-5)	Program mixing(1-5) function ON/OFF
A.B.S.(Brake1)	A.B.S function brake1(2 channel)ON/OFF
A.B.S.(Brake2,3)	A.B.S function brake2,3(Axuliary channel)ON/OFF
Traction control	Traction control function ON/OFF
4WS mixing	4WS mixing function ON/OFF & type select
4WS type1 (Front)	4WS mixing function type1 (Front) select
4WS type2 (Reverse)	4WS mixing function type2 (Reverse) select
4WS type3 (Same)	4WS mixing function type3 (Same) select
4WS type4 (Rear)	4WS mixing function type4 (Rear) select
Dual ESC (Rear)	Dual ESC mixing (Rear Drive mode)
Dual ESC (4WD)	Dual ESC mixing (4WD mode)
Dual ESC (Front)	Dual ESC mixing (Front Drive mode)
Dual ESC (Rear)	Dual ESC mixing (Rear Drive mode)
Gyro mixing	Switching GYRO mode function ON/OFF
Gyro gain	Switching GYRO mode (Switch of Gain1 and Gain2 in same group)
Gyro group	Switching GYRO mode (Switch of Gain group)
CPS mixing(1-3)	CPS up function ON/OFF
Brake	Steering mixing (Brake function ON/OFF)
Start	Start function trigger wait ON/OFF
Engin cut	Engine cut function ON/OFF
Idle up	Idle up function ON/OFF
Neutral brake	Neutral brake function ON/OFF
Timer start	Timer function start /stop
Timer reset	Timer function reset
Telemetry speech	Telemetry voice guide ON/OFF
Telemetry log	Telemetry data logging ON/OFF
Screen capture	Save images of currently displayed screen to microSD card.
OFF	Not used

Function

The HOME screen display

When push switch is operated in the HOME screen state, the state of the function is displayed in the center for a few seconds.

Example:

When the push switch to which ON / OFF of the neutral brake is assigned is operated.

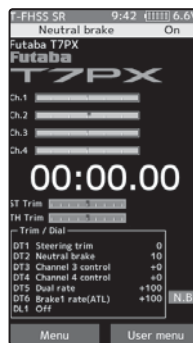

Neutral brake ON/OFF is indicated on the home screen for a few seconds.

Switch select

Idle-Up

This is a function select switch function. The idle up switch must be set (see page 69).

This function is used to improve engine starting performance by raising the idling speed when starting the engine of a GP car (boat). It is also effective when you want to prevent the braking when the power is turned off during running, due to the effect of your gear ratio setting and choice of motor when operating an electronic car. However, considering safety, and to prevent the motor from rotating instantly when the power is turned on, the MC-950CR, MC851C, MC602C, MC402CR, and other Futaba electronic motor speed controller (ESC) will not enter the operation mode if the neutral position is not confirmed. When using the MC950CR, MC851C, MC602C, MC402CR, or other Futaba ESC, confirm that the ESC is in the neutral position and the set is in the operation mode before setting the idle up function switch to ON.

Operation

The throttle neutral position is offset to the forward side or brake side. There is no linkage locking, etc. Because there is no change near the maximum operation angle even when the neutral position is offset by this function.

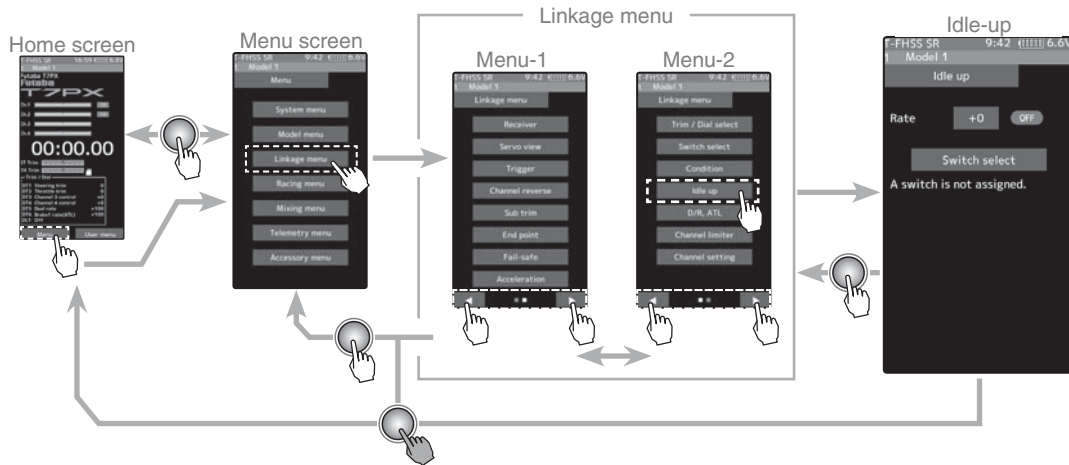

Function

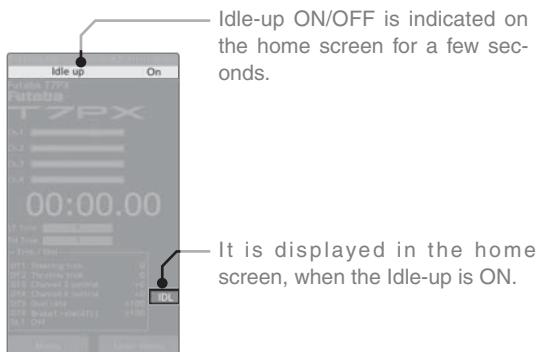

If the power switch is turned on while the Idle-up switch is on, an audible alarm will be heard. Immediately set the Idle-up switch to OFF.

Warning display

Idle-up function adjustment

(Preparation)

- Use the switch select function to the "Switch select". (page 69)

When the switch is not set "A switch is not assigned" is displayed. Tap [Switch select] to display the switch selection screen and set the switch.

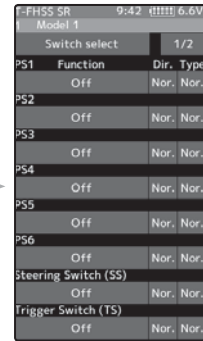
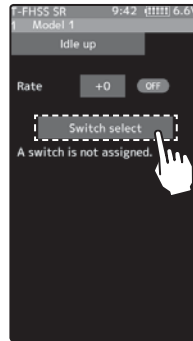

1 (Idle-up rate)

Tap the rate value button. The value input button is displayed on the screen, and use the [+] and [-] buttons to adjust the amount of the neutral brake rate.



*Shows the ON/OFF state

Adjust button

Adjust with the [+] and [-] buttons.
- Return to the initial value by tapping the [reset] buttons.

Idle-up rate

-50~0~+50
Initial value: 0

- 2 When finished, return to the Linkage menu screen by pressing the HOME button.

Dial / Trim Setting

The function select dial function can control the Idle-up rate with digital dial or digital trim (page 66).

Channel limiter

The channel limiter function limits maximum servo movement. By superimposing mixing, the linkage can be protected by setting the limiter in case servo motion becomes unexpectedly large.

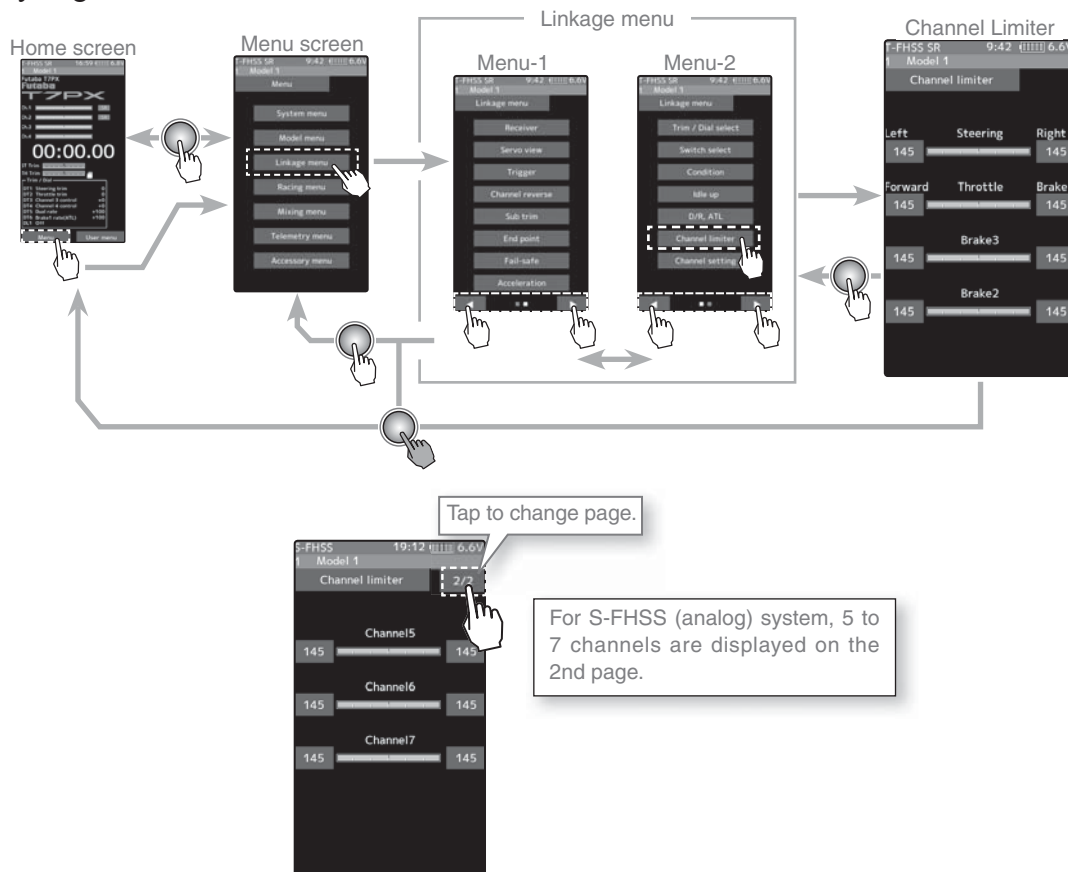

Channel limiter adjustment

(Preparation)

- Tap the travel button of the channel you want to set. Value input buttons appear on the screen.

- 1 Use the [+] or [-] buttons to adjust the servo angle.

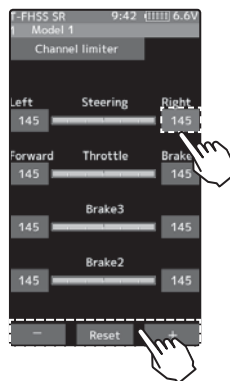

Adjust button

Adjust with the [+] and [-] buttons.

- Return to the initial value by tapping the [reset] buttons.

Limiter rate

0~145
Initial value: 145

- 2 When finished, return to the Linkage menu screen by pressing the HOME button.

Channel setting

This function assigns steering or throttle to any channel. You can operate steering and throttle on other channels, and operate other channels in the same way as steering and throttle.

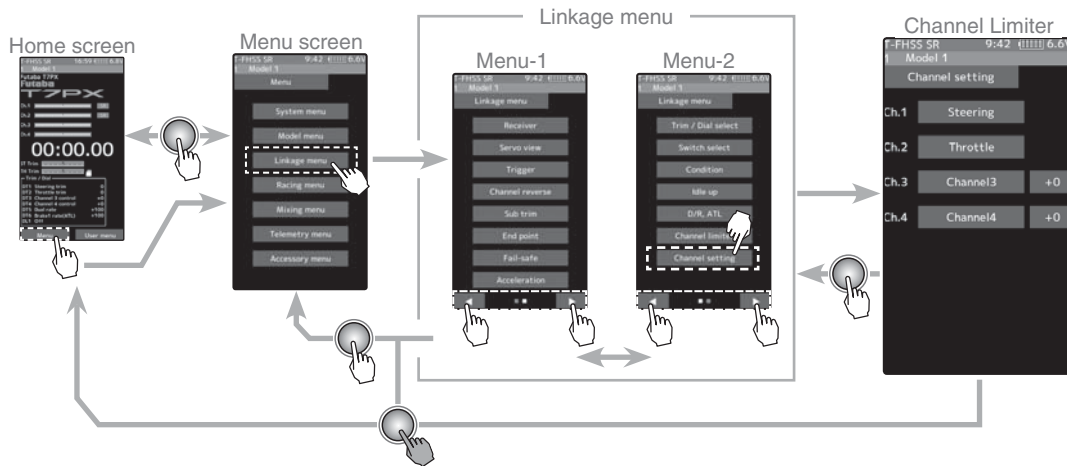

How to select steering / throttle

1 (Channel setup)

Tap the channel you want to set, and the [Steering], [Throttle] setting screen will be displayed. Tap on [Steering] or [Throttle] set for that channel and select it. To cancel, tap [Close].

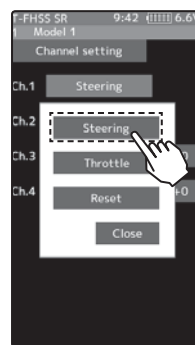

For S-FHSS (analog) system, 1 to 7 channels are displayed.

2 (position setting of protection channel)

If there is no switch, trim/dial etc. To operate the auxiliary channel, you can set the position here.

Tap the rate display part of the channel you want to adjust. Value input buttons appears on the channel setting menu screen. Use the [+] or [-] button to adjust the position.

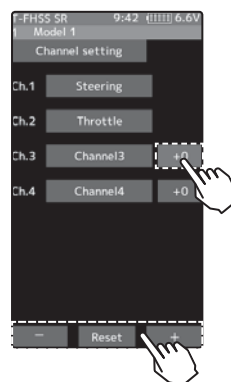

Adjust button

Adjust with the [+] and [-] buttons.

- Return to the initial value by tapping the [reset] buttons.

Position

-100~0~+100
Initial value: 0

3 When finished, return to the Linkage menu screen by pressing the HOME button.

Function

Condition

Two kinds of data can be set in one model for specific functions only; for example, two kinds of data such as steering D/R set to 90% at normal condition and steering D/R set to 80% at second condition. This second condition can be set for each model.

-The functions that can be set at each condition are displayed by condition number at the top of the menu screen. Since the reverse function, end point and other model standard setup menus are not displayed by conditioner number, the condition 1 and condition 2 settings are common.

- To use the condition function, switch setting by the "Switch select" function (page 69) is necessary.

- Switching from normal condition to second condition by switch set by switch select function is indicated by an audible alarm, and the condition number is displayed in the upper on the screen.

-First, the initial settings of each condition 2 function are created.

-The data set at condition 2 is memorized until reset by data reset (page 175). The data is memorized even if the condition function is turned off or setting of the switch by the "Switch select" function is changed.

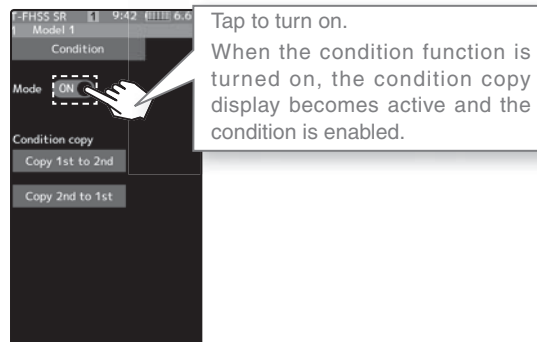
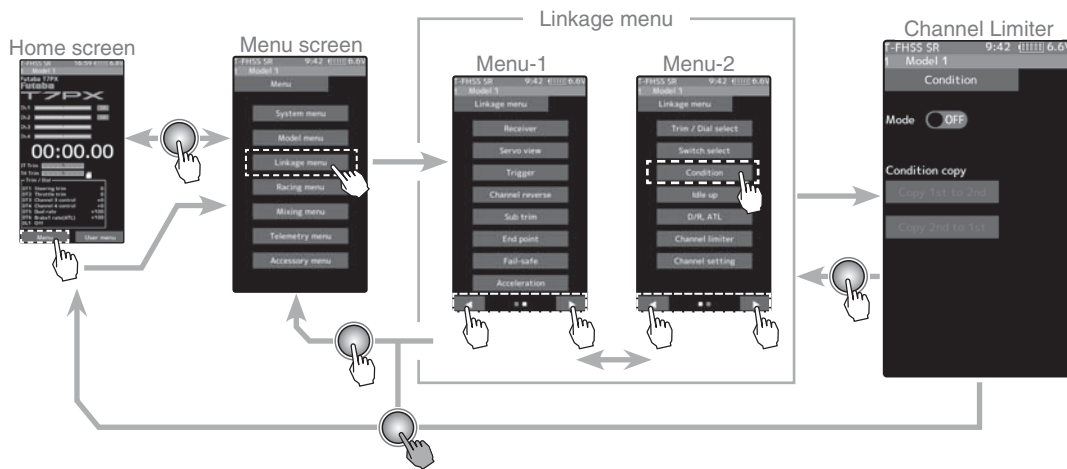

Idle-up function adjustment

(Preparation)

- Use the switch select function to the "Switch select". (page 69)

1 (Function ON/OFF)

Tap mode (ON) or (OFF) to select ON / OFF.

"OFF" :Function OFF

"ON" :Function ON

Setting

- Tap (ON) / (OFF).

Condition copy display becomes active and the condition can be used.

2 (Condition copy)

Tap the condition copy direction. To copy from Condition 1 to Condition 2, tap [Copy 1 → 2], from Condition 2 to Condition 1, [Copy 2 → 1]. A confirmation message will be displayed as "Are you sure?" Tap [Yes] to execute, or [No] to cancel.

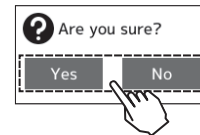
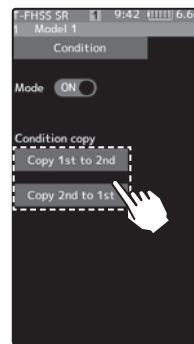

3 When finished, return to the Linkage menu screen by pressing the HOME button.

Display when using condition.

On the function screen which can set the condition and the screen which can not be set, the background color of the number is different.

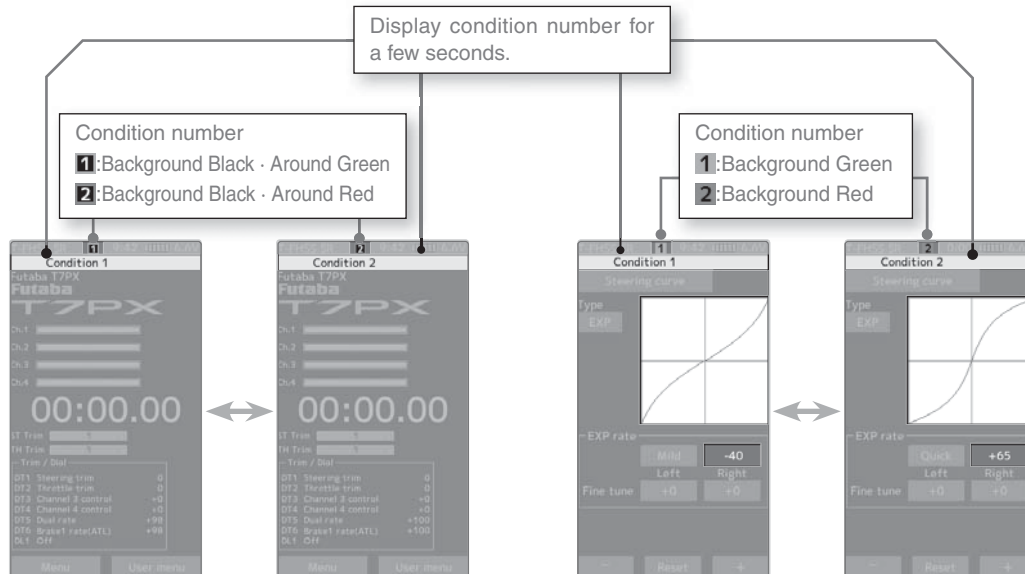

Curve (EXP)

Steering curve

This function is used to change the sensitivity of the steering servo around the neutral position. It has no effect on the maximum servo travel. Also the "Fine tune" function is which can adjust the rate for left and right separately.

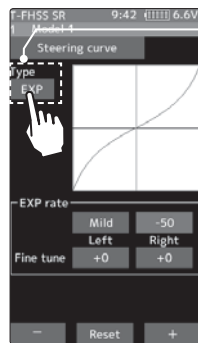
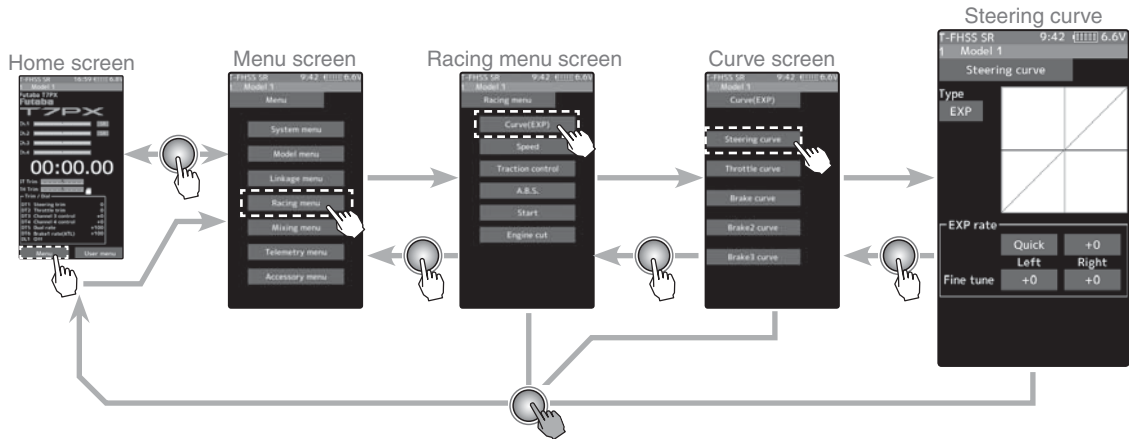

* Touch the type to switch the curve type.

EXP curve screen

Curve type which operates the steering from the neutral point to the end point on a curved curve.

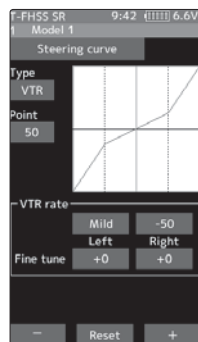
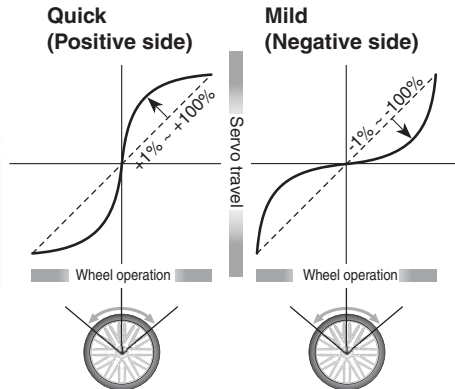

VTR curve screen

Curve type which sets the switching point between the throttle neutral point and high point and operates the throttle on a linear curve.

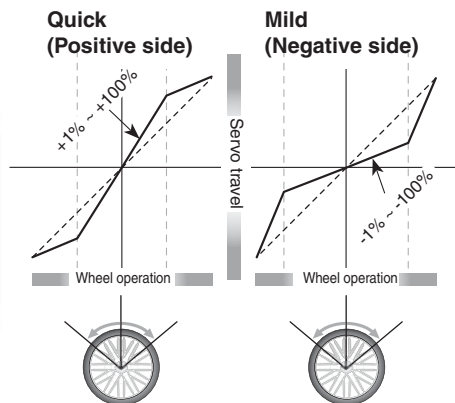

Function

Dial / Trim Setting

The steering EXP, VTR adjustment can be controlled with digital trim DT1~DT6 or digital dial DL1 etc. with the dial select function. (page 66)

Steering EXP adjustment

(Preparation)

-Touch the curve type and select [EXP].

- 1 Tap the value button of the [EXP rate]. Value input buttons appear on the screen. When you want to quicken steering operation, use the [+] button to adjust the + side. When you want to make steering operation milder, use the [-] button to adjust the - side.

If you tap "Quick" or "Mild" when the value is other than "0", Quick / Mild is reversed.

To set the right and left steering curves separately, tap the rate in the direction you wish to change the setting. Value input buttons appear on the screen, use the [+] or [-] buttons to adjust the steering curve.

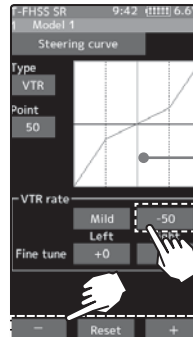

Adjustment buttons

- Adjust with the [+] and [-] buttons.
- Return to the initial value by tapping the [reset] buttons.

Curve rate

- 100~+100
- Initial value : 0

* The vertical cursor line moves in conjunction with the operation of the steering wheel.

- 2 When finished, return to the Racing menu screen by pressing the HOME button twice.

Steering VTR adjustment

(Preparation)

-Touch the curve type and select [VTR].

- 1 Tap the value button of the [VTR rate]. Value input buttons appear on the screen. When you want to quicken steering operation, use the [+] button to adjust the + side. When you want to make steering operation milder, use the [-] button to adjust the - side.

If you tap "Quick" or "Mild" when the value is other than "0", Quick / Mild is reversed.

To set the right and left steering curves separately, tap the rate in the direction you wish to change the setting. Value input buttons appear on the screen, use the [+] or [-] buttons to adjust the steering curve.

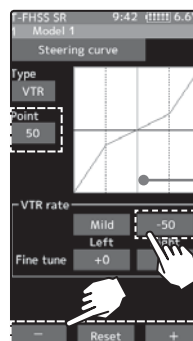

Adjustment buttons

- Adjust with the [+] and [-] buttons.
- Return to the initial value by tapping the [reset] buttons.

Curve rate

- 100~+100
- Initial value : 0

Point
1~99

Initial value : 50

* The vertical cursor line moves in conjunction with the operation of the steering wheel.

- 2 Curve switching point adjustment
Tap the value button of the [Point]. Value input buttons appear on the screen, use the [+] or [-] buttons to move to the point you want to set.

- 3 When finished, return to the Racing menu screen by pressing the HOME button twice.

Function

Throttle curve (Forward side)

This function makes the throttle high side direction servo operation quicker or milder. It has no effect on the servo maximum operation amount.

For the selection from among three kinds of curves (EXP/VTR/Curve) is also possible.

Advice

When the course conditions are good and the surface has good grip, set each curve to the plus [+] side (quick side). When the road surface is slippery and the drive wheels do not grip it, set each curve to the minus [-] side (mild).

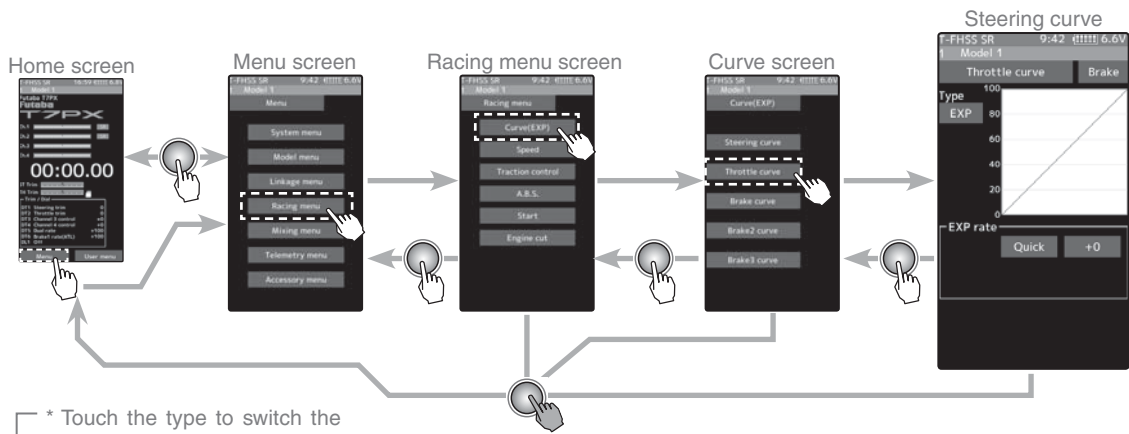

* Touch the type to switch the curve type.

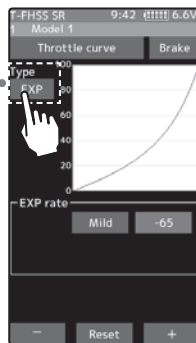

EXP curve screen

Curve type which operates the throttle from the neutral point to the high point on a curved curve.

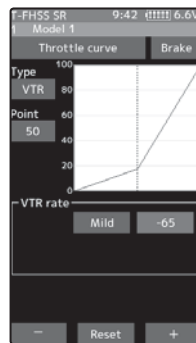
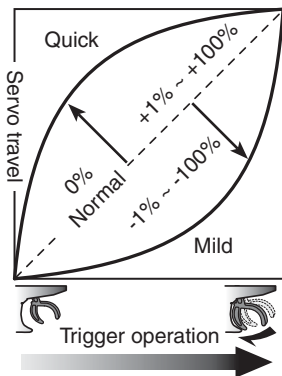

VTR curve screen

Curve type which sets the switching point between the throttle neutral point and high point and operates the throttle on a linear curve.

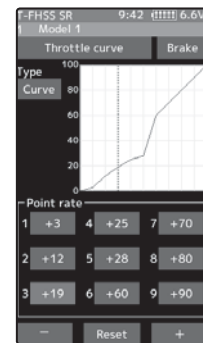
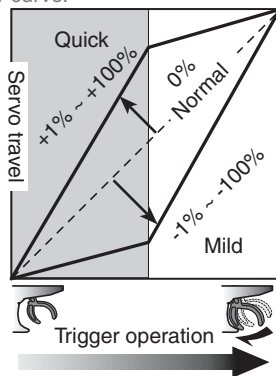

Curve screen

Curve type which sets 9 points between the throttle neutral point and high point and operates the throttle.

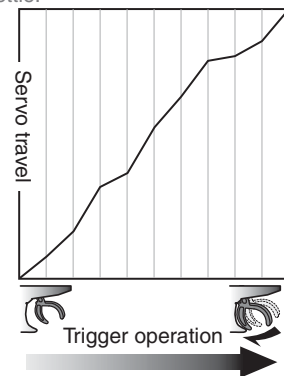

Function

Adjustment method for EXP curve

(Preparation)

-Touch the curve type and select [EXP].

- 1 Tap the value button of the [EXP rate]. Value input buttons appear on the screen. When you want to quicken Throttle operation, use the [+] button to adjust the + side. When you want to make Throttle operation milder, use the [-] button to adjust the - side. If you tap "Quick" or "Mild" when the value is other than "0", Quick / Mild is reversed. To set the right and left Throttle curves separately, tap the rate in the direction you wish to change the setting. Value input buttons appear on the screen, use the [+] or [-] buttons to adjust the Throttler curve.

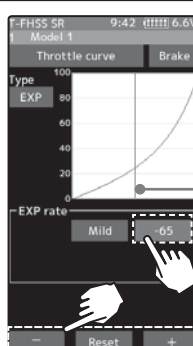

Adjustment buttons

- Adjust with the [+] and [-] buttons.
- Return to the initial value by tapping the [reset] buttons.

Curve rate

-100~+100
Initial value : 0

* The vertical cursor line moves in conjunction with the operation of the throttle trigger.

- 2 When finished, return to the Racing menu screen by pressing the HOME button twice.

Throttle VTR adjustment

(Preparation)

-Touch the curve type and select [VTR].

- 1 Tap the value button of the [VTR rate]. Value input buttons appear on the screen. When you want to quicken throttle operation, use the [+] button to adjust the + side. When you want to make throttle operation milder, use the [-] button to adjust the - side. If you tap "Quick" or "Mild" when the value is other than "0", Quick / Mild is reversed.
- 2 Curve switching point adjustment
Tap the value button of the [Point]. Value input buttons appear on the screen, use the [+] or [-] buttons to move to the point you want to set.

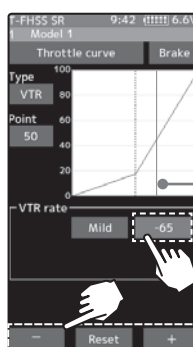

Adjustment buttons

- Adjust with the [+] and [-] buttons.
- Return to the initial value by tapping the [reset] buttons.

Curve rate

-100~+100
Initial value : 0

Point
1~99
Initial value : 50

* The vertical cursor line moves in conjunction with the operation of the throttle trigger.

- 3 When finished, return to the Racing menu screen by pressing the HOME button twice.

Dial / Trim Setting

The throttle EXP, VTR adjustment can be controlled with digital trim DT1~DT6 or digital dial DL1 etc. with the dial select function. (page 66)

Adjustment method for Curve

(Preparation)

-Touch the curve type and select [Curve].

- 1 Tap the value button of the [Point rate] (1 to 9). Value input buttons appear on the screen, use the [+] or [-] buttons to move to the point you want to set.

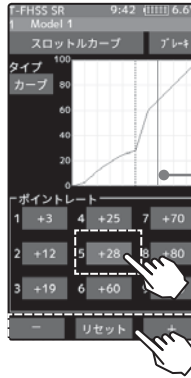

Adjustment buttons

- Adjust with the [+] and [-] buttons.
- Return to the initial value by tapping the [reset] buttons.

Curve rate

+0~+100

Point

1~9

Initial value :

1:+10/ 2:+20/ 3:+30

4:+40/ 5:+50/ 6:+60

7:+70/ 8:+80/ 9:+90

* The vertical cursor line moves in conjunction with the operation of the throttle trigger.

- 2 When finished, return to the Racing menu screen by pressing the HOME button twice.

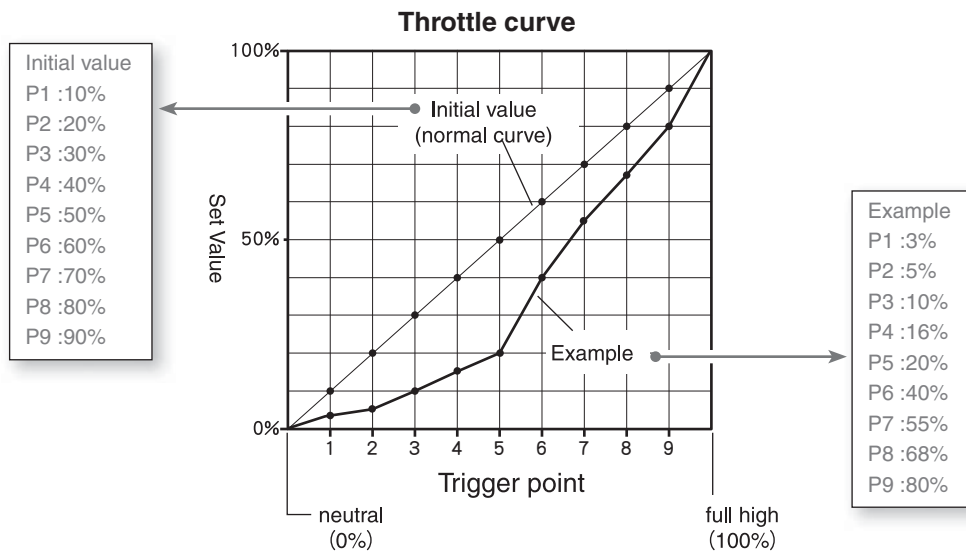

Screen switching between throttle forward side curve and brake side curve.

You can move directly without returning the throttle (forward side) curve screen and the brake curve screen to the curve screen.

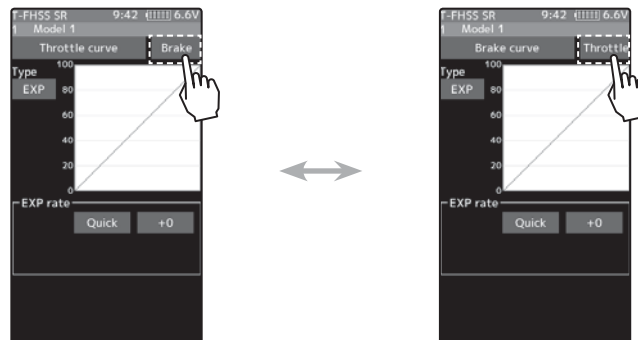

Curve (EXP)

Brake curve

This function makes the throttle brake side direction servo operation quicker or milder. It has no effect on the servo maximum operation amount. For the selection from among three kinds of curves (EXP/VTR/Curve) is also possible. If Ratio is set to 100: 0 with the trigger function (page 62), the brake side will not operate. Since the setting method of each curve is the same as the throttle (forward) side curve, please read P81 to 82.

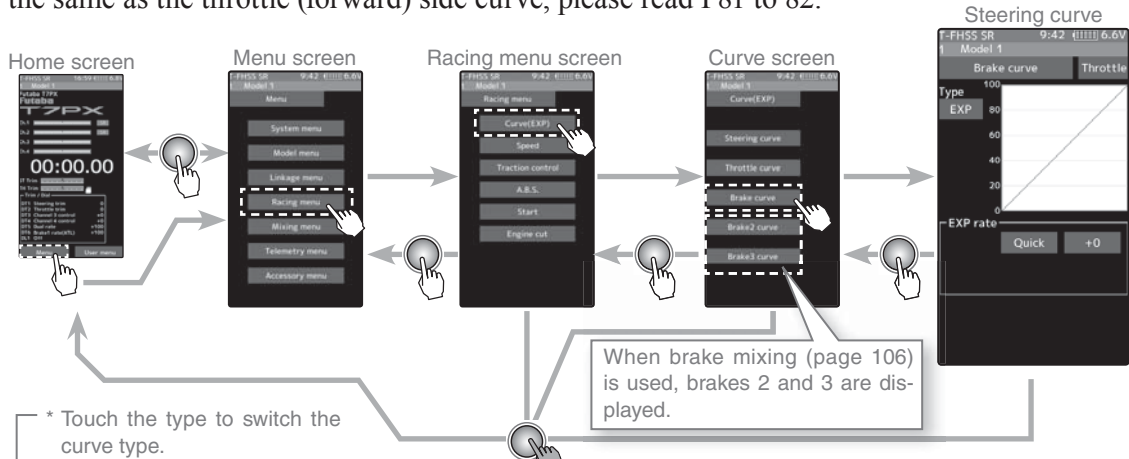

* Touch the type to switch the curve type.

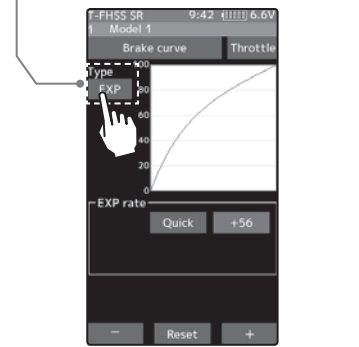

EXP curve screen

Curve type which operates the throttle from the neutral point to the full brake point on a curved curve.

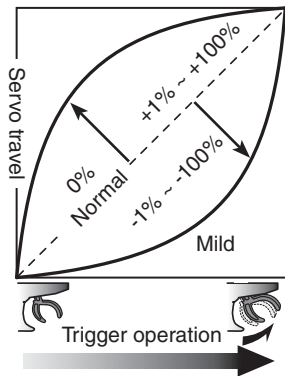

VTR curve screen

Curve type which sets the switching point between the throttle neutral point and full brake point and operates the throttle on a linear curve.

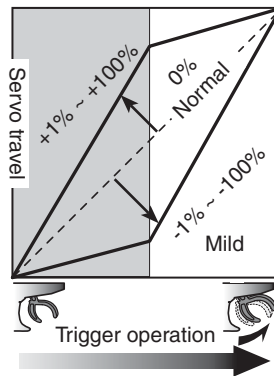

Curve screen

Curve type which sets 9 points between the throttle neutral point and full brake and operates the throttle.

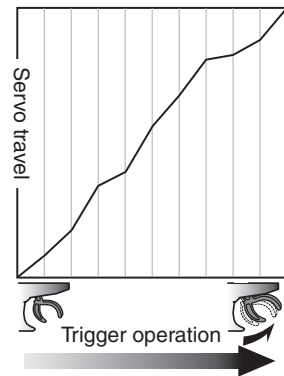

Dial / Trim Setting

The brake EXP, VTR adjustment can be controlled with digital trim DT1~DT6 or digital dial DL1 etc. with the dial select function. (page 66)

Curve (EXP)

Function

Speed

Steering speed

Quick steering operation will cause momentary understeering, loss of speed, or spinning. This function is effective in such cases.

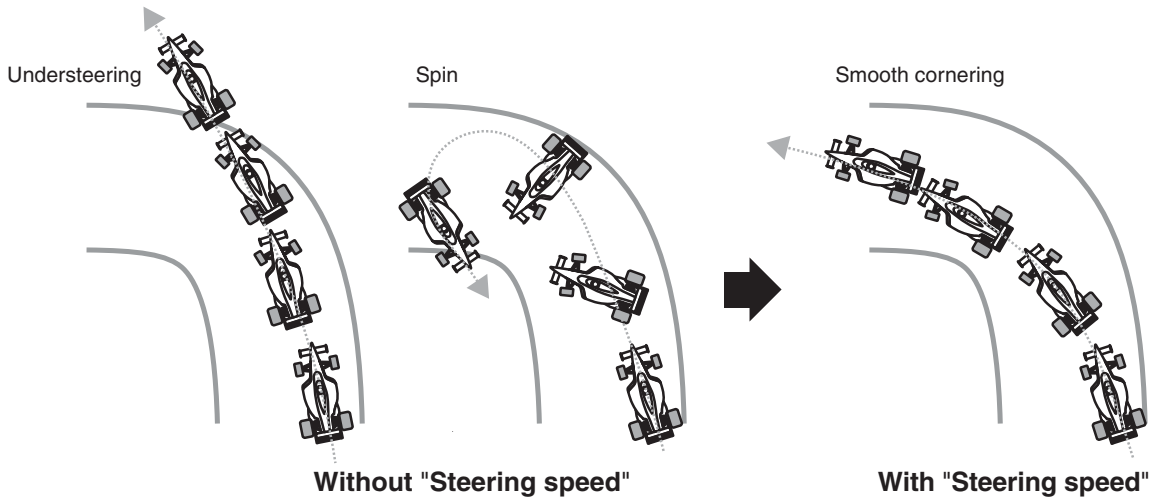

Operation

- This function limits the maximum speed of the steering servo. (Delay function)
- The steering speed when the steering wheel is operated (Turn direction) and returned (Return direction) can be independently set.
- If the steering wheel is turned slower than the set speed, the steering servo is not affected.

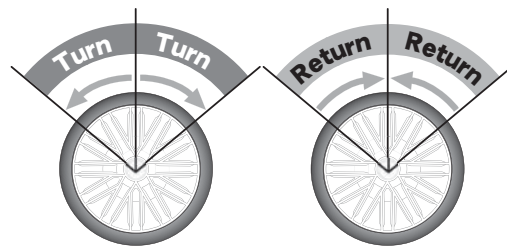

Function

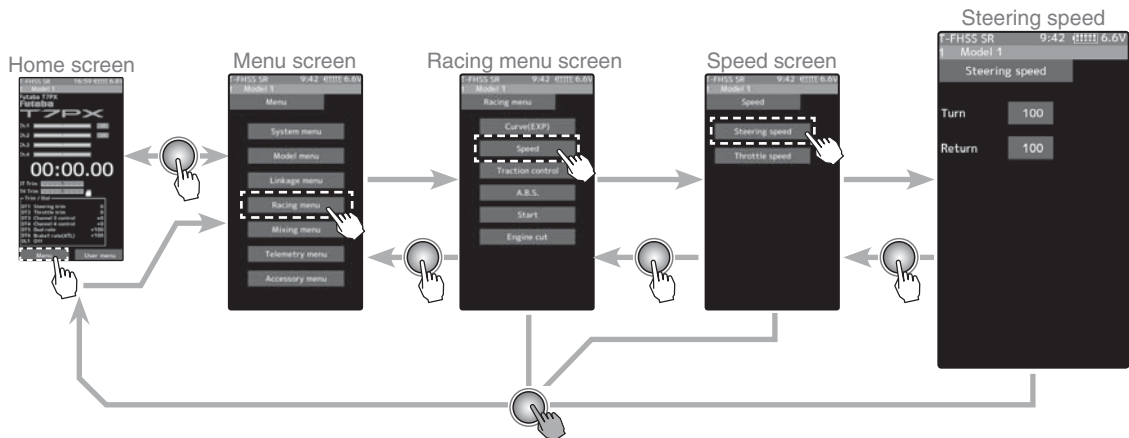

Steering Speed adjustment

1 ("Turn" direction delay adjustment)

Tap the value button of the [Turn]. Value input buttons appear on the screen. Use the [+] and [-] buttons to adjust the turn speed amount.

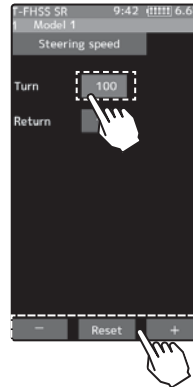
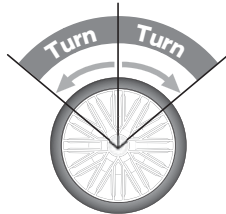

Adjustment buttons

- Adjust with the [+] and [-] buttons.
- Return to the initial value by tapping the [reset] buttons.

Speed range

1~100

Initial value :

100, there is no delay.

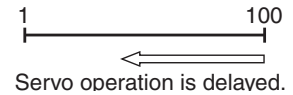

2 ("Return" direction adjustment)

Tap the value button of the [Return]. Value input buttons appear on the screen. Use the [+] and [-] buttons to adjust the return speed amount.

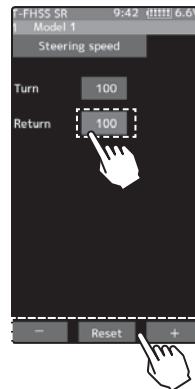

Adjustment buttons

- Adjust with the [+] and [-] buttons.
- Return to the initial value by tapping the [reset] buttons.

Speed range

1~100

Initial value :

100, there is no delay.

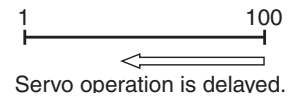

3 When finished, return to the Racing menu screen by pressing the HOME button twice.

Dial / Trim Setting

The steering speed adjustment "Turn" and "Return" adjustment can be controlled with digital trim DT1~DT6 or digital dial DL1 etc. with the dial select function. (page 66)

Throttle speed

Sudden throttle trigger operation on a slippery road only causes the wheels to spin and the vehicle cannot accelerate smoothly. Setting the throttle speed function reduces wasteful battery consumption while at the same time permitting smooth, enjoyable operation.

Without "Throttle speed"
Slow start due to skidding



With "Throttle speed"
Quick start without skidding



Operation

-Throttle servo (ESC) operation is delayed so that the drive wheels will not spin even if the throttle trigger is operated more than necessary. This delay function is not performed when the throttle trigger is returned and at brake operation.
-1 speed, 2 speed, or 3 speed can be selected.

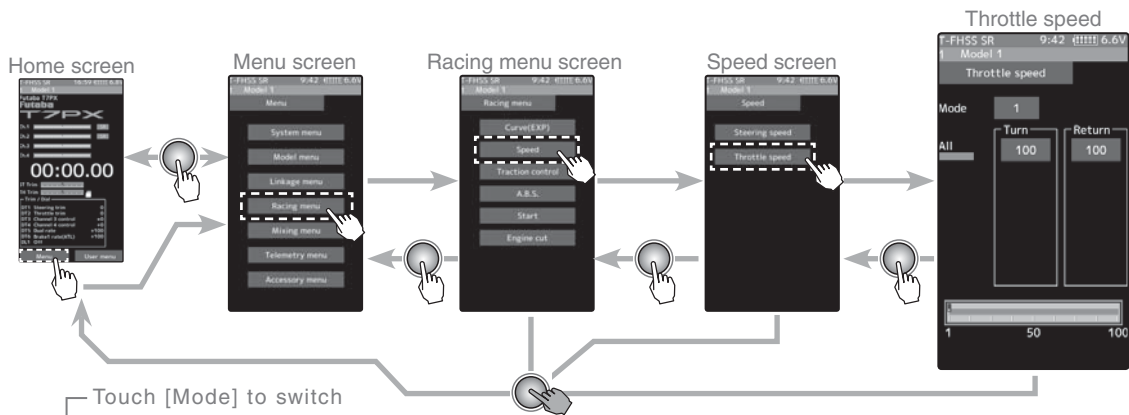

Touch [Mode] to switch between 1, 2 and 3 speed.

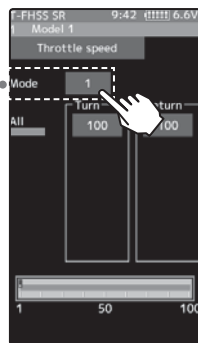

1 SPEED

A delay is set over the entire throttle range.

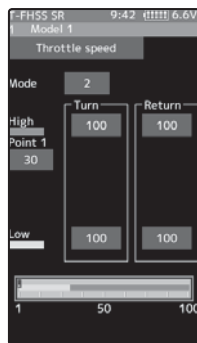
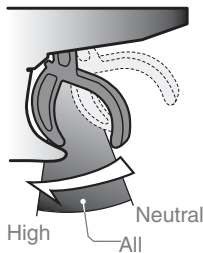

2 SPEED

A delay can be set in 2 ranges with Point 1 as the boundary.

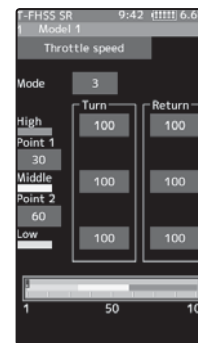
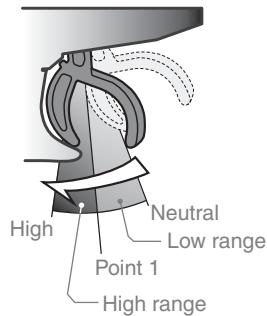

3 SPEED

A delay can be set in 3 ranges with Point 1 and Point 2 as the boundaries.

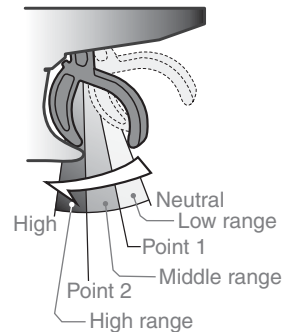

Function

Adjustment method for 1 Speed

(Preparation)

-Touch the speed mode and select [1].

- 1 ("ALL" turn direction delay adjustment)
Tap the [Turn] side of [All] value button. Value input buttons appear on the screen. Use the [+] and [-] buttons to adjust the turn speed amount.

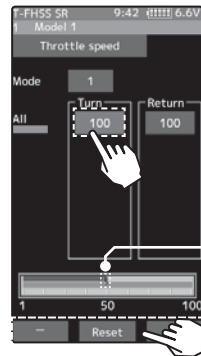

Adjustment buttons

- Adjust with the [+] and [-] buttons.
- Return to the initial value by tapping the [reset] buttons.

Speed range

1~100
Initial value :
100, there is no delay.

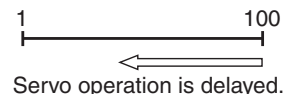

* Throttle trigger position

- 2 ("ALL" return direction delay adjustment)
Tap the [Return] side of [All] value button. A warning is displayed saying "Return speed will be slow. Please be careful.". If you want to use the return, tapped [Close]. Value input buttons appear on the screen. Use the [+] and [-] buttons to adjust the return speed amount.

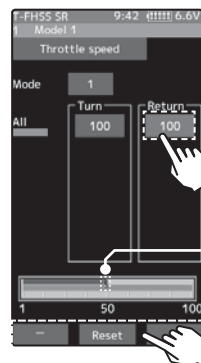
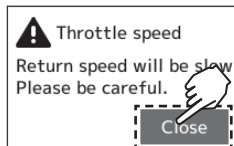

Adjustment buttons

- Adjust with the [+] and [-] buttons.
- Return to the initial value by tapping the [reset] buttons.

Speed range

1~100
Initial value :
100, there is no delay.

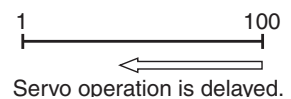

* Throttle trigger position

- 3 When finished, return to the Racing menu screen by pressing the HOME button twice.

Adjustment method for 2 Speed

(Preparation)

-Touch the speed mode and select [2].

- 1 ("Low" and "High" turn direction delay adjustment)
Tap the [Turn] side of [Low] or [High] value button. Value input buttons appear on the screen. Use the [+] and [-] buttons to adjust the turn speed amount.

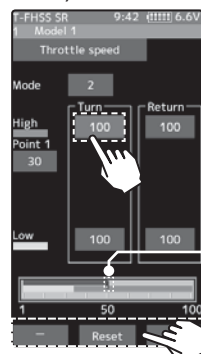

Adjustment buttons

- Adjust with the [+] and [-] buttons.
- Return to the initial value by tapping the [reset] buttons.

Speed range

High :1~100
Low :1~100
Initial value :
100, there is no delay.

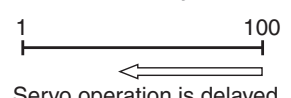

* Throttle trigger position

2 ("Low" and "High" return direction delay adjustment)

Tap the [Return] side of [Low] or [High] value button. A warning is displayed saying "Return speed will be slow. Please be careful.". If you want to use the return, tapped [Close]. Value input buttons appear on the screen. Use the [+] and [-] buttons to adjust the return speed amount.

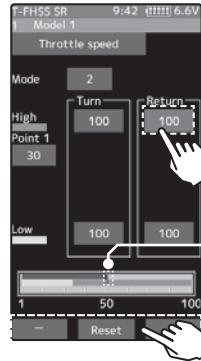
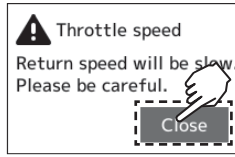

Adjustment buttons

- Adjust with the [+] and [-] buttons.
- Return to the initial value by tapping the [reset] buttons.

Speed range

High :1~100
Low :1~100
Initial value :
100, there is no delay.

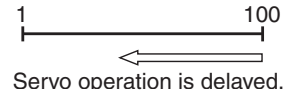

* Throttle trigger position

3 (Speed switching point adjustment)

When you want to change the "Low" and "High" switching point, tap the [point 1] value button. Value input buttons appear on the screen, use the [+] or [-] buttons to move to the point you want to set.

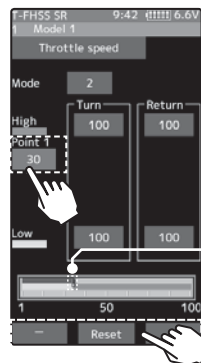

Adjustment buttons

- Adjust with the [+] and [-] buttons.
- Return to the initial value by tapping the [reset] buttons.

Point

Point 1 :1~100
Initial value : 30

* Throttle trigger position

4 When finished, return to the Racing menu screen by pressing the HOME button twice.

Adjustment method for 2 Speed

(Preparation)

- Touch the speed mode and select [3].

1 ("Low", "Middle", or "High" turn direction delay adjustment)

Tap the [Turn] side of [Low] or [High] value button. Value input buttons appear on the screen. Use the [+] and [-] buttons to adjust the turn speed amount.

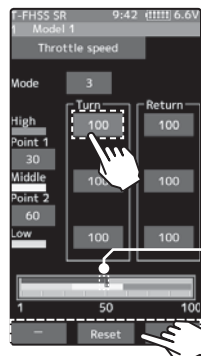

Adjustment buttons

- Adjust with the [+] and [-] buttons.
- Return to the initial value by tapping the [reset] buttons.

Speed range

High :1~100
Middle :1~100
Low :1~100
Initial value :
100, there is no delay.

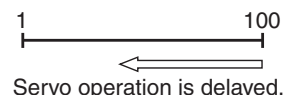

* Throttle trigger position

2 ("Low", "Middle", and "High" return direction delay adjustment)

Tap the [Return] side of [Low], [Middle] or [High] value button. A warning is displayed saying "Return speed will be slow. Please be careful.". If you want to use the return, tapped [Close]. Value input buttons appear on the screen. Use the [+] and [-] buttons to adjust the return speed amount.

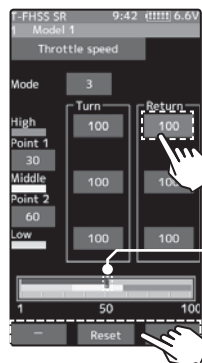
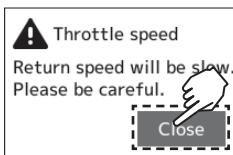

Adjustment buttons

- Adjust with the [+] and [-] buttons.
- Return to the initial value by tapping the [reset] buttons.

Speed range

- High :1~100
- Middle :1~100
- Low :1~100
- Initial value :
- 100, there is no delay.

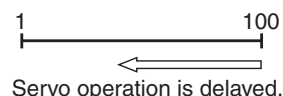

* Throttle trigger position

3 (Speed switching point adjustment)

When you want to change the "Low", "Middle" and "High" switching point, tap the [point 1] or [point 2] value button. Value input buttons appear on the screen, use the [+] or [-] buttons to move to the point you want to set.

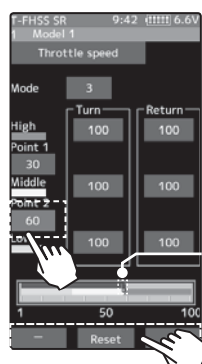

Adjustment buttons

- Adjust with the [+] and [-] buttons.
- Return to the initial value by tapping the [reset] buttons.

Point

- Point 1 :1~100
- Point 2 :2~100
- Initial value : 30

* Throttle trigger position

4 When finished, return to the Racing menu screen by pressing the HOME button twice.

Dial / Trim Setting

The throttle speed adjustment "Turn" and "Return" adjustment can be controlled with digital trim DT1~DT6 or digital dial DL1 etc. with the dial select function. (page 66)

⚠ Warning

- ① Setting the speed function in the return direction slows the deceleration of the car body, so please be careful to set it carefully.

A.B.S

When the brakes are applied while cornering with a 4-Wheel Drive or other type of vehicle, understeer may occur. The generation of understeer can be eliminated and corners can be smoothly cleared by using this function.

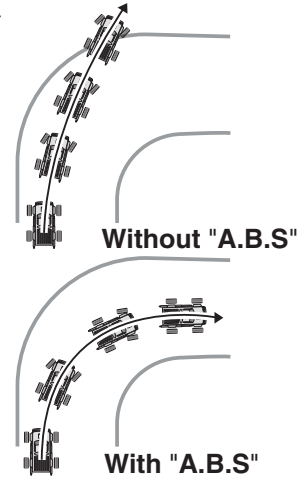

Operation

- When the brakes are applied, the throttle servo will pulse intermittently. This will have the same effect as pumping the brakes in a full size car.
- The brake return amount, pulse cycle, and brake duty can be adjusted.
- By setting the brake mixing function (page 106), it can also be set for 2nd and 3rd (auxiliary channel) brake.

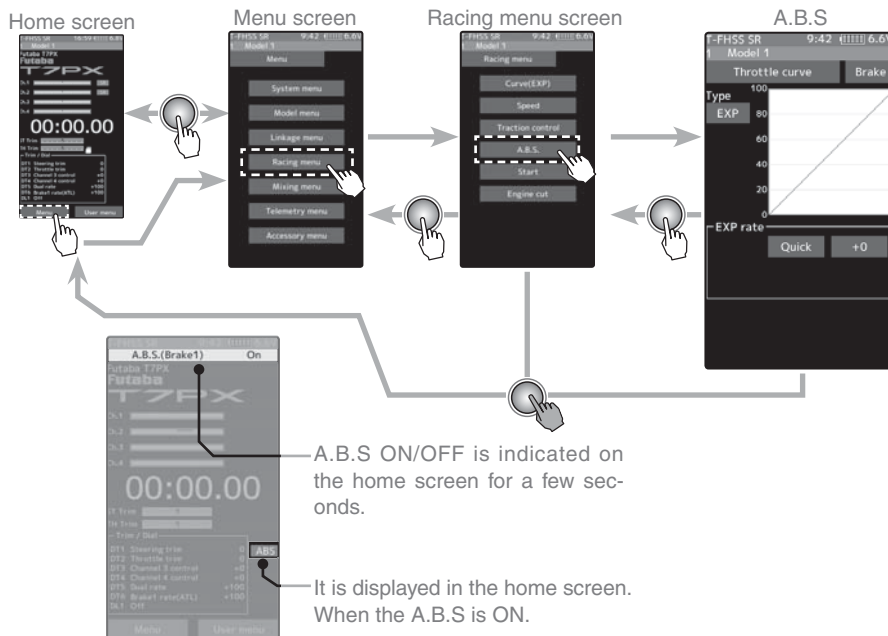

Function

- Mode : Function ON/OFF

ABS function ON/OFF setting. When using the ABS function, set to "ON".

- Brake return

Sets the rate at which the servo returns versus trigger operation for brake release. When set to 0%, the ABS function is not performed. When set to 50%, the servo returns 50% (1/2) of the trigger operation amount and when set to 100%, the servo returns to the neutral position.

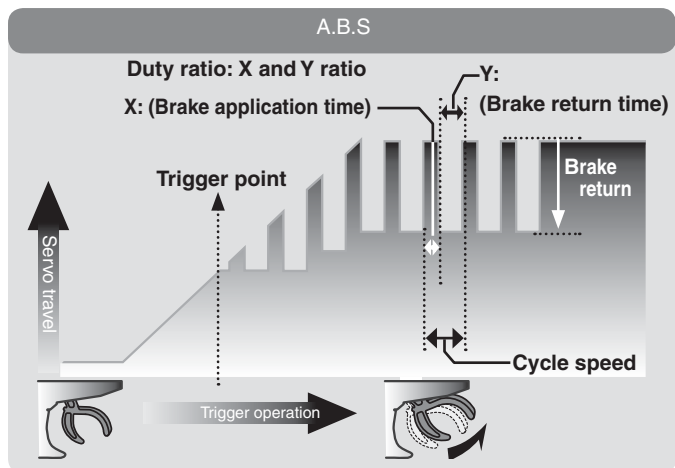

A.B.S

- Delay

Sets the delay from brake operation to ABS operation. When set to 0%, the ABS function is activated without any delay. At 50%, the ABS function is activated after a delay of approximately 0.7 seconds and at 100%, the ABS function is activated after a delay of approximately 1.4 seconds.

- Cycle speed

Sets the pulse speed (cycle speed). The smaller the set value, the faster the pulse cycle.

- Duty ratio

Sets the proportion of the time the brakes are applied and the time the brakes are released by pulse operation. The ratio can be set to +3 ~ 0 ~ -3 in 7 steps.

- Trigger point

Sets the trigger point at which the ABS function begins to operate at brake operation.

When trigger ratio was set to 100:0

When trigger ratio (page 62) was set to 100:0, brake operation stops, and the servo does not operate even if the ABS function is set.

A.B.S. function adjustment

1 (Function ON/OFF)

Tap "Brake" (ON) or (OFF) to select ON / OFF.

"OFF" :ABS function OFF

"ON" :ABS function ON

When using ABS function ON/OFF by switch, use the switch select function (page 69) to set the switch to be used.

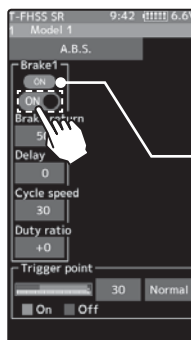

* Displays ON/OFF of the condition that ABS is working by throttle trigger operation.

2 ("Brake return" amount adjustment)

Tap the value button of the [Brake return]. Value input buttons appear on the screen. Use the [+] and [-] buttons to adjust the return amount.

"0" :No return

"50" :Return to the 50% position of the brake operation amount

"100" :Return to the neutral position.

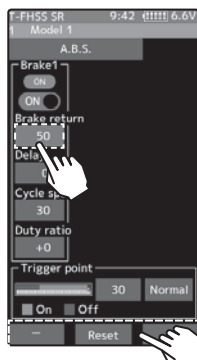
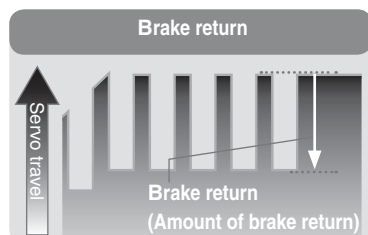

Adjustment buttons

- Adjust with the [+] and [-] buttons.
- Return to the initial value by tapping the [reset] buttons.

Return amount

0 ~ 50 ~ 100
Initial value: 50

The amount of brake return varies depending on the curve setting of the brake etc.

3 ("Delay" amount setup)

Tap the value button of the [Delay]. Value input buttons appear on the screen. Use the [+] and [-] buttons to adjust the delay amount.



- "0" :A.B.S. function performed without any delay
- "50" :A.B.S. function performed after an approximate 0.5 sec delay.
- "100" :A.B.S. function performed after an approximate 1.0 sec delay.

Adjustment buttons

- Adjust with the [+] and [-] buttons.
- Return to the initial value by tapping the [reset] buttons.

Delay amount

0~ 100
Initial value: 0

4 ("Cycle speed" adjustment)

Tap the value button of the [Cycle speed]. Value input buttons appear on the screen. Use the [+] and [-] buttons to adjust the cycle speed amount.

- The smaller the set value, the faster the pulse speed.

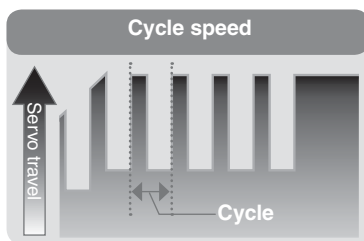

Adjustment buttons

- Adjust with the [+] and [-] buttons.
- Return to the initial value by tapping the [reset] buttons.

Cycle speed amount

1~ 100
Initial value: 30

5 ("Duty ratio" setup)

Tap the value button of the [Duty ratio]. Value input buttons appear on the screen. Use the [+] and [-] buttons to adjust the duty ratio amount.

- "-4" :Brake application time becomes shortest. (Brakes lock with difficulty)
- "+4" :Brake application time becomes longest (Brakes lock easily)

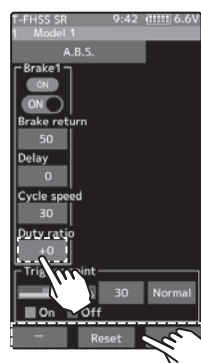
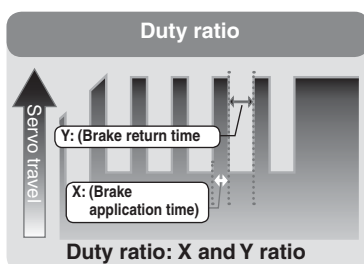

Adjustment buttons

- Adjust with the [+] and [-] buttons.
- Return to the initial value by tapping the [reset] buttons.

Duty ratio amount

-4~ +0~ +4
Initial value: +0

6 ("Trigger point" setup)

Tap the value button of the [Trigger point]. Value input buttons appear on the screen. Use the [+] and [-] buttons to adjust the operation point.

- Sets the throttle trigger position at which the A.B.S. function is performed. The number is the % display with the full brake position made 100.

Tap [Normal] or [Reverse] to set the operating range.

"Normal": Neutral to trigger point is the range of motion.

"Reverse": The range from the trigger point to the full brake side is the operating range.

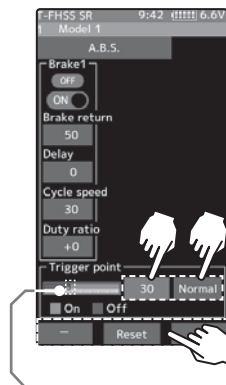
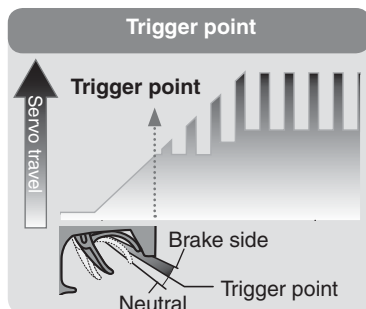

* Throttle trigger position

7 When finished, return to the Racing menu screen by pressing the HOME button.

1/5 scale car and other independent brakes and ABS

ABS can be independently set for the brakes which are controlled by the Brake2 and Brake3 (3rd CH and 4th CH). Brake mixing can be set under the mixing menu. (page 106)

Brake 1, 2, 3 can be adjusted independently except the trigger point of the setting item.



Brake mixing
Brake 2 "ON"

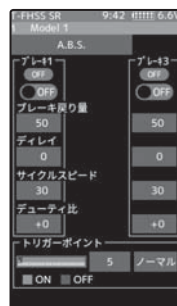

Brake mixing
Brake 3 "ON"



Brake mixing
Brake 2&3 "ON"

A.B.S

Switch setting

Use PS1 to 6 to switch the A.B.S. function ON/OFF.
See the switch select function. (page 69)

Dial / Trim Setting

The brake return amount, delay amount and cycle speed can be controlled with digital trim DT1~DT6 or digital dial DL1 etc. with the dial select function. (page 66)

Example of A.B.S. function setting when S9373SV used

(There will be a slight difference depending on the state of the linkage.)

Brake return: Approx. 30% (If this value is too high, the braking distance will increase.)

Cycle speed: 5~7

Duty ratio: 0 (When grip is low: - side, when grip is high: + side)

Delay : 10~15%

Trigger point: Approx. 70%

Steering mixing: Off

- When the wheels lock, or the car spins, when the brakes are applied fully

Brake return: Increase from 30%

Duty ratio: Shift from 0 to - side (-1, -2, -3, -4) →

Delay : Reduce the delay

- When the braking effect is poor and the braking distance is long when the brakes are applied fully

Brake return: Decrease from 30%

Duty ratio: Shift from 0 to + side (+1, +2, +3, +4) →

DLY: Increase the delay

Traction control

Trigger operation with cornering on a slippery road surface is hard to get traction and smooth cornering can not be done. By intermittently operating the operation of the throttle, you can smoothly navigate and travel on topological lines. Also, with a drift car, by intermittently operating the motor in the high point direction, a pseudo reverberator engine sound can be reproduced.

Operation

- During throttle operation, the throttle servo is intermittently operated in the forward direction.
- You can set the amount of return to the slow side, the amount of delay, the speed of pumping, the operating point, and the duty ratio of pumping.
- You can choose the action on the slow side near the neutral and the action on the high point side.

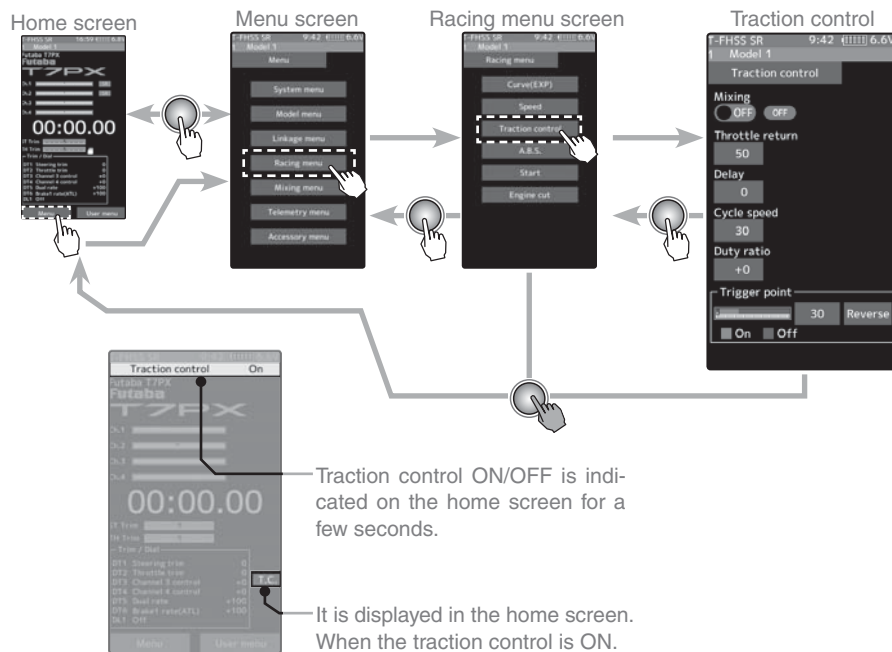

- Mode : Function ON/OFF

Traction control function ON/OFF setting. When using the Traction control function, set to "ON".

- Throttle return

Set the ratio at which the servo returns to the slow side with respect to the trigger operation. If set to 0%, the traction control function will not work. At 50%, it returns to the neutral position at 50% (half), 100% of the trigger operation amount.

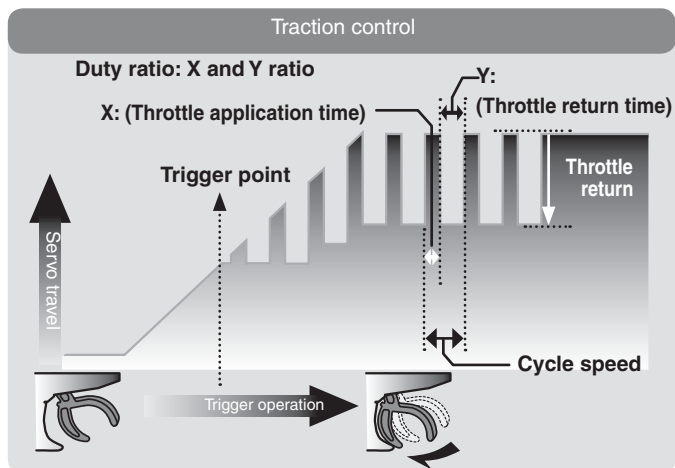

Traction control

Function

- Delay

Set the delay from when the throttle is operated until when the traction control operation starts. When set to 0%, the traction control function works without delay. At 50%, the traction control function works approximately 0.5 second later, and the traction control function works about 1.0 second later at 100%.

- Cycle speed

Sets the pulse speed (cycle speed). The smaller the set value, the faster the pulse cycle.

- Duty ratio

Set the ratio of the time to operate to the high side and the time to operate to the slow side in the pumping operation.

The ratio can be set to +4 ~ +0 ~ -4 in 9 steps.

- Trigger point

In the throttle operation, set the position of the trigger at which traction control starts to work. Normal / Reverse, reverse the throttle operation range where the traction control operates, with the trigger point as the boundary.

Traction control function adjustment

1 (Function ON/OFF)

Tap "Mixing" (ON) or (OFF) to select ON / OFF.

"OFF" :Traction control function OFF

"ON" :Traction control function ON

When using Traction control function ON/OFF by switch, use the switch select function (page 69) to set the switch to be used.

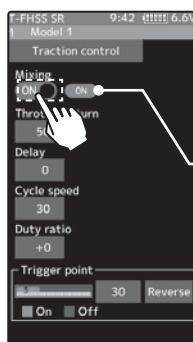

* Displays ON/OFF of the condition that Traction control is working by throttle trigger operation.

2 ("Throttle return" amount adjustment)

Tap the value button of the [Brake return]. Value input buttons appear on the screen. Use the [+] and [-] buttons to adjust the return amount.

"0" :No return

"50" :Return to the 50% position of the brake operation amount

"100" :Return to the neutral position.

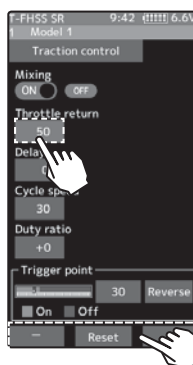
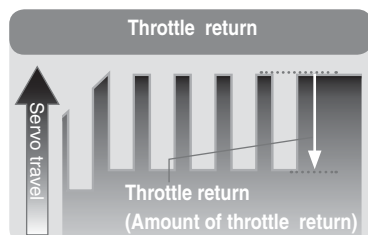

Adjustment buttons

- Adjust with the [+] and [-] buttons.
- Return to the initial value by tapping the [reset] buttons.

Return amount

0 ~ 50 ~ 100
Initial value: 50

The amount of throttle return varies depending on the curve setting of the throttle etc.

3 ("Delay" amount setup)

Tap the value button of the [Delay]. Value input buttons appear on the screen. Use the [+] and [-] buttons to adjust the delay amount.

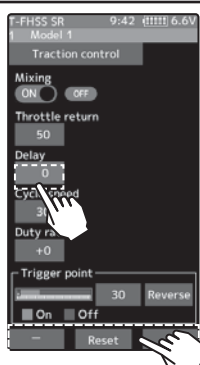

- "0" :Function performed without any delay
- "50" :Function performed after an approximate 0.5 sec delay.
- "100" :Function performed after an approximate 1.0 sec delay.

Adjustment buttons

- Adjust with the [+] and [-] buttons.
- Return to the initial value by tapping the [reset] buttons.

Delay amount

0~ 100
Initial value: 0

4 ("Cycle speed" adjustment)

Tap the value button of the [Cycle speed]. Value input buttons appear on the screen. Use the [+] and [-] buttons to adjust the cycle speed amount.

- The smaller the set value, the faster the pulse speed.

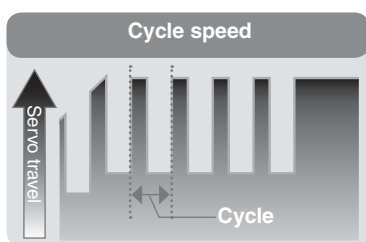

Adjustment buttons

- Adjust with the [+] and [-] buttons.
- Return to the initial value by tapping the [reset] buttons.

Cycle speed amount

1~ 100
Initial value: 30

5 ("Duty ratio" setup)

Tap the value button of the [Duty ratio]. Value input buttons appear on the screen. Use the [+] and [-] buttons to adjust the duty ratio amount.

- "-4" :Brake application time becomes shortest. (Brakes lock with difficulty)
- "+4" :Brake application time becomes longest (Brakes lock easily)

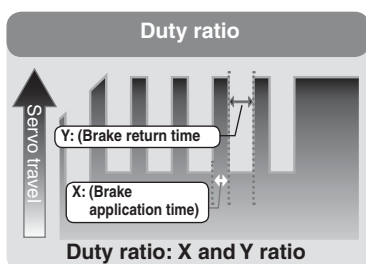

Adjustment buttons

- Adjust with the [+] and [-] buttons.
- Return to the initial value by tapping the [reset] buttons.

Duty ratio amount

-4~ +0~ +4
Initial value: +0

6 ("Trigger point" setup)

Tap the value button of the [Trigger point]. Value input buttons appear on the screen. Use the [+] and [-] buttons to adjust the operation point.

- Sets the throttle trigger position at which the traction control function is performed. The number is the % display with the full brake position made 100.

Tap [Normal] or [Reverse] to set the operating range.

"Normal": High range from the trigger point to the operating range.

"Reverse": Operating range from neutral to trigger point.

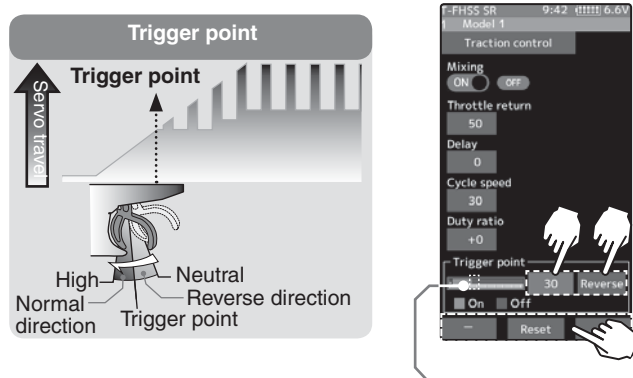

Adjustment buttons

- Adjust with the [+] and [-] buttons.
- Return to the initial value by tapping the [reset] buttons.

Trigger point

5~ 95
Initial value: 30

* Throttle trigger position

7 When finished, return to the Racing menu screen by pressing the HOME button.

Switch setting

Use PS1 to 6 to switch the traction control function ON/OFF.
See the switch select function. (page 69)

Dial / Trim Setting

The throttle return amount, delay amount and cycle speed can be controlled with digital trim DT1~DT6 or digital dial DL1 etc. with the dial select function. (page66)

Start

If the track is slippery and you begin to accelerate by pushing the trigger to full throttle, the car wheels will spin and the car will not accelerate smoothly. When the Start function is activated, merely operating the throttle trigger slowly causes the throttle servo to automatically switch from the set throttle position to a preset point so that the tires do not lose their grip and the car accelerates smoothly.

Without "Throttle speed"
Slow start due to skidding



With "Throttle speed"
Quick start without skidding



Operation

- When the throttle trigger is moved to the preset position (trigger point), the throttle servo moves to the preset position.
- When the throttle trigger is operated slowly so that the wheels will not spin, the car automatically accelerates to the set speed.
- This function is effective only for the first throttle trigger operation at starting. This function has to be activated before every start.
- When the throttle trigger is returned slightly, the Start function is automatically deactivated and the set returns to normal throttle trigger operation.

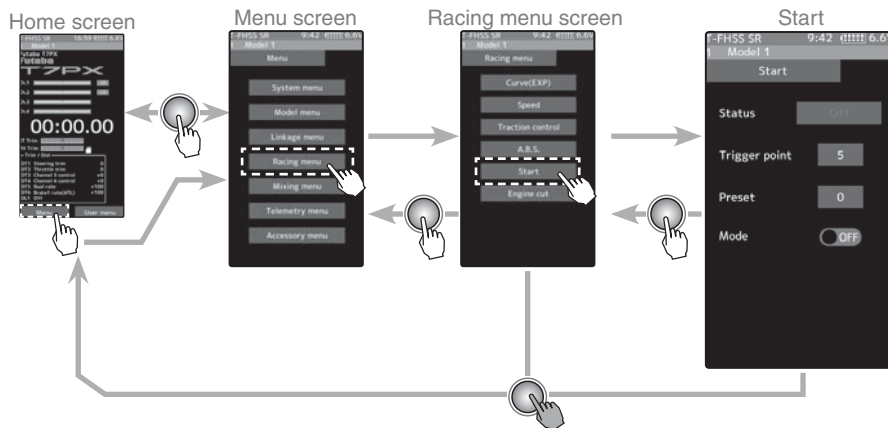

Start function adjustment

1 (Function ON/OFF)

Tap "Mode" (ON) or (OFF) to select ON / OFF.

"OFF" :Start function OFF
"ON" :Start function ON

The status display changes to [Ready].

To enable the [Ready] status with the switch, set the "Start switch" with the switch select function (page 69).

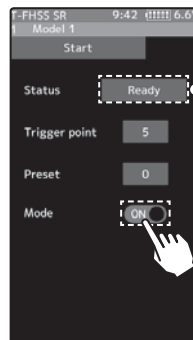

Setting
- Tap (ON) / (OFF).

* The status display changes to "Ready".

Function

2 ("Trigger point" setup)

Tap the value button of the [Trigger point]. Value input buttons appear on the screen. Use the [+] and [-] buttons to adjust the operation point.

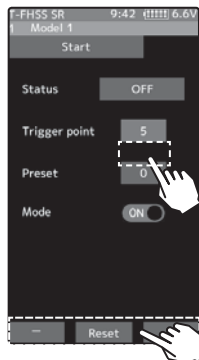

Adjustment buttons

- Adjust with the [+] and [-] buttons.
- Return to the initial value by tapping the [reset] buttons.

Trigger point

5~ 95
Initial value: 30

3 ("Preset position" setup)

Tap the value button of the [Preset]. Value input buttons appear on the screen. Use the [+] and [-] buttons to set the preset position of the throttle servo.

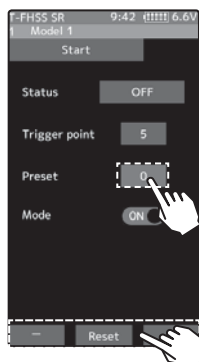

Adjust button

- Adjust with the [+] and [-] buttons.
- Return to the initial value by tapping the [reset] buttons.

Preset position

0~100
Initial value: 0

4 ("Ready" setting)

To set "Ready" again, touch [OFF] of "Status", the display will change to [Ready] and wait for trigger operation. In addition, you can set the switch to be in the [Ready] state in the switch select function (page 69).

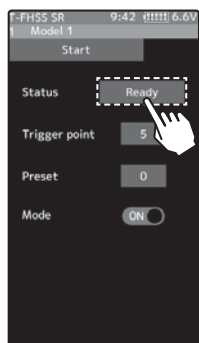

Restart

Tap [OFF] to [Ready]

5 When finished, return to the Racing menu screen by pressing the HOME button.

In the [Ready] state, if the throttle trigger is operated to the position of the trigger position, the throttle servo moves to the servo operation position set with preset. It is canceled when the throttle trigger is returned.

Engine Cut

When the switch is pressed, the throttle servo will move to the preset position without regard to the throttle trigger position. This is convenient when used to cut the engine of boats, etc. (The switch select function. See page 69)

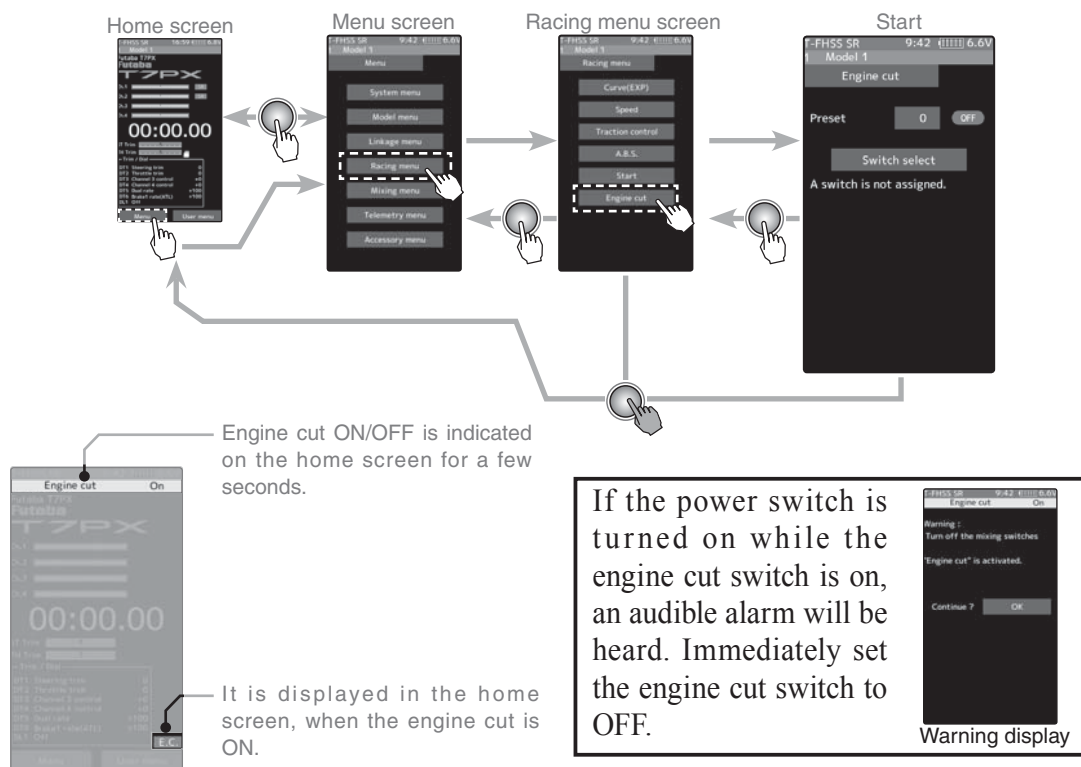

When trigger ratio was set to 100:0

When trigger ratio (page 62) is set to 100: 0, the brake side function will not operate. The preset position set here is the linkage reference. Set the linkage so that the carburetor is fully closed in the preset adjustment range and the engine stops. Full throttle position is set by “advance” of the end point function. Adjust the idling position with throttle trim.

Engine Cut function adjustment

(Preparation)

- Use the switch select function to the "Switch select". (page 69)

When the switch is not set "A switch is not assigned" is displayed. Tap [Switch select] to display the switch selection screen and set the switch.

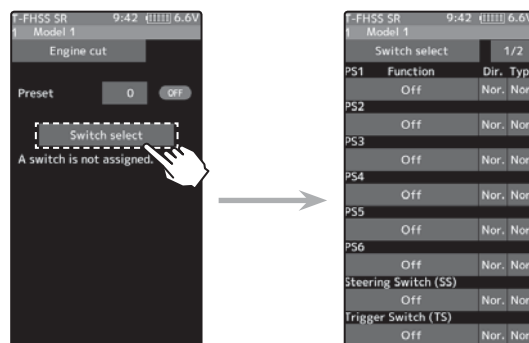

Engine Cut

1 (Preset position setup)

Tap the value button of the [Preset]. Value input buttons appear on the screen. Use the [+] and [-] buttons to set the preset position of the throttle servo.

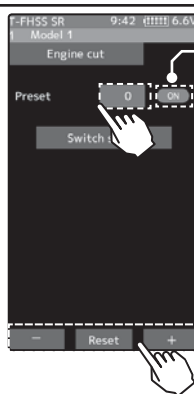

*Shows the ON/OFF state

Adjust button

Adjust with the [+] and [-] buttons.
- Return to the initial value by tapping the [reset] buttons.

Preset position

0~100
Initial value: 0

2 When finished, return to the Linkage menu screen by pressing the HOME button.

Dial / Trim Setting

The function select dial function can control the engine cut preset position with digital dial or digital trim (page 66).

The throttle servo operating position (preset position) set by this setting is unrelated to the setting of other functions. Maximum to minimum servo travel can be set. However, the reverse function setting is enabled.

⚠ Caution

① Always operate carefully before using this function.

While push switch PS1 to PS6, or trigger switch TS with preset function set is in the ON state, the servo (motor controller) is locked in the preset position and does not operate even if the throttle trigger is operated. If the servo was operated at the wrong setting, you may lose control of the car (boat).

Steering Mixing

This mixing function uses 2 servos to individually control the left and right steering. Left and right steering can be set independently so smooth cornering is possible. By using the "Steering mixing rate" function, the motions of the servos on the left and right sides of the steering can be adjusted at the same time. The right side steering servo or the left side steering servo connects to receiver CH1 and the other side connects to receiver auxiliary channels. The channel to which the left and right servo connects is not specified. After the left and right servos are adjusted individually, Ackerman can also be adjusted by Ackerman rate. In addition, the left and right steering are operated in the opposite direction by switch. An emergency brake function by steering can also be set.

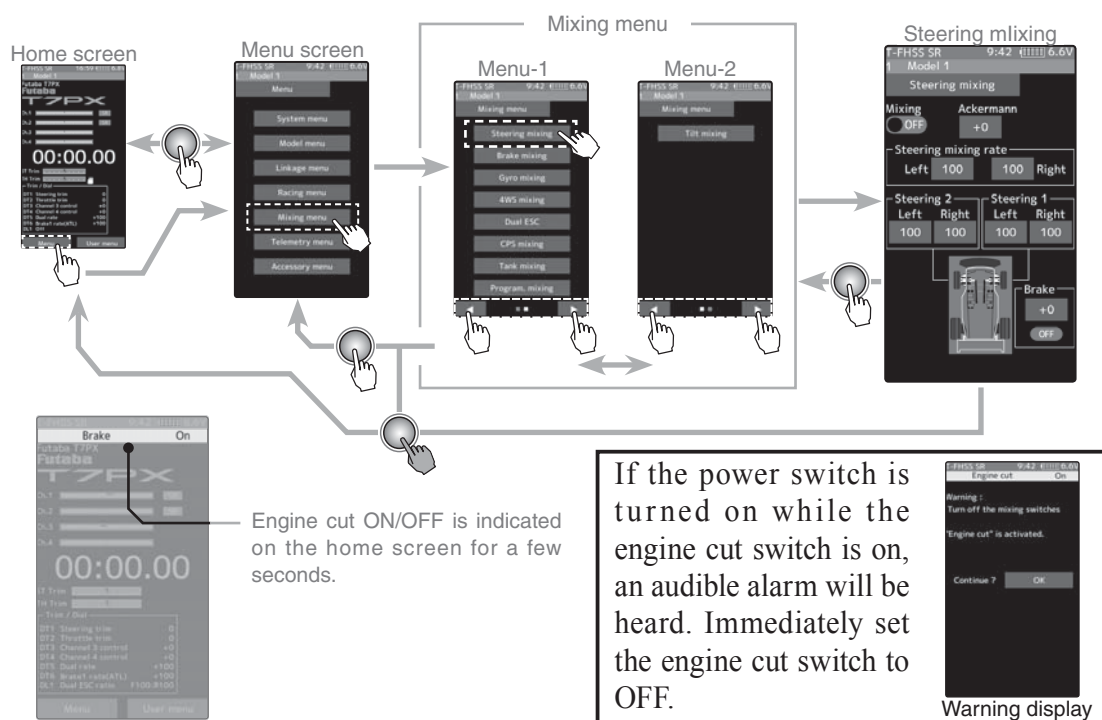

The mixing function is assigned to auxiliary channels used by other mixing cannot be used. When the number of channels is insufficient, cancel the other mixing.

Steering mixing adjustment

- (Function ON/OFF)
Tap "Mixing" (ON) or (OFF) to select ON / OFF.
"OFF" :Mixing function OFF
"ON" :Mixing function ON

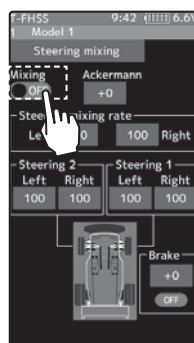

Setting
- Tap (ON) / (OFF).

Steering Mixing

Function

2 (Channel setup)

The channel list screen used for steering 2 is displayed. Tap the auxiliary channel that connected the servo of steering 2.

- When all channels are in use, a screen saying "No assignable channel" is displayed, please turn off other mixing and make an unused channel. You can check the mixing used on the channel setting screen (page 75).
- T7PX can also be used for steering 2 by setting the throttle to another auxiliary channels setting function (P75) and making Ch.2 assignable channel (page 75).

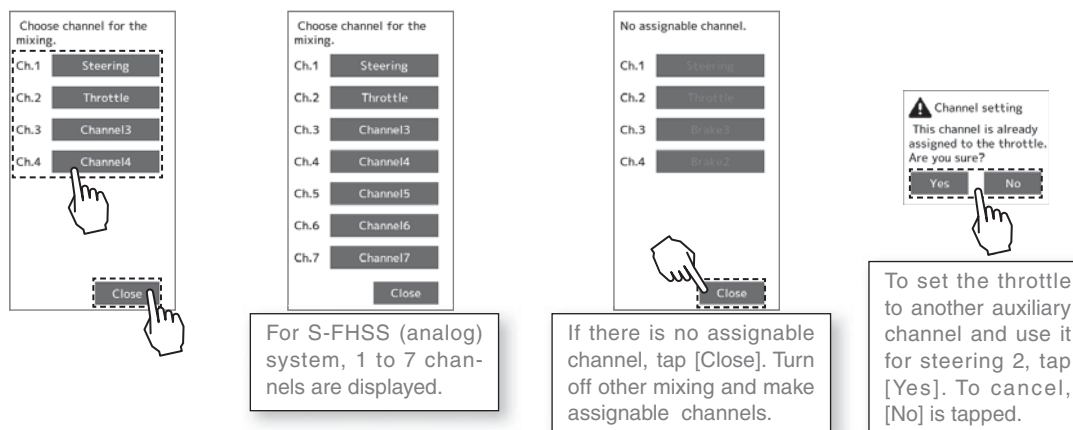

3 (Steering 1 servo steering angle adjustment)

Tap the value button of the "Steering 1" [Left] or [Right]. Value input buttons appear on the screen. Turn the steering wheel fully to the left or right and adjust the left and right steering amounts by [+] or [-] button.

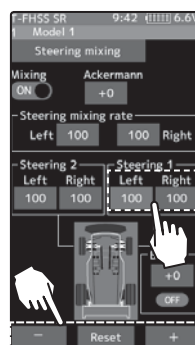

Adjustment buttons

- Adjust with the [+] and [-] buttons.
- Return to the initial value by tapping the [reset] buttons.

Steering 1 rate (Left/Right)

0~140
Initial value : 100

4 (Steering 2 servo steering angle adjustment)

Tap the value button of the "Steering 2" [Left] or [Right]. Value input buttons appear on the screen. Turn the steering wheel fully to the left or right and adjust the left and right steering amounts by [+] or [-] button.

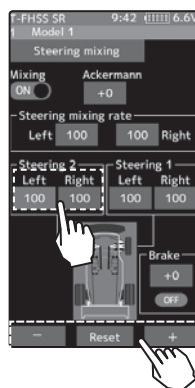

Adjustment buttons

- Adjust with the [+] and [-] buttons.
- Return to the initial value by tapping the [reset] buttons.

Steering 2 rate (Left/Right)

0~140
Initial value : 100

5 (Steering mixing rate adjustment)

Tap the value button of the "Steering mixing rate" [Left] or [Right]. Value input buttons appear on the screen, adjust each of the left/right steering angles using the [+] or [-] button.

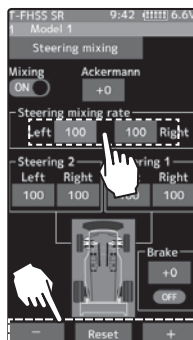

Adjustment buttons

- Adjust with the [+] and [-] buttons.
- Return to the initial value by tapping the [reset] buttons.

Steering mix rate

0~100
Initial value : 100

6 (Ackerman adjustment)

Tap the value button of the "Ackerman rate". Value input buttons appear on the screen, adjust the left and right differential amount and adjust the ackerman by [+] and [-] button.

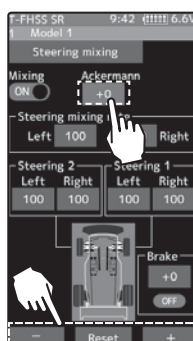

Adjustment buttons

- Adjust with the [+] and [-] buttons.
- Return to the initial value by tapping the [reset] buttons.

Steering mix rate

-100~+0~+100
Initial value : +0

7 (Steering brake) (Preparations)

When using this function, set the switch with the "Switch select" function (page 69). Tap the value button of the "Brake rate". Value input buttons appear on the screen, adjust the steering 1/2 operation position by [+] and [-] button.

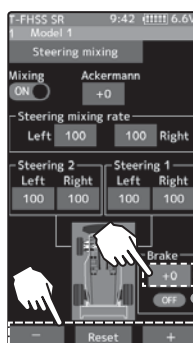

Adjustment buttons

- Adjust with the [+] and [-] buttons.
- Return to the initial value by tapping the [reset] buttons.

Brake mix rate

-100~+0~+100
Initial value : +0

*Shows the ON/OFF state

8 When finished, return to the Racing menu screen by pressing the HOME button twice.

Dial / Trim Setting

The ackerman rate adjustment can be controlled with digital trim DT1~DT6 or digital dial DL1 etc. with the dial select function. (page 66)

Brake Mixing

This function is used when the front and rear brakes must be adjusted independently such as a 1/5 scale GP car. This mixing uses the 2nd channel for the rear brakes and the auxiliary channel for the front brakes, or controls the front brakes with the auxiliary channel servos, or controls the 2nd channel by independent throttle and controls the rear and front brakes with the auxiliary channel. In addition, mixing which varies the auxiliary channels brake rate in proportion to steering operation is also possible.

Operation

- When braking, mixing is applied from brake1 to brake2 and brake3.
- Brake2 and brake3 amount, brake1,2,3 delay, and Brake2 and brake3 EXP and ABS can be set.
- Steering mixing which varies front brakes brake2,3 (auxiliary channels) matched to the steering operation can be set. Front brake2,3 (auxiliary channels) can be individually weakened according to the steering left or right operation amount.

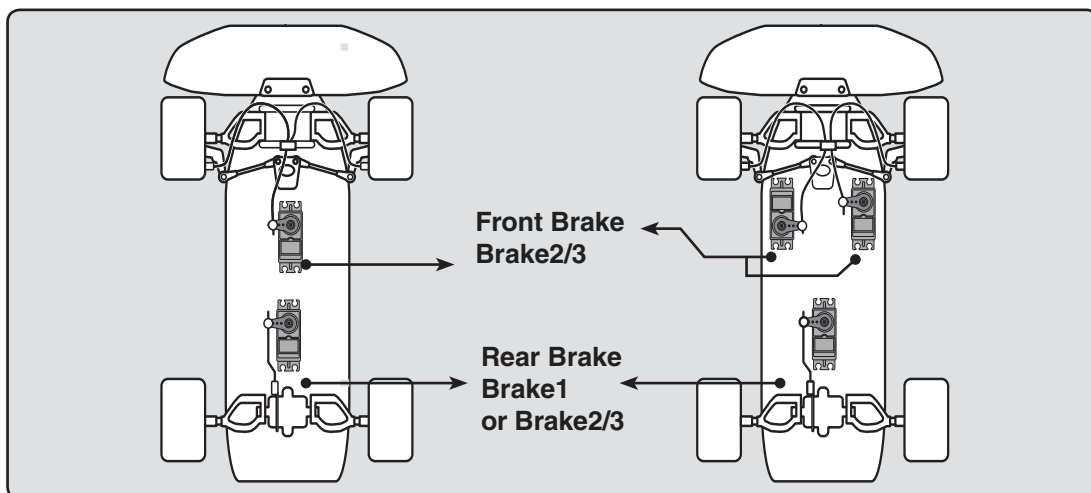

Function

When trigger ratio was set to 100:0

When trigger ratio (page 62) was set to 100:0, brake operation stops. When using brake mixing, set the trigger mode to 70:30 or 50:50.

3rd, 4th channels A.B.S

Brake mixing can also use the A.B.S function (page 90) for 2nd and 3rd brakes. Except for trigger point and steering mixing, it can be set exclusively for 2nd and 3rd brakes side. Even if the A.B.S function on the 1st brake (2nd channel) side is OFF, you can also use the A. B. S function on the 2nd and 3rd brakes side alone. You can set the ON / OFF of the A.B.S (brake 2, 3) function with the switch setting function (page 69).

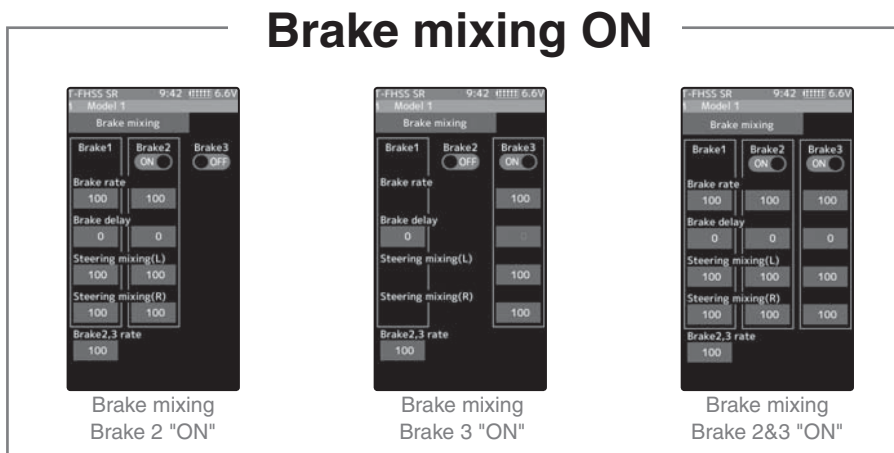
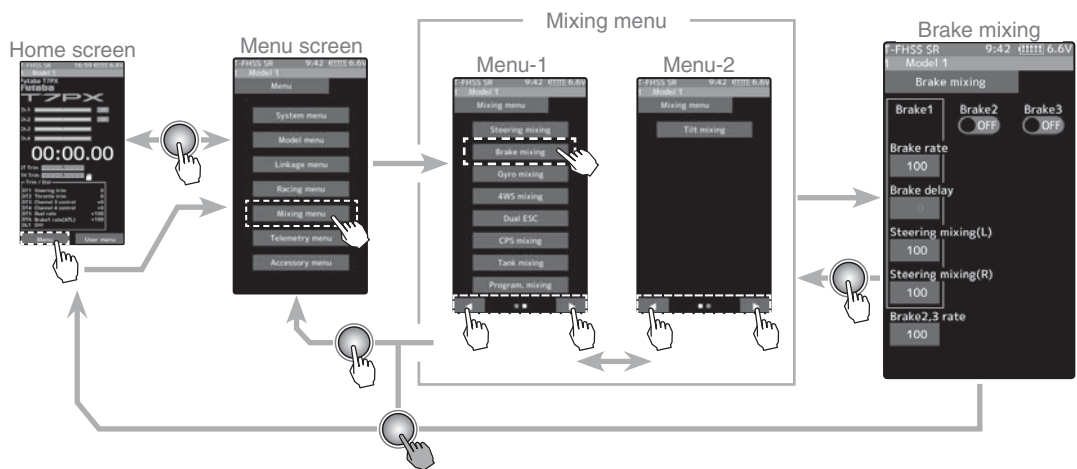

The mixing function is assigned to auxiliary channels used by other mixing cannot be used. When the number of channels is insufficient, cancel the other mixing.

Steering mixing adjustment

- (Function ON/OFF)
Tap "Mixing" (ON) or (OFF) to select ON / OFF.
"OFF" :Mixing function OFF
"ON" :Mixing function ON

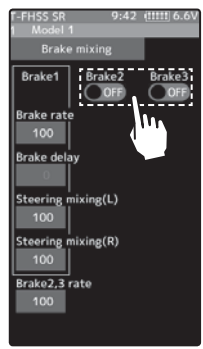

Setting
- Tap (ON) / (OFF).

Function

2 (Channel setup)

The channel list screen used for brake 2 or brake 3 is displayed. Tap the auxiliary channel that connected the servo of brake 2 or brake 3.

- When all channels are in use, a screen saying "No assignable channel" is displayed, please turn off other mixing and make an unused channel. You can check the mixing used on the channel setting screen (page 75).
- T7PX can also be used for brake 2 or 3 by setting the steering to another auxiliary channels with the channel setting function (P75) and making Ch.1 assignable channel (page 75).

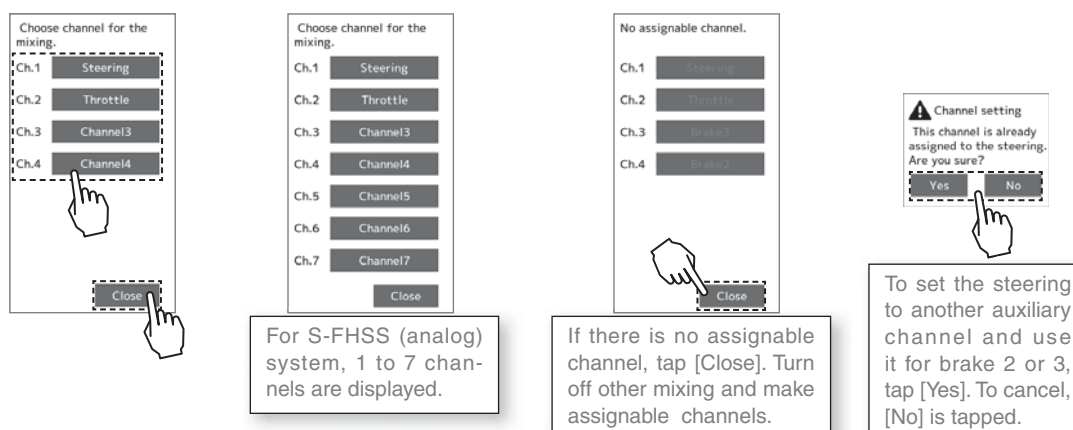

Choose channel for the mixing.

Ch.1 Steering
Ch.2 Throttle
Ch.3 Channel3
Ch.4 Channel4

Close

Choose channel for the mixing.

Ch.1 Steering
Ch.2 Throttle
Ch.3 Channel3
Ch.4 Channel4
Ch.5 Channel5
Ch.6 Channel6
Ch.7 Channel7

Close

No assignable channel.

Ch.1 Steering
Ch.2 Throttle
Ch.3 Brake3
Ch.4 Brake2

Close

Channel setting
This channel is already assigned to the steering.
Are you sure?
Yes No

For S-FHSS (analog) system, 1 to 7 channels are displayed.

If there is no assignable channel, tap [Close]. Turn off other mixing and make assignable channels.

To set the steering to another auxiliary channel and use it for brake 2 or 3, tap [Yes]. To cancel, [No] is tapped.

3 (Brake 2 & 3 rate)

Tap the value button of the "Brake 2 or 3" [Brake rate]. Value input buttons appear on the screen, use the [+] and [-] buttons to adjust the brake rate amount.

- When adjusting the brake amount of both brakes after individually adjusting the Brake2 and Brake3, select "Brake2,3 rate".
- The brake 1 rate is linked with throttle channel (ATL) setting.

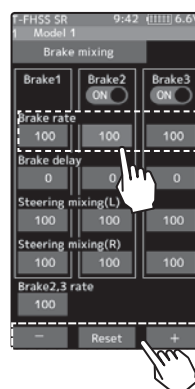

Adjustment buttons

- Adjust with the [+] and [-] buttons.
- Return to the initial value by tapping the [reset] buttons.

Brake rate

0 ~ 100
Initial value:100

4 (Delay amount setup)

Tap the value button of the "Brake 1 or 2,3" [Brake delay]. Value input buttons appear on the screen, use the [+] and [-] buttons to adjust the delay amount.

- Since a delay at all the brakes is dangerous, a delay is not applied to the brake to be adjusted last. For example, when brakes 1, 2, and 3 are all used, when a delay is applied to brakes 2 and 3, a delay cannot be applied to brake 1. When a delay must be applied to brake 1, the brake 2 or brake 3 delay must be set to "0".



5 (Steering mixing)

Use this function when you want to weaken the brakes when steering was operated.

Tap the value button of the "Brake 1 or 2,3" [Left]. Value input buttons appear on the screen. use the [+] and [-] buttons to adjust the rake amount.

Tap the value button of the "Brake 1 or 2,3"[Right]. Value input buttons appear on the screen. use the [+] and [-] buttons to adjust the rake amount. The smaller the value, the weaker the front brakes. Set value "100" is the state in which steering mixing is not performed.

- The mixing amount can be adjusted in a range from 0 to 100.

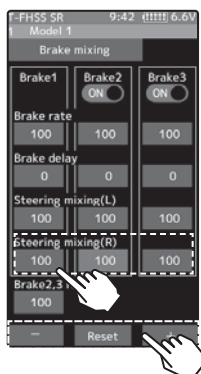
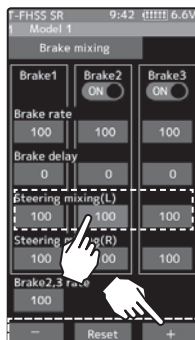

Adjustment buttons

- Adjust with the [+] and [-] buttons.
- Return to the initial value by tapping the [reset] buttons.

Brake rate (Mixung)

100~0
Initial value:100

6 When finished, return to the Mixing menu screen by pressing the HOME button twice.

Dial / Trim Setting

The dial select function can control the brake 1,2,3 rate , delay amount and EXP setting using digital dial or digital trim. (page 66)

Gyro Mixing

This function is a remote gain function which adjusts the sensitivity of the Futaba car rate gyro at the T7PX side, and is mixing that uses the auxiliary channels to adjust the gyro sensitivity. When using the T7PX by switching the AVCS and normal modes use PS1- PS6 with the switch select function (page 69).

For a description of the car rate gyro mounting method and handling, refer to the rate gyro instruction manual.

When using SR mode compatible gyro in SR mode channel set both steering input and gyro sensitivity input channel to SR mode. If either one is in normal mode, gyroscope will not operate properly.

AVCS / NORMAL Modes

The gyro has 2 operating modes: NORMAL mode and AVCS mode. In the AVCS mode, the angle is controlled simultaneously with NORMAL mode rate control (swing speed). The AVCS mode increases straight running stability more than that of the NORMAL mode. Because the feel of operation is different, choose your favorite mode.

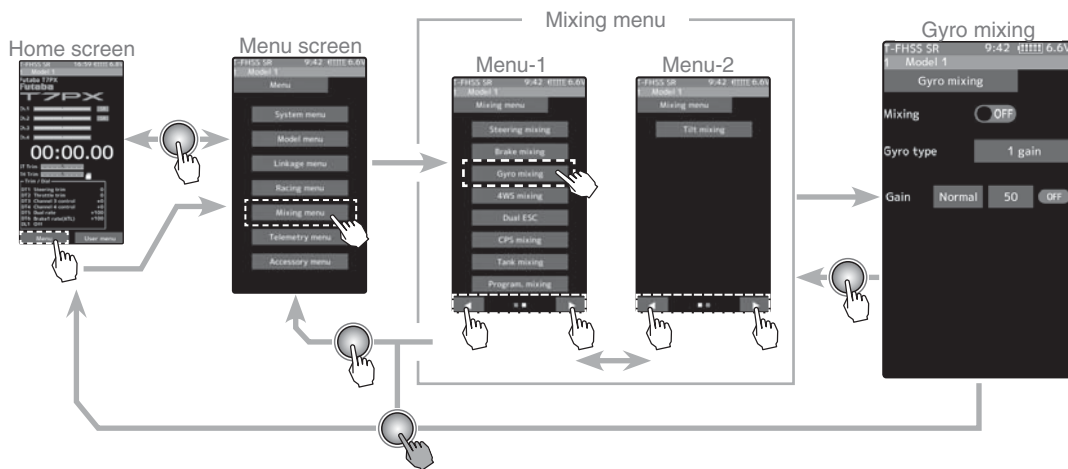

The mixing function is assigned to auxiliary channels used by other mixing cannot be used. When the number of channels is insufficient, cancel the other mixing.

Function

Gyro mixing adjustment

(Preparation)

- Refer to the gyro instruction manual and connect the gyro to the receiver. When using remote gain, connect gyro sensitivity adjustment to the auxiliary channels of the receiver.
- When using gyro mixing by switching between the NORM (normal) and AVCS modes, use the switch select function (page 69) to set the switch to be used.

1 (Function ON/OFF)

Tap "Mixing" (ON) or (OFF) to select ON / OFF.

"OFF" :Mixing function OFF

"ON" :Mixing function ON

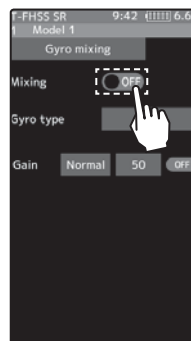

Setting

- Tap (ON) / (OFF).

2 (Channel setup)

The channel list screen used for the gain steering channel is displayed. Tap the auxiliary channel that connected the gain steering channel.

- When all channels are in use, a screen saying "No assignable channel" is displayed, please turn off other mixing and make an unused channel. You can check the mixing used on the channel setting screen (page 75).

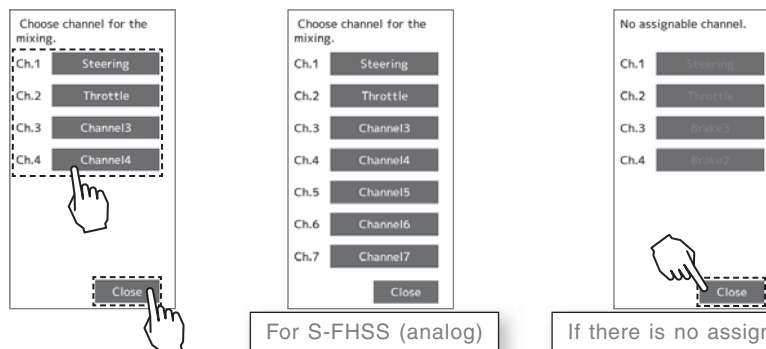

For S-FHSS (analog) system, 1 to 7 channels are displayed.

If there is no assignable channel, tap [Close]. Turn off other mixing and make assignable channels.

3 (Gyro mixing type selection)

Touch the Gyro type and select [1 gain], [2 gain] or [4 gain].

- "1 gain" :One mode only
- "2 gain" :Switching Gyro gain 1 and Gyro gain 2
- "4 gain" :Set 4 Gyro gains.
2 groups of 2 gains can be set in one group.
Set the switch to change the group and the switch to change the gain in the group. (Use to 2 switch)

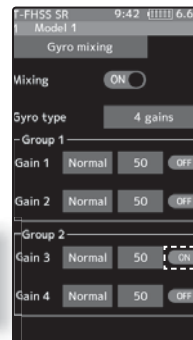
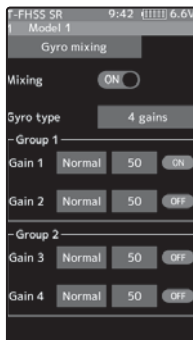
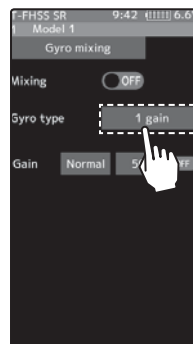

Can be switch the group with the group change switch.

Setting

- Tap Gain type.
1 gain/ 2 gain/ 4 gain

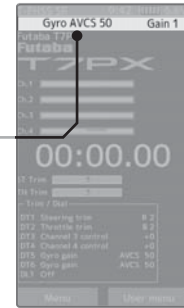

When changing the gain with the switch, indicated on the home screen for a few seconds.

* Display the current gyro gain.

4 (Gyro gain adjustment)

Tap the value button of each the [Gain]. Value input buttons appear on the screen, use the [+] and [-] buttons to adjust the brake rate amount.

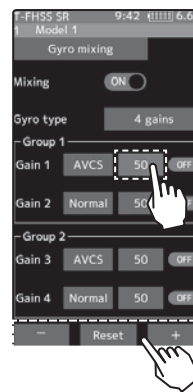

Adjustment buttons

- Adjust with the [+] and [-] buttons.
- Return to the initial value by tapping the [reset] buttons.

Gyro gain

AVCS120~0~Normal120
Initial value:50

Function

5 When finished, return to the Mixing menu screen by pressing the HOME button twice.

Dial / Trim Setting

The gain amount can be adjusted by using the dial select function. (page 66)

4WS Mixing

This function can be used with crawlers and other 4WS type vehicles. It is mixing that uses the 1st channel to control front side steering and the auxiliary channel to control rear side steering.

A method of specifying directly for each type of opposite phase (only on the in-phase side), reverse phase, in-phase side and rear side by selecting PS1, PS2, PS4, PS5, PS6 in the "Switch select" function (page 69). And, it is possible to switch in order.

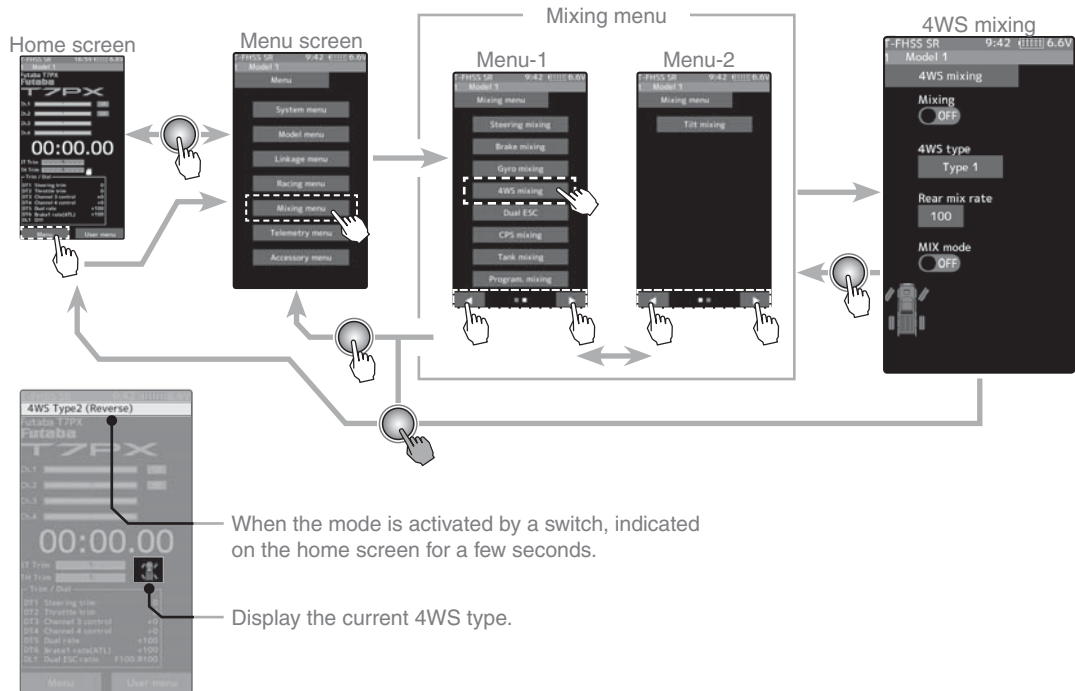

The mixing function is assigned to auxiliary channels used by other mixing cannot be used. When the number of channels is insufficient, cancel the other mixing.

4WS mixing adjustment

(Preparation)

- Since this function is used by switching the type of 4WS with a switch, the switch used by the switch select function (page 69) is set.

1 (Function ON/OFF)

Tap "Mixing" (ON) or (OFF) to select ON / OFF.

- "OFF" :Mixing function OFF
- "ON" :Mixing function ON

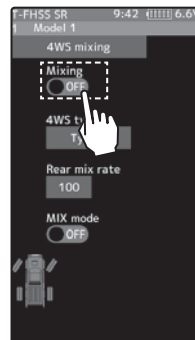

Setting

- Tap (ON) / (OFF).

2 (Channel setup)

The channel list screen used for rear steering is displayed. Tap the auxiliary channel that connected the servo of rear steering.

- When all channels are in use, a screen saying "No assignable channel" is displayed, please turn off other mixing and make an unused channel. You can check the mixing used on the channel setting screen (page 75).
- T7PX can also be used for rear steering by setting the throttle to another auxiliary channels setting function (P75) and making Ch.2 assignable channel (page 75).

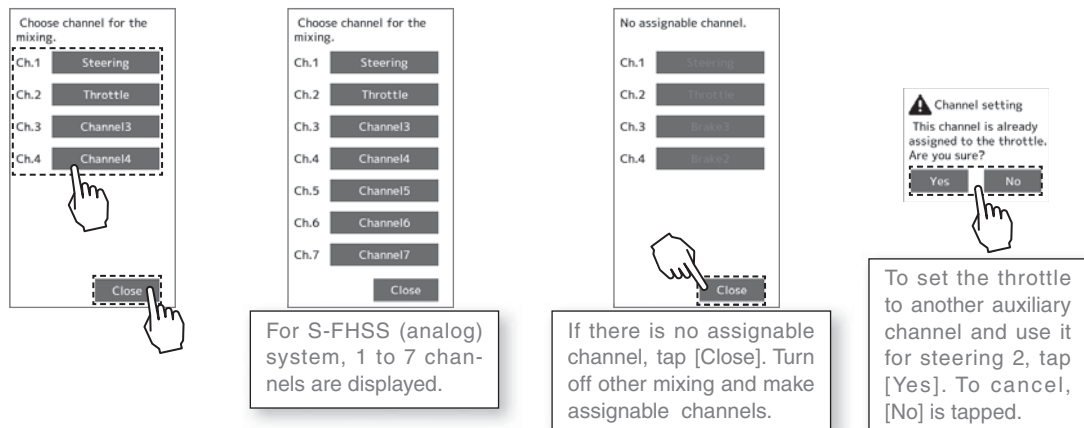

3 (4WS type selection)

Touch the 4WS type and select [Type 1], [Type 2], [Type 3] or [Type 4].

"Type1" :Function OFF (front only)

"Type2" :Front side only, reverse phase switching

"Type3" :Front side only, reverse phase and same phase switching

"Type4" :Front side only, reverse phase, same phase, and rear side only switching

Setting

- Tap T4WS type.

Type 1/ Type 2/ Type3/ Type 4

Switched in the order shown in the figure below by set SW

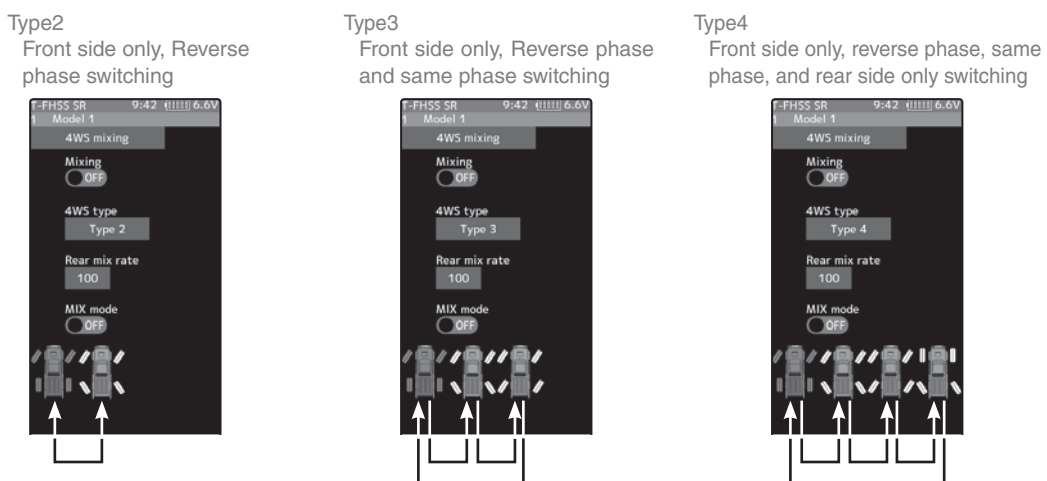

4 (Rear side travel adjustment)

Tap the value button of the [Rear mix rate]. Value input buttons appear on the screen, use the [+] and [-] buttons to adjust the rear side travel amount.



Adjustment buttons

- Adjust with the [+] and [-] buttons.
- Return to the initial value by tapping the [reset] buttons.

Rear rate (Rear mix rate)

0~100
Initial value:100

5 (Mix mode setting)

Tap "MIX mode" (ON) or (OFF) to select ON / OFF.

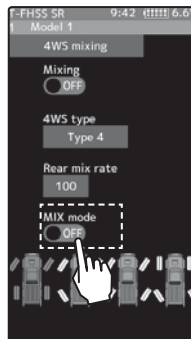

Setting

- Tap (ON) / (OFF).

"OFF" :The EXP function of the 1st CH and other settings are not mixed.

"ON" :The EXP function of the 1st CH and other settings are mixed.

6 When finished, return to the Mixing menu screen by pressing the HOME button twice.

Dial / Trim Setting

The mixing amount can be adjusted by using the dial select function. (page 66)

Dual ESC

This function is mixing two ESC's used with crawlers and other 4WD type vehicles and uses the 2nd channel to control the rear motor controller and the auxiliary channel to control the front motor controller.

Front drive only, rear drive only, and both front and rear drive (4WD) switching can be performed by trim dial or by setting a switch for each mode.

Use a 50:50 trigger ratio setting. (page 62).

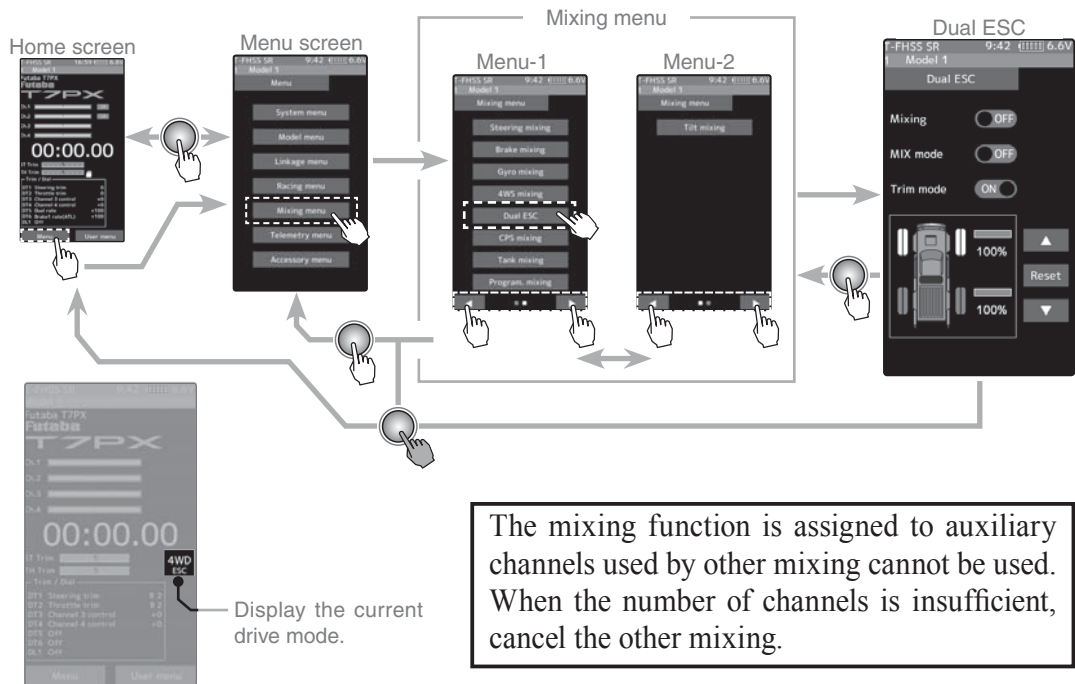

Dual ESC mixing adjustment

(Preparation)

- This function has 2 methods. One method is used by switching the drive type (4WD/front/rear) by one digital trim/dial. The other method performs switching by assigning a switch to each mode (4WD/front/rear). Both methods are set from among DL1 and DT~1DT6 by "Trim/Dial select" function.

1 (Function ON/OFF)

Tap "Mixing" (ON) or (OFF) to select ON / OFF.

"OFF" :Mixing function OFF
 "ON" :Mixing function ON

When switching by one digital trim is set, the set switch performs switching as shown below.

Front drive ↔ 4WD ↔ Rear drive

Setting

- Tap (ON) / (OFF).

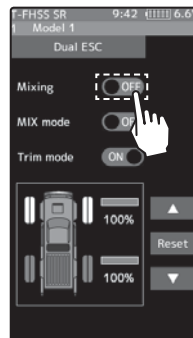

2 (Channel setup)

The channel list screen used for the front ESC channel is displayed. Tap the auxiliary channel that connected the front ESC channel.

- When all channels are in use, a screen saying "No assignable channel" is displayed, please turn off other mixing and make an unused channel. You can check the mixing used on the channel setting screen (page 75).

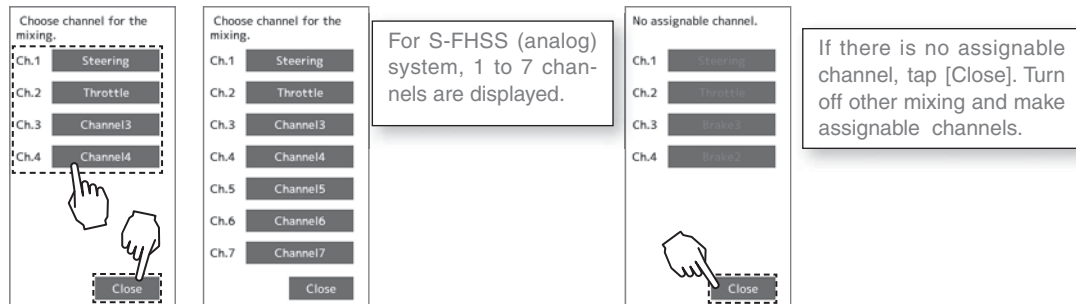

3 (Drive ratio adjustment)

Adjust the front and rear motor controller operation amount by Δ or ∇ button. The ∇ button increases and the Δ button decreases the rear ratio.

Both the front and rear ratios become 100%

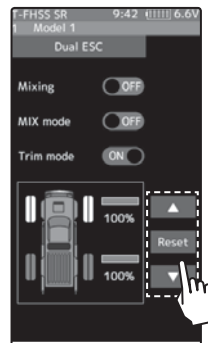

Adjustment buttons

- Adjust with the Δ and ∇ buttons.
- Return to the initial value by tapping the [reset] buttons.

Rear rate (Rear mix rate)

0~100
Initial value:100

4 (Mix mode setting)

Tap "MIX mode" (ON) or (OFF) to select ON / OFF.

"OFF" :The EXP function of the 2nd CH and other settings are not mixed.

"ON" :The EXP function of the 2nd CH and other settings are mixed.

Setting

- Tap (ON) / (OFF).

5 (Trim mode setup)

Tap "Trim mode" (ON) or (OFF) to select ON / OFF.

"OFF" :The trim of the 2nd CH is not mixed.

"ON" :The trim of the 2nd CH is mixed.

Setting

- Tap (ON) / (OFF).

6 When finished, return to the Mixing menu screen by pressing the HOME button twice.

Dial / Trim Setting

The dial select function can control the drive ratio with digital dial or digital trim.(page 66)

Note:

As this function drives 2 separate motor controllers simultaneously, a mutual load is applied. Use this function carefully so that the motor controllers are not damaged. Futaba will not be responsible for motor controller, motor, and other vehicle trouble due to use of this function.