



Spectrum Series™
Base Loaded Mobile Antennas

Installation Manual

Foreword

This manual applies to mobile radios, unless otherwise specified. It includes instructions for installing antennas in a vehicle roof-top configuration.

Product Safety and RF Exposure Compliance

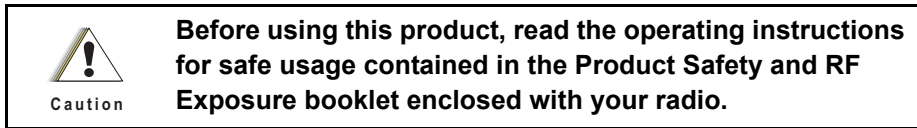

ATTENTION!

This radio is restricted to occupational use only to satisfy FCC RF energy exposure requirements. Before using this product, read the RF energy awareness information and operating instructions in the Product Safety and RF Exposure booklet enclosed with your radio (Motorola Publication part number 6881095C99) to ensure compliance with RF energy exposure limits.

For a list of Motorola-approved antennas, batteries, and other accessories, visit the following website: <http://www.motorola.com/governmentandenterprise>

Document Copyrights

No duplication or distribution of this document or any portion thereof shall take place without the express written permission of Motorola. No part of this manual may be reproduced, distributed, or transmitted in any form or by any means, electronic or mechanical, for any purpose without the express written permission of Motorola.

Disclaimer

The information in this document is carefully examined, and is believed to be entirely reliable. However, no responsibility is assumed for inaccuracies. Furthermore, Motorola reserves the right to make changes to any products herein to improve readability, function, or design. Motorola does not assume any liability arising out of the applications or use of any product or circuit described herein; nor does it cover any license under its patent rights nor the rights of others.

Trademarks

MOTOROLA, the Stylized M logo, and ASTRO are registered in the US Patent & Trademark Office. All other products or service names are the property of their respective owners.

© 2000 – 2010 by Motorola, Inc.

Spectrum™ Series Base Loaded Mobile Antennas

Manufactured by Motorola

- Antenna Installation
- Mounting Instructions
- Cutting Charts
- Replacement Parts
- Connector Instructions

 Important	Read all instructions carefully before starting the installation.
---	---

Introduction

Thank you for selecting the Spectrum mobile antenna. The Spectrum antennas have been designed to withstand demanding and rugged environments. During the design phase, the antennas are put through extensive Accelerated Life Testing (ALT), which simulates years of in-field service. As a result, potential problems are designed out, helping to ensure that the antennas which you receive can give you years of dependable performance.

 DANGER	Antenna contact with high voltage wires may result in death from electrocution.
--	---

 Important	Since April 3, 1994, the warranty on Spectrum antennas have been changed to one year. Motorola manufactured Spectrum antennas are warranted to be free from defects in workmanship and materials for a period of (1) one year from the date of shipment.
---	--

Motorola Communications Part Division
1313 E. Algonquin Road
Schaumburg, Illinois 60196
To order, Call Toll-Free: 1 - 800- 422 - 4210

Before You Start

Roof Mount Safety Precautions and Problem Prevention – for Motor Vehicle Use only

Safe Antenna Installation

 Caution	Be sure to mount the antenna on a horizontal surface to keep the antenna as vertical as possible, thus preventing the antenna from protruding beyond the vehicle and causing bodily injury and/or property damage.
---	--

Entering Garages

 Caution	<p>Remove the antenna from the vehicle when entering a garage to prevent damage to the vehicle and the antenna whip/ball from damaging overhead light fixtures and garage doors.</p>
---	--

Automatic Car Wash

 Caution	<p>Remove the entire antenna from the vehicle before entering the automatic car wash to prevent damage to the antenna and vehicle. The antenna mount contact must be wiped dry to prevent moisture from damaging the contact.</p>
---	---

Installation

Where to Mount the Antenna

General

Motorola recommends that mobile antennas be located as follows:

Recommended Antenna Location

Standard Metal Passenger vehicles	Recommended Location
Standard metal passenger vehicles	Center roof or center trunk lid
Vans, pickups, and other light trucks (metal roofs)	Center roof
Heavy duty equipment with metal roofs (heavy duty trucks, semi-tractors, heavy refuse trucks, cement mixer trucks)	Center cab roof
Specialty vehicles (such as T-roofs, sun roofs, or convertibles)	Center trunk lid—recommended only for transmitter output of less than 7 W.
Other vehicles	Contact your Motorola Field Technical Representative.

Select a location for the antenna as near the center of the roof as possible. Probe the headlining with your fingers to make sure that all points of obstruction are avoided.

Mobile Antenna Installation

Mobile Radio Operation and EME Exposure

Observe the following caution and electromagnetic energy exposure (EME) statements when installing antennas:

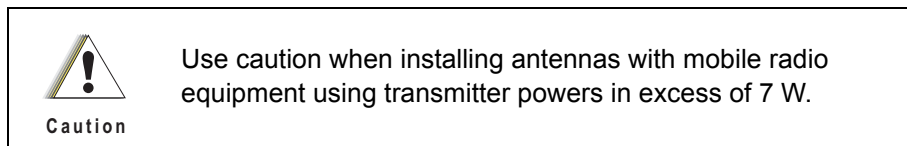

NOTE: For low power mobile radios (7 W or less), there are no antenna type or installation restrictions.

To assure optimal radio performance and that human exposure to radio frequency electromagnetic energy is within the guidelines references in this document, transmit only when people outside the vehicle are at least the minimum distance away from a properly installed, external mounted antenna.

Table 1 lists the minimum distance from several different ranges of rated radio power.

Table 1 Rated Power and Distance

Rated Power of Vehicle-installed Mobile Two-Way Radios	Minimum Distance from Transmitting Antenna
7 to 15 Watts	1 foot (30.5 cm)
16 to 50 Watts	2 feet (61 cm)
More than 50 Watts	3 feet (91.5 cm)

Selecting an Antenna Site

1. Install the vehicle antenna **external** to the vehicle and in accordance with the requirements of this documents.
2. The best mounting location for the antenna is at the center of a large, flat, conductive surface. In almost all vehicles, mounting the antenna in the center of the roof will satisfy these requirements. A good alternative location is in the center of the trunk lid. If you use the trunk lid, ensure that the trunk lid is grounded by connecting grounding straps between the trunk lid and the vehicle chassis.
3. Ensure the antenna cable can be easily routed to the radio. Ensure that the antenna cable is routed separately and not in parallel to any other vehicle wiring or mobile radio cable wiring.
4. Check the antenna location for any electrical interference.

NOTE: Any two metal pieces rubbing against each other, such as seat springs, shift levers, trunk and hood lids, exhaust pipes etc.) in close proximity to the antenna can cause severe receiver interference.

5. If the vehicle is equipped with an electronic anti-lock braking system (ABS), and the antenna will be trunk mounted, then install the antenna on the side opposite to the braking modulator box. This minimizes radio interference to the modulator box from the radio.
6. Make sure the mobile radio antenna is installed at least one foot (30.48 cm) away from any other antenna on the vehicle.

Antenna Assembly Instructions

If antenna mount has not been installed, refer to the Antenna Mount Installation instructions. Assemble the antenna assembly (except the whip) onto the mounting base as shown in [Figure 1](#).

1. Place the lock washer on stud loading coil/base housing.
2. Assemble either the standard duty or heavy duty spring adaptor to the base housing assembly by threading onto the housing stud with lock washer already in place.
3. Hand tighten the adaptor until the lock washer is fully compressed.
4. Press rubber gasket onto the bottom of the coil housing.
5. Do not insert the antenna whip into the antenna adaptor at this time. Refer to the [Tuning the Antenna section on page 1-12](#) for further instructions.

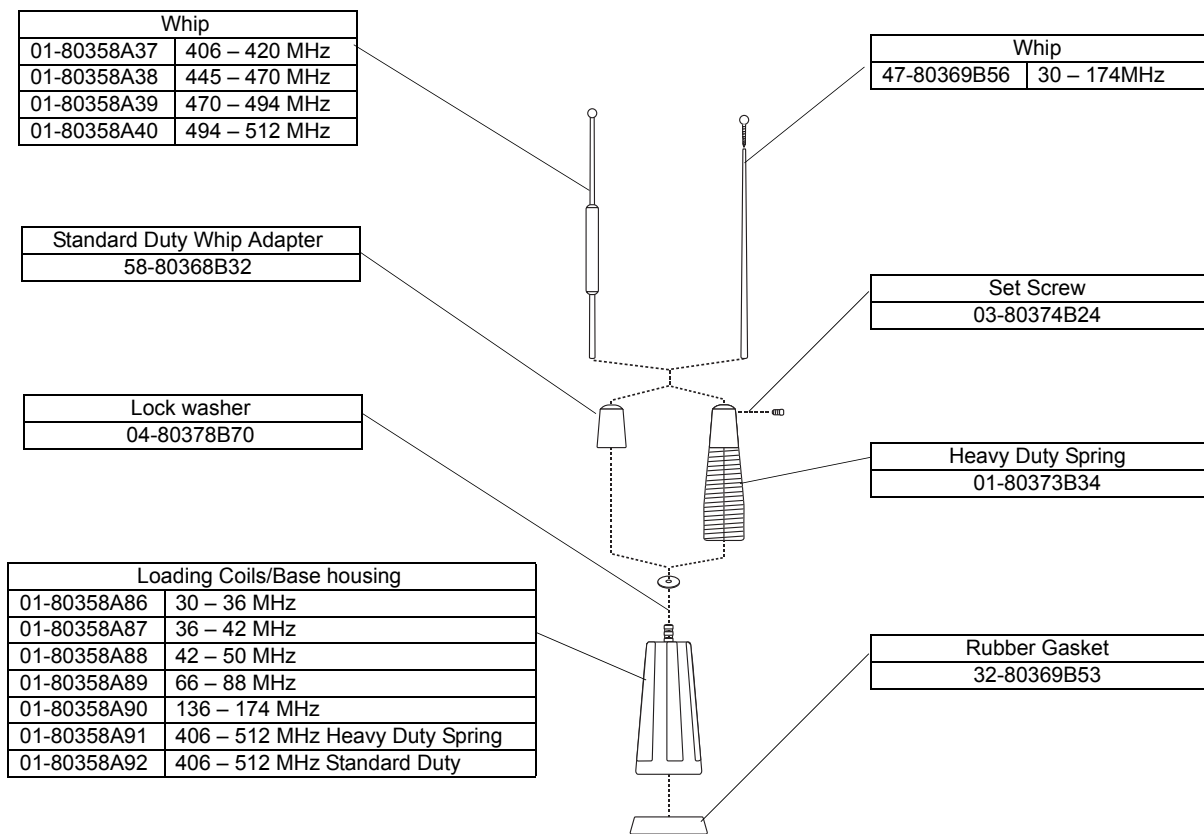

Figure 1.

Antenna Mount Installation Instructions

Roof (Permanent 3/4" Hole) Mount Instructions

Tools Required:

- Safety glasses
- Hole saw (Motorola part # RPX-4378A)
- 15/16" open-end wrench
- Solder, 60/40 rosin flux
- Crimp tool, Motorola part # 66-80388A26 (Mini-UHF Connector only)
- Electric drill
- Spanner wrench, Motorola part # 66-80371A75
- Soldering iron, 40 – 75 watts

1. Drill a 3/4" hole in the vehicle with antenna hole cutting saw, Motorola part # RPX-4378A, and remove all burrs. The antenna hold saw will remove paint in a narrow ring around hole to assure good metal contact between vehicle and mount.
2. Apply generous amounts of silicon grease to inner and outer threads of brass lock nut. Feed coaxial cable and mount through hole as shown in [Figure 2](#).

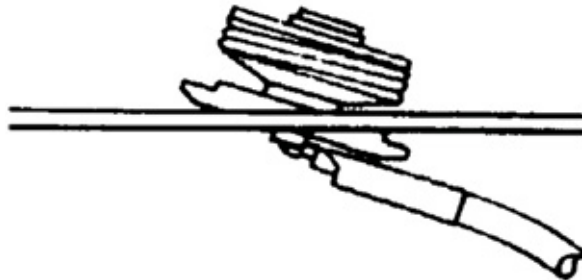

Figure 2.

3. Thread locking nut onto mount and pull up mount base to properly align in hole. While pulling up, finger tighten the locking nut against roof top as show in [Figure 3](#).

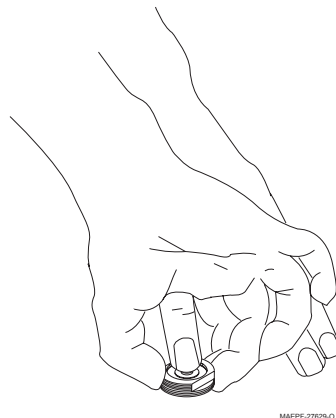

Figure 3.

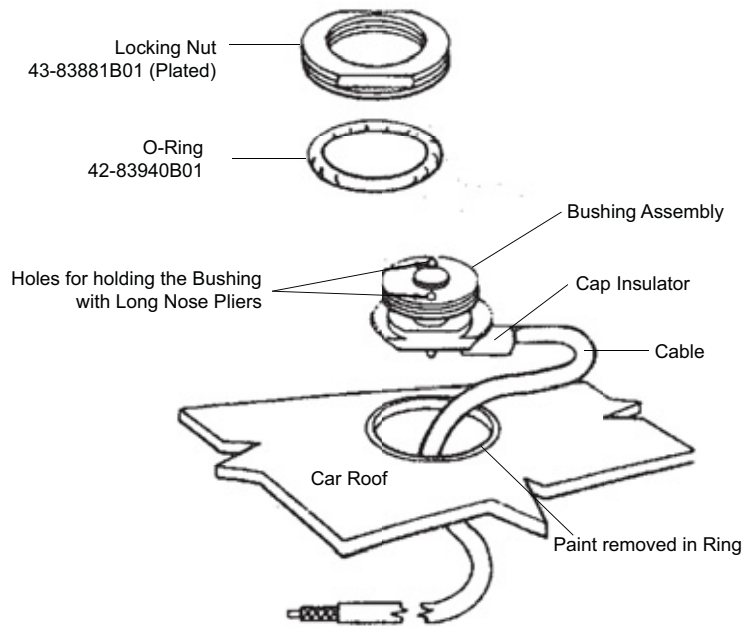

Figure 4.

4. Insert spanner wrench, part # 66-80371A75 or the tops of a needle nose pliers in bushing assembly to prevent mount assembly from slipping. Use a 15/16" open-end wrench to tighten locking nut firmly against vehicle surface. The locking nut must be in contact with vehicle metal to ensure proper antenna radiation. See [Figure 4](#).

Trunk Lid Mount Installation

1. Trunk lid mount may be placed at the center of trunk lid near the rear window, or to the side, preventing the antenna from hitting the rear window when raising the trunk lid. Be sure the coaxial cable is not pinched under the mount clamp bracket. Refer to [Figure 5](#).

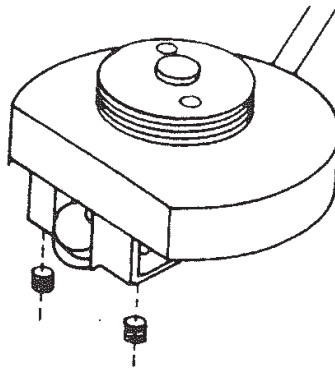

Figure 5. Coaxial Cable Insertion

2. Using the allen wrench supplied, tighten the set screws clockwise until the set screws break through the paint, creating a good contact.

3. Route coaxial cable from the trunk lid to the radio.

Magnet Mount Installation



WARNING

Do not use magnet mount on vinyl roofs, magnet mount will not properly hold the antenna on vehicle because holding power is reduced. Magnet mount will not “hold on” to aluminum and non-metallic surfaces.

1. Remove all dirt and grime that will prevent magnet mount from seating securely.
2. Place magnet mount in final position. Sliding the mount may scratch paint surface.
3. Route coaxial cable to the radio,. Refer to [Figure 6](#).

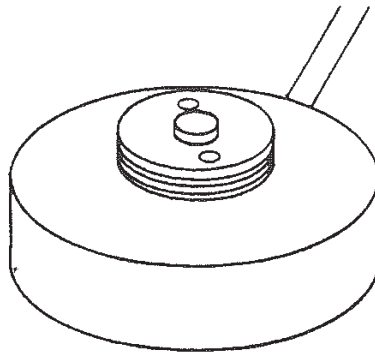

Figure 6. Magnetic Mounted Base

Connector Installation

Before installing the connector, cut off any excess length of cable (at the radio end) to avoid unnecessary signal loss. When the necessary preparations have been made, install the connector using the following steps:

UHF Connector (Motorola part # 28-82021G01)

1. Disassemble the connector as shown in [Figure 7A](#).
2. Cut off end of cable squarely and remove 3/4” of vinyl jacket. Refer to [Figure 7B](#).
3. Slide coupling ring and adaptor on cable as in [Figure 7C](#).
4. Fan braid slightly and fold back as shown in [Figure 7D](#).
5. Position adaptor to dimension as shown in [Figure 7E](#). Press braid back over body of adaptor and trim to 3/8”. Base 5/8” of conductor. Tin exposed center conductor. Add teflon washer for 470 MHz and higher.



Caution

Use a hot soldering iron. DO NOT USE EXCESSIVE HEAT OR SOLDER. Solder quickly to avoid melting surrounding insulation.

6. Screw adaptor to the body of plug assembly. Solder braid to body of plus assembly through holes. Solder center conductor of cable to plug contact of plug assembly. Refer to [Figure 7F](#).
7. For final assembly, screw coupling on plug assembly.
8. Connect cable to antenna connector on radio set. Tighten coupling ring cross section of final assembly as shown in [Figure 7G](#).

NOTE: Coupling ring and plug sub assembly comprise of Motorola part number: 28-82021G01.

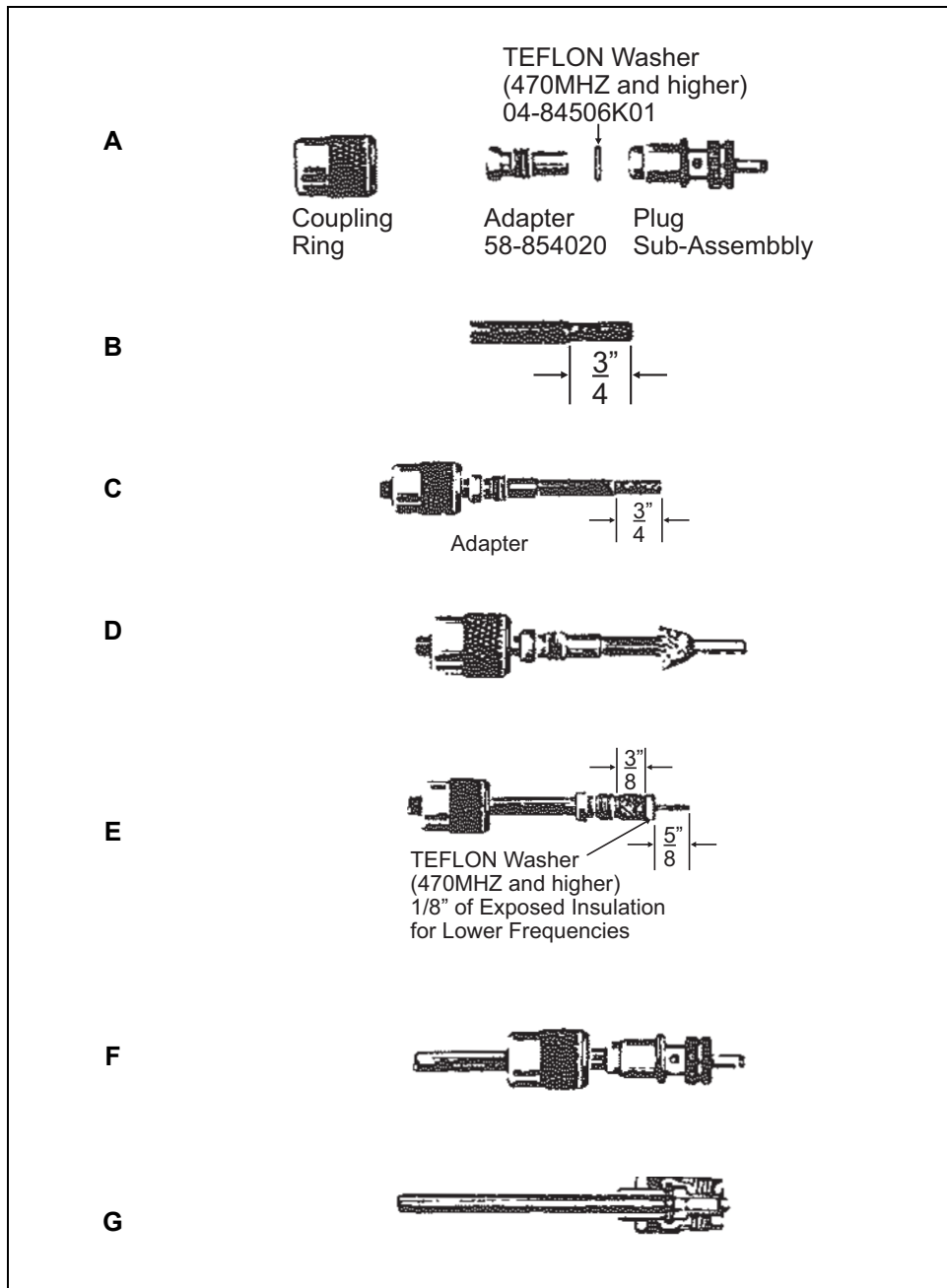

Figure 7.

Mini-UHF Connector Installation #28-84606M01

Installation Instructions

Use Motorola tool part # 66-80388A26 (Refer to [Figure 8](#)).

1. Slip ferrule and collar onto cable. See [Figure 10](#).
2. Prepare cable to strip dimensions as per [Figure 11](#).
3. Insert stripped cable into plug body until conductor is exposed (front end) and dielectric bottoms inside body. See [Figure 10](#).
4. Crimp center contact using crimp area C of [Figure 8](#) . Crimp at base of center contact, avoid crimping at the tip. Refer to [Figure 9](#).
5. Push collar forward onto plug assembly. Fit cable braid over support sleeve of connector. See [Figure 10](#).
6. Push ferrule over braid until flange butts against connector body. Refer to [Figure 10](#). Using the correct crimp area of tool, crimp ferrule close to plug body. Crimp ferrule for a second time close to cable end.
7. Protuding center conductor should be trimmed with end of center contact.

FIVE CRIMP AREAS

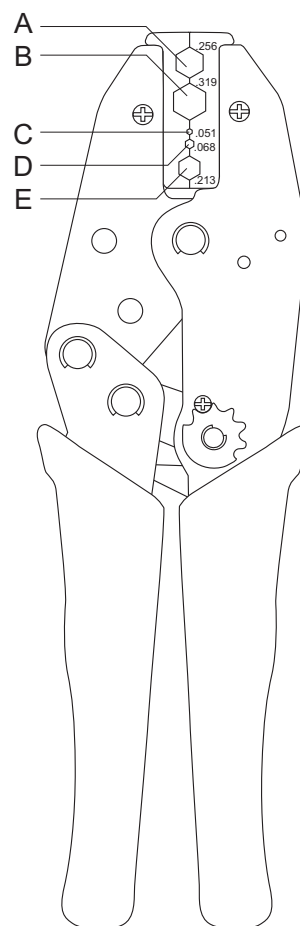

Figure 8. Motorola Crimping Tool 66-80388A26

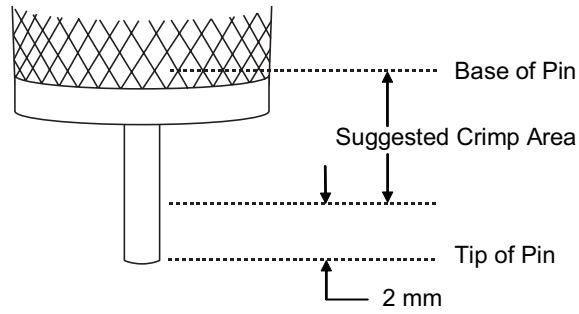
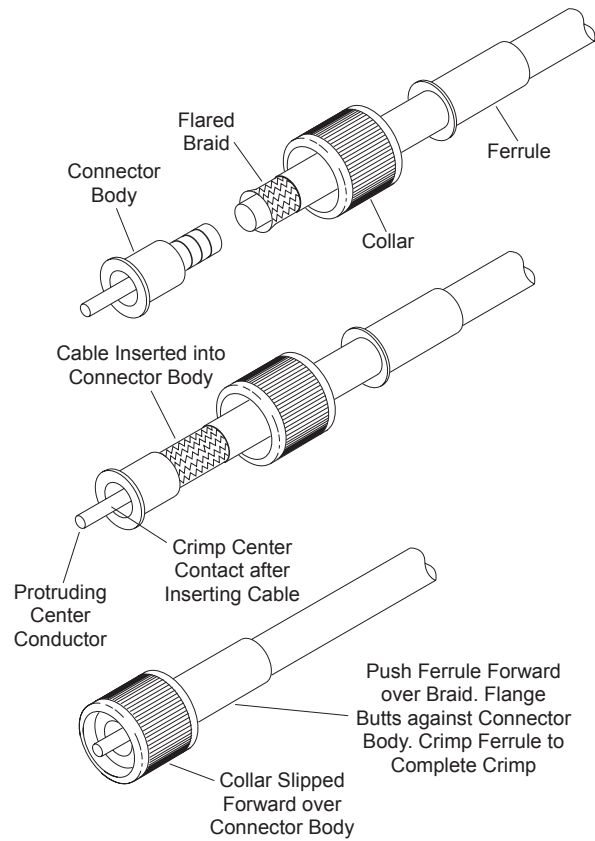
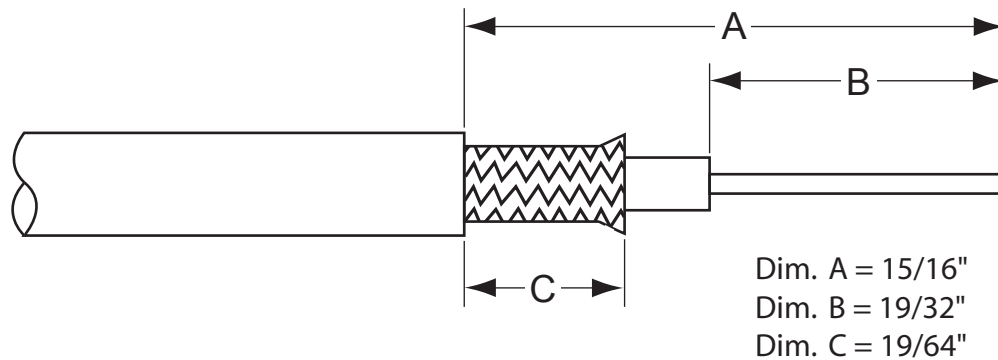

Figure 9. Coaxial Cable Stripping Dimensions



MAEPF-27622-0

Figure 10.



MAEPF-27623-O

Figure 11.

Table 2 Spectrum Antennas

Frequency MHz	Gain	Duty	Max Power Watts	Antenna Only	Roof Mount Kit	Trunk Lid Mount Kit	Magnet Mount Kit
30 – 36	0 dB	Standard	100	RAB-4002A	RAB-4002ARA	**	RAB-4002AMA
36 – 42	0 dB	Standard	100	RAB-4003A	RAB-4003ARA	**	RAB-4003AMA
42 – 50	0 dB	Standard	100	RAB4004A	RAB-4004ARA	**	RAB-4004AMA
30 – 36	0 dB	Heavy	100	RAB-4012A	RAB-4012ARA	**	RAB-4012AMA
36 – 42	0 dB	Heavy	100	RAB-4013A	RAB-4013ARA	**	RAB-4013AMA
42 – 50	0 dB	Heavy	100	RAB-4014A	RAB-4014ARA	**	RAB-4014AMA
66 – 88	0 dB	Standard	100	RAC-4000A	RAC-4000ATA	**	RAC-4000AMA
140 – 174	3 dB	Standard	150	RAD-4000A	RAD-4000ARA	RAD-400DATA	RAD-4000AMA
140 – 174	3 dB	Heavy	150	RAD-4010A	RAD-4010ARA	RAD-401DATA	RAD-4010AMA
406 – 420	5 dB	Standard	150	RAE-4002A	With RG58 A/U Cable RAE-4002ARA	With RG58 A/U Cable RAE-4002ATA	With RG58 A/U Cable RAE-4002AMA
445 – 470	5 dB	Standard	150	RAE-4004A	RAE-4004ARA	RAE-4004ATA	RAE-4004AMA
470 – 495	5 dB	Standard	150	RAE-4005A	RAE-4005ARA	RAE-4005ATA	RAE-4005AMA
495 – 512	5 dB	Standard	150	RAE-4006A	RAE-4006ARA	RAE-4006ATA	RAE-4006AMA
406 – 420	5 dB	Heavy	150	**	With Low Loss Cable RAE-4002ARL	With Low Loss Cable RAE-4002ATL	**
450 – 470	5 dB	Heavy	150	**	RAE-4004ARL	RAE-4004ATL	**
470 – 496	5 dB	Heavy	150	**	RAE-4005ARL	RAE-4005ATL	**
496 – 512	5 dB	Heavy	150	**	RAE-4006ARL	RAE-4006ATL	**
406 – 420	5 dB	Heavy	150	RAE-4012A	With RG58 A/U Cable RAE-4012ARA	With RG58 A/U Cable RAE-4012ATA	With RG58 A/U Cable RAE-4012AMA
450 – 470	5 dB	Heavy	150	RAE-4014A	RAE-4014ARA	RAE-4014ATA	RAE-4014AMA
470 – 496	5 dB	Heavy	150	RAE-4015A	RAE-4015ARA	RAE-2015ATA	RAE-4015AMA

Table 2 Spectrum Antennas (Continued)

Frequency MHz	Gain	Duty	Max Power Watts	Antenna Only	Roof Mount Kit	Trunk Lid Mount Kit	Magnet Mount Kit
496 – 512	5 dB	Heavy	150	RAE-4016A	RAE-4016ARA With Low Loss Cable	RAE-4016ATA With Low Loss Cable	RAE-4016AMA
406 – 420	5 dB	Heavy	150	**	RAE-4012ARL	RAE-4012ATL	**
450 – 470	5 dB	Heavy	150	**	RAE-4014ARL	RAE-4014ATL	**
470 – 496	5 dB	Heavy	150	**	RAE-4015-ARL	RAE-4015ATL	**
496 – 512	5 dB	Heavy	150	**	RAE-4016ARL	RAE-4016ATL	**

NOTE: All antenna mount kits include RG58A/U Cable and PL259 Connector, except cable option that is listed otherwise. ** For low and Mid Band Trunk lid mount kits, order antenna only and trunk lid mounting kit (01-80356A55) separately.

PART NUMBER	ANTENNA MOUNTS
01-80352A03	Roof Mount Kit, RG58A/U Cable, PL259 connector
01-80356A55	Trunk Lid Mount, RG58A/U cable, PL259 connector
01-80356A47	Magnet Mount RG58A/U cable, PL259 connector
01-80371A27	Magnet Mount RG58A/U Cable PL259 connector, low band only

Tuning the Antenna



Adjusting the whip length while radio is keyed may cause burns from RF radiation.

WARNING

NOTE: Tune antenna in an open area at least 12 feet away from any metal objects.

NOTE: Lengths shown on the cutting chart are approximate. Due to antenna variations and mounting location effects, we recommend cutting the antenna rod 1 1/2” longer than the chart and then cutting 1/2” off at a time until reflected power is minimized.

NOTE: DUE TO ANTENNA INTERACTION WITH VEHICLE, SOME LOW BAND ANTENNA MOUNTING LOCATIONS WILL NEVER ACHIEVE 1.5:1 VSWR. In this case, trim the whip for minimum reflected power. A simple table for converting the ratio of forward power and reflected power to VSWR is shown below in [Table 3](#).

1. Locate the transmitter frequency on the cutting chart. In the case of multiple transmitter frequencies, calculate the mid-frequency and locate on cutting chart. Read desired whip length from the chart. Cut the whip 1 1/2” longer than this length.

NOTE: Trim the antenna rod (Low and High band) from the bottom only. On the UHF antenna whip, trim the whip from the bottom of the rod below the phasing coil.

2. Use the set screw to secure the antenna whip in the whip adaptor assembly.
3. Using the in-line wattmeter, measure forward and reflected power at the desired transmit frequency and calculate VSWR using [Table 3](#).
4. If VSWR is >1.5:1, then trim off 1/2” and repeat Step 3.
5. Repeat steps 3 and 4 until minimum VSWR is obtained.

6. Use the adjustment range of the whip in the adaptor in order to minimize the VSWR.
7. Insert the shorter part of the allen wrench into the screw and tighten the set screw at tight as yo can by hand. If a torque wrench is available, tighten set screw to a torque of 25 – 30 inch-lbs.

A simple table for converting the ratio of forward power and reflected power to VSWR is given below:

Table 3

Pfwd/Pref	VSWR
440.6	1.1 : 1
58.8	1.3 : 1
25.0	1.5 : 1
14.9	1.7 : 1
10.4	1.9 : 1
7.9	2.1 : 1

Example: If the forward power (Pfwd) is measured as 100 watts and the reflected power (Pref) is 3 watts, calculate $P_{fwd}/P_{ref} = 33.3$. Since 33.3 is between 25 and 58.8 m, the chart above indicated that the VSWR is less than 1.5 : 1.

Spectrum™ by Motorola

Cutting chart lengths are approximate. Whip length will vary with type of vehicle, mount location and type of mount. Cut 1-1/2 inches longer than chart length, then trim for minimum reflected power.

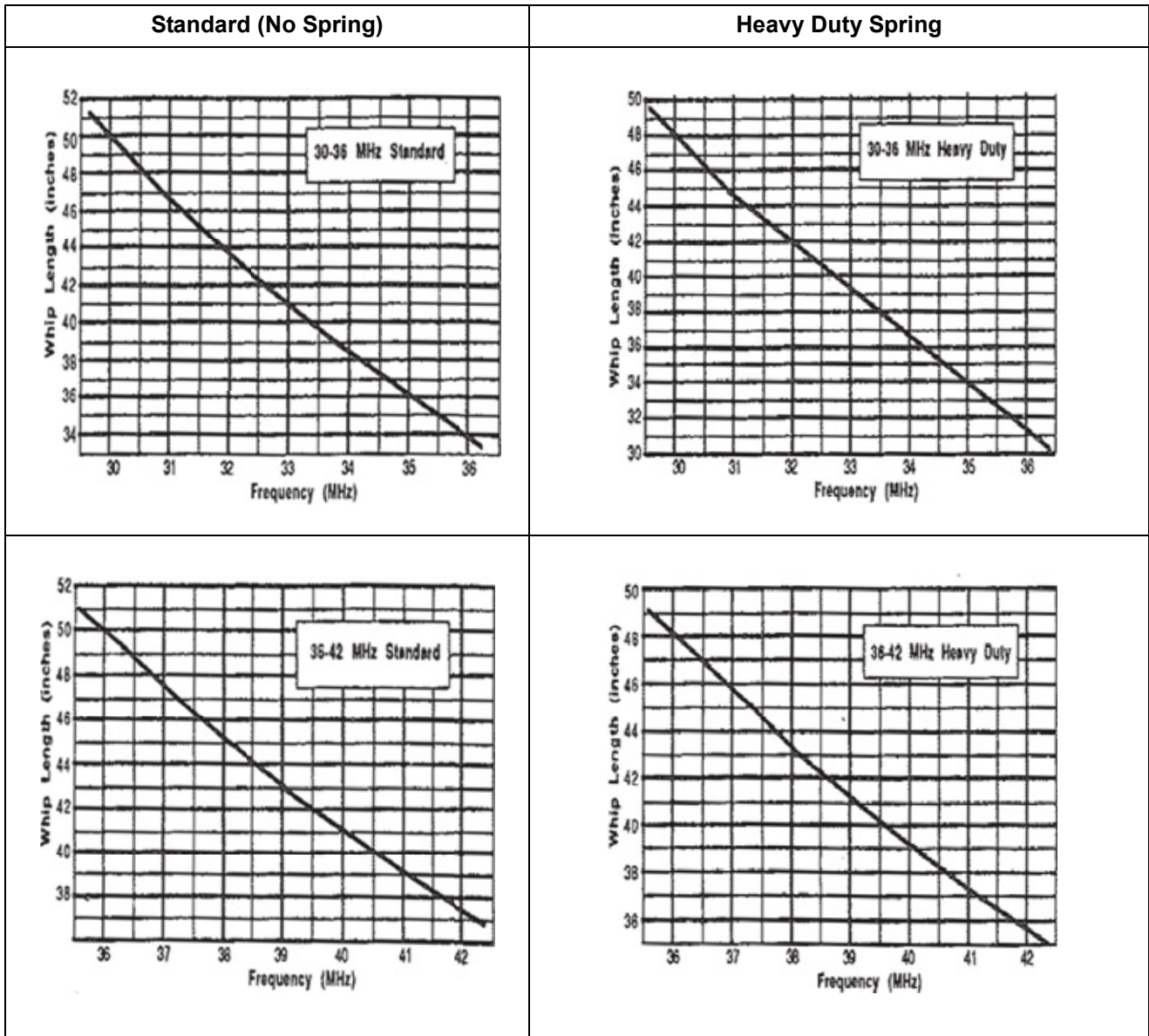

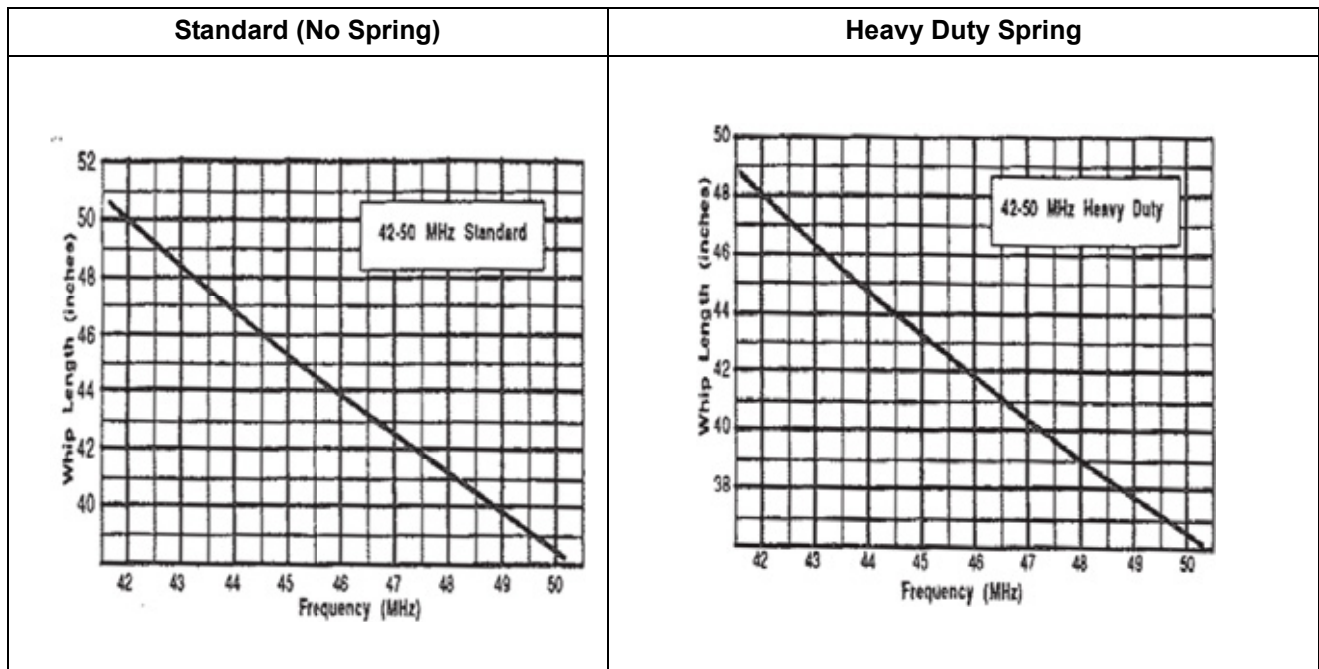

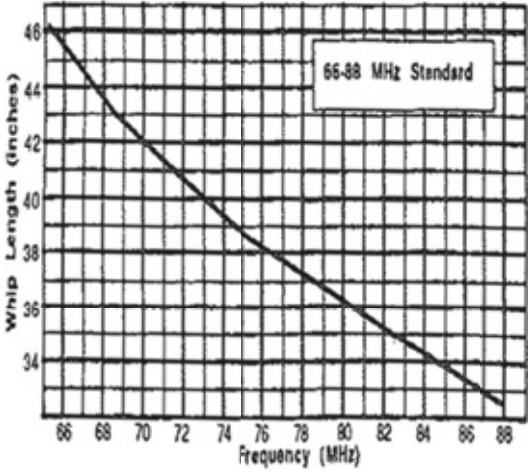
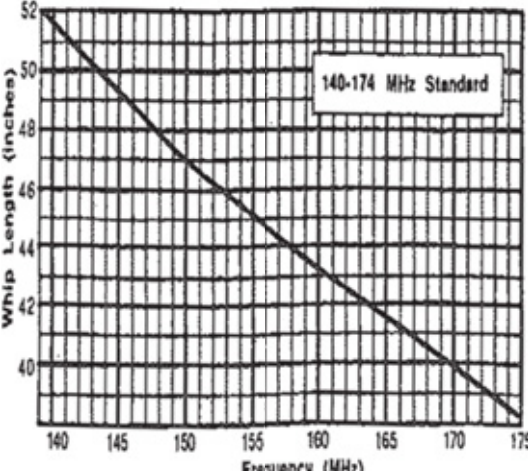
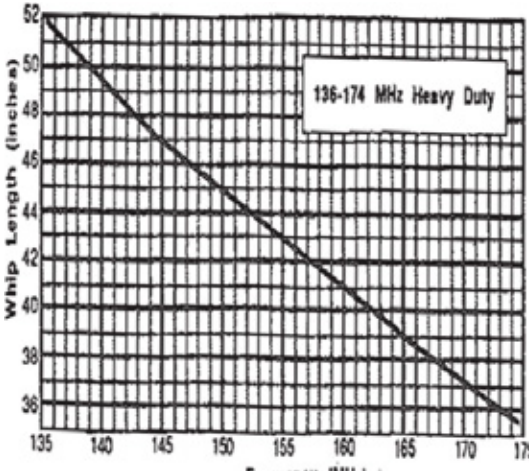
Standard (No Spring)	Heavy Duty Spring																																						
 <p data-bbox="479 401 662 470">66-88 MHz Standard</p> <table border="1" data-bbox="167 359 691 827"><caption>Approximate data for 66-88 MHz Standard</caption><thead><tr><th>Frequency (MHz)</th><th>Whip Length (inches)</th></tr></thead><tbody><tr><td>66</td><td>46</td></tr><tr><td>68</td><td>43</td></tr><tr><td>70</td><td>41</td></tr><tr><td>72</td><td>39</td></tr><tr><td>74</td><td>38</td></tr><tr><td>76</td><td>37</td></tr><tr><td>78</td><td>36</td></tr><tr><td>80</td><td>35</td></tr><tr><td>82</td><td>34</td></tr><tr><td>84</td><td>33</td></tr><tr><td>86</td><td>32</td></tr><tr><td>88</td><td>31</td></tr></tbody></table>	Frequency (MHz)	Whip Length (inches)	66	46	68	43	70	41	72	39	74	38	76	37	78	36	80	35	82	34	84	33	86	32	88	31													
Frequency (MHz)	Whip Length (inches)																																						
66	46																																						
68	43																																						
70	41																																						
72	39																																						
74	38																																						
76	37																																						
78	36																																						
80	35																																						
82	34																																						
84	33																																						
86	32																																						
88	31																																						
 <p data-bbox="479 1010 662 1079">140-174 MHz Standard</p> <table border="1" data-bbox="167 968 691 1436"><caption>Approximate data for 140-174 MHz Standard</caption><thead><tr><th>Frequency (MHz)</th><th>Whip Length (inches)</th></tr></thead><tbody><tr><td>140</td><td>52</td></tr><tr><td>145</td><td>49</td></tr><tr><td>150</td><td>46</td></tr><tr><td>155</td><td>43</td></tr><tr><td>160</td><td>40</td></tr><tr><td>165</td><td>37</td></tr><tr><td>170</td><td>34</td></tr><tr><td>175</td><td>31</td></tr></tbody></table>	Frequency (MHz)	Whip Length (inches)	140	52	145	49	150	46	155	43	160	40	165	37	170	34	175	31	 <p data-bbox="1128 1010 1312 1079">136-174 MHz Heavy Duty</p> <table border="1" data-bbox="824 968 1349 1436"><caption>Approximate data for 136-174 MHz Heavy Duty</caption><thead><tr><th>Frequency (MHz)</th><th>Whip Length (inches)</th></tr></thead><tbody><tr><td>135</td><td>52</td></tr><tr><td>140</td><td>49</td></tr><tr><td>145</td><td>46</td></tr><tr><td>150</td><td>43</td></tr><tr><td>155</td><td>40</td></tr><tr><td>160</td><td>37</td></tr><tr><td>165</td><td>34</td></tr><tr><td>170</td><td>31</td></tr><tr><td>175</td><td>28</td></tr></tbody></table>	Frequency (MHz)	Whip Length (inches)	135	52	140	49	145	46	150	43	155	40	160	37	165	34	170	31	175	28
Frequency (MHz)	Whip Length (inches)																																						
140	52																																						
145	49																																						
150	46																																						
155	43																																						
160	40																																						
165	37																																						
170	34																																						
175	31																																						
Frequency (MHz)	Whip Length (inches)																																						
135	52																																						
140	49																																						
145	46																																						
150	43																																						
155	40																																						
160	37																																						
165	34																																						
170	31																																						
175	28																																						

Spectrum™ by Motorola

Cutting chart lengths are approximate. Whip length will vary with type of vehicle, mount location and type of mount. Cut 1-1/2 inches longer than chart length, then trim for minimum reflected power.

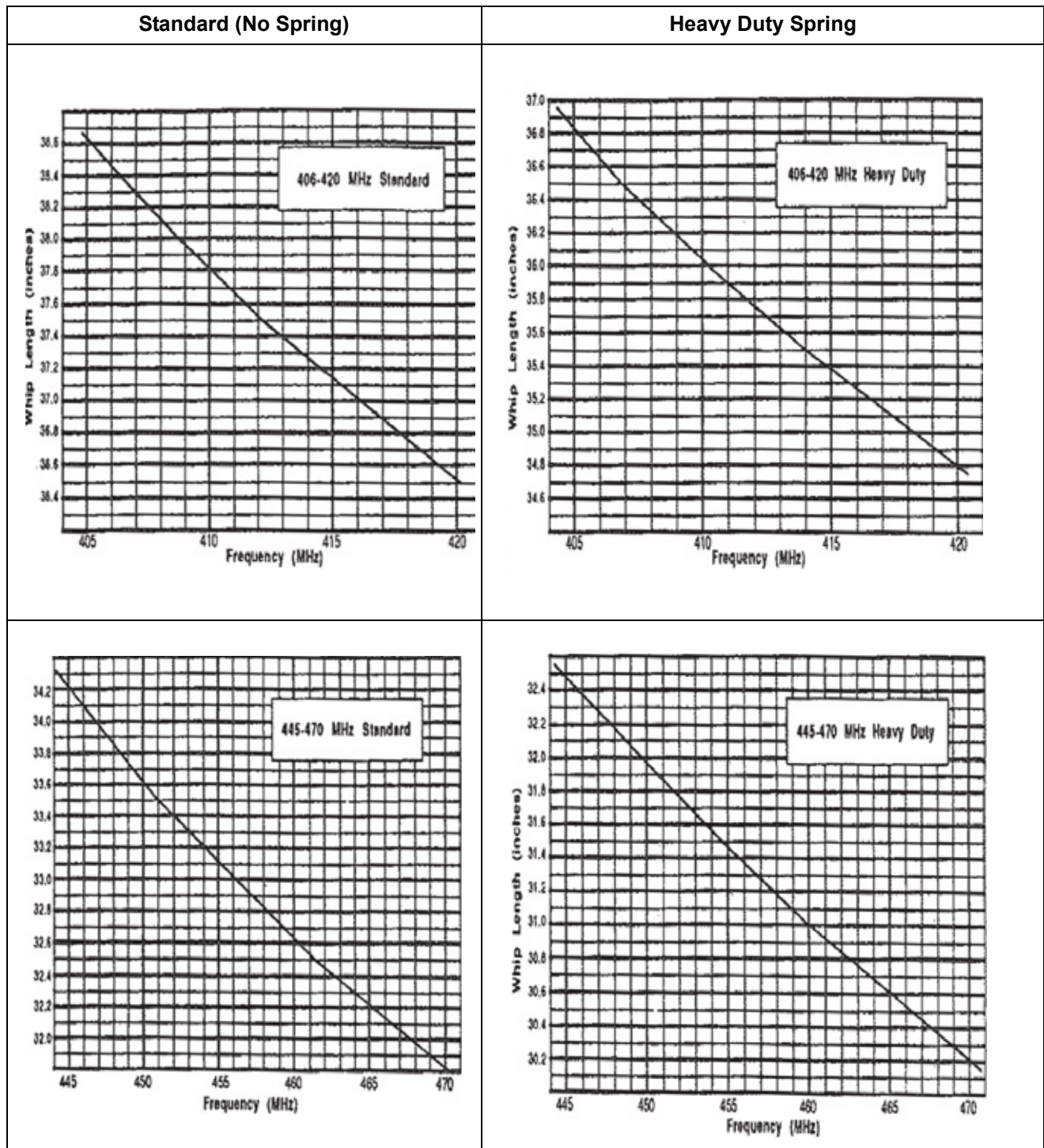

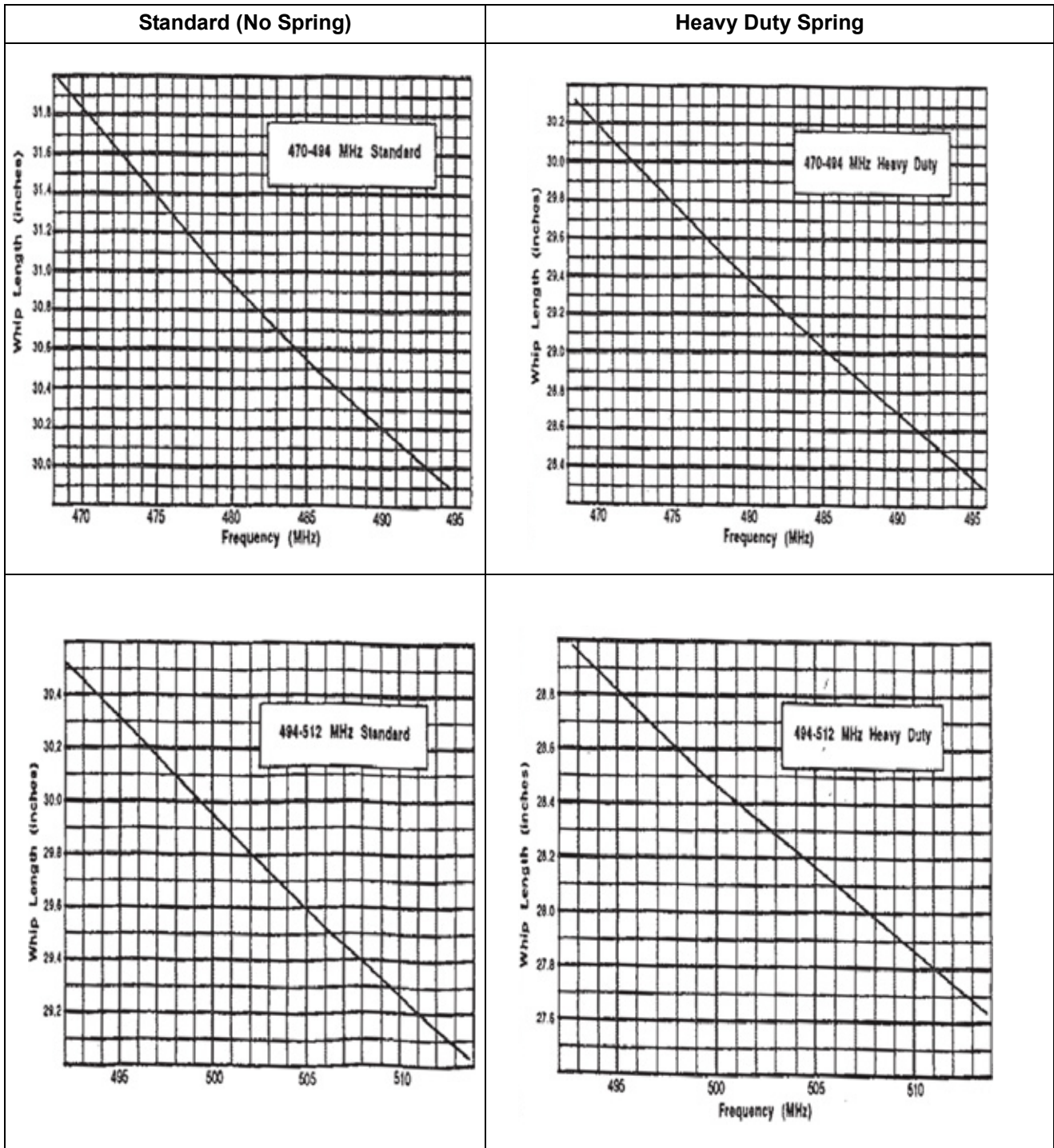



Motorola Inc.
1301 E. Algonquin Rd.,
Schaumburg, IL 60196-1078, U.S.A.

MOTOROLA, the Stylized M Logo, and ASTRO are registered in the U.S. Patent and Trademark Office. All other product or service names are the property of their respective owners.
© 2000 – 2010 by Motorola, Inc.
All rights reserved.



6880309C12-F