

Table of Contents

CHAPTER 1 PRODUCT OVERVIEW	1
1.1 Functions overview.....	1
1.2 Notes	1
1.3 Packaging list	2
1.4 Technical specifications.....	2
CHAPTER 2 BUTTONS AND APPEARANCE.....	4
CHAPTER 3 EASYCONFIG.....	6
CHAPTER 4 BASIC OPERATIONS.....	8
4.1 Booting up	8
4.2 Shutdown	8
4.3 Network	8
4.4 Standby Mode.....	8
4.5 Reset.....	9
4.6 Connecting to PC and file transfer	9
4.7 Volume adjustment	9
4.7.1 Adjusting the media volume.....	10
4.7.2 Adjusting the alarm volume	10
4.7.3 Adjusting the notification volume	10
4.8 Charging.....	10
4.9 Touch screen operations	10
4.10 Search icon	11
CHAPTER 5 COMMON FEATURES	12
5.1 Landscape/Portrait display switching	12
5.2 Using virtual keyboard to type.....	12
5.2.1 Android keyboard.....	12
5.2.2 Editing text	13
5.3 Notification bar	14
5.3.1 Opening notification bar	14

5.3.2 Closing notification panel.....	14
5.4 Recently run apps	14
5.5 Changing wallpaper	14
5.6 Power control	14
CHAPTER 6 MAIN INTERFACE	16
6.1 Main interface	16
6.2 Apps interface	16
6.3 Browser	17
6.3.1 Opening browser	17
6.3.2 Going to a webpage	18
6.3.3 Setting a home page	18
6.3.4 Browsing a webpage.....	18
6.3.5 Managing bookmarks.....	19
6.3.6 Other functions.....	20
6.4 Video player	20
6.4.1 Video playing	20
6.4.2 Delete video.....	22
6.5 Audio player.....	22
6.5.1 Playlist	22
6.5.2 Playing audio	23
6.5.3 Sound effects.....	24
6.6 Picture browser	25
6.6.1 Browsing pictures	25
6.6.2 Picture file operation.....	26
6.7 Camera	27
CHAPTER 7 APPS	28
7.1 Moving a program icon to another interface.....	28
7.2 Deleting a program icon.....	28
7.3 Adding a Widget.....	28
7.4 Creating a folder.....	28
7.5 Renaming a folder.....	28
CHAPTER 8 COMMON TOOLS	29

8.1 E-mail.....	29
8.1.1 Opening e-mail.....	30
8.1.2 Creating and sending e-mails	31
8.1.3 Receiving and reading e-mail.....	31
8.1.4 Replying / Forwarding e-mail	31
8.1.5 Managing e-mails	32
8.1.6 Email Settings	32
8.2 Recorder.....	33
8.3 Alarm	33
8.3.1 Set alarm.....	34
8.3.2 Delete alarm	34
8.4 Calculator.....	34
8.5 Explorer.....	35
8.6 Installing apps	35
8.7 Uninstall app.....	35
CHAPTER 9 SETTINGS	36
9.1 WIRELESS & NETWORK Settings	36
9.1.1 Wi-Fi network connection.....	36
9.1.2 Data usage.....	38
9.2 DEVICE Settings	38
9.2.1 Sound.....	38
9.2.2 Display.....	38
9.2.3 ScreenshotSetting.....	38
9.2.4 Storage	39
9.2.5 Battery	40
9.2.6 Apps.....	40
9.3 PERSONAL Settings	40
9.3.1 Location services	40
9.3.2 Security.....	40
9.3.3 Language & input	40
9.3.4 Backup & reset	41
9.4. Accounts & Sync	41
9.5 SYSTEM Settings	41
9.5.1 Data & Time.....	41
9.5.2 Accessibility.....	41

9.5.3 About device	42
CHAPTER 10 USING MICRO SD (TF) CARD	43
CHAPTER 11 CONNECTING TO USB DRIVE	44
CHAPTER 12 ABOUT THE BATTERY AND POWER	45
CHAPTER 13 FIRMWARE UPDATING / RESETTING TO FACTORY	46
CHAPTER 14 FREQUENTLY ASKED QUESTIONS	47
CHAPTER 15 TROUBLESHOOTING	49

Chapter 1 Product Overview

1.1 Functions overview

- 7 inch wide screen True Color TFT touch screen with a high resolution of 800*480 pixels.
- Surf the Internet wirelessly via Wi-Fi to enjoy the Internet on the go.
- Support all mainstream e-mail services for more convenient e-mail sending and receiving.
- Switching between portrait mode and landscape mode is possible through gravity sensing. Four-direction rotation display is supported.
- Shooting images or videos via 300 thousand pixels front camera.
- Support Video Player, Audio Player, Photo Browser, Camera and Shelves.
- Equipped with a built-in microphone, enabling audio-recording.
- Eco settings enable the brightness to be freely adjusted.

1.2 Notes

- Do not use the unit in an overly hot, cold, wet, or dusty environment. Do not expose it to sunlight.
- Try not to use this unit in an environment with a strong magnetic field or static electricity.
- Avoid dropping this unit or subjecting to strong impacts.
- The adapter of this product should not be dropped nor splashed with liquid. Any object filled with liquid, such as a vase, should not be placed on the top of it.
- There are no user-serviceable parts inside the product. Do not dismantle this unit. Otherwise, the warranty may be voided. Contact servicing personnel if you need assistance.
- The battery life may vary depending on the use conditions and product age.
- Replacing the battery in this product by user is not recommended. Do not dismantle the unit yourself. Explosion may occur if the battery is not properly handled or replaced. Suggest you contact professional servicing personnel for such service. Also recommend to only use the same brand of battery or equivalent for replacement.
- The long life of a lithium battery is due to its much smaller memory effects than that of the regular Nickel-Cadmium batteries. However, if the lithium battery is degrading, contact the local Service Center.
- The company is not liable for the data loss or deletion on machine resulting from the misuse of software, improper operation of the battery, servicing, other accidents, or other indirect loss

thereof.

- The actual product may be different from that described in the Instructions due to the software updates. These Instructions are for informational purposes only.
- This being a highly mobile product, we recommend you back-up your data regularly.

1.3 Packaging list

AOC Breeze Tablet Unit	X 1
Micro USB cable	X1
Micro USB Adapter	X1
Micro USB Power Adapter	X 1
Quick Setup Guide	X1
Warranty Statement	X1



Note: The actual accessories provided with the product may vary.

1.4 Technical specifications

Basic specifications

Model no.	AOC Tablet MW0731
Installed OS	Android OS 4.x
Processor (CPU)	1.4G ARM Cortex A9 Duo-core & Quad-core GPU
Memory	1GB. DDR3
WLAN	Wi-Fi IEEE 802.11b/g/n
Camera	Front 0.3MP
Storage capacity	Built-in 8GB Flash Memory
Expansion cards	Micro SD (TF) card, up to 32 GB.
LCD	7 inch TFT LCD capacitive touch screen with a resolution of 800*480 pixels
Audio output	Headset: Stereo output; internal speakers: Mixed output.

Power specifications

Voltage	Supply voltage: 5V  Charging voltage: 5V 
Current	Max. current for playback is 1A DC. Max. current for charging is 1.2A DC.
Battery used	Built-in lithium-ion polymer rechargeable battery, 3.7V, 3100mAh

Power adapter	AC input: 100-240V 50/60Hz DC input: 5V 1.5A
Charging time	It takes about 3.5 hours for the battery to be fully charged when the provided charger is used while powered-down. The charging time may vary depending on the remaining battery level. Note: Do not charge the battery for more than 12 hours continuously.
Battery use time (Under the condition that the battery is fully charged in a normal temperature)	Audio: About 12 hours Video: About 5 hours Web browsing: About 4 hours

External dimensions

Dimension (L×W×H)	7.56 ×4.76 × 0.39inch (19.2 ×12.1 ×0.99cm)
Weight	0.73 lbs (0.330kgs) (with battery)
Ports	Micro USB 2.0 high speed port, OTG, 3.5mm headset

Environmental conditions

Operating temperature	0°C ~ 40°C
Storage temperature	-20°C ~ 55°C
Max. humidity	90% RH (non-condensation)
Supported OS	Windows2000/XP/Windows 7/Vista, Macintosh OS X

Note: Windows 2000+SP1/SP2 is not supported by this product. The user should upgrade to SP3 or above. This product does not guarantee all video formats are playable. Even if some formats are listed in the instructions, they may be not play properly, due to some video particularities..

Chapter 2 Buttons and Appearance

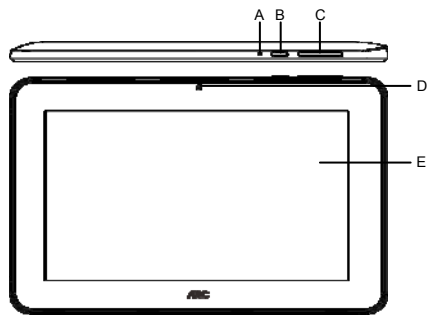

A. Charge indicator	B. Power button
C. Volume +/- buttons	D. Front camera
E. Touch screen	



F. Headphone jack	H. Build-in Microphone
G. Micro USB port (Power cable jack/connecting to PC/ connecting to USB drive)	
I. Micro SD (TF) card slot	J. Audio speaker

Note 1: During operation, sounds will be automatically output from the Audio speaker if there is audio output.

Note 2: In the Instructions, "Press" means pressing a button while "Press and Hold" means continuously pressing a button for 2 ~ 3 seconds.

Chapter 3 EasyConfig

When first using the tablet breeze, the EasyConfig window will pop up. It includes Language, Date/Time and Wi-Fi settings.

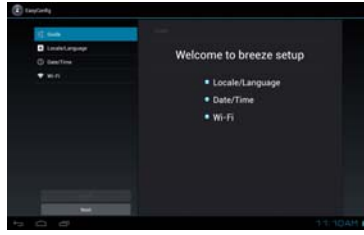

Touch "Next" to setup language, and then choose a language you want.

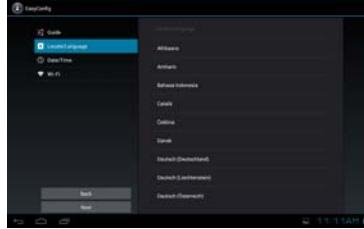

Touch "Next" to setup date, time zone and time.

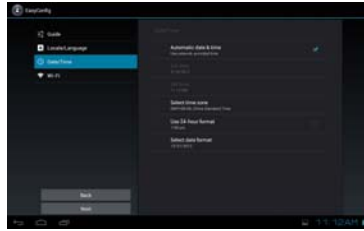

Tap "Next" to go to the Wi-Fi settings interface.



Touch the menu icon () and "Scan" icon to search for the available wireless networks in the vicinity.

Touch the desired wireless network name to connect to it. You will be prompted, if a password is required.

1. If static IP address needs to be entered. Then click on "show advanced options" to show "IP settings". Touch the pop-up menu and select "static". Then enter the IP address, gateway, network mask, and DNS information required for such Wi-Fi network connections.



2. If you use dynamic IP address keep the default "DHCP" in the "IP settings" option.

Note: The word "Connected" displayed under the network name indicates a successful connection.

Afterwards touch "End" to exit and then you can surf the Internet, connect to email services, etc.

Chapter 4 Basic Operations

4.1 Booting up

Press and hold the Power button for a few seconds. After the boot screen is shown (for about 30 seconds), the unlock interface is shown. Touch and hold the unlock icon at the middle right of the screen and drag it rightward to the "open lock" icon to unlock it. Once unlocked, the main interface will be shown.

Note: Touch and hold the unlock icon at the middle right of the screen and drag it leftward to the Camera icon to enter directly into camera mode.

4.2 Shutdown

In any mode, Press and hold the Power button for about 2 seconds. The device shutdown window will appear:

- a. Power off: Touch to turn off the product.
- b. Airplane mode: Touch to turn on or turn off Airplane mode.
- c. Silent mode: Touch to turn on or turn off sound.

Note 1: If the battery is low, the product will shutdown automatically.

Note 2: If the product freezes during operation, press and hold the Power button for 8 seconds to force shutdown.

4.3 Network

To surf the Internet wirelessly, make sure the Wi-Fi wireless network signals are present and set the Wi-Fi network connection. There are two ways of going to the "Wireless & Networks" settings interface:

- a. Touch the notification icon at the bottom right corner of the main interface, touch the popup window and touch "Wi-Fi".
- b. In the "Apps" interface, touch "settings" icon to go to the settings interface, and then touch "Wi-Fi".

Note: For detailed settings, refer to "9.1 Wireless & Network Settings".

4.4 Standby Mode

Standby: During use, you can press the power button to enter into standby mode to save battery power and lock the key and screen.

Wake up: When the device is in standby mode, press the Power button. After the screen lights

up, touch and slide the "Lock" icon to the right towards to the "unlocked" icon.

4.5 Reset

If the product crashes during operation, you can press and hold the Power button for 8 seconds to force shutdown.

4.6 Connecting to PC and file transfer

Connecting to PC:

1. While the product is on, plug the smaller end of the provided USB cable to the Micro USB port on the side of it, and the larger end of it to a USB port on PC.
2. If the "Media device (MTP)" option is selected, (in Storage Settings / menu / USB computer connection), the device is connected as a media device and you can transfer any files on Windows PC, or using "Android File Transfer" on a Macintosh PC.
3. If the "Camera (PTP)" option is selected, device connected as a camera" and you can transfer only photos.
4. If the "Mass Storage" option is selected, (in Storage Settings / menu / USB computer connection), the USB connected interface will pop up on the tablet with the option to "Turn on USB storage". Tap the button "Turn on USB storage" to connect. When the message changes to "Turn off USB storage", the connection has successfully been established.

The tablet (and SD card if installed) will be mounted on your computer as mass storage devices. You may access their data directly on your PC.

Disconnecting from PC:

Touch the "Safely Remove Hardware" icon at the bottom right corner of the Windows PC screen to remove the device safely on PC. On a Macintosh, just "eject drives" from desktop.

Then tap "Turn off USB storage" button on the tablet to disconnect tablet from computer.

Note: File transfer requires: Windows XP system need Windows Media Player 11 or greater than 11 supported, while Mac system may need to install MTP software packages. (* "Android File Transfer" for Mac OS X is available at www.android.com/filetransfer.)

4.7 Volume adjustment

Media volume: Adjust the volume for playing music and video.

Alarm: Adjust the volume of alarm.

Notification volume: Adjust the volume of notification ringtones.

4.7.1 Adjusting the media volume

There are two ways of going to the "Media Volume" adjustment interface:

- In any interface, press or press and hold the Volume +/- button on the top of the product to adjust the media volume.
- In the apps interface, touch "Settings -> Sound -> Volume", touch the media volume bar to adjust the volume after the Volume window appears.

4.7.2 Adjusting the alarm volume

In the apps interface, touch "Settings -> Sound -> Volume". Touch the alarm volume bar to adjust the volume after the Volume window appears.

4.7.3 Adjusting the notification volume

In the apps interface, touch "Settings -> Sound -> Volume". Touch the notification volume bar to adjust the volume after the Volume window appears.

4.8 Charging

When the battery is low, the provided adapter can be used to charge it.

1. If the product is powered on during charging, the status bar will show the charging icon ().

After the battery is fully charged, the bar will show the full battery icon ().

2. If the product is shutdown during charging, the large charging icon interface will be displayed. After the battery is fully charged, the full battery icon () will be shown; in the large charging icon interface, press the Power button according to the prompts to turn on.

Note 1: Check the detailed charging percentage through "Settings -> About Tablet -> Status -> Battery Level".

Note 2: To extend battery life, avoid charging the battery frequently when it is in high level.

(Example: more than 90%) It is not recommended to charge the product at this time; if charging is performed at this time, the percentage shown may not be 100%. This is normal.

Note 3: Once a "Low battery" message is displayed, the tablet should be charged as soon as possible.

4.9 Touch screen operations

Tip: The display used in this product is a capacitive multi touch screen. When using, you can

operate it by using the buttons on its body or touching the corresponding icons on the display with finger to enable the corresponding functions.

Touch

Touch the screen icons to select. When you want to use the on-screen keyboard to type, or press an on-screen icons, just touch them using your finger.

Touch and hold

Touch the screen icons continuously until the option expands.

Slide

Place and slide your finger on the screen. Slide your finger up or down to scroll up or down; or if the list has a scroll bar, slide your finger up or down in the list to page down or up; when you are browsing pictures, slide your finger to the left or to the right to view the previous or next picture.

MultiTouch

While surfing the Internet or browsing pictures.

Zoom in: Touch the screen with two fingers, and slide two fingers together.

Zoom out: Touch the screen with two fingers, and slide two fingers together apart.

4.10 Search icon

In the main interface, touch the "Search" icon to search for the relevant information using the browser.

Chapter 5 Common Features

5.1 Landscape/Portrait display switching

1. In the "Settings" interface, touch "Accessibility ->Auto-rotate screen." When the "√" symbol appeared, the Landscape/Portrait screen display switching is on; when the "√" symbol disappeared, the Landscape/Portrait screen display switching is off.
2. Hold this product vertically with your hands and tilt it to the left or right. When it is tilted to a position 90° to the horizontal plane, the gravity sensor built in the product senses the action and the screen switches to Portrait mode from Landscape mode.
On the contrary, when it is tilted to a position 0° to the horizontal plane, the screen switches to Landscape mode from Portrait mode.



Tip: This product supports 4-direction rotation display.

Note: For gravity sensing (display orientation), the screen orientation will not change if this product is placed on the level and stationary surface, regardless of how you rotate the product.

5.2 Using virtual keyboard to type

Touch any text input box to pop up the virtual keyboard as shown below. Use this keyboard to type any text or characters.

5.2.1 Android keyboard



A. Show box: Show the text typed. Touch and hold this box to display the Edit Text menu for you to cut, copy, and paste the text.
B. Shift: Touch this key to switch between uppercase and lowercase text.
C. Touch this key to switch between numeric keypad and symbol keyboard; For numeric keypad and symbol keyboard, touch the “~ ” key to display the special symbols (such as ~, ±, +, ×, etc.).
D. Touch this key to hide the Android keyboard.
E. Touch to delete the edited text.
F. Touch to ensure input and go to next step.
G. Touch this key to use voice recognition to input text.
H. Touch this key to input space.

Tip: During the input process, you can move the cursor by touching a position.

5.2.2 Editing text

The typed text can be edited.

When there is text in the input field, touch and hold the input field (or touch and hold the show box in the keyboard) to open the Edit Text menu. Touch the options in the menu to edit the text.

Select all	Select all text typed
Cut	Cut text typed
Copy	Copy text typed
Paste	Paste cut or copied text
Share	Share the selected text via Gmail or Email.

5.3 Notification bar

The notification icon appears when a message is received, PC is connected, or music is played.

You can open the notification bar to check for messages and played music.

5.3.1 Opening notification bar

After a new notification icon appears in the notification bar, touch the notification bar to open the notification bar.

5.3.2 Closing notification panel

Touch any space except for notification bar to close it.

5.4 Recently run apps

Touch the recent apps icon in the main interface to go to show the background apps. Touch the icon in the window to open the corresponding app.



Touch the app in the window and slide your finger towards right to close the corresponding app.

5.5 Changing wallpaper

In the main interface, touch and hold a blank space, choose the desire wallpaper from "Live Wallpapers", "Gallery" or "Wallpapers".

5.6 Power control

In the apps interface, slide your finger toward left to go to the Widgets interface, then continue sliding to the next widgets interface, find "Power control" widgets. Touch and hold the widgets icon to move it to main interface, as the picture show below:

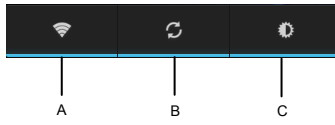

A. Wireless network on/off	Touch to turn on or off the wireless network.
B. Sync icon	Touch to set whether the wireless network can be used together with other programs.
C. Brightness adjustment icon	Touch to adjust the screen brightness.

Chapter 6 Main Interface

Make sure the Wi-Fi wireless network connection is established to use the following functions.

6.1 Main interface

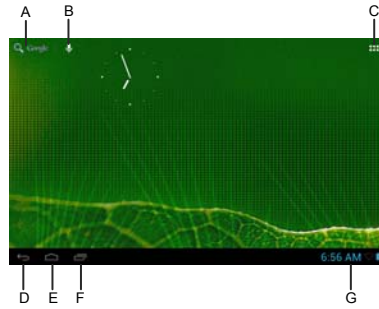

After booting and unlocking, you can go to the main interface (as shown below).

A. Quick search box	Touch to begin search.
B. Voice Search	Touch for voice search.
C. Apps icon	Touch to go to APPS and Widgets Interface.
D. Back icon	Touch to go back one screen.
E. Home icon	Touch to return to the home screen at any time.
F. Go to recent apps	Touch to show thumbnails of your recent Apps. Touch a thumbnail to select it or flick a thumbnail left or right to remove from list. Slide up to scroll through list.
G. Notification bar	Touch for details on status, time, settings, etc.

6.2 Apps interface

Touch the Apps & Widgets icon at the right of the main interface to go to the Apps interface, as shown below:



6.3 Browser

Open the browser to enjoy a colorful experience. You can also access news, weather forecast, and sports or traffic information when needed.

6.3.1 Opening browser

In the "Apps" interface, touch "Browser" to open a webpage.



A. Back icon	Touch to go to previous webpage.
B. Next icon	Touch to go to next webpage.
C. Refresh icon	Touch to refresh the current webpage.
D. Close icon	Touch to close the current tab.
E. Add icon	Touch to open a new tab.
F. Add bookmark / Delete icon	Touch "☆" to add the current webpage to bookmark. /Touch "x" to delete the text in the table.

G. Search icon	Touch to input to search Internet.
H. Menu icon	Touch to show menu options.
I. Bookmark icon	Touch to go to bookmark interface.

Tip: When you touch a webpage link in an e-mail or message, the browser will be opened automatically.

6.3.2 Going to a webpage

1. Type a URL using the keyboard.
2. Touch the "Go" icon at the right of the virtual keyboard to open a webpage.

6.3.3 Setting a home page

1. Touch the Bookmark icon and touch "Setting->General->Set home page".
2. Touch "Current page", "Blank page", "Default page", "Most visited sites" or enter the URL of the webpage as home page.

Touch the back icon to return to the previous page. Touch the "+" icon, to open a new tab and you can go to the newly set home page.

6.3.4 Browsing a webpage

A browser provides many functions, allowing you to browse a webpage as you do on a PC.

You can simultaneously open several pages and touch one of them to browse.

You can slide your finger around the screen to browse other areas of webpage.

You can also zoom in or out of a webpage by sliding two fingers together or apart for easier browsing.

Open new browser tab

You can open several browser tabs, allowing you to browse between several websites easily. Up to 16 browser tabs can be opened.

To open a new tab, touch the menu icon, and touch "New tab" to open a new browser tab and go to the preset home page.

Switching between browser tabs

Touch the tab title to view the corresponding tab.

Selecting link in webpage

The selected link will be put in a blue box.

- Touch it to open a webpage.
- Touch and hold to open the Actions menu, Open, Save link, Copy link URL and Select text.

Selecting text in webpage

Touch and hold the text in webpage, the selected slider and menu option will display, slide the left and right slider to select the text for easier copying or sharing.

Saving webpage

You can save webpage for offline reading. In browser interface, touch menu icon and touch "Save for offline reading".

Finding text on a webpage

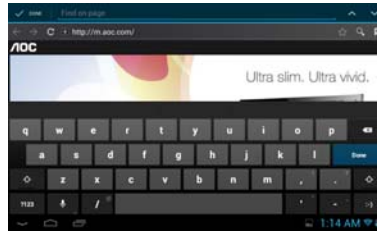

1. When browsing a webpage, touch the menu icon and touch "Find on Page".
2. Type the item to be found. After the content is typed, the shade of the text of the matches is highlighted in blue. Touch "▲" or "▼" to skip forward or backward one match. Touch "Done" to finish finding.

6.3.5 Managing bookmarks

Bookmarks can be stored while browsing a webpage. In the browser interface, touch "Bookmarks" icon to go to the bookmarks management interface where there are three tabs: BOOKMARKS, HISTORY and SAVED PAGES.

BOOKMARKS: Bookmarks management interface.

HISTORY: History webpage interface.

SAVED PAGES: Show the list of saving webpage.

Adding bookmark

Touch "☆" to add the current webpage to bookmark.

Opening bookmark

In the "Bookmark" interface, perform any of the following steps to open a bookmark:

- Touch the bookmark you want to open.
- Touch and hold the bookmark you want to open, and touch "Open" or "Open in new window".

Editing bookmark

1. In the bookmark interface, touch and hold the bookmark you want to edit.
2. Touch "Edit Bookmark" in the options to show the Edit Bookmark window.
4. Enter your desired changes and touch "OK" to finish editing.

Using bookmark

Touch and hold a bookmark in the bookmark list to pop up the Actions option: Open, Open in New Window, Edit bookmark, Add Shortcut to Home, Share Link, Copy Link URL, Delete bookmark, and set as homepage.

6.3.6 Other functions

In the browser interface, touch the "Menu" icon to perform more operations:

Refresh, Forward, New tab, New incognito tab, Share page, Find on Page, Request desktop site, Save for offline reading, Page info and Settings.

6.4 Video player

In the "Apps" interface, touch "Video" to go to the video file list.



6.4.1 Video playing

In the file list, slide your finger up and down to find the videos you want to play. Touch one to play.

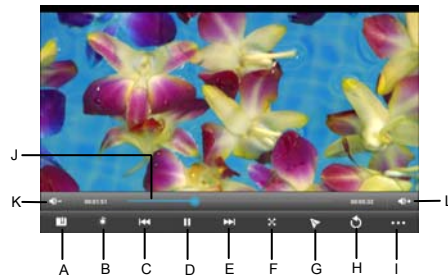

Touch the screen to show the Hide menu:

A. Add video bookmark		B. Adjust screen brightness
C. Touch: Previous video file. Touch and hold: Rewind.		D. Play/pause
E. Touch: Next video file Touch and hold: Fast forward.		F. Screen extension: Touch to select Full Screen, Normal,16:9, 4:3.
G. Touch: display the video in floating mode. Touch and hold the floating window and drag it towards right to close the floating window.		
H. Return to the video list		K/L. Decrease/increase volume
I. More	Delete Bookmark And Play from beginning	Touch this option to delete the video bookmarks and play from the beginning of the title.
	Delete bookmark	Delete the video bookmarks and continue playing.
	Play mode	Select Repeat mode.
	Subtitle Select	Select one subtitle while there is more than one kind of subtitle in the video.
	Audio Track Select	Select one audio track while there is more than one kind of audio track in the video.
	Help	Tips icon function.
	Return	Return to the Play interface.

J. Play progress bar	Touch any position of the play progress bar to skip to this position; Touch and hold it to move to any position to continue playing.
----------------------	---

Note 1: It takes a longer time to start playing a larger formatted video file. Convert video files that exceed the max. Resolution supported by the unit.

Note 2: For some supported video sources, a few video files that are partly damaged may not be played by the unit. Convert them on the PC and play the converted files on unit.

Note 3: This product can not guarantee that all video files are supported. While some are recognizable in the system and played, not all features may be supported; , such as fast forward and rewind, may not be used by individual video files.

6.4.2 Delete video

In the video file list, touch and hold the video you want to delete, then touch "OK" in reply to "Sure to delete this video".

6.5 Audio player

In the "Apps" interface, touch "Music" to go to the audio file list.



Artists	Sort by "Artist"
Albums	Sort by "Album"
Songs	Display the all music stored on built-in Flash memory, SD card and USB device
Playlists	Display the play list
Now playing	Go to the currently played music file

6.5.1 Playlist

In the music file list, touch "playlists" to go to the playlist.

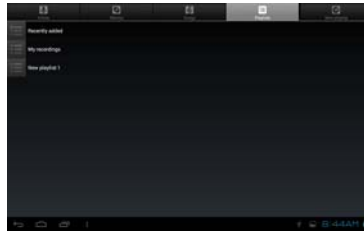

Touch and hold "Recently added" to play or edit the time of the "Recently added" list.
 In the music file list, touch and hold a song or a folder, then touch "Add to playlist" to add the song to a new playlist or other playlist.
 Tip: You cannot delete the "Recently added" list.

6.5.2 Playing audio

Touch the music you want to played and go to the music playing interface.

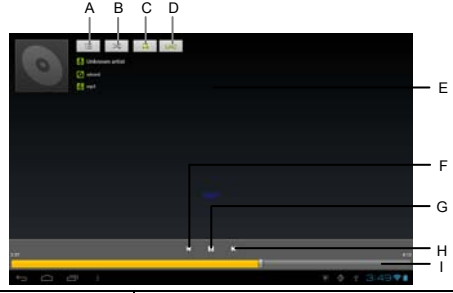

A. Play list	Touch to open the playlist.
B. Shuffle	Playing songs at random mode.
C. Play mode	1) Stop after the end song is played.
	2) Repeat playing all songs in the current directory.
	3) Repeat the current song.

D. LRC	Touch to show or hide lyrics.
E. File info	When the network connection is established, touch and hold it to check the link information about the currently played music file.
F. Rewind/previous	Touch: Switch to the previous song. Touch and hold: Rewind.
G. Play/pause	Play/pause music.
H. Fast forward/next	Touch: Switch to the next song. Touch and hold: Fast forward.
I. Play progress bar	Touch any position of the play progress bar to skip to this position; Touch and hold it to move to any position to continue playing.

Note: Keep the lrc file name consistent with the audio file name, copy them to a same folder in tablet.

6.5.3 Sound effects

In the music playing interface, touch the menu icon and touch "Sound effects" to go to sound effects settings interface.

Slide the slider switch at the top right corner to turn on and off sound effects.

To select pre-set music type equalizer settings, touch the drop-down menu that show the current "type" selected. Select your preferred sound effects by choosing a type of music type from the menu or by sliding your finger up and down on the sound effect frequency bars.



Note: Few MP3/WMA audio files that are specifically encoded may not be played by the product. Convert them using an audio conversion tool and download the converted files to the product to play.

6.6 Picture browser

In the "Apps" interface, touch "Gallery" to go to the picture list.



Tip: The system will automatically search for all pictures on Flash memory, SD card and USB device and display them as folders.

6.6.1 Browsing pictures

In the directory, touch the pictures you want to browse to open the picture browsing interface.

Touch the screen to pop up or hide the menu:

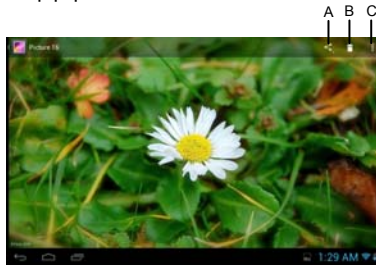

A. Share icon	Share the current picture through Picasa, Gmail or Email.
B. Trash can	Delete the current picture.
C. Menu	Touch to show the menu options.

Touch the menu icon to show the menu options



Slideshow	Automatically browse pictures.
Edit	Touch to edit the current picture.
Rotate left	Rotate the picture 90° counter-clockwise. Touch this icon to rotate the picture counter-clockwise in the following order: 90°, 180°, 270° and restore.
Rotate right	Rotate the picture 90° clockwise. Touch this icon to rotate the picture clockwise in the following order: 90°, 180°, 270° and restore.
Crop	Crop current picture.
Set picture as	Set the picture as Wallpaper background or Contact photo.
Details	Show the name of the picture file, its resolution, etc.

Tip1: When browsing pictures, you can slide your finger to the left or right rapidly to switch to the previous or next picture.

Tip2: When browsing pictures, you can zoom in or zoom out the picture by sliding two fingers together or apart.

6.6.2 Picture file operation

In the picture list, touch and hold a picture or a folder to pop up the Multi-choice operation list.



A. Done	Finish the operation.
B. X items selected	Show the number of the selected picture. Touch a picture to be selected or unselected
C. Share	Share the pictures through Picasa, Gmail or Email.
D. Delete	Delete the selected pictures.
E. Menu	Touch to show the menu options.

6.7 Camera

Touch the camera icon to go to the camera interface.

Touch icon for camera mode, touch icon for video record mode.

Slide along the arc icon to zoom in or out.

Touch icon to take photo or start recording video. Touch to end recording video.

Touch the screen to take photos while recording the video.

Take photos

Image Size	File Size
QVGA	(320 X 240)
VGA	(640 X 480)

Recording Videos

Mode	File Size
Default	640 X 480

Note: You can view and edit the photographs and recording videos on you computer in path: AOC TABLET: \\Internal Storage\\DCIM\\Camera\\.

Chapter 7 Apps

In the main interface, click "Apps" icon to go to the "Apps" interface in which the installed apps will be shown.



7.1 Moving a program icon to another interface

To create a program alias icon and move it to other interfaces, touch and hold the program icon and the screen will switch to last interface viewed. Then place the icon at a desired position and release.

7.2 Deleting a program icon

In the main interface, touch and hold the program icon you want to remove. When the "X Remove" appears at top of the screen, drag program icon to "X Remove" to delete it.

7.3 Adding a Widget

In the "Widgets" interface, touch and hold a widget you want to add and the screen will switch to the last interface viewed. Then place the widgets at the desired position and release.

7.4 Creating a folder

Create a folder in the interface to store the app icons or controls. To make a new folder on your Home screen, stack one app icon on top of another. Then to add more program icons to a folder, touch and hold a program icon on the screen and drag it to the folder.

Tip: To delete a folder, refer to the steps described in "Deleting a program icon".

7.5 Renaming a folder

Touch the folder and the name of the folder will display. Touch the name to rename the folder.

Chapter 8 Common Tools

8.1 E-mail

When you use the e-mail for the first time, you need to create an e-mail account first.

1. Enter the address and password for your e-mail account and Touch "Next".

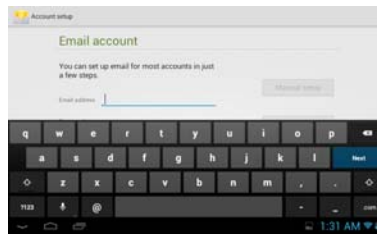

2. Select an account type. Touch "POP3" for a POP3 account.



3. Touch "POP3 Server" and "Port", enter "pop.+ account suffix" and port number. For example, if the e-mail account is 123456@163.com and the port number is 110, enter "pop.163.com" and "110". Then touch "Next".

Note: If you select IMAP Account in step 2, touch "IMAP Server" and enter "IMAP.163.com".



4. Touch "SMTP Server" and "Port", enter "smtp.+ account suffix" and port number, for example "smtp.163.com". Then touch "Next".



5. Set the account options and touch "Next" to finish settings.

Note: Since the e-mail service providers may vary, configure the server settings based on the actual e-mail account. This product can support the accounts provided by the popular e-mail service providers, such as Yahoo, Sohu, etc.

8.1.1 Opening e-mail

In the "apps" interface, touch "E-mail" to enter.

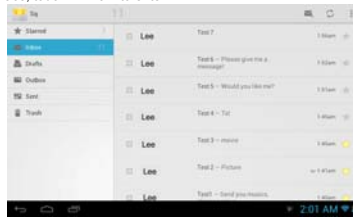

Tip 1: By default, this product can be used to browse the inbox after the e-mail app has synchronize with email provider. All e-mails you received will be put into the inbox.

Tip 2: Touch "Refresh" icon to send or receive a new e-mail and synchronize your e-mails with your e-mail accounts.

8.1.2 Creating and sending e-mails

1. Touch the "Compose" icon at the top right of the E-mail interface.
2. Next to "To", enter the e-mail address of the receiver.

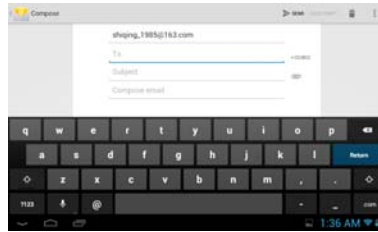

Tip: If you want to send a carbon copy or a blind carbon copy e-mail to other recipients, touch "+CC/BCC".

3. Enter the e-mail subject and compose your e-mail.

Tip: If you want to add a picture attachment, touch the "Attach" (paper clip) icon, select the picture you want to attach, and touch it to confirm or touch the "Cancel" icon to cancel.

4. After composing your e-mail, touch "Send".

Tip: When you compose your e-mail, touch the "Save draft" or back icon to save your e-mail to Draft.

8.1.3 Receiving and reading e-mail

When a new e-mail is received, the notification bar will show the new e-mail (envelope) icon.

Perform one of the following to read your e-mail:

- Touch the notification bar, and touch the new e-mail to read.
- Touch the unread e-mails in the Inbox to read.

8.1.4 Replying / Forwarding e-mail





Open an e-mail, touch “” icon to reply, touch “” icon to reply all and touch “” icon to forward the email.

8.1.5 Managing e-mails

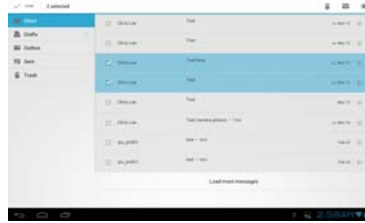
Touch and hold an e-mail or touch mini-box in front of the e-mail to show the menu:



 Delete	Delete the e-mails.
 Mark as read/unread	The unread e-mails in the Inbox are highlighted with white background.
Add “  ” (Star)	Flag with a Star

8.1.6 Email Settings

In the e-mail interface, touch the menu icon, and touch “Settings” to go to the e-mail settings interface. Touch “Add Account” to add a new e-mail account.

Note: You can set several e-mail accounts. The default account will show whenever you perform e-mail apps.

Account name	Display and change an account name.
Your name	Display and change the sender's name of the account.
Signature	Display your signature at the bottom of your email.
Quick responses	Edit text that you frequently insert when composing email.
Default account	Send e-mails from this account by default.
Inbox check frequency	Set the interval of receiving e-mails. There are six options available: Never, Every 5 minutes, Every 10 minutes, Every 15 minutes, Every 30 minutes, and Every hour.
E-mail notifications	Notify in Notification bar when e-mail arrives.
Choose ringtone	Set the ringtone used when an e-mail is received.
Incoming settings	Display and change the receiving server settings.
Outgoing settings	Display and change the sending server settings.
Remove account	Remove user account.

8.2 Recorder

In the "Apps" interface, touch "Sound Rec" to go to the record interface.

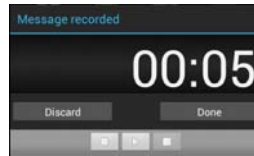

Touch "▶" to start recording or "■" to stop recording. After recording is finished, touch "▶" to play the just recorded file. Touch "Done" to save the just recorded file or touch "Discard" to not save the recorded file.

Note 1: The recorded file can be automatically saved in flash so that you can find them in the AudioPlayer "playlists ->My recordings" to play.

Note2: The naming rule of the recorded file: recording_Year+Month+Date+Time stamp.

8.3 Alarm

In the "Apps" interface, touch "Clock" to the clock interface.



Touch "Set alarm" to enable the alarm function.

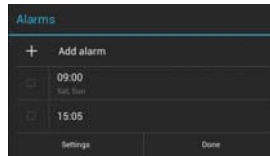

8.3.1 Set alarm

1. Touch the preset alarm to select an alarm or touch "Add alarm" to add new alarm.
2. Touch "settings" to set some menus such as "Alarm in silent mode", "Alarm volume", "Snooze duration", "Auto-silence", "Volume buttons", "Set default ringtone".
3. Touch "Time", and set the time for the alarm. Slide your finger up and down to adjust the time, and touch "Set" to complete.
4. Touch "Repeat," select the date you want the alarm to ring, and touch "OK".
5. Touch "Ringtone" and select alarm ringtone. After selection, the ringtone will be played temporarily.
6. Touch the "Label", set the name of the alarm.
7. Touch the "DONE" icon to go back to the alarm interface.

Tip: Touch "☐" to turn on or turn off the alarm.

Note: When it is shut down, the alarm is not affected.

8.3.2 Delete alarm

Touch and hold the alarm you want to delete and touch "Delete alarm -> OK" to delete it.

8.4 Calculator

In the apps interface, touch the "Calculator" icon to go to the calculator interface.
You can perform the basic math operations by this calculator.

8.5 Explorer

In the "Apps" interface, touch "Explorer" to go to the Explorer interface that includes the following options:

Home	Touch to return to the root directory.
Level Up	Touch to return to the upper level directory.
Multi	Touch to select multiple files.
Editor	Allow you to Copy, delete, move, paste or rename a file.
NewFolder	Create a new folder.
Back	Back to the previous operation.
Next	Back to the next operation.

Note: This product complies with the fat32 file system. When you name a file, do not use special characters, or you may not rename it later.

8.6 Installing apps

1. Copy the setup file to your PC. (Make sure the format of the setup file is xxx.apk format supported by this product.)
2. Connect the device to PC using USB cable.
3. Copy the setup file xxx.apk to the device.
4. Disconnect the device from PC.
5. Turn on the device and activate Explorer.
6. Locate the xxx.apk file and touch it to open.
7. Install the app according to the on-screen prompts.
8. After completion, you will see the installed app in the apps interface.

8.7 Uninstall app

1. In the apps interface, touch and hold the app you want to uninstall.
2. Move the app to trash can and touch "OK" to uninstall it.

Tip: You cannot delete the pre-installed factory default app on this product.

Chapter 9 Settings

In apps interface, touch the "Settings" icon to go to the "Settings" interface.

9.1 WIRELESS & NETWORK Settings

9.1.1 Wi-Fi network connection

Connection

1. Touch "Wi-Fi" to enter into Wi-Fi settings interface.
2. Slide the slider to right to enable Wi-Fi and scans for available wireless networks.



3. Touch the desired wireless network name to connect to it. You will be prompted, if a password is required.
4. If static IP address needs to be entered, touch "show advanced options" for more options. Then click on "show advanced options" to show "IP settings". Touch the pop-up menu and select "static". Then enter the IP address, gateway, network mask, and DNS information required for such Wi-Fi network connections.
5. If you use dynamic IP address keep the default "DHCP" in the "IP settings" option.

Note: The word "Connected" displayed under the network name indicates a successful connection.

Afterwards you can surf the Internet, connect to email services, etc.

Note 1: When you connect Wi-Fi for the first time and the prompt "Failed" appears, disconnect Wi-Fi and reconnect it. When you input an incorrect password and the prompt "Authentication problem" appears, touch the network and touch "Forget", then connect with correct password.

Note 2: You do not have to re-enter the password when you re-connect to the previously

connected wireless network that is encrypted, unless you reset the product to the factory settings.

Note 3: Auto search for Wi-Fi is performed, i.e., no additional steps are required to connect to the Wi-Fi network. For some closed wireless networks, the username or password may be required.

Note 4: The availability of Wi-Fi signals may depend on the distance, infrastructure, and objects through which a signal must pass.

Scan

Touch the menu icon () and "Scan" icon at the top right corner of screen to search for the available wireless networks in the vicinity.

Advanced settings

Network notification	Select to notify you when an open network is available.
Keep Wi-Fi on during sleep	Choose under which condition (Always, Only when plugged in or Never) to keep Wi-Fi on when tablet is in standby mode.
MAC address	Shows the tablet's Wi-Fi MAC address.
IP address	Shows the tablet's IP address.

Checking status of wireless network

You can check the status of the currently connected Wi-Fi through the following methods:

- Status bar

After the product is connected to the wireless network, the status bar shows the Wi-Fi icon  and signal strength (the number of the bars lighting up).

- Wi-Fi network

In the network connection interface, touch "Wi-Fi settings" and touch the currently connected wireless network to show the information, such as name, status, speed, signal strength, and security.

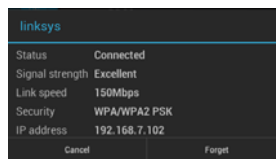

Tip: If you want to remove the network settings, touch "Forget" in this window; if you want to

connect to this network, the settings should be configured again.

Connecting to other Wi-Fi networks

In the "Wi-Fi" settings interface, touch "+" icon and enter the corresponding network settings, and touch "Save".

Tip: Not all wireless networks are connected to the Internet. Some wireless networks may be connected to several computers and cannot be connected to the Internet.

9.1.2 Data usage

Show the usage per app statistics in per day.

9.2 DEVICE Settings

9.2.1 Sound

Volumes	Music, video, games & other media	Set the media volume for music and video. Touch the volume bar to adjust the volume level.
	Notifications	Set the notification volume by touching the volume bar to adjust the volume level.
	Alarms	Set the alarm volume by touching the volume bar to adjust the volume level.
Default notification		Set your default notification ringtone.
Touch sounds		Play sound when touch screen.
Screen lock sounds		Play sounds when locking and Un-locking the screen.

9.2.2 Display

Brightness	Adjust the screen brightness. Touch the brightness bar to adjust the volume level and touch "OK" to save.
Wallpaper	Choose wallpaper from Gallery, Live Wallpapers or Wallpapers.
Sleep	Select the delay time before the screen automatically closes. There are six options available: 15 seconds, 30 seconds, 1 minute, 2 minutes, 5 minutes, 10 minutes, 30 minutes.
Font size	Set the font size of tablet. There are four options available: Small, Normal, Large and Huge.

9.2.3 ScreenshotSetting

Select delay time to	Screenshot will be delayed according to the setting time.
----------------------	---

capture the screen	
Set the location of screenshot storage	Select a location to store the screenshots.
Show the screenshot button in the status bar	Click to show the shortcuts screenshot button in the status bar.

9.2.4 Storage

INTERNAL STORAGE	Total space	Show the total capacity of the Internal Memory.
	Apps	Show the used space of the apps.
	Available	Show the remaining free space of the data memory.
NAND FLASH	Total space	Show the total capacity of the Internal Flash memory.
	Apps	Show the used space of the apps.
	Pictures, videos	Show the used space of pictures and videos.
	Available	Show the remaining free space of the Nand Flash.
	Erase storage	Erases all data on the Nand Flash, such as music and photos.

After SD card and USB drive plugged in, the following options will appear.

SD CARD	Total space	Show the total capacity of the SD card.
	Available	Show the free space on the SD card.
	Unmount storage	Safely remove the SD card locally.
	Erase storage	Erase all data on the SD card.
USB Disk	Total space	Show the total capacity of the USB drive.
	Available	Show the free space on the USB drive.
	Unmount storage	Safely remove the USB drive locally.
	Erase storage	Erase all data on the USB drive.

Touch the menu icon at the top right corner of screen, touch "USB computer connection".

CONNECT AS	Media device (MTP)	It lets you transfer files on Windows, or using Android File Transfer on MAC.
	Camera(PTP)	It lets you transfer photos using camera software.

	Mass Storage	Use Mass Storage to share files (Mac or Windows).
--	--------------	---

9.2.5 Battery

It shows the status of battery and the elapsed time of use.

9.2.6 Apps

Manage and delete installed apps: For uninstall apps, clear data, clear cache, clear default and force stop.

9.3 PERSONAL Settings

9.3.1 Location services

Google's location service	Select to allow Google's location service to collect approximate location data from Wi-Fi or mobile networks.
Location & Google search	Select to allow Google to use location for improved search results and other services.

9.3.2 Security

Screen lock	Lock screen with Slide, Face Unlock, Pattern, PIN, or Password.
Automatically lock	Set the delay time to run automatically lock after sleep.
Power button instantly locks	Selected to instantly lock the screen after power button press.
Owner info	Show the information user want you display on lock screen.
Make passwords visible	After this feature is enabled, the password is shown when the keyboard is used to type it.
Device administrators	View or deactivate device administrators.
Unknown sources	Select to allow installation of non-Market apps.
Trusted credentials	Display trusted CA certificates
Install from SD card	Install certificates from SD card
Clear credentials	Remove all certificates.

9.3.3 Language & input

Language	Select language for device
Spelling correction	Select to enable spelling correction.
Personal dictionary	Add & remove words form user dictionary

Default	Set the default input method.
Android keyboard	Touch settings icon to set Android keyboard.
Google voice typing	Touch settings icon to set Google voice typing.
Voice Search	Touch to set language. SafeSearch, Block offensive words and show hints.
Text-to-speech output	Touch to set the preferred engine, set the speed at which the text is spoken, and ect.
Pointer speed	Set the pointer speed of (optional) mouse and trackpad.

9.3.4 Backup & reset

Backup my data	Select to back up app data, Wi-Fi passwords and other Google settings.
Backup account	Choose the backup account.
Automatic restore	When reinstalling an app, restore backed up settings and data.
Factory data reset	Erases all data on tablet.

9.4. Accounts & Sync

SYNC: Selected the options to turn on sync.

ADD ACCOUNT: Touch "ADD ACCOUNT" to add corporate, Email or Google account.

9.5 SYSTEM Settings

9.5.1 Data & Time

Automatic date & time	Use network-provided time.
Set date	Set year, month and day.
Set time	Set hour and minute.
Select time zone	Select the time zone.
Use 24-hour format	Show 12-hour or 24-hour format
Select date format	Select the format used for date display.

9.5.2 Accessibility

Talk Back	Slide the slider to the right to enable the talk back. When talkback is on, tablet provides spoken feedback to help blind and low-vision users.
Identify Gesture	Can collect all text you type, except passwords.
Large text	Select to show large text.
Auto-rotate screen	When feature is checked on, the Landscape/Portrait

	switching feature is enabled. This product supports 4-direction rotation display.
Speak passwords	Allow spoken passwords
Text-to-speech output	Touch to set the text-to-speech settings.
Touch & hold delay	Set touch & hold delay to Short, Medium or Long time.
Enhance web accessibility	Touch to forbid or allow Apps to install scripts from Google

9.5.3 About device

This option allows you to check information about the battery status, Legal information, Model number, Android version, Kernel version and Build number.

Chapter 10 Using Micro SD (TF) Card

The external card supported by this product is a Micro SD card, through which the capacity of storage can be expanded. To install, insert the Micro SD card into the slot with the silk screen lettering facing away from front of tablet. Push into card slot until it is fully inserted and locks inside the product. To remove Micro SD card, press the Micro SD card inward to eject it.

Note:

- Insert cards face-down into the card slot.
- Do not bend the card. The card should be in a protected case, when not in use.
- Keep the chip clean and avoid dust and chemicals.
- Format new Micro SD cards before first use.
- Avoid insertion and removal of the Micro SD card while in use to avoid damage or losing data.
- This product does not support the write-protect feature of Micro SD cards.
- Back up files on card before deleting data to avoid possible loss due to errors.

Chapter 11 Connecting to USB Drive

Plug the larger end of the provided Micro USB Adapter to the USB drive. and the smaller end of it to the Micro USB port on the side of product.

Open Explorer and you can see the "USB" directory. This directory is your USB drive. Touch USB to check the files on USB drive. Note that when unit is connected to a USB drive, it should be turn off / shutdown. Avoid insertion and removal when the files on USB drive are in play / use to avoid damaging the data on USB drive.

Note: When you unplug the Power Adapter or USB cable or Micro USB Adapter from the micro USB port on the side of product, please pinch the head of the cable, do not pinch the middle of the cable.

The correct way



The wrong way



Chapter 12 About the Battery and Power

This product uses a built-in 3100mAh polymer lithium battery. When the provided power adapter is connected, the battery is automatically charged.

When you charge this product for the first time, it is recommended to shutdown the product and charges it continuously for more than 3.5 hours for optimal battery use.

When using a new product, the battery should be fully charged and totally discharged for the first three times, to activate set a battery's ideal lifecycle.

If charging is performed while the product is in use, it takes a longer time to charge.

Charging time: Typically takes about 3.5 hours to charge. The actual time depends on the battery level when starting to charge.

It is recommended to fully charge and discharge the product once every 3 months to extend the lithium battery life.

Do not plug the charger into the electric outlet when the product is not also connected to it.

When tablet will not be used for an extended period of time, fully charge the battery before storing. It should also be charged and discharged about every three months.

If the battery ever gets too hot, the charging protection circuit will automatically open the charging circuit to protect the lithium battery and the tablet.

When the battery is low, charge before using. When it is running out of power, charge the machine using the provided charger..

Charge it if:

- A. The battery charging icon indicates that battery power is almost exhausted / really low
- B. The system automatically shuts down. It also shuts down quickly after reboot.
- C. After you press buttons, there is no response.

Chapter 13 Firmware Updating / Resetting to Factory

1. Go to for the website (www.aoc.com) to download the current / latest firmware for your device.
2. Follow the instructions provided for the model of AOC tablet being updated.

Note: During the upgrade / resetting process, it is best to have the device plugged into electric power, using the supplied power adapter.

Chapter 14 Frequently Asked Questions

- **Product cannot be turned on or boots-up abnormally**

- ① Plug the AC adapter.
- ② Press and hold the Power button for 6 to 10 seconds, to restart.
- ③ Shutdown (ensure the USB and power cables is unplugged, then,
 - a) Press and hold the power button and volume button 3 seconds at the same time. Release the buttons and tablet will boot and an Android robot will be displayed.
 - b) Press and hold "-" and then press the "+" button. This will cause the tablet will go into the "Android system recovery interface"
 - c) Select "wipe data/factory reset" (navigate menu by pressing volume up/down ("+" / "-") buttons), then,
 - d) Press the power button to perform selection.
 - e) Navigate (with the volume up/down ("+" / "-") buttons) to the menu item: "Yes – delete all user data.
 - f) Press the power button to perform selection.
 - g) When presented with "reboot system now", press the power button to perform selection.

The tablet will be restored to factory defaults and all data on device will be erased.

- **No sounds from headset**

Check if the volume is set to 0 (lowest).

Check if the headset is properly connected (plugged all the way in).

- **Loud / static noises**

Check if the plug of the headset is clean. Dirt may result in noise.

Check if the file being played for possible damage. Play other music files to confirm this. If it is damaged, it may cause loud noises or sound skipping.

- **Screen shows garbled / incomprehensible characters**

Check if the correct language is set (in Settings / Language & input).

- **Cannot download files**

Make sure that the computer is properly connected to the tablet

Make sure that the storage space is not full

Make sure that the USB cable is not damaged

- **Connect to Wi-Fi but cannot surf the Internet**

Confirm connection to internet from another source using same Wi-Fi network..

If static IP addresses are needed, make to enter a valid IP address. If dynamic IP addresses are used, static IP addresses should be disabled while the network is connected.

- **Cannot connect to computer**

Make sure the tablet is turned on

Make sure the tablet is not in sleep mode

Make sure to use the correct USB cable

- **Cannot view files in AudioPlayer, PhotoBrowser, Video Player, Shelves and/or Explorer. Cannot record sound.**

Confirm the correct files have been downloaded to your tablet.

Ensure your device is not connecting to PC.

Wait a few minutes for to allow refresh of media library.

Chapter 15 Troubleshooting

1. When I view JPEG pictures, some of them cannot be viewed. Why?

Some JPEG files may have a non-standard resolution, they may not be viewed in full screen, or zoomed in or out. If an error prompt appears, touch the back icon to exit or touch the Reset button on the side of the product to resolve the problem.

2. The product cannot play my videos. Why?

Make sure the video format is supported by this product. Some video files are encoded in different formats and versions. We cannot guarantee that all formats are playable.

3. Why does image lag occurs when the video files are played?

Upgrade system software to the latest version.

In addition, this also depends on the video file, high bit-rate streaming video and high resolution video.

① High bit-rate streaming video. For example, the motion scenes of some videos have a bit-rate of 5~6M and image lag may occur.

② High resolution video. If the max frames are reached, non-synchronization may occur.

5. Product does not respond to operations.

Various conditions may cause the tablet to be unable to shutdown or respond. You can press and hold the Power button for 8 seconds to force the product to shutdown. After restarting, the problem is usually solved.

6. The space available on PC is not consistent with that shown on the tablet.

The space on a PC is calculated by 1024 bytes while this tablet's capacity is calculated by 1000 bytes. So the actual free space of the tablet will be slightly different from indicated capacity, also the operating system uses part of the available space.

7. Cannot connect to Wi-Fi.

If you can not connect to Wi-Fi after resetting tablet, please restart and then connect again.

FCC Caution: Any changes or modifications not expressly approved by the party responsible for compliance could void the user's authority to operate this equipment.

This device complies with Part 15 of the FCC Rules. Operation is subject to the following two conditions: (1) This device may not cause harmful interference, and (2) this device must accept any interference received, including interference that may cause undesired operation.

This device and its antenna(s) must not be co-located or operating in conjunction with any other antenna or transmitter.

FCC15.105: This equipment has been tested and found to comply with the limits for a Class B digital device, pursuant to Part 15 of the FCC Rules.

These limits are designed to provide reasonable protection against harmful interference in a residential installation. This equipment generates, uses and can radiate radiofrequency energy and, if not installed and used in accordance with the instructions, may cause harmful interference to radio communications. However, there is no guarantee that interference will not occur in a particular installation. If this equipment does cause harmful interference to radio or television reception, which can be determined by turning the equipment off and on, the user is encouraged to try to correct the interference by one or more of the following measures:

- Reorient or relocate the receiving antenna.
- Increase the separation between the equipment and receiver.
- Connect the equipment into an outlet on a circuit different from that to which the receiver is connected.

-- Consult the dealer or an experienced radio/TV technician for help.