



Contents

Introduction	1-2
Gg03 overview	3-7
Getting started	6-13
Using your headset	17-22
Using your headset with multiple Bluetooth devices	23-27
Function / Button matrix	28-29
LED indicator chart	30-31
Audio indicator chart	32
Additional information	33-38
Declaration of conformity	39-41
Regulatory information	41-42

«Introduction»

Your Bluetooth headset Gg03 is a portable headset solution based on Bluetooth wireless technology. Please read the "Additional Information" before using your headset.

What is Bluetooth wireless technology?

Bluetooth is the most advanced cable-replacement technology available today. It enables effortless, cable-free connections between your Bluetooth devices. your headset and the Bluetooth enabled phone can communicate within the range up to 10m (30 ft) outdoors or up to 5m (15 ft) indoors with no solid objects in between.

How to use your headset?

your headset is a Bluetooth V1.2 qualified product and supports both Headset profile and Handsfree profile. your headset can store information and wirelessly interacts with up to three different Bluetooth V1.1/V1.2 compliant devices, including mobile phones, PDAs and PCs or any Bluetooth enabled device that supports Headset profile or Handsfree profile. This manual focuses on how to use your headset with your Bluetooth enabled phone. When your headset is connected to your phone, you can do:

- ⊙ Handle incoming and outgoing calls.
- ⊙ Adjust the volume.
- ⊙ Mute the microphone.
- ⊙ Voice dialing (if your phone supports this function).
- ⊙ Last call redial (if your phone supports Handsfree profile).
- ⊙ Reject the incoming call (if your phone supports Handsfree profile).

What's in the package?

your headset Bluetooth headset package comes equipped with a headset and a charging solution.

In this package you will find:

- ⊙ One Bluetooth headset.
- ⊙ One 100-240V power adapter.
- ⊙ One USB charging cable.
- ⊙ One user guide.
- ⊙ One portable charging cradle in the Gg03 package.
- ⊙ One removeable ear-hook in the Gg03a package.



«Gg03 overview»

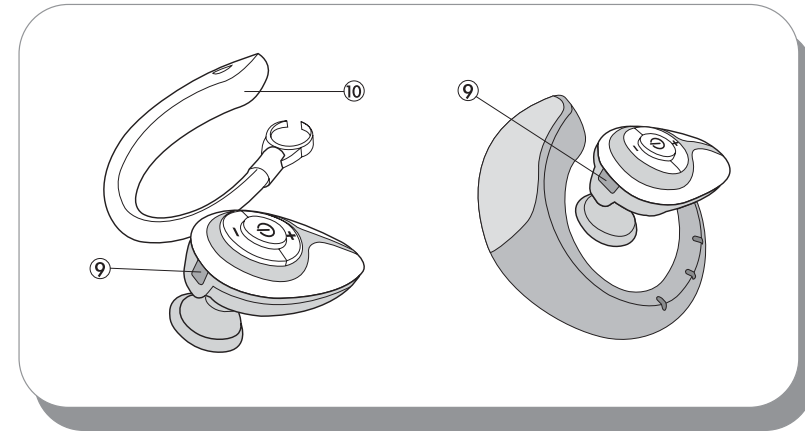
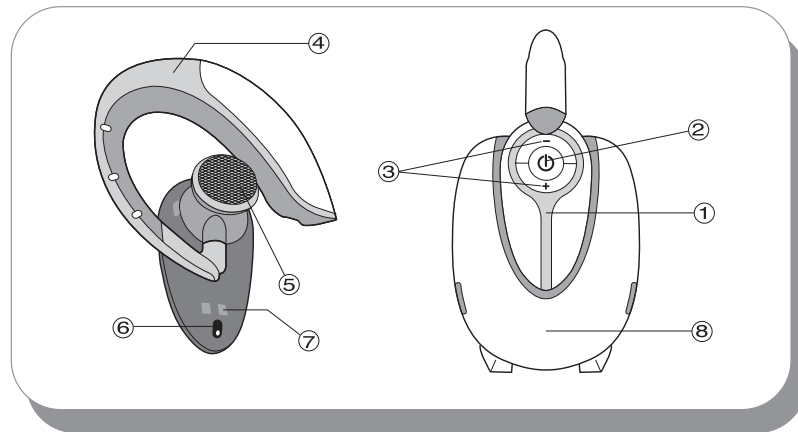





1.Indicator LED

There are 3 colors(blue/red/purple) to show the status of your headset.



2.Multifunction button 

To answer, end, reject a call and control advance functions by constituting with volume control button   (please refer to the Function/Button matrix).



3.Volume control button  

To increase or decrease the volume of speaker and control advance functions by constituting with MFB  (please refer to the Function/Button matrix).



4.Ear-hook

To wear the headset on your ear, you can switch the direction as your habit.



5. Speaker

Plays the sound you receive on the call or the audio indicators (please refer to the audio indicator chart).



6. Microphone

Voice input for outgoing voice.



7. Charging port

Approaching with the cradle to charge the battery of your headset.



8. Charging Cradle

Design for charging the headset by multiple power supplier such as switching adaptor, USB cable or car charger.





9. Charging Port

Plug in the USB charging cable to charge the battery of your headset.



10. Removable

Removeable ear-hook fits either ear.

«Getting started»

Before you can use your headset, you must do following two things:

1. Charge your headset battery, using an appropriate G.G. Telecom charger.
2. Pair your headset with a Bluetooth enabled device, for example, a mobile phone.

Charging

your headset comes with a built-in rechargeable battery. For the first time use, you need to charge for 4 hours. During charging, the indicator shows a steady red light. When the battery is fully charged, the red light is off. It takes 90-120 minutes to fully charge the battery. Do not charge your headset for more than 1 day. The talk time of Gg03 is about 8 hours, and the standby time is about 220 hours. The more you talk using your headset, the less standby time your battery has. your headset require longer charging times when not used over extended periods of time.

To charge your headset

1. Make sure the earhook forms an angle of 90°.

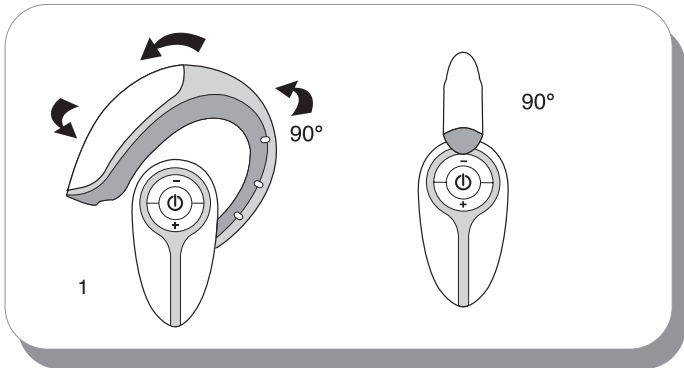

2. Secure the bottom of the headset on the cradle.

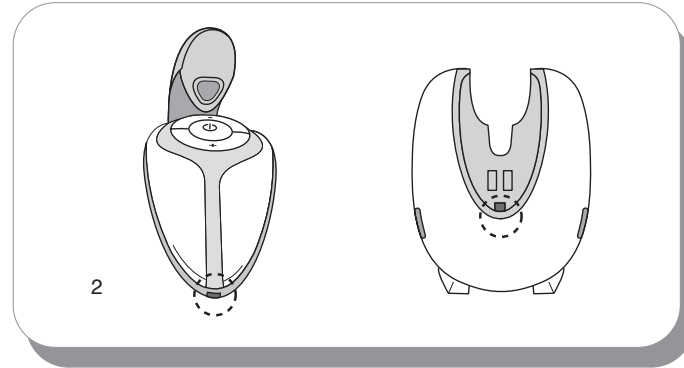

Getting started

3. Press the tip of the earpiece firmly towards the cradle until you hear a “click” sound.
4. You will see the red light when the headset is properly charging.

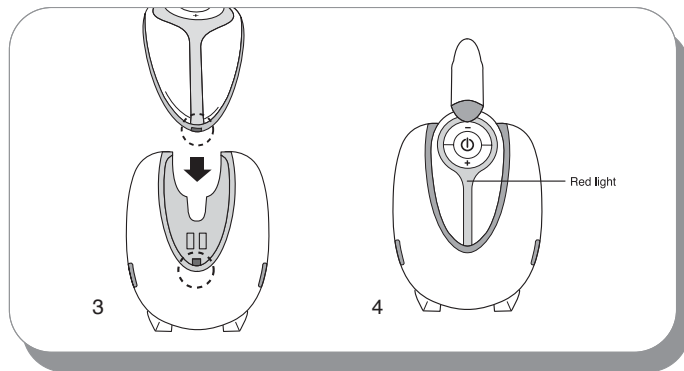

5. It takes 90-120 minutes to fully recharge the battery. Red indicator is off.
6. Press the buttons on the both side of your cradle to remove your headset from your cradle.

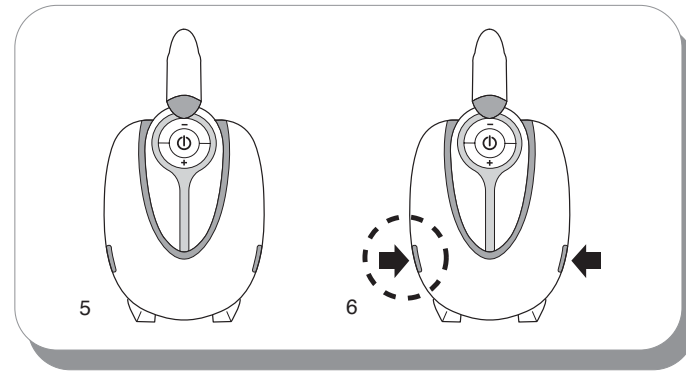



Gg03a



Gg03v





Gg03a / Gg03v

1. Plug the USB charging cable into the charging port of the headset.
2. Plug the other end of the USB charging cable into the PC's USB port, charging adapter or car charger.
3. When charging is complete (Red indicator is off, remove the charging adapter or car charger, and detach the USB charging cable from the headset.

Pairing

Power on your headset

Long press the MFB , then you will hear a power on melody and the blue indicator will quickly flash twice. You could start the operation now.

Note 1:

The first time your headset is turned on, it might automatically be ready for pairing.

Note 2:

Long press: It refers to press and release and the duration is more than 3 seconds. After long press, you should hear 1 long beep.

Short press: It refers to press and release and the duration is less than 1 second. After short press, you should hear 1 short beep.

Power off your headset

Long press the MFB , then you will hear a power off melody and the red indicator will quickly flash twice.

Pairing your headset with your phone

Pair your headset with your phone by adding it to the list of paired devices in your phone. your headset should be paired once with your phone before use. The two devices then recognize each other when they connect. You do not need to pair it again until you want to use your headset with another device or the pairing information is deleted from your phone. It is recommended that the distance between your headset and your phone is as close as possible with no solid objects in between.

1. Put your headset enter pairing mode by long pressing the Volume up button . You can see the blue indicator and the red indicator cross blink per second, your headset is waiting for pairing now. You can only put your headset into pairing mode when it is in standby mode (please refer

to the LED indicator chart).

2. Perform a "Bluetooth device discovery" from the mobile phone.
3. Select your headset from the discovered devices list and confirm the following on screen prompts.
4. When prompted by your phone, enter the passkey "1234" and your headset will confirm to pair successfully with a pairing success melody.

Note:

If your headset is not successfully paired within 2 minutes, it will automatically leave pairing mode. If there is no paired data in the paired devices list of your headset, it will power off otherwise get into standby mode.

«Using your headset»



After you have paired your headset with your phone, you can make and receive a call using your headset as long as your headset and your phone are turned on and these two devices are within range of up to 10 m(30 ft) outdoors or up to 5 m(15 ft) indoors with no solid objects in between. When using your headset, always make sure the Bluetooth operation mode in your phone is on. your headset supports both Handsfree profile and Headset profile. Accessing call functions depends on which profile your phone supports.

Making and answering a phone call

You can make and answer a phone call using the MFB  on your headset, or using the keys on your phone as usual.

To make a call using voice dialing

1. Make sure your phone support this function and is on.
2. Make sure your headset and your phone are both powered on and within range of each other.

3. Short press the MFB  on your headset. It may take a while to set up the Bluetooth connection if the Bluetooth connection is down.
4. After you hear a beep, voice dial as you normal would.
5. To cancel the voice dialing or end the call by short pressing the MFB .

Note:

Using your headset to record the voice tag can let the recognizing rate enhancement. Please refer to the user's guide of your phone.

To answer a call



1. When your headset rings or LED indicates you have an incoming call (please refer to the LED indicator chart), short press the MFB  to answer the incoming call.

Note:

If your phone rings first, wait until your headset rings, then short press the MFB . Your phone takes time to set up the Bluetooth connection if the Bluetooth connection is down.

2. End the call by short pressing the MFB .

To redial the last call

1. Make sure your phone support Handsfree profile.
2. When your headset is in standby mode, long press the Volume down button  until you hear a long beep.
3. To cancel the last call redial or end the call by short pressing the MFB .



To reject a call

1. Make sure your phone support Handsfree profile.
2. When your headset rings, long press the MFB  until you hear a long beep.

Adjusting the volume

your headset listening volume and ring volume can be adjusted during a call, your headset will remember your volume setting.





To adjust the listening volume

1. To increase the volume, short press the Volume up button .
2. To decrease the volume, short press the Volume down button .
3. An long beep will be played while either the minimum or maximum volume has been achieved.

Note:

For safety reasons, do not always adjust the listening volume to the maximum setting.



To mute the microphone

1. During a call, short press both Volume up button  and Volume down button  at the same time to turn off the microphone. While the microphone is turned off, a mute notice tone is heard every 3 seconds .
2. Short press both Volume up button  and Volume down button  at the same time to resume the conversation.



To do audio transfer from your phone to your headset

If your headset is turned on or got within range after a call has been initiated, you can transfer the sound from your phone to your headset by short pressing the MFB  during a call.

Note:

To do audio transfer from your headset to your phone, please short press the MFB  and Volume down button  at the same time.

Release the Bluetooth connection

Some mobile phones (e.g. NOKIA mobile phones) do not release the Bluetooth connection when not during a call. For some reasons (e.g. power consumption), you can release the Bluetooth connection from your headset by short pressing the MFB  and Volume down button  at the same time then the Bluetooth connection will be dropped.

Note:

Some mobile phones (e.g. NOKIA mobile phones) can not work properly when there is no Bluetooth connection between the Bluetooth headset and the phone, so if these two devices can get into sniff mode(please refer to the LED indicator chart) when not during a call , do not release the Bluetooth connection!!

Using your headset with multiple Bluetooth devices

«Using your headset with multiple Bluetooth devices»

your headset can pair with up to three different Bluetooth V1.1/V1.2 compliant devices that support Headset profile or Handsfree profile. You do not need to buy 3 Bluetooth headsets when you using 3 Bluetooth mobile phones, just one Gg03/Gg03a/Gg03v could meet your requirement. Please refer the Function/Button matrix for the advance functions.

Pairing the second/third phone with your headset

Pair the second/third phone with your headset by adding it to a list of paired devices in your headset. The second/third phone should be paired once with your headset before use. It is recommended that the distance between your headset and your phone is as close as possible with no solid objects in between.

1. Put your headset enter pairing mode by long pressing the Volume up button  on your headset. You can see the blue indicator and the red indicator cross blink per second, now your headset is waiting for pairing now. You can only put your headset into pairing mode when it is in standby mode (please refer to the LED indicator chart).

2. Perform a Bluetooth device discovery” from the mobile phone.
3. Select your headset from the discovered devices list and confirm the following on screen prompts.
4. When prompted by your phone, enter the passkey “1234” and your headset will confirm to pair successfully with a pairing success melody.

Note:

If you have paired your headset with the third phone, you can not put your headset enter pairing mode. The paired devices list of your headset is full now, so if you want to paire your headset with another phone, you must reset your headset to clean the paired devices list. And all the paired data stored in the paired devices list will be lost.

Resetting your headset

You may want to reset your headset to its default settings or want to pair your headset the paired devices list is full with another Bluetooth device. Resetting your headset clears all the



Using your headset with multiple Bluetooth devices

current pairings.

1. Short press and release all the three buttons on your headset and the duration is less than 1 second. You can see the purple indicator quickly flash twice then the blue indicator and the red indicator cross blink per second, your headset go into pairing mode automatically after resetting. You can only reset your headset when it is in standby mode (please refer to the LED indicator chart).
2. Pair the Bluetooth device with your headset.

To answer a call

When your headset have a Bluetooth link with one of the paired phones, and the other paired phone rings, you can answer this call follow these steps:

1. Release the Bluetooth connection with current device by short pressing MFB  and Volume down button  at the same time.

2. After your headset get into standby mode (please refer to the LED indicator char), press the

your headset takes time to set up the Bluetooth connection with the n'th phone. If you hear the ring tone from your headset, just short press MFB  again to answer this call.

3. End the call by short pressing the MFB .

To make a call using voice dialing

1. Make sure your phone support this function and is on.
2. Make sure your headset and your phone are both powered on and within range of each other.
3. Voice dialing through the current connected device by short pressing the MFB  1 time on your headset.

Note:

Short press the MFB  n times to voice dial through the n'th paired device when not connected. It may take a while to set up the Bluetooth connection if the Bluetooth

connection is down.

4. After you hear a beep, voice dial as you normal would.

5. To cancel the voice dialing or end the call by short pressing the MFB .

To redial the last call

1. Make sure your phone support Handsfree profile.





2. Redial the last call through the current connected device by long pressing the Volume down button  on your headset.

Note:

Last call redial using the current connected phone when connected and using the first paired phone when not connected. It may take a while to set up the Bluetooth connection if the Bluetooth connection is down.

3. To cancel the last call redial or end the call by short pressing the MFB .

«Function / Button matrix»

Function	Button
Power on/off	 long press for 3 seconds
Pair	 long press for 3 seconds
<ul style="list-style-type: none"> ● Voice dial using the current connected phone when connected ● Voice dial through the first paired phone when not connected ● Cancel voice dialing ● Cancel last call redial ● Answer a call ● End a call 	 short press 1 time
Voice dial through the second paired phone when not connected	 short press 2 times
Voice dial through the third paired phone when not	 short press 3 times



LED Indicator chart

Function	Button
<ul style="list-style-type: none"> • Last call redial using the current connected phone when connected • Last call redial using the first paired phone when not connected 	⏻ long press for 3 seconds
Reject a call	⏻ long press for 3 seconds
Volume up	⏮ short press 1 time
Volume down	⏭ short press 1 time
Mute/Unmute the microphone	⏮ ⏭ short press 1 time
<ul style="list-style-type: none"> • Release the Bluetooth connection • Audio transfer from the headset to your phone 	⏻ ⏭ short press 1 time
Reset	⏻ ⏮ ⏭ short press 1 time

※ Short press: It refers to press and release and the duration is less than 1 second. After short press, you should hear 1 short beep.

※ Long press: It refers to press and release and the duration is more than 3 seconds. After long press, you should hear 1 long beep.

《LED indicator chart》

Headset State	LED Indication
Power off	Red indicator blinks twice
Power on	Blue indicator blinks twice
Pairing mode	Red & Blue indicator blinks by turns.
Reset	Purple indicator blinks twice and then Blue & Red indicators blinks by turns as pairing mode
Standby mode	Blue indicator blinks once every 4 seconds
Sniff mode	Blue indicator rapidly blinks twice every 4 seconds
Incoming call	Purple indicator blinks once per second
Talking	Blue indicator rapidly blinks 3 times every 4 seconds
Charging	Red indicator light steady on
Charging complete	Red indicator off
Voice dialing	Blue indicator blinks once per second

Headset State	LED Indication
Mute	Red indicator blinks per second
Low battery	Red indicator rapidly blinks twice every 5 seconds

Note:

Sniff mode: The sniff mode is for power conservation and short response time purpose. There is already a Bluetooth connection between your headset and your phone when in sniff mode, so do not spend time to set up a Bluetooth connection when need.

« Audio indicator chart »

Headset state	Audio indication
Power on	Power on melody
Power off	Power off melody
Pairing success	Pairing success melody
Volume adjustment	Notice tone while either the minimum or maximum volume has been achieved
Incoming call	Mobile phone ring tone or Gg03 default ring tone depends on mobile phones
Mute	Mute notice tone
Low battery warning	Low battery tone
Long press	Lone beep tone
Short press	Short beep tone

«Additional information»

Product care

- Please check for any exceptions, due to national requirements or limitations, in usage of Bluetooth equipment before using your headset.
- Please check the laws and regulations on the use of mobile phones and hands free equipment like your headset in the areas where you drive. Do not carry or store flammable goods such as gas, liquid in your vehicle compartment containing your headset.
- Do not use your headset while the plane is in the air, Turn OFF your headset before boarding any aircraft.
- Do not use your headset near the medical equipment without requesting permission.
- Use of non-G.G. Telecom original accessories may result in lost of performance, product damage, electronic shock or injury, and warranty termination. Please note only G.G. Telecom service partners should remove or replace the battery.

- Do not attempt do disassemble your headset. your headset does not contain consumer serviceable or replaceable components. Only G.G. Telecom service partners should perform service.
- Do not place your headset in extreme hot or cold temperature.
- Do not place your headset in dusty or dirty area, and only use soft damp cloth to clean it.
- Do not place your headset near lit cigarettes, cigars or candles, or near open flames etc.
- Do not allow children to play with your headset, as they might injure themselves or others as well as your headset, and small parts of it may become a choking hazard.
- If you will not be using your headset for a while, store it in a place that is dry, free from damp, dust and extreme temperatures.

FAQ

Please refer to <http://www.gg2002.com>

Gg03 specification

Bluetooth compliance	Bluetooth version 1.2 with Headset profile and Handsfree profile
Bluetooth power	2.5mW (0.0025W)
Max. cordless distance	30 feet (10 meters)
Weight of headset	Gg03:21g / Gg03a:13g / Gg03v:21g
Standby time	Gg03:220 hours / Gg03a:150 hours / Gg03v:220 hours
Talk time	Gg03:8 hours / Gg03a:5.5hours / Gg03v:8hours
Normal re-charge time	1.5 ~ 2 hours
Battery type	Li polymer rechargeable battery

Note:

Talk time and standby time are varied according to different mobile phones.

Potentially explosive atmospheres

For safety reasons, Turn off your electronic device when surrounded by possible explosive atmosphere. It is rare, but your electronic device could generate sparks which can cause an explosion or fire. Areas with a potentially explosive atmosphere are often, but not always, clearly marked. Explosive atmosphere may include gas stations, fuel or chemical storage facilities, and in environment where metal powders, grain, dust are contained in the air.

Power supply

- Do not wear your headset when charging.
- Power supply must be connected to designated power sources as marked on the product.
- To reduce risk of damage to the electric cord, only remove it by grasping onto the AC adaptor rather than the cord itself from the outlet.
- Make sure the cord is well positioned to avoid potential damage.
- Before attempting to clean the AC power adapter, please unplug the unit from any power source to reduce risk of electric shock.

- The AC power adapter is designed for indoor use only, and must not be used outdoors.
- If the plug will not fit into the outlet, asking help from a qualified electrician. Improper connection can result in risk of electric shock.

Emergency calls

IMPORTANT!

You should never rely solely upon any electronic device for essential communications (e.g. 911 calls). Keep in mind that when making or receiving a call, your headset and the electronic device connected to must be switched on and in a service area with adequate cellular signal strength. Emergency calls can sometimes be disturbed on certain cellular phone networks or when certain network services and/or phone features are in use. Check with your local cellular service provider.

Battery information

- The rechargeable battery of your headset is not fully charged when it is new. For first time, please charge for 4 hours before using.
- When the rechargeable battery of your headset is low, there will be one battery low tone and the red indicator quickly flash twice every 5 seconds to alert the user.
- The rechargeable battery of your headset has a long service life if treated properly.
- One new battery, or one that has not been used for a long period of time, could have reduced capacity the first few times it is used.
- Use your headset in room temperature for maximum battery capacity.
- Do not expose your headset in an environment temperature above +55°C (+131°F). If your headset is operated in cold temperatures, the battery capacity is reduced.
- The battery can only be charged in temperatures between +10°C (+55°F) and +45°C (+113°F)

«Declaration of conformity»

FCC statement

This device complies with Part 15 of the FCC Rules. Operation is subject to the following two conditions.

1. This device must accept any interference received, including interference that may cause undesired operation.
2. This device may not cause harmful interference.

Federal Communications Commission (FCC) statement

15.21

You are cautioned that changes or modifications not expressly approved by the part responsible for compliance could void the user's authority to operate the equipment.

15.105(b)

This equipment has been tested and found to comply with the limits for a Class B digital device,

pursuant to part 15 of the FCC rules. These limits are designed to provide reasonable protection against harmful interference in a residential installation. This equipment generates, uses and can radiate radio frequency energy and, if not installed and used in accordance with the instructions, may cause harmful interference to radio communications. However, there is no guarantee that interference will not occur in a particular installation. If this equipment does cause harmful interference to radio or television reception, which can be determined by turning the equipment off and on, the user is encouraged to try to correct the interference by one or more of the following measures:

- Reorient or relocate the receiving antenna.
- Increase the separation between the equipment and receiver.
- Connect the equipment into an outlet on a circuit different from that to which the receiver is connected.
- Consult the dealer or an experienced radio/TV technician for help.

You are cautioned that changes or modifications not expressly approved by the party

responsible for compliance could void your authority to operate the equipment.

FCC RF radiation exposure statement:

This Transmitter must not be co-located or operating in conjunction with any other antenna or transmitter.

«Regulatory information»

Any modifications or changes (e.g. antennas) made to this headset that are not expressly approved by G.G. Telecom may void the user's authority to operate this headset. G.G. Telecom is not responsible for any radio or television interference caused by unauthorized modification of this headset. It is the responsibility of the user to correct any interference caused by such unauthorized modification. G.G. Telecom and its authorized resellers or distributors will assume no liability for any damage or violation of government regulations arising from failing to comply with these guidelines.

This manual is published by G.G. Telecom, without any warranty. The information contained in this document is subject to change without notice.
All rights reserved. **GG** Telecom

The  **Bluetooth** word mark and logos are owned by the Bluetooth SIG, Inc. and any use of such marks by G.G. Telecom is under license. Other trademarks and trade names are those of their respective owners.