

Installation and Operating Manual

BDA-PS8NEPS-37/37-90-C

Public Safety 800 MHz Band Bi-Directional Amplifier





Table of Contents

SAFETY OPERATION INSTRUCTIONS	3
OVERVIEW	4
FCC NOTE	4
IC NOTE.....	4
NOTE.....	4
RF EXPOSURE WARNING- FCC.....	4
RF EXPOSURE WARNING- INDUSTRY CANADA.....	4
ELECTRICAL SPECIFICATIONS	6
MECHANICAL SPECIFICATIONS	6
ENVIRONMENTAL CONDITIONS	6
MECHANICAL OUTLINE.....	8
CONNECTIONS	9
AVAILABLE, OPTIONAL FEATURES	10
ALARM CONDITIONS.....	11
VARIABLE GAIN ADJUSTMENT AND LED INDICATORS	12
INSTALLATION	13
OPERATION.....	14
DIAGNOSTICS GUIDE	15
ANTENNA SEPERATION.....	15
APPENDIX 1	16
APPENDIX 1	17
APPENDIX 2.....	18



SAFETY OPERATION INSTRUCTIONS

BEFORE USE

Review this manual and insure that all conditions are compatible with the amplifier's specifications. Safe operation may be impaired if this equipment is not used as intended.

GENERAL DESCRIPTION

This symbol is marked in the manual and denotes important safety operation instructions. Please read carefully before continuing.

This equipment is suitable for a wide variety of scientific, industrial, laboratory and communication applications where high levels of electromagnetic Radio Frequency (RF) energy are required. Therefore, the output of the amplifier must be terminated to an appropriate load, such as a high power attenuator, dummy load, a communication or radiation antenna. User must insure that radiated energy do not violate regulatory levels of electromagnetic interference.



PROTECTIVE GROUND

This symbol is marked on the equipment and denotes protective ground terminal.

This amplifier includes protective ground terminal. The equipment shouldn't be used if this protection is impaired. The supplied power cord must be used along with an uninterrupted external power source.

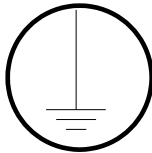

HAZARDOUS LINE AND RF VOLTAGES

This symbol is marked on the equipment where dangerous voltages are present. Use extreme caution.

Both RF input and output connectors should be terminated prior to the application of the external AC source. Otherwise, contact with the RF output center pin can be dangerous. Place the amplifier in the OFF position prior to connecting and disconnecting RF output load.



ELECTROSTATIC DISCHARGE (ESD)

This symbol is marked on the equipment where ESD sensitive devices are present. Do not handle without the proper protection.



MAINTENANCE

Maintenance, repair and calibration must be performed by qualified personnel only. Contact with the internal amplifier components maybe dangerous even when the equipment is in the OFF position.

CAUTION

This denotes a condition that may cause damage to the Amplifier if procedure is not correctly performed. Do not proceed until the indicated conditions are met.

FORCED AIR COOLING

Do not block the inlet and outlet of the internal cooling blowers. Otherwise damage may result to the amplifier.



OVERVIEW

The BDA assembly enhances the coverage area of radio communications in buildings and RF shielded environments.

The BDA has dual RF paths (Down-Link / Up-Link) to improve coverage in two distinct frequency bands.

The unit features low noise figure and wide dynamic range. It is based on a dual duplexed path configuration with sharp out of band attenuation allowing improved isolation between the receiving and transmitting paths.

BDA-PS8NEPS-37/37-90-C provides up to 37 dBm composite power and has up to 92 db gain.

FCC NOTE

This is a Class B device. The product has been tested and found to comply with the Booster requirements per FCC Part 90.

IC NOTE

The product has been tested and found to comply with the Industry Canada (IC) RF Exposure Requirements, pursuant to IC RSS-131.

NOTE

The Manufacturer's rated output power of this equipment is for single carrier operation. For situations when multiple carrier signals are present, the rating would have to be reduced by 3.5 dB, especially where the output signal is re-radiated and can cause interference to adjacent band users. This power reduction is to be by means of input power or gain reduction and not by an attenuator at the output of the device.

RF EXPOSURE WARNING- FCC

The ERP limit, as defined by the FCC is +37 dBm. In order to comply with the FCC RF exposure requirements, the antenna installation must comply with the following:

The Omni directional antenna (or leaky cable) must be installed so as to provide a **minimum** separation distance of at least 29.9 cm (~11.8 inches) between the antenna connected to the RF booster and the human user's body within the area. (This assumes an antenna with gain of 0 dBi, VSWR \leq 2:1, Zo= 50 ohms and a cable attenuation less than 1dB).

Should user choose to utilize a higher gain antenna (greater than 0 dBi) with the system, attenuation of the BDA's gain will be required to meet FCC ERP limit of +37 dBm.

RF EXPOSURE WARNING- INDUSTRY CANADA

In order to comply with the IC RF exposure requirements, the antenna installation must comply with the following:

For 0 dBi gain antenna: The antenna must be installed so as to provide a **minimum** separation distance of at least 39.5 cm (~15.6inches) between the antenna connected to the RF booster and the human user's body within the area. (VSWR \leq 2:1, Zo= 50 ohms and a cable attenuation less than 1dB).

For 10 dBi gain antenna: The antenna must be installed so as to provide a **minimum** separation distance of at least 124.9 cm (~49.2 inches) between the antenna connected to the RF booster and the human user's body within the area. (VSWR \leq 2:1, Zo= 50 ohms and a cable attenuation less than 1dB).

Refer to Figure 1 for the following discussion.

The downlink path of BDA receives RF signals from the base station, amplifies the signal and transmits the signal, without changing the frequency, into a Distributed Antenna System at the direction of the mobiles. The signal travels over a DAS medium that then dissipates the signal to the Mobile subscribers. The uplink path receives RF signals at the Mobile side from the DAS system, then amplifies it, and transmits the amplified signal (without changing the frequency) to the base station.

This BDA supports Uplink and Downlink, PS 800 occupy distinct dedicated frequency bands.

The diplexer isolates the paths and route each signal to the proper amplifying channel.

An Automatic Level Control (ALC) allows for output power limiting. A variable step attenuator gives 0 – 30 dB of attenuation in 2 dB steps. The use of these controls is covered in the “OPERATION” section, later in this document.

BLOCK DIAGRAM DESCRIPTION

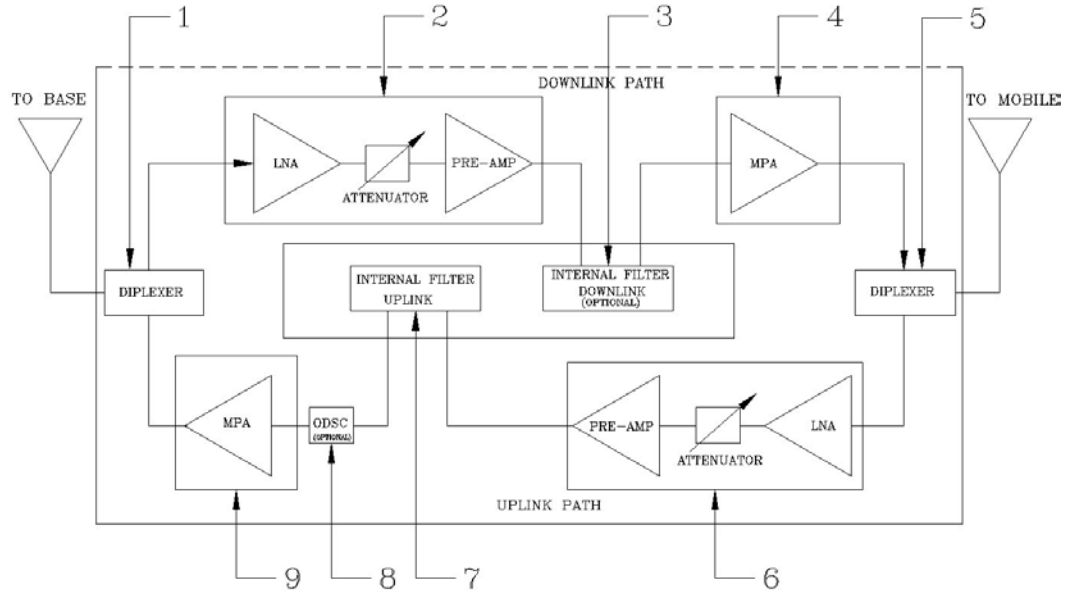

Figure 1: Block Diagram

1. Diplexer – Separates/Combines UL and DL pass bands, provides needed isolation and selectivity to support system gain.
2. Downlink Low noise amplifier and driver. Exhibits low noise figure and high linearity.
3. Downlink Filter – High selectivity filter gives additional rejection for increased isolation.
4. High linearity Downlink power amplifier with an ALC circuit..
5. Diplexer – Separates/Combines UL and DL pass bands, provides needed isolation and selectivity to support system gain.
6. Uplink Low noise amplifier and driver. Exhibits low noise figure and high linearity.
7. Uplink Filter – High selectivity filter gives additional rejection for increased isolation.
8. Module that detects oscillations in the system due to insufficient Donor and Mobile Antenna (optional).
9. High linearity Up Link power amplifier with an ALC circuit.



ELECTRICAL SPECIFICATIONS

Down-Link Frequency Range	851-862 MHz
Up-Link Frequency Range	806-817 MHz
Pass band Gain @ Min. attenuation	Up to 92 dB
Variable Step Attenuator Range 2-dB steps	0-30 dB
Maximum Input Signal Level	-30 dBm
Input/Output Impedance	50 Ohms
VSWR (Input/Output)	<1.5: 1
Power Supply @ 37dbm unit	110VAC/1..2Amps
	220VAC/0.6Amps
	50 to 60 Hz

Composite Output Power	25 dBm	27 dBm	33 dBm	37 dBm
Gain Flatness [dB]	± 1.5	± 2.0	± 1.5	± 1.5
Noise Figure [dB]	5.0 (Max.) 4.5 (Typ.)	5.0 (Max.) 4.5 (Typ.)	5.0 (Max.) 4.5 (Typ.)	5.5 (Max.) 5.0 (Typ.)
Output Power ALC Set [dBm]	UL: +25 ±1 DL: +25 ±1	UL: +27 ±1 DL: +27 ±1	UL: +33 ±1 DL: +33 ±1	UL: +37 ±1 DL: +37 ±1
3rd Order Intercept Point [dBm]	UL: +46 (Typ.) DL: +46 (Typ.)	UL: +48 (Typ.) DL: +48 (Typ.)	UL: +51 (Typ.) DL: +51 (Typ.)	UL: +55 (Typ.) DL: +55 (Typ.)

MECHANICAL SPECIFICATIONS

May vary per unit, see spec for more accurate information

Size	14" x 6.7" x18.1"
RF Connectors	N-Type Female
Weight	37.8 lb.

ENVIRONMENTAL CONDITIONS

The unit is designed for indoor applications:

Operating temperature: - 20°C to +55°C

Storage temperature: - 40°C to +85°C



Optional Battery Back-Up Configuration

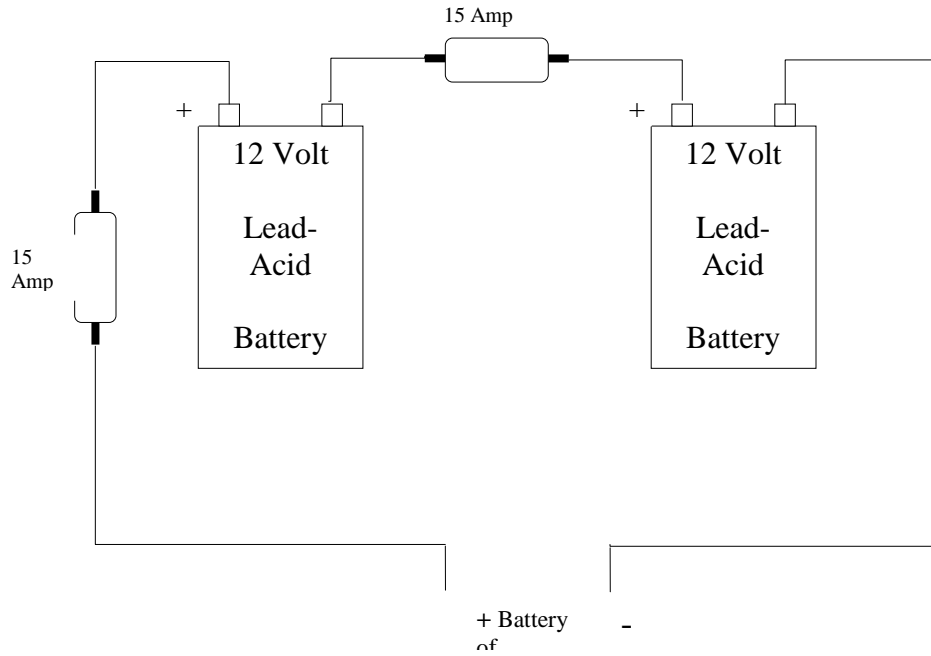

Figure 2: Optional Battery Back-Up Configuration

Output Composite Power	Typical DC Current Draw @24VDC [A]	Battery Back-Up Time [Hours]	Recommend Battery Rated Capacity (20 Hour Rate) [Amp Hours]
37 dBm	3.55	4	17.75
		8	35.5
		12	53.25
		24	106.5
33 dBm	2.47	4	12.35
		8	24.7
		12	37.05
		24	74.1
31 dBm	2.35	4	11.75
		8	23.5
		12	35.25
		24	70.5
27 dBm	2.1	4	10.5
		8	21
		12	31.5
		24	63

Note: We do not guarantee specifications under Battery Back-Up power.

MECHANICAL OUTLINE

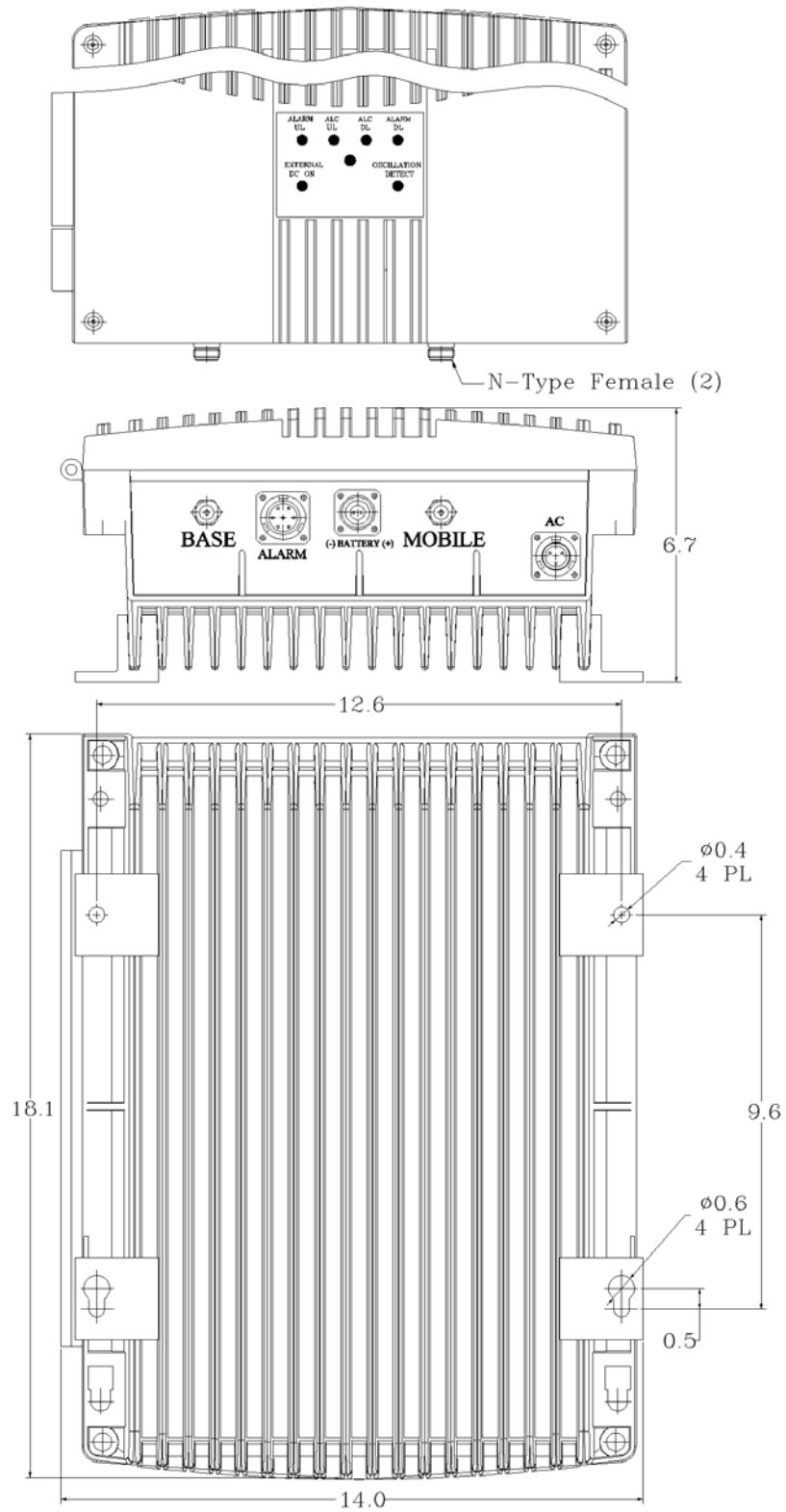

Figure 3: Mechanical Outline



CONNECTIONS

The RF connections are made via two “N-type” female connectors. The RF connector labeled “BASE” must be connected to the antenna pointing towards the base station. The RF connection labeled “MOBILE” must be connected to the antenna / passive DAS facing the area to be covered by the BDA.

The RF connections must be made through cables with characteristic impedance of 50 ohms.

The BDA AC power is accepted through a standard 3-wire male plug (IEC-320) with phase, neutral and ground leads. The AC power is wired to a high efficiency DC switching power supply which is CE and UL approved. The power supply runs the amplifiers and the LED indicators. The metal enclosure of the BDA is connected to ground.

Additional monitoring connectors are available as described in the “Features” section.



Figure 4: Front Panel Connections



AVAILABLE, OPTIONAL FEATURES

The following options are available, (please review the specification provided with the unit, to verify the features included in your BDA)

- **Visual Alarms**

All G-Wave systems include local visual alarms as a standard. Local visual alarms are LED lights located in the unit that indicate various failures. For a list of corresponding alarms, please see Variable Gain Adjustment and LED Indicators.

- **DC Input Power Option (S1)**

The BDA is equipped with both AC and DC voltage inputs for power operation. This gives the flexibility of powering the BDA with either an AC or DC source. If both sources are connected, the BDA will automatically select the stronger voltage source for power. (See page 7 for Current Draw calculations)



- **Local Alarming via dry contact 7-pin Connector (RM7)**

A 7-Pin dry contact will be provided to hard wire into a building's alarm system. Dry contact will provide alarms for ALC and amplifier failure.



- **Local Alarming via dry contact 26-Pin Connector (026)**

A 26-Pin dry contact will be provided to hard wire into a building's alarm system. Dry contact will provide alarms for ALC, amplifier failure, donor antenna failure and DC backup failure. (See details in appendix 1)



- **Oscillation Detector and Shutdown - ODSC / ODSCRM7**

To minimize interference with other RF systems, this unit includes an Oscillation detection module that continuously monitors the BDA operation, in a case of Oscillation detection inside the BDA, the detector will shut down all the amplifiers to avoid RF interference with other systems in the area, when the Oscillation condition passes or is resolved, the ODSC operation will turn on all the amplifiers, returning to regular operation. The ODSCRM7 module will allow Oscillation detect / display & shutdown of all amplifiers with local alarming via dry contact connector. A red LED located on the LED panel (See Figure 5) illuminates when oscillation is detected.





AVAILABLE, OPTIONAL FEATURES (Cont.)

- **DC28**
Powered DC Only @ + 28 VDC
- **LGHT**
Lightning Protection on UL/DL Ports
- **RED -**
Red Enclosure to signify equipment is for public safety. Please verify your local requirements.
- **ACSP**
AC Surge Protection and DC Line Conditioning (Required if powered by generator)
- **LATCH**
A door latch to be included on NEMA 4 door of the "N" enclosure, enabling user to implement a pad-lock, ensuring a tamper-proof system.
- **D**
A cannon type AC connector, prohibits an individual from accidentally pulling AC cord from unit as well as providing additional protection against direct water.

ALARM CONDITIONS

The alarm monitors the current of both the uplink and downlink amplifiers. An alarm condition will occur if either the uplink or downlink amplifiers are over or under its current tolerance.

Additionally, each failure/alarm/indicator from the available features may be monitored via an audible alarm dry contact connector, 3 contacts per each alarm. The following diagram shows a Non Alarm condition. If an alarm occurs the trigger will switch the position of the relay, a short will be between COM and N.C.

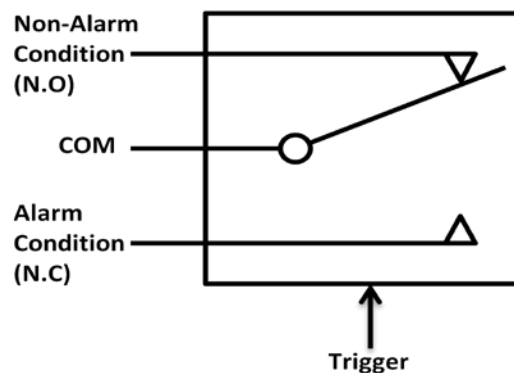

(Relay Shown in Non-Alarm Condition)

VARIABLE GAIN ADJUSTMENT AND LED INDICATORS

- AC Power LED - Illuminates when the AC voltage is supplied, the unit is ON, and the AC/DC power supply is operating.
- DL ALC LED - Illuminates when DL composite power reaches the ALC set
- DL Alarm - Illuminates when the DL amplifier fails.
- UL ALC LED - Illuminates when UL composite power reaches the ALC set.
- UL Alarm - Illuminates when the UL amplifier fails.
- External DC LED (optional) - Illuminates when the BDA is operating from a DC source.
- Oscillation detection LED (optional) - Illuminates when oscillation is detected.
- Donor antenna alarm LED (optional) - Illuminates when Donor Antenna is disconnected.
- Mobile antenna alarm LED (optional) - Illuminates when the mobile port is disconnected.
- DL Manual Gain Attenuator- Is a switch used for DL gain attenuation
- UL Manual Gain Attenuator- Is a switch used for UL gain attenuation

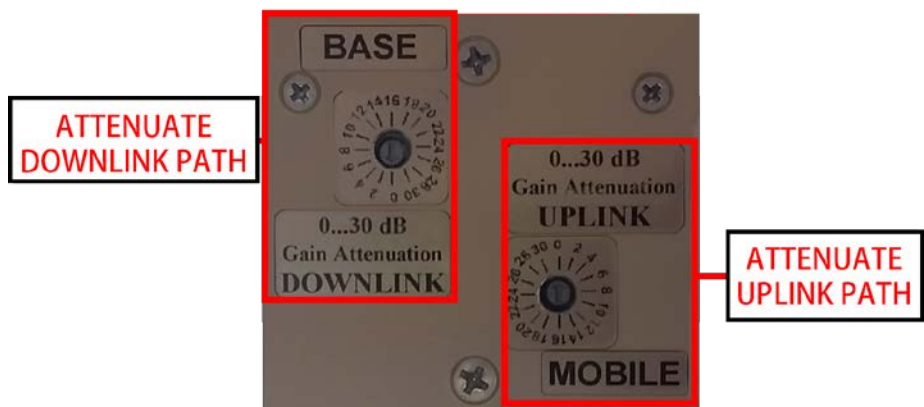
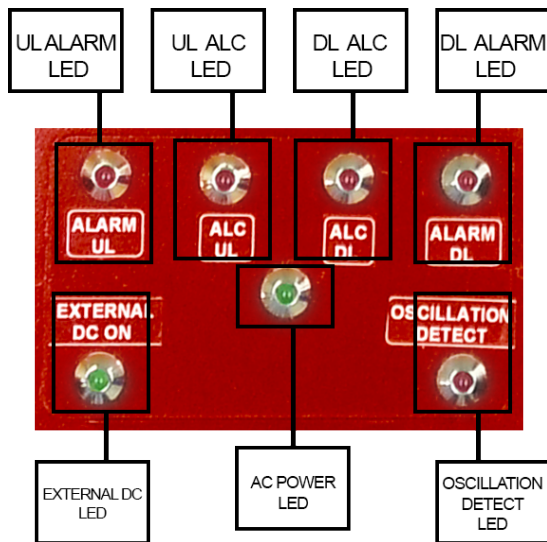

Figure 5: External LED Indication and Manual Gain Attenuation Access



WARNING. This is NOT a CONSUMER device. It is designed for installation by FCC LICENSEES and QUALIFIED INSTALLERS. You MUST have an FCC LICENSE or express consent of an FCC Licensee to operate this device. You MUST register Class B signal boosters (as defined in 47 CFR 90.219) online at www.fcc.gov/signal-boosters/registration. Unauthorized use may result in significant forfeiture penalties, including penalties in excess of \$100,000 for each continuing violation.

INSTALLATION

DO NOT APPLY A.C. POWER TO THE UNIT UNTIL CABLES ARE CONNECTED TO BOTH PORTS OF THE BDA AND THE ANTENNAS.

1. Set the BDA on the floor or mount on a wall (where applicable). Using appropriate screws and anchors, attach the BDA to the wall at the four mounting holes on the side flanges. (Special version not shown in this manual).
2. Ensure that the isolation between the base station antenna and the mobile antenna should be at least **12 dB higher than the BDA gain** (Use the higher of the Uplink and Downlink gains reported on the BDA test data sheet).
Isolation less than this value can cause gain ripple across the band. Isolation equal to or less than the BDA gain will give rise to oscillations which will saturate the amplifiers and possibly cause damage to the BDA.
3. Connect the cable from the donor antenna to the BDA connector labeled “BASE” and the cable from the service antennas to the BDA connector labeled “MOBILE”.
4. See main Panel of the BDA and verify that both of the Uplink and Downlink attenuation is set to 30 dB via dial Attenuator.
5. Connect the AC power cord to the BDA and then to the power source. Verify that the “Power ON” lamp is illuminated.

Installation of the BDA is now complete. To adjust the gain controls to suit the specific signal environment, refer to the next section of the manual.

Note: For repeat installations of existing equipment, make sure the attenuation is positioned to its maximum setting (30 dB). After verification attenuation, follow the above steps starting with step 1.



OPERATION

Refer to Figures 4,5 for adjustment access location, connectors and labels.

Variable Step Attenuator

BDA gain that indicated in the spec can be reduced by up to 30 dB in 2 dB steps using the variable step attenuator. Gain adjustment is made with rotary switches located inside the BDA enclosure. Arrows on the shafts of these switches point to the value of attenuation selected. BDA gain can be determined by subtracting the attenuation value from the gain reported on the BDA Test Data Sheet for that side of the unit. The attenuators are labeled for Uplink and Downlink.

ALC (Automatic Level Control)

To minimize intermodulation products, each amplifier in the BDA contains an ALC feedback loop. The ALC circuit senses the output power and limits it to the factory preset level, as indicated in the specification.

ALC function is located in each power amplifier. A red LED indicator located inside the BDA enclosure (see figure 5) illuminates when output power meets or exceeds the ALC preset point.

To establish proper operating gain on the Uplink and Downlink paths, begin with the Downlink. Observe the red LED indicator labeled DL ALC. Units are shipped from the factory with maximum attenuation (30 dB). Decrease attenuation one step at a time (each step is 2 dB) until the red LED (DL ALC) is lit. Then, using the Downlink step attenuator, increase the attenuation until the red LED goes off. Repeat the process for the Uplink. This setup should be done under RF signal transmit for either path the level indicator is accurate to +/- 0.4 dB of the ALC set point.

Verify the downlink in-building signal strength and the uplink signal strength at donor antenna meets requirements. Reduce the gain if needed (increase attenuation).



Note: Operation of BDA-PS8NEPS-37/37-90-C at maximum gain with greater than -30 dBm average power incidents on the MOBILE or BASE ports could cause damage to the BDA.

WARNING:
**Input Signal Level
above - 30 dBm may cause
damage to system**



DIAGNOSTICS GUIDE

The BDA provides long term, care-free operation and requires no periodic maintenance. There are no user-serviceable components inside the BDA.

This section covers possible problems that may be related to the installation or operating environment.

Gain Reduction

Possible causes: Defective RF cables and RF connections to antennas, damaged antenna or Leaky cable.

Occasional Drop-out of some Channels

Possible causes: One channel with very strong power dominates the RF output of the amplifier.

Excessive Intermodulation or Spurious

Possible causes: Amplifier oscillation caused by insufficient isolation between two antennas. See antenna separation paragraph below.

ANTENNA SEPERATION

BDA oscillation is caused by low isolation (antenna separation) between donor antenna and service antennas. The recommended isolation between those antennas is 15db above the system gain. The amount of isolation that can be achieved between antennas depends on several factors, such as the physical vertical and horizontal separation (distance between the antennas), polarization, radiation pattern of the antennas, the medium between the antennas, antenna gain etc.

Antenna isolation can most accurately be determined through on-site measurements An antenna isolation measurement configuration is illustrated in Figure 6, where two spatially separated antennas (service antenna #1 and donor antenna #2) are connected to a signal generator and signal analyzer.

A signal at center frequency is generated by the signal generator sent to the input of antenna 1; the output of the signal at antenna 2 is measured and recorded by the signal analyzer. With calibrated connection cables, by taking into account the cable loss, the difference of signal power level at the output of antenna 2 and that at the antenna 1 input is taken as antenna isolation.

(See Appendix 2 for analytical calculation)

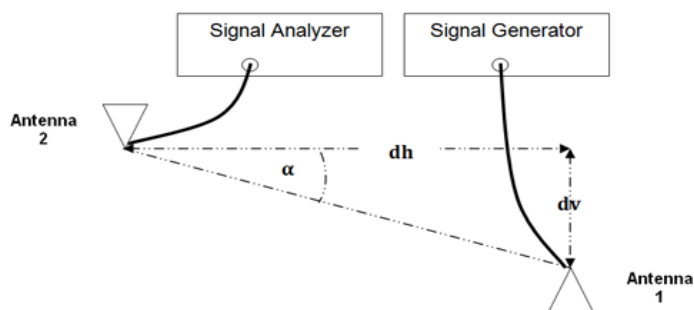
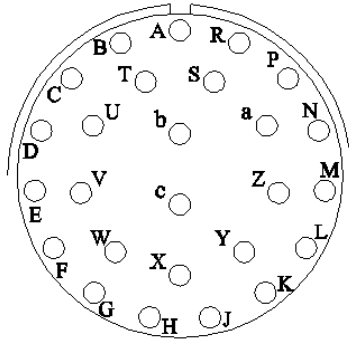

Figure 6

APPENDIX 1

26-Pin Connector

PIN OUT NFPA O26



PIN #	DESCRIPTION
A	1-NO DL/UL Current Alarm
B	1-COM DL/UL Current Alarm
C	1-NC DL/UL Current Alarm
D	2-NO Donor Antenna Alarm
E	2-COM Donor Antenna Alarm
F	2-NC Donor Antenna Alarm
G	3-NO DC Backup Alarm
H	3-COM DC Backup Alarm
J	3-NC DC Backup Alarm
K	4-NO Mobile Antenna Alarm
L	4-COM Mobile Antenna Alarm
M	4-NC Mobile Antenna Alarm
N	GND
P	GND
R	+12 VDC 200mA
S	+12 VDC 200mA (STNB)

Mobile Antenna Failure contacts are not standard in the O26 pin-out and must be requested at time of order to be included.

Conditions for Donor Alarm (26-pin)

This functionality applies only for a Donor antenna with a DC short. Alarm monitors the connection of the BDA to the donor antenna. An alarm condition will occur if there is a disconnect at the donor antenna. Uplink and Downlink amplifiers will shut down. Donor Alarm, Current DL, and Current UL will indicate.

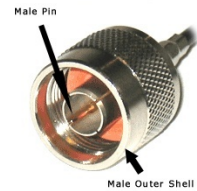

Test for DC short between male pin and outer shell of antenna connectors

Figure 7a

If the donor antenna does not short please connect G-Way's special Donor Short Simulator.

Please note, if you intend to use other components (i.e. Lightning Protector) between the base port and donor antenna make sure they have an open short.



N Type Female/Female Donor Short Simulator N Type Male/Female Donor Short Simulator

Figure 7b

Conditions for DC Backup Alarm

The alarm monitors the AC power. If the AC power fails and DC is connected, the DC Alarm LED will indicate DC power.

Conditions for Mobile Alarm *OPTIONAL

The alarm monitors mobile antenna conditions to the VSWR. In poor conditions, Mobile Alarm and Current UL will indicate.

APPENDIX 1

O26 Alarm Block Diagram

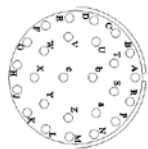
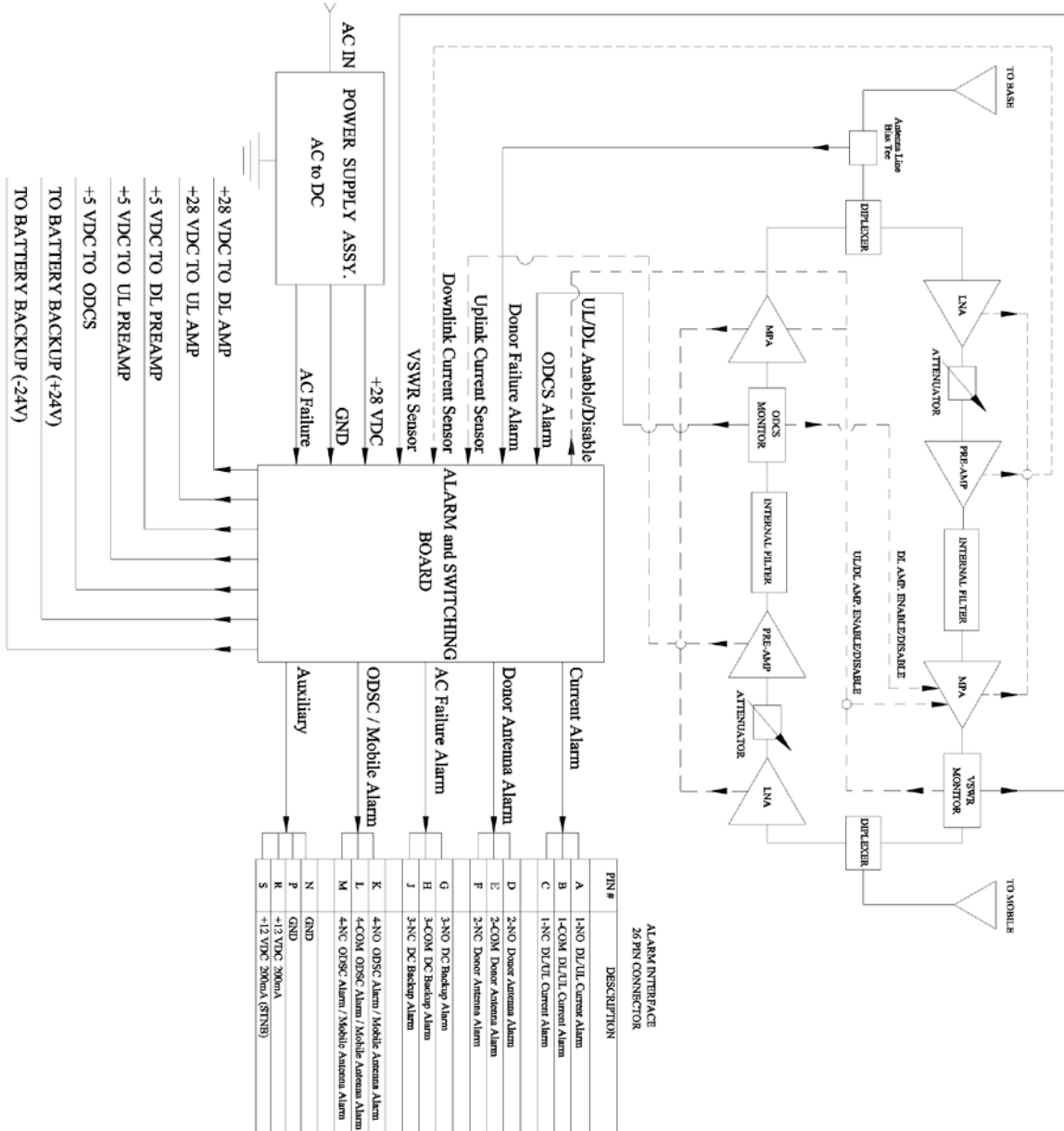

PIN OUT NPPA O26



APPENDIX 2

The horizontal I_h and vertical I_v space antenna isolation for a scenario as in Figure 6 can be computed analytically, using the following equations:

$$I_h [\text{db}] = 22 + 20 \log \left(\frac{dh \cdot f}{3 \cdot 10^8} \right) - GT_x - GR_x$$

*Under assumptions of far field condition)

$$I_v [\text{db}] = 28 + 40 \log \left(\frac{dv \cdot f}{3 \cdot 10^8} \right) - GT_x - GR_x$$

$$I_{\text{slant}} [\text{db}] = (I_v - I_h) \cdot \frac{\alpha}{90^\circ} + I_h$$

Antenna Separation variable definitions:

I_h [dB]	isolation between horizontally separated transmitter and receiver antennas
dh [m]	the horizontal distance from the centre of interferer antenna to that of the interfered with receiver antenna
dv [m]	the vertical distance from the interferer antenna to the interfered with receiver antenna, (measured from radiation center-to-radiation center)
f [Hz]	the wavelength of the interfered with system frequency band
GT_x [dBi]	gain of the transmitter antenna
GR_x [dBi]	gain of the receiver antenna
I_v [dB]	Isolation between vertically separated transmitter and receiver antennas.
α [°]	$\arctan\left(\frac{dv}{dh}\right)$