

GDU O₂

O₂ / O₂Plus / O₂X

User Manual V1.0



Contents

Features	4
Slide Arm technology	4
Stabilized Video and Photo Camera System	4
HD Video Transmission	4
Smart Lock Prop	4
Vision position System	5
User Instructions	5
Warning	5
Get To Know O ₂	5
GDU Mini App Download	6
Product Registration	6
UAV Legal Registration	6
Safety Overview	6
Product Overview	7
Aircraft and Remote controller Preparation	7
Aircraft Part Diagram	8
Remote controller Part Diagram	9
Aircraft	10
Aircraft Status Indicator	10
Flight Mode	11
Automatic Return Home	11
Vision Position System	13
Smart Flight Function	15
Propellers	19
Battery	20
Remote controller	23
Prepare the Remote controller	23
Mobile Phone Installation	24
HD Video Transmission System	25

Gimbal Camera.....	25
Aircraft Control.....	26
Frequency Matching.....	27
Flight Mode Selection.....	27
Upgrading the Remote controller.....	28
Gimbal Camera.....	28
Camera Overview.....	28
Gimbal Overview.....	29
GDU Mini App.....	29
Drone.....	30
Media.....	35
Explore.....	37
Me.....	38
Flight.....	39
Preflight Check.....	39
Magnetometer Calibration.....	39
General Flight Operations.....	41
Technical Parameters.....	43
Certification Information.....	45

Features

Slide Arm technology

The aircraft's slided arms and folding landing pad and blade are designed to form a functional and portable structure without sacrificing strength or flexibility.

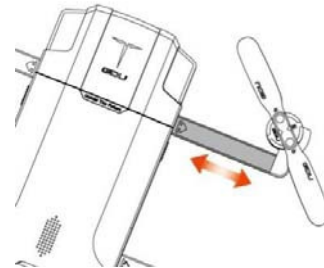

Stabilized Video and Photo Camera System

Using new integrated control algorithms and high-precision three-axis stabilization design, 4K ultra-high-definition videos and 13,000,000-pixel photos can be taken on a stable platform, offering excellent photographic effects and recording experiences.



HD Video Transmission

The aircraft is equipped with a HD transmission module for real-time transmission of HD videos and photography. The transmission range is 1km for O₂ products and 7km for O₂Plus products



Smart Lock Prop

In order to fully protect your safety, the propeller of the GDU O₂ series enjoys dual protection. Designed with

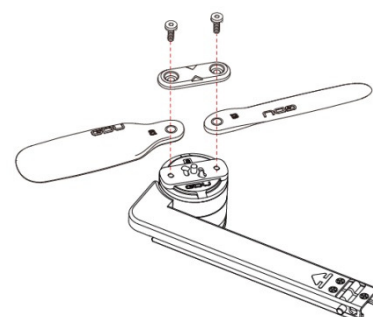

2 small set screws and a second proprietary locking mechanism, the props on the O₂ will ensure they stay secured during flight.

Vision position System

Our advanced forward and downward is onboard the GDU O₂ series, thus achieving intelligent obstacle avoidance, follow me, vision circle, and gesture shot. With the powerful vision system, the aircraft is made more intelligent.

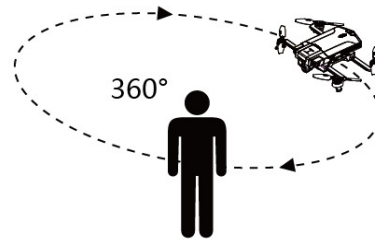

User Instructions

Warning

Thank you for using this GDU product. Improper operation of any special electronic products may result in damages, personal injury and even death, and the user should bear the legal consequences of these actions. The product must not be used by juveniles under the age of 18. In order to ensure a positive operating experience and to protect your personal safety, please carefully read the following documents before use.

“Disclaimer”

“List of Items”

“User Manual”

“Quick Operations Guide”

“Battery Safety Guide”

“Daily Maintenance Manual”

※The parameters in the documents only represent the delivery status. The actual parameters will prevail.

Get To Know O₂

In addition to this document, GDU also provides a basic instructional video.

You can log in to the official website at <http://www.gdu-tech.com/cn/> or by scanning the QR code below to access and view the teaching video, which will give you an intuitive understanding of how to use the product. It is recommended to watch the teaching video in a WIFI-supported environment.



GDU Mini App Download

For an optimal operating experience, please download the GDU Mini App by logging on the official website www.gdu-tech.com or by scanning the QR code below, and then install the GDU Mini App.



※ Please either use the IOS8.0 or Android5.0 or above to install the GDU Mini APP.

Product Registration

To ensure complete after-sales services, please log on to the official website www.gdu-tech.com and register your product. Registration will not affect your normal use of the product, but it is recommended to promptly complete registration to become a GDU member. You can obtain the latest official event information and occasional promotional information as recommended by GDU.

UAV Legal Registration

As per the *Provisions on Real-time Registration Management of Civil Unmanned Aerial Vehicles* of the Civil Aviation Administration of China, all UAV owners must register their real name and fill any related information at time of purchasing their UAV in the official government UAV registration system (<http://uas.caac.gov.cn>), and paste the registration mark on the hull of the UAV.

※ The personal information of the user will be kept strictly confidential after registration.

Safety Overview

1. Environmental Requirements

- Do not use the aircraft under severe weather conditions such as rain, lightning, heavy winds, heavy fog, dust and extreme cold.
- Signals will be blocked by buildings, trees, and other environmental obstructions resulting in possible GPS positioning failure or control disconnection. Please only use the product in open spaces.
- Please use the product only within your own visual range, and avoid any obstacles, people, water, etc.

- Do not use the product in proximity to high-voltage communications towers, in order to prevent interference with remote controller signals.
- Be careful when using the product at altitudes of 4000m, or as performance is greatly reduced and aircraft could be dangerous to operate.
- Please only use the product in legally permitted areas.

2. Operating Instructions

- Do not call or answer the phone while product is in flight. Pay close attention to the GDU Mini App interface to ensure a safe flight.
- After receiving a low power alert signal, please return and land as soon as possible.
- The aircraft will be forced to return upon receiving an emergency low power alert. Please control the aircraft to allow it to land into a safe place.
- After landing, first turn off the aircraft's power supply, then conduct any other operations.
- Do not stop the motor in mid-flight except in case of emergency, in order to prevent any injuries caused by the falling aircraft.
- The propellers are dangerous when rotating at high speed. Please keep a safe distance from the aircraft in order to ensure your safety.

3. Maintenance

- Please replace the battery promptly in the case the battery exhibits damage, bulging or leakage.
- If the motors produce abnormal sounds, this may be caused by bearing wear. Please replace the motor by contacting Customer Support.
- Promptly replace any deformed or damaged propeller blades.
- Keep the gimbal camera lens clean. Only use the special cleaning kit to wipe it.

Product Overview

Aircraft and Remote controller Preparation

1. Remove the cover from the aircraft.

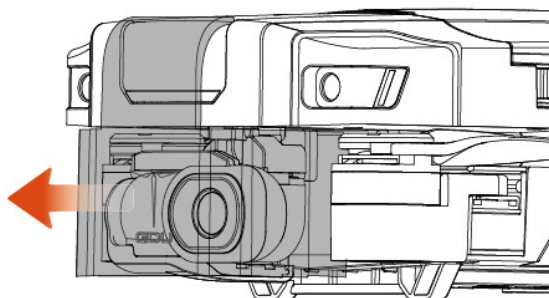

- ※ The cover is used for protecting the equipped gimbal camera. Confirm that the holder cover has been removed before using the aircraft.
 - ※ It is recommended to install the holder cover to protect the gimbal camera whenever the aircraft is not in use.
2. Pull out each of the aircraft arms to the limit mark, and fully unfold the propellers and landing feet to completely.

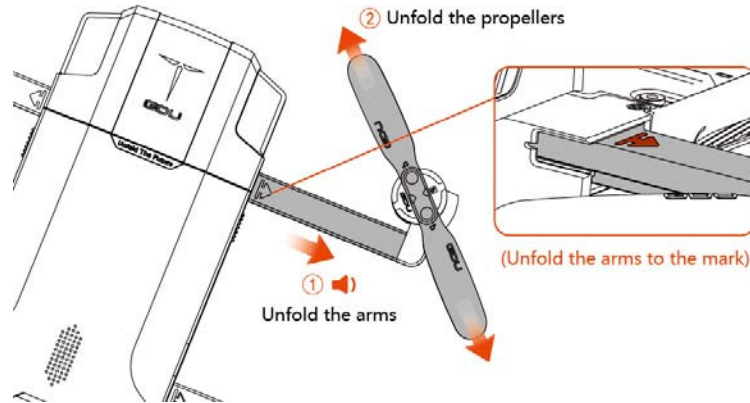

- ※ While extending the arm, Be sure to pull firmly and carefully and do not extend past limit marks.
- ※ While retracting the arm, Firmly push the arm back to the proper position, while being sure to guide props into their grooves, until the clicking sound is heard.

3. Correctly position the remote controller antennae.

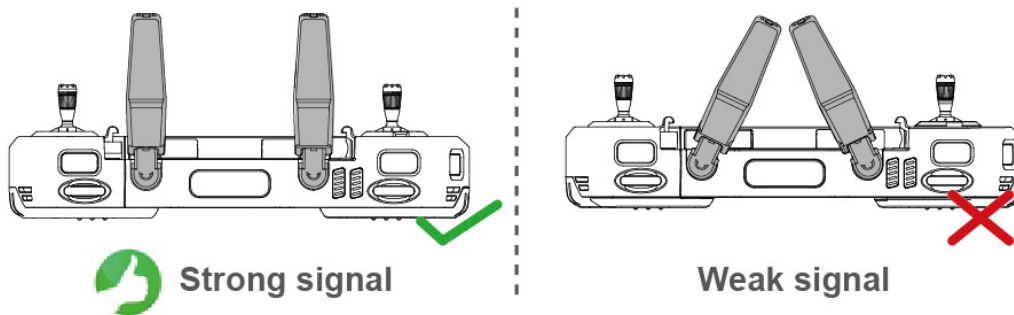

Aircraft Part Diagram

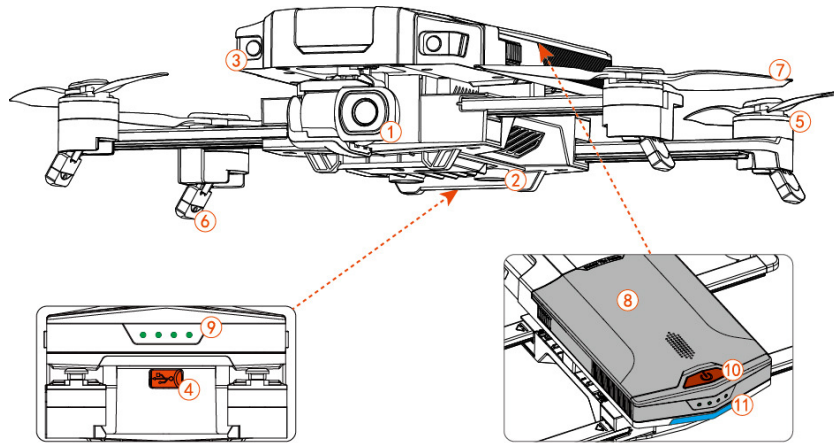

1. 3 axis Stabilized Camera	7. Propellers
2. Downward vision system	8. Battery
3. Forward vision system	9. LED Battery Level Indicator
4. Parameter/data adjustment interface (MicroUSB)	10. Power Button
5. Motors	11. Aircraft Status indicator (and orientation) lights
6. Tripods	

Remote controller Part Diagram

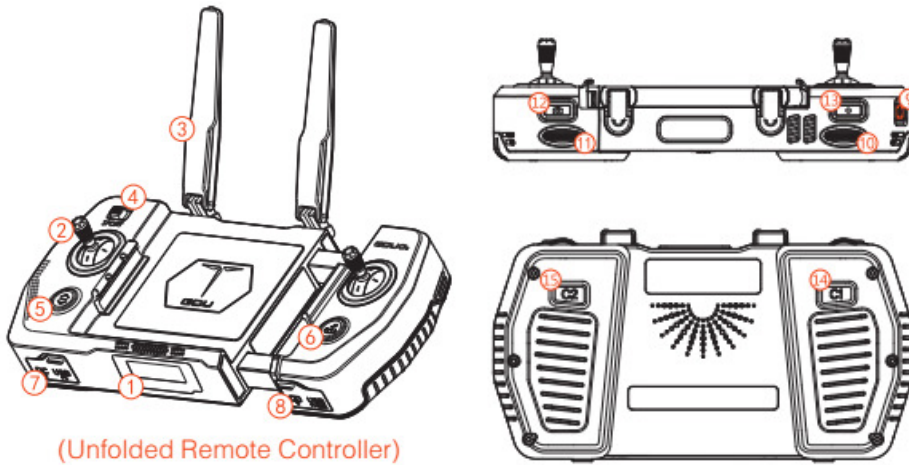

1. Status display	9. Power button
2. Stick	10. NA
3. Antenna	11. Camera Pitch dial

4. Flight mode switch	12. Camera button
5. One-button Take-off	13. Video button
6. RTH (Return to Home) Button	14. Custom function button C1
7. USB update, debugging, and charging interface	15. Custom function button C2
8. Micro USB slot	

Aircraft

Aircraft Status Indicator

The flight status of GDU O₂ series aircraft is shown according to the tail indicator.

Definitions of Flight Status Indicators		
	Status Description	Tail Indicator
Self-check after startup	Self-check process	● OFF - none
	Self-check failure	⦿ Red - flashing quickly
	Self-check success (connection)	● Green - ON
	Self-check success (not connected)	● Red - ON
Normal status	Standard mode	● Green - ON
	Sport mode	○ Green - flashing slowly
	Return mode	⦿ Green - flashing quickly
Magnetometer calibration	Calibration start	● Yellow - ON
	The aircraft did not remain horizontal	⦿ Yellow - flashing quickly
	Calibration success in horizontal direction	⦿ White - flashing quickly
	Calibration of the vertical direction	○ White - ON
	Success of magnetometer calibration	● Green - ON
Abnormal status	Low power	○ Red - flashing slowly
	Severe low power	⦿ Red - flashing quickly
	Loss of connection with remote controller	● Red - ON
	Close to NFZ (No Fly Zone)	⦿ Yellow - flashing quickly
	NFZ (No Fly Zone)	⦿ Red - flashing quickly
	Vision position ineffective	⦿ Red/yellow - flashing quickly

Flight Mode

The GDU O₂ series product supports two flight modes:

1. Standard mode (maximum flight speed: 5m/s)

Accurate hovering and smart flight can be achieved through the use of the GPS module and vision position system.

If the GPS signal is strong, the aircraft will be positioned through GPS;

If the GPS signal is too weak, and the light levels meet the needs of the vision position system, then the aircraft will be positioned through the vision position system;

If the GPS signal is weak and the light condition do not meet the needs of the vision position system, the aircraft will not hover accurately, and the GDU Mini App will prompt the user to land.

2. Sport mode (maximum flight speed: 15m/s)

The aircraft will hover accurately using the GPS module. The maximum flight speed can be increased by adjusting the aircraft control sensitivity.

Attention! If the sport mode is selected during the flight process, the forward vision system will automatically shut down, and the aircraft will cease actively braking and avoiding obstacles. The user must pay attention to the surrounding environment and control the aircraft to avoid obstacles along the flight route.

Attention! The flight speed and landing speed of the aircraft will be higher in sport mode than in standard mode, so the braking distance will significantly increase. In a windless environment, the user should reserve a braking distance of 30m at least to ensure flight safety.

Attention! The control sensitivity of the aircraft will be significantly improved in sport mode. The aircraft will respond strongly and fly far in response to even minor operations of the remote controller. In actual flight situations, the user should ensure sufficient flying space to ensure flight safety.

Automatic Return Home

The GDU O₂ series product has the function of automatic return home in three modes, i.e. “Automatic return home”, “Low power return” and “Communication loss return.”

If a return point has been recorded successfully before takeoff, the aircraft will automatically return and land in the takeoff area once the user triggers automatic return home mode, low power return mode, or communication (between the remote controller and aircraft) loss control mode.

The return point, also known as the HOME point, is defined as the valid GPS coordinates recorded at the time of takeoff or when flight conditions enjoy strong GPS signals. A return point is valid only for the current flight.

When automatic return is triggered, if the aircraft is within 20m to return point and the height of aircraft is less than 5m, aircraft will rise to the height of 5m and return; if the height of aircraft is

higher than 5m, the aircraft will return at the current height.

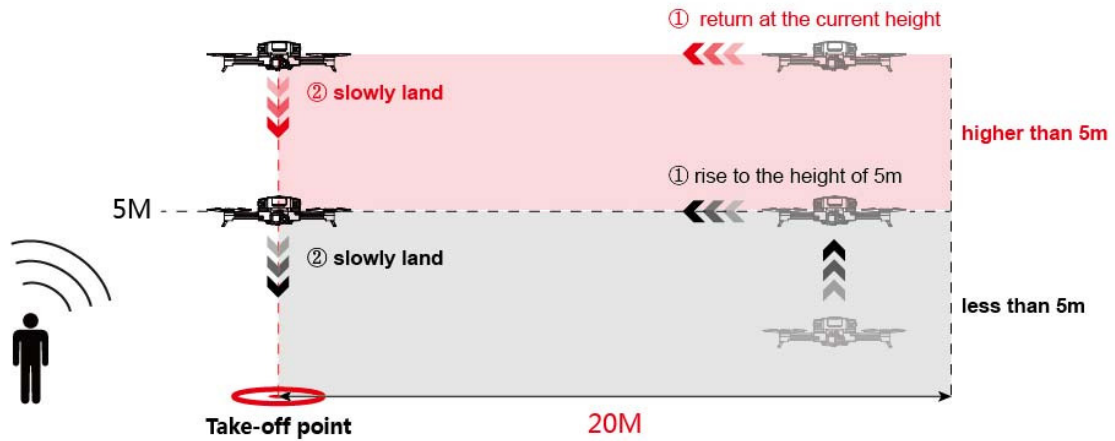

If the aircraft is over 20m away from the return point, the aircraft will rise to the preset height (if the current height is above the set height, the aircraft will fly at the current height), fly directly above the return point, and then slowly land.

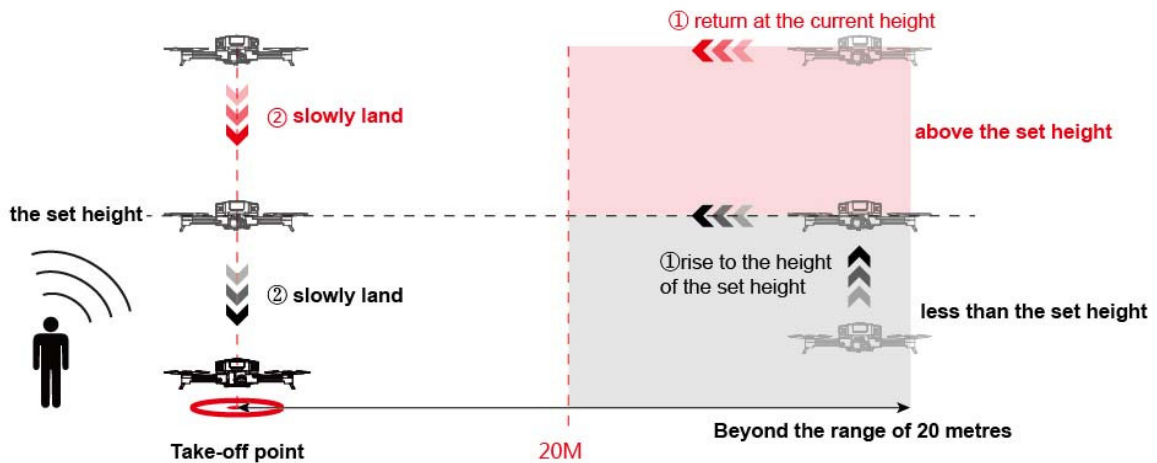

※ Please set the return height in the flight setting interface of the GDU Mini App.

1. Automatic return home

Automatic return can be triggered during the flight process by pressing the “Return” button on the remote controller or by clicking “” in the GDU Mini App interface. During the return process,

the user can press the “Return” button or click “” in the GDU Mini App interface to exit the return cycle and regain active control.

2. Low power return

Three mechanisms are provided: low power alarm, low power return and emergency low power landing.

- **Low power alert**

If the remaining power is 30% or less of total power, the low power alert will be triggered, the red indicator will flash slowly, and the GDU Mini App will remind the user of the low power levels.

- **Low power return**

If the remaining power is 20% or less of total power, the red indicator will flash quickly, and the aircraft will be forced to return automatically. During the return process, the aircraft can be controlled by remote controller (assuming standard signal levels).

- **Emergency low power landing**

If the remaining power is 5% or less of total power, this will constitute a power emergency, the red indicator will flash quickly, and the aircraft will be forced to land vertically.

※ **The throttle lever can be adjusted to position the aircraft into a more appropriate position before landing.**

※ **If the battery power is too low for the aircraft to return, the user should immediately land the aircraft.**

3. Communication loss return

If the GPS signal is strong, and the compass is operating normally, then a return point will be successfully recorded by the aircraft. If the remote controller's signal is interrupted, the aircraft will remain hovering. If the duration of signal interruption exceeds 15s, the aircraft will automatically return. Under WIFI control, if the duration of APP signal interruption exceeds 15s the aircraft will then also return automatically. If normal signal conditions are recovered during the return process, the aircraft will continue returning, but the user can press the "Return" button on the remote

controller or click “” on the GDU Mini App interface to exit the return process.

※ **WIFI control is only applicable to GDU O₂.**

Vision Position System

The vision position system includes the forward vision system and the downward vision system. The forward vision system on two sides of the nose includes two lenses, and used for sensing obstacles by visual distance identification. The downward vision system at the bottom of the aircraft includes optical and ultrasonic sensors, and used to obtain the location information of the aircraft with optical sensor to provide the location reference along the horizontal axis. The current flight height can be judged through ultrasonic sensor, thus providing a vertical height reference and allowing flight at a fixed height.

Observation Range

See the figure below for the observation ranges of the forward vision system and downward vision system. If obstacles exist outside these ranges, the aircraft cannot effectively avoid them; please fly carefully.

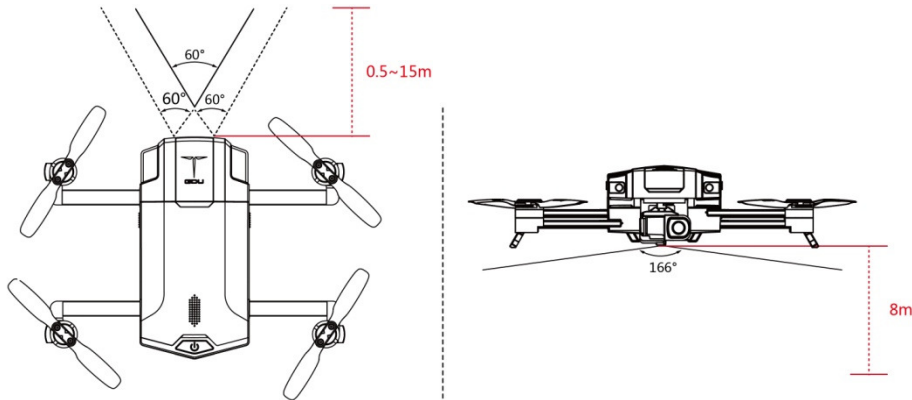

Downward Vision System Application Scenario

The downward vision system is effective with height less than 3m, in poor GPS signal conditions. It is particularly applicable to indoor flight.

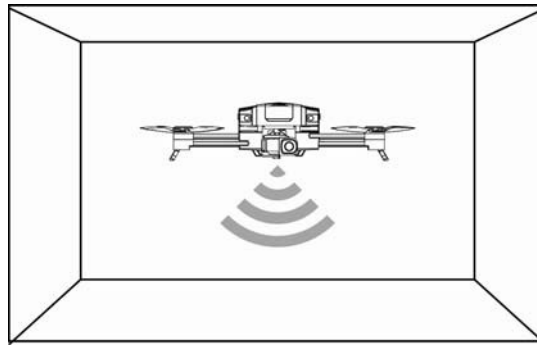

Operating Steps

1. Use the remote controller to switch the flight mode into standard mode.
2. Turn on the aircraft's power supply. Wait until the flight status indicator is a steady green ON.
3. Engage the sticks to start the aircraft. The downward vision system will work automatically without requiring manual activation.

Forward Vision System Application Scenario

The forward vision system is available in standard mode under well-lit conditions, and can be used for observing and avoiding clear obstacles during flight.

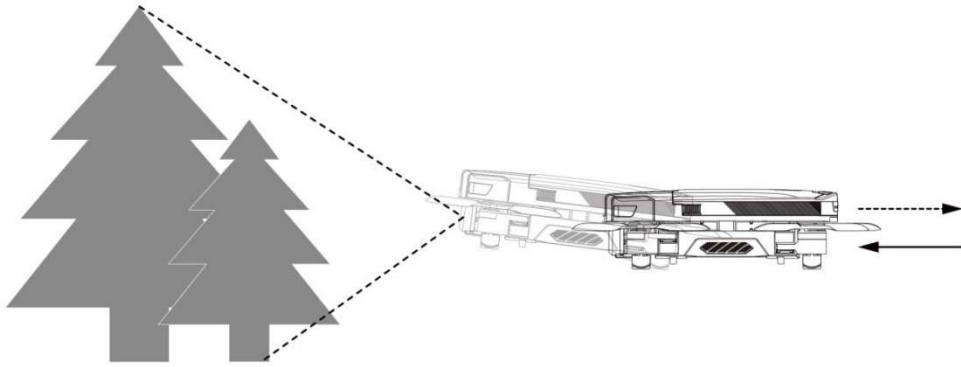

The accuracy of the vision position system is likely to be influenced by light intensity and surface of obstacles, and ultrasonic positioning may be inaccurate if the drone flies close to sound-absorbing materials. Therefore, be careful not to rely on the vision position system in the following conditions:

- Light intensity: less than 10lux or more than 10,000lux.
- Operating temperature: below -10°C or above 55°C .
- Flight altitude: more than 4,000m.
- Excessively flight speed.
- Pure color surfaces (such as pure black, pure red, pure white and pure green).
- Highly reflective surfaces.
- Near water or transparent objects.
- Surface of moving objects.
- Strong or rapid changing light.
- Surface with strong ultrasonic absorbing objects.
- Surfaces with no clear textures.
- Surface with highly repetitive or patterned textures.
- Surface sloped at more than 30 degrees.
- Small obstacles (area: less than 1m^2).

Smart Flight Function

Pay attention to the following items before enabling the smart flight function:

1. Ensure good light conditions.
2. Ensure that the cameras of the forward and downward vision systems are clean and free of blemishes.
3. Ensure that the aircraft is fully charged and in standard mode.
4. Ensure that the power-on self-check results of the GDU Mini App comply with the preflight

requirements.

5. The aircraft should fly more than 3m above the ground after the Follow/Around function is enabled.
6. Always pay attention to surrounding objects along the aircraft's Follow/Around route, and be ready to switch to manual control or click "STOP" on the GDU Mini APP to avoid collision in case of emergency.
7. Pedestrians should be kept more than 5m away from aircraft in Follow/Around mode.
8. Be careful when enabling the Follow/Around function if the target is moving significantly or is beyond visual range.
9. Communication may be interrupted in the complex outdoor electromagnetic environment. In case of communication interruption, then safely approach the aircraft. If possible, click "Automatic return home" to prevent the aircraft from losing control as a result of the ensuing communication loss.
10. Please observe the local laws and regulations regarding privacy while using the Follow function.
11. If the gesture shot function is enabled, the aircraft should be hovered at about 3m away from the main user and at a height of less than 1.5 times the height of the main user.

Obstacle Avoidance

This function is used for high-precision and rapid detection and avoidance of obstacles, so that the aircraft will automatically avoid obstacles during flight.

Operating steps:

1. Enable the obstacle avoidance mode.

Click "Start shooting" to enter the flight interface. Enable "Vision-based obstacle avoidance" and "Display radar map" by clicking "Settings" - "Flight setting". The obstacle avoidance mode will then be enabled.

2. After obstacle avoidance mode is enabled:

- 1) The GDU Mini App will display the distance of frontward obstacles. Obstacles detected by the vision system will be displayed at a range of up to 8m. The radar map display on the GDU Mini APP will turn green, yellow and red according to distance.

- 2) The aircraft will stop at 1.5m away from any obstacle, and Forward commands on the stick will be rendered invalid. If the obstacle moves towards the aircraft, the aircraft will move backwards and maintain a safe distance of at least 1.5m from the obstacle.

Follow Me

Operating steps:

1. Click the smart function button “”, and select “Follow Me” in the pop-up interface to enter Follow me mode. A target selection prompt will appear.

2. Select the target by one of two means:

A. Double-click: double-click the face or pedestrian icon on the screen to detect the target. After the target is selected, a green cursor prompt will appear on the screen.

B. Box selection: press your finger on the screen and drag a box until the selected area fully covers the target outline. After the target is selected, a green cursor prompt will appear on the screen.

Once the target is selected, the aircraft will track the object using the gimbal camera, and follow the target at a certain distance.

3. Stop Follow Me mode or reselect the target.

The “STOP” button is located on the left of the GDU Mini APP flight interface. Click it to cancel the current follow me command. Then “EXIT” will appear, and the aircraft will hover. Follow me mode can be enabled again by double-clicking or box selection as described above. Then “EXIT” will change to “STOP”, and the aircraft will switch to Follow me mode.

4. If “EXIT” is clicked, the aircraft will exit Follow me mode and hover in its current position.

Vision Circle

Operating steps:

1. Click the smart function button “”, and select “Vision circle” in the pop-up interface to enter Vision circle mode. The prompt for the user to select the target will then appear.

2. Select the target by means of double-clicking or box selection. The aircraft will then fly around the target.

The direction and speed of flight around the target can be adjusted through the slide bar on the GDU Mini APP interface.

3. Stop the Vision circle mode or reselect target.

1) The “STOP” button is located on the left of the GDU Mini App flight interface. Click it to exit Vision circle mode. Then “EXIT” will appear, and the aircraft will hover. Vision circle mode can be re-enabled by double-clicking or box selection. Then “EXIT” will change to “STOP”, and the aircraft will fly in Vision circle mode.

4. If “EXIT” is clicked, the aircraft will exit Vision circle mode and hover in its current position.

Gesture Shot

Operating steps:

1. Click the smart function button “” in the GDU Mini App flight interface. Select “Gesture Shot” in the pop-up interface to enter Gesture shot mode. This mode supports two functions: photo and video.

1) Photo

Make a V () gesture in front of the gimbal camera. After this gesture is recognized successfully, the GDU Mini APP will commence a 3 second countdown. The user should pose during this time. The photo will be taken at the end of the countdown.

2) Video

Make a palm () gesture in front of the gimbal camera. After this gesture is recognized successfully, release the gesture. Video recording will commence.

Make the palm () gesture again. After this gesture is recognized successfully, the GDU Mini APP will prompt you to stop recording. Release the gesture, and video recording will be stopped.

2. If “EXIT” is clicked, the aircraft will exit Gesture Shot mode and hover in its current position.

Point of Interest

Operating step:

1. Click the smart function button “” in the GDU Mini App flight interface. Select “Point of Interest” in the pop-up interface to enter Point of Interest mode.

2. Position the aircraft above the interest point. Set a radius around this point, and click “Start circling.” The aircraft will fly around this point clockwise at 2m/s at its current height within a certain radius.

3. If “EXIT” is clicked, the aircraft will exit Point of Interest mode and hover in its current position.

Dronie

Operating steps:

1. Click the smart function button “” in the GDU Mini App flight interface. Select “Dronie” in the pop-up interface to enter Dronie Shooting mode.

2. Dragging a box around the target. The user should set the flight distance, select either video or photo mode along with the control mode, and then click “Start flight”. The aircraft will rise while flying backwards. At the same time, photos will be taken. After shooting, the aircraft will return and hover in place, as per the established settings.

3. If “EXIT” is clicked, the aircraft will exit the Dronie mode and hover in its current position.



Rocket

Operating steps:

1. Click the smart function button “” in the GDU Mini App flight interface. Select “Rocket” in the pop-up interface to enter the Rocket mode.
2. The user should set the flight distance, select video or photo mode along with the control mode, and then click “Start flight”. The aircraft will rise vertically, and the target will be shot vertically. After shooting, the aircraft will return and hover in place, as per the settings.
3. If “EXIT” is clicked, the aircraft will exit Rocket mode and hover in its current position.

Propellers

The GDU O₂ system is provided with folding propellers divided into Type A and Type B, corresponding to the different rotational directions of the motor.

Propeller	Type A	Type B
Schematic Diagram		
Installation location	On the clockwise rotating motor shaft	On the counterclockwise rotating motor shaft

Propeller Disassembly

The base of blade, the motor, and the arm’s inner surface are marked with either A or B. The letters on these three parts must match during the installation process.

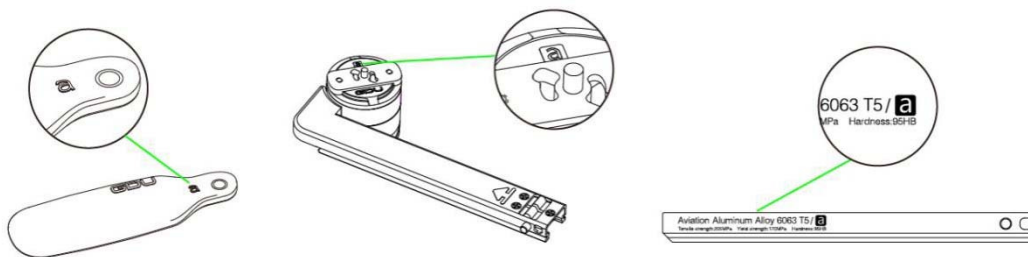

The process of propeller installation is as follows. First, select the same type of propeller as per the letter on the motor. With the letter facing upwards, press the blade into the clamp. Then press the clamp into the slot of the motor shaft, and turn the Type A propeller leftwards 45 degrees and the Type B propeller rightwards 45 degrees, until the holes at the two ends are aligned with the stop pins.

Finally, tighten the screws.

① Screw	② Clamp	③ Blade	④ Motor shaft slot
---------	---------	---------	--------------------

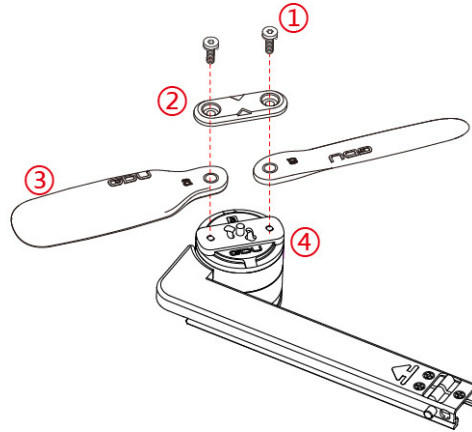

The process of propeller disassembly is as follows. First, remove the screws. Then rotate the clamp of the Type A propeller rightwards or the clamp of Type B propeller leftwards 45 degrees, then remove the clamp. Finally, remove the propeller.

Anti-Shooting Propellers

The anti-shooting propellers provide a safety guarantee in addition to screw locking. Even if the screws are loose, the anti-shooting propellers prevent the propellers from being released. The hook of the propeller clamp fits with the slot of the motor shaft. The motor shaft cannot be removed until the clamp is rotated to a proper angle.

Battery

The product is provided with a high-performance smart lithium battery (4000mAh and 11.4V).

Power On and Off

Press the power switch once and hold for 2 seconds to power on/off the aircraft.

Power Check

Press the power switch once to check the remaining power when the aircraft is OFF.

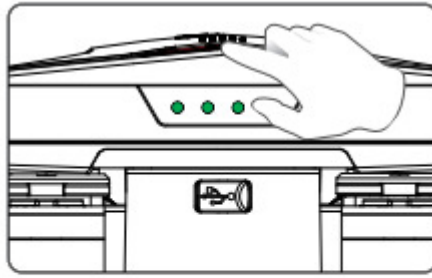

Low ← Battery Level → ● High



Power Indicator

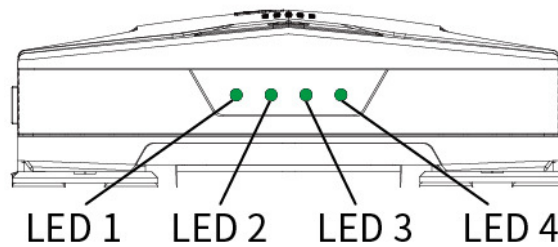

LED1	LED2	LED3	LED4	Current Power
Flashing fast	None	None	None	0-5%
Flashing	None	None	None	6%-25%
ON	Flashing	None	None	26%-50%
ON	ON	Flashing	None	51%-75%
ON	ON	ON	Flashing	76%-100%
ON	ON	ON	ON	100%

Charging

Power off the aircraft. Remove the battery and charge with a designated charger. The charging time is within 2 hours.

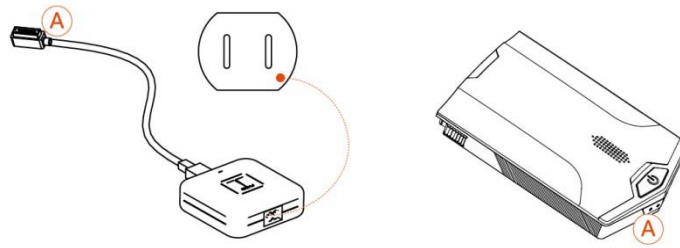

Input voltage: 100-240V

Charging time: less than 2 hours

If the battery and remote controller are charged at the same time, the charging time is within 2.5 hours.

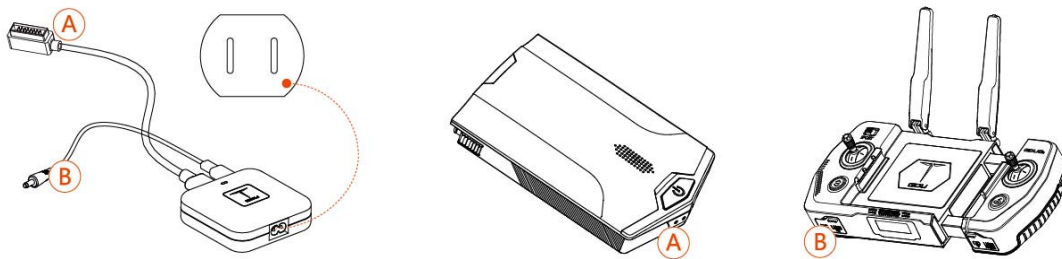

Input voltage: 100-240V

Charging time: less than 2.5 hours (A+B)

During the charging process, if the indicators on red, it means that the battery is being charged. If the indicators is green on, it means that the battery has been fully charged.If the A and B charging at the same time,when A or B not a full charge,the indicators is red on.

Charging Indicator

LED1	LED2	LED3	LED4	Current Power
	O	O	O	0%-25%
		O	O	25%-50%
			O	50%-75%
				75%-100%
O	O	O	O	Full

Battery Removal

(i) Press the buttons on both sides at the same time. (ii) Remove the battery by pulling backwards.

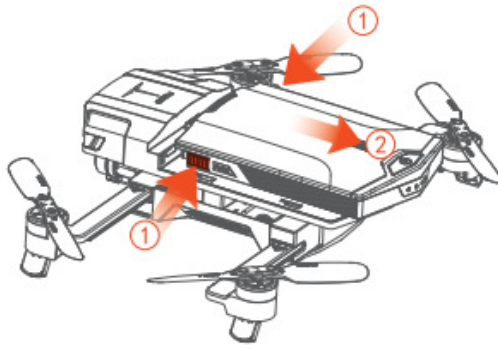

Align the battery with the locking slot of the body, and insert the battery by pushing forwards.

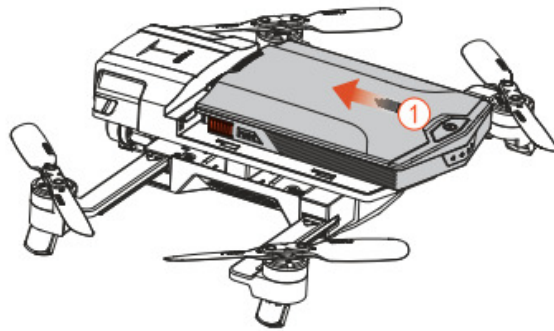

- ※ Insert or remove the battery with the aircraft powered OFF. After flight, remove the battery.
- ※ The battery contains hazardous chemicals. Prior to use, please carefully read the Battery Safety Guide and the warnings written on the battery.

Remote controller

The remote controller of GDU O₂ product is equipped with the advanced automatic frequency-switching wireless communication system. Your mobile phone can be easily inserted on the remote controller. The wireless HD video transmission system is integrated in the remote controller. Using the GDU Mini App, the user can watch HD real-time footage on their mobile phone. The parameters of the aircraft can be fully displayed on the screen.

Prepare the Remote controller

Power on and off

Press the remote controller until you heard the prompt tone to power on/off the aircraft.

Power Check

Press the remote controller for 1 second in the OFF state, and check its power on the left side of the screen. If the aircraft is connected to the remote controller, check the power of the aircraft on the right side of the screen.

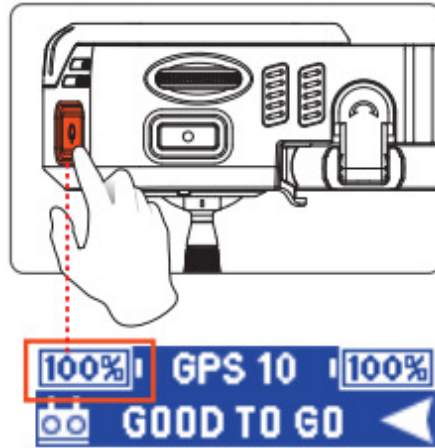

Description of Remote controller Screen

Connection of Remote controller and Aircraft

Disconnection of Remote controller and Aircraft



Charging of Remote controller

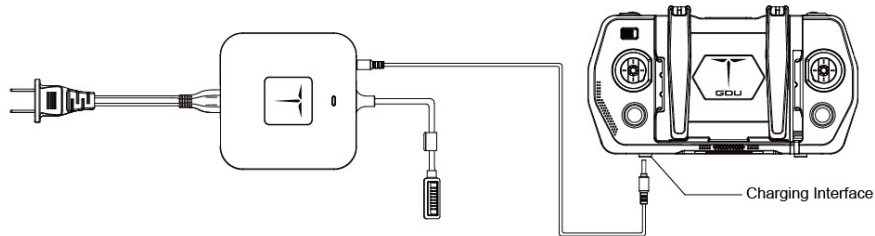

Only charge the remote controller in its OFF state. Check whether the remote controller is fully charged according to the charger's indicator light color. If the power indicator flashes in red, it means that the remote controller is being charged. If the power indicator shows a steady ON in green, it means that the remote controller has been fully charged. The charging duration is generally within 2 hours. A fully charged remote controller can be used for about 1.5 hours.

※ Please use designated chargers to charge battery and remote controller. GDU will not be responsible for any damages or faults caused by not using original accessories.

Mobile Phone Installation

1. Use the appropriate data cable with micro USB side inserted into the slot.

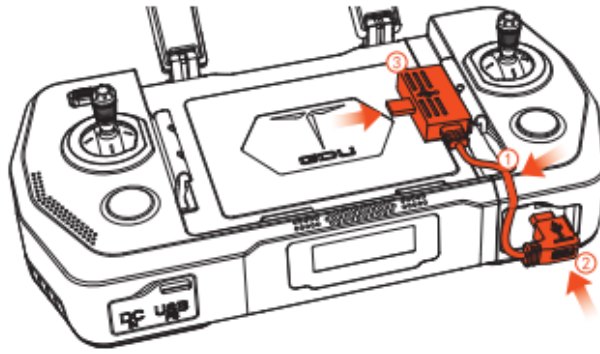

2. Adjust the length of remote controller, clamp the mobile phone into the appropriate position, and connect the other end to the mobile phone's charging interface.

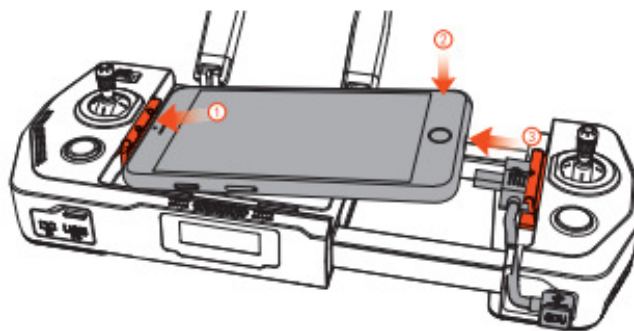

3. After flying, remove the mobile phone and fix the data cable back into the slot.

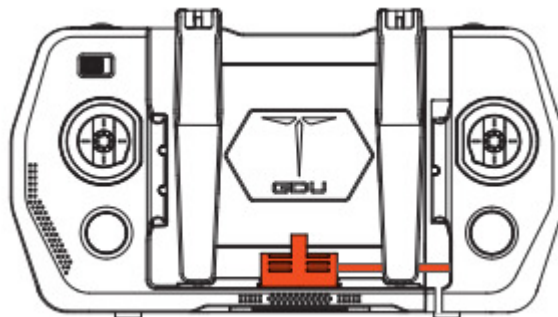

The remote comes equipped with a Lightning cable by default. If requires, please replace it with the Micro USB cable.

HD Video Transmission System

The GDU O₂ series product is provided with an HD video transmission module for the real-time transmission of 720P HD images. The transmission range is 1km for O₂ and 7km for O₂Plus.

Gimbal Camera

The control dial wheels on the controller controls pitch. Back-to-center could let the gimbal return to the initialization place. The “Photo” button and “Video” buttons are used for controlling the camera

in real-time.

※ **The Back-to-center button can be customized.**

※ **The gimbal camera can also be controlled by the GDU Mini App. See details in APP.**

Aircraft Control

The remote controller supports three modes: American (Mode 1), Japanese (Mode 3) and Chinese (Mode 2). The control sticks are defined as follows.

1. American (Mode 1): throttle and rotation on left stick, and left/right and forward/backward on right stick.

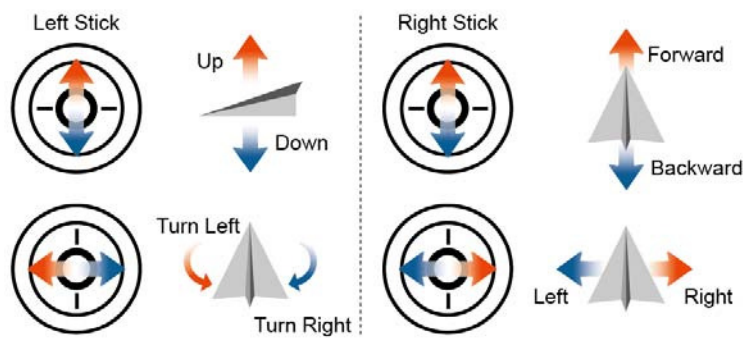

2. Japanese (Mode 3): forward/backward and rotation on left stick; throttle and left/right on right stick.

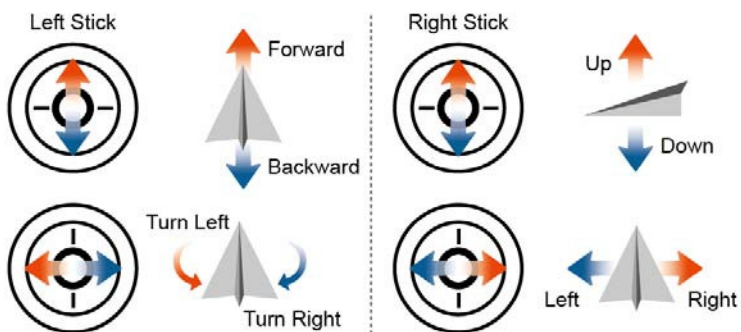

3. Chinese (Mode 2): forward/backward and left/right on left stick; throttle and rotation on right stick.

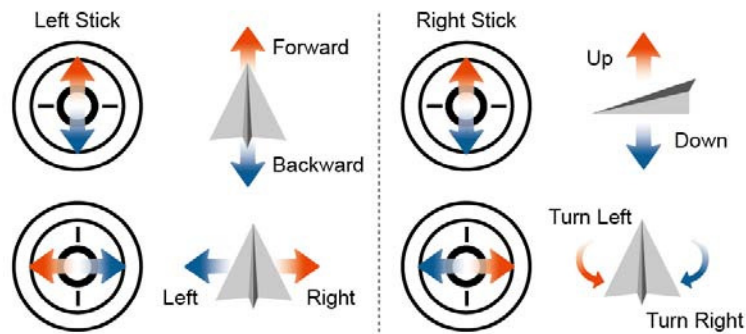

The default mode is American (Mode 1). You can change the operating mode of the remote controller in the Control settings interface of the GDU Mini App.

Frequency Matching

Frequency matching of the remote controller and built-in receiver has been performed before delivery, so the user can directly access the remote controller. If the aircraft or remote controller is replaced, frequency matching should be redone.

Frequency matching steps:

1. Turn on the power supply of the aircraft, and turn on Remote controller.
2. Connect the mobile phone to the Remote controller. Run the GDU Mini App and click “Start shooting” to enter the flight interface.
3. Click “Settings” in the upper right corner. Then click “Remote controller matching” in the “Control settings” interface. Read the pairing tips, click "OK"
4. Select the aircraft's WiFi, click "pairing";
5. If matching succeeds, the aircraft indicators are green on and the “MATCH SUCCESS” will appear on the remote controller screen.
6. If matching fails, repeat the above steps.

Flight Mode Selection

Use the remote controller’s flight mode switch to switch among flight modes. Push the switch to the left to enable standard mode and to the right to enable sport mode.

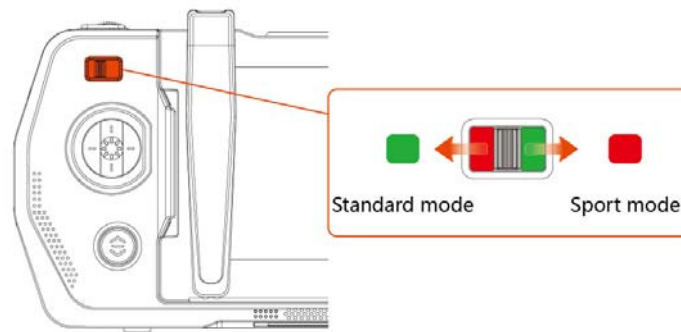

Upgrading the Remote controller

Upgrading the remote controller includes upgrading of both the operation system and the video transmission system.

Download the upgrade tool and firmware of the O2 controller from GDU official website www.gdu-tech.com, install it by connecting the controller to the PC with USB cable, open the upgrade software and click connect, once it is normally connected, click to upgrade the firmware, wait till the upgrading is completed.

Video transmission upgrading: once the information of the WIFI video transmission version is detected, the GDU Mini APP will automatically remind the user to upgrade the version. The user can upgrade the video transmission version by following the prompts.

Gimbal Camera

Camera Overview

GDU O₂ is equipped with a Sony 1/3 inch CMOS camera, with a resolution up to 13,000,000 pixels. With a low-distortion wide-angle lens of 25.5mm equivalent focal length, premium images can be captured.

The camera supports 4K video recording at 30 fps and photographs of a maximum of 13M pixels. Using the advanced image processing technology, high-quality videos and photos can be provided. The camera also supports various shooting modes, including single shooting (12MP), time-lapse shooting, continuous shooting (12MP/5 photos/second), timed shooting, and zoom shooting.

HD videos can be previewed in real-time through the GDU mini App.

Memory

The capacity of the built-in memory is 16G for the O₂ and 32G for the O₂Plus. The videos and photos in the memory can be copied by connecting one end the USB cable to the PC and the other end to the aircraft and then turning on the aircraft's power. The user can also download their videos and photos from the media interface of the GDU Mini APP.

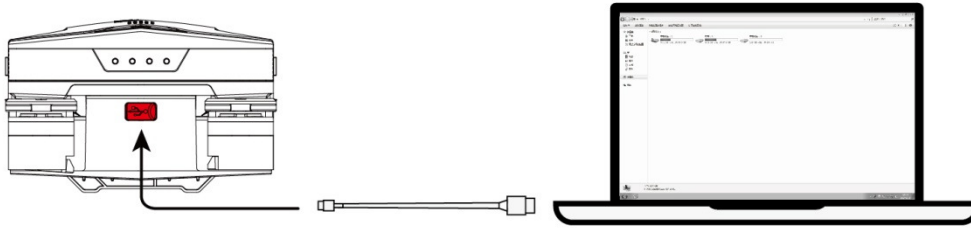

Gimbal Overview

The three-axis stabilized gimbal provides a stable platform for the camera, so as to shoot high quality images during high-speed flight.

With this high-precision three-axis anti-shake gimbal, the variations in accuracy will be 0.02° or less. Even in case of heavy maneuvering, photography will remain accurate to within 0.05° or less, thus preventing shaking and enabling HD video recording and image acquisition.

The aircraft's orientation angle and roll angle range are -30° to $+30^\circ$, and pitch angle range is -90° to $+30^\circ$, which ensures shooting stability regardless of the aircraft's motions.

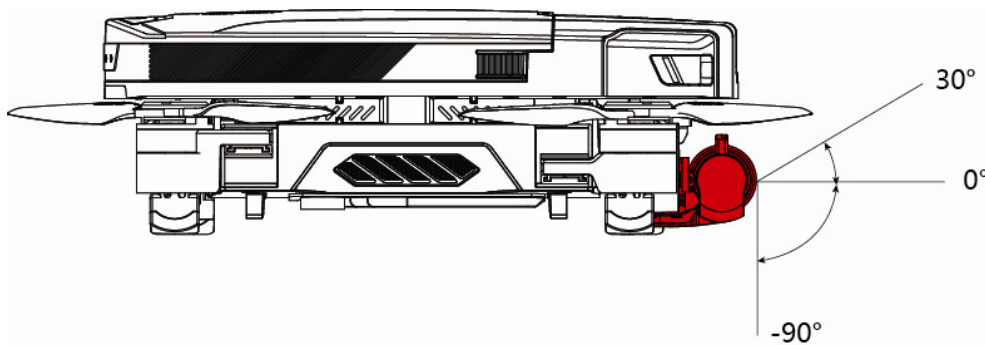

- ※ Before takeoff, keep the aircraft on flat broad ground and prevent the gimbal camera from coming in contact with any object.
- ※ If the aircraft is kept on uneven ground or grass and the gimbal camera is subject to collision against any foreign object or large external force, motor stalling and other errors may occur.
- ※ Flight in fog or clouds may result in condensation or damage the aircraft and camera. In this case, dry the gimbal camera and drone immediately.
- ※ A short vibration prompt after startup is normal. Do not physically turn the gimbal camera.
- ※ Before flight, check whether the lens is clean. Do not touch the lens by hand. Wipe any stains with scratch free, lint free cloth.

GDU Mini App

The GDU Mini APP is application software designed by GDU for O₂ series products. The user

can use the software to control the aircraft, the gimbal camera and its gimbal, thus enabling the functions of flight control, shooting/recording, course planning, parameter settings, media sharing, etc.

The GDU Mini APP is composed of four parts: Drone, Media, Explore and Me.

※ The interfaces and functions of the app will be regularly upgraded. Please refer to the latest APP version.

Drone

The Drone page includes: real-time weather, flight index view, aircraft appearance, and aircraft connection status. Click “Start” to enter the flight interface.

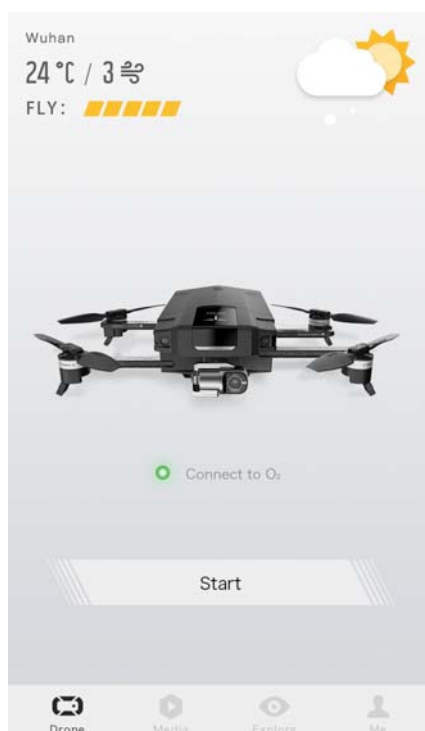

Flight Interface

Before entering the flight interface, select Smart shot or Classic shot. These are provided for different users, and their functional interfaces are difference.



Classic Shot Mode

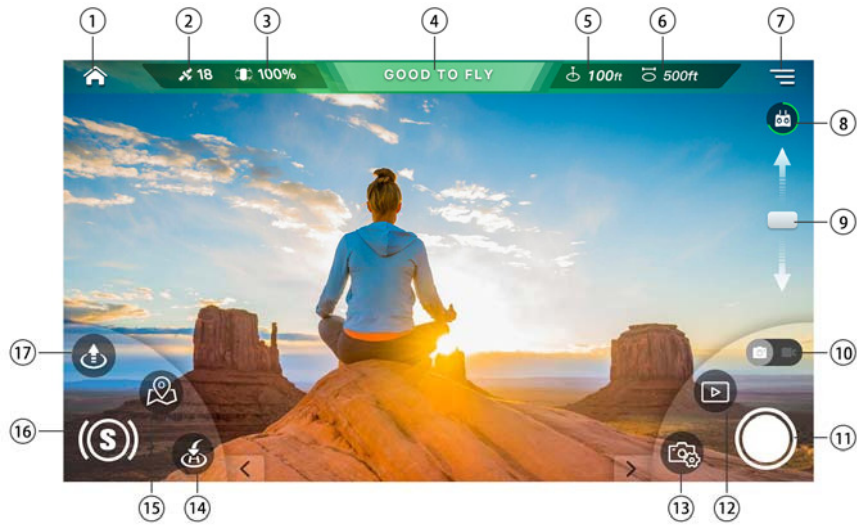

① Home

: click to return to the Home page of APP.

② GPS status

: shows the number of GPS.

③ Aircraft power

: shows the remaining power of the aircraft.

④ Aircraft connection status

: shows the connection status of the aircraft.

⑤ Altitude

: shows the current flight altitude.

⑥ Flight distance

: shows the current flight distance.

⑦ Settings

: click to enter the system setting interface of the aircraft, including control settings, flight settings, video transmission settings, camera settings and general settings.

⑧ Remote controller power

: show the remaining power of the remote controller.

⑨ Gimbal pitch adjustment

: adjust the pitch angle of the gimbal camera.

⑩ Photo/video switching

: click it to switch between photo/video modes.

Photo/video button

: shows the current shooting mode: photo or video.

⑫ Cloud media

: view the media files in the memory of the currently connected aircraft.

Camera settings



: click to open the camera function parameters, which can be adjusted.

RTH



: click to return and land.

Switch to map



: click to switch to the map interface.

Compass



: shows the current orientation and heading.

Auto take-off/Vertical landing button



: shows the take off button before take off ; shows vertical landing button after takeoff.

Smart Shot Mode

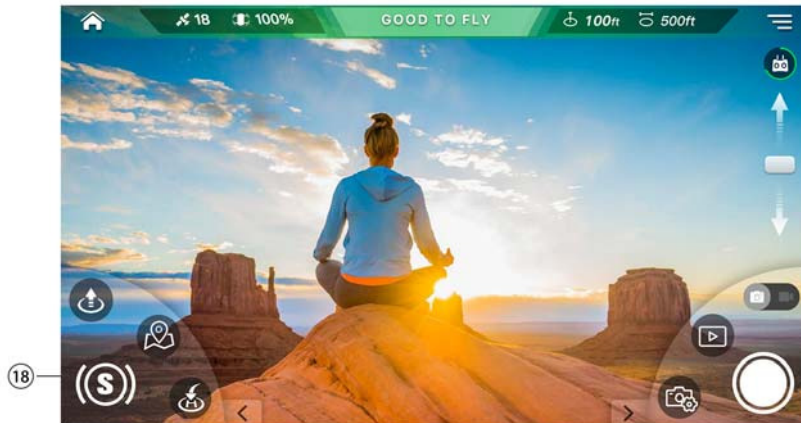

Smart function



: main functions of the flight interface in smart shot mode include: Follow Me, Vision circle, Point of Interest, Gesture Shot, Dronie, Rocket, etc.

※ See the smart flight function for specific operations.

※ The smart functions will be upgraded continuously. Please refer to the latest APP version.

Map interface:

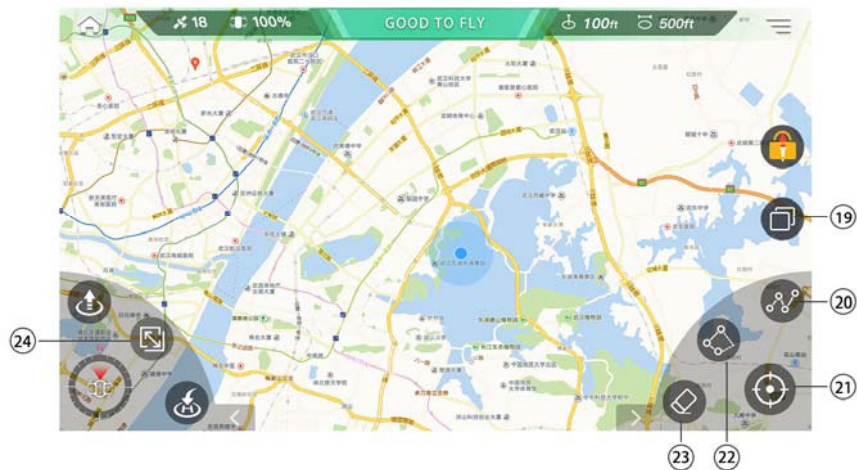

□ Map switching

: click to change the map display among 2D map, satellite map and hybrid map.

□ Waypoint

: click to activate the waypoint function, where you can set and upload flying mark points that the aircraft will follow.

□ Positioning

: click to locate the aircraft's current position.

□ Electronic fence

: the aircraft will fly safely within the set electronic fence.

□ Clear

: click to clear any non-uploaded waypoints or electronic fences in the map interface.

□ Switch to flight interface

: click to return to the flight interface.

Settings:

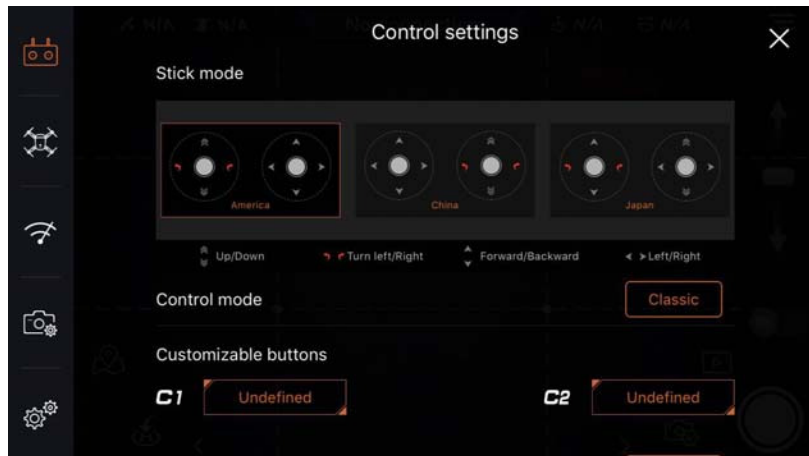

▮ Control settings

Switch the control mode, customize C1\C2 buttons and match RC with drone.

▮ Flight settings

Set altitude/distance limit, return altitude and visual obstacle avoidance.

▮ Image transmission settings

Set channel mode, check the signal strength.

▮ Camera settings

Set preview resolution ratio, video resolution ratio, photo resolution ratio and storage.

▮ General settings

Set the grid, sound, param units, magnetometer, calibrate map coordinates and view drone information.

Media

The user can view downloaded photos and videos through the media center, or edit photos and videos using the appropriate editor. These edited works can then be shared to social networks.



Photo editing:

Retouch and Color Correction



Video editing:

Single-video editing, multi-video stitching, and adding video themes (filter + music)

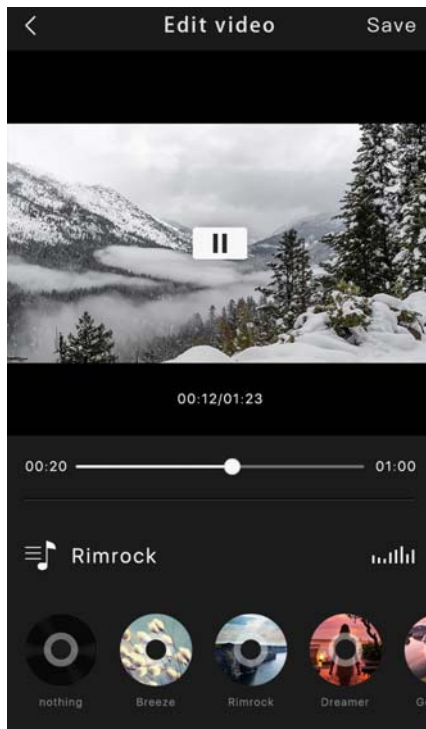

Explore

The Explore interface shows the wonderful aerial artworks uploaded by the user. After uploading is successful, the works will be synchronously shared on social media platforms.

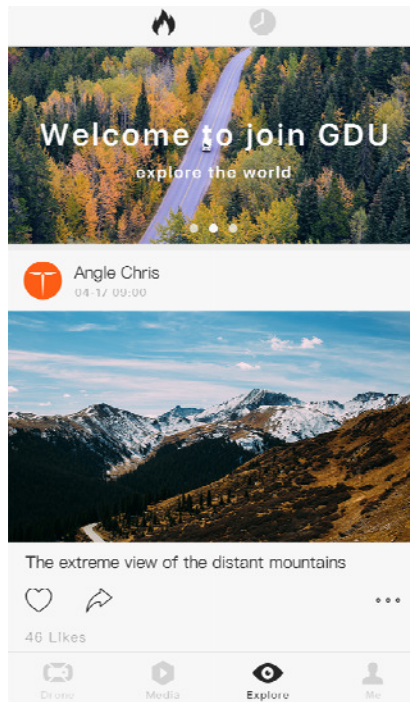

Sharing:

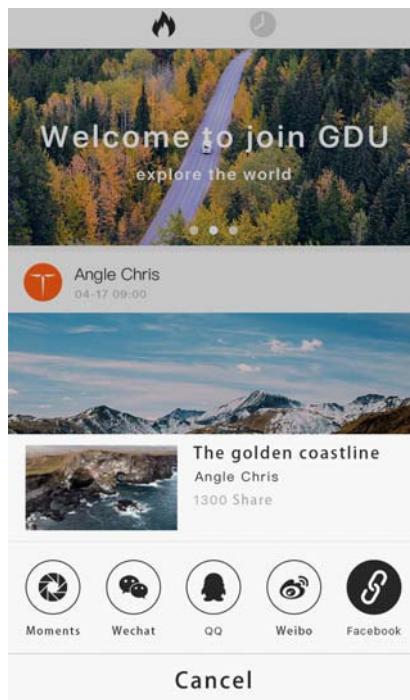

✘ **The supported third-party platforms will be added continuously as the app is upgraded. Please refer to the latest APP vision.**

Me

In the GDU Personal Center, the user can modify their personal information, view their published works and collected favorites and visit the Official GDU Store.

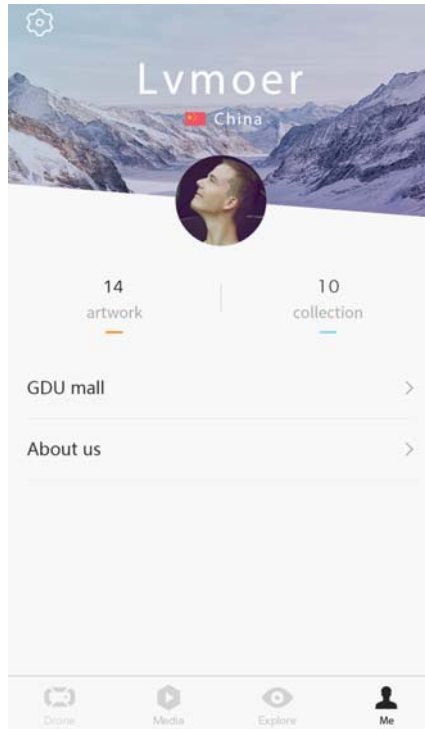

- ※ The language of the app interface should be the same as the system language of the mobile device. Change the system language of the mobile device before changing the interface language.
- ※ At present, the app interface only supports Chinese Simplified and English. The language package will be added later, and please refer to the latest APP version.

Flight

Preflight Check

- Check all parts of the aircraft before each flight. If there is any damage, please repair/replace before trying to fly the aircraft
- Check whether the aircraft battery, remote control and mobile phone have sufficient power.
- Ensure that the arm and landing pad have been fully extended in place and the propeller has been installed securely.
- Check whether the remote controller is properly connected to the aircraft.
- Always operate with the latest firmware. And check whether the GDU Mini APP and the remote controller are connected normally.
- Check whether the motor and gimbal camera work normally after the aircraft is started.

Magnetometer Calibration

Calibrate the magnetometer according to the following procedures in an open space. For more information, watch the related teaching video.

Steps:

1. Power on the remote control and then the aircraft, then connect the mobile phone to the remote controller. At this time, the aircraft will begin its self-check, accompanied by a beeping sound.
2. After the beep stops, click  on APP, and select page of “General Settings”; click “Calibrate” on the right; it enters into mode of compass calibration when the yellow light keeps on, the magnetometer calibration mode is enabled.

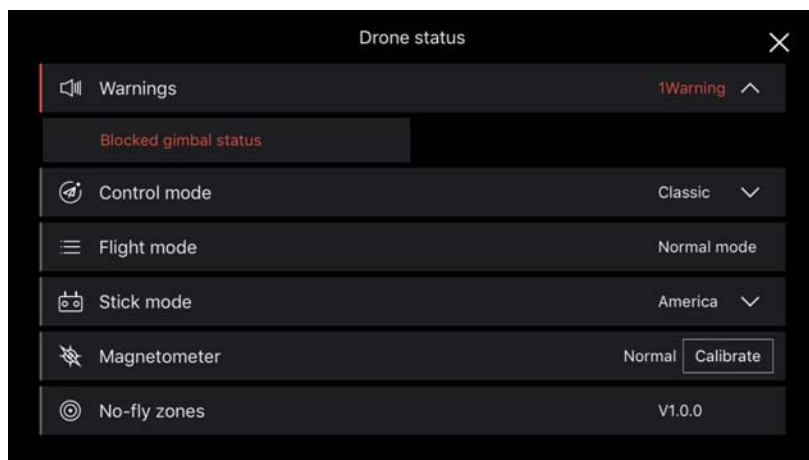
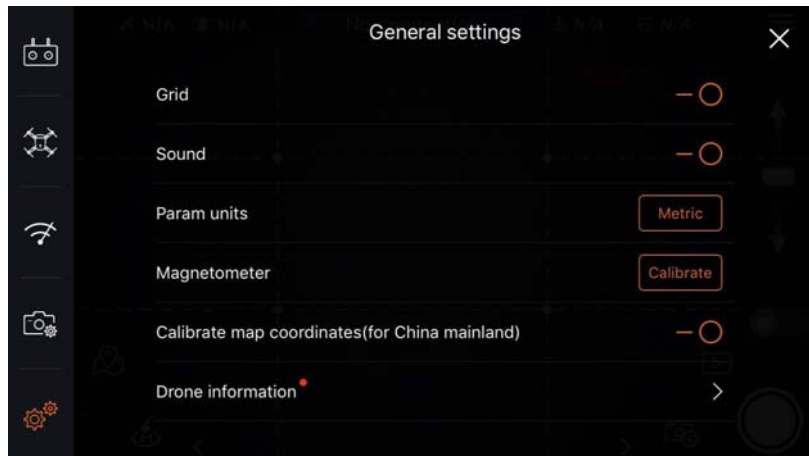

3. Start magnetometer calibration. Hold the aircraft and rotate it clock-wisely and horizontally. Observe the color of the LED indicator light in the aircraft and go to the next step when the LED indicator turns solid white light. Otherwise, please return to the step 2.



4. Hold the aircraft carefully. With the nose facing downward, rotate the aircraft clockwise vertically and observe the aircraft's indicators. If the tail indicator is solid green, vertical magnetometer calibration is successful. Otherwise, magnetometer calibration failed, please return to Step 2.

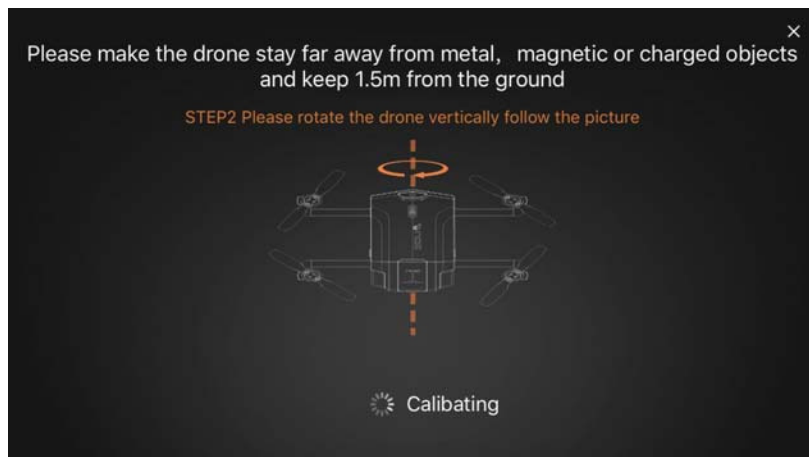





- ※ Do not move the aircraft while it is in self-check.
- ※ Calibrate the magnetometer before the aircraft's first use or after any significant change in flight area. Otherwise, the aircraft will not be unlocked for flight.
- ※ Calibrate the magnetometer in cases of serious drift or if the aircraft fails to fly along a straight line.
- ※ Do not calibrate the magnetometer indoors or near large metal objects or in the place with strong electric and magnetic fields.
- ※ Do not touch mobile phones, watches, keys, or other metal objects while calibrating the magnetometer.

General Flight Operations

Select a flat and open space, and turn on the power of both the remote controller and aircraft. After the magnetometer is calibrated successfully, the indicator of the aircraft will become green. The aircraft should be kept horizontal, and the user should face the tail of the aircraft.

Manual Take-off/Landing

Take-off:① Press the AUTO Take-off button on the remote controller 3s, the aircraft will hover at 1.5 meters above the ground. 

Or ② Unlock the aircraft by pushing the sticks down inward   , the motor running, push the throttle up. 

Landing:① Press the RTH button on the remote controller. 

Or ② Push the throttle down until the aircraft lands onto the ground and the motor stops running. 

Automatic Take-off/Landing

The aircraft must fly within 80m of the controller if being piloted using the GDU Mini APP.

Operating steps:

1. Power on the aircraft, and connect the mobile phone to aircraft. WIFI: GDU-02-A-xxx; password: 12345678.
2. Run GDU Mini APP. Click “Start” to enter the flight interface.
3. Conduct pre-flight check according to the prompts.
4. Press the Takeoff button and confirm that the safety takeoff conditions have been met. The aircraft will hover at 1.5 meters above the ground. At the same time, the virtual sticks will appear in the interface.

Landing

1. Click the RTH or Vertical Landing button and confirm that the safety landing conditions have been met before landing.
 2. The user can click “ⓧ” in the screen to exit landing.
 3. The aircraft will land on the ground, and the motor will automatically stop running.
 4. Power off the aircraft.
- ※ **In case of emergency in the air, the stick can issue an emergency stop, which will result in the aircraft falling to the ground.**
 - ※ **If flight is controlled by the controller, it can be connected to a mobile phone for real-time viewing of the flight interface.**

- ※ The GDU Mini APP is only applicable to O₂ products.
- ※ Before the flight, please put the head of the aircraft forward and keep over 10 feet away from the aircraft.
- ※ Do not unlock the aircraft on steep slopes or hillsides.

Technical Parameters

- Aircraft

Takeoff weight (excluding hood)	730g
Takeoff weight (including hood)	846g
Maximum ascend speed	5m/s (sport mode)
Maximum descend speed	3m/s
Maximum horizontal speed	15m/s (sport mode, in windless condition above sea level)
Maximum flight altitude	3500m
Maximum hovering time	20min (in windless condition)
Operating temperature	0°C to 40°C
Satellite positioning module	GPS/GLONASS, dual-mode

- Gimbal camera

Controllable angle range	Pitch: 0°~-90°
--------------------------	----------------

- Forward vision system

Sensing range	0.5-15m
Operating condition	Obstacles with clear texture and adequate lighting conditions (>15lux)

- Downward vision system

Speed measurement range	Flight speed: ≤10m/S (at 2m height, with adequate light)
Height measurement range	0.3-3 m
Accurate hovering range	0.3-8 m
Operating environment	Clear texture on the ground and adequate lighting conditions (>15lux)

- Camera

Image sensor	1/3-inch CMOS with 13M effective pixels
Lens	FOV 79.8°equivalent focal length_25.5 mm F/2.2
Distortion	<1.5%
ISO range	Auto 100 - 1600
Electronic shutter speed	Auto
Maximum photo resolution	4208*3120
Video resolution	4K: 3840×2160 @ 30fps 1080P: 1920×1080 @ 30fps 720P: 1280×720 @ 30fps
Image format	JPG
Video format	MP4
Built-in memory:	16G (O ₂) or 32G (O ₂ Plus and O ₂ X)
• Remote controller	
Operating frequency	5.8GHz (O ₂) or 2.4GHz (O ₂ Plus and O ₂ X)
Video transmission distance	1km (O ₂) or 7km (O ₂ Plus) or 10km (O ₂ X)
Operating temperature	0 to 40°C
Battery	1200mAh
Operating voltage	7.6V
USB type	Lightning, Micro USB and Type C
• Charger	
Voltage	13.05 V
Rated power	39.15 W
• Battery	
Capacity	4000mAh
Voltage	11.4 V
Type	LiPo 3S
Energy	45.6Wh
Overall weight	About 283g
Maximum charging power	78W

Certification Information

FCC Compliance

This equipment has been tested and found to comply with the limits of a Class B digital device, pursuant to Part 15 of the FCC Rules. These limits are designed to provide reasonable protection against harmful interference in a residential installation. This equipment generates uses and can radiate radio frequency energy and, if not installed or used in accordance with the instructions, may cause harmful interference to radio communications. However, there is no guarantee that interference will not occur with a particular installation. If this equipment does cause harmful interference to radio or television reception, as can be determined by turning the equipment in question off and on, the user is encouraged to try to correct the interference by one or more of the following measures:

- Reorient or relocate the receiving antenna.
- Increase the separation between the equipment and receiver.
- Connect the equipment into an outlet on a circuit different from that to which the receiver is connected.
- Consult the dealer or an experienced radio/TV technician for help.

Changes or modifications not expressly approved by the party responsible for compliance could void the user's authority to operate the equipment.

This device complies with part 15 of the FCC Rules. Operation is subject to the following two conditions: (1) This device may not cause harmful interference, and (2) this device must accept any interference received, including interference that may cause undesired operation.

GDU O₂

The antenna(s) used for this transmitter must be installed to provide a separation distance of at least 20 cm from all persons and must not be co-located or operating in conjunction with any other antenna or transmitter. This equipment complies with FCC radiation exposure limits set forth for an uncontrolled environment. The end user must follow the specific operating instructions for satisfying radio frequency exposure compliance. This transmitter must not be co-located or operating in conjunction with any other antenna or transmitter.

GDU Remote controller

The portable device is designed to meet the requirements for exposure to radio waves as established by the Federal Communications Commission (USA). These requirements set an SAR limit of 1.6 W/Kg averaged over 1 gram of tissue for body mode and 4.0 W/Kg averaged over 10 gram of tissue for Handheld mode. The highest SAR value reported under this standard during product certification for use as below:

Controller: The highest measured Body SAR value (1g) is: 0.92W/Kg.

Controller: The highest measured Handheld SAR value (10g) is: 1.02W/Kg.

For body worn operation, this model device has been tested and meets the FCC/ISED RF exposure guidelines when used with an accessory designated for this product or when used with an accessory that contains no metal and that positions the handset a minimum of 10 mm from the body.

