



Microwave Data Systems

MDS FIVE Series Digital Radio Transceiver



User Reference and Installation Guide

Document Number: 05-4498A01, Rev. G

Date: 13 July 2006



© 2006 Microwave Data Systems Inc. All Rights Reserved.

This book and the information contained herein is the proprietary and confidential information of Microwave Data Systems Inc. that is provided by Microwave Data Systems™ exclusively for evaluating the purchase of Microwave Data Systems Inc. technology and is protected by copyright and trade secret laws.

No part of this document may be disclosed, reproduced, or transmitted in any form or by any means, electronic or mechanical, for any purpose without the express written permission of Microwave Data Systems Inc.

For permissions, contact Microwave Data Systems Inc. Marketing Group at 1-585-241-5510 or 1-585-242-8369 (FAX).

Notice of Disclaimer

The information and specifications provided in this document are subject to change without notice. Microwave Data Systems Inc. reserves the right to make changes in design or components as progress in engineering and manufacturing may warrant.

The Warranty(s) that accompany Microwave Data Systems Inc., products are set forth in the sales agreement/contract between Microwave Data Systems Inc. and its customer. Please consult the sales agreement for the terms and conditions of the Warranty(s) proved by Microwave Data Systems Inc. To obtain a copy of the Warranty(s), contact your Microwave Data Systems Inc. Sales Representative at 1-585-241-5510 or 1-585-242-8369 (FAX).

The information provided in this Microwave Data Systems Inc., document is provided “as is” without warranty of any kind, either expressed or implied, including, but not limited to, the implied warranties of merchantability, fitness for a particular purpose, or non-infringement. Some jurisdictions do not allow the exclusion of implied warranties, so the above exclusion may not apply to you.

In no event shall Microwave Data Systems Inc. be liable for any damages whatsoever – including special, indirect, consequential or incidental damages or damages for loss of profits, revenue, use, or data whether brought in contract or tort, arising out of or connected with any Microwave Data Systems Inc., document or the use, reliance upon or performance of any material contained in or accessed from this Microwave Data Systems Inc. document. Microwave Data Systems’s license agreement may be provided upon request. Additional Terms and Conditions will be finalized upon negotiation or a purchase.

The above information shall not be constructed to imply any additional warranties for Microwave Data Systems Inc. equipment including, but not limited to, warranties of merchantability or fitness for an intended use.

Trademark Information

Software Defined Indoor Unit™ (SDIDU™) is a product and trademark of CarrierComm Inc.

Java™ is a trademark of Sun Microsystems Inc.

Windows® is a registered trademark of Microsoft Corporation

All other brand or product names are trademarks or registered trademarks of their respective companies or organizations.

Part Number: 05-4498A01

Table of Contents

1	SAFETY PRECAUTIONS	1-1
2	SYSTEM DESCRIPTION	2-1
2.1	About This Manual	2-1
2.2	Introduction	2-1
2.3	System Features	2-4
2.4	Physical Description	2-5
2.4.1	Model Types	2-5
2.4.2	Options	2-6
2.4.3	Front Panel Indicators	2-7
2.4.4	Front Panel Connections	2-8
2.5	System Description	2-11
2.6	Consecutive Point Architecture	2-14
2.7	2 + 0 (East-West) Configuration	2-16
2.8	Spanning Tree Protocol (STP)	2-17
2.9	1+1 Protection	2-17
2.9.1	Protected Non-Diversity (Hot Standby)	2-18
2.9.2	Protected Diversity	2-18
2.10	1 + 1 Multi-hop Repeater Configuration	2-19
2.11	Data Interfaces	2-21
2.12	Crosspoint Switch	2-21
2.13	Power Management	2-22
2.14	MDS FIVE Series Software and Network Management	2-23
2.14.1	IP Address	2-24
2.14.2	Network	2-24
2.14.3	NMS Network Operational Principles	2-24
2.14.4	Third Party Network Management Software Support	2-25
2.15	System Loopbacks	2-25
3	INSTALLATION	3-1
3.1	Unpacking	3-1
3.2	Notices	3-2
3.3	Required Tools	3-2
3.3.1	SDIDU™ Tools	3-2
3.3.2	ODU Tools	3-2
3.4	PRE-INSTALLATION NOTES	3-3
3.5	Overview of Installation and Testing Process	3-3
3.6	Site Evaluation	3-5
3.6.1	Preparing for a Site Evaluation	3-6
3.6.2	Site Evaluation Process	3-7
3.6.3	Critical System Calculations	3-12
3.6.4	Frequency Plan Determination	3-13
3.6.5	Antenna Planning	3-15

3.6.6	ODU Transmit Power Setup	3-15
3.6.7	Documenting a Site Evaluation	3-18
3.7	Installation of the MDS FIVE Series	3-21
3.7.1	Installing the MDS FIVE Series Software Defined IDU™	3-21
3.7.2	Installing the MDS FIVE Series ODU	3-22
3.7.3	Routing the ODU/ SDIDU™ Interconnect Cable	3-24
3.8	Quick Start Guide	3-26
3.8.1	Materials Required	3-26
3.8.2	Grounding the ODU	3-26
3.8.3	Grounding the SDIDU™	3-28
3.8.4	Connecting the SDIDU™ to the PC and Power Source	3-28
3.8.5	SDIDU™ Configuration	3-29
3.8.6	ODU Antenna Alignment	3-31
3.8.7	Quick Start Settings	3-32
3.9	SDIDU™ Service	3-33
3.9.1	Removing a Module	3-33
3.9.2	Installing a Module	3-34
3.10	Documenting MDS FIVE Series Configuration	3-35
4	SUMMARY SPECIFICATION	4-1
5	FRONT PANEL CONNECTORS	5-1
5.1	DC Input (Power) Connector	5-1
5.2	Ethernet 100BaseTX Payload Connector 1-2	5-1
5.3	SONET Payload Connector	5-2
5.4	STM-1 Payload Connector	5-2
5.5	DS-3/E-3/STS-1 Payload Connector	5-2
5.6	NMS 10/100BaseTX Connector 1-2	5-3
5.7	Alarm/Serial Port Connector	5-3
5.8	ODU Connector	5-4
5.9	T1/E1 - Channels 1-2 Connector	5-4
5.10	T1/E1 - Channels 3-16 Connector	5-5
5.11	USB	5-7
5.12	Voice Order Wire	5-7
5.13	Data Order Wire	5-8
5.13.1	RS422	5-8
5.13.2	RS-232	5-8
6	APPENDIX	6-1
6.1	Alarm Descriptions	6-1
6.2	Abbreviations & Acronyms	6-16

1 Safety Precautions

PLEASE READ THESE SAFETY PRECAUTIONS!

RF Energy Health Hazard



The radio equipment described in this guide uses radio frequency transmitters. Although the power level is low, the concentrated energy from a directional antenna may pose a health hazard. Do not allow people to come in close proximity to the front of the antenna while the transmitter is operating. The antenna will be professionally installed on fixed-mounted outdoor permanent structures to provide separation from any other antenna and all persons as detailed on page 1-3.

Protection from Lightning



Article 810 of the US National Electric Department of Energy Handbook 1996 specifies that radio and television lead-in cables must have adequate surge protection at or near the point of entry to the building. The code specifies that any shielded cable from an external antenna must have the shield directly connected to a 10 AWG wire that connects to the building ground electrode.

Warning – This is a Class A product

Warning – This is a Class A product. In a domestic environment this product may cause radio interference in which case the user may be required to take adequate measures.

Warning – Turn off all power before servicing

Warning – Turn off all power before servicing.

Safety Requirements

Safety requirements require a switch be employed between the SDIDU™ external power supply and the SDIDU™ power supplies.

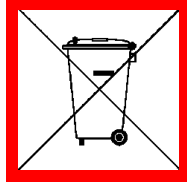

Proper Disposal

The manufacture of the equipment described herein has required the extraction and use of natural resources. Improper disposal may contaminate the environment and present a health risk due to the release of hazardous substances contained within. To avoid dissemination of these substances into our environment, and to lessen the demand on natural resources, we encourage you to use the appropriate recycling systems for disposal. These systems will reuse or recycle most of the materials found in this equipment in a sound way. Please contact Microwave Data Systems or your supplier for more information on the proper disposal of this equipment.

FCC Notice, USA

Microwave Data Systems Digital Radios comply with Part 15 of the FCC rules. The radios are specifically designed to be used under Part 15, Section 15.247 of the FCC rules and regulations. Operation is subject to following conditions:

- The device to utilize a fixed mount antenna, for use on a permanent outdoor structure.
- The device to be installed by qualified installation/deployment personnel. When the device is operating, a minimum separation must exist between the device and persons as shown in the table below. The following method was used to calculate the RF safety distance:

$$S_{MPE} = PG/4\pi r_{min}^2 = EIRP/4\pi r_{min}^2$$

which is solved for the minimum separation distance

$$r_{min} = (PG/4\pi S_{MPE})^{1/2} = (EIRP/4\pi S_{MPE})^{1/2}$$

where P = power input to the antenna (mW), EIRP = Equivalent (effective) isotropic radiated power, S = maximum permissible exposure (mW/cm²), G = numeric gain of the antenna relative to an isotropic radiator, and r_{min} is the minimum separation distance to the center of radiation (cm). The resulting separation distances are dependent on frequency band.

Frequency Band	Minimum Distance (cm)
UNII Band (nominal frequency = 5.25 GHz)	9
ISM Band (nominal frequency = 5.725 GHz)	371

- The device installers and operators should be aware of the transmitter operating conditions, specified in the installation manual and other associated user documentation, as well as the antenna co-location requirements of Part 1.1307 (b) (3), of FCC rules, pertaining to RF exposure.
- The device may not cause harmful interference.
- The device must accept interference received, including interference that may cause undesired operation.

The device is intended to be used only when installed in accordance with instructions outlined in this manual. Failure to comply with these instructions may void the user's authority to operate this device and/or the manufacturer's warranty. Furthermore, any unauthorized modification or changes to this device without the express approval of Microwave Data Systems may also void the user's authority to operate this device.

FCC Part 15 Notice

This equipment has been tested and found to comply with the limits for a Class A digital device, pursuant to Part 15 of the FCC Rules. These limits are designed to provide reasonable protection against harmful interference when the equipment is operated in a commercial environment. This equipment generates, uses, and can radiate radio frequency energy and, if not installed and used in accordance with the instruction manual, may cause harmful interference to radio communications. Operation of this equipment in a residential area may cause harmful interference, in which case the user will be required to correct the interference at his expense. Any external data or audio connection to this equipment must use shielded cables.

2 System Description

2.1 About This Manual

This manual is written for those who are involved in the “hands-on” installation of the MDS FIVE Series Digital Transceiver, such as installation technicians, site evaluators, project managers, and network engineers. It assumes the reader has a basic understanding of how to install hardware, use Windows® based software, and operate test equipment.

The MDS FIVE Series includes a Software Defined Indoor Unit™ (SDIDU™) and outdoor unit (ODU). The SDIDU™ is a product and trademark of CarrierComm.

2.2 Introduction

The Microwave Data Systems family of digital radios provides high capacity transmission, flexibility, features, and convenience for wireless digital communications networks. The Microwave Data Systems digital point-to-point radios represent a new microwave architecture that is designed to address universal applications for both PDH and SDH platforms. This advanced technology platform is designed to provide the flexibility to customers for their current and future network needs.

The Microwave Data Systems radio family is based upon a common platform to support a wide range of network interfaces and configurations. It supports links for 16 x E1/T1, 100BaseTX Ethernet, and DS-3/E-3/STS-1 (optional, consult factory for availability). The radio family is spectrum and data rate scalable, enabling service providers or organizations to trade-off system gain with spectral efficiency and channel availability for optimal network connectivity. The Microwave Data Systems digital radio family enables network operators (mobile and private), government and access service providers to offer a portfolio of secure, scalable wireless applications for data, video, and Voice over IP (VoIP).

The MDS FIVE Series digital radio family operates in the Industrial, Scientific, and Medical (ISM) band of 5.725 to 5.850 GHz, which is generically referred to as 5.8 GHz, and the Unlicensed National Information Infrastructure (U-NII) band of 5.25 to 5.35 GHz, which is generically referred to as 5.3 GHz. The MDS FIVE Series supports three types of user data payload connectivity:

- 100Base-TX intelligent bridging between two locations without the delay and expense of installing cable or traditional microwave.
- Scalable Ethernet capability of 25 and 50 Mbps is included. These scalable radios provide LAN connectivity and offer performance trade-offs between operational bandwidths, data rates, and distance.

- 16E1 or T1 for cellular backhaul, enterprise voice applications and voice network redundancy

For customers such as cellular carriers requiring backhaul and backbone extension as well as service providers requiring network redundancy, new Points of Presence (POPs), and last mile access, the MDS FIVE Series radio is a cost effective alternative to leased lines with carrier-class quality of performance. The MDS FIVE Series is a cost effective solution to meet the growing demand for enterprise Local Area Network (LAN) connectivity between buildings and campuses as well as service providers requiring reliable products for infrastructure expansion, extending Metropolitan Area Network (MAN) fiber access, and network redundancy.

The MDS FIVE Series includes integrated Network Management functionality and design features enabling simple commissioning when the radio network is initially set up in the field at the customer's premises. Furthermore, a highlight of MDS radio products is scalability and the capability to support a ring-type architecture. This ring or consecutive point radio architecture is self-healing in the event of an outage in the link and automatically re-routes data traffic, thereby ensuring that service to the end user is not interrupted.

The MDS FIVE Series is composed of a Software Defined Indoor Unit™ (SDIDU™) and Outdoor Unit (ODU). It supports 1+0 and 1+1 protection and ring architectures in a single 1 RU chassis. The modem and power supply functions are supported using easily replaceable plug-in modules. An additional feature of the SDIDU™ is provision for a second plug-in modem/IF module to provide repeater or east/west network configurations.

The overall architecture consists of a single 1RU rack mount Software Defined Indoor Unit (SDIDU™) with a cable connecting to an Outdoor Unit (ODU) with an external antenna.

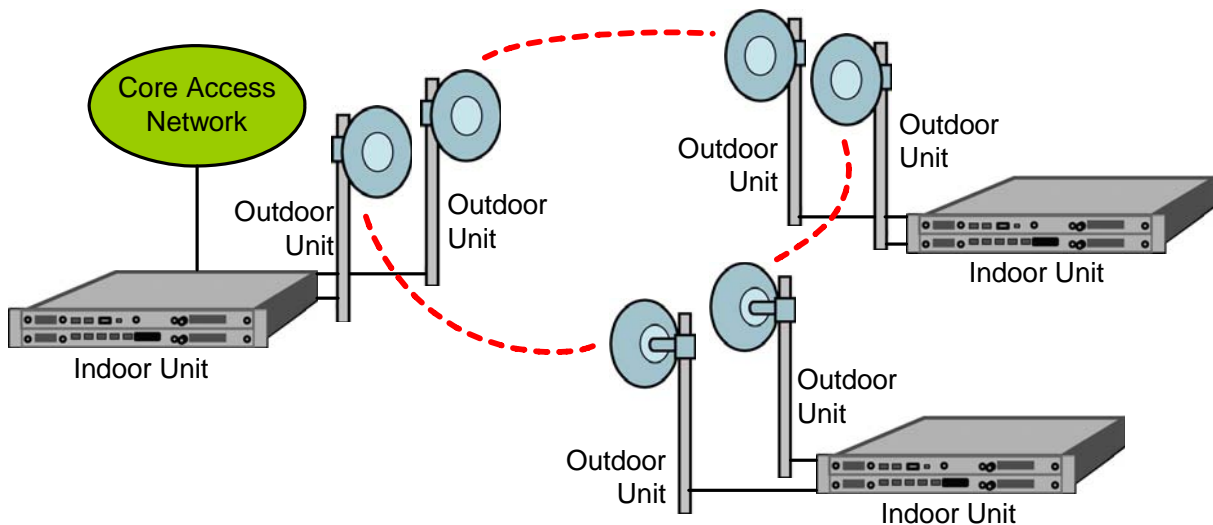

Figure 2-1. MDS FIVE Series SDIDU™ /ODU Architecture

Table 2-1 lists key features that MDS FIVE Series technology offers to those involved in the design, deployment and support of broadband fixed wireless networks.

Table 2-1 Key Benefits and Advantages of MDS FIVE Series Radios

Benefits	Advantages to Providers/Customers	Reference
Wireless license-exempt system		
<p>ISM bands do not require expensive license band fees or incur licensing delays.</p> <p>Wireless connectivity supplements existing cable (Ethernet).</p>	<p>Fast return on investment.</p> <p>Lower total cost of total ownership.</p> <p>Media diversity avoids single points of failure.</p>	<p>2.2 –2.4</p>
Easy to install units		
<p>Straightforward modular system enables fast deployment and activation.</p> <p>Carrier-class reliability.</p>	<p>Fast return on investment.</p> <p>No monthly leased line fees.</p>	<p>3.5</p>
Complete support of payload capacity with additional wayside channels		
<p>Aggregate capacity beyond basic payload (34 Mbps or 50 Mbps or 100 Mbps).</p> <p>Scalable and spectrally efficient system.</p> <p>Separate networks for radio overhead/management and user payload.</p>	<p>Increases available bandwidth of network.</p> <p>Allows customer full use of revenue-generating payload channel.</p> <p>Up to 16 T1/E1 wayside channels supports extension of PBX connectivity between buildings without additional leased-line costs.</p> <p>Lowers total cost of ownership.</p>	<p>2.2– 0</p>
Ring Architecture		
<p>Supports a ring (consecutive point) configuration, thus creating a self-healing redundancy that is more reliable than traditional point-to-point networks.</p> <p>In the event of an outage, traffic is automatically rerouted via another part of the ring without service interruption.</p> <p>Ring/consecutive point networks can overcome line-of-sight issues and reach more buildings than other traditional wireless networks.</p> <p>Networks can be expanded by adding more MDS FIVE Series units or more rings without interruption of service.</p>	<p>Enables network scalability.</p> <p>Increases deployment scenarios for initial deployment as well as network expansion with reduced line-of-sight issues.</p> <p>Increases network reliability due to self-healing redundancy of the network.</p> <p>Minimizes total cost of ownership and maintenance of the network.</p> <p>Allows for mass deployment.</p>	<p>2.6,2.7,2.10</p>

Benefits	Advantages to Providers/Customers	Reference
A separate management channel allows for a dedicated maintenance ring with connections to each MDS FIVE Series Digital Radio on the ring.		
Adaptive Power Control		
Automatically adjusts transmit power in discrete increments in response to RF interference.	Enables dense deployment. Simplifies deployment and network management.	2.12
Comprehensive Link/Network Management Software		
A graphical user interface offers security, configuration, fault, and performance management via standard craft interfaces. Suite of SNMP-compatible network management tools that provide robust local and remote management capabilities.	Simplifies management of radio network and minimizes resources as entire network can be centrally managed out of any location. Simplifies troubleshooting of single radios, links, or entire networks. Simplifies network upgrades with remote software upgrades. Allows for mass deployment.	2.14

2.3 System Features

- Selectable Rates and Interfaces
 - Up to 16 x E1/T1 (wayside channels)
 - 100BaseTX/Ethernet: Scalable 25-100 Mbps
 - DS-3/E-3/STS-1 (option; consult factory for availability)
- Support for multiple configurations
 - 1+0, 1+1 protection/diversity
 - Hot Standby
 - East/West Repeater (2 + 0)
- Selectable Spectral Efficiency of 0.8 to 6.25 bits/Hz (including FEC and spectral shaping effects)

- QPSK, 16 – 64 QAM Modulation
- Powerful Trellis Coded Modulation concatenated with Reed-Solomon Error Correction
- Built-in Adaptive Equalizer
- Support of Voice Orderwire Channels
- Peak output power at antenna port
 - 30 dBm at 5.8 GHz
 - 12 dBm at 5.3 GHz
- Receive Sensitivity: -84 dBm to -72 dBm (depending on data rate/modulation/FEC/ODU)
- Adaptive Power Control
- Built-in Network Management System (NMS)
- Consecutive Point ring architecture
- Built-in performance statistics
 - Built-in Bit Error Rate (BER) performance monitoring
- Data encryption of all payload data and T1/E1 wayside channels for MDS FIVE Series-100 and MDS FIVE Series-50 Ethernet models (Consult factory for availability)

2.4 Physical Description

The following section details the physical features of the MDS FIVE Series digital radios

- Model types
- Front panel indicators
- Front panel connections

2.4.1 Model Types

Table 2-2 lists the MDS FIVE Series digital radios according to model number and associated capabilities of throughput, data interface, and wayside channel. Table 2-3 lists the ODU model numbers.

Table 2-2 MDS FIVE Series SDIDU™ Model Type

PRODUCT NAME	MODEL NUMBER	FULL DUPLEX THROUGHPUT	DATA INTERFACE	WAYSIDE
SDIDU-MD-0001	SDIDU-M1VA11A000	108 Mbps aggregate (54 Mbps full duplex)	100 BaseTX	Two T1/E1s
SDIDU-MD-0003 (includes 28-6066A03)	SDIDU-M1VA31A000	132 Mbps aggregate (66 Mbps full duplex)	1-8xT1/E1	Scalable Ethernet
SDIDU-MD-0002	SDIDU-M1CA11A000	202 Mbps aggregate (101 Mbps full duplex)	100 BaseTX	Two T1/E1s
SDIDU-MD-0004 (includes 28-6066A03)	SDIDU-M1CA31A000	124 Mbps aggregate (62 Mbps full duplex)	1-16xT1/E1	Scalable Ethernet

Table 2-3 MDS FIVE Series ODU Model Types

PRODUCT NAME	MODEL NUMBER	ANTENNA
MDS FIVE Series 5.8 ODU-I	ODU5800MIP	Integrated antenna
MDS FIVE Series 5.8 ODU-E	ODU5800MEP	External antenna required
MDS FIVE Series 5.3 ODU-I	ODU5300MIP	Integrated antenna
MDS FIVE Series 5.3 ODU-E	ODU5300MEP	External antenna required

2.4.2 Options

The following items are also available:

- AC/DC power supply
- Data Encryption
- Upgrade 50Mbps Ethernet systems to 100Mbps capability
- OC-3/STM-1 Mini-IO Module

Please consult the factory for more information.

2.4.3 Front Panel Indicators

All models of the MDS FIVE Series support a variety of front panel configurations that are dependent on the network interface and capacity configurations.

Figure 2-2 provides an example of the MDS FIVE Series 1+0 configuration and the associated LEDs displayed on the SDIDU™ front panel. The controller, standard I/O, and each modem card have a status LED.

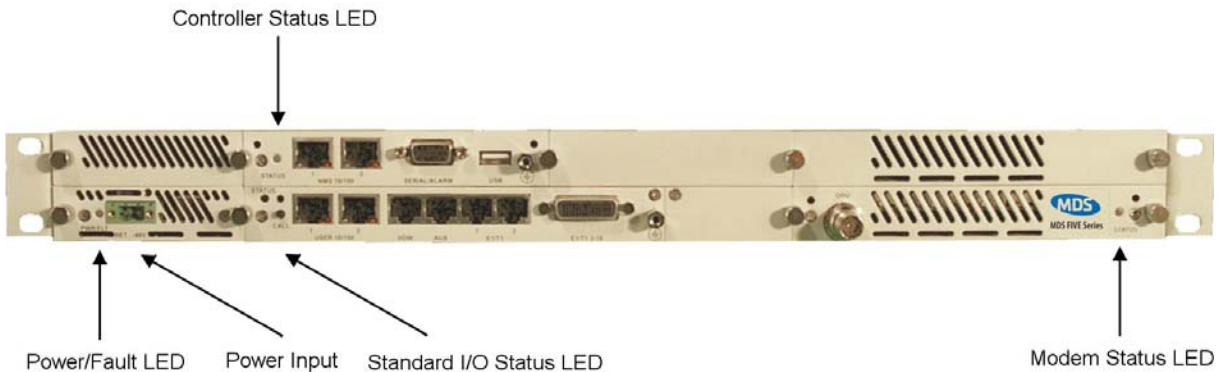

Figure 2-2. MDS FIVE Series LEDs: SDIDU™ Front Panel Configuration for MDS FIVE Series, 1+0 Configuration

The modem status LED indicates the modem status as described in Table 2-4.

Table 2-4. Modem status LED.

LED	STATUS
Green	Active Locked Link
Orange	Standby Locked Link (1+1 Non-Diversity Only)
Flashing Green	Low SNR
Flashing Orange	Unlocked

The controller status LED is the primary front panel indicator of alarms. An alarm is generated when a specific condition is identified and is cleared when the specified condition is no longer detected. When an alarm is posted,

1. The controller status LED turns orange for 5 seconds
2. The controller status LED turns off for 5 seconds

3. The controller status LED flashes orange the number of times specified by the first digit of the alarm code
4. The controller status LED turns off for 3 seconds
5. The controller status LED flashes orange the number of times specified by the second digit of the alarm code

Steps 2-5 are repeated for each alarm posted. The entire process is repeated as long as the alarms are still posted.

The standard I/O and modem status LEDs are set to red when certain alarms are posted. A complete list of alarms is provided in Appendix 6.1.

The alarm description is also displayed in the Graphical User Interface (GUI) as described in the User Interface Reference Manual.

2.4.4 Front Panel Connections

Please refer to the Figure 2-3 for an example of a MDS FIVE Series SDIDU™ front panel followed by a descriptive text of the connections.

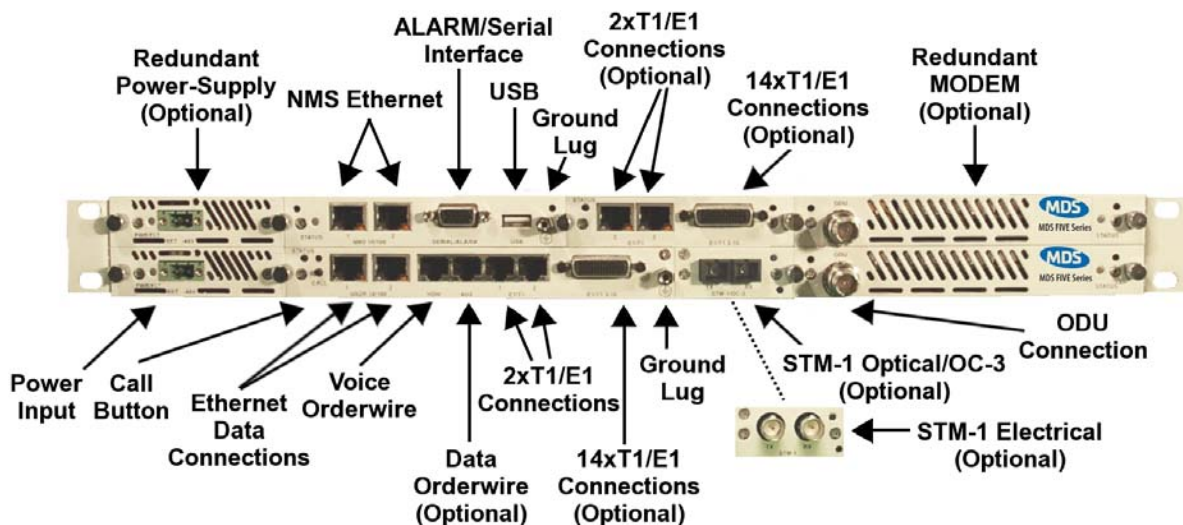

Figure 2-3. SDIDU™ Front Panel Connections

Power Supply Input

<p>DC Input</p> <p>-48 VDC</p>	<p>-48v (Isolated Input); 2-pin captive power connector. The MDS FIVE Series requires an input of -48 volts dc $\pm 10\%$ at the front panel DC Input connector. The total required power is dependent on the option cards and protection configuration (1+0, 1+1). The SDIDU™ front panel power connector pin numbering is 1 through 2, from left to right, when facing the unit front panel. Pin 1 is the power supply return and is connected to unit chassis ground internally. Pin 2 should be supplied with a nominal -48 V dc, with respect to the unit chassis (ground). A ground-isolated supply may be used, provided it will tolerate grounding of its most positive output.</p> <p>The recommended power input is -44 to -52 V dc at 2 Amps minimum. It is recommended that any power supply used be able to supply a minimum of 100 W to the SDIDU™.</p> <p>A mating power cable connector is supplied with the MDS FIVE Series SDIDU™. It is a 2-pin plug, 5 mm pitch, manufactured by Phoenix Contact, P/N 17 86 83 1 (connector type MSTB 2,5/2-STF). This connector has screw clamp terminals that accommodate 24 AWG to 12 AWG wire. The power cable wire should be selected to provide the appropriate current with minimal voltage drop, based on the power supply voltage and length of cable required. The recommended wire size for power cables under 10 feet in length supplying -48 Vdc is 18 AWG.</p> <p>The SDIDU™ supplies the ODU with all required power via the ODU/SDIDU™ Interconnect cable. The MDS FIVE Series SDIDU™ does not have a power on/off switch. When DC power is connected to the SDIDU™, the digital radio powers up and is operational. There can be up to 320 mW of RF power present at the antenna port (external antenna version). The antenna should be directed safely when power is applied.</p>
--	--

Alarm/Serial Interface

Alarms/Serial	DB-15HD female connector for two Form-C relay alarm outputs (rated load: 1A @ 24 VDC), two TTL alarm outputs, four TTL alarm inputs, and Serial Console. The two Form-C relay alarm outputs can be configured to emulate TTL alarm outputs.
----------------------	---

USB Interface

USB	USB connector, reserved.
------------	--------------------------

Voice Orderwire Connector

Call Button	The voice orderwire provides a PTP connection via a PTT handset and buzzer. The call button initiates a ring. Only the SDIDU™'s link partner will receive the ring. VOW does not ring all nodes or support "party line" calls.
Voice Orderwire	RJ-45 modular port connector for voice orderwire interface.

Data Orderwire Connector

Data Orderwire	RJ-45 modular port connector for RS422/RS-232 data at 64 kbps.
-----------------------	--

NMS 10/100 Network Management System Connections

NMS 10/100 1	10/100Base-TX RJ-45 modular local port connector for access to the Network Management System (SNMP) and GUI.
NMS 10/100 2	10/100BaseTX RJ-45 modular remote port connector for access to the Network Management System (SNMP). This port to be used for consecutive point networks.

100/Ethernet Models: Ethernet 100BaseT Connections

USER 10/100 1	100Base-TX RJ-45 modular port connector for the local Fast Ethernet interface.
USER 10/100 1	100Base-TX RJ-45 modular port connector. This port to be used for consecutive point networks.

T1 Channels

T1 1-2	Two T1/E1 (RJ-48C) interface connections.
T1 3-16	Fourteen T1/E1 high density interface connector

Ground Connection

Ground Lug	Two ground lugs are provided on the front panel. Either may be used to connect the SDIDU™ to ground.
-------------------	--

2.5 System Description

The overall digital radio architecture consists of a single 1RU rack mount Software Defined Indoor Unit™ (SDIDU™) with a cable connecting to an Outdoor Unit (ODU). The ODU is available with an integrated antenna or connectors to support an external antenna. Two ODU types are available servicing the 5.8 GHz band or the 5.3 GHz band. This SDIDU™ /ODU architecture is advantageous when compared to a single IDU with external mount antenna since supporting a signal of 5.8 GHz from the IDU rack to the antenna will result in significant signal degradation, which would require expensive coaxial cable or waveguide.

Figure 2-4 shows the SDIDU™ and interfaces from a functional point of view. The functional partitions for the I/O, Modem/IF, and power supply modules are shown. The SDIDU™ comes with the standard I/O capability that can be upgraded. In addition, the Modem/IF function is modular. This allows the addition of a second Modem to support protection or ring architectures. The power supply is similarly modular.

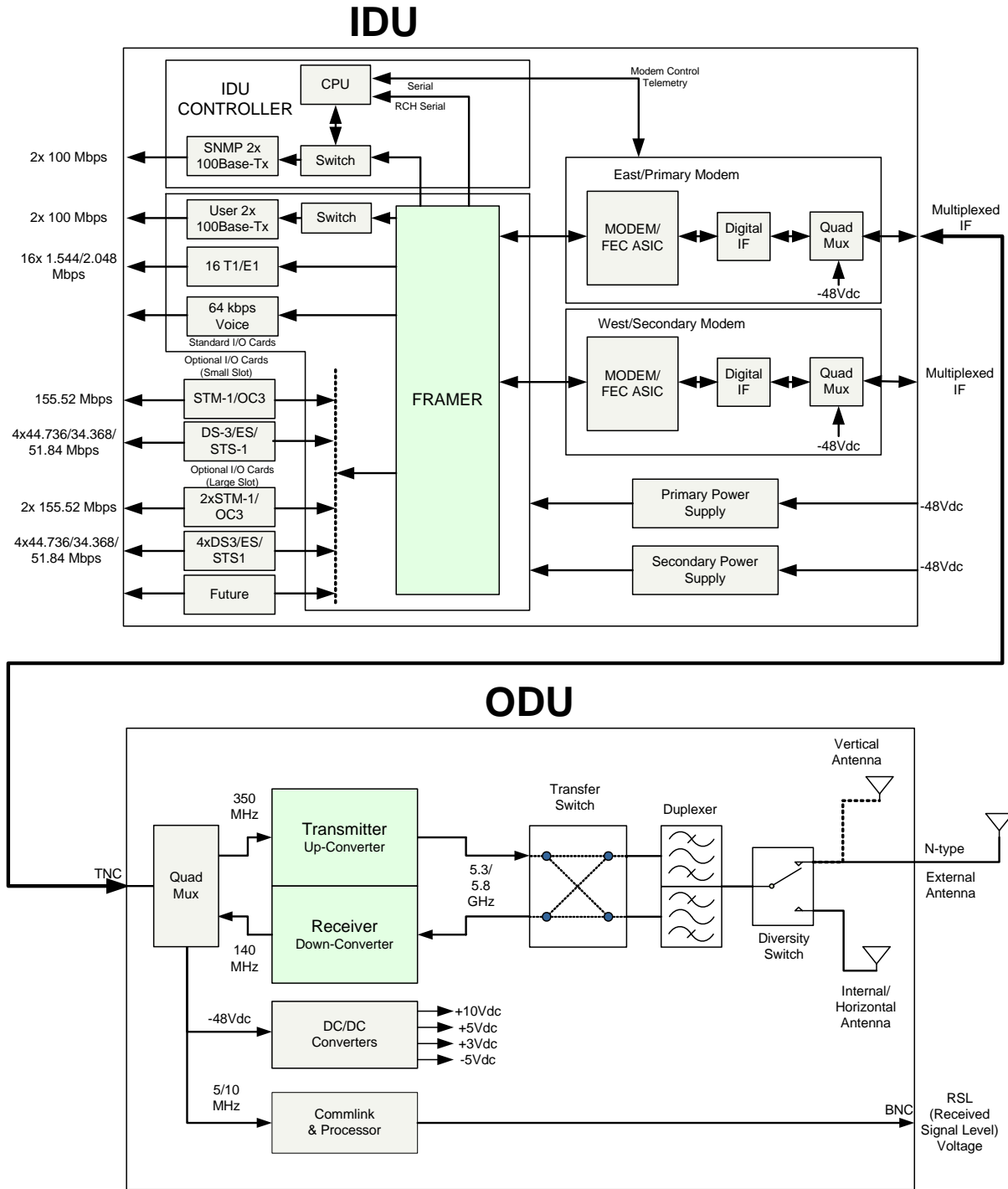

Figure 2-4. MDS FIVE Series System Block Diagram

The SDIDU™ interfaces with the ODU to receive and provide modulated transmit and receive waveforms. The SDIDU™ interfaces provide Fast Ethernet 100Base-T (MDS FIVE Series-100) connections to the network. Contact factory for availability of SONET OC-3 (MDS FIVE Series-155) connections. In addition, two E1/T1 channels are provided for PBX extension. SNMP is provided on 10/100BaseT ports.

The ODU RF Up/Down Converter card provides the interface to the antenna. The transmit section up converts and amplifies the modulated Intermediate Frequency (IF) of 350 MHz from the IF Processor and provides additional filtering. The receive section down converts the received signal, provides additional filtering, and outputs an IF of 140 MHz to the IF Processor. The 64-QAM Modem performs the modulation and demodulation of the payload and forward error correction using advanced modulation and coding techniques. Using all-digital processing, the 64-QAM Modem uses robust modulation and forward error correction coding to minimize the number of bit errors and optimize the radio and network performance. The 64-QAM Modem also scrambles, descrambles and interleaves/deinterleaves the data stream in accordance with Intelsat standards to ensure modulation efficiency and resilience to sustained burst errors. The modulation will vary by application, data rate, and frequency spectrum. The highest order modulation mode supported is 64 Quadrature Amplitude Modulation (QAM). Table 2-5 summarizes the TCM/convolutional code rates for each modulation type supported by the MDS FIVE Series.

Table 2-5. MDS FIVE Series TCM/Convolutional Code Rates

Modulation Type	Available Code Rates
QPSK	1/2, 3/4, 7/8
16-QAM	3/4, 7/8, 11/12
32-QAM	4/5, 9/10
64-QAM	5/6, 11/12

The major functions of the SDIDU™ can be summarized as follows:

- I/O Processing – The SDIDU™ comes with a standard I/O capability that includes support for up to 16xT1/E1 and 2x100Base-TX user payloads, 2x100Base-TX for SNMP, and voice orderwire. In addition, option cards for DS-3/E3/STS-1, 1-2 x STM-1/OC-3, and 4xDS-3/E3/STS-1 may be added. The SDIDU™ architecture is flexible and allows for the addition of other I/O types in the future.
- Switch/Framing – The SDIDU™ includes an Ethernet Switch and a proprietary Framer that are designed to support 1+1 protection switching, ring architecture routing, and overall network control functions.
- Network Processor – The SDIDU™ includes a Network Processor that performs SNMP and Network Management functions.
- Modem/IF – The SDIDU™ Modem performs forward-error-correction (FEC) encoding, PSK/QAM modulation and demodulation, equalization, and FEC decoding functions. The IF chain provides a 350 MHz carrier, receives 140 MHz carrier, processes OOK telemetry, and provides –48V power. Two modems can be used for 1+1 protection or ring architectures.
- Power Supply – The SDIDU™ power supply accepts -48 Vdc and supplies the SDIDU™ and ODU with power. A second redundant power supply may be added as an optional module.

The Modem Processor and its associated RAM, ROM, and peripherals control the digital and analog Modem operation. It also provides configuration and control for both the IF and I/O cards. The

SDIDU™ interfaces with the ODU to receive and provide modulated transmit and receive waveforms.

The SDIDU™ also provides the physical interface for the user payload and network management. In transmit mode, the Frammer merges user payload with radio overhead-encapsulated network management data. This combined data stream is transmitted without any loss of user bandwidth. In the receive mode, the Frammer separates the combined data stream received from the 64-QAM Modem. The SDIDU™ supports Scalable Ethernet data rates, such as 25 or 50 Mbps via the 100BaseT data interface port. The SDIDU™ provides network management data on 10 Mbps ports accessible via the 10/100BaseTX port. The Central Processor Unit (CPU) provides the embedded control and network element functionality of the NMS. The CPU also communicates with other functions within the SDIDU™ for configuration, control, and status monitoring.

In Ethernet models, the payload of each user Ethernet data packet and all T1 can be encrypted using an AES encryption algorithm. In addition, the encryption engine is re-seeded with a new, randomly generated key stream every 10 seconds, in order to provide enhanced security. The initial key is based off of a pass phrase entered into each MDS FIVE Series unit by the network administrator. Consult factory for the availability of this encryption function.

The power supply converts -48 Vdc to the DC voltage levels required by each component in the system.

2.6 Consecutive Point Architecture

The consecutive point network architecture is based upon the proven SONET/SDH ring. Telecommunications service providers traditionally use the SONET/SDH ring architecture to implement their access networks. A typical SONET/SDH network consists of the service provider's Point of Presence (POP) site and several customer sites with fiber optic cables connecting these sites in a ring configuration (see Figure 2-5). This architecture lets providers deliver high bandwidth with high availability to their customers.

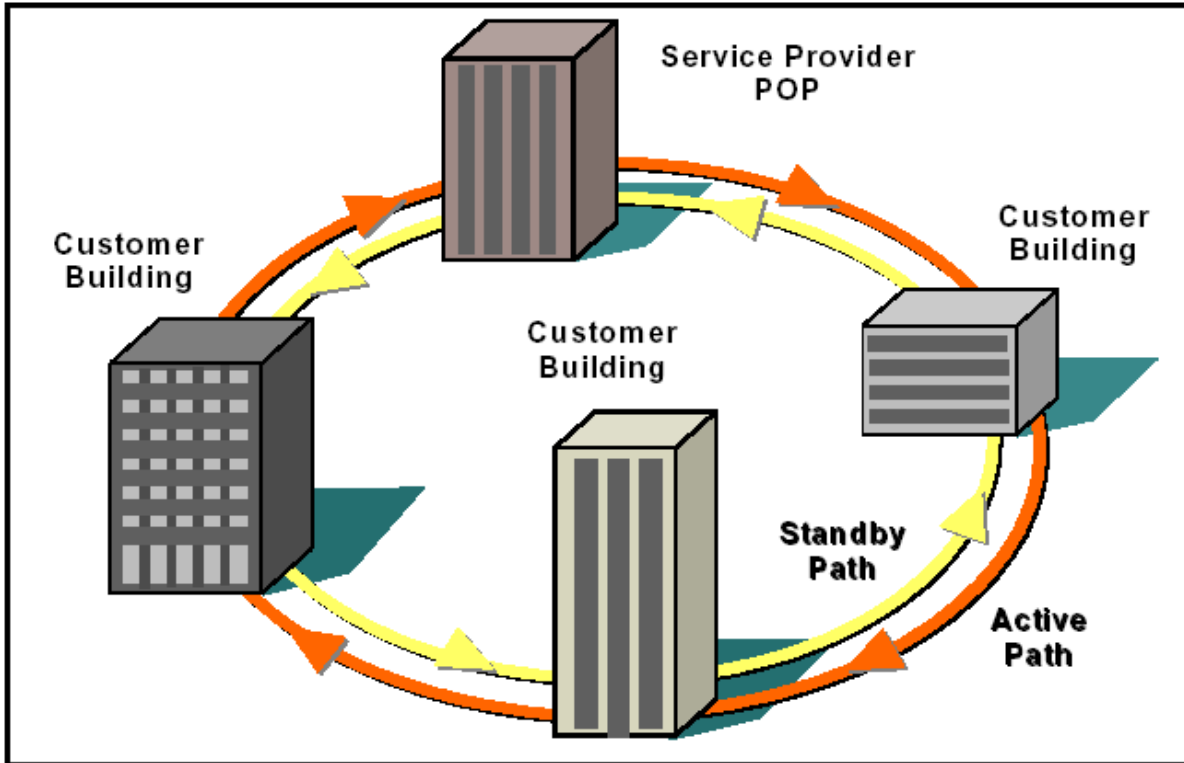

Figure 2-5. Ring Configuration.

SONET/SDH rings are inherently self-healing. Each ring has both an active path and a standby path. Network traffic normally uses the active path. Should one section of the ring fail, the network will switch to the standby path. Switchover occurs in seconds. There may be a brief delay in service, but no loss of payload, thus maintaining high levels of network availability.

The consecutive point architecture implemented in the MDS FIVE Series Digital Radio family is based on a point-to-point-to-point topology that mimics fiber rings, with broadband wireless links replacing in-ground fiber cable. A typical consecutive point network consists of a POP and several customer sites connected using MDS FIVE Series units. These units are typically in a building in an east/west configuration. Using east/west configurations, each unit installed at a customer site is logically connected to two other units via an over-the-air radio frequency (RF) link to a unit at an adjacent site.

Each consecutive point network typically starts and ends at a POP. A pattern of wireless links and in-building connections is repeated at each site until all buildings in the network are connected in a ring as shown in Figure 2-6. . For 2 x 1+0 and 2 x 1+1 nodes payload and NMS connections need to be jumpered between two SDIDU™s. For 1 x 2+0 nodes, there is no need for jumpers as there is a single SDIDU™. For SDH or SONET payloads, the configuration is similar but an external add/drop mux and a second SDH/SONET interface card are required.

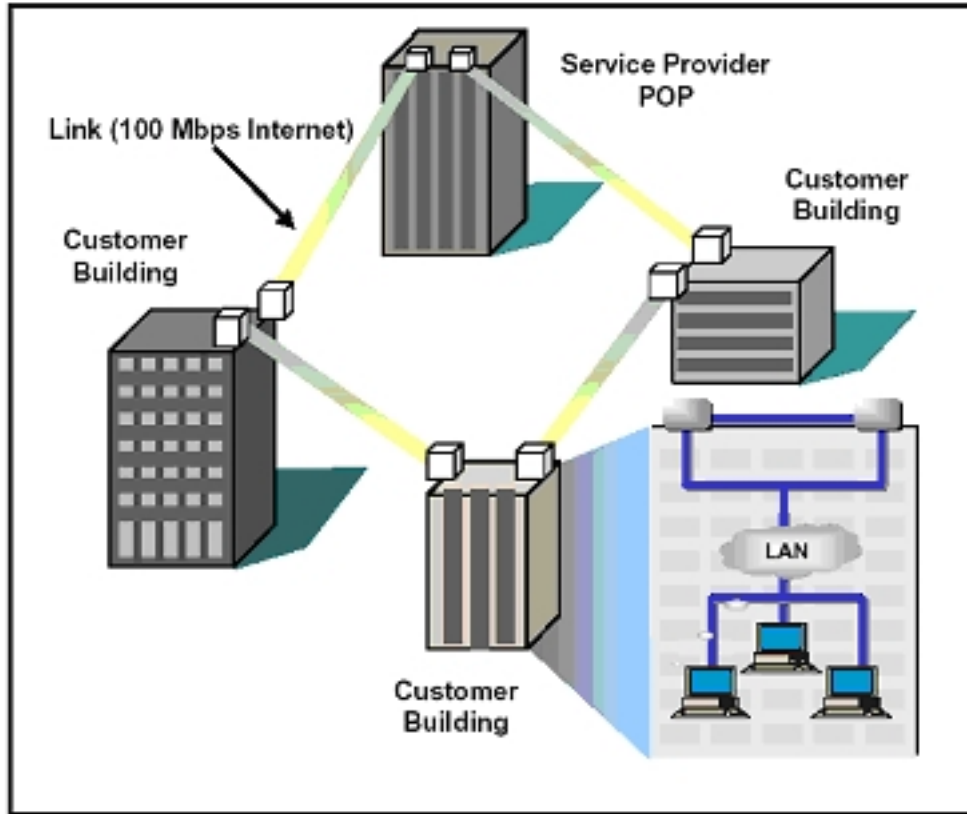

Figure 2-6. Consecutive Point Network

2.7 2 + 0 (East-West) Configuration

The SDIDU™ supports an east/west, or 2+0, configuration that allows a consecutive point architecture to be achieved with only a single 1 RU chassis at each location. In this configuration the SDIDU™ contains two modems supplies and may contain two power supplies. One modem is referred to as the west modem and the other as the east modem. The SDIDU™ is connected to two ODUs, one broadcasting/receiving in one direction of the ring architecture and the other broadcasting/receiving in the other as shown in Figure 2-7.

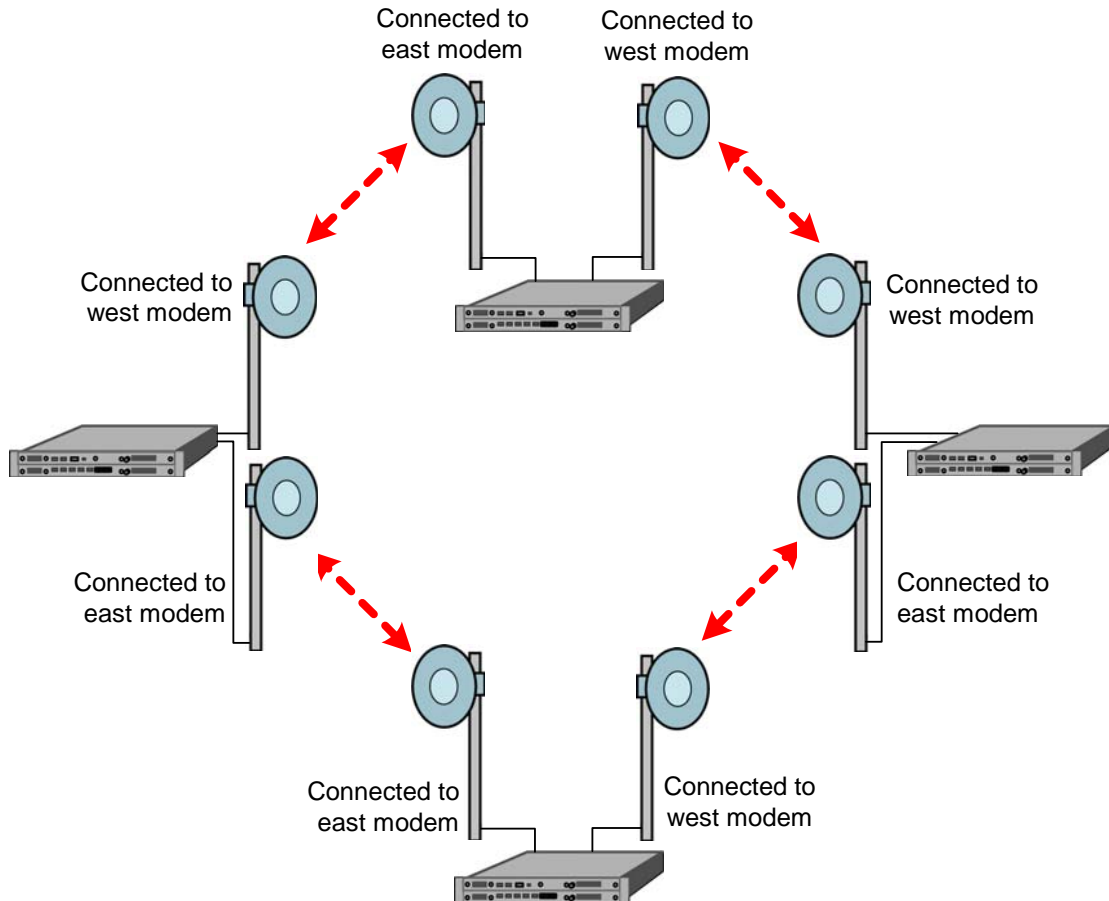

Figure 2-7. 2+0 (East-West) configuration.

2.8 Spanning Tree Protocol (STP)

Spanning Tree Protocol STP keeps Ethernet loops from forming in a ring architecture. Without STP, loops would flood a network with packets. STP prevents loops by creating an artificial network break. In the event of a network outage, STP automatically removes the artificial break, restoring connectivity.

2.9 1+1 Protection

The MDS FIVE Series supports 1+1 protection as an option for a critical link. In this configuration, protection is provided in a single 1 RU chassis. The SDIDU™ contains two power supplies and two modems. The power supply, ODU, IF/telemetry and modem are protected. The digital framing and LIUs are not. One modem is referred to as the west modem and the other as the east modem. 1+1 protection can be run in two modes called Protected Non-Diversity and Protected Diversity.

2.9.1 Protected Non-Diversity (Hot Standby)

Figure 2-8 **Error! Reference source not found.** shows operation in Protected Non-Diversity mode, also called Hot Standby. In this mode, one ODU at each location transmits to two ODUs at the other location. This mode does not require the extra bandwidth or interference protection. It provides hitless receive switching and hot standby. The SDIDU™ automatically switches transmit ODU upon appropriate ODU alarm or ODU interface error, minimizing transmit outage time.

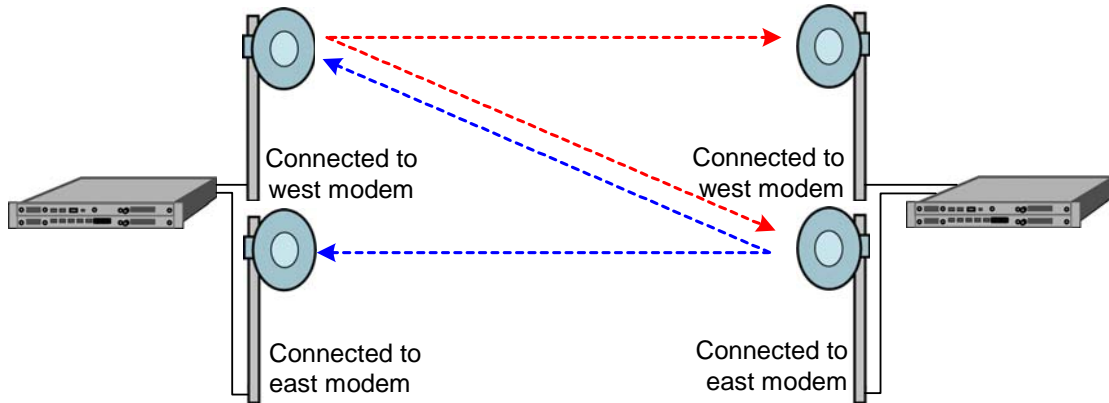

Figure 2-8. 1+1 protection in non-diversity mode

2.9.2 Protected Diversity

In Protected Diversity mode, the link between each pair of modems is the same, as shown in Figure 2-9 **Error! Reference source not found.**, providing complete redundancy. This arrangement requires bandwidth for both links and non-interference between the links, but it provides hitless receive and transmit switching. The SDIDU™ supports both frequency and spatial diversity.

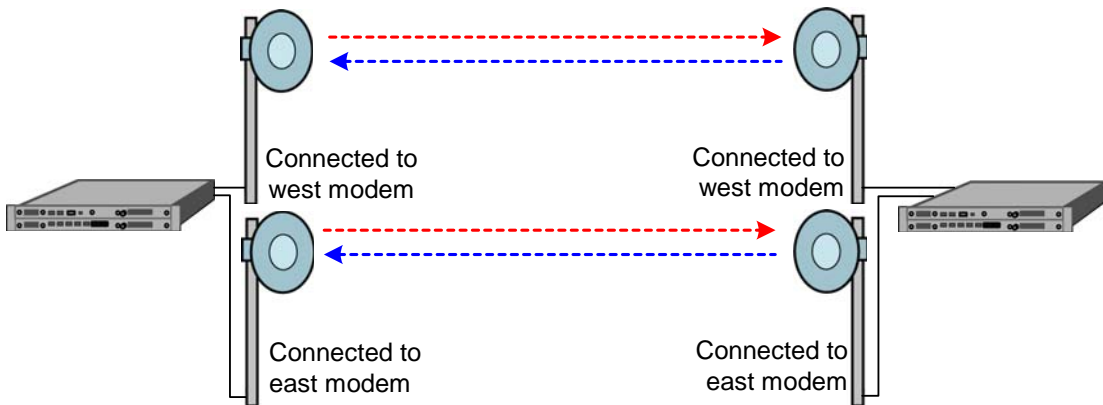

Figure 2-9. 1+1 protection in diversity mode

2.9.2.1 Frequency Diversity

In frequency diversity, two frequencies are used to achieve non-interference. The proprietary framer chooses the best, or error-free, data stream and forwards it to the Line Interface Units (LIUs).

2.9.2.2 Spatial Diversity

In spatial diversity, two non-interfering paths are used. The proprietary framer chooses the best, or error-free, data stream and forwards it to the Line Interface Units (LIUs).

2.9.2.2.1 Single Transmitter

Protected Non-Diversity, or Hot Standby, is also referred to as Single Transmitter Spatial Diversity. For more information on this mode, see Section 2.9.1.

2.9.2.2.2 Dual Transmitter

When using Dual Transmitter Spatial Diversity, two active transmitters are physically isolated to avoid crosstalk.

2.10 1 + 1 Multi-hop Repeater Configuration

The MDS FIVE Series supports a 1 + 1 multi-hop repeater configuration with drop/insert capability as shown in Figure 2-10. This configuration provides individual 1 + 1 link protection as described in section 2.8, as well as the full-scale protection inherent in the consecutive point architecture as described in section 2.6. At each location within the network, data may be dropped or inserted. Front panel connections for drop/insert capability are shown in Figure 2-11. In this configuration each SDIDU™ contains two power supplies and two modems.

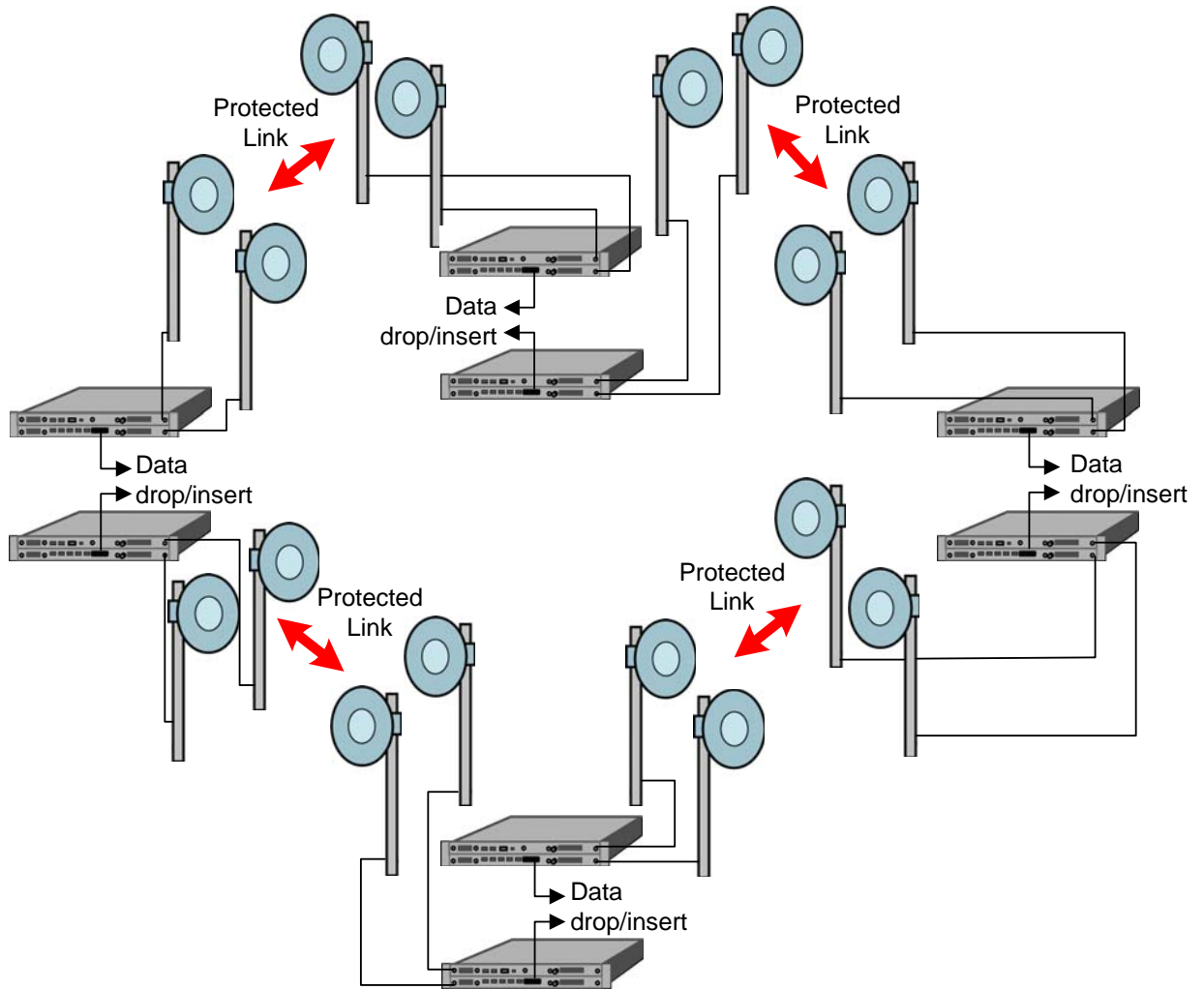

Figure 2-10. 1 + 1 Multi-hop Repeater Configuration

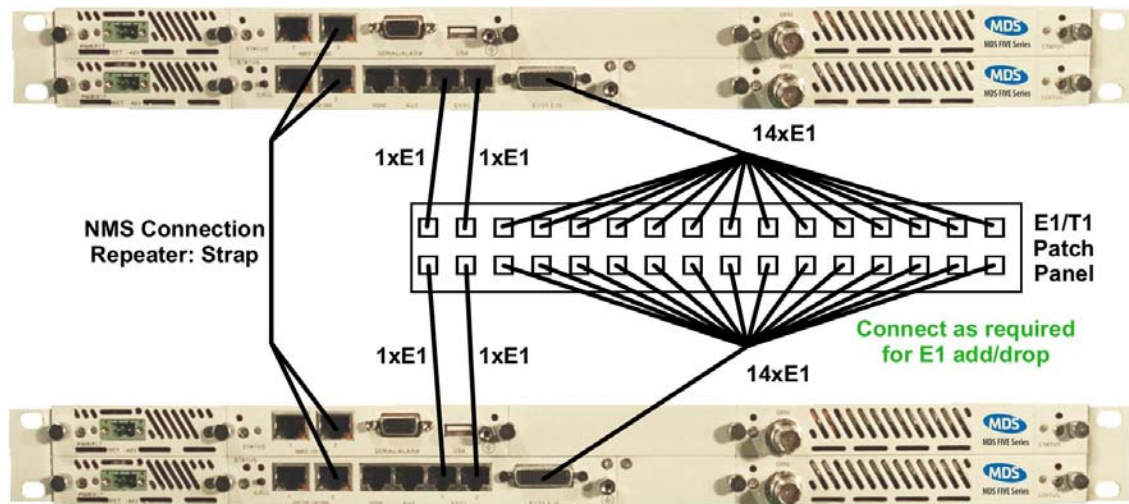

Figure 2-11. Front Panel connections in 1 + 1 multi-hop repeater configuration

2.11 Data Interfaces

The I/O card has 2x100BaseTX interfaces that can be configured as either primary payload, or secondary wayside channels. The Over-the-air channel has a data-bandwidth capacity that is set by the frequency-bandwidth, modulation, and coding. The data-bandwidth may be allocated to various I/O card interfaces, including 155.52 Mbps for STM-1, 2 Mbps per E1, up to 100 Mbps Ethernet, and up to 1 Mbps NMS. Only up to 100 Mbps of data-bandwidth may be allocated for either net data, and the two I/O card 100BaseTX interfaces will share that 100 Mbps data-bandwidth.

There is also an option mini-I/O card, which provides STM-1 Optical/OC-3 or STM-1 Electrical interfaces. The optical interface is single mode at 1300 nm. Consult factory for availability of Mini-IO STM-1/OC-3 Module.

2.12 Crosspoint Switch

The SDIDU™ crosspoint switch provides any-to-any E1/T1 routing between front panel ports and RF links, as shown in Figure 2-12. Flexible channel mapping allows selection from predefined routings or custom routing. Custom routings are uploaded to the SDIDU™ via FTP. Two examples of the crosspoint capability are to use the crosspoint switch to configure a repeater or an add/drop. These examples are shown in Figure 2-13. In the repeater example, the Crosspoint Switch is used as a passthrough to send E1/T1s from the east modem to the west modem. In the add/drop example, the crosspoint switch connects E1/T1s from the modems to the front-panel ports.

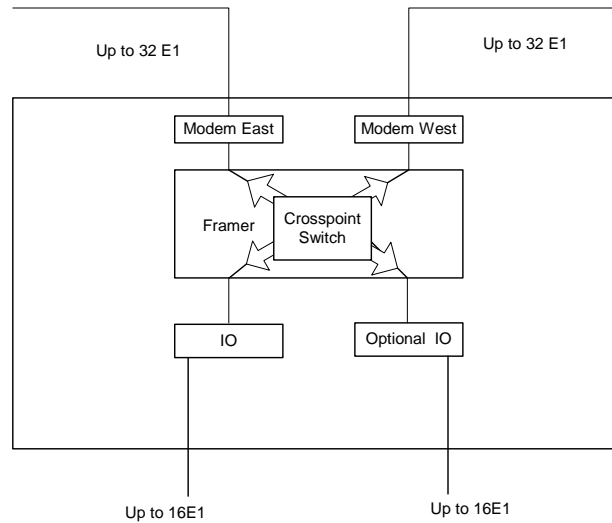

Figure 2-12 Crosspoint switch

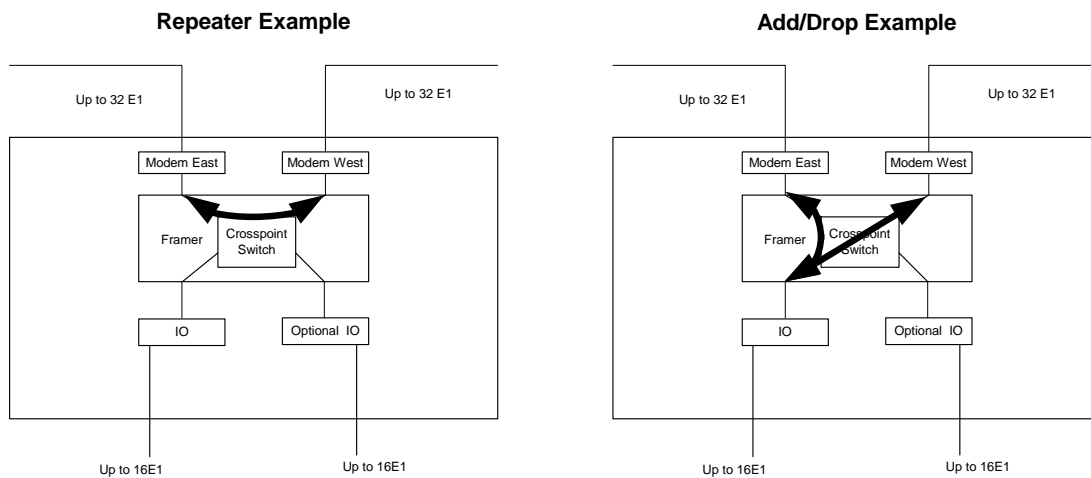

Figure 2-13 (a) Crosspoint switch used a passthrough in repeater configuration. (b) Crosspoint switch allows access for add/drop.

2.13 Power Management

RF power management is a radio design feature that controls the power level (typically expressed in dBm) of the RF signal received from a transmitter by a receiver. The traditional goal of power management is to ensure that the RF signal at a receiver is strong enough to maintain the radio link under changing weather and link conditions.

Traditional power management techniques such as Constant Transmit Power Control (CTPC) and Automatic Transmit Power Control (ATPC) transmit at a high power level to overcome the effects of fading and interference. However, these techniques continue to operate at a higher power level than needed to maintain the link in clear weather. Because transmit power remains high when the weather clears, the level of *system interference* increases.

Radios operating at high transmit power will interfere with other radios, even if the interfering source is miles away from the victim. High interference levels can degrade signal quality to the point that wireless radio links become unreliable and network availability suffers. The traditional solution to system interference is to increase the distance between radios. However, the resulting sparse deployment model is inappropriate for metropolitan areas.

In response to the need for a high-density deployment model the MDS FIVE Series use a unique power control technique called A_d TPC. A_d TPC enables MDS FIVE Series units to transmit at the minimum power level necessary to maintain a link regardless of the prevailing weather and interference conditions. The MDS FIVE Series is designed and manufactured to not exceed the +30 dBm maximum power allowed. The purpose of power management is to minimize transmit power level when lower power levels are sufficient. A_d TPC also extends the concept of power management by controlling not only the power (dBm) of the RF signal, but its quality (signal-to-noise ratio) as well.

In contrast to ATPC, the A_d TPC technique dynamically adjusts the output power based on both the actual strength and quality of the signal. Networked MDS FIVE Series units constantly monitor receive power and maintain 10^{-12} BER performance under varying interference and climate conditions. Each MDS FIVE Series unit can detect when there is a degradation in the received signal level of quality and adjust the transmit power level of the far-end MDS FIVE Series unit to correct for it.

A_d TPC provides maximum power in periods of heavy interference and fading and minimum power when conditions are clear. Minimal transmit power reduces potential for co-channel and adjacent channel interference with other RF devices in the service area, thereby ensuring maximum frequency re-use. The resulting benefit is that operators are able to deploy more MDS FIVE Series units in a smaller area.

2.14 MDS FIVE Series Software and Network Management

All of the MDS FIVE Series parameters are accessible in three ways:

1. Using a standard web-browser via HTTP to access the built in webserver.
2. Via SNMP using the fully featured MIB, allowing for automation of data collection and network management.
3. Via a command line client accessible from a terminal client connected to the serial port, or telnet over the NMS Ethernet.

The GUI, SNMP, and CLI control are discussed in the MDS FIVE Series User Interface Manual.

2.14.1 IP Address

Each SDIDU™ is configured independently for network parameters such as IP address, subnet, and gateway. However, the SDIDU™ also supports acting as a DHCP client, in which case the IP address can be assigned to the SDIDU™ using a DHCP server. A specific IP address may be associated with a particular SDIDU™ by configuring the DHCP server to server IP address based upon the SDIDU™ Ethernet MAC address.

2.14.2 Network

The SDIDU™ uses an “Out-of-Band” NMS network which is separated from the payload Ethernet network. Each SDIDU™ contains a managed Layer 2 Ethernet switch that supports Spanning-Tree Protocol (STP) for managing NMS traffic. This allows the SDIDU™ to be configured in a protected ring configuration where the STP will prevent an Ethernet loop in the ring. This will allow the ring to re-configure in the event of an outage. The SDIDU acts as a network bridge via the Ethernet switch and STP. The SDIDU™ does not currently support NMS routing capability.

2.14.3 NMS Network Operational Principles

The SDIDU™ does not provide routing capability. Therefore, all SDIDUs™ must be on the same subnet as the PC being used to access the SDIDUs™. If the SDIDUs™ and/or the PC are on different subnets, a router must be used, with the gateway addresses set appropriately. Figure 2-14 shows the PC and both SDIDUs™ in the same subnet. In this case, no router is required. Figure 2-15 shows the PC and one of the SDIDUs™ in one subnet and the other SDIDU™ in another. In this case, a router is required. Note how the GW addresses are set to allow communication from the PC to the SDIDU™ in the other subnet.

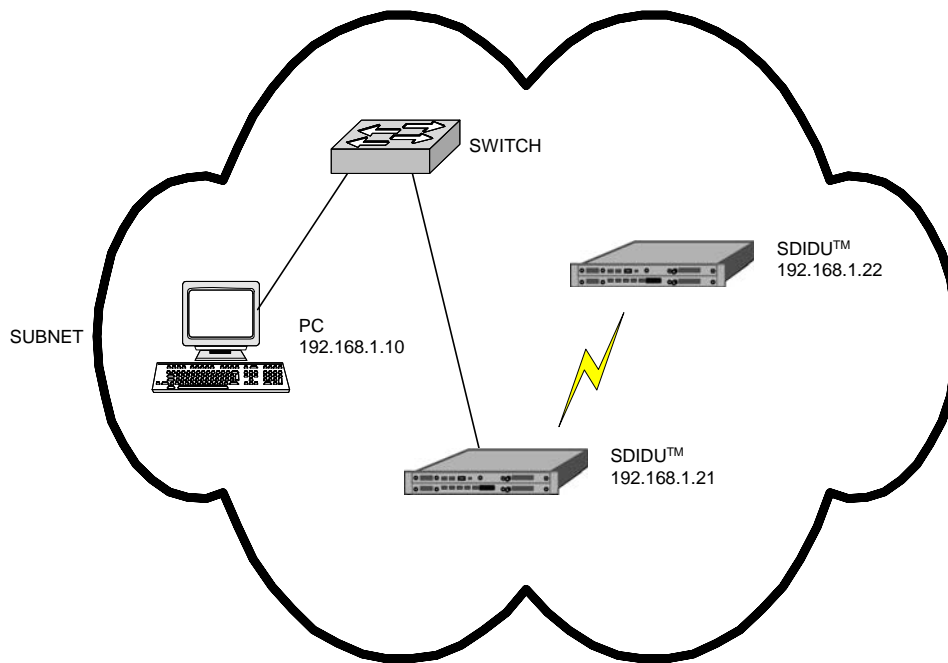

Figure 2-14. PC and SDIDUs™ on same subnet

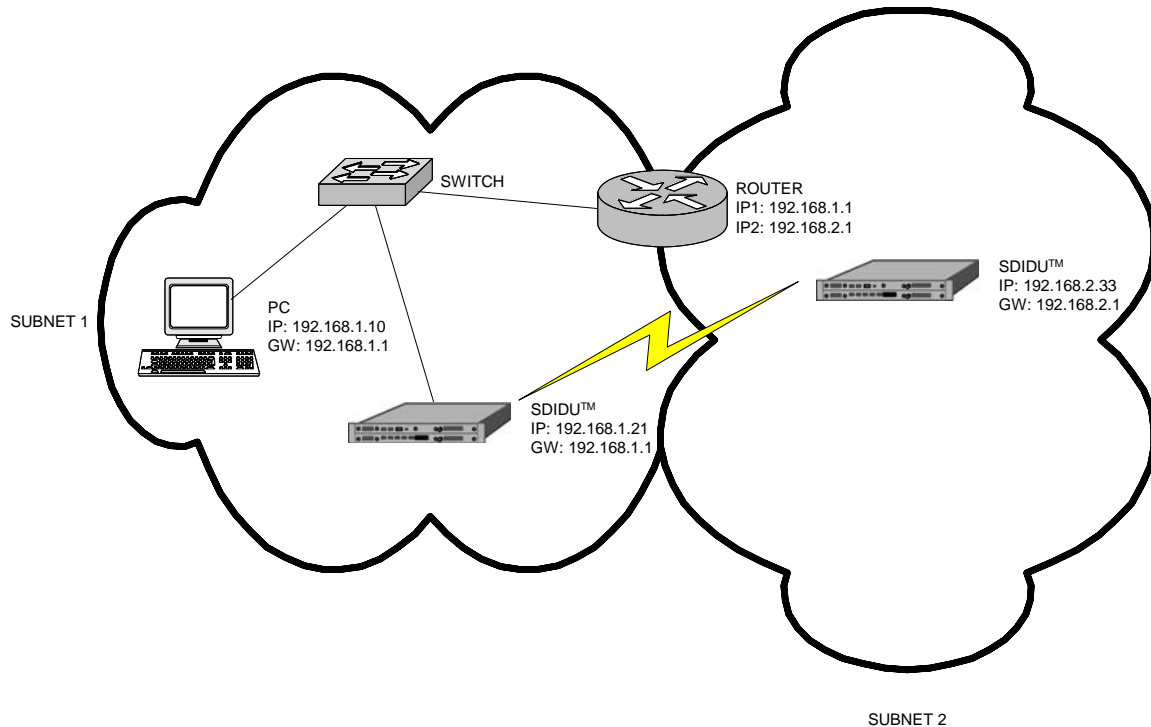

Figure 2-15. SDIDUs™ on different subnets.

2.14.4 Third Party Network Management Software Support

The SDIDU™ supports SNMPv1, SNMPv2, and SNMPv3 protocols for use with third party network management software. The SNMP agent will send SNMP traps to specified IP addresses when an alarm is set or cleared. Information contained in the trap includes:

- IP address
- System uptime
- System time
- Alarm name
- Alarm set/clear detail

The SDIDU™ may also be managed via HTTP, TELNET, and SSH protocols.

2.15 System Loopbacks

The SDIDU™ provides system loopbacks as a means for test and verification of a unit, link, and/or network. A variety of loopback points, included LIU selection, are available, Loopback

points are easily selected through the Graphical User Interface, for more information see the User Interface Guide. Loopback duration is also selectable.

3 Installation

3.1 Unpacking

The following is a list of possible included items.

Description	Quantity
Digital Radio SDIDU™ (1RU chassis)	1
ODU (with hardware)	1
Manual and/or Quick Start Guide	1

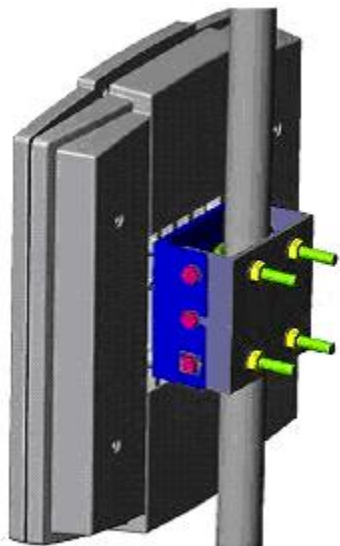

ODU



SDIDU™

Figure 3-1. MDS FIVE Series Components

Be sure to retain the original boxes and packing material in case of return shipping. Inspect all items for damage and/or loose parts. Contact the shipping company immediately if anything appears damaged. If any of the listed parts are missing, call the distributor or the factory immediately to resolve the problem.

3.2 Notices

CAUTION

DO NOT OPERATE EXTERNAL ANTENNA ODU UNITS WITHOUT AN ANTENNA, ATTENUATOR, OR LOAD CONNECTED TO THE ANTENNA PORT. DAMAGE MAY OCCUR TO THE TRANSMITTER DUE TO EXCESSIVE REFLECTED RF ENERGY.

ALWAYS ATTENUATE THE SIGNAL INTO THE RECEIVER ANTENNA PORT TO LESS THAN -20 dBm. THIS WILL PREVENT OVERLOAD AND POSSIBLE DAMAGE TO THE RECEIVER MODULE.

WARNING

HIGH VOLTAGE IS PRESENT INSIDE THE ODU and SDIDU™ WHEN THE UNIT IS PLUGGED IN. TO PREVENT ELECTRICAL SHOCK, UNPLUG THE POWER CABLE BEFORE SERVICING. UNIT SHOULD BE SERVICED BY QUALIFIED PERSONNEL ONLY.

3.3 Required Tools

The following tools are needed for installation.

3.3.1 SDIDU™ Tools

- 1/8" Slotted screwdriver for securing power supply connector
- Screwdriver for rack mount assembly. Size and types depends on rack mount screws (not included).

3.3.2 ODU Tools

- 13 mm or adjustable wrench for ODU bracket mounting bolts
- 17 mm or adjustable wrench for U-Bolt

3.4 PRE-INSTALLATION NOTES

It may be useful to gain familiarity with the MDS FIVE Series via back-to-back bench testing prior to final installation. We highly recommend installation of lightning protectors on the ODU/SDIDU™ Interconnect Cable to prevent line surges from damaging expensive components.

Back-to-back bench testing prior to final installation is highly recommended in order to gain familiarity with the product. The following additional equipment is required for back-to-back testing:

- Low-loss cables, N-male connectors on ODU interfaces.
- Two inline RF attenuators, 30 dB each, rated for ODU frequency.

The SDIDU™ and ODUs must be configured in an operational configuration and set-up as shown in Figure 3-2. When equipment is connected in operational configuration, no errors should be reported on the front panel.

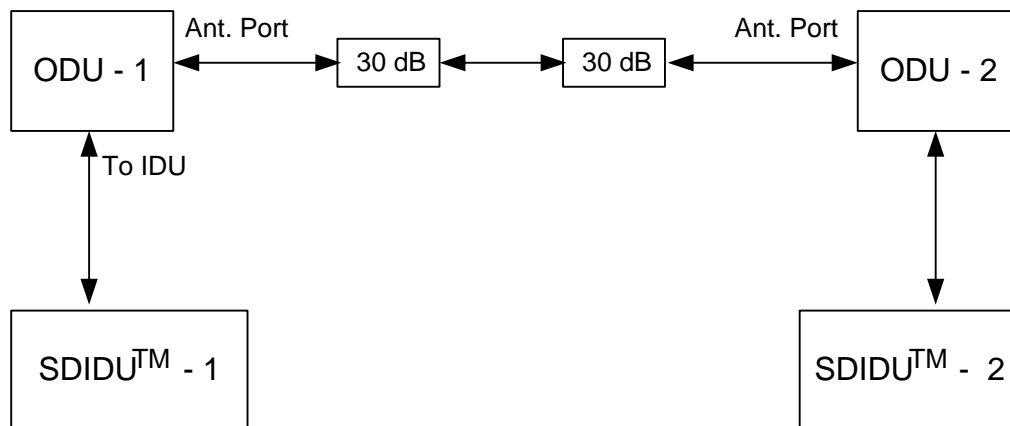

Figure 3-2. MDS FIVE Series Back-to-Back Testing Configuration

3.5 Overview of Installation and Testing Process

The installation and testing process is accomplished by performing a series of separate, yet interrelated, procedures, each of which is required for the successful implementation of a production MDS FIVE Series network. These procedures are as follows:

- Site Evaluation: gathering specific information about potential MDS FIVE Series installation sites.

- Cable and Installation: Testing and installing MDS FIVE Series ODU cables and optional interface devices at installation sites.
- MDS FIVE Series ODU Mounting and Alignment: Mounting ODUs to a pole or wall, performing link alignment and radio frequency (RF) verification.
- MDS FIVE Series Digital Radio Configuration: Using MDS FIVE Series Link Manager software to install network- and site-specific parameters in the radios.
- MDS FIVE Series Digital Radio Testing: Performing cable continuity checks and RF tests for links, the payload/radio overhead channel, and the management channel.

The following diagram shows where installation and commissioning resides within the MDS FIVE Series network deployment life cycle and defines the sequence in which the processes that comprise installation and commissioning should be performed.

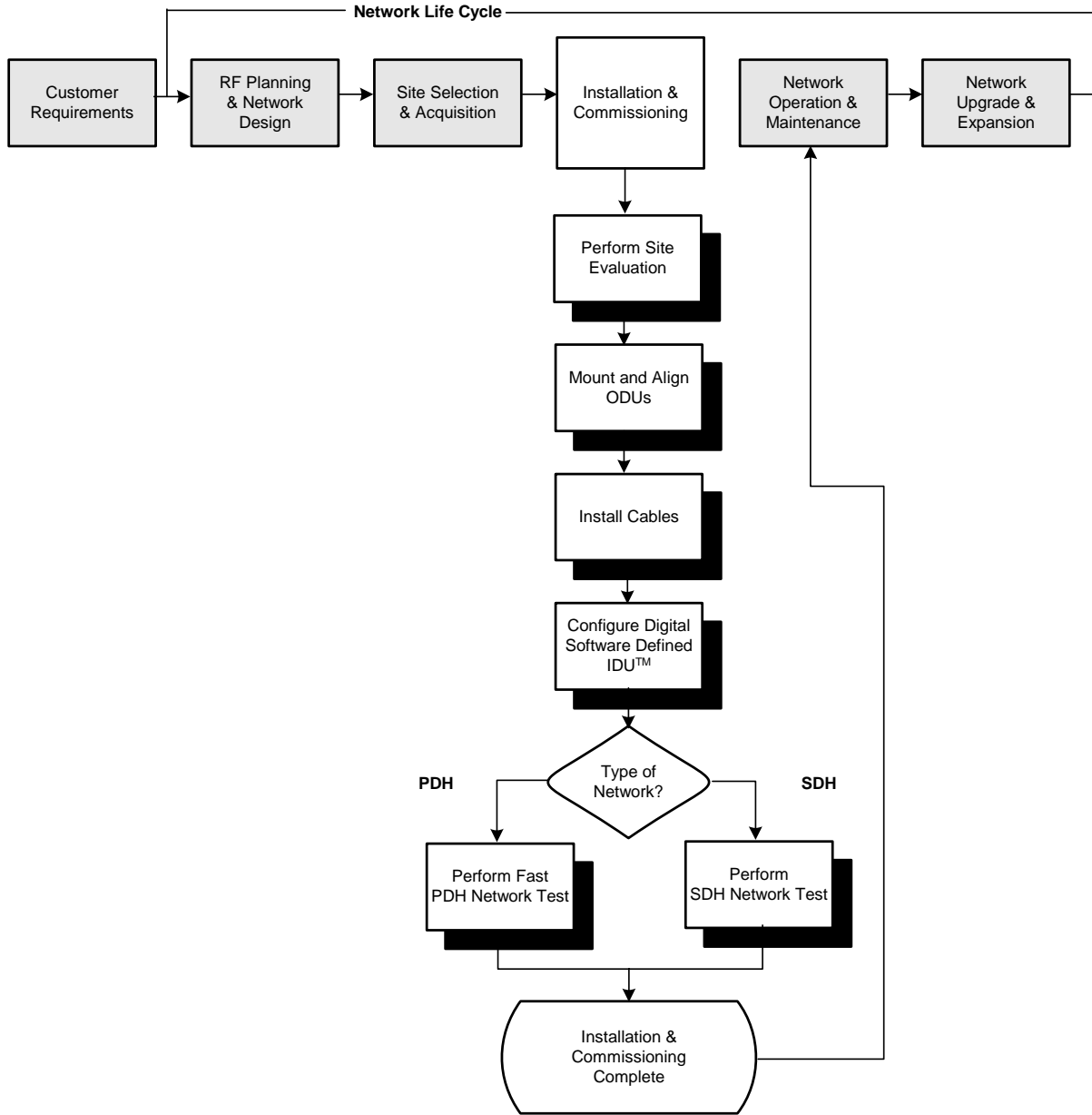

03-01-013b

3.6 Site Evaluation

A site evaluation consists of a series of procedures for gathering specific information about potential MDS FIVE Series locations. This information is critical to the successful design and deployment of a network.

Site evaluations are required to confirm whether or not a building meets network design requirements. The main objectives are as follows:

- Confirm
 - Line of sight for each link
 - MDS FIVE Series ODU mounting locations
 - Site equipment locations
 - Cable routes
 - Any other potential RF sources
- Prepare site drawings and record site information

3.6.1 Preparing for a Site Evaluation

The following tools are required to perform a site evaluation:

- RF and network design diagrams (as required)
- Binoculars
- Global positioning system (GPS) or range finder
- Compass
- Measuring tape and/or wheel
- Digital camera
- Area map
- Aerial photograph (if available)
- List of potential installation sites (“targeted buildings”)

The following tasks must be completed prior to performing a site evaluation:

- Prepare the initial network design by performing the following:
 - Identify potential buildings by identifying targeted customers (applicable if you’re a service provider)
 - Identify potential links by selecting buildings based on the high probability of line of sight
- Arrange for access with the facility personnel into the buildings, equipment rooms, and architectural plans to become familiar with the location of all ducts, risers, etc.

3.6.2 Site Evaluation Process

The following steps must be completed to perform a successful site evaluation. Each step in the process is detailed in the following subparagraphs:

- Ensure RF Safety compliance: Ensure that appropriate warning signs are properly placed and posted at the equipment site or access entry. For a complete list of warnings, refer the Safety Precautions listed at the beginning of this manual.
- Ensure Compliance with Laws, Regulations, Codes, and Agreements: Ensure that any installation performed as a result of the site evaluation is in full compliance with applicable federal and local laws, regulations, electrical codes, building codes, and fire codes.
- Establish Radio Line of Sight between MDS FIVE Series Radios: **The most critical step in conducting a site evaluation is confirming a clear visual and radio Line of Sight (LOS) between a near MDS FIVE Series Radio and a far MDS FIVE Series Radio. If LOS does not exist, another location must be used.**

MDS FIVE Series Radios in a link must have a clear view of each other, or visual “line of sight”. Binoculars may be used evaluate the path from the desired location of the near MDS FIVE Series Radio to the desired location of the far MDS FIVE Series Radio.

To confirm Line of Sight:

- Ensure that no obstructions are close to the transmitting/receiving path. Take into consideration trees, bridges, construction of new buildings, unexpected aerial traffic, window washing units, etc.
- Ensure that each MDS FIVE Series can be mounted in the position required to correctly align the MDS FIVE Series with its link partner.

MDS FIVE Series Radios must also have a clear radio line of sight. If a hard object, such as a mountain ridge or building, is too close to the signal path, it can damage the radio signal or reduce its strength. This happens even though the obstacle does not obscure the direct, visual line of sight. The Fresnel zone for a radio beam is an elliptical area immediately surrounding the visual path. It varies in thickness depending on the length of the signal path and the frequency of the signal. The necessary clearance for the Fresnel zone can be calculated, and it must be taken into account when designing a wireless links.

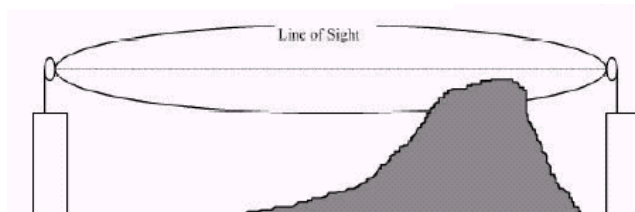

As shown in the picture above, when a hard object protrudes into the signal path within the Fresnel zone, knife-edge diffraction can deflect part of the signal and cause it to reach the receiving antenna slightly later than the direct signal. Since these deflected signals are out of phase with the direct signal, they can reduce its power or cancel it out

altogether. If trees or other 'soft' objects protrude into the Fresnel zone, they can attenuate (reduced the strength of) a passing signal. In short, the fact that you can see a location does not mean that you can establish a quality radio link to that location. Microwave Data Systems provides a link planner spreadsheet that calculates the Fresnel ratio and helps determine link feasibility. Contact your technical support representative for a copy of the spreadsheet.

- Determine MDS FIVE Series ODU Mounting Requirements: MDS FIVE Series ODUs can be mounted on an antenna mast, brick, masonry or wall. Refer to detailed installation sections.
- Determine MDS FIVE Series SDIDU™ Installation Location: MDS FIVE Series SDIDUs™ can be installed tabletop or cabinet, wall mount, or rack mount. The site must provide DC power or an optional AC/DC converter may be used. Refer to detailed installation sections.
- Document Potential Sources of Co-location Interference: When MDS FIVE Series ODUs are located on a roof or pole with other transmitters and receivers, an interference analysis may be required to determine and resolve potential interference issues. The interference analysis needs to be performed by an RF engineer. The specific information required for each transmitter and receiver includes the following:
 - Transmitting and/or receiving frequency
 - Type of antenna
 - Distance from MDS FIVE Series ODU (horizontal and vertical)
 - Polarity (horizontal or vertical)
 - Transmit power level
 - Antenna direction
- Measure the Link Distance: The two ways to measure link distance are as follows:
 - GPS: record the latitude and longitude for the near and far MDS FIVE Series ODU sites and calculate the link distance. Record the mapping datum used by the GPS unit and ensure the same mapping datum is used for all site evaluations in a given network.
 - Range finder: measure the link distance (imperial or metric units may be used).

Once the link distance has been measured, verify that the link distance meets the availability requirements of the link. Microwave Data Systems has created a spreadsheet tool that calculates the link availability based on the details of the link. The Microsoft Excel spreadsheet is available on internet, at <http://www.microwavedata.com/>, and is shown on the following page. The following parameters should be entered (items in yellow):

- Operating Frequency: Enter 5800 or 5300

- Transmit Antenna Gain: Enter 23 for the internal antenna or enter the gain of the external antenna if used.
- Transmit Output Power: Selectable between +5 to +23dB (5.8 GHz) and -18 to +5 (5.3 GHz) in 1 dB steps.
- Receive Antenna Gain: Enter 23 for the internal antenna or enter the gain of the external antenna if used.
- Link Distance: Enter distance in miles or kilometers (must select the correct units: miles or kilometers)
- Fresnel Clearance Ratio: This is a factor indicating the radio line of sight. A clear radio line of site has a fresnel clearance ratio of +0.60. As the curvature of the earth or other obstacles degrade the radio line of sight, the ratio can drop to -1. A separate spreadsheet is provided to calculate the appropriate ratio. In this spreadsheet the path length, tower heights and heights of any obstructions or ridges in the path of the link are entered.
- Climate Factor: Enter 0.1 for dry, 0.25 for average and 0.5 for humid environments
- Terrain Factor: Enter 0.25 for mountainous, 1 for average, and 4 for smooth (water)
- Determine the Length of Interconnect Cable from ODU to SDIDU™: The primary consideration for the outdoor interconnect cable from the ODU to SDIDU™ is the distance and route between the ODU and SDIDU™. Maximum cable lengths are listed in Table 3-1.

Table 3-1. Maximum cable lengths

Cable Type	Loss at (dB/100 m)		Maximum Length*
	140 MHz	350 MHz	
LMR-200	12.6	20.1	100 m
LMR-300	7.6	12.1	165 m
LMR-400	4.9	7.8	256 m
RG-214	8	13.1	153 m
Belden 7808	8.6	14	143 m

* Does not account for connector loss.

The link availability, dispersive fade margin and expected signal strength readings are calculated based on the entered parameters. Maximum link distances based on the antenna and transmitter power settings are also displayed.



MDS FIVE series Link Planner: 5.3GHz Availability

Parameter	Value
Operating Frequency (MHz)	5300
Transmit Antenna Gain (dBi)	23
Transmitter Output Power (dBm)	6
Receive Antenna Gain (dBi)	23
Link Distance	3.93 miles
Fresnel Clearance Ratio ^{1,2}	0.60
Climate Factor	0.25
Terrain Factor	1

MDS FIVE series Mode 5.3GHz Band	Modem Data Rate (Mbps)	Channel Bandwidth (MHz)	Receiver Sensitivity ³ (dBm)	Link Fade Margin (dB)	ODU RSSI (dBm)	Availability (%)
5.3G-25FE1	31.112E+6	30.0	-83	12	-71	99.9987
5.3G-25FE2	31.112E+6	20.0	-82	11	-71	99.9984
5.3G-25FE3	31.112E+6	13.3	-82	11	-71	99.9984
5.3G-50FE1	56.733E+6	30.0	-80	9	-71	99.9975
5.3G-50FE2	56.733E+6	20.0	-77	6	-71	99.9950
5.3G-50FE3	56.733E+6	13.3	-72	1	-71	99.9845
5.3G-100FE1	107.797E+6	30.0	-73	2	-71	99.9876
5.3G-16E1-2	36.918E+6	20.0	-82	11	-71	99.9984
5.3G-16T1-2	28.655E+6	20.0	-84	13	-71	99.9990
5.3G-16E1-3	36.918E+6	13.3	-82	11	-71	99.9984
5.3G-16T1-3	28.655E+6	13.3	-84	13	-71	99.9990

Note1: FCC's definition; negative clearance indicates no optical LOS; range is [-1, ..., 0.6]; 0.6 is radio LOS condition.

Note2: Accounting for single knife-edge diffraction loss only.

Note3: BER << 1e-6.

Note4: Listed data rates includes 2 E1 Wayside channels, except for 16E1/T1 modes.

MDS FIVE series Mode	Modulation and Code Rate	Receiver Sensitivity ³ (dBm)	Max Distance (<i>miles</i>) for Various Availability		
			99.9%	99.99%	99.999%
5.3G-25FE1	QPSK 3/4	-83	9	5	3
5.3G-25FE2	16QAM 3/4	-82	9	5	3
5.3G-25FE3	16QAM 3/4	-82	9	5	3
5.3G-50FE1	16QAM 3/4	-80	8	5	3
5.3G-50FE2	32QAM 4/5	-77	7	4	2
5.3G-50FE3	64QAM 11/12	-72	5	3	2
5.3G-100FE1	32QAM 9/10	-73	5	3	2
5.3G-16E1-2	16QAM 3/4	-82	9	5	3
5.3G-16T1-2	16QAM 3/4	-84	9	6	3
5.3G-16E1-3	16QAM 7/8	-82	9	5	3
5.3G-16T1-3	16QAM 7/8	-84	9	6	3



Path Length (Km)	10
TX Tower Height (m)	30
RX Tower Height (m)	30
Frequency (MHz)	5800
Calculated Fresnel Clearance Ratio	0.48

MDS FIVE series Link Planner: Fresnel Zone Clearance

Distance from TX (Km)	Optical LOS Height (m)	1st Fresnel Zone Radius (m)	1st Fresnel Zone Height (m)	Radio LOS (60% Fresnel Clearance) Zone Height (m)	Earth Curvature ¹ (m)	Obstruction Height (m)	Total Earth Terrain Height (m)	Fresnel Clearance Ratio
0.0	30.0	0.0	30.0	30.0	0.0	0.0	0.0	-
0.3	30.0	3.5	26.5	27.9	0.1	0.0	0.1	8.42
0.5	30.0	5.0	25.0	27.0	0.3	0.0	0.3	6.00
0.8	30.0	6.0	24.0	26.4	0.4	0.0	0.4	4.95
1.0	30.0	6.8	23.2	25.9	0.5	0.0	0.5	4.32
1.3	30.0	7.5	22.5	25.5	0.6	0.0	0.6	3.91
1.5	30.0	8.1	21.9	25.1	0.8	0.0	0.8	3.61
1.8	30.0	8.6	21.4	24.8	0.8	20.0	20.8	1.06
2.0	30.0	9.1	20.9	24.5	0.9	10.0	10.9	2.10
2.3	30.0	9.5	20.5	24.3	1.0	10.0	11.0	2.00
2.5	30.0	9.8	20.2	24.1	1.1	23.0	24.1	0.60
2.8	30.0	10.1	19.9	23.9	1.2	24.0	25.2	0.48
3.0	30.0	10.4	19.6	23.8	1.2	0.0	1.2	2.76
3.3	30.0	10.6	19.4	23.6	1.3	0.0	1.3	2.70
3.5	30.0	10.8	19.2	23.5	1.3	0.0	1.3	2.65
3.8	30.0	11.0	19.0	23.4	1.4	0.0	1.4	2.60
4.0	30.0	11.1	18.9	23.3	1.4	10.0	11.4	1.67
4.3	30.0	11.2	18.8	23.3	1.4	0.0	1.4	2.54
4.5	30.0	11.3	18.7	23.2	1.5	0.0	1.5	2.53
4.8	30.0	11.3	18.7	23.2	1.5	0.0	1.5	2.52
5.0	30.0	11.4	18.6	23.2	1.5	0.0	1.5	2.51
5.3	30.0	11.3	18.7	23.2	1.5	0.0	1.5	2.52
5.5	30.0	11.3	18.7	23.2	1.5	0.0	1.5	2.53
5.8	30.0	11.2	18.8	23.3	1.4	0.0	1.4	2.54
6.0	30.0	11.1	18.9	23.3	1.4	0.0	1.4	2.57
6.3	30.0	11.0	19.0	23.4	1.4	0.0	1.4	2.60
6.5	30.0	10.8	19.2	23.5	1.3	18.5	19.8	0.94
6.8	30.0	10.6	19.4	23.6	1.3	0.0	1.3	2.70
7.0	30.0	10.4	19.6	23.8	1.2	0.0	1.2	2.76
7.3	30.0	10.1	19.9	23.9	1.2	0.0	1.2	2.84
7.5	30.0	9.8	20.2	24.1	1.1	0.0	1.1	2.94
7.8	30.0	9.5	20.5	24.3	1.0	0.0	1.0	3.05
8.0	30.0	9.1	20.9	24.5	0.9	0.0	0.9	3.20
8.3	30.0	8.6	21.4	24.8	0.8	0.0	0.8	3.38
8.5	30.0	8.1	21.9	25.1	0.8	0.0	0.8	3.61
8.8	30.0	7.5	22.5	25.5	0.6	0.0	0.6	3.91
9.0	30.0	6.8	23.2	25.9	0.5	0.0	0.5	4.32
9.3	30.0	6.0	24.0	26.4	0.4	0.0	0.4	4.95
9.5	30.0	5.0	25.0	27.0	0.3	0.0	0.3	6.00
9.8	30.0	3.5	26.5	27.9	0.1	0.0	0.1	8.42
10.0	30.0	0.0	30.0	30.0	0.0	0.0	0.0	-

Note1: Earth Curvature is based on a spherical Earth model with a nominal radius of 6371Km and a typical K-factor of 1.33.

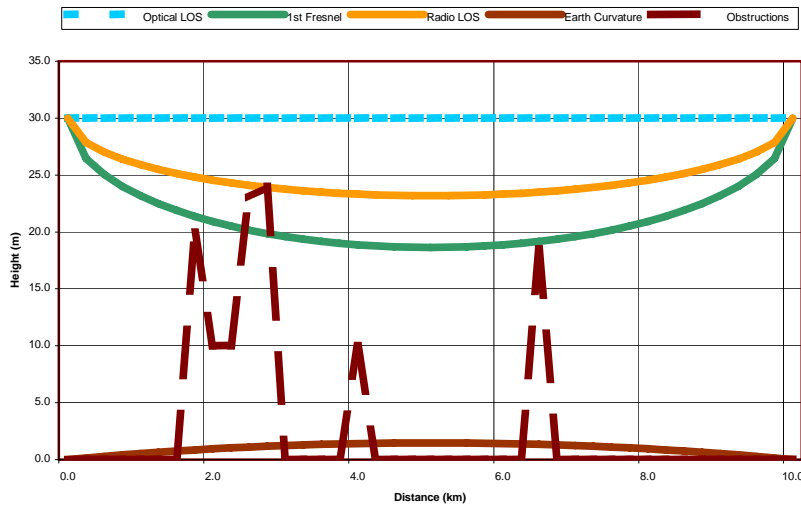

Select the Grounding Location for both the MDS FIVE Series ODU and SDIDU™: The MDS FIVE Series must be properly grounded in order to protect it and the structure it is installed on from lightning damage. This requires

- Grounding all ODUs as specified by supplier
- Grounding all SDIDU™ to the rack.
- Confirm the Presence of DC Power for the MDS FIVE Series SDIDU™.
- Ensure Building Aesthetics: Ensure that the ODU can be mounted so that it is aesthetically pleasing to the environment and to the property owner. Aesthetics must be approved by the property owner and the network engineer.
- Take Site Photographs
- Sketch the Site

3.6.3 Critical System Calculations

3.6.3.1 Received Signal Level (RSL) and Link Budget

The received signal level (RSL) can be estimated using the following formula:

$$\text{RSL (dBm)} = P_{\text{TX}} + G_{\text{TX ANT}} - L_{\text{Path}} + G_{\text{RX ANT}}$$

Where: P_{TX} is the transmitter output power (in dBm)

$G_{\text{TX ANT}}$ is the gain of the transmit antenna (in dB), 23 dBi for ODU's internal antenna

$G_{\text{RX ANT}}$ is the gain of the receive antenna (in dB), 23 dBi for ODU's internal antenna

L_{Path} is the Path loss, defined by:

$$L_{\text{P}} \text{ (dB)} = 36.6 + 20\log_{10}(F \cdot D)$$

Where: F is the Frequency in MHz (5800 or 5300), D is the Distance of path in miles

This link budget is very important in determining any potential problems during installation. The expected RSL and measured RSL should be close (+/- 5 to 10 dB)

3.6.3.2 Fade Margin Calculation

The fade margin is the difference between the actual received signal and the MDS FIVE Series Radio's threshold for the modulation mode selected. The fade margin can be used to determine availability and should be at least 10 dB.

3.6.3.3 Availability Calculation

Availability of the microwave path is a prediction of the percent of time that the link will operate without producing an excessive BER due to multipath fading. Availability is affected by the following:

- Path length
- Fade margin
- Frequency
- Terrain (smooth, average, mountainous, valleys)
- Climate (dry, temperate, hot, humid)

Depending on the type of traffic carried over the link and the overall network design redundancy, fade margin should be included to support the desired availability rate. Critical data and voice may require a very high availability rate (99.999% or 5.3 minutes of predicted outage per year). To improve availability, the fade margin can be increased by shortening the path length, transmitting at a higher power level, or by using higher gain antennas.

Availability can be computed using the following formula, which is known as the *Vigants Barnett Method*.

$$\text{Availability} = 100 \times (1 - P)$$

$$P = 2.5 \times 10^{-9} \times C \times F \times D^3 \times 10^{(-FM/10)}$$

Where F is the frequency in MHz (5300 or 5800)

D is the distance in miles

FM is the fade margin in dB

C is the climate/terrain factor as defined below:

Humid/Over Water: C = 4 (worst case channel)

Average Conditions: C = 1

Dry/Mountains: C = 0.25 (best case channel)

Example: Assume 21 dB fade margin, over 5 miles with average climate/terrain, at 5.8 GHz. The availability comes out to be 99.9986. This corresponds to the link being unavailable for 7.6 minutes per year.

3.6.4 Frequency Plan Determination

When configuring MDS FIVE Series units in a point-to-point or consecutive point configuration, careful engineering of the MDS FIVE Series frequency plans and antenna locations should be performed in order to minimize potential interference between nearby radios. Nearby radios should operate on different frequencies, transmitting in the same band (high side or low side).

When designing multi-radio configurations, antenna size, antenna polarization, and antenna location are critical.

The frequency plan must be selected based on desired data rate and expected link conditions. In a high interference environment or with lower gain antennas, higher bandwidth, more robust modulation formats must be employed. The available frequency plans are illustrated in Figure 3-3 and Figure 3-4.

The channel assignments shown in the figures correspond to the channel numbers entered via the graphical user interface (GUI) or SNMP.

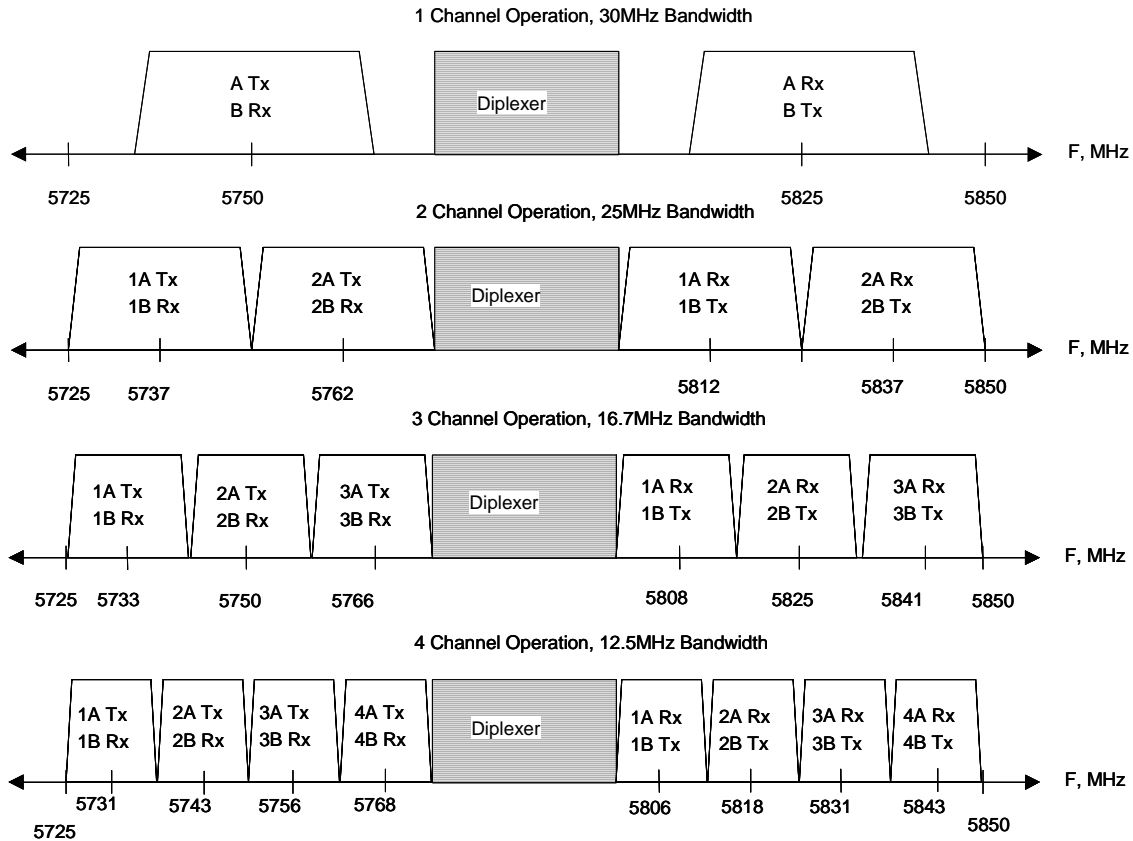

Figure 3-3. MDS FIVE Series Channel 5.8 GHz Frequency Plan

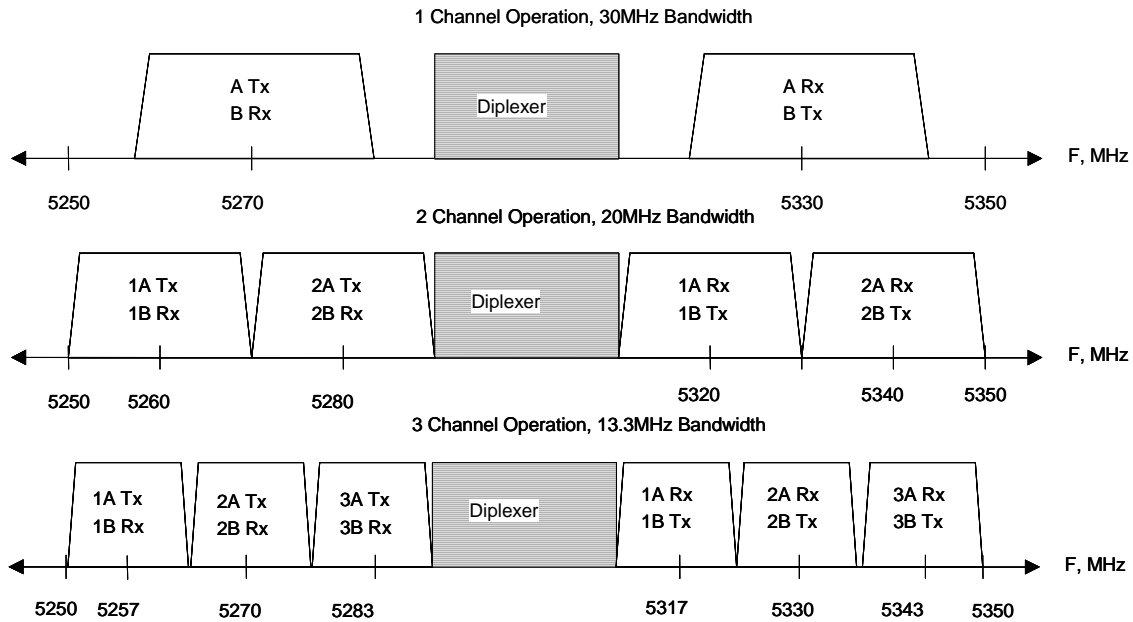

Figure 3-4. MDS FIVE Series Channel 5.3 GHz Frequency Plan

3.6.5 Antenna Planning

The ODU comes with a built in 23 dBi gain antenna. This should provide adequate link performance for most applications.

Larger antennas have the advantage of providing narrower beamwidths and high isotropic gain, which yields better link performance (higher fade margin, better availability), and improves immunity to spatial interference (due to the smaller beamwidths). However, larger antennas are more costly to purchase and install than smaller antennas and in some cases, they require special equipment for installation due to narrower beamwidths. They are also more easily affected by wind.

Only directional antennas can be used with MDS FIVE Series radios. Consult factory for antenna manufacturer options.

The ISM (5.8 GHz) band does not restrict antenna gain or EIRP, therefore there is no need to back off transmit power due to excessive antenna gain.

1. Select where the cable will enter the building from the outside.
2. Determine the length of cable required. Allow three extra feet on each end to allow for strain relief, as well as any bends and turns.

3.6.6 ODU Transmit Power Setup

Setting the ODU transmit power is conditional on the band and application. The installer of this equipment is responsible for proper selection of allowable power settings. If there are

any questions on power settings refer to your professional installer in order to maintain the FCC legal ERP limits.

The SDIDU™ employs spectrally efficient shaped Quadrature Amplitude Modulation (QAM). This waveform is not a constant envelope waveform. Therefore, the average power and peak power are different. The difference in peak and average power depends on the constellation type and shaping factor, where spectral efficiency such as more constellation points or lower shaping factor leading to peak powers higher than average powers. The peak power is typically 5-7 dB greater than the average power in the SDIDU™, and never exceeds 7 dB. Regulatory requirements are usually based on peak EIRP which is based on peak power and antenna gain.

3.6.6.1 5.8 GHz Band

For fixed point-to-point applications in the United States the maximum EIRP (Effective Isotropic Radiated Power) is unlimited when using directional antennas in accordance with FCC part 15.247b(3). The ODU 5800 may therefore be operated at its maximum output power, +23 dBm, for maximum system gain.

EIRP is calculated for link budget with external antennas as,

$$\text{EIRP(avg) dBm} = \text{External Antenna Gain (dBi)} + 23 \text{ dBm}$$

For internal antenna (23 dBi) EIRP is,

$$\text{EIRP(avg)} = 46 \text{ dBm}$$

3.6.6.2 5.3 GHz Band

In the 5.3 GHz U-NII band the peak EIRP (Effective Isotropic Radiated Power) is limited to +30 dBm at the antenna for bandwidths above 20 MHz and is reduced for narrower bandwidths in accordance with FCC part 15.407a(3).

The installer is responsible during set up of transmit power to not exceed FCC limits on transmission power. These maximum power levels are provided in Table 3-1 for both internal antenna and external antenna ODU configurations, along with the operational bandwidths.

Note that though regulatory limits are stated in terms of peak power, the system transmit power levels are calibrated as averaged power readings. Average power is used for link calculations. Therefore the levels provided in the following table is average power levels that have been certified to correspond with the maximum peak EIRP allowed.

3.6.6.2.1 ODU with Internal Antenna

Table 3-1 indicates the maximum average transmit power setting that may be selected ODU 5300 with internal (23 dBi) antenna.

The number of supported channels per band (low band or high band) is shown in the link configuration wizard. The greater number of channels supported the lower the emission bandwidth for each channel.

For link budget, $EIRP(Avg) = 23 \text{ dBi} + \text{Tx Power Setting (dBm)}$.

3.6.6.2.2 ODU with External Antenna

When using external antennas with gains greater than 23 dBi, the transmit power must be reduced in dB from that given in Table 3-1 by the antenna gain difference above 23 dBi for the mode that is being used.

For example, using a 6 foot dish antenna with 37 dBi gain, the output power would be dropped by

$$\text{Antenna Gain (External)} - 23 \text{ dBi} = \text{Antenna Gain Difference}$$

$$37.6 \text{ dBi} - 23 \text{ dBi} = 14.6 \text{ dB}$$

For mode 100FE1 (single channel configuration with 30MHz emission bandwidth) the power would be lowered from

$$\text{Tx Power (Internal Antenna)} - \text{Antenna Gain Difference} = \text{Tx Power (External Ant)}$$

$$+5 \text{ dBm} - 14.6 \text{ dB} = -9.6 \text{ dBm} (-10 \text{ dBm}).$$

Table 3-1 also presents transmit power settings for various antenna dish sizes.

For link budget, $EIRP(Avg) \text{ dBm} = 37 \text{ dBi} + \text{Tx Power Setting (dBm)}$.

Table 3-2. Maximum Power Settings for 5.3GHz U-NII Band Operation (US).

Antenna Diameter	Antenna Gain, dBi* (example)	Maximum Tx Power Setting, dBm	Maximum Tx Power Setting, dBm	Maximum Tx Power Setting, dBm
		1 Channel Mode (30MHz BW)	2 Channel Mode (20MHz BW)	3 Channel Mode (13.3MHz BW)
6 foot dish	37.6	-10	-11	-12
4 foot dish	34.6	-7	-8	-9
3 foot dish	31.2	-3	-4	-5
2 foot dish	28.0	0	-1	-2
1.5 foot dish	25.3	+3	+2	+1
Internal	23.0	+5	+4	+3

* Note: Many antenna manufacturers rate antenna gain in dBd (dB referred to a dipole antenna) in their literature. To convert to dBi, add 2.15 dB.

Power settings for other modes of operation can be easily extrapolated from Table 3-2. For link budget calculations,

$EIRP(Avg) \text{ dBm} = \text{Antenna Gain (dBi)} + \text{Tx Power Setting (dBm)}$.

Though transmitter radiated power is limited in the 5.3 GHz band regardless of antenna size, the receiver benefits from gain of larger antennas.

3.6.7 Documenting a Site Evaluation

Use the site evaluation form provided on the following pages to document the results of your site evaluation. Optimally, this complete site form would be stored with the SDIDU™ for future reference.

Site Evaluation Form					
Address				Site Engineer	
				Contact Person	
				Phone	
Site No					
Site Type					
ODU Roof Location					
ODU	#	Latitude	Longitude	Mapping Datum (ex. NDA27)	
Roof Requirements	Example	Information	Information	Information	
ODU#	4				
Clear Line of Sight	Yes				
Mounting Method	Wall or Pole				
FCC Compliance	Yes				
Collocation					
Aesthetics					
ODU Azimuth	60 degrees				
GPS Reading	80 21' 48"				
Cable Lengths					
Alarm					
Interconnect Cable	250 feet				
Grounding/Lighting					
Instructions					
Photographs*					
Photo 1					
Photo 2					
Photo 3					
Sketches**					
Sketch 1					
Sketch 2					
Recommendations for Site Photographs and Sketches					
<u>*Photographs</u>			<u>**Sketches</u>		
Photo 1 - ODU mounting location			Sketch 1- Roof and cable route to entry point		
Photo 2 - View from the ODU mounting location to the link partner			Sketch 2 - Details for grounding and lighting protection		
Photo 3 - IDU location			Sketch 3 - IDU room and cable routes from entry port		

Site Evaluation					
	Parameters	Example Information	Information	Information	Information
Colocated	Source	PCS			
	Tx and/or Rx	Tx/Rx			
	Frequency	2.1 GHz			
	Distance from ODU	5 feet			
	Owner	Sprint PCS			
	Azimuth	210 degrees			
	Elevation	2 degrees downtilt			
	Antenna Type				
	Power				
	Power	14W			
	Parameters	Example Information	Information	Information	Information
SDIDU™	IDU room Identified	Yes			
	Space for cabinet	Yes			
	Phone line	Need to install			
	48 VDC available?	Yes			
	Cables	Confirm cables			
	Take Photo 3				
	Sketch 3				
Indoor Space	Front View	Equipment Dimensions	Top View	Side View	
	Equipment Cabinet				
	Batteries				
Note					

3.7 Installation of the MDS FIVE Series

The following sections provide installation guides for:

- SDIDU™ Installation
- ODU Installation

3.7.1 Installing the MDS FIVE Series Software Defined IDU™

The MDS FIVE Series SDIDU™ can be installed in the following three options:

1. Table top or cabinet
2. Wall mount
3. Rack mount

The MDS FIVE Series SDIDU™ should be:

- Located where you can easily connect to a power supply and any other equipment used in your network, such as a router or PC.
- In a relatively clean, dust-free environment that allows easy access to the rear grounding post as well as the front panel controls and indicators. Air must be able to pass freely over the chassis.
- Accessible for service and troubleshooting.
- Protected from rain and extremes of temperature (it is designed for indoor use).

3.7.1.1 Installing on a Table Top or Cabinet

The MDS FIVE Series SDIDU™ can be placed on a tabletop or cabinet shelf. In order to prevent possible disruption, it is recommended to use a strap to secure the SDIDU™.

3.7.1.2 Installing on a Wall

An installation option for the SDIDU™ is mounting the unit to a wall. If the wall mount option is being considered, plan to position the MDS FIVE Series SDIDU™ at a height that allows LEDs, the connectors on the front panel, and the rear grounding post to be visible at all times and easily accessible. Also, including plastic clamps to support and arrange the ODU/ SDIDU™ Interconnect Cable should also be considered.

3.7.1.3 Installing in a Rack

To rack-mount the SDIDU™, use the supplied mounting brackets to secure the chassis to a 19 inch rack cabinet. As shown in Figure 3-5, the brackets can be attached to the front sides of the enclosure. An optional 21 inch rack mount kit is also available (consult factory for details).

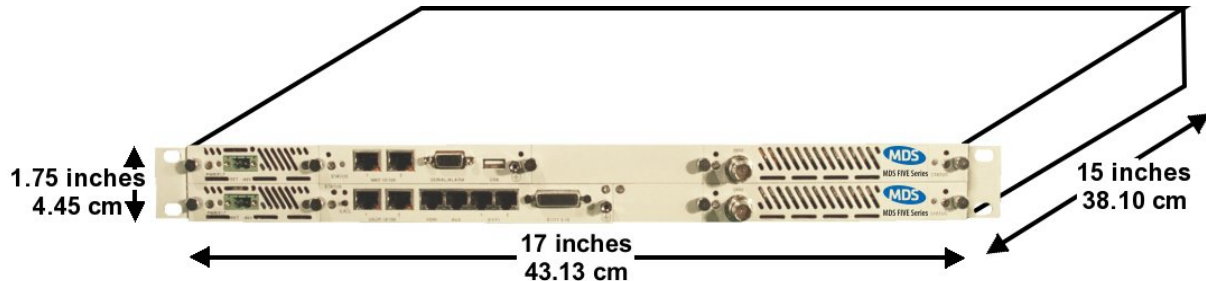

Figure 3-5. MDS FIVE Series SDIDU™ Dimensions

3.7.2 Installing the MDS FIVE Series ODU

The MDS FIVE Series ODU is intended for mounting on either a pole or antenna mast.

Each site must be assessed for the mounting method, location, and height. After defining the mounting location and height for the MDS FIVE Series ODU, re-confirm the line of sight.

When operating a 1+1 configured SDIDU™, i.e. an SDIDU™ with two power supplies and two modem modules installed, in 1+0 mode, the ODU must be connected to the modem in the bottom slot. If the ODU is connected to the modem in the top slot, the SDIDU™ will not communicate with the ODU, and a link cannot be established.

3.7.2.1 Installing the Mounting Poles

First install the mounting poles, on which you will mount the **MDS FIVE** Series ODU. It is important to note the direction in which the ODU will point when installing the mounting pole.

The mounting pole must be mounted in a vertical position. Failure to do so may result in improper alignment of the ODU. Vertical tilt of the ODU is accomplished from the tilt mounting bracket.

The mounting pole must be grounded.

Now that you have installed the mounting pole, you are ready to install the MDS FIVE Series ODU onto the mounting poles. Reference Figure 3-6 through Figure 3-9.

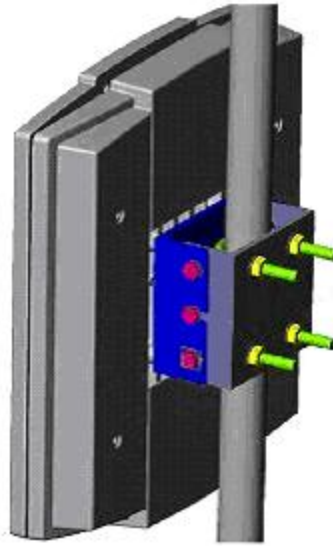

Figure 3-6. Mounting Parts for the MDS FIVE Series ODU

1. Remove the pole mount portion of the tilt bracket from the ODU by loosening the middle bolts and removing the top and bottom bolts on each side.
2. Mount the tilt bracket to the mounting pole using the U-Bolts and nuts. Insert the U-bolts around the pole and through the holes in the tilt bracket. Install a washer and nut to each side of the threaded U-bolt and hand tighten. Repeat this step for the second U-bolt.
3. Place the MDS FIVE Series ODU on the mating half of the tilt bracket connected by the two center bolts.
4. Add the remaining four bolts to the tilt bracket but do not tighten until the antenna alignment is complete (only applies for internal antenna ODUs).
5. Manually point the ODU in the direction of the link partner ODU.



Figure 3-7. MDS FIVE Series ODU Rear View



Figure 3-8. Tilt Bracket



Figure 3-9. MDS FIVE Series ODU with Mounted Tilt Bracket

3.7.3 Routing the ODU/ SDIDU™ Interconnect Cable

1. Select where the cable will enter the building from outside.

2. Determine the length of cable required. Allow three extra feet on each end to allow for strain relief, as well as any bends and turns.
3. Route the cable.

The SDIDU™ is equipped with TNC female connector on the front of the chassis. Depending on the ODU type, it will be equipped with either a N-type or TNC female connector at its interconnecting port. A length of coaxial cable (such as Times Microwave Systems LMR-400, LMR-300 or LMR-200) fitted with the appropriate N-type or TNC male connectors is required to connect the ODU to the SDIDU™. This cable assembly may be supplied in fixed lengths with the digital radio. Bulk coaxial cable of equivalent specification may also be used, with terminating connectors applied during cable installation.

Based on an evaluation of the cable routing path, pull the ODU/SDIDU™ Interconnect cable from one unit to the other, utilizing cable trays, ducts, or conduit as required. Take care that the ODU/SDIDU™ Interconnect cable is not kinked or damaged in any way during installation. Be sure to protect the TNC connectors from stress, damage and contamination during installation (do not pull the cable by the connectors). If multiple ODU/SDIDU™ Interconnect cables are to be installed along the same route, the cables should all be pulled at one time. Be sure the installed cable does not have any bends that exceed the specified cable bend radius. The ODU/SDIDU™ Interconnect cable should be adequately supported on horizontal runs and should be restrained by hangers or ties on vertical runs to reduce stress on the cable. Outside the building, support and restrain the cable as required by routing and environmental conditions (wind, ice).

The MDS FIVE Series ODU/SDIDU™ and interconnection must be properly grounded in order to protect it and the structure it is installed on from lightning damage. This requires that the ODU, any mounting pole or mast and any exposed interconnect cable be grounded on the outside of the structure. The SDIDU™ must be grounded to a rack or structure ground that also has direct path to earth ground.

The ODU must be directly connected to a ground rod or equivalent earth ground. The ODU/SDIDU™ interconnect cable should also be grounded at the ODU, where the cable enters the structure and at intermediate points if the exposed cable run is long (typically at intervals of 100 ft), with the cable manufacturer's grounding kits. Lightning protection devices used with the interconnect cable must be appropriate for the transmission of the interconnect signals (DC to 350 MHz).

Provide a sufficient but not excessive length of cable at each end to allow easy connection to the ODU and SDIDU™ without stress or tension on the cable. Excessive cable length, especially outdoors, should be avoided to minimize signal attenuation and provide a more robust and reliable installation. If installing using bulk coaxial cable, terminate the ODU/SDIDU™ Interconnect cable at each end with a TNC male connector on the SDIDU™ side and either a N-type or TNC male connector on the ODU side that is appropriate for the cable type. Use of connectors, tools and termination procedures specified by the cable manufacturer is recommended.

Once the cable has been installed but before connection has been made to either unit, a simple DC continuity test should be made to verify the integrity of the installed cable. A DC continuity tester or digital multimeter may be used to verify a lack of DC continuity between the cable center conductor and outer conductor, with the opposite end of the cable unconnected. With a temporary test lead or shorting adapter connected to one end of the cable, DC continuity should be verified between the center and outer conductors at the opposite end.

3.8 Quick Start Guide

3.8.1 Materials Required

1. Power supply (-48 V DC @ 2 Amps) **OR** optional AC/DC power supply and power cable (A Phoenix Contact P/N 17 86 83 1 connector is provided)
2. Digital voltmeter with test leads and BNC connector (optional, for ODU alignment).
3. SDIDU™ Serial Cable (Optional)
4. Computer with networking capability, consisting of either:
 - Laptop computer and Ethernet card with any necessary adapters and a Cat-5 Ethernet regular or crossover cable
 - or
 - Networked computer and an additional Ethernet cable providing access to the network.

With the following system requirements:

Minimum:

- Pentium II 400MHz
- 128MB RAM
- 30MB available hard drive space
- Windows 98, Windows NT, Windows 2000, or Windows XP
- Internet Explorer 5.5 (available at <http://www.microsoft.com>) and above or Mozilla Firefox 1.0.6 (available at <http://www.firefox.com>) with default settings.
- Sun Java JVM 1.5.0 or above (available at <http://www.java.com>)

Recommended:

- Pentium III 500MHz
 - 256 RAM
 - 30MB available hard drive space
 - Windows 98SE, Windows NT, Windows 2000, or Windows XP
 - Internet Explorer 5.5 (available at <http://www.microsoft.com>) and above or Mozilla Firefox 1.0.6 (available at <http://www.firefox.com>) with default settings.
 - Sun Java JVM 1.5.0 or above (available at <http://www.java.com>)
5. Site engineering folder with site drawings, or equivalent SDIDU™ configuration information
 6. 1/8" slotted screwdriver

3.8.2 Grounding the ODU

1. Place the grounding rod so as to allow for the shortest possible path from the grounding cable to the ODU.
2. Drive the grounding rod into the ground at least eight inches from the ground surface.

3. Attach a grounding clamp to the grounding rod. You will use this clamp to attach grounding wires for both the ODU and SDIDU™, reference Figure 3-10.

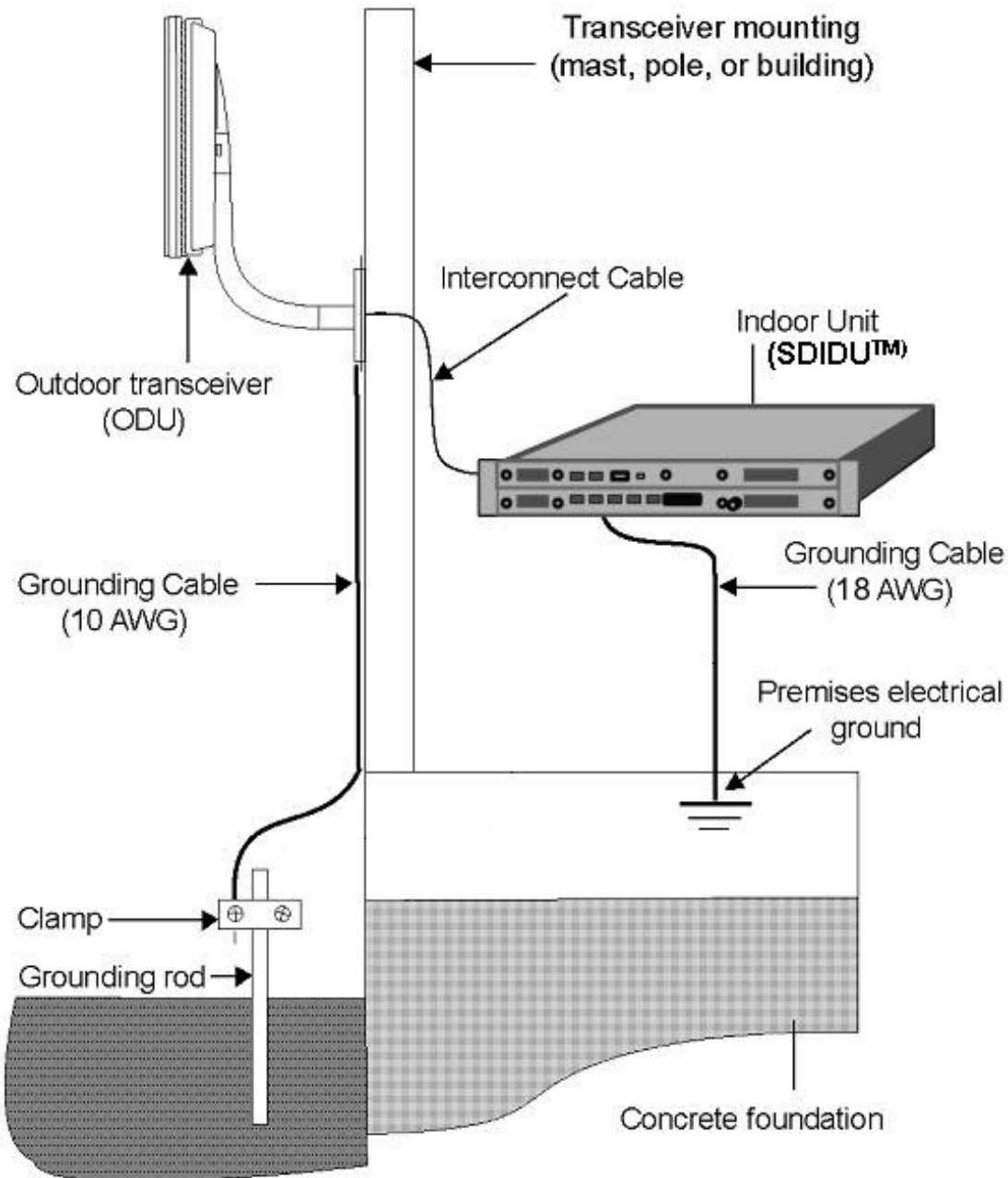

Figure 3-10 Ground Connections to ODU

4. Connect a ground lug to one end of the grounding wire.

5. Remove one of the lower mounting screws of the mounting pole. Insert a screw through the grounding lug terminal and re-install it to the mounting pole.
6. Attach the grounding wire to the clamp on the grounding rod. If necessary, use wire staples to secure the grounding wire to the outside wall.

3.8.3 Grounding the SDIDU™

1. The SDIDU™ should be able to be connected to a system or building electrical ground point (rack ground or power third-wire ground) with a cable of 36" or less.
2. Connect the grounding wire to either grounding point on the front panel. Use 6-32x5/16 maximum length screws (not provided) to fasten the lug of the grounding cable.
3. Connect the other end of the ground to the local source of ground in an appropriate manner.

3.8.4 Connecting the SDIDU™ to the PC and Power Source

1. Using the supplied power cable connector, pin 2 (labeled **-V**) should be connected to the power supply terminal supplying -48 V dc, while pin 1 (labeled **RET**) should be connected to the power supply return. Refer to Figure 3-11. Use of a power supply with an inappropriate ground reference may cause damage to the SDIDU™ and/or the supply.

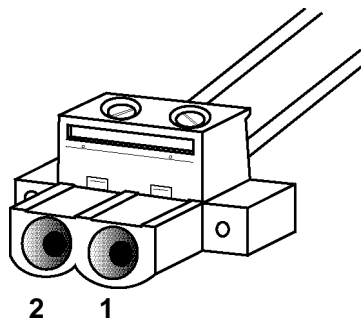

Figure 3-11. SDIDU™ DC Power Cable Connector

2. Connect the SDIDU™ power cable to the -48 V dc power supply, and place the voltmeter probes on the unconnected SDIDU™ end of the power cable, with the positive voltmeter probe on pin 2 (**-V**) of the cable connector and the negative probe on pin 1 (**RET**). The connector terminal screw heads may be used as convenient monitor points. Refer to Figure 3-11.
3. Turn on the -48 V dc supply. Verify that the digital voltmeter reads between -44 V dc and -52 V dc when monitoring the cable points specified above. Adjust the power supply output voltage and/or change the connections at the power supply to achieve this reading.
4. Turn the -48 V dc supply off.
5. Plug the SDIDU™ power cable into the SDIDU™ front panel DC Power connector (DC Input). Place the voltmeter probes on the cable connector terminal screw heads as per

step 2 above. Refer to Figure 3-11. Note that the MDS FIVE Series SDIDU™ does not have a power on/off switch. When DC power is connected, the digital radio powers up and is operational. There can be up to 320 mW of RF power present at the antenna port. The antenna should be directed safely when power is applied.

6. Turn on the -48 V dc power supply, and verify that the reading on the digital voltmeter is as specified in step 3 above.
7. Connect the SDIDU™ to the laptop computer, using a Cat-5 Ethernet cable or connect the SDIDU™ to a computer network, using a Cat-5 Ethernet cable. Connect the Ethernet cable to the **NMS 1 or 2** connector on the SDIDU™ front panel. Refer to Figure 3-12 for the SDIDU™ front panel connections.

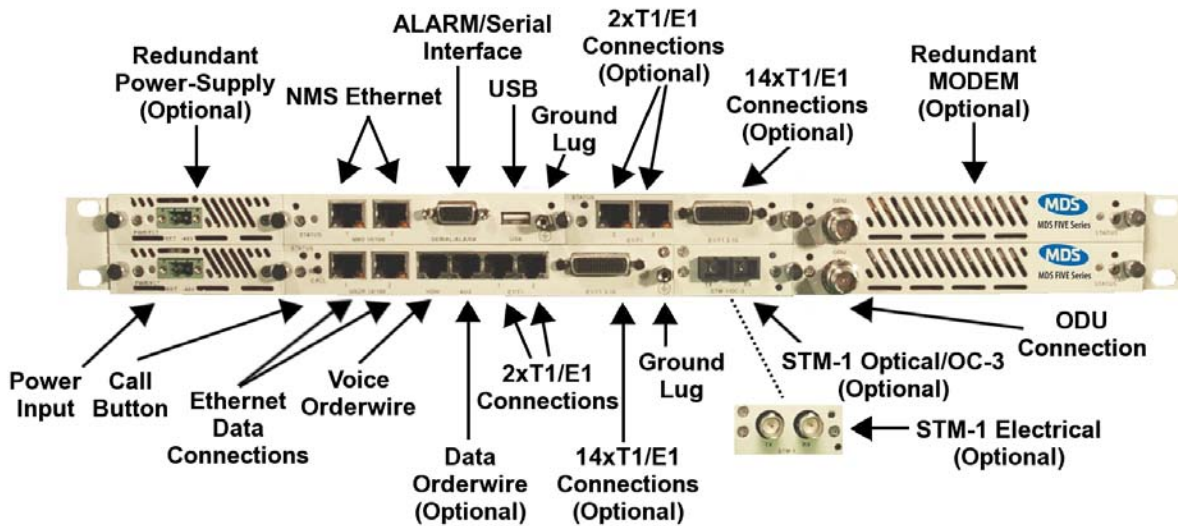

Figure 3-12. MDS FIVE Series-SB, 1+1 Protection: SDIDU™ Front Panel Connections

3.8.5 SDIDU™ Configuration

Although basic configuration of the MDS FIVE Series SDIDU™ does not require a connection to the ODU, it is recommended that the ODU and SDIDU™ are connected prior to configuring the SDIDU™. A connection to the ODU must be established prior to running the Link Configuration process (section 5.2) in order to configure ODU related parameters.

3.8.5.1 Setting the SDIDU™ IP Address

1. The PC's network configuration must be set with the parameters provided at the end of this guide.
2. The IDU should be accessible from your PC at the default IP address provided at the end of this guide. A network 'ping' can be done to verify connectivity to the IDU.
3. Start web browser and use the SDIDU™ default IP address as the url.

4. Log in at the login prompt. The username and password are provided at the end of this guide.
5. The GUI includes a navigation menu in the left frame. If this navigation menu is not visible, make sure the Java environment is properly installed and active. In the navigation menu, select Administration, then Network Configuration, and then General. The IP address, IP Netmask, and IP Gateway are shown.
6. Enter the new IP address, IP Netmask, and IP Gateway. The gateway must be in the same subnet as the IP address for proper operation. Click "Update" to change the values.
7. To verify the new IP address, change the PC's network configuration to be on the same subnet as the new IP address set in the unit and a network 'ping' may be performed to the new address.
8. To continue using the GUI, point the web browser to the new IP address.

3.8.5.2 Link Configuration

1. Start the SDIDU™ GUI.
2. Use the frame on the left side of the window to navigate to "Link Configuration", then "Radio Link."
3. Select the subcategory "Link Configuration."
4. Select the operating mode. If the SDIDU™ has one modem installed and is connected to one ODU, select standard. If the SDIDU™ has two modems installed and is connected to two ODUs, select 1+1 diversity or 1+1 non-diversity for a protected link or east-west for a 2+0 ring configuration.
5. Follow the wizard located here to enter the rest of the required settings.

3.8.5.3 Setting SDIDU™ Site Attributes

1. Start the SDIDU™ GUI.
2. In the navigation menu, select Administration, then Device Information, and then Device Names.
3. Enter the Owner, Contact, Description, and Location. These values are not required for operation, but will help keep a system organized.

3.8.5.4 Power on Reset to Factory Defaults

The SDIDU™ may be reset to factory defaults during power up. A power on reset affects the IP address and the user logins/passwords. To perform a power on reset:

1. Power on the SDIDU™

2. During bootup, the SDIDU™ will flash the controller-card LED alternating red/green for five seconds.
3. Make sure the call button is not active at the start of this five second period.
4. While the LED is flashing, press the call button and release it one second prior to the LED changing to static green.

3.8.5.5 CLI Access via NMS Ethernet

The CLI may be accessed via NMS Ethernet after connecting and configuring the PC as described in the previous section. Then using a Telnet client, telnet to the SDIDU™ IP address. You will be prompted for a username and password. Use the username and password supplied at the end of this guide.

3.8.5.6 CLI Access via Serial Port

The CLI for configuring/monitoring the SDIDU™ may be accessed via the front-panel serial port. Table 3-3 shows the pinout for constructing a DB-9 to HD-15 cable.

Table 3-3: Serial Cable Pinout

DB-9 Pin	HDB-15 Pin
2	2
3	3
5	5

The serial port parameters are show in Table 3-4.

Table 3-4: Serial Port Parameters

Parameter	Value
Speed	38400
Bits	8
Stop-Bits	1
Parity	None
Flow-Control	None

After powering-on the SDIDU™, the CLI may be accessed by connecting the serial cable between the PC and the SDIDU™, launching and configuring a terminal program (e.g. Hyperterm) and pressing the enter key. You will be prompted for a username and password, which are supplied at the end of this guide.

3.8.6 ODU Antenna Alignment

To use the built-in tuning of the ODU antenna, a complete link is required, with both ends of the link roughly pointed at each other, and transmitting.

Once the links are roughly pointed, connect the voltmeter to the RSSI (Receive Signal Strength Indication) BNC connector seen on the ODU. This mode outputs 0 to +3 Volts. Adjust the antenna for maximum voltage. The RSSI voltage is linearly calibrated from 2.5 Volts for maximum

RSL (received signal level) at -20 dBm to 0Volts for minimum RSL at -90 dBm. This mapping characteristic is plotted below in Figure 3-13.

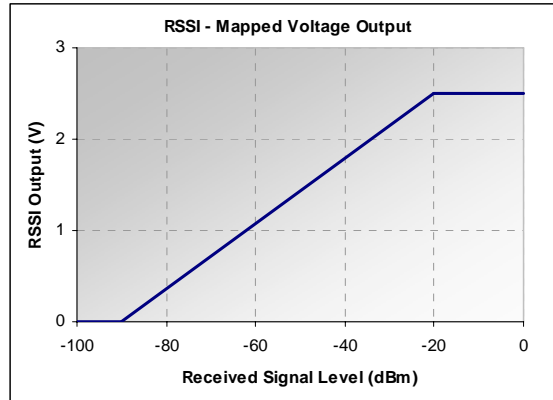

Figure 3-13. ODU RSSI Output vs. Received Signal.

3.8.7 Quick Start Settings

PC Network Configuration

The Web GUI may be accessed via NMS by connecting a CAT5 patch cable between the SDIDU™ front-panel NMS port and a PC. The PC's network interface must be configured to an open IP address within the same subnet. For the default SDIDU™ configuration, the IP address of the PC needs to be 192.168.0.x, where x (between 2 and 253) provides an available IP address. DHCP may also be used to set the PC IP address if a DHCP server is configured on the same subnet.

SDIDU™ Default IP Address

Parameter	Value
IP Address	192.168.0.1
Netmask	255.255.255.0
Gateway	192.168.0.254

After configuring the PC's network interface, a web browser may be launched and the following URL entered to access the Web GUI:

<http://192.168.0.1/>

Username and Password

A dialog box will show requesting a username and password:

- User: administrator
- Pass: d1scovery

3.9 SDIDU™ Service

At times, it may be necessary to service the SDIDU™. This may include installing, removing, or replacing an SDIDU™ module. There may be up to 8 modules installed in a single SDIDU™ chassis. Figure 3-14 shows the front panel of the SDIDU™ with each module labeled. The basic procedure for removing and installing a module is common to all the modules, with slight variations for the Power Supply Module, Controller Module, and Mini IO Module. These basic procedures are described below. Variations are described in sub-items beneath each step.

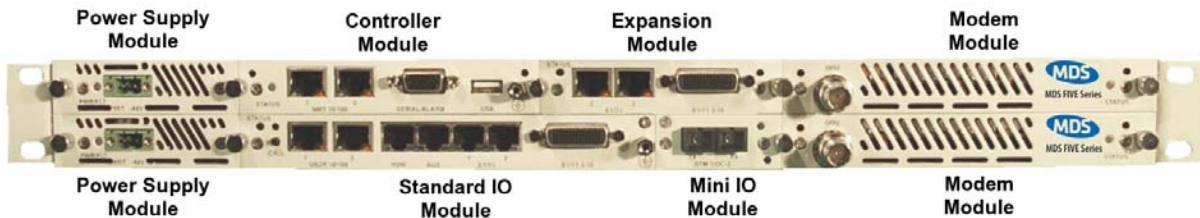

Figure 3-14 SDIDU™ Modules

3.9.1 Removing a Module

1. Modules are static sensitive and should only be handled in an ESD-safe environment. When packaging modules for shipment or storage, place in an ESD bag.
2. Remove front panel connections to the module.
3. Remove the two thumbscrews on either side of the module. Figure 3-15 shows the locations of these thumb screws.
4. The thumbscrew for the Standard IO Module is located on the right side of the Mini IO Module slot.
5. If a Mini IO module is installed and the Standard IO Module is to be removed, both modules will be removed as one unit.
6. When removing only the Mini IO card, remove the corner screw indicated in Figure 3-15 and one thumb screw.

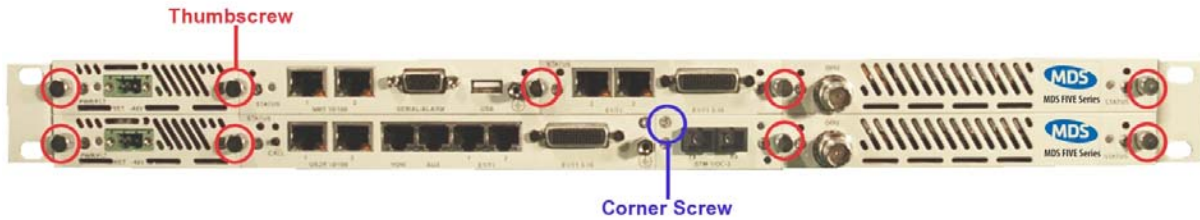

Figure 3-15 Thumbscrew and Corner Screw Locations

7. Thread thumbscrew(s) into hole(s) shown in Figure 3-16. Remove the module by grasping the thumbscrew(s) and pulling module straight out of the SDIDU™. Both thumbscrews should be used for all modules except the Power Supply and the Mini IO Modules.
8. The Power Supply and Mini IO Modules have only one threaded hole each.
9. When removing the Standard IO Module, the ground lug indicated in Figure 3-16 is used as the second threaded hole. If the SDIDU™ is to remain powered on and the ground lug is being used to ground the unit, first move the ground connection to the ground lug located on the Controller Module.

The SDIDU™ retains its current configuration when a module is removed, unless that module is the Controller Module. In which case, the IP addresses will need to be reprogrammed.

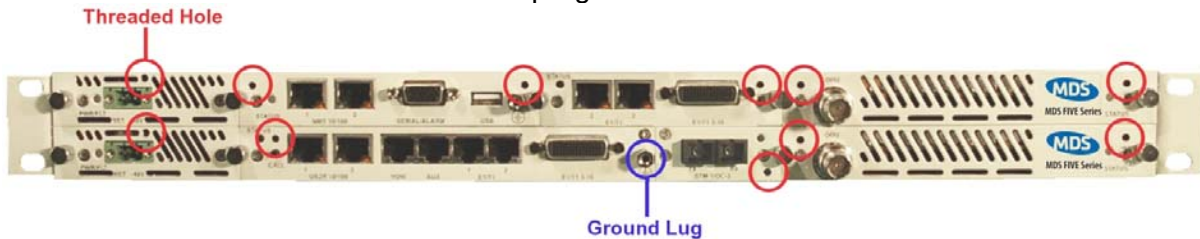

Figure 3-16 Threaded Hole Locations

3.9.2 Installing a Module

1. Modules are static sensitive and should only be handled in an ESD-safe environment. When packaging modules for shipment or storage, place in an ESD bag.
2. Line up the module board with the guides in the chassis and slide the module into the SDIDU™. Figure 3-17 shows a photo of the guides. As the module face plate comes flush with the face of the SDIDU™, connectors on the back of the module will engage with the SDIDU™ backplane. It is possible to encounter interference from adjacent module front panels. If this occurs, loosen the thumbscrews holding the neighboring panels and shift them as necessary to ensure fit.
 - a. The Mini IO Module only has one guide on the right side. Take care to insert the Mini IO module carefully and correctly engage the rear connector with its mate on the Standard IO Module.

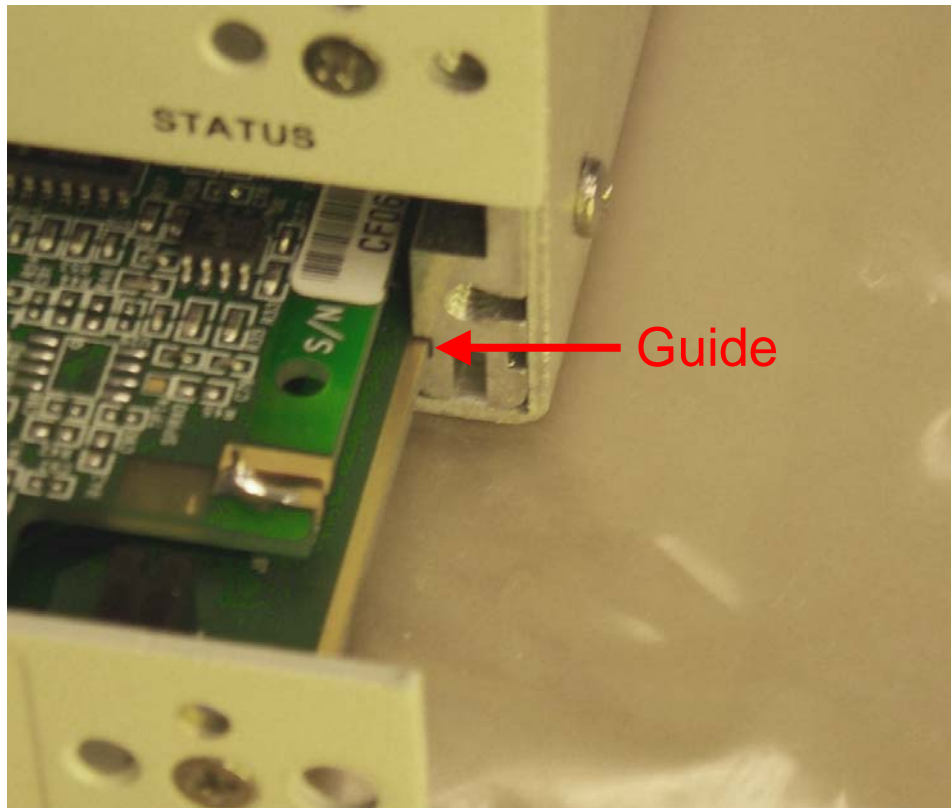

Figure 3-17 Guides

3. Install thumbscrews on either side of the module as shown in Figure 3-15.
 - a. The Mini IO card has a corner screw which should be installed. This corner screw is shown in Figure 3-15.
4. Make front panel connections to the module and power on the SDIDU™ if necessary.
5. Verify proper operation of the unit.
 - a. If the Controller Module has been changed, reprogram the IP addresses.

3.10 Documenting MDS FIVE Series Configuration

Use the MDS FIVE Series configuration form provided at the end of this section, or a similar form, to document the results of the SDIDU™ configuration procedure. Optimally, this complete site form would be stored with the SDIDU™ for future reference.

Link ID

Radio Type(A/B) A = Low band, Horizontal polarization, odd serial number
B= High band & Vertical polarization, even serial number

Radio ID # Radio S/N

Site Name

Network Administration

Addresses

Near IP Far IP

Routing

Net Mask IP EMS 1

NTP IP EMS 2

Gateway IP EMS 3

IP EMS 4

SNMP Community Names

Trap Super User

Read/Write Read

Digital Radio Configuration Form

1

Link Administration

Comissioning

Rain Model

Frequency TX RX

Grade of Service

Rain Region

Link Distance

Distance (meters)

OR

GPS Location

Near Latitude deg min sec

Near Longitude deg min sec

Far Latitude deg min sec

Far Longitude deg min sec

Radio Type(A/B) A = Low band, Horizontal polarization, odd serial number
B= High band & Vertical polarization, even serial number

Radio ID # Radio S/N

Site Name

Network Administration

Addresses

Near IP Far IP

Routing

Net Mask IP EMS 1

NTP IP EMS 2

Gateway IP EMS 3

IP EMS 4

SNMP Community Names

Trap Super User

Read/Write Read

2

Link Administration

Comissioning

Rain Model

Frequency TX RX

Grade of Service

Rain Region

Link Distance

Distance (meters)

OR

GPS Location

Near Latitude deg min sec

Near Longitude deg min sec

Far Latitude deg min sec

Far Longitude deg min sec

4 Summary Specification

Parameter	5.8 GHz	5.3 GHz
System		
Capacity	100 Mbps Ethernet 1-16 T1/E1 Various combinations of above	100 Mbps Ethernet 1-16 T1/E1 Various combinations of above
Output Power – Average* (at antenna port)	+5 to 23 dBm	-18 to +5 dBm (Ext. Antenna) -6 to +5 (Int. Antenna)
Output Power – Peak* (at antenna port)	30 dBm	12 dBm
Input Sensitivity	-84 dBm (or higher, based on selected mode)	-84 dBm (or higher, based on selected mode)
Maximum Input Power	-20 dBm	-20 dBm
Modulation	QPSK to 64-QAM	QPSK to 64-QAM
Channelization	12.5, 16.7, 25, 30 MHz	13.3, 20, 30 MHz
Radio Interfaces		
External Antenna	N Type Female	N Type Female
SDIDU™ /ODU Link	TNC Female	TNC Female
RSSI	BNC Female	BNC Female
Data Interfaces		
Payload		
Ethernet	100Base-Tx RJ-45	100Base-Tx RJ-45
2 T1/E1	100 Ω / 120 Ω Balanced RJ-48C Female (2)	100 Ω / 120 Ω Balanced RJ-48C Female (2)
14 T1/E1	100 Ω / 120 Ω Balanced Molex High-Density 60-pin	100 Ω / 120 Ω Balanced Molex High-Density 60-pin
SNMP	10Base-T/100Base-Tx RJ-45 Female	10Base-T/100Base-Tx RJ-45 Female
Control		
Network Management	SNMP, web/http browser	SNMP, web/http browser
NMS Connector	10Base-T/100Base-Tx	10Base-T/100Base-Tx
Voice Orderwire	RJ-45 for PTT handset	RJ-45 for PTT handset
Auxiliary Data (64 kbps)	RS422 via RJ-45	RS422 via RJ-45
Encryption	Proprietary, AES (optional)	Proprietary, AES (optional)

Parameter	5.8 GHz	5.3 GHz
Alarm Port	2 Form C (SPDT), 2 TTL Output, 4 TTL Input, DB-15HD	2 Form C (SPDT), 2 TTL Output, 4 TTL Input, DB-15HD
Power/Environment		
DC Power	-48 Volts \pm 10%, <70 W	-48 Volts \pm 10%, <70 W
SDIDU™ Operational Temperature	-5° to 55° C	-5° to 55° C
ODU Operational Temperature	-30° to 55° C	-30° to 55° C
SDIDU™ Humidity	0 to 95%, non-condensing	0 to 95%, non-condensing
ODU Humidity	Up to 100% at 45° C	Up to 100% at 45° C
Altitude	15,000 feet/4572 meters, maximum	15,000 feet/4572 meters, maximum
Physical Dimensions		
SDIDU™ Size (WxHxD)	17.2 x 1.75 x 14.5 inches (43.7 x 4.5 x 36.0 cm)	17.2 x 1.75 x 14.5 inches (43.7 x 4.5 x 36.0 cm)
SDIDU™ Weight	7 lbs (3.12 Kg)	7 lbs (3.12 Kg)
SDIDU™		
EIA Rack Mount	19 inch/48.2 cm, 1 rack unit	19 inch/48.2 cm, 1 rack unit
ODU Size (W x H x D)	14.6 x 15.4 x 2.6 inches	14.6 x 15.4 x 2.6 inches
ODU Weight	15 lbs (6.8 Kgs)	15 lbs (6.8 Kg)
ODU		
Mounting	Custom Bracket	Custom Bracket

* For definitions of peak and average power, see Section 3.6.6

5 Front Panel Connectors

5.1 DC Input (Power) Connector

Two-pin male

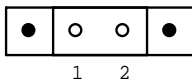

PIN	TYPE	SIGNAL
1	POWER	Power supply return
2	POWER	-48 Vdc, nominal

5.2 Ethernet 100BaseTX Payload Connector 1-2

RJ-45 Female

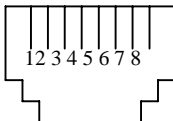

PIN	TYPE	SIGNAL
1	INPUT	RX+
2	INPUT	RX-
3	OUTPUT	TX+
4	N/A	N/A
5	N/A	N/A
6	OUTPUT	TX-
7	N/A	N/A
8	N/A	N/A

5.3 SONET Payload Connector

Consult factor for Mini-IO Optical Module for availability.

SC Duplex Female Fiber

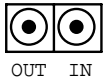

PIN	TYPE	SIGNAL
OUT	OUTPUT	SONET OC-3 payload output (optical)
IN	INPUT	SONET OC-3 payload input (optical)

5.4 STM-1 Payload Connector

Consult factor for Mini-IO Optical Module for availability.

BNC Duplex

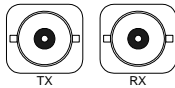

PIN	TYPE	SIGNAL
TX	OUTPUT	SDH STM-1 payload output (electrical)
RX	INPUT	SDH STM-1 payload input (electrical)

5.5 DS-3/E-3/STS-1 Payload Connector

BNC Duplex

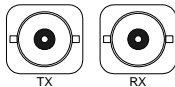

PIN	TYPE	SIGNAL
TX	OUTPUT	DS-3/E-3/STS-1 payload output
RX	INPUT	DS-3/E-3/STS-1 payload input

5.6 NMS 10/100BaseTX Connector 1-2

RJ-45 Female

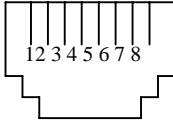

PIN	TYPE	SIGNAL
1	OUTPUT	TX+
2	OUTPUT	TX-
3	INPUT	RX+
4	N/A	N/A
5	N/A	N/A
6	INPUT	RX-
7	N/A	N/A
8	N/A	N/A

5.7 Alarm/Serial Port Connector

DB-15HD Female

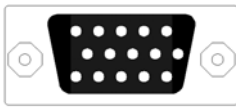

PIN	TYPE	SIGNAL
1	OUTPUT	TTL Alarm Output 3
2 ¹	INPUT/ Output	RS-232 RX/TX
3 ¹	OUTPUT/ Input	RS-232 TX/RX
4	OUTPUT	TTL Alarm Output 4
5	N/A	GROUND
6 ²	N/A	Alarm 1 Form C Contact Normally Open
7 ²	N/A	Alarm 1 Form C Contact Normally Closed
8 ²	N/A	Alarm 2 Form C Contact Common

¹ Pins 2 and 3 are hardware jumper configurable for DCE or DTE operation.

² Form C Contacts are hardware jumper configurable to emulate TTL outputs.

PIN	TYPE	SIGNAL
9	INPUT	TTL Alarm Input 1
10	INPUT	TTL Alarm Input 3
11 ²	N/A	Alarm 1 Form C Contact Common
12 ²	N/A	Alarm 2 Form C Contact Normally Open
13 ²	N/A	Alarm 2 Form C Contact Normally Closed
14	INPUT	TTL Alarm Input 2
15	Input	TTL Alarm Input 4

5.8 ODU Connector

TNC coaxial female

PIN	TYPE	SIGNAL
Center	I/O	350 MHz TX IF / 140 MHz RX IF / -48 VDC
Shield	N/A	Shield / Chassis GND

5.9 T1/E1 - Channels 1-2 Connector

RJ-45 Female

100 Ω / 120 Ω Balanced

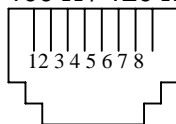

PIN	TYPE	SIGNAL
1	INPUT	RX+
2	INPUT	RX-
3	N/A	GND
4	OUTPUT	TX+
5	OUTPUT	TX-
6	N/A	GND
7	N/A	N/A
8	N/A	N/A

5.10 T1/E1 - Channels 3-16 Connector

60-pin Molex

100 Ω / 120 Ω Balanced

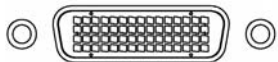

PIN	TYPE	SIGNAL
1	OUTPUT	T1 Channel 13 Transmit Tip
2	OUTPUT	T1 Channel 14 Transmit Tip
3	OUTPUT	T1 Channel 15 Transmit Tip
4	OUTPUT	T1 Channel 16 Transmit Tip
5	OUTPUT	T1 Channel 9 Transmit Tip
6	OUTPUT	T1 Channel 10 Transmit Tip
7	OUTPUT	T1 Channel 11 Transmit Tip
8	OUTPUT	T1 Channel 12 Transmit Tip
9	OUTPUT	T1 Channel 5 Transmit Tip
10	OUTPUT	T1 Channel 6 Transmit Tip
11	OUTPUT	T1 Channel 7 Transmit Tip
12	OUTPUT	T1 Channel 8 Transmit Tip
13	OUTPUT	T1 Channel 3 Transmit Tip
14	OUTPUT	T1 Channel 4 Transmit Tip
15	NC	NC
16	NC	NC
17	OUTPUT	T1 Channel 4 Transmit Ring
18	OUTPUT	T1 Channel 3 Transmit Ring
19	OUTPUT	T1 Channel 8 Transmit Ring
20	OUTPUT	T1 Channel 7 Transmit Ring
21	OUTPUT	T1 Channel 6 Transmit Ring
22	OUTPUT	T1 Channel 5 Transmit Ring
23	OUTPUT	T1 Channel 12 Transmit Ring

PIN	TYPE	SIGNAL
24	OUTPUT	T1 Channel 11 Transmit Ring
25	OUTPUT	T1 Channel 10 Transmit Ring
26	OUTPUT	T1 Channel 9 Transmit Ring
27	OUTPUT	T1 Channel 16 Transmit Ring
28	OUTPUT	T1 Channel 15 Transmit Ring
29	OUTPUT	T1 Channel 14 Transmit Ring
30	OUTPUT	T1 Channel 13 Transmit Ring
31	INPUT	T1 Channel 16 Receive Tip
32	INPUT	T1 Channel 15 Receive Tip
33	INPUT	T1 Channel 9 Receive Tip
34	INPUT	T1 Channel 14 Receive Tip
35	INPUT	T1 Channel 10 Receive Tip
36	INPUT	T1 Channel 13 Receive Tip
37	INPUT	T1 Channel 11 Receive Tip
38	INPUT	T1 Channel 4 Receive Tip
39	INPUT	T1 Channel 12 Receive Tip
40	INPUT	T1 Channel 3 Receive Tip
41	INPUT	T1 Channel 5 Receive Tip
42	INPUT	T1 Channel 8 Receive Tip
43	INPUT	T1 Channel 6 Receive Tip
44	INPUT	T1 Channel 7 Receive Tip
45	NC	NC
46	NC	NC
47	INPUT	T1 Channel 7 Receive Ring
48	INPUT	T1 Channel 6 Receive Ring

PIN	TYPE	SIGNAL
49	INPUT	T1 Channel 8 Receive Ring
50	INPUT	T1 Channel 5 Receive Ring
51	INPUT	T1 Channel 3 Receive Ring
52	INPUT	T1 Channel 12 Receive Ring
53	INPUT	T1 Channel 4 Receive Ring
54	INPUT	T1 Channel 11 Receive Ring
55	INPUT	T1 Channel 13 Receive Ring
56	INPUT	T1 Channel 10 Receive Ring
57	INPUT	T1 Channel 14 Receive Ring
58	INPUT	T1 Channel 9 Receive Ring
59	INPUT	T1 Channel 15 Receive Ring
60	INPUT	T1 Channel 16 Receive Ring

5.11 USB

USB Type A



PIN	TYPE	SIGNAL
1	OUTPUT	+5V
2	I/O	-Data
3	I/O	+Data
4	N/A	GND

5.12 Voice Order Wire

RJ-45 Female

PIN	TYPE	SIGNAL
1	N/A	NC

	PIN	TYPE	SIGNAL
	2	INPUT	PTT
	3	N/A	GND
	4	OUTPUT	PO-
	5	OUTPUT	PO+
	6	INPUT	TI-
	7	N/A	GND
	8	N/A	NC

5.13 Data Order Wire

5.13.1 RS422

RJ-45 Female

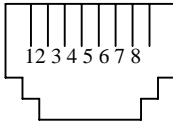

	PIN	TYPE	SIGNAL
	1	OUTPUT	TX Clock -
	2	OUTPUT	TX Clock +
	3	OUTPUT	TX Data -
	4	INPUT	RX Data -
	5	INPUT	RX Data +
	6	OUTPUT	TX Data +
	7	INPUT	RX Clock -
	8	INPUT	RX Clock +

5.13.2 RS-232

RJ-45 Female

	PIN	TYPE	SIGNAL
	1	N/A	NC

PIN	TYPE	SIGNAL
2	N/A	NC
3	N/A	Signal GND
4	N/A	NC
5	INPUT	RX Data +
6	OUTPUT	TX Data +
7	N/A	NC
8	N/A	NC

6 Appendix

6.1 Alarm Descriptions

Alarm	Affected Component	Description	LED to RED	Alarm Code	Severity
Modem Fault Lower	Modem	The specified Modem card has indicated a fault. Fault detection is via reading Modem Hardware Status from MODEM during start-up and polling GPIO for MODEM fault indication. Polling interval 5 sec.	N/A	11	Critical
Modem Comm Failure Lower	Modem	The Controller Card is unable to communicate with the specified Modem card.	Modem Lower	12	Critical
Modem Card Removed Lower	Modem	The specified Modem card has been removed from the IDU (only if the specified Modem card has been enabled for use). Fault detection via card-detect logic.	N/A	13	Major
Modem Card Installed Lower	Modem	The specified Modem card has been installed into the IDU (only if the specified Modem card is not enabled for use). Fault detection via card-detect logic. Alarm is raised then lowered.	Modem Lower	14	Info
Modem Unlock Lower	Modem	The demodulation functional components of the modem have lost lock to the incoming signal. The data received through the RF link is not valid. Fault detection via modem status polling. Polling interval: 1 sec.	N/A	N/A	Critical

Alarm	Affected Component	Description	LED to RED	Alarm Code	Severity
RSL Low Lower	Modem	RSSI is approaching the minimum operational level of the link as set during configuration. Fault detection via modem status polling, comparing RSSI value to threshold value in configuration table. Polling interval 5 sec.	N/A	N/A	Major
Synthesizer Unlock Lower	Modem	Modem synthesizer has unlocked. Fault detection via modem status polling. Polling is done in conjunction with Modem Unlock polling.	N/A	N/A	Critical
SNR Low Lower	Modem	The signal-to-noise ratio is below the minimum operational level of the link as set during configuration. Fault detection via modem status polling, comparing Eb/N0 value to threshold value in configuration table. Polling interval 5 sec.	N/A	N/A	Major
Modem Fault Upper	Modem	The specified Modem card has indicated a fault. Fault detection is via reading Modem Hardware Status from MODEM during start-up and polling GPIO for MODEM fault indication. Polling interval 5 sec.	N/A	16	Critical
Modem Comm Failure Upper	Modem	The Controller Card is unable to communicate with the specified Modem card.	Modem Lower	17	Critical
Modem Card Removed Upper	Modem	The specified Modem card has been removed from the IDU (only if the specified Modem card has been enabled for use). Fault detection via card-detect logic.	N/A	18	Major

Alarm	Affected Component	Description	LED to RED	Alarm Code	Severity
Modem Card Installed Upper	Modem	The specified Modem card has been installed into the IDU (only if the specified Modem card is not enabled for use). Fault detection via card-detect logic. Alarm is raised then lowered.	Modem Upper	19	Info
Modem Unlock Upper	Modem	The demodulation functional components of the modem have lost lock to the incoming signal. The data received through the RF link is not valid. Fault detection via modem status polling. Polling interval 1 sec.	N/A	N/A	Critical
RSL Low Upper	Modem	RSSI is approaching the minimum operational level of the link as set during configuration. Fault detection via modem status polling, comparing RSSI value to threshold value in configuration table. Polling interval 5 sec.	N/A	N/A	Major
SNR Low Upper	Modem	The signal-to-noise ratio is below the minimum operational level of the link as set during configuration. Fault detection via modem status polling, comparing Eb/N0 value to threshold value in configuration table. Polling interval 5 sec.	N/A	N/A	Major
Synthesizer Unlock Upper	Modem	Modem synthesizer has unlocked. Fault detection via modem status polling. Polling is done in conjunction with Modem Unlock polling.	N/A	N/A	Critical

Alarm	Affected Component	Description	LED to RED	Alarm Code	Severity
Fan Failure	Controller	The Fan rotational speed is too low. (Controller card LED flashed red rather than orange). Fault detection via polling fan controller status. Polling interval 10 sec.	Controller	21	Major
Controller Card Fault	Controller	The CPU has detected a fault in the controller card. (Controller card LED flashes red rather than orange). Fault detection via software.	Controller	22	Critical
Low Battery Voltage	Controller	The CPU has detected a low-battery voltage condition. (Controller card LED flashes red rather than orange). Fault detection via software polling RTC via controller FPGA.	Controller	23	Info
Power Supply Fault Lower	Power Supply	The Power Supply card has indicated a fault. Fault detection via polling GPIO. Polling interval 5 sec.	N/A	31	Critical
Power Supply Card Removed Lower	Power Supply	The specified Power Supply card has been removed from the IDU. Fault detection via card-detect logic.	N/A	32	Major
Power Supply Fault Upper	Power Supply	The Power Supply card has indicated a fault. Fault detection via polling GPIO. Polling interval 5 sec.	N/A	36	Critical
Power Supply Card Removed Upper	Power Supply	The specified Power Supply card has been removed from the IDU. Fault detection via card-detect logic.	N/A	37	Major
Standard I/O Card Removed	StdIO	The Standard I/O card has been removed from the IDU. Fault detect via card-detect logic.	N/A	41	Critical

Alarm	Affected Component	Description	LED to RED	Alarm Code	Severity
Ethernet Payload Disconnect	StdIO	There is no cable detected at either Ethernet payload on Standard I/O card (only if Ethernet mode enabled). Fault detection via polling of Ethernet PHY. Polling interval 5 sec.	Standard I/O	42	Critical
Framer Initialization Timeout	StdIO	There is an Initialization wait for Framer to turn ON the Framer Receiver side after turning ON the Modem/ODU. Fault detection via polling. Poll only after timeout to detect.	Standard I/O	43	Critical
Mini I/O Card Removed	MiniIO	The Mini I/O card has been removed from the IDU (only if Mini I/O card has been enabled for use). Fault detection via card-detect logic.	Standard I/O	46	Critical
Mini I/O Card Installed	MiniIO	The Mini I/O card has been installed into the IDU (only if Mini I/O card is noted enabled for use). Fault detection via card-detect logic. Alarm is raised then lowered.	Standard I/O	47	Info
Optional I/O Card Removed	OptIO	The Optional I/O card has been removed from the IDU (only if the Optional I/O card has been enabled for use). Fault detection via card-detect logic.	N/A	26	Critical
Optional I/O Card Installed	OptIO	The Optional I/O card has been installed into the IDU (only if the Optional I/O card is not enabled for use). Fault detection via card-detect logic. Alarm is cleared after 5 minutes.	Optional I/O	27	Info

Alarm	Affected Component	Description	LED to RED	Alarm Code	Severity
T1/E1 Channel Alarm Ch x	StdIO (1-16) OptIO (17-32)	There is either no cable detected at the specified E1/T1 channel port on Standard I/O Card or there is an AIS condition detected (only for active T1/E1 channels). Fault detection via polling of LIUs on Standart I/O card and Optional I/O Card when installed. Polling interval 2 channels per 1 sec. Report of this alarm in the GUI/Syslog/Alarm history shall indicate whether this is a disconnect or AIS condition. If both conditions are present, then the disconnect alarm shall take precedence over the AIS alarm.	Standard I/O when 1-16 Optional I/O when 17-32 Turn LED orange rather than RED	51-58 (1-16) 61-68 (17-32)	Critical
T1/E1 Test Mode	StdIO	The user has selected a T1/E1 test mode (loopback or Tx Data). This alarm shall be set when the user sets the testmode for any of the T1/E1 channels, and cleared when all T1/E1 channels are not in loopback and Tx Data is normal.	N/A	59	Info
BERT/LB/CW Test Mode	StdIO	This alarm shall be set when the user enables either BERT,, Loopback, or CW mode, and cleared when all BERT, Loopback and CW modes are disabled.	N/A	69	Info
ODU Fault Lower	ODU	The ODU has indicated a fault condition. Fault detection via polling of ODU or unsolicited message, if supported. Polling interval 5 sec. Polling done via API functional call. Report of this alarm in the GUI/Syslog/Alarm history shall indicate the fault code from the ODU.	N/A	71	Critical

Alarm	Affected Component	Description	LED to RED	Alarm Code	Severity
ODU Comm Failure Lower	ODU	The IDU is unable to communicate with the ODU. This could be a problem with the ODU or a problem with the cable connecting the ODU to the IDU.	N/A	72	Critical
ODU Fault Upper	ODU	The ODU has indicated a fault condition or unsolicited message, if supported. Fault detection via polling of ODU. Polling interval 5 sec. Polling done via API function call. Report of this alarm in the GUI/Syslog/Alarm history shall indicate the fault code from the ODU.	N/A	73	Critical
ODU Comm Failure Upper	ODU	The IDU is unable to communicate with the ODU. This could be a problem with the ODU or a problem with the cable connecting the ODU to the IDU.	N/A	74	Critical
Protection Switch	MODEM/ODU	This alarm shall be set when an AL1 command is received from the active MODEM/ODU, then cleared when an AL2 command is received from the standby MODEM/ODU. Report of this alarm in the GUI/Syslog/Alarm history shall indicate the fault code from the ODU, if received.	N/A	75	Major
East ATPC Tx at Max Power	ODU	The IDU is unable to increase the Tx Power as requested by link partner due to maximum power being reached. Maximum power is specified in the configuration table.	N/A	76	Info

Alarm	Affected Component	Description	LED to RED	Alarm Code	Severity
West ATPC Tx at Max Power	ODU	The IDU is unable to increase the Tx Power as requested by link partner due to maximum power being reached. Maximum power is specified in the configuration table.	N/A	78	Info
Link Fault	IDU	Failed to receive link heartbeat from link partner via Radio Overhead (ROH) channel. Fault detection via timeout counter, which is reset via reception of link heartbeat message.	N/A	81	Critical
Remote Fault	IDU	Link Partner IDU indicating it has a fault condition. Local IDU receives Link Partner Fault detection via Radio Overhead (ROH) channel message.	N/A	82	Info
Encryption Failure	IDU	Data is not being decrypted properly due to encryption key mismatch between link partners. Fault detection via software detection of unreadable ROH messages from link partner.	N/A	83	Critical
Encryption OneWay	IDU	Only one IDU has data encryption enabled. Fault detection via software messages to/from link partner.	N/A	84	Major
External Alarm 1	External	The external Alarm 1 input has been activated. Fault detection via polling GPIO. Polling interval 1 sec.	N/A	91	Info
External Alarm 2	External	The external Alarm 2 input has been activated. Fault detection via polling GPIO. Polling interval 1 sec.	N/A	92	Info

Alarm	Affected Component	Description	LED to RED	Alarm Code	Severity
External Alarm 3	External	The external Alarm 3 input has been activated. Fault detection via polling GPIO. Polling interval 1 sec.	N/A	93	Info
External Alarm 4	External	The external Alarm 4 input has been activated. Fault detection via polling GPIO. Polling interval 1 sec.	N/A	94	Info
Remote IDU Alarm	Link Partner IDU	The link partner IDU has indicated an alarm condition via ROH.	N/A	95	Major
Remote IDU External Alarm 1	Link Partner External	The link partner IDU has indicated via ROH its external alarm input 1 has been activated.	N/A	96	Info
Remote IDU External Alarm 2	Link Partner External	The link partner IDU has indicated via ROH its external alarm input 2 has been activated.	N/A	97	Info
Remote IDU External Alarm 3	Link Partner External	The link partner IDU has indicated via ROH its external alarm input 3 has been activated.	N/A	98	Info
Remote IDU External Alarm 4	Link Partner External	The link partner IDU has indicated via ROH its external alarm input 4 has been activated.	N/A	99	Info
STM Loss of Clock	IDU	The SDH/SONET clock has lost lock. Fault detection via polling of LIU.	N/A	Solid	Critical
STM RS_LOS	IDU	The SDH/SONET has a Loss of Signal Defect. Fault detection via polling of LIU.	N/A	Solid	Critical

Alarm	Affected Component	Description	LED to RED	Alarm Code	Severity
STM RS_B1	IDU	The SDH/SONET Mux/Demux has a B1 Defect. Fault detection via polling of RS_B1_T bit in STM-1 Core. Alternate detection via Interrupt enabled in STM-1 core.	N/A	Solid	Major
STM RS_LOF	IDU	The SDH/SONET Mux/Demux has a Loss of Frame Defect. Fault detection via polling of RS_LOF_T bit in STM-1 Core. Alternate detection via Interrupt enabled in STM-1 core.	N/A	Solid	Critical
STM RS_OOF	IDU	The SDH/SONET Mux/Demux has a Out of Frame Defect. Fault detection via polling of RS_OOF_T bit in STM-1 Core. Alternate detection via Interrupt enabled in STM-1 core.	N/A	Solid	Critical
STM RS_TIM	IDU	The SDH/SONET Mux/Demux has a Trace Identifier Mismatch Defect. Fault detection via polling of RS_TIM_T bit in STM-1 Core. Alternate detection via Interrupt enabled in STM-1 core.	N/A	Solid	Major
STM MS-AIS	IDU	The SDH/SONET Mux/Demux has detected an AIS at the Multiplexer Level. Fault detection via polling of MS_AIS_T bit in STM-1 Core. Alternate detection via Interrupt enabled in STM-1 core.	N/A	Solid	Critical

Alarm	Affected Component	Description	LED to RED	Alarm Code	Severity
STM MS-REI	IDU	The SDH/SONET Mux/Demux has detected a Remote Error at the Multiplexer Level. Fault detection via polling of MS_REI_T bit in STM-1 Core. Alternate detection via Interrupt enabled in STM-1 core.	N/A	Solid	Major
STM MS-RDI	IDU	The SDH/SONET Mux/Demux has detected an Remote Defect at the Multiplexer Level. Fault detection via polling of MS_RDI_T bit in STM-1 Core. Alternate detection via Interrupt enabled in STM-1 core.	N/A	Solid	Major
STM MS_B2	IDU	The SDH/SONET Mux/Demux has a B2 Defect at the Multiplex level. Fault detection via polling of MS_B2_T bit in STM-1 Core. Alternate detection via Interrupt enabled in STM-1 core.	N/A	Solid	Major
STM AU-AIS x	IDU	The SDH/SONET Mux/Demux has detected an AIS at the AU Level. Fault detection via polling of AU_AIS_T bit in STM-1 Core. Where 'x' is the HP index. Alternate detection via Interrupt enabled in STM-1 core.	N/A	Solid	Critical
STM AU-LOP x	IDU	The SDH/SONET Mux/Demux has detected an Loss of Pointer Defect at the AU Level. Fault detection via polling of AU_LOP_T bit in STM-1 Core. Where 'x' is the HP index. Alternate detection via Interrupt enabled in STM-1 core.	N/A	Solid	Critical

Alarm	Affected Component	Description	LED to RED	Alarm Code	Severity
STM HP-UNEQ x	IDU	The SDH/SONET Mux/Demux HP number 'x' is Unequipped. Fault detection via polling of HP_UNEQ_T bit in STM-1 Core. Where 'x' is the HP index. Alternate detection via Interrupt enabled in STM-1 core.	N/A	Solid	Critical
STM HP-TIM x	IDU	The SDH/SONET Mux/Demux HP number 'x' has a Trace Identifier Mismatch. Fault detection via polling of HP_TM_TIM_T bit in STM-1 Core. Where 'x' is the HP index. Alternate detection via Interrupt enabled in STM-1 core.	N/A	Solid	Major
STM HP-REI x	IDU	The SDH/SONET Mux/Demux HP number 'x' has a Remote Error Indication. Fault detection via polling of HP_REI_T bit in STM-1 Core. Where 'x' is the HP index. Alternate detection via Interrupt enabled in STM-1 core.	N/A	Solid	Major
STM HP-RDI x	IDU	The SDH/SONET Mux/Demux HP number 'x' has a Remote Defect Indication. Fault detection via polling of HP_RDI_T bit in STM-1 Core. Where 'x' is the HP index. Alternate detection via Interrupt enabled in STM-1 core.	N/A	Solid	Major
STM HP-PLM x	IDU	The SDH/SONET Mux/Demux HP number 'x' has a Path Identifier Mismatch. Fault detection via polling of HP_PLM_T bit in STM-1 Core. Where 'x' is the HP index. Alternate detection via Interrupt enabled in STM-1 core.	N/A	Solid	Critical

Alarm	Affected Component	Description	LED to RED	Alarm Code	Severity
STM HP_B3 x	IDU	The SDH/SONET Mux/Demux HP number 'x' has a CRC Error. Fault detection via polling of HP_B3_T bit in STM-1 Core. Where 'x' is the HP index. Alternate detection via Interrupt enabled in STM-1 core.	N/A	Solid	Major
STM TU-LOM lkm	IDU	The SDH/SONET Mux/Demux TU number 'x' has a Loss of Multiframe. Fault detection via polling of TU_LOMF_T bit in STM-1 Core. Where 'lkm' is the TU index as LKM numbering. Alternate detection via Interrupt enabled in STM-1 core.	N/A	Solid	Critical
STM TU-AIS lkm	IDU	The SDH/SONET Mux/Demux TU number 'x' has an AIS. Fault detection via polling of TU_AIS_T bit in STM-1 Core. Where 'lkm' is the TU index as LKM numbering. Alternate detection via Interrupt enabled in STM-1 core.	N/A	Solid	Critical
STM TU-LOP lkm	IDU	The SDH/SONET Mux/Demux TU number 'x' has a Loss of Pointer Defect. Fault detection via polling of TU_LOP_T bit in STM-1 Core. Where 'lkm' is the TU index as LKM numbering. Alternate detection via Interrupt enabled in STM-1 core.	N/A	Solid	Critical

Alarm	Affected Component	Description	LED to RED	Alarm Code	Severity
STM LP-UNEQ lkm	IDU	The SDH/SONET Mux/Demux LP number 'x' is Unequipped. Fault detection via polling of LP_UNEQ_T bit in STM-1 Core. Where 'lkm' is the LP index as LKM numbering. Alternate detection via Interrupt enabled in STM-1 core.	N/A	Solid	Major
STM LP-TIM lkm	IDU	The SDH/SONET Mux/Demux LP number 'x' has a Trace Identifier Mismatch. Fault detection via polling of LP_TM_TIM_T bit in STM-1 Core. Where 'lkm' is the LP index as LKM numbering. Alternate detection via Interrupt enabled in STM-1 core.	N/A	Solid	Major
STM LP-REI lkm	IDU	The SDH/SONET Mux/Demux LP number 'x' has a Remote Error Indication. Fault detection via polling of LP_REI_T bit in STM-1 Core. Where 'lkm' is the LP index as LKM numbering. Alternate detection via Interrupt enabled in STM-1 core.	N/A	Solid	Major
STM LP-RDI lkm	IDU	The SDH/SONET Mux/Demux LP number 'x' has a Remote Defect Indication. Fault detection via polling of LP_RDI_T bit in STM-1 Core. Where 'lkm' is the LP index as LKM numbering. Alternate detection via Interrupt enabled in STM-1 core.	N/A	Solid	Major

Alarm	Affected Component	Description	LED to RED	Alarm Code	Severity
STM LP-PLM lkm	IDU	The SDH/SONET Mux/Demux LP number 'x' has a Path Identifier Mismatch. Fault detection via polling of LP_PLM_T bit in STM-1 Core. Where 'lkm' is the LP index as LKM numbering. Alternate detection via Interrupt enabled in STM-1 core.	N/A	Solid	Critical
STM LP-RFI lkm	IDU	The SDH/SONET Mux/Demux LP number 'x' has a Remote Fault Indication. Fault detection via polling of LP_RFI_T bit in STM-1 Core. Where 'lkm' is the LP index as LKM numbering. Alternate detection via Interrupt enabled in STM-1 core.	N/A	Solid	Critical
STM LP-BIP2 lkm	IDU	The SDH/SONET Mux/Demux LP number 'x' has a CRC Error. Fault detection via polling of LP_BIP2_T bit in STM-1 Core. Where 'lkm' is the LP index as LKM numbering. Alternate detection via Interrupt enabled in STM-1 core.	N/A	Solid	Major
SDIDU Power-Up	IDU	During power-up raise then lower this alarm.	N/A	Solid	Info
SDIDU Re-boot	IDU	When a user reboots the SDIDU, raise then lower this alarm prior to re-booting.	N/A	Solid	Info
NTP Update	IDU	When the system time is updated via NTP raise then lower this alarm. The previous system time and new system time should be noted in the alarm log, snmp trap, and syslog messages.	N/A	Solid	Info

Alarm	Affected Component	Description	LED to RED	Alarm Code	Severity
Remote Reconfiguration Failure	IDU	When a remote reconfiguration fails and the original configuration is restored after timeout, raise then lower this alarm.	N/A	Solid	Info
FPGA Programming Failure	IDU	When the FPGA programming fails, this alarm shall be set.	N/A	Solid	Critical
Reconfiguration Failure	IDU	When the local SDIDU configuration fails raise then lower this alarm.	N/A	Solid	Info

6.2 Abbreviations & Acronyms

A _d TPC	Adaptive Power Control
AIS	Alarm Indication Signal
BER	Bit Error Rate
Codec	Coder-Decoder
CPU	Central Processing Unit
DB	Decibel
DBm	Decibel relative to 1 mW
DCE	Data Circuit-Terminating Equipment
DTE	Data Terminal Equipment
EIRP	Effective Isotropic Radiated Power
FCC	Federal Communications Commission
FEC	Forward Error Correction
FPGA	Field Programmable Gate Array
GPIO	General Purpose Input/Output
IF	Intermediate frequency
IP	Internet Protocol
LED	Light-emitting diode
LOS	Line of Sight
MIB	Management Information Base

Modem	Modulator-demodulator
ms	Millisecond
NC	Normally closed
NMS	Network Management System
OAM&P	Operations, Administration, Maintenance, and Provisioning
OC-3	Optical Carrier level 3
ODU	Outdoor Unit
PCB	Printed circuit board
POP	Point of Presence
QAM	Quadrature Amplitude Modulation
QPSK	Quadrature Phase Shift Keying
RF	Radio Frequency
RSL	Received Signal Level (in dBm)
RSSI	Received Signal Strength Indicator/Indication
RX	Receiver
SDH	Synchronous Digital Hierarchy
SNMP	Simple Network Management Protocol
SNR	Signal-to-Noise Ratio
SDIDU™	Software Defined Indoor Unit (CarrierComm trademark)
SONET	Synchronous Optical Network
STM-1	Synchronous Transport Module 1
TCP/IP	Transmission Control Protocol/Internet Protocol
TTL	Transistor-transistor logic
TX	Transmitter

IN CASE OF DIFFICULTY...

MDS products are designed for long life and trouble-free operation. However, this equipment, as with all electronic equipment, may have an occasional component failure. The following information will assist you in the event that servicing becomes necessary.

TECHNICAL ASSISTANCE

Technical assistance for MDS products is available from our Technical Support Department during business hours (8:00 A.M.–5:30 P.M. Eastern Time). When calling, please give the complete model number of the radio, along with a description of the trouble/symptom(s) that you are experiencing. In many cases, problems can be resolved over the telephone, without the need for returning the unit to the factory. Please use one of the following means for product assistance:

Phone: 585 241-5510 E-Mail: <mailto:TechSupport@microwavedata.com>

FAX: 585 242-8369 Web: <http://www.microwavedata.com/>

FACTORY SERVICE

Component level repair of radio equipment is not recommended in the field. Many components are installed using surface mount technology, which requires specialized training and equipment for proper servicing. For this reason, the equipment should be returned to the factory for any PC board repairs. The factory is best equipped to diagnose, repair and align your radio to its proper operating specifications.

If return of the equipment is necessary, you will be issued a Service Request Order (SRO) number and return shipping address. The SRO number will help expedite the repair so that the equipment can be repaired and returned to you as quickly as possible. Please be sure to include the SRO number on the outside of the shipping box, and on any correspondence relating to the repair. No equipment will be accepted for repair without an SRO number.

A statement should accompany the radio describing, in detail, the trouble symptom(s), and a description of any associated equipment normally connected to the radio. It is also important to include the name and telephone number of a person in your organization who can be contacted if additional information is required.

The radio must be properly packed for return to the factory. The original shipping container and packaging materials should be used whenever possible.

When repairs have been completed, the equipment will be returned to you by the same shipping method used to send it to the factory. Please specify if you wish to make different shipping arrangements. To inquire about an in-process repair, you may contact our Product Services Group at 585-241-5540 (FAX: 585-242-8400), or via e-mail at: ProductServices@microwavedata.com

