

Microwave Data Systems Inc.  
**MDS TransNET OEM™**

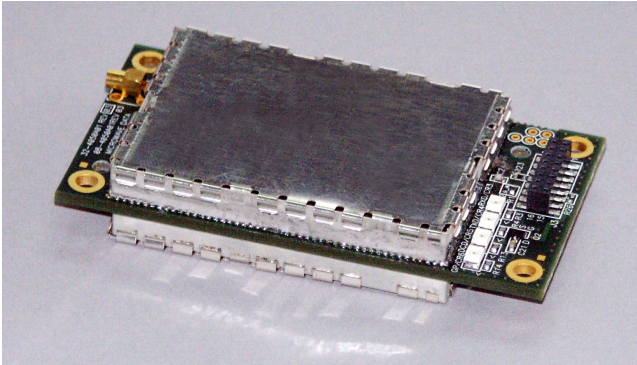

Transceiver Model EL806-2.4

**2.4 GHz**  
**Spread Spectrum Data Transceiver**

*Including Instructions for*  
*03-4053A01 Evaluation Development Kit*

MDS 05-xxxxA01, Rev. 01  
MARCH 2004  
PRELIMINARY

**industrial/wireless/performance**



# QUICK START GUIDE

The steps below contain the essential information needed to place the OEM transceiver in service. Because the transceiver is designed for use in other pieces of equipment, these steps assume that prior testing and evaluation have been conducted with the host device. If not, please refer to Section 3.0, Benchtop Setup and Evaluation for interface wiring and configuration details.

## 1. Mount the transceiver module using the four holes provided.

- If possible, select a mounting location that allows viewing the status LEDs and provides ready access to the antenna connector.
- Use standoff hardware to secure the board to the host device.
- When mounting the board, use care to align the transceiver's 16-pin header connector with the mating pins in the host device.

## 2. Connect the antenna system to the transceiver

- Use only with antenna/feedline assemblies that have been expressly tested and approved for such service by Microwave Data Systems Inc.
- Use an MCX-type male connector to attach the antenna to the transceiver.
- For best performance, antennas should be mounted in the clear, with an unobstructed path in the direction of desired transmission/reception.

## 3. Apply power and observe the LEDs for proper operation. The LED command must be set to ON (LEDS ON).

After 16 seconds...

- The GP lamp should be lit continuously
- The DCD lamp should be lit continuously—if synchronization with another unit has been achieved
- The Remote radio(s) should be transmitting data (TXD) and receiving data (RXD) with its associated station

### LED Indicator Descriptions

LED Name	Description
RXD (CR3) Receive Data	Serial receive data activity. Payload data from connected device.
TXD (CR4) Transmit Data	Serial transmit data activity. Payload data to connected device.
DCD (CR5) Data Carrier Detect	Continuous—Radio is receiving/sending synchronization frames On within 10 seconds of power-up under normal conditions

GP (CR6)  
General Purpose

- Continuous—Power is applied to the radio; no problems detected
- Flashing (5 times-per-second)—Fault indication. See "TROUBLESHOOTING" on Page 52

RXD



TXD



DCD



GP





---

# CONTENTS

---

1.0 ABOUT THIS MANUAL.....	1
2.0 PRODUCT DESCRIPTION.....	1
2.1 Transceiver Features .....	2
2.2 Model Configuration Codes .....	2
2.3 Spread Spectrum Transmission .....	3
2.4 Typical Applications .....	3
Multiple Address Systems (MAS) .....	3
Point-to-Point System .....	4
Tail-End Link to an Existing Network .....	5
Store-and-Forward Repeater .....	5
2.5 Transceiver Accessories .....	6
3.0 BENCHTOP SETUP & EVALUATION .....	7
3.1 Evaluation Development Kit (P/N 03-4053A01) .....	7
Evaluation Board .....	8
Connecting the Evaluation Board & Transceiver.....	9
3.2 Cable Connections for Benchtop Testing .....	10
Antenna Connection .....	10
Diagnostic Connection (J4).....	11
Data Connector (J5) .....	12
DC Power Connector (J3).....	14
Jumper Block J1 (DC Power Configuration) .....	15
3.3 Initial Power-Up & Configuration .....	15
Configuration Settings .....	16
LED Indicators .....	17
4.0 EVALUATION BOARD DOCUMENTATION .....	18
4.1 Assembly Drawing .....	18
4.2 Parts List .....	18
4.3 Evaluation Board Fuse Replacement .....	20
5.0 TRANSCEIVER MOUNTING .....	21

---



- 5.1 Mounting Dimensions ..... 21
- 5.2 Antennas & Feedlines ..... 21
  - Feedlines..... 22
- 6.0 OPTIMIZING PERFORMANCE..... 23

---
- 6.1 Antenna Aiming ..... 23
- 6.2 Antenna SWR Check ..... 23
- 6.3 Data Buffer Setting ..... 23
- 6.4 Hoptime Setting ..... 23
- 6.5 Operation at 115200 bps ..... 24
- 6.6 Baud Rate Setting ..... 24
- 6.7 Radio Interference Checks ..... 24
- 6.8 RF Output Setting ..... 24
- 7.0 OPERATING PRINCIPLES & SPECIAL CONFIGURATIONS ..... 25

---
- 7.1 How Remotes Acquire Synchronization ..... 25
- 7.2 Establishing a Tail-End Link ..... 25
- 7.3 Store & Forward (SAF) Operation w/Extension Radios .... 26
  - Simple Extended SAF Network..... 26
  - Extended SAF Network..... 27
  - Retransmission and ARQ operation..... 28
  - Synchronization in SAF Networks..... 28
  - Configuration Parameters for S&F Services ..... 29
- 7.4 Sleep Mode Operation (Remote units only) ..... 31
  - Sleep Mode Example ..... 32
- 8.0 DEALING WITH INTERFERENCE..... 32

---
- 9.0 PROGRAMMING REFERENCE ..... 34

---
- 9.1 Programming Methods ..... 34
  - Terminal Interface Mode..... 34
  - PC-Based Configuration Software ..... 34
- 9.2 User Commands ..... 34
  - Entering Commands ..... 35
- 9.3 Detailed Command Descriptions ..... 40
  - ADDR [1–65000]..... 40
  - AMASK [0000 0000–FFFF FFFF]..... 41



ASENSE [HI/LO].....	41
BAUD [xxxxx abc] .....	41
BUFF [ON, OFF].....	41
CODE [NONE, 1..255] .....	42
CTS [0-255].....	42
CTSHOLD [0-60000].....	43
DEVICE [DCE, CTS KEY] .....	43
DLINK [xxxxx/ON/OFF].....	43
DKEY .....	44
DTYPE [NODE/ROOT] .....	44
FEC [ON, OFF].....	44
HOPTIME [7, 28] .....	44
INIT .....	44
HREV .....	45
KEY.....	45
LEDS [ON, OFF].....	45
MODE [M, R, X].....	45
OWM [xxxxx].....	45
OWN [xxxxx] .....	45
PORT [RS232, RS485].....	45
PWR [20-30] .....	46
REPEAT [0-10].....	47
RETRY [0-10].....	47
RSSI .....	47
RTU [ON, OFF, 0-80] .....	48
RX [xxxx].....	48
RXTOT [NONE, 0-1440] .....	48
SAF [ON, OFF] .....	48
SETUP .....	48
SER .....	49
SHOW PWR .....	49
SHOW SYNC.....	49
SKIP [NONE, 1..8] .....	49
SLEEP [ON, OFF].....	50
SREV .....	50
STAT .....	50
TEMP.....	50
TX [xxxx].....	50
UNIT [10000-65000] .....	50



XADDR [0–31].....	51
XMAP [00000000-FFFFFFFF] .....	51
XPRI [0–31].....	51
XRSSI [NONE, –40...–120].....	51
ZONE CLEAR .....	51
ZONE DATA.....	51
<b>10.0 TROUBLESHOOTING.....</b>	<b>52</b>
<hr/>	
10.1 Alarm Codes .....	53
Checking for Alarms—STAT command .....	53
Major Alarms vs. Minor Alarms .....	53
Alarm Code Definitions .....	53
10.2 LED Indicators .....	54
10.3 Troubleshooting Chart .....	54
10.4 Network-Wide Remote Diagnostics .....	55
<b>11.0 FIRMWARE UPGRADES.....</b>	<b>57</b>
<hr/>	
11.1 Obtaining new firmware .....	57
Saving a Web-site firmware file to your PC.....	57
11.2 Installing firmware in your radio .....	57
<b>12.0 Security .....</b>	<b>57</b>
<hr/>	
<b>13.0 Product Specifications.....</b>	<b>58</b>
<hr/>	
13.1 Detailed Pin Descriptions .....	59
<b>14.0 dBm-Watts-Volts Conversion Chart.....</b>	<b>66</b>
<hr/>	

## To Our Customers

We appreciate your patronage. You are our business. We promise to serve and anticipate your needs. We strive to give you solutions that are cost effective, innovative, reliable and of the highest quality possible. We promise to build a relationship that is forthright and ethical, one that builds confidence and trust.

## Copyright Notice

This manual and all software described herein are Copyright 2004 by Microwave Data Systems Inc. All rights reserved. Microwave Data Systems Inc. reserves its right to correct any errors or omissions in this manual without obligation to any party.



## RF Exposure Notice



The radio equipment described in this guide emits radio frequency energy. Although the power level is low, the concentrated energy from a directional antenna may pose a health hazard. All antennas used with this transmitter, whether indoor or outdoor mounted, must be installed to provide a separation distance of at least 11.2 cm (4.4 inches) from all persons, and must not be co-located or operating in conjunction with any other antenna or transmitter.

In mobile applications (vehicle mounted) the above separation distance must be maintained at all times. More information on RF exposure is available on the Internet at [www.fcc.gov/oet/info/documents/bulletins](http://www.fcc.gov/oet/info/documents/bulletins).

## FCC Part 15 Notice

This equipment has been tested and found to comply with the limits for a Class A digital device, pursuant to Part 15 of the FCC Rules. These limits are designed to provide reasonable protection against harmful interference when the equipment is operated in a commercial environment. This equipment generates, uses, and can radiate radio frequency energy and, if not installed and used in accordance with the instruction manual, may cause harmful interference to radio communications. Operation of this equipment in a residential environment is likely to cause harmful interference in which case the user will be required to correct the interference at his own expense.

## FCC Modular Approval Notice

This device is offered as an FCC Part 15 Unlicensed Limited Modular Transmitter (LMA). This Modular Transmitter is approved for use only with specific antenna, cable and output power configurations that have been tested and approved by the manufacturer (Microwave Data Systems Inc.). Modifications to the radio, the antenna system, or power output, that have not been explicitly specified by the manufacturer are not permitted, and may render the radio non-compliant with applicable regulatory authorities. Refer to “[EIRP Compliance Check](#)” on [Page 23](#) for more detailed information.

This device employs a unique connector at all connections between the module and the antenna, including the cable. Consult MDS for approved antenna/cable assemblies in our product offering. When this device is placed inside an enclosure, a durable label must be affixed to the outside of the assembled device which states: “Contains TX FCC ID: E5MDS-EL806-24”.

**Changes or modifications not expressly approved by the party responsible for compliance could void the user’s authority to operate the equipment.**

**Notice to OEM Integrators: This is a modular FCC Part 15 approval. Integrators shall not supply in their documentation any instructions on how to remove or install this module.**

## ISO 9001 Registration

Microwave Data Systems Inc. adheres to the internationally-accepted ISO 9001 quality system standard.



## Manual Revision and Accuracy

While every reasonable effort has been made to ensure the accuracy of this guide, product improvements may result in minor differences between the manual and the product shipped to you. If you have additional questions or need an exact specification for a product, please contact our Customer Service Team using the information at the back of this guide. In addition, manual updates can often be found on the MDS website at [www.microwavedata.com](http://www.microwavedata.com).





## 1.0 ABOUT THIS MANUAL

This manual is intended to guide technical personnel in the integration of MDS TransNET OEM™ transceivers into existing electronic equipment. The OEM transceiver is designed for use inside Remote Terminal Units (RTUs), Programmable Logic Controllers (PLCs) and other equipment associated with remote data collection, telemetry and control.

The manual provides instructions for interface connections, hardware mounting, and programming commands. Following integration of the transceiver, it is recommended that a copy of this manual be retained for future reference by technical personnel.

## 2.0 PRODUCT DESCRIPTION

The OEM transceiver, (Figure 1), is a compact, spread spectrum wireless module designed for license-free operation in the 2.4 GHz frequency range. It is contained on one double-sided circuit board with all necessary components and RF shielding included. It need only be protected from direct exposure to the weather and is designed for rugged service in extreme temperature environments. The transceiver has full over-the-air compatibility with standard (non-OEM) TransNET™ transceivers manufactured by MDS.

All transceiver programming is performed via a connected PC terminal. No jumper settings or manual adjustments are used to configure the transceiver for operation.

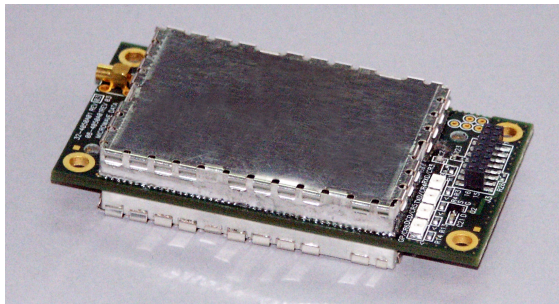

**Figure 1. TransNET OEM™ Transceiver**

The transceiver employs Digital Signal Processing (DSP) technology for highly reliable data communications, even in the presence of weak or interfering signals. DSP techniques also make it possible to obtain information about the radio's operation and troubleshoot problems, often eliminating the need for site visits.

Using appropriate software at the master station, diagnostic data can be retrieved for any radio in the system, even while payload data is being transmitted. (See “[Network-Wide Remote Diagnostics](#)” on Page 56.)



## 2.1 Transceiver Features

The OEM transceiver is designed for easy installation and flexibility in a wide range of wireless applications. Listed below are several key features of the transceiver which are described in more detail later in this guide.

- Three operating bands in the 2.4006 to 2.4820 GHz spectrum
- Configurable operating zones to omit frequencies with constant interference
- 65,000 available network addresses to enhance communications security
- Network-wide configuration from the master station; eliminates most trips to remote sites
- Data transparency—ensures compatibility with virtually all asynchronous data terminals
- Peak-hold RSSI, averaged over eight hop cycles
- Operation at up to 115,200 bps continuous data flow
- Store-and-Forward repeater operation
- Data latency typically less than 10 ms
- Same hardware for master or remote configuration
- Supports RS/EIA-232 or RS/EIA-485 interfaces (factory configured)
- Low current consumption—nominal 8 mA in “sleep” mode. Ideal for solar/battery powered applications.

**NOTE:** Some features may not be available on all units, based on the options purchased and the regulatory constraints for the region in which the radio will operate.

## 2.2 Model Configuration Codes

The model number code is printed on the radio module, and provides key information about how it was configured when it left the factory. See [Figure 2](#) for an explanation of the model number codes. (Note: This information is subject to change and should not be used for ordering additional products. Your factory representative can assist you with product ordering.)

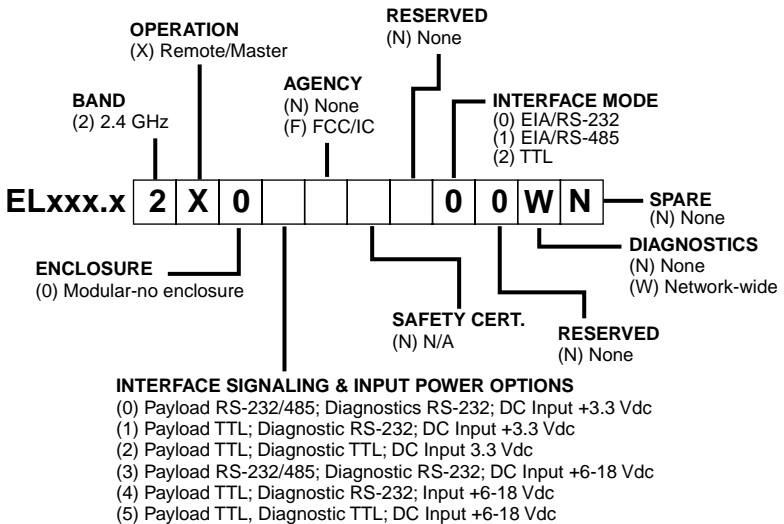

**Figure 2. Model Number Configuration Codes**

## 2.3 Spread Spectrum Transmission

The transceiver “hops” from channel to channel many times per second using a specific hop pattern applied to all radios in the network. A distinct hopping pattern is provided for each of the 65,000 available network addresses, thereby minimizing the chance of interference with other spread spectrum systems.

In the USA, and certain other countries, no license is required to install and operate this type of radio device, provided RF power and antenna gain restrictions are observed. In the USA and Canada, a maximum of 36 dBm Effective Isotropic Radiated Power (EIRP) is allowed. The factory offers a set of approved antennas with special connectors for this radio. Substitutions that would void the compliance of the device are not permitted.

## 2.4 Typical Applications

### Multiple Address Systems (MAS)

This is the most common application of the transceiver. It consists of a central control station (master) and two or more associated remote units, as shown in [Figure 3](#). This type of network provides communications between a central host computer and remote terminal units (RTUs) or other data collection devices. The operation of the radio system is transparent to the computer equipment. This application provides a practical alternative to traditional (licensed) MAS radio systems.

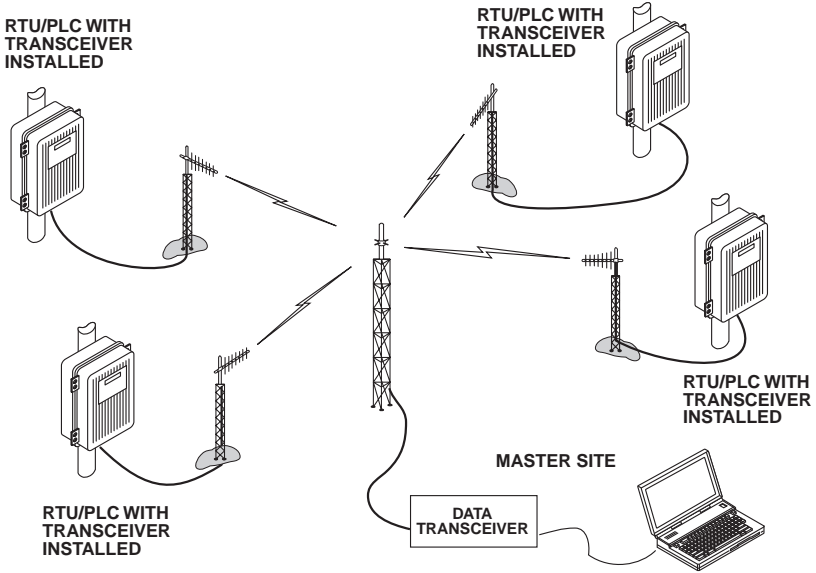

Figure 3. Typical MAS Network

### Point-to-Point System

A point-to-point configuration (Figure 4) is a simple arrangement consisting of just two radios—a master and a remote. This provides a half-duplex communications link for the transfer of data between two locations.

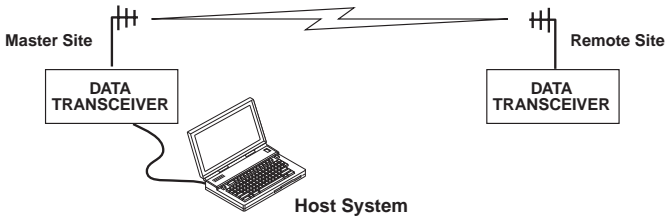

Figure 4. Typical Point-to-Point Link



## Tail-End Link to an Existing Network

A tail-end link is often used to extend the range of a traditional (licensed) MAS system without adding another licensed radio. This might be required if an outlying site is blocked from the MAS master station by a natural or man-made obstruction. In this arrangement, a spread spectrum transceiver links the outlying remote site into the rest of the system by sending data from that site to an associated transceiver installed at one of the licensed remote sites—usually the one closest to the outlying facility. (See Figure 5).

As the data from the outlying site is received at the associated transceiver, it is transferred to the co-located licensed radio (via a data crossover cable) and is transmitted to the MAS master station over the licensed channel. Additional details for tail-end links are given in Section 7.2 (Page 25).

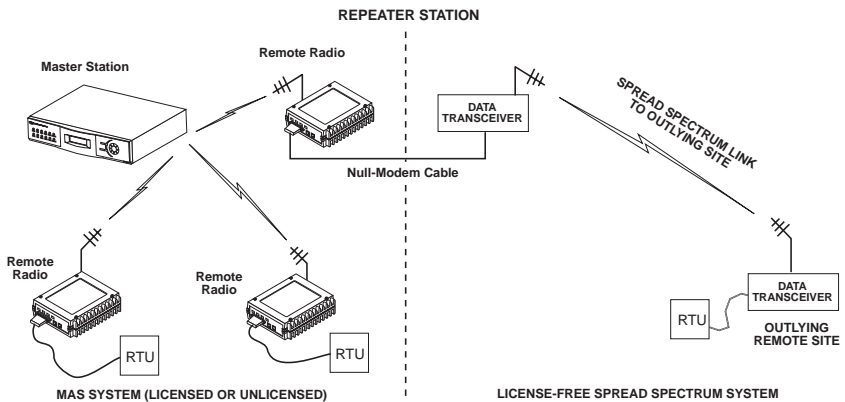
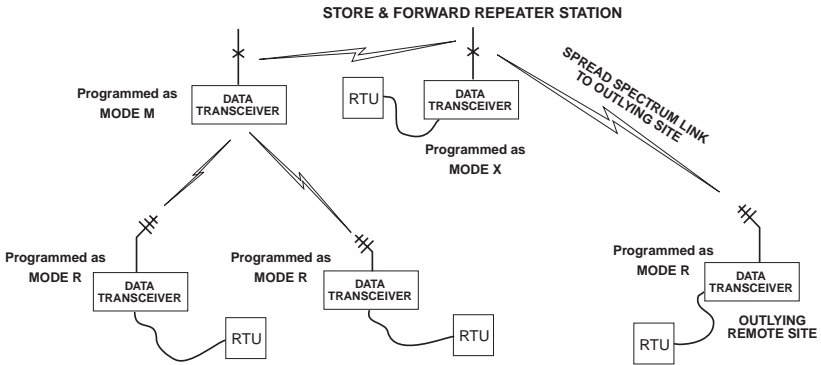

Figure 5. Typical Tail-End Link Arrangement

## Store-and-Forward Repeater

Similar to a Tail-End Link, Store-and-Forward (SAF) offers a way to physically extend the range of a network, but in a simplified and economical manner. SAF operates by storing up the data received from one site, and then retransmitting it a short time later. Figure 6 shows a typical SAF repeater arrangement.

SAF operates by dividing a network into a vertical hierarchy of two or more sub-networks. Extension radios (designated as **MODE X**) serve as single-radio repeaters that link adjacent sub-networks, and move data from one sub-network to the next. Additional information on SAF mode is provided in “Store & Forward (SAF) Operation with Extension Radios” on Page 26.



**Figure 6. Store-and-Forward Repeater Network**

## 2.5 Transceiver Accessories

One or more of the accessories listed in [Table 1](#) may be used with the OEM transceiver. Contact your factory representative for availability and ordering details.

**Table 1. OEM Transceiver Accessories**

Accessory	Description	Part No.
AC Power Adapter	Small power supply designed for continuous operation of the transceiver. UL approved. Input: 120/220; Output: 12 Vdc.	01-3862A02
TransNET Support Package CD	Programming, diagnostic and support files on a CD ROM. Includes electronic copy of this guide (PDF format).	03-2708A01
RJ-11-to-DB9 Adapter Cable	Short cable assembly that converts RJ-11 to DB9 connector type	03-3246A01
Fuse (for Evaluation Board)	2A SMF Slo-Blo (plugs into FH1 on Evaluation Board)	29-1784A03
InSite Diagnostic Software	PC-based diagnostic software for MDS radios. Supplied on CD.	03-3533A01
Omnidirectional Antennas	Rugged antennas suitable for use at Master stations.	Various

**Table 1. OEM Transceiver Accessories (Continued)**

Yagi Antenna	Rugged directional antennas suitable for use at Remote stations.	Various
Whip Antennas	Short, flexible antennas suitable for short-range applications. Available with and without coaxial feedlines.	Various
Bandpass Filter	Antenna system filter to aid in eliminating interference from high power transmitters, such as those used in paging systems.	20-2822A01
Evaluation Development Kit	Kit containing two OEM Transceiver modules, whip antennas, two Evaluation Boards, support software on CD, cables, power supplies and other accessories needed to operate the transceiver in a benchtop setting.	Consult Factory

### 3.0 BENCHTOP SETUP & EVALUATION

As an Integrator, your first task is to verify that the OEM module will function as intended with the host equipment. This section describes how to test the unit for operation with host devices such as RTUs, PLCs and similar gear. It covers the steps for making interface connections, powering up the transceiver, and setting configuration parameters using a connected PC.

Evaluation of the module is best performed in a controlled environment, such as a shop or lab facility where you can readily test various hardware and programming configurations and observe the effects of these changes before final installation.

Once you are satisfied that the transceiver module operates properly on the bench, you can plan the installation of the module inside the host device and be assured of proper operation in the field.

#### 3.1 Evaluation Development Kit

The Evaluation Development Kit is designed to assist integrators who will be working with the transceiver in a benchtop setting. The kit contains the following:

- Two OEM Transceiver modules (configured for TTL, or RS-232/485 operation, as requested)
- Two Evaluation Development boards (P/N 03-4051A01)
- Interface Cables
- Two whip antennas
- Two 12 Vdc power supplies
- TransNET Support CD containing software for programming & diagnostics