



Range Hoods

Vented

Safety Information 2, 3

Operating/Care and Cleaning Instructions

Charcoal Filters5
Grease Filters4
Hood Lights5
Hood Surfaces5
Stainless Steel Surfaces5
Vent Controls4

Installation Instructions ... 6-15

Troubleshooting Tips16

Consumer Support

Consumer Support20
Warranty 19

**Owner's Manual
and Installation
Instructions**

- JV535
- JV536
- JV565
- JV566
- JV635
- JV636
- JV665
- JV666

Write the model and serial numbers here:

Model # _____

Serial # _____

Find these numbers on a label on the back wall of the hood.



IMPORTANT SAFETY INFORMATION. READ ALL INSTRUCTIONS BEFORE USING.

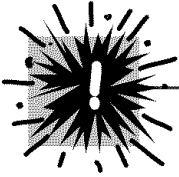

SAFETY PRECAUTIONS

WARNING — TO REDUCE THE RISK OF FIRE, ELECTRIC SHOCK OR INJURY TO PERSONS, OBSERVE THE FOLLOWING:

- A. Use this unit only in the manner intended by the manufacturer. If you have questions, contact the manufacturer.
- B. Before servicing or cleaning unit, switch power off at service panel and lock the service disconnecting means to prevent power from being switched on accidentally. When the service disconnecting means cannot be locked, securely fasten a prominent warning device, such as a tag, to the service panel.
- C. Do not use this unit with any solid-state speed control device.
- D. This unit must be grounded.

CAUTION — FOR GENERAL VENTILATING USE ONLY. DO NOT USE TO EXHAUST HAZARDOUS OR EXPLOSIVE MATERIALS AND VAPORS.

WARNING — TO REDUCE THE RISK OF INJURY TO PERSONS IN THE EVENT OF A RANGE TOP GREASE FIRE, OBSERVE THE FOLLOWING*:

- A. SMOTHER FLAMES with a close-fitting lid, cookie sheet or metal tray, then turn off the burner. BE CAREFUL TO PREVENT BURNS. If the flames do not go out immediately, EVACUATE AND CALL THE FIRE DEPARTMENT.
- B. NEVER PICK UP A FLAMING PAN—You may be burned.
- C. DO NOT USE WATER, including wet dishcloths or towels—a violent steam explosion will result.
- D. Use an extinguisher ONLY if:
 1. You know you have a Class ABC extinguisher, and you already know how to operate it.
 2. The fire is small and contained in the area where it started.
 3. The fire department is being called.
 4. You can fight the fire with your back to an exit.

* Based on "Kitchen Firesafety Tips" published by NFPA.

WARNING — TO REDUCE THE RISK OF A RANGE TOP GREASE FIRE:

- A. Never leave surface units unattended at high settings. Boilovers cause smoking and greasy spillovers that may ignite. Heat oils slowly on low or medium settings.
- B. Always turn hood **ON** when cooking at high heat or when cooking flaming foods.
- C. Clean ventilating fans frequently. Grease should not be allowed to accumulate on fan or filter.
- D. Use proper pan size. Always use cookware appropriate for the size of the surface element.

WARNING — TO REDUCE THE RISK OF FIRE, ELECTRIC SHOCK OR INJURY TO PERSONS, OBSERVE THE FOLLOWING:

- A. Installation work and electrical wiring must be done by qualified person(s) in accordance with all applicable codes and standards, including fire-rated construction.
- B. Sufficient air is needed for proper combustion and exhausting of gases through the flue (chimney) of fuel burning equipment to prevent back drafting. Follow the heating equipment manufacturer's guideline and safety standards such as those published by the National Fire Protection Association (NFPA), the American Society for Heating, Refrigeration and Air Conditioning Engineers (ASHRAE) and the local code authorities.
- C. When cutting or drilling into wall or ceiling, do not damage electrical wiring and other hidden utilities.
- D. Ducted fans must always be vented to the outdoors.

WARNING — TO REDUCE THE RISK OF FIRE, USE ONLY METAL DUCTWORK.

- Do not attempt to repair or replace any part of your hood unless it is specifically recommended in this guide. All other servicing should be referred to a qualified technician.



READ AND FOLLOW THIS SAFETY INFORMATION CAREFULLY.
READ AND SAVE THESE INSTRUCTIONS

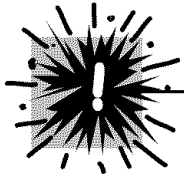

PRÉCAUTIONS EN MATIÈRE DE SÉCURITÉ

AVERTISSEMENT — POUR RÉDUIRE LE RISQUE D'INCENDIE, DE SECOUSSE ÉLECTRIQUE OU DE BLESSURE CORPORELLE, OBSERVEZ LES PRÉCAUTIONS SUIVANTES :

- A. N'utilisez cet appareil que de la manière prévue par le fabricant. Si vous avez des questions, appelez le fabricant.
- B. Avant de réparer ou de nettoyer votre appareil, débranchez le courant au niveau du panneau de service et verrouillez les mécanismes de débranchement de service pour éviter tout branchement accidentel au courant. Si vous ne pouvez pas verrouiller les mécanismes de débranchement de service, attachez soigneusement un avertissement bien visible, comme une étiquette, au panneau de service.
- C. N'utilisez jamais cet appareil avec un mécanisme de réglage de la vitesse à semi-conducteurs.
- D. Cet appareil doit être bien mis à la terre.

ATTENTION — UNIQUEMENT À USAGE DE VENTILATION GÉNÉRALE. N'UTILISEZ JAMAIS POUR L'ÉCHAPPEMENT DE MATIÈRES ET DE VAPEURS EXPLOSIVES.

AVERTISSEMENT — POUR RÉDUIRE LE RISQUE DE BLESSURE CORPORELLE SI DE LA GRAISSE PREND FEU SUR LA SURFACE DE CUISSON DU FOUR, SUIVEZ LES INSTRUCTIONS SUIVANTES* :

- A. ÉTOUFFEZ LES FLAMMES avec un couvercle qui convient, une tôle à biscuits ou un plateau en métal, puis éteignez le brûleur. FAITES BIEN ATTENTION DE NE PAS VOUS BRÛLER. Si les flammes ne s'éteignent pas immédiatement, SORTEZ ET APPELEZ LES POMPIERS.
- B. NE DÉPLACEZ JAMAIS UNE CASSEROLLE QUI FLAMBE – Vous pouvez vous brûler.
- C. N'UTILISEZ JAMAIS D'EAU, en particulier de serviette ou de chiffon mouillé – il se produira une explosion violente de vapeur brûlante.
- D. N'UTILISEZ UN EXTINCTEUR que si :
 - 1. Vous avez un extincteur de classe ABC et vous savez comment l'utiliser;
 - 2. Le feu est réduit et confiné à l'endroit où il a commencé;
 - 3. Vous avez déjà appelé les pompiers;
 - 4. Vous combattez les flammes en tournant le dos à une sortie.

* Basé sur l'ouvrage intitulé «Kitchen Fire Safety Tips» publié par la NFPA.

AVERTISSEMENT — RÉDUISEZ LE RISQUE D'UN FEU DE GRAISSE SUR LA SURFACE DE CUISSON DU FOUR :

- A. Ne laissez jamais sans surveillance les unités de cuisson de surface à une température élevée. Le bouillonnement occasionne des débordements fumants et graisseux qui peuvent prendre feu. Chauffez à feu doux les substances huileuses, avec un réglage bas ou moyen.
- B. Mettez toujours la hotte en marche quand vous cuisinez à haute température ou quand vous cuisinez des aliments qui ont des flammes.
- C. Nettoyez les mécanismes de ventilation fréquemment. Il ne faut pas permettre une accumulation de graisse sur le ventilateur ou sur le filtre.
- D. Utilisez une casserole de bonne taille. Utilisez toujours un ustensile de cuisine qui convienne au diamètre de l'élément de cuisson.

AVERTISSEMENT — POUR RÉDUIRE LE RISQUE D'INCENDIE, DE SECOUSSE ÉLECTRIQUE OU DE BLESSURE CORPORELLE, OBSERVEZ LES PRÉCAUTIONS SUIVANTES :

- A. Vous devez faire exécuter tous les travaux d'installation et de câblage électrique par une personne qualifiée, conformément à tous les codes et les normes en vigueur, en particulier ceux de construction relatifs aux incendies.
- B. Vous devez assez d'air pour avoir une bonne combustion et permettre l'évacuation des gaz par le conduit de cheminée du matériel de combustion du carburant, afin d'éviter tout retour d'air. Suivez les directives du fabricant de matériel de combustion et les normes de sécurité comme celles publiées par la National Fire Protection Association (NFPA), l'American Society for Heating, Refrigeration and Air Conditioning Engineers (ASHRAE), ainsi que les modalités des codes locaux.
- C. Si vous faites un trou ou une ouverture dans un mur ou un plafond, n'endommagez pas les fils électriques et les autres installations cachées de service public.
- D. Vous devez toujours alimenter les ventilateurs dans les conduits en air en provenance de l'extérieur.

AVERTISSEMENT — POUR RÉDUIRE LE RISQUE D'INCENDIE, N'UTILISEZ QUE DES CONDUITS EN MÉTAL

- N'essayez jamais de remplacer ou de réparer un élément de votre hotte si le présent manuel ne le recommande pas expressément. Tout autre entretien doit être effectué par un technicien qualifié.



LISEZ ET SUIVEZ ATTENTIVEMENT CES INSTRUCTIONS.

LISEZ ET CONSERVEZ CES INSTRUCTIONS

Using the hood controls.

Throughout this manual, features and appearance may vary from your model.

Control Knobs (on some models)

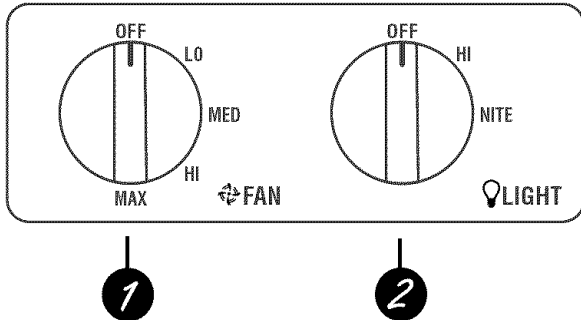

1 FAN Control

Turn to **LO**, **MED**, **HI** or **MAX** as needed. Continuous use of the fan system while cooking helps keep the kitchen comfortable and less humid. It also reduces cooking odors and soiling moisture that create a frequent need for cleaning.

2 LIGHT Control

Turn to **HI** while cooking or to **NITE** for use as a night light.

Rocker Switch Controls (on some models)

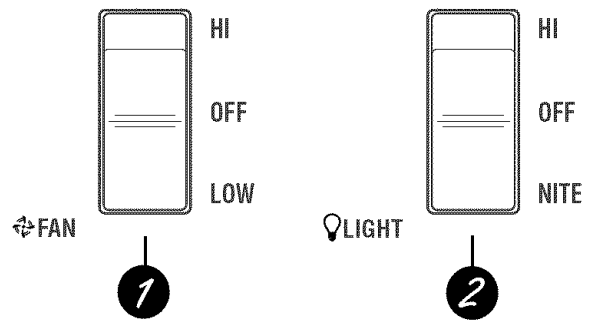

1 FAN Control

Press the rocker switch at the top to turn the fan on **HI** and at the bottom to turn it on **LOW**. The center position is **OFF**. Continuous use of the fan system while cooking helps keep the kitchen comfortable and less humid. It also reduces cooking odors and soiling moisture that create a frequent need for cleaning.

2 LIGHT Control

Press the rocker switch at the top to turn the light **ON** while cooking. Press the rocker switch at the bottom for use as a night light. The center position is **OFF**.

Care and cleaning of the vent hood.

Be sure electrical power is off and all surfaces are cool before cleaning or servicing any part of the vent hood.

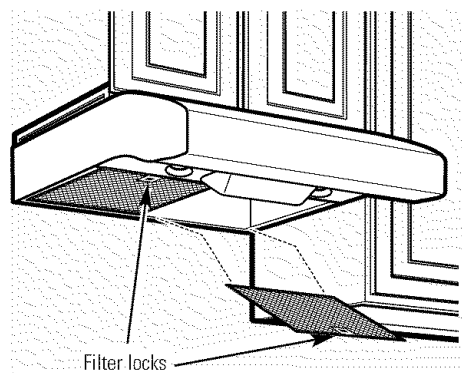

Reusable Metal Grease Filters

The hood has 2 metal reusable grease filters.

The metal filters trap grease released by foods on the cooktop. They also help prevent flaming foods on the cooktop from damaging the inside of the hood.

For this reason, the filters must **ALWAYS** be in place when the hood is used. The grease filters should be cleaned once a month, or as needed.

To remove, press the filter locks back and pull the filters down and out.

To replace, insert the rear filter tabs in the frame slots at the back of the opening. Push the filters up and lock them into place.

To clean the grease filters, soak them and then swish them around in hot water and detergent. Don't use ammonia or ammonia products because they will darken the metal. Do not use abrasives or oven cleaners. Light brushing can be used to remove embedded dirt. Rinse, shake and let them dry before replacing. **They may also be cleaned in an automatic dishwasher.**

NOTE: Before cleaning, make sure the charcoal filters, if present, are unclipped and removed. See the Charcoal Filters section.

If it ever becomes necessary to replace the metal grease filters, they may be ordered from your GE supplier.

Care and cleaning of the vent hood.

www.GEAppliances.com

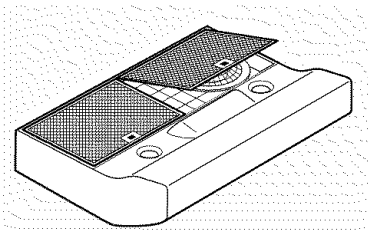

The charcoal filters are clipped inside of each reusable metal grease filter.

Charcoal Filters (on some models)

The charcoal filters cannot be cleaned. They must be replaced.

For 30" hood models, order Kit no. WB02X11000.

For 36" hood models, order Kit no. WB02X11001.

These kits can be ordered from your GE supplier.

NOTE: Charcoal filters are **not** included with the hood. They must be ordered from your GE supplier.

If the model is not vented to the outside, the air will be recirculated through disposable charcoal filters that help remove smoke and odors.

The charcoal filters should be replaced when they are noticeably dirty or discolored (usually after 6–12 months, depending on hood usage).

NOTE: DO NOT rinse, or put charcoal filters in an automatic dishwasher.

Painted Surfaces (on some models)

To clean the hood surface, use a hot, damp cloth with a mild detergent suitable for painted surfaces. Use a clean, hot, damp cloth to remove soap. Dry with a dry, clean cloth.

Do not use steel-wool pads or other abrasive cleaners. They will scratch the surface. Wipe with a clean, hot, damp cloth after using cleansers.

To order:

To order CERAMA BRYTE® Stainless Steel Cleaning Polish and Conditioner, please call our toll-free number.

National Parts Center . . . 800.626.2002

www.GEAppliances.com

**CERAMA BRYTE®
Stainless Steel Cleaning Polish
and Conditioner # PM10X313**

Stainless Steel Surfaces (on some models)

Do not use a steel-wool pad; it will scratch the surface.

- 1 Shake bottle well.
- 2 Place a small amount of CERAMA BRYTE® Stainless Steel Cleaning Polish and Conditioner on a dry cloth or dry paper towel.

- 3 Clean a small area (approximately 8" x 8"), rubbing with the grain of the stainless steel if applicable.
- 4 Dry and buff with a clean, dry paper towel or soft cloth.
- 5 Repeat as necessary.

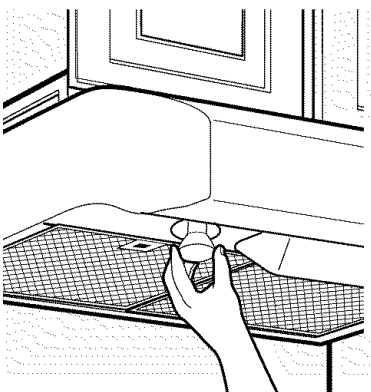

Hood Lights

This hood requires two bulbs (**not included**), maximum 50 watts.

Purchase and install PAR20, 50 W Maximum **halogen** bulbs.

When replacing a bulb, let it cool first. Make sure that power to the light has been turned off. Never allow a hot bulb to come into contact with water.

WARNING: To reduce the risk of electric shock, do not connect electrical power to the hood without both bulbs in place.

To change the light bulbs:

- 1 Grasp the bulb on the edges and unscrew it.
- 2 Replace with the same size bulb.

CAUTION:

- Do not touch the hood light bulbs when they are on. They may be hot enough to cause injury.
- The light bulbs operate at extremely high temperatures. If they shatter, the hot glass could cause personal injury.

Installation Instructions

Range Hood

Questions? Call **800.GE.CARES (800.432.2737)** or Visit our Website at: **www.GEAppliances.com**

BEFORE YOU BEGIN

Read these instructions completely and carefully.

- **IMPORTANT** — Save these instructions for local inspector's use.
- **IMPORTANT** — Observe all governing codes and ordinances.
- **Note to Installer** — Be sure to leave these instructions with the Consumer.
- **Note to Consumer** — Keep these instructions for future reference.
- **Skill level** — Installation of this appliance requires basic mechanical and electrical skills.
- **Completion time** — 1–3 hours
- Proper installation is the responsibility of the installer.
- Product failure due to improper installation is not covered under the Warranty.
- Use only with approved cord kit, JXHCL.

FOR YOUR SAFETY:

WARNING — Before beginning the installation, switch power off at service panel and lock the service disconnecting means to prevent power from being switched on accidentally. When the service disconnecting means cannot be locked, securely fasten a prominent warning device, such as a tag, to the service panel.

DUCTWORK REQUIREMENTS

NOTE: Read the ductwork sections only if you do not have existing ductwork. If you have existing ductwork, skip to the “Damage” section and proceed.

The venting system must exhaust to the outside.

This hood can be vented vertically through upper cabinets or horizontally through an outside wall. Ductwork is not included.

Exhaust connection:

The hood exhaust has been designed to mate with standard 3¼" x 10" rectangular ducting or 7" diameter round ducting.

If a 6" round duct is required, a rectangular-to-round transition adaptor must be used*. **Do not use less than a 6" diameter duct.**

Maximum duct length:

For satisfactory air movement, the total duct length of a 3¼" x 10" rectangular, 6" or 7" diameter round duct **should not exceed 65 equivalent feet.**

NOTE: It's important that ducting be installed using the most direct route and with as few elbows as possible. This ensures clear venting of exhaust and helps prevent blockages. **Also, make sure dampers swing freely and nothing is blocking the ducts.**

Elbows, transitions, wall and roofcaps, etc.,

present additional resistance to airflow and are equivalent to a section of straight duct longer than their actual physical size. When calculating the total duct length, add the equivalent lengths of all transitions and adaptors plus the length of all straight duct sections. The charts on the following pages show you how to calculate total equivalent ductwork length using the approximate feet of equivalent length of some typical ducts.



* **IMPORTANT:** If a rectangular-to-round transition adaptor is used, the bottom corners of the damper will have to be cut to fit, using the tin snips, in order to allow free movement of the damper. Equivalent lengths of duct pieces are based on actual tests and reflect requirements for good venting performance with any hood.

Installation Instructions

Follow the guidelines for proper duct sizing in the ducting charts.

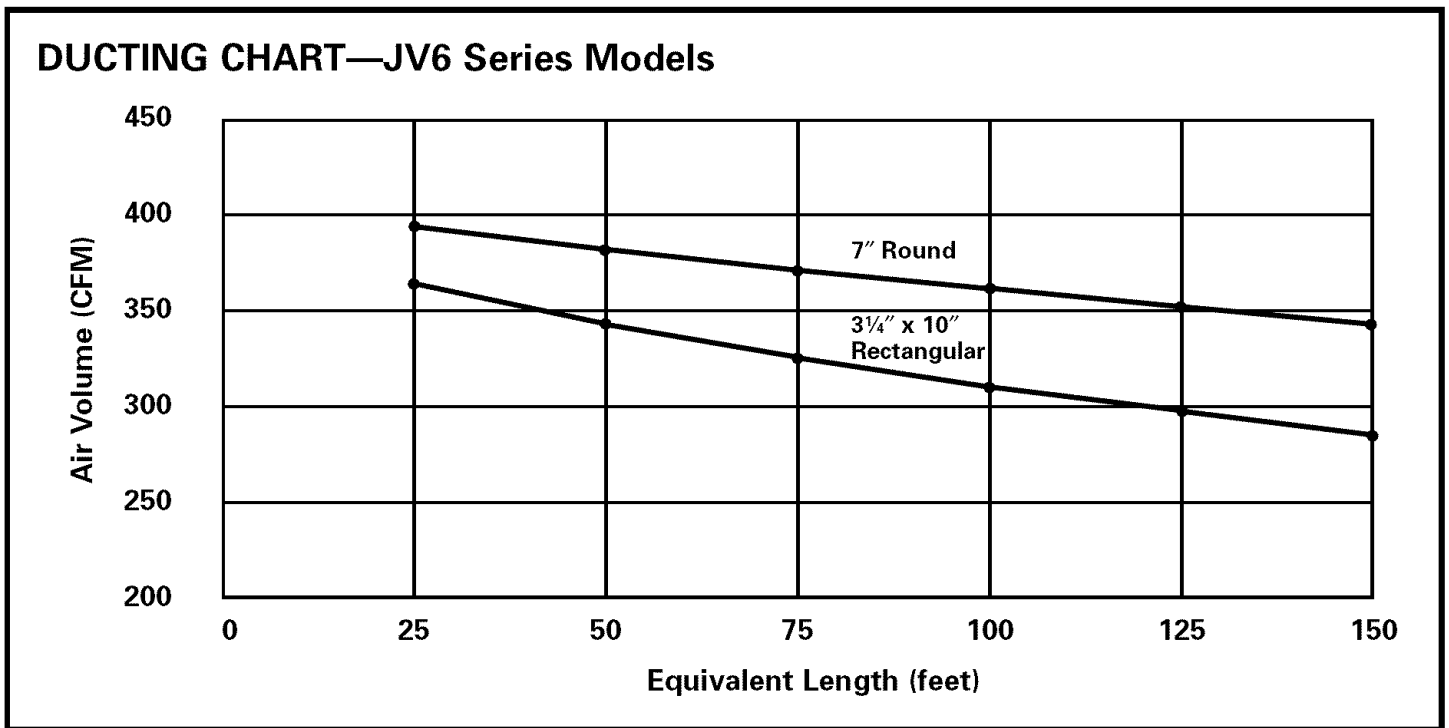
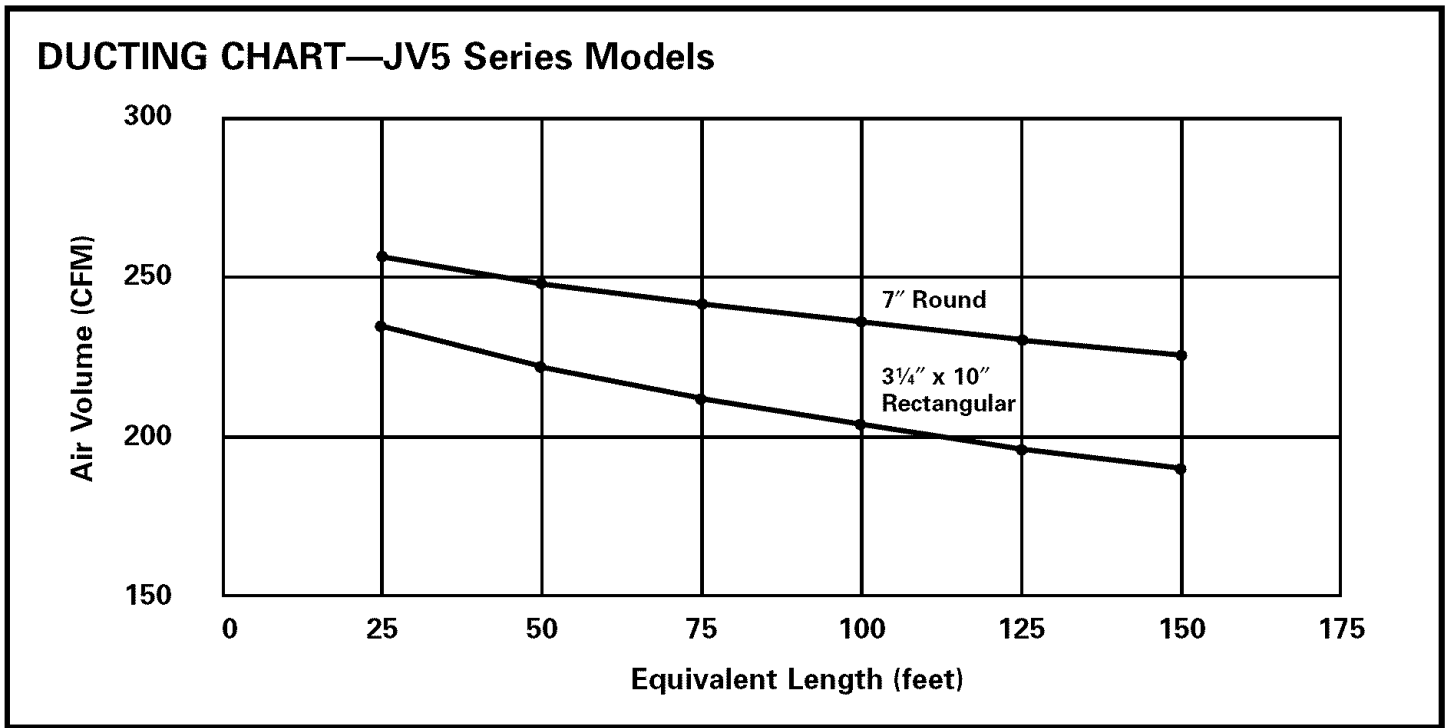

3 1/4" x 10" Rectangular Transition to 6" Round = 4.5 ft.











7" Round 90° Elbow = 8 ft.

7" Roof Cap = 30 ft.











MAXIMUM DUCT LENGTH: For satisfactory air movement, the total duct length of a 3 1/4" x 10" rectangular, 6" or 7" diameter round duct should not exceed 65 equivalent feet.

Installation Instructions

WORKSHEET—CALCULATE TOTAL EQUIVALENT DUCTWORK LENGTH

DUCT PIECES	EQUIVALENT NUMBER LENGTH x USED =	TOTAL
 3 1/4" x 10" Rect., straight	1 Ft. x () =	Ft.
 7" Round, straight	1 Ft. x () =	Ft.
 6" Round, straight	1 Ft. x () =	Ft.
 3 1/4" x 10" Rect. 90° elbow	8.5 Ft. x () =	Ft.
 3 1/4" x 10" Rect. 45° elbow	7 Ft. x () =	Ft.
 3 1/4" x 10" Rect. 90° flat elbow	24 Ft. x () =	Ft.
 3 1/4" x 10" Rect. wall cap with damper	45 Ft. x () =	Ft.
	(7 ft. w/o damper) x () =	Ft.
 3 1/4" x 10" Rect. to 6" round transition	4.5 Ft. x () =	Ft.
 3 1/4" x 10" Rect. to 6" round transition 90° elbow	11.5 Ft. x () =	Ft.
 6" Round, 90° elbow	8 Ft. x () =	Ft.
 6" Round, 45° elbow	6.5 Ft. x () =	Ft.
Subtotal column 1 =		Ft.

MAXIMUM DUCT LENGTH: For satisfactory air movement, the total duct length of a 3 1/4" x 10" rectangular, 6" or 7" diameter round duct **should not exceed 65 equivalent feet.**

DUCT PIECES	EQUIVALENT NUMBER LENGTH x USED =	TOTAL
 6" Round wall cap with damper	34 Ft. x () =	Ft.
	(6 ft. w/o damper) x () =	Ft.
 6" Round roof cap	30 Ft. x () =	Ft.
 6" Round to 3 1/4" x 10" rect. transition	5.5 Ft. x () =	Ft.
 6" Round to 3 1/4" x 10" rect. transition 90° elbow	14.5 Ft. x () =	Ft.
 7" Round, 90° elbow	8 Ft. x () =	Ft.
 7" Round, 45° elbow	6.5 Ft. x () =	Ft.
 7" Round wall cap with damper	34 Ft. x () =	Ft.
	(6 ft. w/o damper) x () =	Ft.
 7" Round roof cap	30 Ft. x () =	Ft.
 7" Round to 3 1/4" x 10" rect. transition	5.5 Ft. x () =	Ft.
 7" Round to 3 1/4" x 10" rect. transition, 90° elbow	14.5 Ft. x () =	Ft.
Subtotal column 2 =		Ft.
Subtotal column 1 =		Ft.
Total ductwork =		Ft.

Installation Instructions

DAMAGE—SHIPMENT/INSTALLATION

- If the unit is damaged in shipment, return the unit to the store in which it was bought for repair or replacement.
- If the unit is damaged by the customer, repair or replacement is the responsibility of the customer.
- If the unit is damaged by the installer (if other than the customer), repair or replacement must be made by arrangement between customer and installer.

MOUNTING SPACE

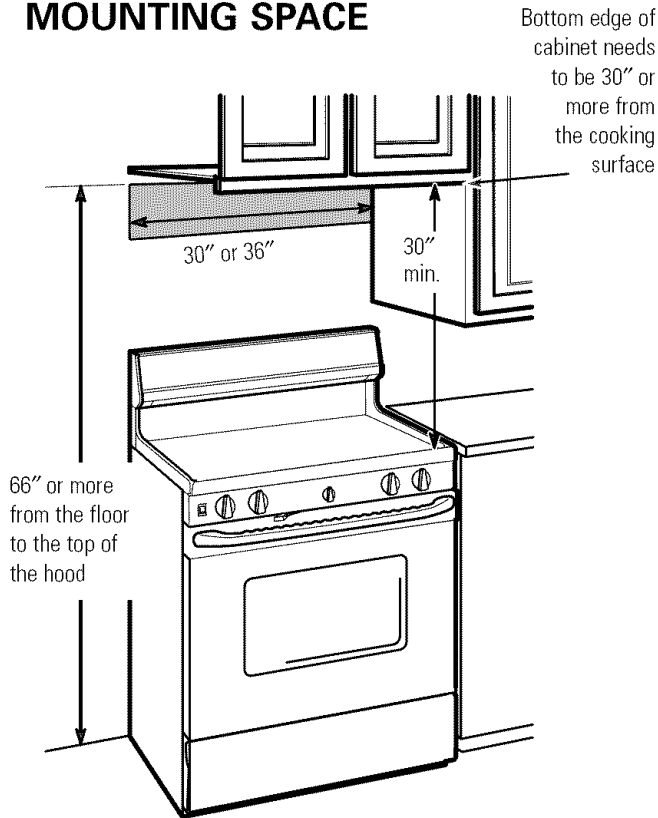

NOTES:

- This range hood is for installation over ranges up to 36" wide.
- If you are going to vent your range hood to the outside, see the "Ducting Requirements" section for exhaust duct preparation.

TOOLS YOU WILL NEED

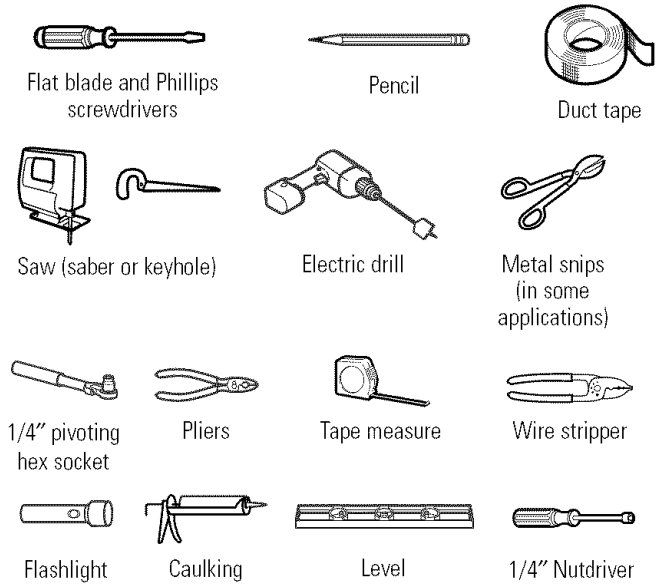

PARTS INCLUDED

PART	QUANTITY
Metal Grease Filters	2
Mounting Screws	4
Exhaust Adaptor/Damper (for 3/4" x 10" rect. venting)	1
Exhaust Adaptor Screws	1
Exhaust Adaptor (for 7" round venting)	1

PARTS YOU MAY NEED

Damper for 7" Round Exhaust Adaptor (Obtain Locally)
--

OPTIONAL ACCESSORIES

These kits can be ordered from your GE supplier.

	Cord Kit—For both 30" and 36" models, order Kit no. JXHC1.
	Charcoal Filters—JV5 Series only, if recirculating For 30" hood models, order Kit no. WB02X11000. For 36" hood models, order Kit no. WB02X11001.

Installation Instructions

1 CHOOSE VENT OPTION

Determine the vent option that your installation will require from the following choices:

The outside vent exhaust option that your installation requires will determine the hood knockouts that you will use.

NOTE: Only JV5 Series models may be recirculated. The JV6 Series models cannot be recirculated.

IMPORTANT: If the hood is to be installed in a recirculating, non-vented ductless manner, do not knock out any vent openings in the hood. Only an electrical access hole will be knocked out of the hood.

A Outside top exhaust (Vertical duct— $3\frac{1}{4}$ " x 10" Rectangular)

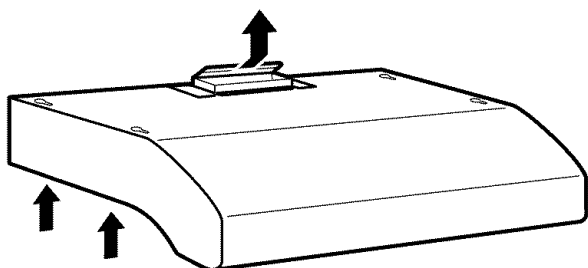

C Outside rear exhaust (Horizontal duct— $3\frac{1}{4}$ " x 10" Rectangular)

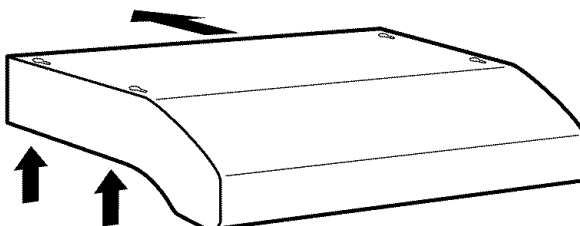

B Outside top exhaust (Vertical duct—7" Round)

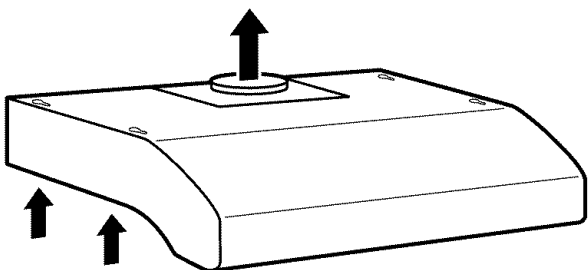

D Recirculating (Non-vented ductless—Optional for JV5 Series models only)

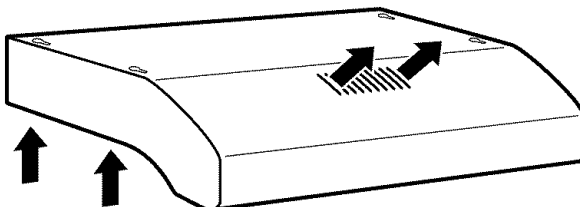

Installation Instructions

2 REMOVE EXHAUST ADAPTOR

Remove the 7" round exhaust adaptor from the top of the hood. Set it aside along with its mounting screws.
NOTE: Save the screws for 3-1/4" x 10" rectangular ducted installation, if that is your chosen venting option.

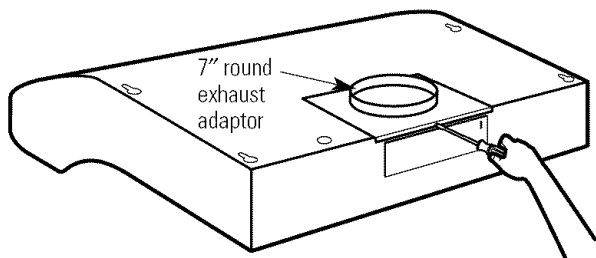

4 REMOVE WIRING COVER FROM THE JUNCTION BOX

Remove the **wiring cover** from inside the hood. Set the cover and its mounting screw aside.

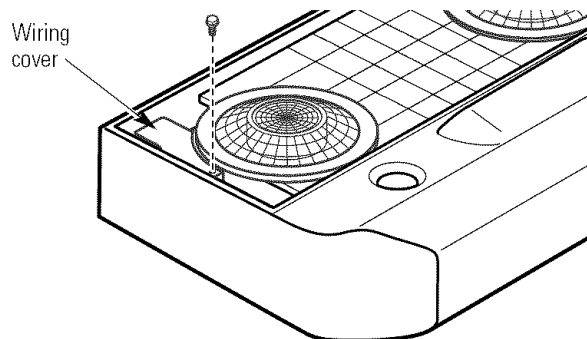

3 REMOVE FILTERS

Remove the protective shipping film from the edges of the **metal grease filters**. Press the filter locks back and lift the filters out. Set them aside.

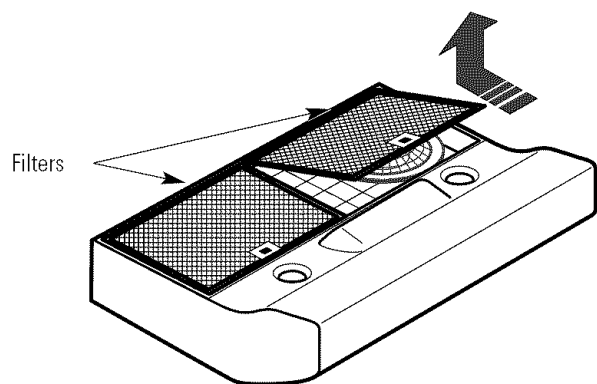

5 REMOVE WIRING KNOCKOUT

Remove either the top or the back wiring knockout as needed and install an approved **strain relief clamp**.

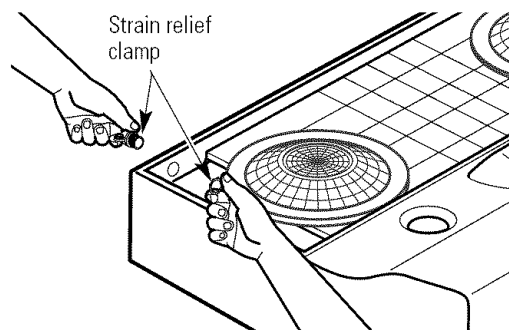

Installation Instructions

6 REMOVE DUCT KNOCKOUT(S)

If **recirculating**, non-vented ductless (optional for JV5 Series models only), see note below and **skip to Step 9 D and proceed**. The JV6 Series models cannot be recirculated.

Using a flat blade screwdriver, remove the appropriate **duct knockout(s)** from the top or back of the hood.

3/4" x 10" Rectangular vertical discharge.

Remove top rectangular duct knockout only.

7" Round vertical discharge.

Remove semi-circular duct knockout and top rectangular duct knockout.

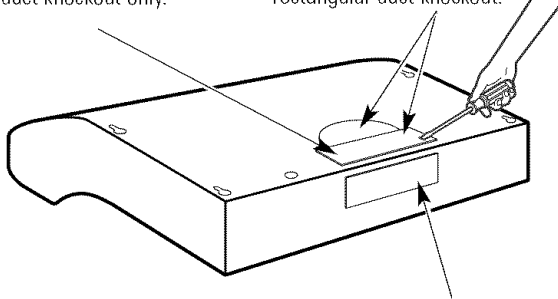

3/4" x 10" Rectangular horizontal discharge. Remove rear rectangular duct knockout only.

NOTE: If the hood is to be installed in a **recirculating**, non-vented ductless manner, order charcoal filters, kit number WB02X11000 for 30" hood models, or kit number WB02X11001 for 36" hood models. These kits can be ordered from your GE supplier. **Skip to Step 9 D and proceed.**

7 FOR 3/4" x 10" RECTANGULAR DUCTED DISCHARGE INSTALLATIONS ONLY:

Attach **exhaust adaptor/damper** over knockout opening with two exhaust adaptor screws. Make sure damper **pivot** is nearest to **top/back edge** of hood. Remove **tape** from damper flap.

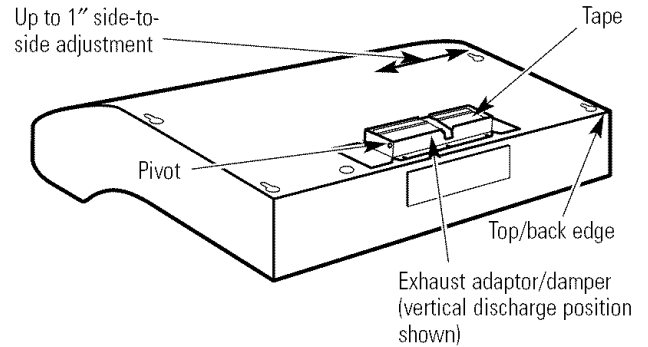

NOTE: The exhaust adaptor/damper can be installed up to 1 inch on either side of the hood center to accommodate off-center ductwork. In extreme off-center installations, one end of the duct connector may need to be trimmed to clear the electrical cable clamp.

8 FOR 7" ROUND VERTICAL DUCTED DISCHARGE INSTALLATIONS ONLY:

Re-install the **7" round exhaust adaptor** with its screws, removed in Step 2 under the "Prepare the Hood" section.

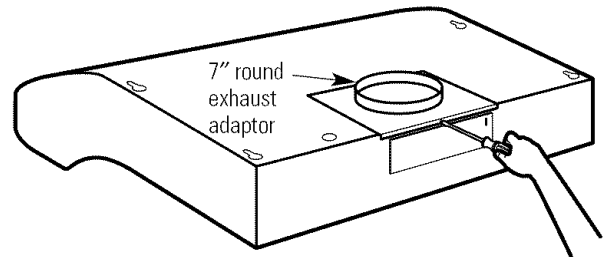

NOTE: The 7" round exhaust adaptor can be installed up to 1 inch on either side of the hood center to accommodate off-center ductwork. In extreme off-center installations, one end of the duct connector may need to be trimmed to clear the electrical cable clamp.

NOTE: The 7" round damper is not included with this product. It can be purchased as a kit by calling 800.626.2002. Order kit number JXDA22.

Installation Instructions

9 MARK HOLES

Select the vent option that your installation will require and proceed to that section:

A. Outside top exhaust (Vertical duct—3¼" x 10" Rectangular)

- Use the diagram or the hood as a template and mark the locations on the cabinet for ductwork, electrical wiring and keyhole screw slots.

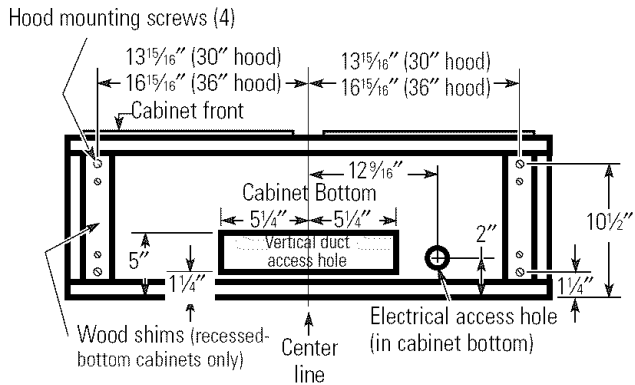

B. Outside top exhaust (Vertical duct—7" Round)

- Use the diagram or the hood as a template and mark the locations on the cabinet for ductwork, electrical wiring and keyhole screw slots.

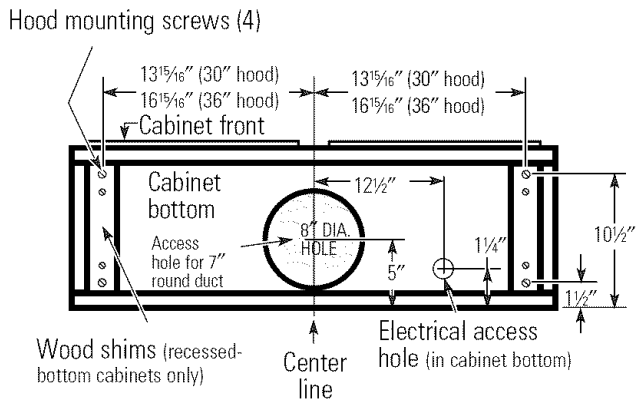

C. Outside rear exhaust (Horizontal duct—3¼" x 10" Rectangular)

- Use the diagram or the hood as a template and mark the locations on the cabinet for ductwork, electrical wiring and keyhole screw slots.

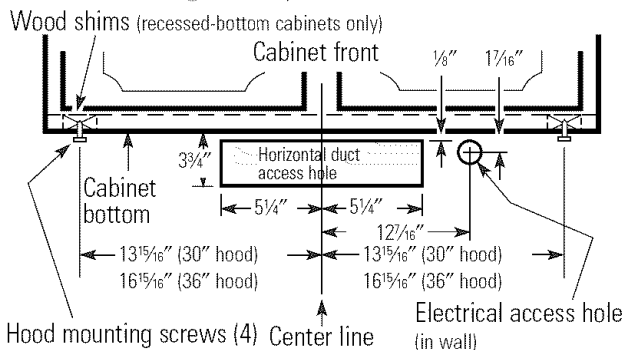

D. Recirculating (non-vented ductless— Available on JV5 Series models only)

- Use the hood as a template and mark the locations on the cabinet for the electrical wiring and keyhole screw slots.
- Since the hood is to be recirculated (not to be vented outside), do not cut out any vent openings in the wall or cabinet bottom.

10 CHOOSE VENTING OPTION (for JV5 Series models only)

The hood can be set to vent outside or to recirculate air back into the kitchen.

The plastic vent lever is located near the center of the hood opening.

- To vent to the outside**, make sure the plastic vent lever is in the **HORIZONTAL** position (flat against the metal top of the hood).
- To recirculate air into the kitchen**, make sure the plastic vent lever is in the **VERTICAL** position (flat against the plastic blower housing).

NOTE: In order to change the vent lever position, you will need to pull the lever out slightly to clear the plastic tabs.

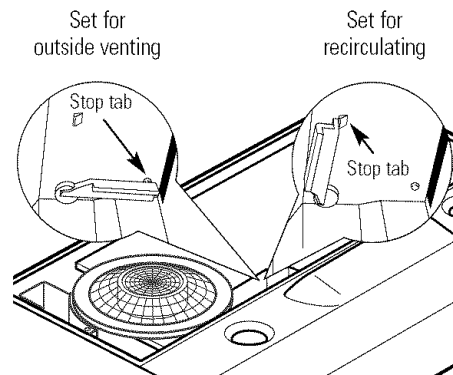

Hood shown lying upside down

Installation Instructions

11 FOR RECESSED-BOTTOM CABINETS ONLY

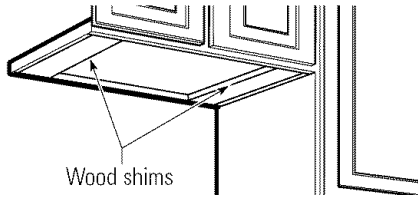

- If the cabinets have front, side or back trim, make 2 wood shims the width of the trim and attach them to the cabinet bottom recess on both sides. See Step 9 for marking locations.

12 CUT HOLES

Cut holes at marked locations for duct and electrical wiring. For the vertical duct, cut out 3/4" extra toward the front of the cabinet so you can move the duct freely when installing the hood. It may also ease installation by cutting the hole 10½" instead of 10".

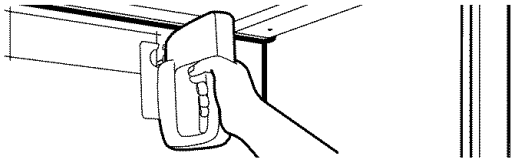

13 RUN WIRES

Run the electrical wires through the wall or cabinet according to National Electrical Code and applicable local codes.

NOTE: DO NOT turn the power on until installation is complete.

14 SCREW IN PARTWAY

Drive a mounting screw (from the hardware packet) partway into each center of the narrow neck of the keyhole slots marked on the cabinet bottom.

15 FEED IN WIRES

Lift the hood into position and feed the house wiring through the wiring knockout.

16 SECURE HOOD

Slide the hood back against the wall. Tighten the mounting screws. Be sure the screw heads are in the narrow neck of the keyhole slot.

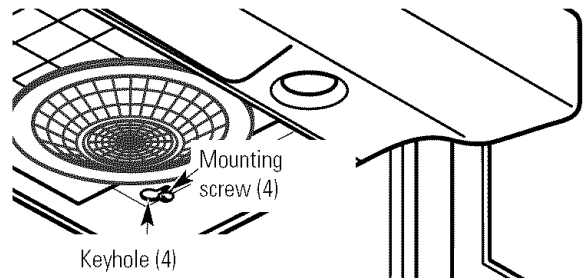

Installation Instructions

17 CONNECT DUCTWORK TO HOOD

Use **duct tape** to make joints secure and air tight.

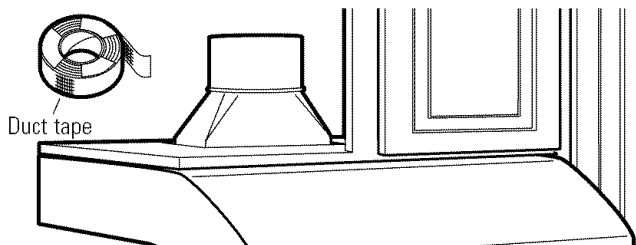

20 CONNECT WIRING

Connect house black to hood black wire, house white to hood white wire, and house ground to hood green/yellow wire. Securely tighten the strain relief clamp onto the house wiring.

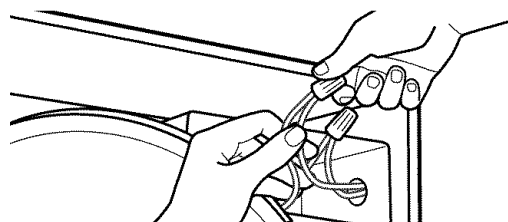

18 INSTALL LIGHT BULBS

Purchase and install two PAR20, 50 W maximum **halogen bulbs**. Light bulbs are not included with the hood.

WARNING: To reduce the risk of electric shock, do not connect electrical power to the hood without both bulbs in place.

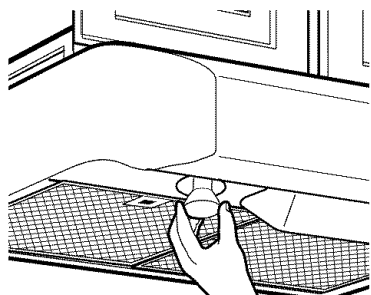

21 REPLACE WIRING COVER

Replace the wiring cover.

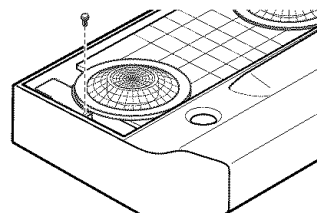

22 REPLACE FILTERS

The installation is complete. Turn on power at service panel, and test for proper operation.

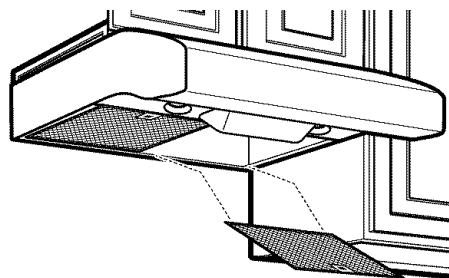

19 FOLLOW ELECTRICAL CODE

Complete the electrical wiring according to National Electrical Code and local codes.

NOTE: This hood must be permanently grounded. Connect **house wiring** (120 VAC) to hood wiring.

TROUBLESHOOTING CHECKLIST

If the hood seems to be operating at high speed when the control is not set on high, or if ventilation seems inadequate, check the following:

- Knockouts not removed from hood.
- Damper blade not opening.
- Reduced airflow because the duct is too small or the duct length is too long.
- The duct is blocked.
- Undersized or restrictive wall or roof cap.

Before you call for service...



Troubleshooting Tips

Save time and money! Review the following chart first and you may not need to call for service.

Problem	Possible Causes	What To Do
Fan does not operate when the switch is on	A fuse may be blown or a circuit breaker may be tripped.	<ul style="list-style-type: none"> • Replace fuse or reset circuit breaker.
Fan fails to circulate air or moves air more slowly than normal	Excessively soiled filter.	<ul style="list-style-type: none"> • Wash and replace the filters. See the <i>Reusable Metal Grease Filters</i> section. • Replace the filter if it is too soiled to clean. If it is not soiled, or if replacing the filter does not solve the problem, call for service.
Fan continually cycles off and on	The motor is probably overheating and turning itself off. This can be harmful to the motor. Filter may be excessively soiled.	<ul style="list-style-type: none"> • Replace the filter if it is soiled. If it is not soiled, or if replacing the filter does not solve the problem, call for service.
Air coming from the front vent (on some models) when it is ducted to the outside	Vent lever is in the VERTICAL position (flat against the plastic blower housing) for recirculating.	<ul style="list-style-type: none"> • Move the lever back to the HORIZONTAL position (flat against the metal top of the hood) to vent to the outside. See Step 10 in the Installation Instructions for vent lever operation. This is normal if the hood has been installed to recirculate.

Notes.

Safety Instructions

Operating Instructions

Installation Instructions

Troubleshooting Tips

Consumer Support

Consumer Support	Troubleshooting Tips	Installation Instructions	Operating Instructions	Safety Instructions
-------------------------	-----------------------------	----------------------------------	-------------------------------	----------------------------

Notes.

GE Range Hood Warranty.

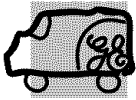

All warranty service provided by our Factory Service Centers, or an authorized Customer Care® technician. To schedule service, on-line, 24 hours a day, visit us at GEAppliances.com, or call 800.GE.CARES (800.432.2737).

Staple your receipt here.
Proof of the original purchase date is needed to obtain service under the warranty.

For The Period Of: **GE Will Replace:**

One Year

From the date of the original purchase

Any part of the range hood which fails due to a defect in materials or workmanship. During this **full one-year warranty**, GE will also provide, **free of charge**, all labor and in-home service to replace the defective part.

What GE Will Not Cover:

- Service trips to your home to teach you how to use the product.
- Replacement of house fuses or resetting of circuit breakers.
- Improper installation, delivery or maintenance.
- Damage to the product caused by accident, fire, floods or acts of God.
- Failure of the product if it is abused, misused, or used for other than the intended purpose or used commercially.
- Incidental or consequential damage caused by possible defects with this appliance.
- Damage caused after delivery.

This warranty is extended to the original purchaser and any succeeding owner for products purchased for home use within the USA. In Alaska, the warranty excludes the cost of shipping or service calls to your home.

Some states do not allow the exclusion or limitation of incidental or consequential damages. This warranty gives you specific legal rights, and you may also have other rights which vary from state to state. To know what your legal rights are, consult your local or state consumer affairs office or your state's Attorney General.

Warrantor: General Electric Company, Louisville, KY 40225

Safety Instructions

Operating Instructions

Installation Instructions

Troubleshooting Tips

Consumer Support

Consumer Support



GE Appliances Website

www.GEAppliances.com

Have a question or need assistance with your appliance? Try the GE Appliances Website 24 hours a day, any day of the year! For greater convenience and faster service, you can now download Owner's Manuals, order parts, catalogs, or even schedule service on-line. You can also "Ask Our Team of Experts"[™] your questions, and so much more...

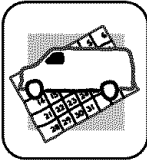

Schedule Service

www.GEAppliances.com

Expert GE repair service is only one step away from your door. Get on-line and schedule your service at your convenience 24 hours any day of the year! Or call 800.GE.CARES (800.432.2737) during normal business hours.

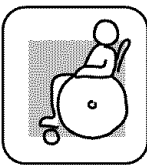

Real Life Design Studio

www.GEAppliances.com

GE supports the Universal Design concept—products, services and environments that can be used by people of all ages, sizes and capabilities. We recognize the need to design for a wide range of physical and mental abilities and impairments. For details of GE's Universal Design applications, including kitchen design ideas for people with disabilities, check out our Website today. For the hearing impaired, please call 800.TDD.GEAC (800.833.4322).



Extended Warranties

www.GEAppliances.com

Purchase a GE extended warranty and learn about special discounts that are available while your warranty is still in effect. You can purchase it on-line anytime, or call 800.626.2224 during normal business hours. GE Consumer Home Services will still be there after your warranty expires.

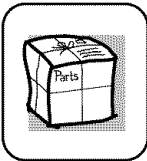

Parts and Accessories

www.GEAppliances.com

Individuals qualified to service their own appliances can have parts or accessories sent directly to their homes (VISA, MasterCard and Discover cards are accepted). Order on-line today, 24 hours every day or by phone at 800.626.2002 during normal business hours.

Instructions contained in this manual cover procedures to be performed by any user. Other servicing generally should be referred to qualified service personnel. Caution must be exercised, since improper servicing may cause unsafe operation.



Contact Us

www.GEAppliances.com

If you are not satisfied with the service you receive from GE, contact us on our Website with all the details including your phone number, or write to: General Manager, Customer Relations
GE Appliances, Appliance Park
Louisville, KY 40225



Register Your Appliance

www.GEAppliances.com

Register your new appliance on-line—at your convenience! Timely product registration will allow for enhanced communication and prompt service under the terms of your warranty, should the need arise. You may also mail in the pre-printed registration card included in the packing material.