

# GIGABYTE

T E C H N O L O G Y



## AirCruiser N150 Router

GN-BR31NE-RH

## User's Guide

June 2008 - Revision 1.0



# Contents

<b>Chapter 1 Getting To Know Your GN-BR31NE-RH .....</b>	<b>1</b>
Overview .....	1
Package Contents .....	1
Side Panel .....	2
LEDs .....	4
Key Features.....	5
<b>Chapter 2 Wireless Networking .....</b>	<b>6</b>
Wireless Network Layout .....	6
<b>Chapter 3 Before You Start.....</b>	<b>7</b>
What You Will Need .....	7
Internet.....	7
Hardware Requirements.....	7
System Requirements .....	7
ISP Configuration Information.....	7
<b>Chapter 4 Connecting the GN-BR31NE-RH .....</b>	<b>8</b>
Overview .....	8
Using a Wired Connection.....	8
Using a Wireless Connection .....	9
<b>Chapter 5 Connecting the Router to the Internet .....</b>	<b>10</b>
Overview .....	10

<b>Logging into the GN-BR31NE-RH .....</b>	<b>10</b>
<b>Chapter 6 Advanced Setup .....</b>	<b>13</b>
<b>Overview .....</b>	<b>13</b>
<b>The Status Page.....</b>	<b>13</b>
<b>The Network Configuration Screen .....</b>	<b>19</b>
<b>The Wireless Configuration Screen.....</b>	<b>27</b>
<b>The Static Routing Table Screen .....</b>	<b>33</b>
<b>The Virtual Server Screen.....</b>	<b>34</b>
<b>The Firewall Rule Screen.....</b>	<b>37</b>
<b>The DNS Configuration Screen.....</b>	<b>41</b>
<b>The URL Blocking Configuration Screen .....</b>	<b>42</b>
<b>Chapter 7 Using Management Tools ..</b>	<b>43</b>
<b>Overview .....</b>	<b>43</b>
<b>The PPP Monitor Screen.....</b>	<b>43</b>
<b>Manage Port Configuration Screen .....</b>	<b>43</b>
<b>The Reboot Screen.....</b>	<b>44</b>
<b>The Initialization Screen .....</b>	<b>45</b>
<b>The Change Password Screen .....</b>	<b>45</b>
<b>The Change WAN MAC Screen .....</b>	<b>46</b>
<b>The Upgrade Firmware Screen.....</b>	<b>47</b>
<b>The Backup / Restore Screen.....</b>	<b>48</b>
<b>The Log Information Screen.....</b>	<b>49</b>
<b>The Save Maintenance Screen .....</b>	<b>51</b>
<b>The Ping Screen .....</b>	<b>52</b>
<b>The Help Screen .....</b>	<b>53</b>

The About Screen.....	53
<b>Chapter 8 Using Multiple BSSID Function under AP Mode.....</b>	<b>54</b>
Overview .....	54
How to Configure Multiple BSSID .....	54
Entering the Advanced Setup .....	56
The VLAN Configuration Screen.....	57
The Wireless Configuration Screen.....	58
<b>Appendix A FAQ.....</b>	<b>60</b>
<b>Appendix B Using Setup Wizard .....</b>	<b>62</b>
<b>Appendix C Configuring TCP/IP Settings .....</b>	<b>71</b>
<b>Appendix D Troubleshooting.....</b>	<b>74</b>
<b>Appendix E Glossary .....</b>	<b>78</b>
<b>Appendix F Specifications .....</b>	<b>81</b>
<b>Appendix G Warranty .....</b>	<b>82</b>
<b>Appendix H Regulatory Information.....</b>	<b>83</b>
<b>Appendix I General Public License .....</b>	<b>85</b>
Licensing Information .....	85
Availability of Source Code .....	85



# Chapter 1

## Getting To Know Your BR31NE-RH

### Overview

---

Thank you for purchasing the GN-BR31NE-RH 2.4GHz Wireless Router. Providing transmission speeds of up to 300Mbps, the GN-BR31NE-RH allows users to share network resources, retrieve emails, download large files, conduct a video conference, and distribute or display digital photos, videos or MP3 files. The GN-BR31NE-RH is the ideal networking device for you to share a broadband connection in your home or office. The GN-BR31NE-RH gives you a simple, cost-effective wireless networking solution.

The GN-BR31NE-RH offers the newest, strongest, most advanced security features available today. Unlike most other wireless routers, the GN-BR31NE-RH offers advanced features such as a user editable routing table, Dynamic DNS mapping (allowing you to host a website on your dynamic DSL account), and more. Advanced security features such as WPA (Wi-Fi Protected Access) and 802.1x safeguard your privacy on-line, while URL blocking keeps kids safe from explicit websites.

Like all 802.11n/b/g wireless products, the GN-BR31NE-RH is fully backwards compatible with 802.11bg products. This means that you don't need to change your entire network to maintain connectivity.

### Package Contents

---

- GN-BR31NE-RH 2.4GHz Wireless Broadband Router
- Power adapter (5V DC, 2A)
- User Guide on CD-ROM
- Quick Start Guide
- SmartSetup 3 Guide
- Ethernet cable – All of the GN-BR31NE-RH Ethernet ports are Auto-MDIX

If there are any missing or damaged parts, please contact your local distributor or dealer immediately.



*Using a power supply with a different voltage rating than the one included with the GN-BR31NE-RH may cause damage and void the warranty for this product.*

## Side Panel

---

The side panel of the GN-BR31NE-RH Wireless Broadband Router contains all the Router's ports as well as the DC power port and initialization button.

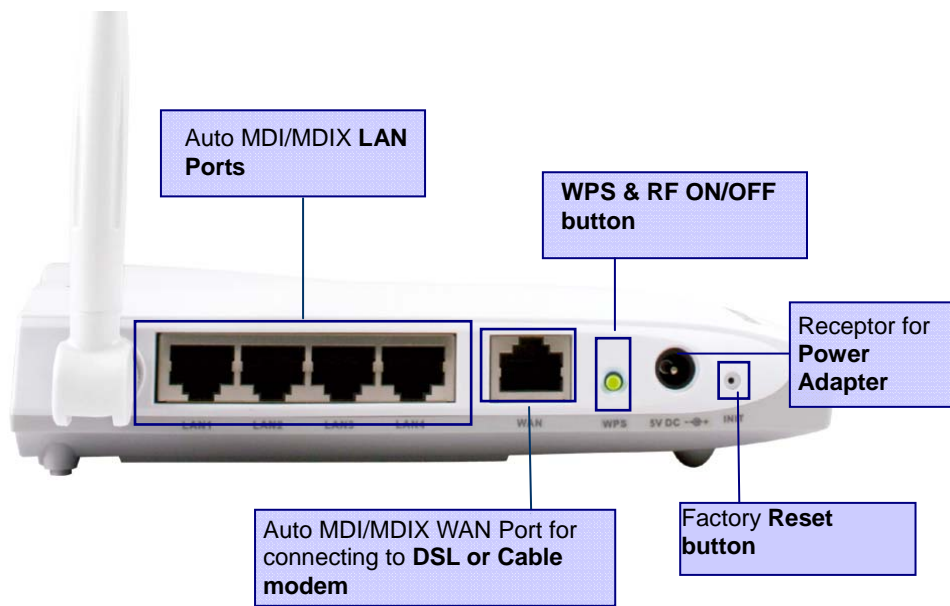

Figure 1: Router's Side Panel

- Reset Button** There are two ways to reset the Router's factory defaults. Either press the Reset Button, for approximately five seconds, or restore the defaults from the Management Tools>Router Initialization screen in Router's Web-based Utility.
- WAN** The WAN port is where you will connect your broadband Internet connection.
- LAN1, 2, 3, 4** These ports (1, 2, 3, 4) connect the Router to PCs on your wired network and other Ethernet network devices.
- Power** The Power port is where you will connect the power adapter.
- WPS** The WPS Button is Wi-Fi Protected Setup & RF ON/OFF function, if you want to enable WPS function, just press the



GN-BR31NE-RH 2.4GHz AirCruiser N150 Wireless Router

WPS button. Please note that when WPS function is enabled, the status will last only 2 minutes. If you hold the button **over 4 seconds**, the router will inactive RF ON/OFF function.

## LEDs

---

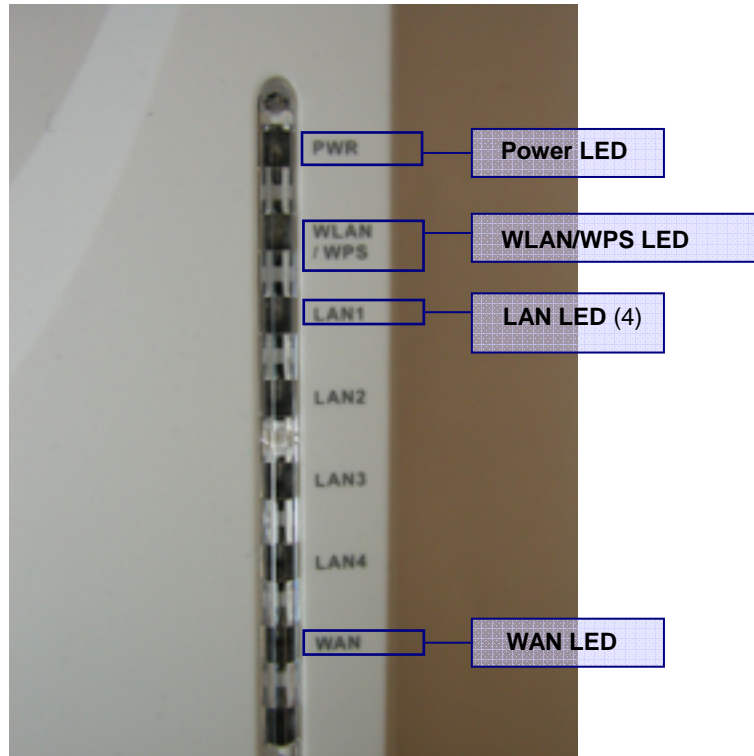

Figure 2: LED Layout

The table below describes the LED indicators on the front panel of the GN-BR31NE-RH. All LEDs are green when lit.

LED	STATUS	Color	DESCRIPTION
Power	On	Green	Power is supplied to the Router
	Off	N/A	Power is NOT supplied to the Router
WLAN /WPS	Flashing	Green	Data is being transmitted wirelessly
	On	Green	No traffic
	Off	N/A	WLAN status idle
	Flashing	Red	WPS function is active.
WAN	On	Green	WAN port has detected a wired link with a DSL or Cable modem.

GN-BR31NE-RH 2.4GHz AirCruiser N150 Wireless Router

	Flashing	Green	Data is being transmitted / received through WAN port.
LAN	On	Green	LAN port has detected a link with a 10/100Mbps device
	Flashing	Green	Data is being transmitted / received through LAN port.

## Key Features

---

- Support Smart Setup for auto configuration
- Conforms to IEEE 802.11n specification.
- Wireless transmits/receives data rate up to 150/300Mbps.
- Support 64-bit /128-bit WEP encryption, 802.1x, WPA™ and WPA™2.
- Support PPPoE and PPPoE Unnumbered DSL connection
- Support up to 4 WAN configuration records
- Support DHCP client for cable/DSL connection
- Support DHCP server for LAN connection
- Support UPnP IGD 1.0
- Support MSN messenger and most Internet applications
- Support Firewall Filtering
- Support Virtual Server
- Support DMZ
- Support Stateful Packet Inspection (SPI)
- Support DoS Protection
- Support Stealth Mode
- VPN Packets Pass Through (Support PPTP/IPSec/L2TP Protocol)
- Log Management (Support Firewall/UPnP/WAN Connection Log)
- Easy Web Management
- Support WAN side Remote Management
- DNS Relay and Dynamic DNS
- Web based Firmware upgrade
- Support URL Blocking
- MDI/MDIX Auto crossover detect
- Support Multiple BSSID (AP Mode)
- Support VLAN (AP Mode)
- Enhance WPS security feature

\*Theoretical throughput

## Chapter 2 Wireless Networking

A wireless local area network (or Wi-Fi for short) is exactly like a regular local area network (LAN), except that each computer in the wireless network uses a wireless device to connect to the network. Computers in a wireless network share the same frequency channel and SSID, which is an identification name shared by the wireless devices belonging to the same wireless network.

The Router transmits data to PCs equipped with wireless network adapters, which can roam within a certain radial range of the Router. You can arrange the Router and multiple access points to work in succession to extend the roaming range, and you can set up your wireless network to communicate with your Ethernet hardware as well. The big advantage of Wi-Fi is its simplicity. You can connect computers anywhere in your home or office without the need for wires. The computers connect to the network using radio signals, and computers can be up to 100 feet or so apart.

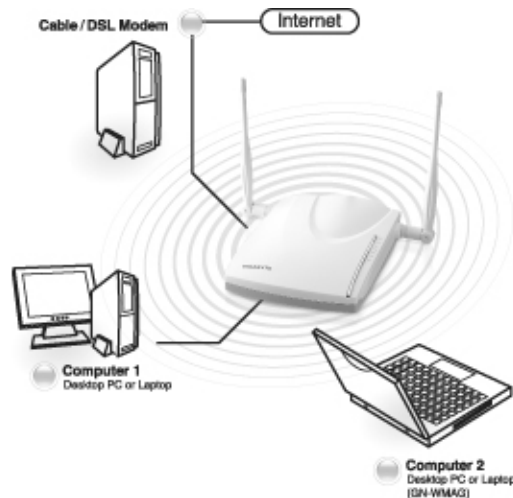

Figure 3: Typical Home Wireless Network

### Wireless Network Layout

The GN-BR31NE-RH High-speed wireless Router has been specifically designed for use with both your 802.11n and 802.11b/g products, and retains full backward compatibility. After you have finished setting up your GN-BR31NE-RH High-speed Wireless Router, your home network will be similar to the diagram shown at the right.

## Chapter 3 Before You Start

### What You Will Need

---

#### Internet

You will need to have an active Internet account, supplied through either ADSL or cable Modem, and your ISP user account and password information. (Your ISP can supply you with this)

#### Hardware Requirements

A minimum of one PC with an installed Ethernet NIC (network interface card). (If you have a DSL or Cable modem broadband connection to the Internet, you should already have this). If you wish to connect wirelessly to your GN-BR31NE-RH from a laptop, a wireless network PCMCIA notebook card is needed, and this manual assumes it is already properly installed.

#### System Requirements

The GN-BR31NE-RH will work with Windows, Macintosh or Linux Operating System. You just need a HTTP standard JavaScript-enabled browser, for example, Microsoft Internet Explorer or Netscape Navigator 4.0 or above.

#### ISP Configuration Information

Depending on the type of ISP connection you have, you may need one or more of the following configuration parameters.

- ✓ ISP User ID and Password
- ✓ ISP Domain Name Server (DNS)
- ✓ Fixed IP address or Static IP address
- ✓ Subnet Mask
- ✓ Default Gateway
- ✓ Host and Domain Names

If you are unsure of any of these settings, contact your ISP customer service.

## Chapter 4 Connecting the GN-BR31NE-RH

### Overview

---

You can connect to, and configure the GN-BR31NE-RH using either a wireless connection (via notebook PC) or using a wired connection to your desktop PC. It is HIGHLY recommended for the first time setup that configuration be done using a wired connection to your desktop PC as shown in the figure below.

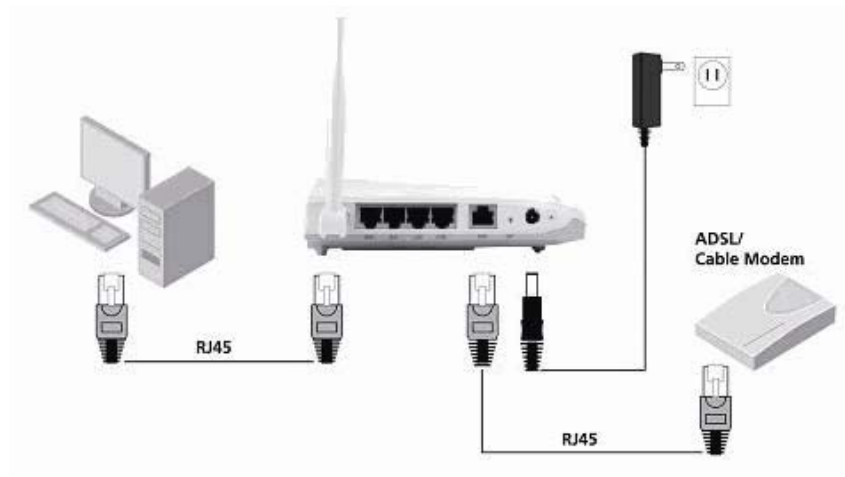

Figure 4: Wired Connection Diagram

### Using a Wired Connection

---

It is suggested for first time setup your Router that you used the wired connection method. It is simpler, and eliminates the possibility of error due to improperly setup wireless connection.

- Step 1 Turn off all the hardware devices in your network, including the ADSL/Cable modem by unplugging their power supply.
- Step 2 Connect the Ethernet cable of your ADSL/Cable modem to the WAN port of the GN-BR31NE-RH.
- Step 3 Connect one end of an Ethernet cable (provided) to a LAN port in the

## GN-BR31NE-RH 2.4GHz AirCruiser N150 Wireless Router

side panel of the GN-BR31NE-RH and the other end to the 10/100 Ethernet port of your computer. (It does not matter which LAN port you select).

- Step 4 Plug the power adapter cord into the router's power jack and then plug the power adapter into a power outlet.
- Step 5 Turn on your ADSL/Cable modem. After verifying all the connections, proceed to **Chapter 5 Connecting the Router to the Internet.**

### Using a Wireless Connection

---

- Step 1 Turn off all the hardware devices in your network, including the ADSL/Cable modem by unplugging their power supply.
- Step 2 Connect the Ethernet cable of your ADSL/Cable modem to the WAN port of the GN-BR31NE-RH.
- Step 3 Plug the power adapter cord into the router's power jack and then plug the power adapter into a power outlet.
- Step 4 Turn on your ADSL/Cable modem.
- Step 5 Insert you PCMCIA notebook card, or wireless USB adapter into your notebook PC.
- Step 6 If using a GIGABYTE PCMCIA notebook card, SmartSetup 3 will automatically detect your GN-BR31NE-RH and walk you through the setup procedure (for more details refer to your SmartSetup 3 Guide). Please refer to your vendor's users manual for connecting to the wireless network.
- Step 7 When scanning for available wireless networks, your GN-BR31NE-RH's factory default SSID name is **GIGABYTE**. Select it using the procedures described in your particular vendor's notebook adapter users manual.
- Step 8 After verifying all the connections, proceed to **Chapter 5 Connecting the Router to the Internet.**

## Chapter 5 Connecting the Router to the Internet

### Overview

---

The GN-BR31NE-RH High-speed wireless router is configured to work “out of the box”, and the default settings generally do not require any modification. However, for initial setup, you must log into the router and key in your Internet Service Provider (ISP) settings. This only needs to be done once. Your ISP customer service desk can provide you with the all the information you will need.

This chapter includes two sets of instructions. First, by using SmartSetup to configure ISP settings in your Router, and then by using Setup Wizard to for users who wish to take more control over the ISP settings

### Logging into the GN-BR31NE-RH

---



SmartSetup 3 is the quickest way to securing your wireless network with WPA-PSK, and then controlling your Wi-Fi network with its powerful and intuitive G-EZlink utility. **Please refer to your SmartSetup 3 Guide for more information.**

To login to your GN-BR31NE-RH follow the steps described below:

- A. In the address bar of your browser, type “**192.168.1.254**” and then press the **ENTER** key.

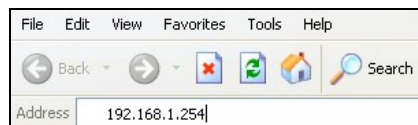

- B. When the password page appears; use **admin** as both the default User Name and default Password. Then click the **OK** button.



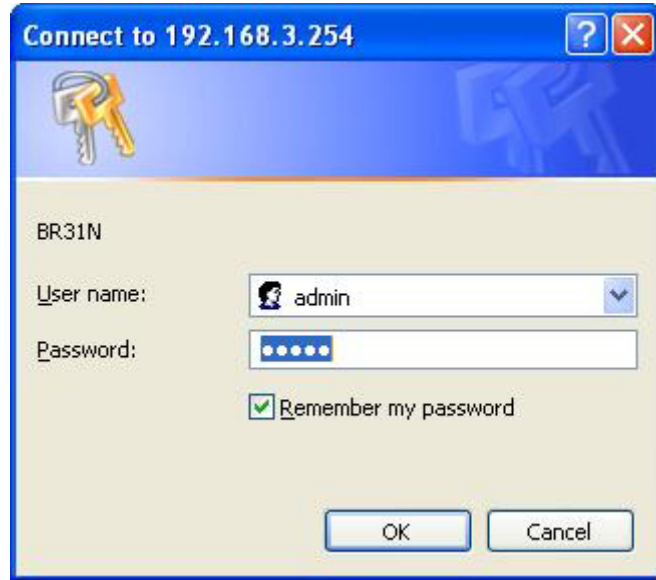

C. You are now connected to the Router and SmartSetup will detect your ISP type. If you do not see the menu shown below, click the Smart Setup button in the upper left of the main menu.

After SmartSetup detects your Internet connection, it will report the connection it finds. The possible options are:

- PPPoE
- Dynamic IP
- Static IP

 If your connection is not detected automatically, simply press the "Smart Setup" button on the menu panel to activate it.

**PPPoE Internet Connection Type**

If you have a **PPPoE** type connection, the following screen shown below will appear prompting you to enter the ISP User Name and Password.

 Note that you only have to enter the ISP information during initial setup only.

**Dynamic IP Internet Connection Type**

If you are connecting through a **Dynamic IP** address, no ISP login information is required. Just click the **OK** to allow the router to save

GN-BR31NE-RH 2.4GHz AirCruiser N150 Wireless Router

the Dynamic IP settings and the Router will reboot, bringing you to the Utility Main Page.

**Static IP Internet Connection Type**

If you have a **Static IP** address, the following screen show below will appear prompting you to enter your WAN IP address, WAN subnet mask, WAN gateway, and DSN information. This information is provided by your ISP.

- D. After signing in to your ISP, the router will restart and the web based configuration utility will restart again automatically. You will be presented with the GIGABYTE Wireless Router Main Page shown below.

Your GN-BR31NE-RH High-speed wireless router is now fully installed, and you are able to wirelessly share network resources, retrieve emails, download large files, conduct a video conference, and distribute or display digital photos, videos or MP3 files.

## Chapter 6 Advanced Setup

### Overview

This chapter explains the Advanced Setup options available for the GN-BR31NE-RH. The Advanced Setup Screens offer LAN and WLAN Network Configuration, Static Routing Table, Virtual Server, Firewall Rules, DNS Configuration, and URL Blocking. The Advanced Setup screens are available from the links on the Main menu.

### The Status Page

On the **Status** page the router's current connection and configuration information is displayed for the following; LAN Ethernet, WAN Ethernet, ARP Table, DHCP Lease Table, Routing Table, UPnP Port Mapping Table.



**LAN IP 1 Address** Displays the primary IP address being used by the Local (LAN) port of the Router. The default is 192.168.1.254

GN-BR31NE-RH 2.4GHz AirCruiser N150 Wireless Router

- LAN Netmask 1** Displays the IP Subnet Mask being used by the Local (LAN) port of the router. Default is 255.255.255.0
- LAN IP 2 Address** Displays the alternate IP address being used by the Local (LAN) port of the Router
- LAN Netmask 2** Displays the alternate IP Subnet Mask being used by the alternate Local (LAN) port of the router.
- LAN DHCP Status** Identifies if the Router's built-in DHCP server is active for the LAN attached devices.
- LAN DHCP Start IP** The starting IP number in the range possible IP addresses issued by the DHCP server
- LAN DHCP End IP** The last IP number in the range possible IP addresses issued by the DHCP server

**The LAN Ethernet Status Tab**

On the LAN Ethernet Status the Router displays the Ethernet Status of the current LAN current connection.



**MAC** This field displays the MAC address of the portable AP as seen on your wireless network.

**MTU** This specifies the maximum size of the packet permitted for Internet transmission.

**Rx packets** The number of data packets received by the AP.

**Tx packets** The number of data packets transmitted by the AP.

**Rx bytes** The current bandwidth (receive) on the LAN port.

**Tx bytes** The current bandwidth (transmit) on the LAN port.

**The WAN Ethernet Status button**



**MAC** The field displays the MAC address used by the WAN port of the AP.

**MTU** The maximum size of the packet sent from your computer to the Internet.

**Rx packets** The number of received packets of this port after resetting or manually initial.

**Tx packets** The number of transmitted packets of this port after resetting or manually initial.

**Rx bytes** The current bandwidth (receive) on the WAN port.

**Tx bytes** The current bandwidth (transmit) on the WAN port.

### The Wireless Status



The screenshot shows a web interface titled "Wireless Status". It contains a table with the following data:

Wireless Status	
MAC :	00:00:81:41:A6:14
MTU :	—
Rx packets :	198144
Tx packets :	1226
Rx bytes :	13690445
Tx bytes :	163636

Below the table is a button labeled "<< Previous".

**MAC** The field displays the MAC address used by the AP when wireless.

**Rx packets** The number of received packets of this wireless port after resetting or manually initial.

**Tx packets** The number of transmitted packets of this wireless port after resetting or manually initial.

**Rx bytes** The current reception bandwidth on the Wireless LAN.

**Tx bytes** The current transmission bandwidth on the Wireless LAN.

**ARP Table Tab**

The **ARP Table** displays the associated MAC address and IP address pairs of your local network devices. In the example below, only the GN-BR31NE-RH Router is in the ARP Table.

**ARP Table**

IP Address	MAC Address
192.168.1.111	00:20:ED:01:9E:94

[<<Previous](#)

**DHCP Lease Table Tab**

The DHCP server "leases" out address for specific times (Time To Live) to the various hosts. If a host does not use a given address for some period of time, that IP address can then be assigned to another machine. When assignments are made or changed, the DHCP server must update the information in the DNS server. The GN-BR31NE-RH DHCP Lease Table displays the associated IP/MAC assignment and Time To Lease.

**DHCP Lease Table**

IP Address	MAC Address	TTL
------------	-------------	-----

[<<Previous](#)

**IP Address** DHCP assigned IP address on WLAN

**MAC Address** MAC address of the device with the assigned IP.

**TTL** The time to live (TTL) in seconds that a resolver will use data received from a nameserver before it will ask for the same data again.

**Routing Table Tab**

To determine the best path to a distant network, the GN-BR31NE-RH uses RIP to always select the path that has the least number of hops. Each router that data must traverse is considered to be one hop. The routing table in a router using RIP contains an entry for every known destination network. The **Routing Table** displays the GN-BR31NE-RH RIP routing details.

**Routing Table**

Destination	Netmask	Gateway	Metric	Interface
192.168.1.0	255.255.255.0	*	0	LAN
10.0.0.0	255.0.0.0	*	0	WAN

<<Previous

**Destination** The IP address of the destination network address

**Netmask** The subnet of that destination IP address

**Gateway** Gateway of the destination IP address

**Metric** Hop count to the destination network

**Interface** Type of interface used

**UPnP Port Mapping Table**

The UPnP specification is based on TCP/IP and Internet protocols that let devices communicate with each other - UPnP technology doesn't rely on specific device drivers, using instead these standard protocols. UPnP devices can automatically configure network addressing, announce their presence on a network subnet, and permit the exchange of device and service descriptions. The **UPnP Port Mapping Table** displays the GN-BR31NE-RH port mapping and UPnP packet request details.

**UPnP Port Mapping Table**

Port Mapping usage:		0/128							
UPnP Auto Delete Time:		indefinite							
No.	Status	Client IP	Protocol	External Port	Internal Port	Remote Host IP	Lease Time	Create Time	Description

<< Previous Clear

**No.** The event number

**Status** Current status of the UPnP port (enable/disable)

**Client IP** The IP address of the client utilizing the port

**Protocol** IP protocol (UDP/TCP)

**External Port** The external port mapping

**Internal Port** The Internal port mapping

**Remote Host IP** The IP of the remote host (if applicable)

GN-BR31NE-RH 2.4GHz AirCruiser N150 Wireless Router

<b>Lease Time</b>	Length of time the port may be utilized for UPnP
<b>Create Time</b>	Time the port was established for UPnP
<b>Description</b>	UPnP process



## The Network Configuration Screen

The **Network Configuration** screen consists of three areas: **LAN Configuration**, **WAN Configuration** and **WAN settings**.

### The LAN Configuration Tab



#### LAN Configuration

Allows you to modify the LAN parameters, and if you want to enable DHCP automatic IP address assignments, you can enable it here, and specify a Start and End address for the IP range.

#### DHCP Option

The DHCP server "leases" out address for specific times (Time To Live) to the various hosts. If a host does not use a given address for some period of time, that IP address can then be assigned to another machine. When assignments are made or changed, the DHCP server must update the information in the DNS server. The AirCruiser G DHCP Lease Table displays the associated IP/MAC assignment and Time To Lease.

#### Force IP-MAC Mapping

Allows you to manually assign a specific IP address to a specific network device (MAC address) on the network. This will be updated in the ARP table automatically.

## The WAN Configuration Tab



The GN-BR31NE-RH has many advanced WAN configuration features. As a special redundant feature, you can configure up to 4 WAN connections and each may have its own connection type (PPPoE, PPPoE Unnumber, Dynamic IP address, Static IP address) and other properties. The device can automatically attempt to connect to these in order if your primary connection fails.

Click the **Edit** button to the right of the ISP that you wish to modify. A screen will appear allowing you to change the Internet connection type. (see below) Click the **Next** button to continue with modifications.

## GN-BR31NE-RH 2.4GHz AirCruiser N150 Wireless Router

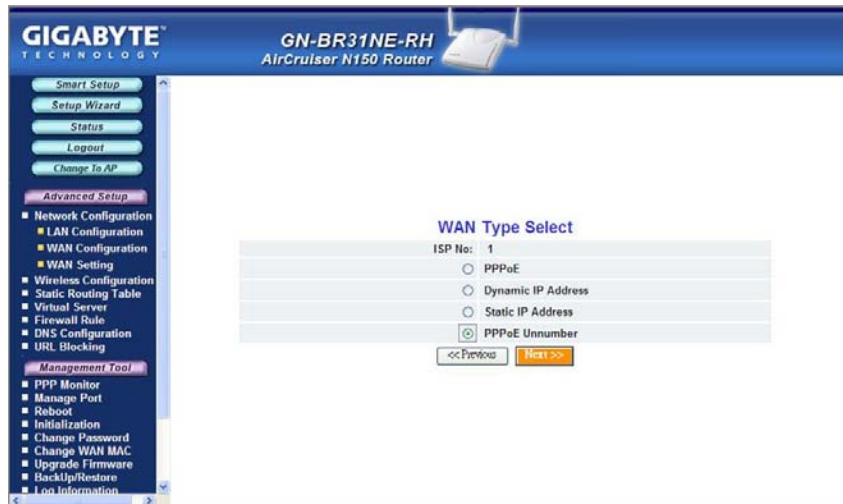

Depending on the WAN type you select, the corresponding WAN setup screen will appear next.

### WAN Configuration Tab – Dynamic IP Address



Your Internet Service Provider will supply you with the following account information you will need:

- ISP Name
- Host Name

GN-BR31NE-RH 2.4GHz AirCruiser N150 Wireless Router

- Gateway
- DNS1 and DNS2 Address
- DNS Domain Name

Enter the information provided by your ISP in the spaces provided.

**MTU (Maximum Transmission Unit)**

The largest packet unit is sent from your computer to the network. Any message larger than MTU will be divided into smaller packets before being sent. You should keep the default setting (1500). Setting MTU size is largely a process of trial-and-error: If you suspect your MTU setting is causing a connection problem, start with the maximum value of 1500, and then reduce the size down to 1400 until the problem goes away.

**NAT Setup**

The Network Address Translation (NAT) is a standard that allows multiple computers on a private network to share a single IP address.

Universal Plug and Play (UPnP) is a technology based on Internet standards and technologies, such as TCP/IP, HTTP, and XML, that allows devices on a network to automatically connect with other devices.

**UPnP Delete Time**

Select the duration that UPnP will be active. Since allowing this may present a security risk, the default setting is 0.



If the WAN IP address and LAN IP address obtained from DHCP server are from the same subnet, the LAN IP address will *automatically* change to another subnet and reboot the router.

**WAN Configuration Tab – PPPoE**



Your Internet Service Provider will supply you with the following account information you will need:

- ISP Name
- User ID/Password
- Service Name
- AC Name
- DNS1 and DNS2 Address
- DNS Domain Name

Enter the information provided by your ISP in the fields provided.

**Authentication Type**

Select one of the following authentication settings: Auto, CHAP or PAP. The default setting is “Auto” (automatic authentication).

Challenge Handshake Authentication Protocol (CHAP) is the most common authentication method using PPP dialup method. With CHAP, the server will send a challenging signal to a remote Router, which will send back an encryption key.

Password Authentication Protocol (PAP) is a simple PPP authentication protocol allowing a Router to send a simple user ID and password to another Router for authentication. PAP has been defined in RFC1334.

**Connection**

Automatic When the GN-BR31NE-RH is powered on, it automatically establishes a connection with the network. If the link becomes disconnected for any reason, the GN-BR31NE-RH will re-connect automatically.

Manual When you click “connection”, the system will establish a connection to the network. If the link becomes disconnected for any reason, the GN-BR31NE-RH will **not** re-connect automatically.

**Dial on Demand**

Enable When there is no Internet activity for a period, the WAN connection will automatically end. If a browser is launched again, the GN-BR31NE-RH will automatically connect to Internet.

Disable When there is no Internet activity for a period, the WAN connection will automatically end. If a browser is launched again, the GN-BR31NE-RH will **not** automatically connect to Internet.

**WAN Configuration Tab – Static IP Address**



Your Internet Service Provider will supply you with the following account information you will need:

- ISP Name
- WAN IP Address
- WAN Subnet Mask
- WAN Gateway

GN-BR31NE-RH 2.4GHz AirCruiser N150 Wireless Router

- Manual DNS1 and DNS2
- DNS Domain Name

This information is all provided by your ISP. In the event that your ISP has assigned you several Static IP addresses, you will only need to one.

**WAN Configuration Tab - PPPoE Unnumbered**

**PPPoE Unnumbered** is a PPPoE service provided by some ISPs. The GN-BR31NE-RH supports services that provide multiple global IP addresses. When using PPPoE Unnumbered, you can have up to 16 Global IP address depending upon your ISP's service policy. Among these Global IP addresses, one is used as Router's WAN IP address and the others can be used by the downstream clients of the Router.



Your Internet Service Provider will supply you with the following account information you will need:

- ISP Name
- User ID/Password
- Service Name
- AC Name
- Manual DNS1 and DNS2
- DNS Domain Name
- WAN IP Address
- WAN Subnet Mask

## GN-BR31NE-RH 2.4GHz AirCruiser N150 Wireless Router

Enter the information provided by your ISP for each of your Global IP's, then click next to proceed to enter additional IP's.

### The WAN Settings Tab - WAN Multi-Session Select

The WAN Multi-Session Select Tab displays the settings of the **Main Session** and **Backup Session**.



Select a WAN connection type for the Main Session from the drop-down menu and select Backup Session type. The Backup Session will become active if the Main Session fails to establish a connection to the Internet.

In the event that neither the Main Session nor the Backup Session can successfully establish a connection with your ISP, the following process will apply:

Automatic: Main -> Backup, Main -> Backup (repeat) Attempts to establish connection is repeated until successful.

Manual: Main -> Backup (Backup Session attempts only once)



The Backup Session can have a specific LAN type connection assigned.



## The Wireless Configuration Screen

The **Wireless Configuration** screen allows you to configure the Router's WLAN function.

### The 802.11ng Tab

The screenshot displays the 'Wireless LAN 802.11ng Configuration' page. The left sidebar contains navigation options: Smart Setup, Setup Wizard, Status, Logout, Change To AP, Advanced Setup, Network Configuration, Wireless Configuration (selected), 802.11ng (selected), MAC Access Control, 802.1x, WDS, WPS, Static Routing Table, Virtual Server, Firewall Rule, DNS Configuration, URL Blocking, Management Tools, PPP Monitor, Manage Port, Reboot, Initialization, Change Password, and Change WAN MAC. The main configuration area includes: Region (North America), Channel Width (Auto 20MHz/40MHz), Channel (5, ch1), QOS (WMM), SSID (GIGABYTE), Hidden SSID (disable), Authentication Type (Open System), WEP (disable), WEP Default Key (Key 1), and WEP Key fields (Key 1, Key 2, Key 3, Key 4). A note states: 'The WEP key must consist of Hexadecimal digits (A-F & 0-9) -> Enter 10 Hexadecimal digits as 64 Bit WEP Keys -> Enter 26 Hexadecimal digits as 128 Bit WEP Keys'. 'Submit' and 'Clear' buttons are at the bottom right.

#### Region

Indicates the geographical region you are in. Verify that the region indicated is correct. If not, please contact your local distributor or dealer immediately.

#### Channel Width

Selecting channel width by clicking the drop-down list.

Option 20Mhz indicates supporting 20MHz channel bandwidth.

Option Auto 20MHz/40MHz supports auto channel switching, and supports up to 40MHz, offering more faster speed.

#### Channel

The channel may be manually changed (if there are other wireless networks operating in your area) by selecting a channel from the drop-down list.

#### QOS

Select the QOS type from drop-down list.

#### SSID

The SSID (Service Set Identifier) is the name of your wireless network. The SSID is up to 32 ASCII characters in length and case sensitive (i.e. Letters in upper case "A~Z" and lower case "a~z" are unique). The default SSID is "GIGABYTE". To change the SSID, type in the SSID you want to use in the SSID field and click Submit. If you make a change to the SSID, any wireless

devices on your network must also be reconfigured to connect to the new network name.

**Hidden SSID**

For security purposes, you may choose to hide your network's SSID by selecting enable from the drop-down list. This will prevent computers scanning for the presence of wireless networks to detect your network name. The default setting is disable.

**Authentication Type**

Select an authentication type from the drop-down list. The default setting is Open System.

Open System: The sender and the receiver do NOT share a secret key. Each party generates its own key-pair and asks the receiver to accept a randomly generated key. Once accepted, this key will only be used for a short period of time. Afterwards, a new key will be generated and agreed upon.

Shared Key: Authentication is based upon a secret key shared by both the sender and the receiver. If Shared Key is selected, you cannot choose the WEP disable option.

WPA Pre-shared key: The WPA Pre-shared Key authentication standard uses a password or "key" between 8 and 32 characters. This encryption key is changed after every dialog box using the Temporary Key Integrity Protocol (TKIP), which allows users to change keys based on dialog box and automatically synchronize keys between devices on the network. The TKIP encryption algorithm is stricter than the one used by WEP but is based on the same standard.

WPA: The 802.1x authentication protocol, allows users to authenticate wireless network access through a RADIUS Server and is a required by WPA standard. If no RADIUS Server exists in your network environment, you still can use WPA through the use of WPA Pre-shared Key.

**WEP Key**

The GN-BR31NE-RH supports two WEP standards: 64-bit, 128-bit. Select either 64-bits or 128-bits from the drop-down list activate WEP encryption. The 64-bits encryption uses 40 bits as a secret key, (user-defined) and the remaining 24 bits are reserved. The 128-bits encryption uses 104 bits as a secret key, (user-defined) and the remaining 24 bits are reserved.

**WPA Re-key**

Enabling the requirement for WPA rekeying of a Passphrase for increased security. Default is disable.

**WEP Re-key Timer**

Specify time (in minutes) for expiration of the current WPA Key.

**WPA PSK Passphrase**

The Passphrase must be between 8 and 64 characters.

**WPA PSK Re-key**

A user without a RADIUS server, may specify generating a new WPA PSK key more frequently than each time he connects to the network.

**WPA PSK Re-key Timer**

Specify time (in minutes) for expiration of the current WPA PSK key

**The MAC Access Control Tab**



The **MAC Access Control** screen allows you to specify the Media Access Controller (MAC) address of up to 32 devices on your network. Only those devices listed in the table will have access to transmit data through the GN-BR31NE-RH. In this way, even if someone manages to obtain all the information necessary to connect to your network, if their MAC address is not permitted, they still cannot connect. Keep in mind, however that MAC addresses can be spoofed, so it is not a panacea but rather another component of your existing security process. Enable the feature, then key in the MAC addresses to be allowed. Enter the MAC in the form separated by colon. The default setting is **Disable**.

## The Radius Server Configuration Tab



Your GN-BR31NE-RH supports 802.1x and RADIUS Server authentication. RADIUS provides a centralized, server-based authentication of client access to the network.

**RADIUS Server IP** Assign an IP address for the RADIUS Server.

**RADIUS Server Port** Enter a value within the range 1~65536 for the port.

**Shared Secret** Enter a password up to 256 characters (uppercase "A~Z", lowercase "a~z" or numeric "0~9") in length.

**Rekey** Disable or enable Rekey function.

## The WDS Tab

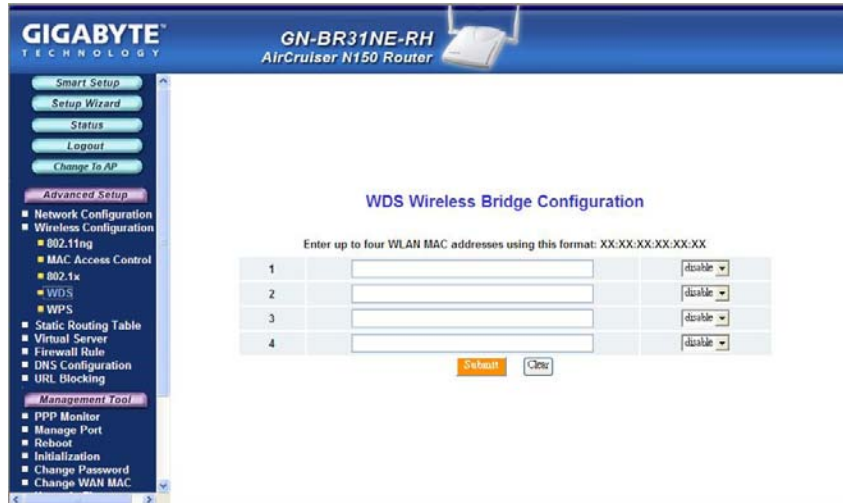

Wireless Distribution System (WDS) technology enables several access points to increase the coverage of a wireless network. Although enterprises or home users can reduce most wiring problems by using access points that support WDS, they still need cables to connect external ISP.

To use WDS, please make sure:

- ✓ All routers/AP's participating in the WDS must use the same RF Channel
- ✓ DHCP (if used) must only be enabled on the bridge Router and **not** on the node AP's.

**Example:** Suppose Router1 is connected to the DSL modem, and uses DHCP to dish out IP's to your WLAN. To use Router1 to bridge to a remote AP, key in AP's Wireless MAC Address in Router1's WDS configuration list and select "enable" then press Submit. In AP's LAN settings, disable DHCP and assure the AP uses the same RF Channel as the Router1. You should now be able to connect to Router1 through AP.



Note that bridging between different vendors wireless gear is not guaranteed. Your GN-BR31NE-RH may only create a WDS environment with other Gigabyte Routers or GIGABYTE Access Points.

## The WPS Tab

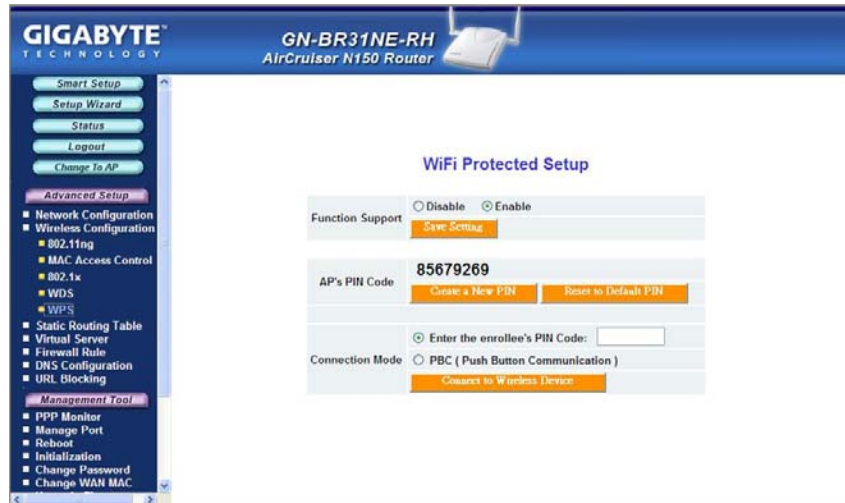

The primary goal of Wi-Fi Protected Setup (Wi-Fi Simple Configuration) is to simplify the security setup and management of Wi-Fi networks. Gigabyte STA supports the configuration and setup using a PIN configuration method or a PBC configuration method through an internal or external Registrar.

- |                         |   |
|-------------------------|---|
| <b>Function Support</b> | Select either enable or disable WPS function support. Determine the function support, then click the "Save Setting" tab to save the configuration.  |
| <b>AP's PIN Code</b>    | This item provide function for user to Create a New PIN or Reset to Default PIN.  |
| <b>Connect Mode</b>     | The user is required to enter an 8-digit PIN Code into Registrar. When an STA is the Enrollee, you can click "Renew" to re-generate a new PIN Code. |

## The Static Routing Table Screen

The **Static Routing Table** displays the GN-BR31NE-RH routing settings. To add or modify, enter a value into the field and click the **Submit** button.

List	Destination IP	Netmask	Gateway	Metric
1	<input type="text"/>	<input type="text"/>	<input type="text"/>	<input type="text"/>
2	<input type="text"/>	<input type="text"/>	<input type="text"/>	<input type="text"/>
3	<input type="text"/>	<input type="text"/>	<input type="text"/>	<input type="text"/>
4	<input type="text"/>	<input type="text"/>	<input type="text"/>	<input type="text"/>

### Destination IP

Enter the Destination IP address that will be assigned to a specific network or host.

### Netmask

Enter the netmask associated with the Destination IP.

### Gateway

Enter an IP address that will be assigned to the interface connecting to subnets.

### Metric

The "Metric" value is a number between 1 and 15 that represents the number of Routers between your network and the destination. Generally, setting the Metric value as either 2 or 3 is sufficient for most applications. If this is a direct connection, please set the value to 1. The default setting is 1.

## The Virtual Server Screen

The **Virtual Server** screen allows you to manage the virtual server settings of the GN-BR31NE-RH. There are two virtual server options: 1. The router has only one IP address or, 2. The router has multiple IP addresses (8 or 16 in most instances). If you have only one IP address click on the **PPPoE/DHCP/Static** tab. If you have multiple IP addresses, click on the **PPPoE Unnumber** tab. The DMZ Support tab allows you to enable a Demilitarized Zone (Zone) on your network.

## The DMZ Setting Tab



With a firewall setup, it sometimes necessary to place some clients (e.g. Internet games, video conferencing, or VPN connections) outside of the firewall while leaving the others protected. You can do this using a Demilitarized Zone. The DMZ feature allows you to specify the IP address of the computer that will be placed outside the firewall of your network. Enter the IP Address of your computer (e.g. 192.168.1.2) into the LAN IP Address field and click the **Submit** button.

	<p>Note: DMZ servers pose a security risk. A computer designated as the default DMZ server loses much of the protection of the firewall, and is exposed to exploits from the Internet. If compromised, the DMZ server can be used to attack your network.</p>
---	---



## The Virtual Server PPPoE/DHCP/Static Configuration Tab

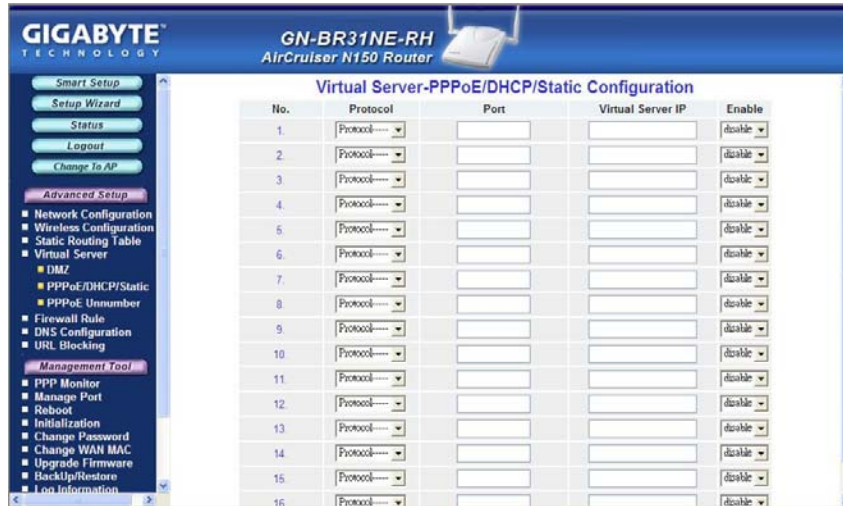

The GN-BR31NE-RH is configurable to behave as a Virtual Server, allowing remote computers on the WAN (Internet) side of the network to be automatically redirected to local server(s) on the LAN (your private network) side of the network.

**Protocol** The protocol used for the virtual service

**Port** The port number of the service used by the PC on the LAN side.

**Virtual Server IP** The server computer in the LAN that will be providing the virtual services

For example, if you have an FTP server on the LAN side you wanted Internet users to access, suppose the PC has a local IP address of 192.168.1.1, you would use the following virtual server settings:

- Protocol: TCP
- Port: 21 (FTP uses port 21)
- Virtual Server IP: 192.168.1.1
- Enable: enable

## The PPPoE Unnumber Tab

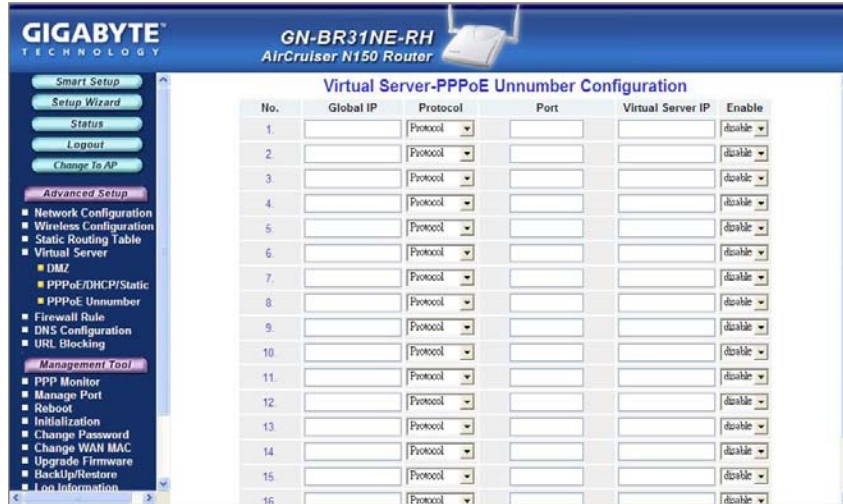

Advanced feature of the GN-BR31NE-RH is that it supports services that offer multiple global IP addresses, with each IP address requires its own setting. This feature is normally only found on enterprise class routers. The GN-BR31NE-RH has an IP allocation scheme capable of directly assigning global IP to LAN clients.

You can only take advantage of this feature if your ISP service packages will provide you with a range of valid "Global IP". (For example **61.222.10.1 ~ 61.222.10.7**) These seven addresses can be individually configured.

**Global IP** An IP within the range of IP's assigned to you by your ISP

**Protocol** The protocol used for the Unnumbered service

**Port** The port number of the service used by the LAN side

**Virtual Server IP** The computer on the LAN that will be providing the Unnumbered virtual services

Example: Taking the IP address of 192.168.1.1 of a PC connected to the GN-BR31NE-RH for example would use the following settings:

- Global IP: 61.222.10.2
- Protocol: TCP
- Port: 21
- Virtual Server IP: 192.168.1.1
- Enable: enable

The Global IP 61.222.10.2 is now directly assigned to the FTP server at the IP address 192.168.1.1 located within the GN-BR31NE-RH's LAN.

## The Firewall Rule Screen

The Firewall Rule screen displays your network security settings. Use this screen to create network security policies to prevent unauthorized access to your network.

## The Security Configuration Tab

Select security configuration options from this page including **Security One-Touch Setting**, **Stealth Mode** and **Unlawful Computer Access Detection**. You can select with one click a 'High' 'Medium' or 'Low (off)' level of Security. You can fine tune your security level settings with the One-touch Settings section. Just check /uncheck the boxes to include/remove that particular setting.

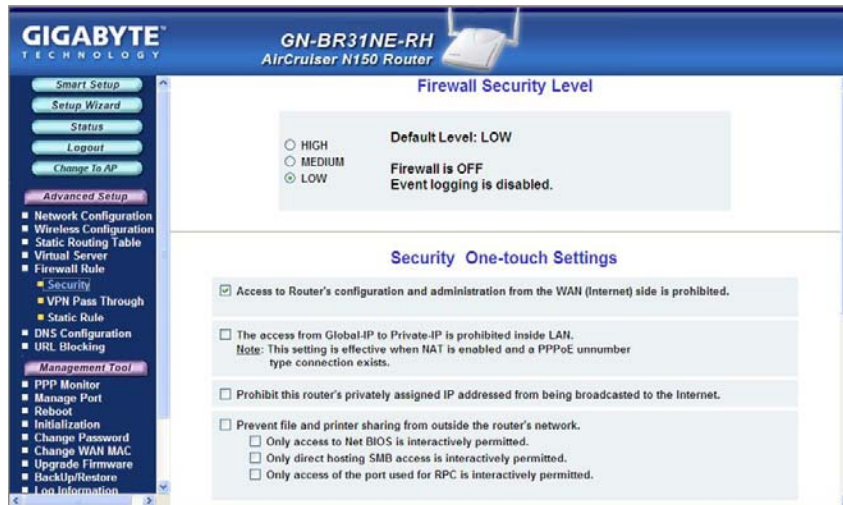

When any item in Security One-touch setting combined with "Stateful Packet Inspection is used" under the **Unlawful Computer Access Detection** group are checked, the **URL Blocking** feature becomes unavailable.

## The VPN Pass Through Tab

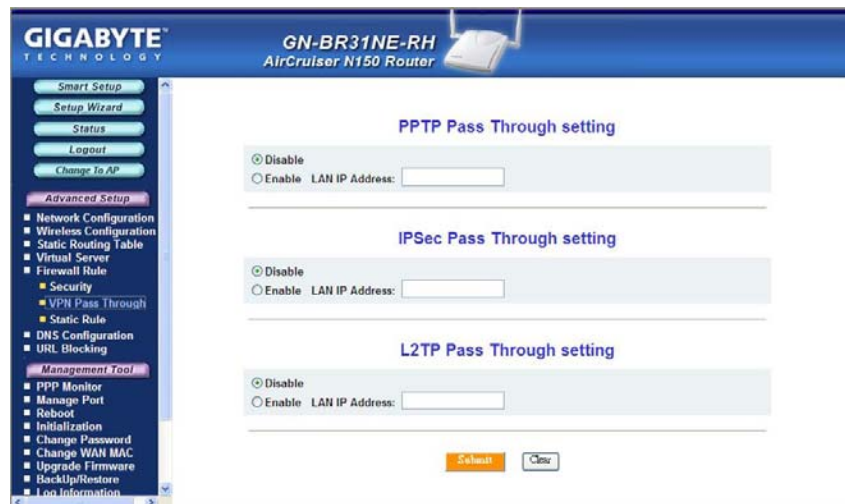

A Virtual Private Network (VPN) is a type of secured private network connection, built upon publicly-accessible infrastructure such as the Internet. They usually provide connectivity to various devices behind a gateway or firewall.

The GN-BR31NE-RH supports Internet-industry standard technologies to provide open and interoperable VPN solutions, including Internet Protocol Security (IPSec), Layer 2 Tunneling Protocol (L2TP) and Point-to-Point Tunneling Protocol (PPTP).

### **PPTP Pass Through setting**

Point-to-Point Tunneling Protocol (PPTP) allows you to establish a connection to an enterprise network. To allow PPTP tunnels to pass through the Router, click Enable and key in the Router's IP address.

### **IPSec Pass Through setting**

IP Security (IPSec) provides authentication and encryption. Since it is mainly a Layer 3 technology, it can secure all data on the network. To allow IPSec tunnels to pass through the Router, click Enable and key in the Router's IP address.

### **L2TP Pass Through setting**

Layer 2 Tunneling Protocol (L2TP) is an extension of the Point-to-Point Tunneling Protocol and is also used to establish virtual private networks. To allow L2TP tunnels to pass through the Router, click Enable, and key in the Router's IP address.

## The Static Rule Tab

The Static Rule screen allows you to manually edit the firewall rule table, thereby helping to protect your network from external attacks as well as provide a method to restrict Internet access to users on your network. Additionally, it can filter out specific packets which are used by hackers to trigger the Router to establish an outgoing connection.



To edit the current settings, click the **Add** button. The following screen will appear.

GN-BR31NE-RH 2.4GHz AirCruiser N150 Wireless Router



**Rule Number (No.)**

Enter a number for the rule between 1 and 64. Rules are ranked in priority based on their number in descending order, so that rule 1 is given the highest priority and rule 64 the lowest priority.

**Policy**

Select an **accept** or **drop** option. You can specify the Router to drop (or accept) all packets which meets the Rule criteria.

**Direction**

Specify the packet flow direction according to data filtering rule.

- a. **W->L:** WAN to LAN, filtering incoming packets
- b. **L->W:** LAN to WAN, filtering outgoing packets

**Protocol**

Select a setting from the drop-down list to specify the protocol (s) for the static rule.

**Log**

Enable or disable the log feature.

## The DNS Configuration Screen



### DNS Relay

DNS Relay will set your PC's DNS entries to point to the Router's Gateway address, which will then forward DNS queries to the DNS server used by the Router. This is needed when using DHCP to assign IP address to the PC's in you LAN. The default value of DNS relay is **Enable**.

### Dynamic DNS

The GN-BR31NE-RH offers a **Dynamic Domain Name Server (DDNS)** service that allows you to assign a fixed host and domain name to a dynamic Internet IP address. This gives Internet users the ability to connect with a virtual sever using a FQDN, rather than with an IP address. Before using this feature, you must first register an account with the dynamic DNS service. (<http://www.dyndns.org>)

**Service Provider** From this pull down menu, enter the DDNS service with which you have membership.

**Domain Name** This is the DDNS URL assigned by the DDNS service.

**Login Name** Enter the User Name for your DDNS account.

**Password** Enter the Password for your DDNS account.

**Wildcards** If your dynamic DNS provider allows using wildcards in resolving your URL, you may select Enable to activate this function.

## The URL Blocking Configuration Screen

The URL Blocking Configuration screen allows you to restrict access based upon specific web addresses and/or keywords.

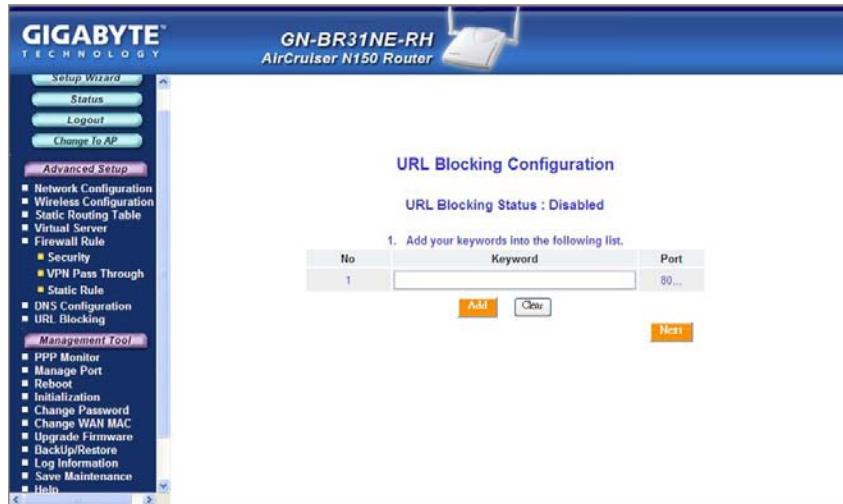

To activate the **URL Blocking** feature:

**Keyword** Enter the keyword or domain in the Keyword field that you wish to block.

All URL's with those keywords in the DOMAIN name will now be blocked.



## Chapter 7 Using Management Tools

### Overview

---

Management Tool Screens offer management of the Router itself, such as Firmware Updates, Initialization, and Password administration etc. The instructions in this chapter will help you how to use the management tools of the web-based utility to effectively manage your GN-BR31NE-RH wireless broadband router.

### The PPP Monitor Screen

---

The **PPP Monitor** screen displays the WAN (Internet) connection status. Click the **Disconnect** button to end your current session. Click the **Connect** button to re-connect to the ISP.



### Manage Port Configuration Screen

---

The **Manage Port Configuration** screen allows you to change the port on which the Router's configuration utility runs. The default is Port 80 but users can change this to any port they wish (like 8080, 8000 or else port). In this case, to access the Router configuration utility, you would type `http://192.168.1.254:8080`

## GN-BR31NE-RH 2.4GHz AirCruiser N150 Wireless Router

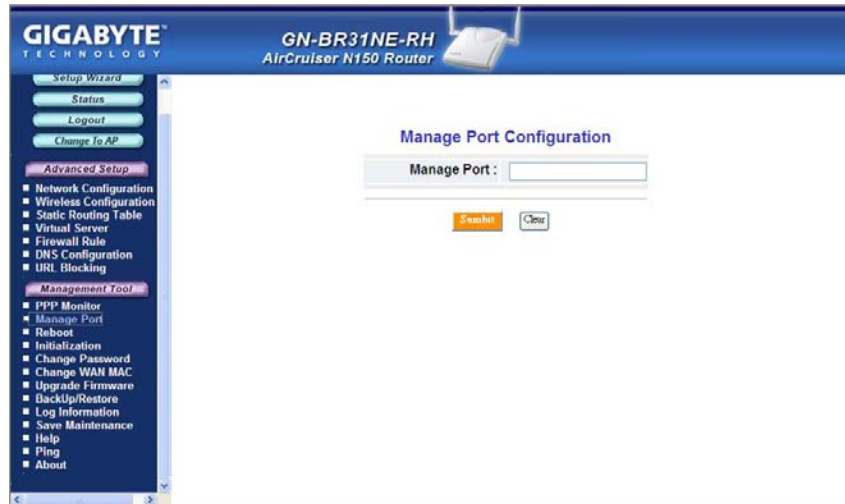

## The Reboot Screen

The Reboot screen allows you to reboot the GN-BR31NE-RH. You are also automatically brought to this screen after you confirm OK to any change of Router settings.

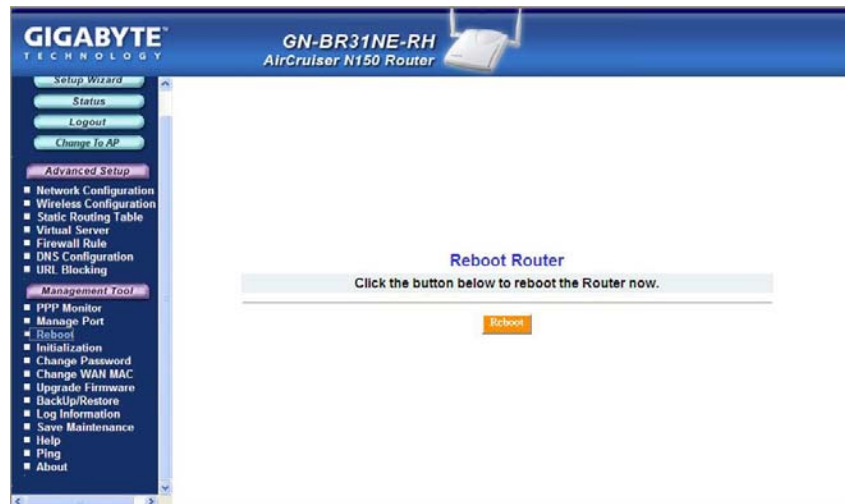

## The Initialization Screen

---

The **Initialization** screen allows you to reset the GN-BR31NE-RH back to its original factory settings. To initialize the router, use the tip of a pencil or a paperclip to press and hold the **init** button for 5 seconds. (The init button is located on the side of the unit, next to the AC power input).

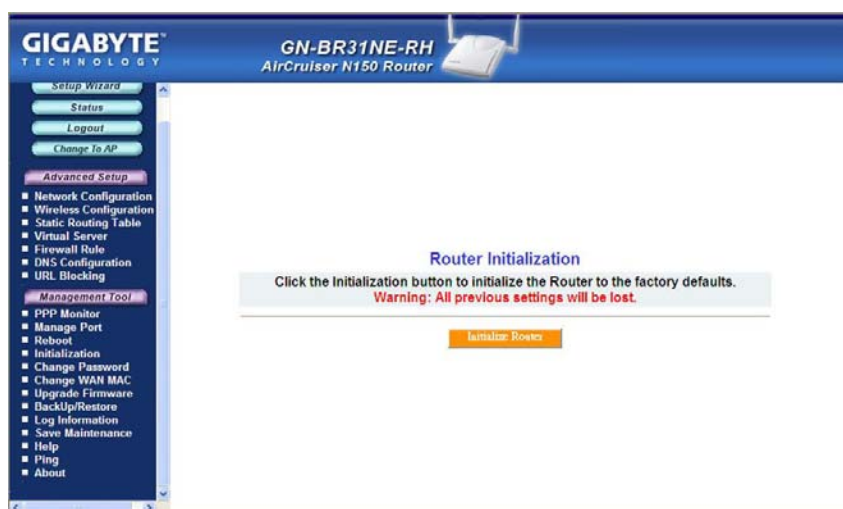

## The Change Password Screen

---

The **Change Password** screen allows the administrator to create a new password for the GN-BR31NE-RH. To change an existing password, enter your account and new password and after re-typing the password to confirm, click the **Submit** button.

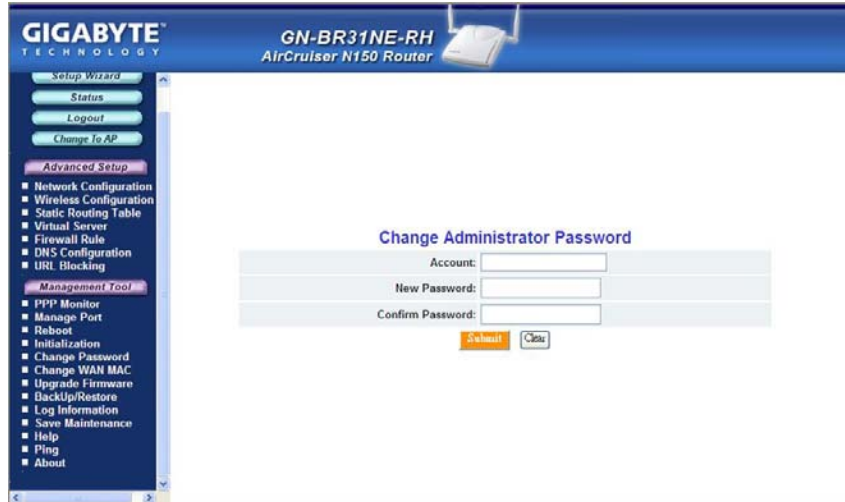

## The Change WAN MAC Screen

The **Change WAN MAC** screen allows you to assign a new MAC address. If your ISP requires MAC address authentication, choose the **Assign WAN MAC** option and enter the ISP authorized MAC address in the **New WAN MAC Address** field and click the **Submit** button. If you want to restore the factory default MAC address, choose the **Restore Default WAN MAC** option and click the **Submit** button.



## The Upgrade Firmware Screen

The Upgrade Firmware screen allows you to update the current GN-BR31NE-RH firmware to the latest version directly from the GIGABYTE website. Click the Browse button to locate the firmware file which you just downloaded from the GIGABYTE website, and then click **Upgrade**. Warning: Assure you are installing the correct firmware version.

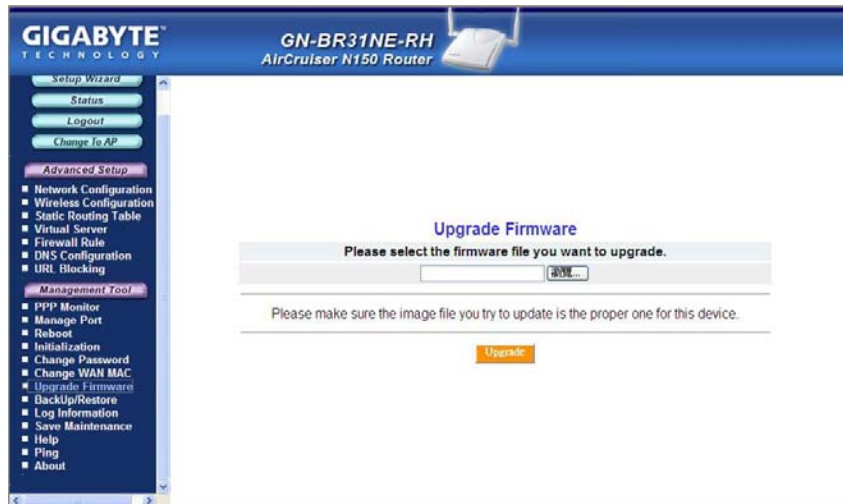

## The Backup / Restore Screen

The **Backup / Restore** screen allows you to save the current configuration settings of the GN-BR31NE-RH as a temp file onto your computer. To revert the GN-BR31NE-RH to back to a previously saved configuration settings, click the **Browse** to locate the saved configuration file. Then, click the **Restore** button.

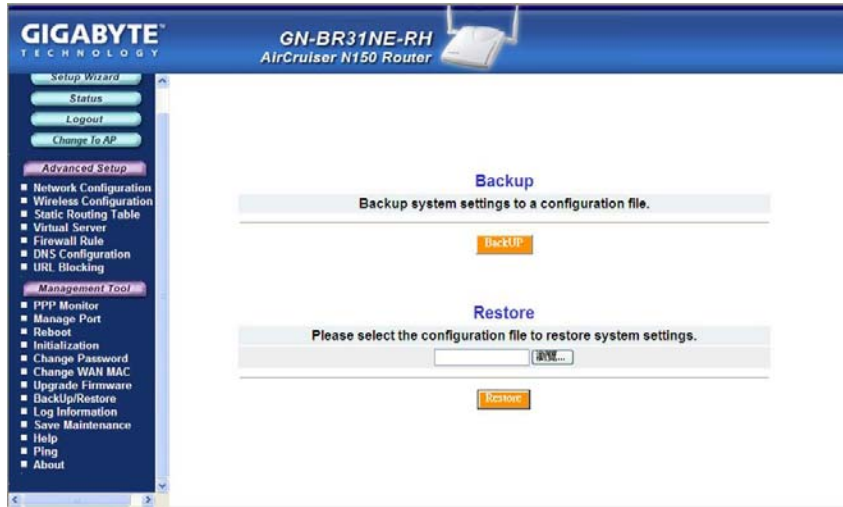

## The Log Information Screen

The GN-BR31NE-RH has advanced firewall features, and can effectively prevent intruders and unwanted attacks on your network, while keeping logs of all such attempts including all legitimate WAN connections and UPnP logs. Click on **Firewall Log**, **WAN Connection** or **UPnP Log** to view the list.

### The Firewall Log Tab

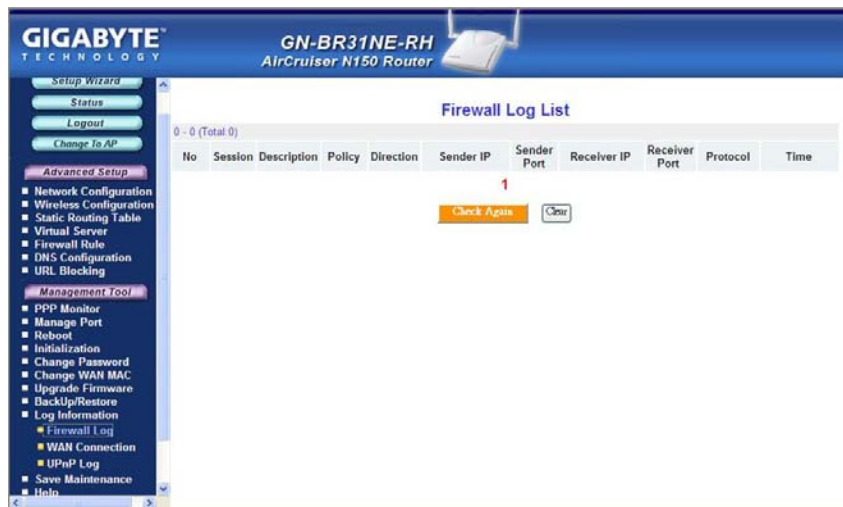

### The WAN Connection Tab

In the WAN connection Log, all logins are chronologically ordered, with indications of connection type and event type.

GN-BR31NE-RH 2.4GHz AirCruiser N150 Wireless Router

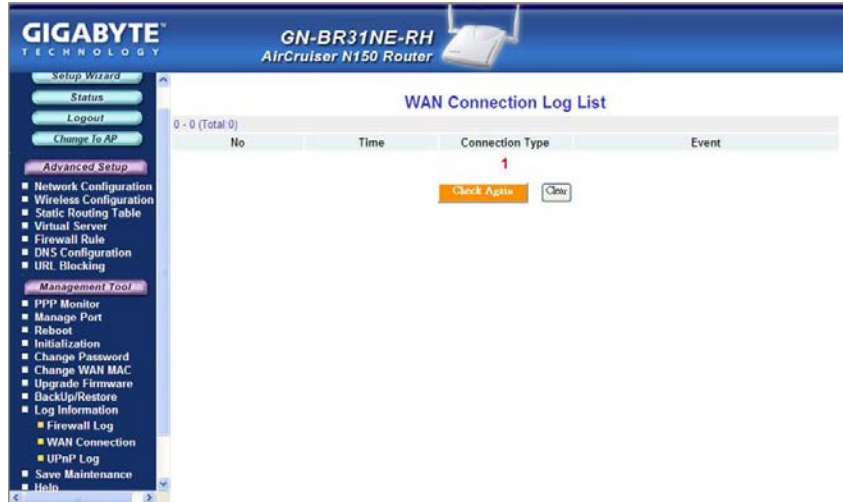

**The UPnP Log Tab**

The Universal Plug and Play log screen records and displays UPnP packets reaching your GN-BR31NE-RH. It logs details such as Source IP, time of connection, connection status, external port and protocol for LAN port(s) that are UPnP enabled. To refresh the list, press “Check Again”.

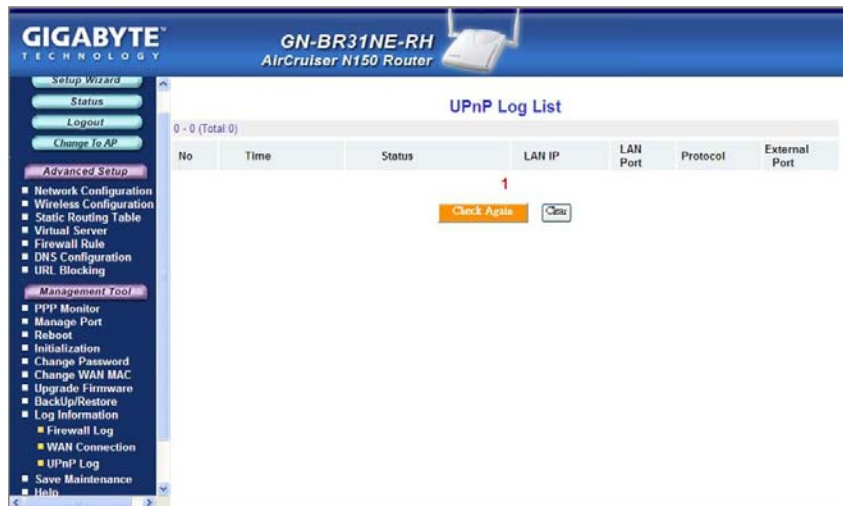



## The Save Maintenance Screen

The Save Maintenance screen allows you to save logs and status information as a file which can then be sent to the Technical Support team at GIGABYTE.



## The Ping Screen

'Pinging' involves sending a packet of data to a site and recording how long it takes for the site to acknowledge receipt. This is useful if you think that a web site might be slow or unavailable. Type the IP Address and click the Ping to start.

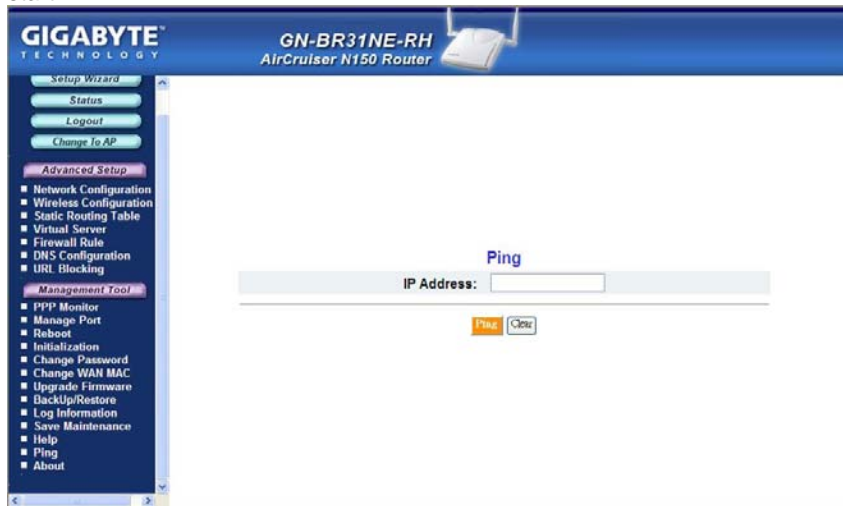

## The Help Screen

The **Help** screen is where you can access online guide to assist in configuring the GN-BR31NE-RH.

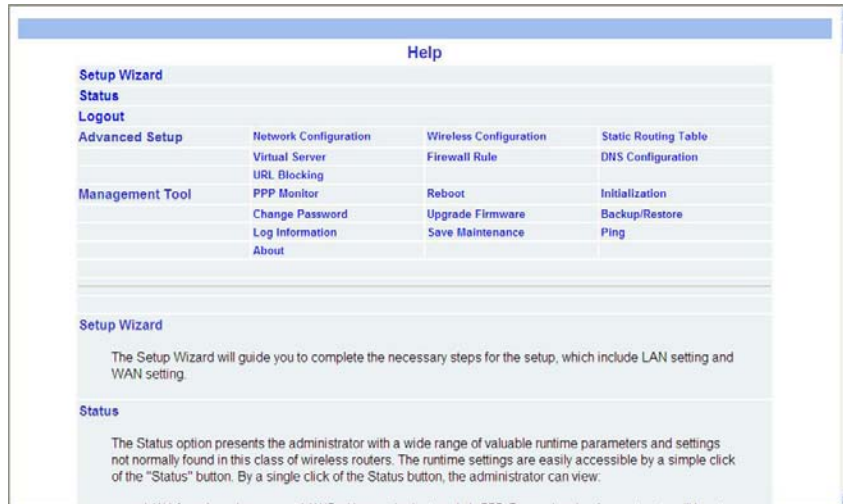

## The About Screen

The **About** screen displays the Router model name and firmware version.

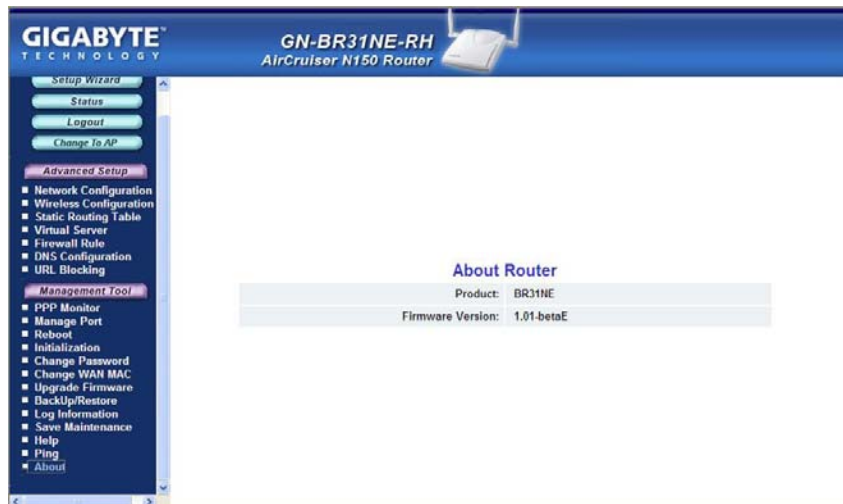

## Chapter 8

# Using Multiple BSSID Function under AP Mode

### Overview

---

GN-BR31NE-RH supports Multiple BSSID function. When one AP is connected to a wired network and a set of wireless stations it is referred to as a Basic Service Set (BSS). The Basic Service Set Identifier (BSSID) is a 32-character unique identifier attached to the header of packets sent over a WLAN that differentiated one WLAN from another when a mobile device tries to connect to the network.

### How to Configure Multiple BSSID

---

To configure Multiple BSSID function, just go to Advanced Setup Screen. Click on **Change to AP** tab. By clicking Change to AP tab, the following setup wizard will appears:



Click **“OK”**.

GN-BR31NE-RH 2.4GHz AirCruiser N150 Wireless Router

The **Setup Completed** screen appears. Click the **Reboot** button to restart your router so that the settings take effect.



While the router is rebooting, the Router Restarting Screen will display the time remaining. Please be patient and let the router restart itself.

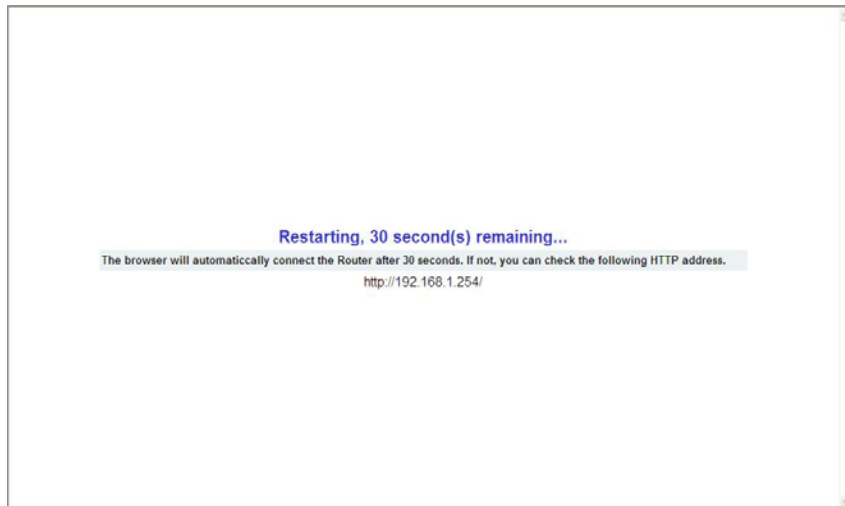

## Entering the Advanced Setup

To configure Multiple BSSID function, click on **Wireless Configuration**.



## The VLAN Configuration Screen

The **VLAN Configuration** screen allows you to configure the AP's VLAN function.

With using Multiple BSSIDs combined with VLANs. You can configure combinations of VLANS and BSSIDs with stronger or less restrictive access security according to your requirements.

### Port Configuration



In the Port Configuration, user can create maximum 4 groups within 4 ports and 4 SSID. Once VLAN configuration is set, and click **Save** button to take effect on the VLAN configuration

## The Wireless Configuration Screen

The **Wireless Configuration** screen allows you to configure the AP's WLAN function.

### The 802.11ng Tab

The screenshot displays the 'Wireless LAN 802.11ng Configuration' page. The left sidebar contains navigation options like 'Status', 'Logout', 'Change to Router', and 'Advanced Setup'. The main configuration area includes: Region (North America), Channel Width (Auto 20/40 MHz), Channel (5, ch 1), QOS (WMM), Multiple BSSID (SSID 1), SSID (GIGABYTE), Hidden SSID (disable), Authentication Type (open system), WEP (disable), WEP Default Key (Key 1), and four WEP Key input fields (Key 1-4). A note specifies that WEP keys must be hexadecimal digits (A-F & 0-9).

#### Region

Indicates the geographical region you are in. Verify that the region indicated is correct. If not, please contact your local distributor or dealer immediately.

#### Channel Width

Selecting channel width by clicking the drop-down list.

Option 20MHz indicates supporting 20MHz channel bandwidth.

Option Auto 20MHz/40MHz supports auto channel switching, and supports up to 40MHz, offering more faster speed.

#### Channel

The channel may be manually changed (if there are other wireless networks operating in your area) by selecting a channel from the drop-down list.

#### QOS

Select the QOS type from drop-down list.

#### Multiple BSSID

Select the Multiple BSSID from drop-down list.

#### SSID

The SSID (Service Set Identifier) is the name of your wireless network. The



SSID is up to 32 ASCII characters in length and case sensitive (i.e. Letters in upper case "A-Z" and lower case "a-z" are unique). The default SSID is "GIGABYTE". To change the SSID, type in the SSID you want to use in the SSID field and click Submit. If you make a change to the SSID, any wireless devices on your network must also be reconfigured to connect to the new network name.

**Hidden SSID**

For security purposes, you may choose to hide your network's SSID by selecting enable from the drop-down list. This will prevent computers scanning for the presence of wireless networks to detect your network name. The default setting is disable.

**Authentication Type**

Select an authentication type from the drop-down list. The default setting is Open System.

Open System: The sender and the receiver do NOT share a secret key. Each party generates its own key-pair and asks the receiver to accept a randomly generated key. Once accepted, this key will only be used for a short period of time. Afterwards, a new key will be generated and agreed upon.

Shared Key: Authentication is based upon a secret key shared by both the sender and the receiver. If Shared Key is selected, you cannot choose the WEP disable option.

WPA Pre-shared key: The WPA Pre-shared Key authentication standard uses a password or "key" between 8 and 32 characters. This encryption key is changed after every dialog box using the Temporary Key Integrity Protocol (TKIP), which allows users to change keys based on dialog box and automatically synchronize keys between devices on the network. The TKIP encryption algorithm is stricter than the one used by WEP but is based on the same standard.

WPA: The 802.1x authentication protocol, allows users to authenticate wireless network access through a RADIUS Server and is a required by WPA standard. If no RADIUS Server exists in your network environment, you still can use WPA through the use of WPA Pre-shared Key.

**WEP Key**

The GN-BR31NE-RH supports two WEP standards: 64-bit, 128-bit. Select either 64-bits or 128-bits from the drop-down list activate WEP encryption. The 64-bits encryption uses 40 bits as a secret key, (user-defined) and the remaining 24 bits are reserved. The 128-bits encryption uses 104 bits as a secret key, (user-defined) and the remaining 24 bits are reserved. more frequently than each time he connects to the network.

## Appendix A FAQ

This section provides solutions to common problems that may occur during installation, configuration or use of the GN-BR31NE-RH.

**Q: What is the default IP address for the BR31NE-RH?**

**A:** 192.168.1.254

**Q: I can't remember the password or IP address of the router.**

**A:** You can resolve this by pressing the "Init" button on the side of the router. You can also reset the Router from the Web Utility <Initialization Page>. The Router will reboot and all settings (including the default password) will be restored to their default values.

**Q: What is the default username and password for the GN-BR31NE-RH?**

**A:** Username is "admin" and password is "admin".

**Q: Why do I have to setup ISP information into my Router?**

**A:** ISPs require a special login protocol, in which you must enter a login name and password in order to access the Internet. In order to share the Internet connection among several computers, you must configure it with the TCP/IP information that your one PC would normally use.

**Q: Where in the network do I connect the router?**

**A:** In a typical environment, the GN-BR31NE-RH is installed directly onto the ADSL/Cable Modem. Plug the RJ45 Ethernet cable of the ADSL or Cable Modem into the WAN port of the Router.

**Q: Why should I use the GN-BR31NE-RH to work as a DHCP server?**

**A:** Using the GN-BR31NE-RH Router as a DHCP server By default, the router will function as a DHCP (Dynamic Host Configuration Protocol) server, allowing it to assign IP, DNS server, and default gateway addresses to all computers connected to the router's LAN. The assigned default gateway address is the LAN address of the router. IP addresses will be assigned to the attached PCs from a pool of addresses specified in this menu. Each pool address is tested before it is assigned to avoid duplicate addresses on the LAN. DHCP helps prevent IP conflicts.

**Q: What is the IEEE 802.11g standard?**

**A:** The IEEE 802.11g standard specifies data rates of up to 54 Mbps in the 2.45-GHz band. It uses Orthogonal Frequency Division Multiplexing (OFDM), which is provided by this standard and is compatible with 802.11b standard offering speeds of about 11 Mbps. This standard uses Complementary Code Keying (CCK) modulation. Both 11g and 11b can operate at a range of up to 300 feet.

GN-BR31NE-RH 2.4GHz AirCruiser N150 Wireless Router

**Q: When using GN-BR31NE-RH in Australia, you will use PPPoA protocol. How to set up your configuration in GN-BR31NE-RH?**

**A:** Suggestion 1, Using Static IP.  
Suggestion 2, Using DHCP client to get IP from ADSL/Cable modem.

## Appendix B Using Setup Wizard

In addition to Smart Setup, your **GN-BR31NE-RH** Router's ISP settings may be configured manually using Setup Wizard. Press the Setup Wizard menu button to proceed. You will be presented with the screen shown below. Please choose your Internet connection (WAN) type from the list and follow the steps for instructions

The screenshot shows the GIGABYTE GN-BR31NE-RH AirCruiser N150 Router's Setup Wizard interface. The left sidebar contains navigation options: Smart Setup, Setup Wizard, Status, Logout, Change To AP, Advanced Setup (with sub-items: Network Configuration, Wireless Configuration, Static Routing Table, Virtual Server, Firewall Rule, DNS Configuration, URL Blocking), and Management Tool (with sub-items: PPP Monitor, Manage Port, Reboot, Initialization, Change Password, Change WAN MAC, Upgrade Firmware, Backup/Restore, Log Information, Solve Maintenance, Help, Ping, About). The main content area is titled 'LAN Setup' and contains the following fields and options:

LAN IP Address:	192.168.1.254
LAN Subnet Mask:	255.255.255.0
DHCP Server:	<input checked="" type="radio"/> enable <input type="radio"/> disable
Starting IP Address:	192.168.1.2
Ending IP Address:	192.168.1.33

At the bottom of the form are two buttons: 'Next >>' and 'Clear'.

**LAN IP Address:** Input LAN IP Address.

**LAN Subnet Mask:** Input Subnet Mask.

**DHCP Server:** Enable or Disable DHCP server option. The default setting is **enabled**.

**Starting IP Address:** Input Starting LAN IP Address.

**Ending IP Address:** Input Ending LAN IP Address.

Click Next to process LAN Setup configuration.

## GN-BR31NE-RH 2.4GHz AirCruiser N150 Wireless Router



**PPPoE:** Most common type for typical home users. If your broadband ISP service PPPoE, please select this item, click the Next button and then **go to Step 3** of this section

**Dynamic IP Address:** If your broadband ISP service is an 'always-on connection', but you do not have a static IP, please select this item, click the **Next** button and then go to Step 7 of this section.

**Static IP Address:** Common for Enterprise Internet connections. If your broadband ISP service is a 'fixed-connection' and your IP never changes, please select this item, click the Next button and then go to Step 11 of this section.

**PPPoE Unnumber:** Common in Japan and some European Countries. If you use PPPoE Unnumber, please select this item, click the **Next** button and then go to Step 15 of this section.

### Connection Type - PPPoE

On the **PPPoE** screen, enter your User Name and Password as provided by your ISP. Click the **Finish** button to continue with setup.

GN-BR31NE-RH 2.4GHz AirCruiser N150 Wireless Router

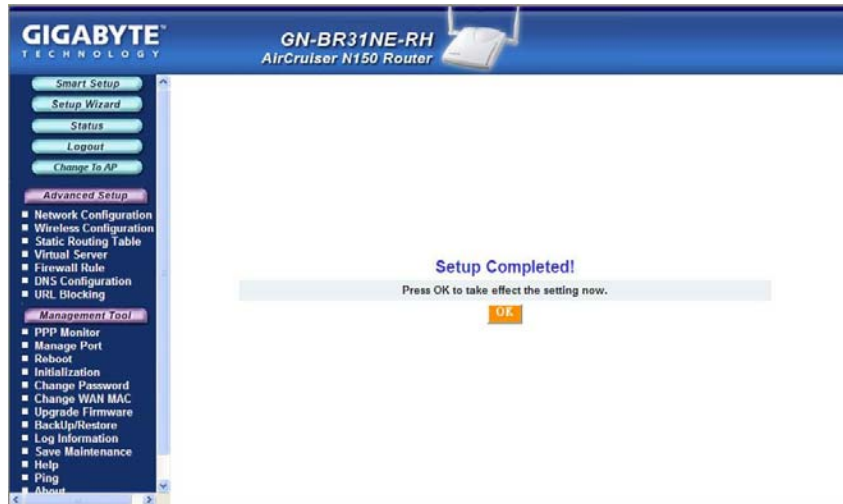

GN-BR31NE-RH 2.4GHz AirCruiser N150 Wireless Router

The **Setup Completed** screen appears. Click the **Reboot** button to restart your router so that the settings take effect.

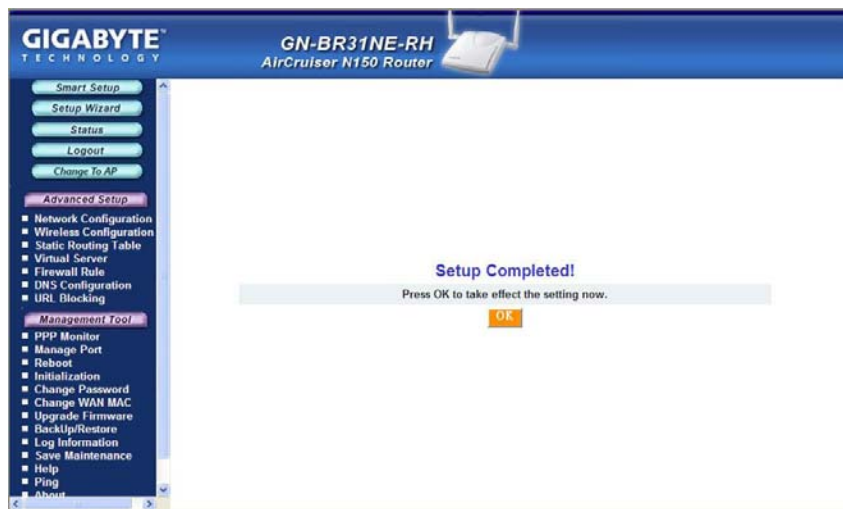

## GN-BR31NE-RH 2.4GHz AirCruiser N150 Wireless Router

While the router is rebooting, the Router Restarting Screen will display the time remaining. Please be patient and let the router restart itself.

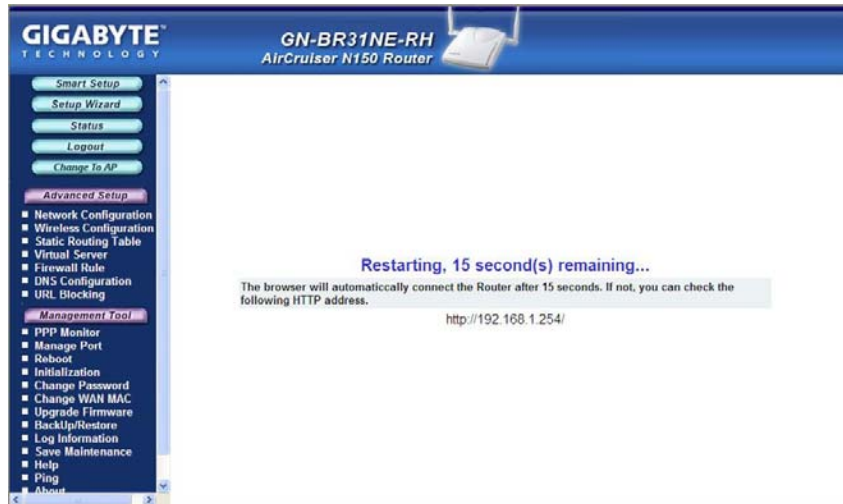

Once your router has successfully rebooted, it will load Router Welcome Screen. **Setup is complete.**

### Connection Type - Dynamic IP Address

If you have selected **Dynamic IP Address** ISP Type, the Dynamic IP Address Screen will display, prompting you for the ISP information. Enter it and click the **Finish** button to continue with router setup.



GN-BR31NE-RH 2.4GHz AirCruiser N150 Wireless Router

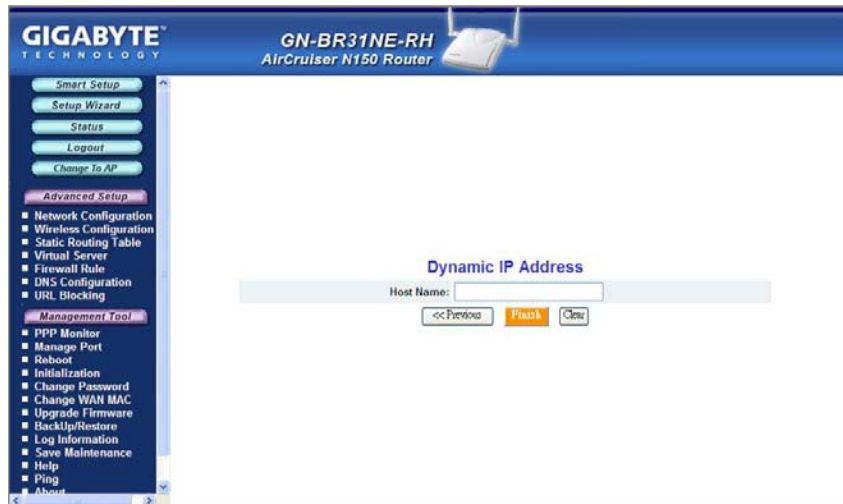

The **Setup Completed** appears. Click the **Reboot** button to restart your router so that the settings take effect

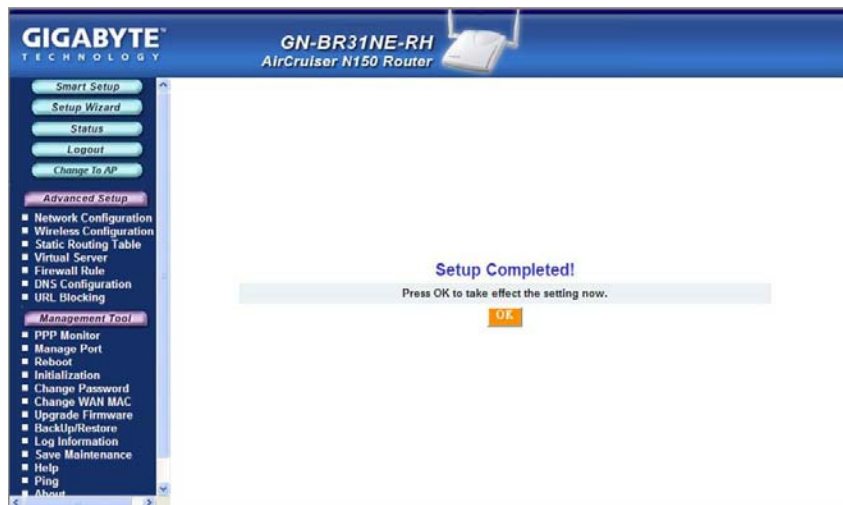

## GN-BR31NE-RH 2.4GHz AirCruiser N150 Wireless Router

While the router is rebooting, the **Router Restarting** screen will display the time remaining.

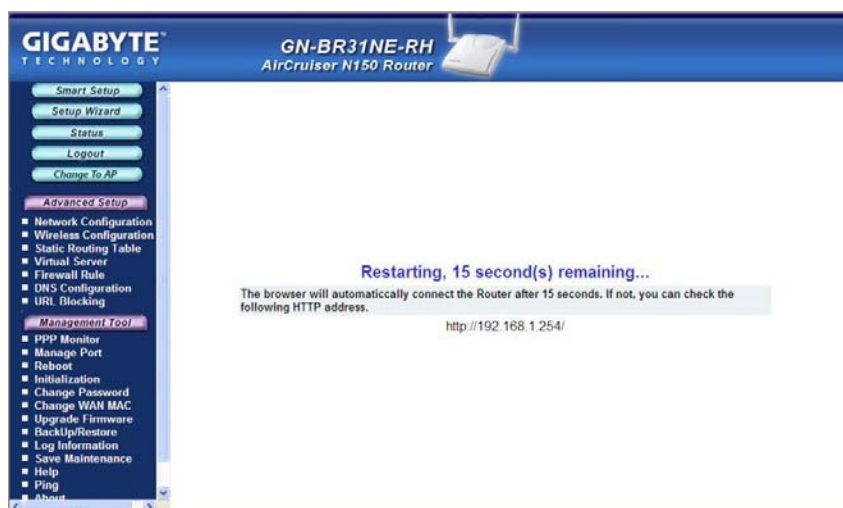

Once your router has successfully rebooted, it will load Router Welcome Screen. **Setup is complete.**

### Connection Type - Static IP Address

On the **Static IP Address** screen, type in the information provided by your ISP, and then click the **Finish** button to continue with router setup.

 If your ISP has assigned you several IP addresses, please enter only one.

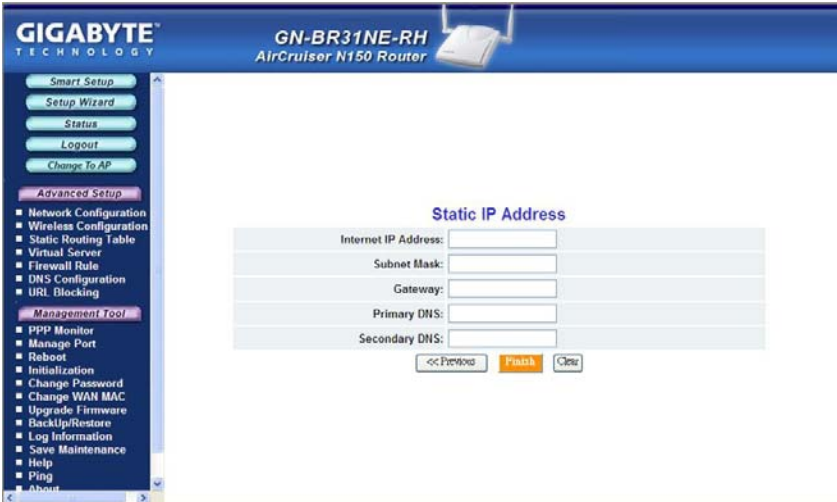

The screenshot shows the web interface of the GIGABYTE GN-BR31NE-RH AirCruiser N150 Router. The page title is "Static IP Address". The interface includes a navigation menu on the left with options like "Smart Setup", "Setup Wizard", "Status", "Logout", "Change To AP", "Advanced Setup", "Management Tool", and "About". The main content area contains five input fields for "Internet IP Address", "Subnet Mask", "Gateway", "Primary DNS", and "Secondary DNS". Below the fields are three buttons: "<< Previous", "Finish", and "Clear".

A screen with the message **Setup Completed** appears. Click the **Reboot** button to restart your router so that the settings take effect

GN-BR31NE-RH 2.4GHz AirCruiser N150 Wireless Router

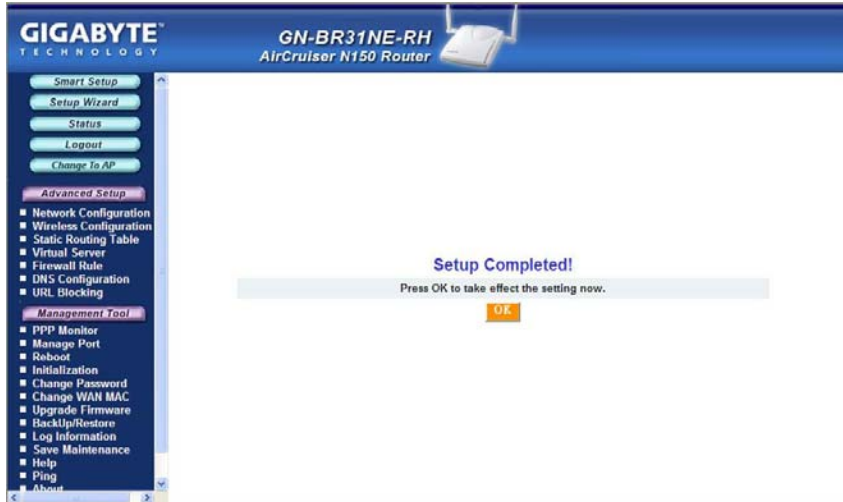

While the router is rebooting, the **Router Restarting** screen will display the time remaining.



Once your router has successfully rebooted, it will load Router Welcome Screen. **Setup is complete.**

## Appendix C Configuring TCP/IP Settings

Computers access the Internet using a protocol called TCP/IP (Transmission Control Protocol/ Internet Protocol). Each computer on your network must have TCP/IP installed and selected as its networking protocol. If a Network Interface Card (NIC) is already installed in your PC, then TCP/ IP is probably already installed as well. Please follow the steps in this chapter to assure the correct TCP/IP settings. For advanced users who know the TCP/IP settings are already correct, you may skip this section and proceed directly to **Chapter 6 Advanced Setup**.

### Enabling DHCP to Automatically Configure TCP/IP Settings

Each PC using accessing the wireless router must be assigned specific information about itself and resources that are available on its network. The simplest way to configure this is to allow the PC to automatically assign the IP by using a DHCP server. Follow the steps below to allow windows to automatically assign IP numbers for you.

- Step 1 Click the **Start** button. Select **Settings** and then click the **Control Panel** icon.

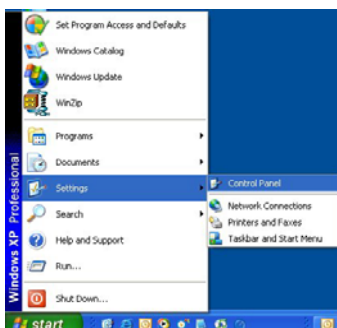

- Step 2 Double-click the **Network and Dial-up Connection** icon.

## GN-BR31NE-RH 2.4GHz AirCruiser N150 Wireless Router

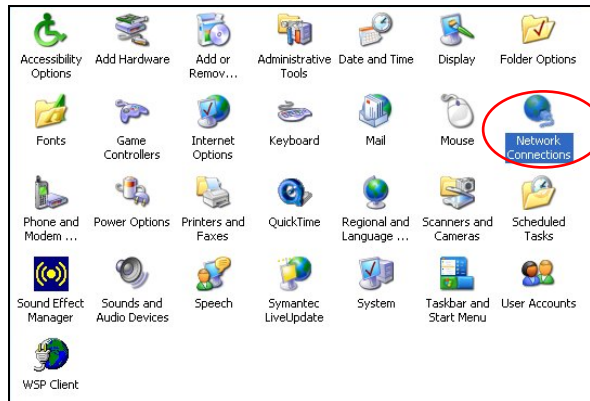

Step 3 Double-click the **Local Area Connection** icon, and then click the **Properties** button.

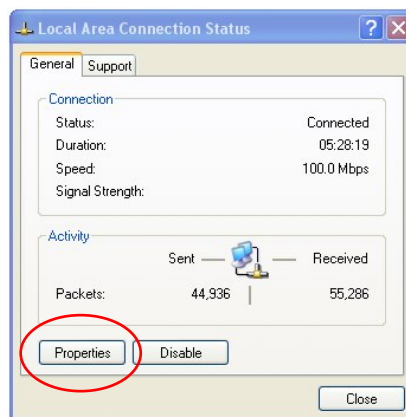

Step 4 The **Local Area Connection Properties** window will appear. For the applicable Ethernet / wireless adapter, make sure that there is a check in the **Internet Protocol (TCP/IP)** checkbox, then double-click on **Internet Protocol (TCP/IP)**

GN-BR31NE-RH 2.4GHz AirCruiser N150 Wireless Router

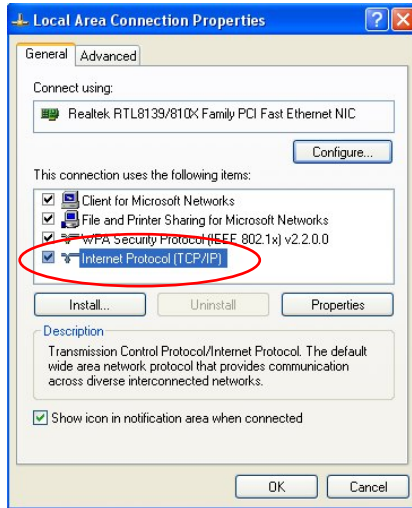

Step 5 Select both the **Obtain IP address automatically** and **Obtain DNS server address automatically**, options and then click **OK**. Continue clicking on the **OK** button to complete the PC configuration.

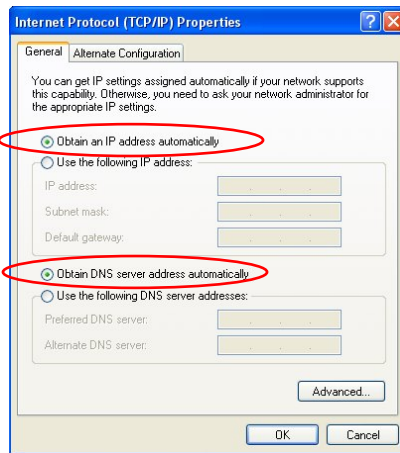

Windows will now automatically assign IP numbers to computers connecting to your GN-BR31NE-RH.

## Appendix D Troubleshooting

**Problem 1: Cannot connect to the Router's Web-based Utility.**

Response:

- Make sure that your Router uses DHCP, and make sure your PC's IP address is on the same subnet as the router.
- Check to see if your web browser is automatically detecting LAN settings.
- Try closing all web browsers and trying again.

**Make sure that your Router uses DHCP, and make sure your PC's IP address is on the same subnet as the router.**

Step 1 Click the **Start** button. Select **Run**, then type "command". Press OK.

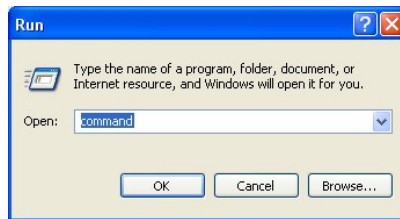

Step 2 At the command prompt, type "**ipconfig /release**" and press the **ENTER** key.

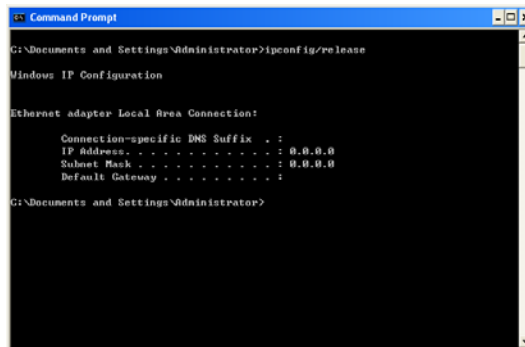

Step 3 At the next command prompt, type "**ipconfig /renew**" and press the **ENTER** key.



GN-BR31NE-RH 2.4GHz AirCruiser N150 Wireless Router

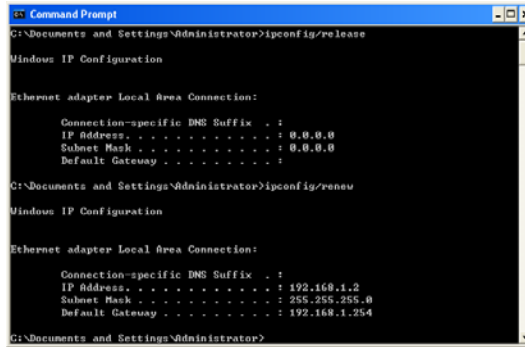

The default gateway represents the IP address of your GN-BR31NE-RH, that is: 192.168.1.254. All computers accessing this Router MUST be in the same subnet (192.168.1.x, where x is anything between 1 and 253)  
**In the above example, the GN-BR31NE-RH gateway shown above is 192.168.1.254, and the PC's IP address is 192.168.1.2**

---

**Check to see if your web browser is automatically detecting LAN settings**

- Step 1 Open **Internet Explorer**. From the menu select **Tools** and then click **Internet Options**.



GN-BR31NE-RH 2.4GHz AirCruiser N150 Wireless Router

Step 2 From the **Internet Options** window, click the **Connections** tab, and then click the **LAN Settings** button (see figure below).

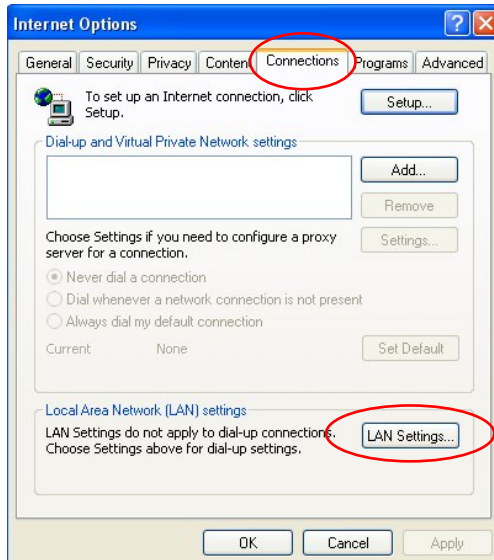

Step 3 Now verify that none of the checkboxes have been ticked, and click on the **OK** button. Now you will be able to login to the Router and configure or change network settings.

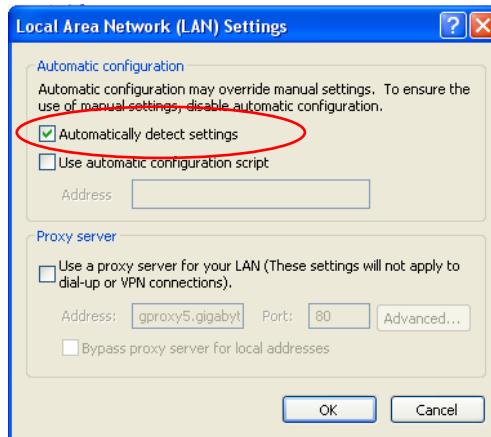

---

**Problem 2: I can't connect to the Internet**

GN-BR31NE-RH 2.4GHz AirCruiser N150 Wireless Router

Response :

- Check that the power cord is connected properly, and the router's power LED is lit green.
- Verify that all the TCP/IP configuration settings are correct. (Problem 1 above)
- Check that your ADSL/Cable Modem is operating normally, and/or you have ISP service available.
- Check that all network cabling is properly connected.

---

**Problem 3:      When I Configure WDS bridging, my Wi-Fi Protected Access (WPA) security is cancelled.**

Response:      Wi-Fi Protected Access (WPA) and Wireless Distribution System (WDS) cannot be used at the same time.

If you need to secure a WDS network, use the Wireless Encryption Protocol (WEP) feature instead.

If you must use WPA, connect your base stations to a wired local area network (LAN).

## Appendix E Glossary

### **ADSL**

Asymmetric digital subscriber line (ADSL) is a new modem technology that converts existing twisted-pair telephone lines into access paths for high-speed communication of various sorts.

### **Auto-MDI/MDIX**

On a network hub or switch, an auto-MDI/MDIX port automatically senses if it needs to act as a MDI or MDIX port. The auto-MDI/MDIX capability eliminates the need for crossover cables.

### **Auto-negotiate**

To automatically determine the correct setting. The term is often used with communications and networking

### **DHCP**

The Dynamic Host Configuration Protocol (DHCP) is an Internet protocol for automating the configuration of computers that use TCP/IP. DHCP can be used to automatically assign IP addresses, to deliver TCP/IP stack configuration parameters such as the subnet mask and default router, and to provide other configuration information such as the addresses for printer, time and news servers.

### **DMZ**

In computer networks, a DMZ (demilitarized zone) is a computer host or small network inserted as a "neutral zone" between a company's private network and the outside public network. It prevents outside users from getting direct access to a server that stores company data. Typically, the DMZ contains devices accessible to Internet traffic, such as Web (HTTP) servers, FTP servers, SMTP (e-mail) servers and DNS servers.

### **DNS**

The Domain Name System (DNS) is a distributed Internet directory service. DNS is used mostly to translate between domain names and IP addresses, and to control Internet email delivery. Most Internet services rely on DNS to work. If DNS fails, web sites cannot be located and email delivery service will be suspended.

### **Dynamic IP Address**

An IP address is automatically assigned to a user's AP in a TCP/IP network typically by a DHCP server.

### **Firewall**

A system designed to prevent unauthorized access to or from a private network. Firewalls can be implemented in both hardware and software, or a combination

of both. Firewalls are frequently used to prevent unauthorized Internet users from accessing private networks connected to the Internet, especially intranets. All messages entering or leaving the intranet pass through the firewall, which examines each message and blocks those that do not meet the specified security criteria.

**Gateway**

A device, usually a Router, that connects hosts on a local network to other networks.

**IP Address**

Every PC on the Internet has a unique identifying number, called an IP Address. A typical IP address looks like this: 216.27.61.137

**IPSec**

IPSec stands for IP Security. It provides authentication and encryption over the Internet. It functions at Layer 3 and thus secures everything on the network. It has become a standard protocol used for virtual private networks (VPNs).

**MAC Address**

On a local area network (LAN) or other network, the MAC (Media Access Control) address is your computer's unique hardware number. Usually written as: 01:23:45:67:89:ab

**MTU**

The size in bytes of the largest packet that can be sent or received.

**NAT**

A technique by which several hosts share a single IP address for accessing to the Internet.

**Ping (Packet Internet Groper)**

A utility to determine whether a specific IP address is accessible. It works by sending a packet to the specified address and waiting for a reply. PING is used primarily to troubleshoot Internet connections.

**SSID**

SSID is the name representing the Router in WLAN.

**PPPoE**

Point-to-Point over Ethernet is a protocol for connecting remote hosts to the Internet over an always-on connection by simulating a dial-up connection.

**Router**

A device that forwards data packets along networks. A router is connected to at least two networks, commonly two LANs or WANs or a LAN and its ISP network. Routers are located at gateways, the places where two or more networks connect.

**Subnet Mask**

A mask used to determine which subnet an IP address belongs to. An IP address has two components, the network address and the host address. Subnetting enables the network administrator to further divide the host part of the address into two or more subnets.

**TCP/IP**

TCP/IP (Transmission Control Protocol/Internet Protocol), the suite of communications protocols used to connect hosts on the Internet.

**VPN**

Virtual private networks are secured private network connections, built on top of publicly accessible infrastructure, such as the Internet or the public telephone network. VPNs typically employ some combination of encryption, digital certificates, strong user authentication and access control to provide security to the traffic they carry. They usually provide connectivity to many machines behind a gateway or firewall.

**WAN**

Wide Area Network, a communication network that covers a relatively broad geographic area, consisting of two or more LANs. Broadband communication over the WAN is often through public networks such as the ADSL or Cable systems, or through leased lines or satellites. To simplify it, please image network as a WAN.

**WEP**

WEP (Wired Equivalent Privacy) is a data privacy mechanism based on a 64/128-bit shared key algorithm, as described in the IEEE 802.11 standard.

## Appendix F Specifications

<b>General</b>	
<b>Standards</b>	IEEE 802.3 (10BaseT), IEEE 802.3u (100BaseTX), IEEE 802.11b/g/n (Wireless)
<b>Ports / Buttons</b>	LAN – 4 ports 10/100 Ethernet (auto-MDIX), RJ-45 WAN - 10/100 Ethernet (auto-MDIX), RJ-45 One Init (Reset) button One WPS/WLAN button
<b>Power</b>	External; 5V DC, 2A
<b>Wireless</b>	
<b>Frequency Band</b>	2412 ~ 2484 MHz (subject to local regulation)
<b>Modulation Technology</b>	OFDM and DSSS
<b>Modulation Techniques</b>	64QAM, 16QAM, QPSK, BPSK, DBPSK, DQPSK, CCK
<b>Data Rates</b>	300, 270, 243, 216, 162, 135, 121.5, 108, 81, 54, 48, 36, 27, 24, 18, 13.5, 12, 11, 9, 6, 5.5, 2, 1 Mbps, auto fallback
<b>Average power</b>	Legacy mode: 19 dBm @11b, 15 dBm @11g; HT20 mode: 15 dBm @MCS7/15 ; HT40 mode: 15 dBm @MCS7 /15.
<b>Receive Sensitivity</b>	Legacy mode: -91 dBm @11b, -77 dBm @11g; HT20 mode: -72 dBm @ MCS7/15; HT40 mode: -68 dBm @ MCS7/15.
<b>Antenna</b>	2 external dipole antennas
<b>Wireless Range</b>	<i>Outdoor:</i> 100 to 300m <i>Indoor:</i> 30 to 100m
<b>Regulatory and Environmental Compliance</b>	
<b>EMC certification</b>	FCC part 15 (USA)   NCC (Taiwan) CE(Europe)
<b>Temperature Range</b>	Operating: 0 ~ 55 degree C, Storage: -20 ~ 65 degree C
<b>Humidity</b>	10% ~ 85% Non-condensing
<b>Protocols</b>	
<b>Routing Protocols</b>	Dynamic, Static Routing with TCP/IP NAT, PPTP, PPPoE VPN Pass-Through (IPSec, L2TP) DHCP (Client & Server)
<b>Security</b>	64/128 bit WEP; WPA-PSK; WPA
<b>Mechanical</b>	
<b>LEDs</b>	Power/Status; WLAN; LAN (1-4); WAN
<b>Gross Weight</b>	290± 5g
<b>Dimensions</b>	140 mm x 178 mm x 43 mm ± 0.5mm

## Appendix G Warranty

### **Limited Warranty Statement (1-Year Warranty)**

Thank you for purchasing the GIGABYTE Product. This limited warranty statement will provide you one year warranty starting from the purchase date. Of which if any defect is occurred due to accidents or any man-made factors, or any unauthorized torn-off or damage to GIGABYTE's sticker on the product, GIGABYTE Technology will not provide after-sale services, such as:

- Products are damaged due to any violation of instructions on user manual.
- Hardware is damaged due to inappropriate assembling.
- Products are damaged due to the use of illegal accessory.
- Products are damaged due to parts disassembling without authorization.
- Products are damaged due to exceeding environment limits.
- Products are damaged due to unexpected external force.
- Products are damaged due to nature disasters.
- Products are copies or illegally smuggled goods.



## Appendix H Regulatory Information

**CE Mark Warning:** This is a Class B product. In a domestic environment, this product may cause radio interference, in which case the user may be required to take adequate measures.

**FCC Statement:** This equipment has been tested and found to comply with the limits for a Class B digital device, pursuant to Part 15 of the FCC Rules. These limits are designed to provide reasonable protection against harmful interference in a residential installation. This equipment generates, uses and can radiate radio frequency energy and, if not installed and used in accordance with the instructions, may cause harmful interference to radio communications. However, there is no guarantee that interference will not occur in a particular installation. If this equipment does cause harmful interference to radio or television reception, which can be determined by turning the equipment off and on, the user is encouraged to try to correct the interference by one of the following measures:

- Reorient or relocate the receiving antenna.
- Increase the separation between the equipment and receiver.
- Connect the equipment into an outlet on a circuit different from that to which the receiver is connected.
- Consult the dealer or an experienced radio/TV technician for help.

**FCC Caution:** To assure continued compliance, any changes or modifications not expressly approved by the party responsible for compliance could void the user authority to operate this equipment.

This device complies with Part 15 of the FCC Rules. Operation is subject to the following two conditions: (1) This device may not cause harmful interference, and (2) this device must accept any interference received, including interference that may cause undesired operation.

**IMPORTANT NOTE:**

**FCC Radiation Exposure Statement:**

This equipment complies with FCC radiation exposure limits set forth for an uncontrolled environment. This equipment should be installed and operated with minimum distance 20cm between the radiator & your body. The antenna(s) used for this transmitter must not be co-located or operating in conjunction with any other antenna or transmitter.

### Europe - Declaration of Conformity

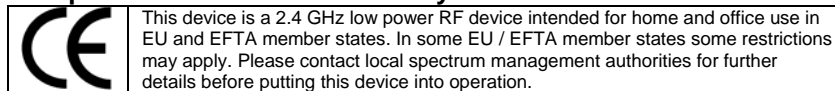

GIGA-BYTE Technology, Inc. declares that the product: **Wireless Broadband Router Model Number: GN-BR31NE-RH** is in conformity with and in accordance with the European Directive of EMC, 89/336 EEC for the following sections:

EN 61000-3-2, EN 61000-3-3, EN 55024, and EN 55022 Disturbances and Immunities

GIGA-BYTE Technology, Inc. also declares the conformity of above mentioned product with the actual required safety standards in accordance with LVD Directive 73/23 EEC:

EN 60950 Safety

In accordance with R&TTE Directive 1995/5/EC, Part 17: Requirements for Operation in the European Community, GIGA-BYTE Technology, Inc declares the conformity of the above mentioned products

## GN-BR31NE-RH 2.4GHz AirCruiser N150 Wireless Router

for:

EN 300 328-2 V1.2.1, ETSI EN 300 328-1 : V1.3.1, EN 301 489-1, and EN 301 489-17 Technical Requirements for Radio Equipment

### **Countries of Operation and Conditions of Use in the European Community**

The user should run the configuration utility program provided with this product to check the current channel of operation and confirm that the device is operating in conformance with the spectrum usage rules for European Community countries as described in this section. European standards dictate a maximum radiated transmit power of 100mW EIRP and a frequency range of 2.400 - 2.4835 Ghz.

### **Operation using 2.4 GHz Channels in France**

2.4 GHz Bande: les canaux 10, 11, 12, 13 (2457, 2462, 2467, et 2472 MHz respectivement) sont complètement libres d'utilisation en France (en utilisation intérieur). Pour ce qui est des autres canaux, ils peuvent être soumis à autorisation selon le département. L'utilisation en extérieur est soumise à autorisation préalable et très restreinte. Vous pouvez contacter l'Autorité de Régulation des Télécommunications (<http://www.art-telecom.fr>) pour de plus amples renseignements.

Please check ART's web site for latest requirements for use of the 2.4GHz band in France:  
<http://www.art-telecom.fr/eng/index.htm>.

When operating in France, this device may be operated under the following conditions:  
Indoors only, using any channel in the 2.4465-2.4835 GHz band.

**Trademarks:** GIGABYTE is a registered trademark of GIGA-BYTE Technology, Inc. Other trademarks or registered trademarks are the property of their respective manufacturers or owners.

**Copyright Statement:** No part of this publication or documentation accompanying this Product may be reproduced in any form or by any means or used to make any derivative such as translation, transformation, or adaptation without permission from GIGABYTE/GIGA-BYTE Technology, Inc., as stipulated by the United States Copyright Act of 1976. Contents are subject to change without prior notice. Copyright© 2004 by GIGA-BYTE Technology, Inc. All rights reserved.

### 第十二條

型式認證合格之低功率射頻電機，非經許可，公司、商號或使用者均不得擅自變更頻率、加大功率或變更原設計之特性及功能。

### 第十四條

低功率射頻電機之使用不得影響飛航安全及干擾合法通信；經發現有干擾現象時，應立即停用，並改善至無干擾時方得繼續使用。

前項合法通信，指依電信法規定作業之無線電通信。

低功率射頻電機須忍受合法通信或工業、科學及醫療用電波輻射性電機設備之干擾。

# Appendix I

## General Public License

### Licensing Information

This product includes copyrighted software license owned by third-party under terms of the GNU General Public License. Texts of the GPL are included with every CD shipped with our product. All future firmware updates will also be accompanied with their related source code on our website.

Please refer to the following GNU General Public License for further details of this License.

Specially, the parts of this product listed below are subject to the GNU General Public License.

1. The Linux operating system kernel
2. The iptables packet filter and NAT software
3. The busybox swiss army knife of embedded linux
4. The udhcpd DHCP client/server implementation
5. The rp-pppoe PPPoE client implementation
6. The pppd PPP daemon implementation
7. The ez-ipupdate ddns implementation

The Copyright for All listed Software packages are owned by their respective authors, please refer to the source code via our website for further details.

### Availability of Source Code

Gigabyte Tech. has provided the full Source Code of the GPL Licensed Software on our website. All future firmware updates will also be accompanied with their related source code.

### GNU GENERAL PUBLIC LICENSE

Version 2, June 1991  
Copyright (C) 1989, 1991 Free Software Foundation, Inc.  
59 Temple Place - Suite 330, Boston, MA 02111-1307, USA

Everyone is permitted to copy and distribute verbatim copies of this license document, but changing it is not allowed.

#### Preamble

The licenses for most software are designed to take away your freedom to share and change it. By contrast, the GNU General Public License is intended to guarantee your freedom to share and change free software--to make sure the software is free for all its users. This General Public License applies to most of the Free Software Foundation's software and to any other program whose authors commit to using it. (Some other Free Software Foundation software is covered by the GNU Library General Public License instead.) You can apply it to your programs, too.

When we speak of free software, we are referring to freedom, not price. Our General Public Licenses are designed to make sure that you have the freedom to distribute copies of free software (and charge for this service if you wish), that you receive source code or can get it if you want it, that you can change the software or use pieces of it in new free programs; and that you know you can do these things.

To protect your rights, we need to make restrictions that forbid anyone to deny you these rights or to ask you to surrender the rights. These restrictions translate to certain responsibilities for you if you distribute copies of the software, or if you modify it.

For example, if you distribute copies of such a program, whether gratis or for a fee, you must give the recipients all the rights that you have. You must make sure that they, too, receive or can get the source code. And you must show them these terms so they know their rights.

## GN-BR31NE-RH 2.4GHz AirCruiser N150 Wireless Router

We protect your rights with two steps: (1) copyright the software, and (2) offer you this license which gives you legal permission to copy, distribute and/or modify the software.

Also, for each author's protection and ours, we want to make certain that everyone understands that there is no warranty for this free software. If the software is modified by someone else and passed on, we want its recipients to know that what they have is not the original, so that any problems introduced by others will not reflect on the original authors' reputations.

Finally, any free program is threatened constantly by software patents. We wish to avoid the danger that redistributors of a free program will individually obtain patent licenses, in effect making the program proprietary. To prevent this, we have made it clear that any patent must be licensed for everyone's free use or not licensed at all.

The precise terms and conditions for copying, distribution and modification follow.

### TERMS AND CONDITIONS FOR COPYING, DISTRIBUTION AND MODIFICATION

0. This License applies to any program or other work which contains a notice placed by the copyright holder saying it may be distributed under the terms of this General Public License. The "Program", below, refers to any such program or work, and a "work based on the Program" means either the Program or any derivative work under copyright law: that is to say, a work containing the Program or a portion of it, either verbatim or with modifications and/or translated into another language. (Hereinafter, translation is included without limitation in the term "modification".) Each licensee is addressed as "you".

Activities other than copying, distribution and modification are not covered by this License; they are outside its scope. The act of running the Program is not restricted, and the output from the Program is covered only if its contents constitute a work based on the Program (independent of having been made by running the Program). Whether that is true depends on what the Program does.

1. You may copy and distribute verbatim copies of the Program's source code as you receive it, in any medium, provided that you conspicuously and appropriately publish on each copy an appropriate copyright notice and disclaimer of warranty; keep intact all the notices that refer to this License and to the absence of any warranty; and give any other recipients of the Program a copy of this License along with the Program.

You may charge a fee for the physical act of transferring a copy, and you may at your option offer warranty protection in exchange for a fee.

2. You may modify your copy or copies of the Program or any portion of it, thus forming a work based on the Program, and copy and distribute such modifications or work under the terms of Section 1 above, provided that you also meet all of these conditions:

- a) You must cause the modified files to carry prominent notices stating that you changed the files and the date of any change.
- b) You must cause any work that you distribute or publish, that in whole or in part contains or is derived from the Program or any part thereof, to be licensed as a whole at no charge to all third parties under the terms of this License.
- c) If the modified program normally reads commands interactively when run, you must cause it, when started running for such interactive use in the most ordinary way, to print or display an announcement including an appropriate copyright notice and a notice that there is no warranty (or else, saying that you provide a warranty) and that users may redistribute the program under these conditions, and telling the user how to view a copy of this License. (Exception: if the Program itself is interactive but does not normally print such an announcement, your work based on the Program is not required to print an announcement.)

These requirements apply to the modified work as a whole. If identifiable sections of that work are not derived from the Program, and can be reasonably considered independent and separate works in themselves, then this License, and its terms, do not apply to those sections when you distribute them as separate works. But when you distribute the same sections as part of a whole which is a work based on the Program, the distribution of the whole must be on the terms of this License, whose permissions for other licensees extend to the entire whole, and thus to each and every part regardless of who wrote it.

Thus, it is not the intent of this section to claim rights or contest your rights to work written entirely by you; rather, the intent is to exercise the right to control the distribution of derivative or collective works based on the Program.

In addition, mere aggregation of another work not based on the Program with the Program (or with a work based on the Program) on a volume of a storage or distribution medium does not bring the other work under the scope of this License.

3. You may copy and distribute the Program (or a work based on it, under Section 2) in object code or executable form under the terms of Sections 1 and 2 above provided that you also do one of the

## GN-BR31NE-RH 2.4GHz AirCruiser N150 Wireless Router

following:

a) Accompany it with the complete corresponding machine-readable source code, which must be distributed under the terms of Sections 1 and 2 above on a medium customarily used for software interchange; or,

b) Accompany it with a written offer, valid for at least three years, to give any third party, for a charge no more than your cost of physically performing source distribution, a complete machine-readable copy of the corresponding source code, to be distributed under the terms of Sections 1 and 2 above on a medium customarily used for software interchange; or,

c) Accompany it with the information you received as to the offer to distribute corresponding source code. (This alternative is allowed only for noncommercial distribution and only if you received the program in object code or executable form with such an offer, in accord with Subsection b above.)

The source code for a work means the preferred form of the work for making modifications to it. For an executable work, complete source code means all the source code for all modules it contains, plus any associated interface definition files, plus the scripts used to control compilation and installation of the executable. However, as a special exception, the source code distributed need not include anything that is normally distributed (in either source or binary form) with the major components (compiler, kernel, and so on) of the operating system on which the executable runs, unless that component itself accompanies the executable.

If distribution of executable or object code is made by offering access to copy from a designated place, then offering equivalent access to copy the source code from the same place counts as distribution of the source code, even though third parties are not compelled to copy the source along with the object code.

4. You may not copy, modify, sublicense, or distribute the Program except as expressly provided under this License. Any attempt otherwise to copy, modify, sublicense or distribute the Program is void, and will automatically terminate your rights under this License. However, parties who have received copies, or rights, from you under this License will not have their licenses terminated so long as such parties remain in full compliance.

5. You are not required to accept this License, since you have not signed it. However, nothing else grants you permission to modify or distribute the Program or its derivative works. These actions are prohibited by law if you do not accept this License. Therefore, by modifying or distributing the Program (or any work based on the Program), you indicate your acceptance of this License to do so, and all its terms and conditions for copying, distributing or modifying the Program or works based on it.

6. Each time you redistribute the Program (or any work based on the Program), the recipient automatically receives a license from the original licensor to copy, distribute or modify the Program subject to these terms and conditions. You may not impose any further restrictions on the recipients' exercise of the rights granted herein. You are not responsible for enforcing compliance by third parties to this License.

7. If, as a consequence of a court judgment or allegation of patent infringement or for any other reason (not limited to patent issues), conditions are imposed on you (whether by court order, agreement or otherwise) that contradict the conditions of this License, they do not excuse you from the conditions of this License. If you cannot distribute so as to satisfy simultaneously your obligations under this License and any other pertinent obligations, then as a consequence you may not distribute the Program at all. For example, if a patent license would not permit royalty-free redistribution of the Program by all those who receive copies directly or indirectly through you, then the only way you could satisfy both it and this License would be to refrain entirely from distribution of the Program.

If any portion of this section is held invalid or unenforceable under any particular circumstance, the balance of the section is intended to apply and the section as a whole is intended to apply in other circumstances.

It is not the purpose of this section to induce you to infringe any patents or other property right claims or to contest validity of any such claims; this section has the sole purpose of protecting the integrity of the free software distribution system, which is implemented by public license practices. Many people have made generous contributions to the wide range of software distributed through that system in reliance on consistent application of that system; it is up to the author/donor to decide if he or she is willing to distribute software through any other system and a licensee cannot impose that choice. This section is intended to make thoroughly clear what is believed to be a consequence of the rest of this License.

8. If the distribution and/or use of the Program is restricted in certain countries either by patents or by copyrighted interfaces, the original copyright holder who places the Program under this License may add an explicit geographical distribution limitation excluding those countries, so that distribution is permitted only in or among countries not thus excluded. In such case, this License incorporates the limitation as if written in the body of this License.

9. The Free Software Foundation may publish revised and/or new versions of the General Public License from time to time. Such new versions will be similar in spirit to the present version, but may

## GN-BR31NE-RH 2.4GHz AirCruiser N150 Wireless Router

differ in detail to address new problems or concerns.

Each version is given a distinguishing version number. If the Program specifies a version number of this License which applies to it and "any later version", you have the option of following the terms and conditions either of that version or of any later version published by the Free Software Foundation. If the Program does not specify a version number of this License, you may choose any version ever published by the Free Software Foundation.

10. If you wish to incorporate parts of the Program into other free programs whose distribution conditions are different, write to the author to ask for permission. For software which is copyrighted by the Free Software Foundation, write to the Free Software Foundation; we sometimes make exceptions for this. Our decision will be guided by the two goals of preserving the free status of all derivatives of our free software and of promoting the sharing and reuse of software generally.

### **NO WARRANTY**

11. BECAUSE THE PROGRAM IS LICENSED FREE OF CHARGE, THERE IS NO WARRANTY FOR THE PROGRAM, TO THE EXTENT PERMITTED BY APPLICABLE LAW. EXCEPT WHEN OTHERWISE STATED IN WRITING THE COPYRIGHT HOLDERS AND/OR OTHER PARTIES PROVIDE THE PROGRAM "AS IS" WITHOUT WARRANTY OF ANY KIND, EITHER EXPRESSED OR IMPLIED, INCLUDING, BUT NOT LIMITED TO, THE IMPLIED WARRANTIES OF MERCHANTABILITY AND FITNESS FOR A PARTICULAR PURPOSE. THE ENTIRE RISK AS TO THE QUALITY AND PERFORMANCE OF THE PROGRAM IS WITH YOU. SHOULD THE PROGRAM PROVE DEFECTIVE, YOU ASSUME THE COST OF ALL NECESSARY SERVICING, REPAIR OR CORRECTION.

12. IN NO EVENT UNLESS REQUIRED BY APPLICABLE LAW OR AGREED TO IN WRITING WILL ANY COPYRIGHT HOLDER, OR ANY OTHER PARTY WHO MAY MODIFY AND/OR REDISTRIBUTE THE PROGRAM AS PERMITTED ABOVE, BE LIABLE TO YOU FOR DAMAGES, INCLUDING ANY GENERAL, SPECIAL, INCIDENTAL OR CONSEQUENTIAL DAMAGES ARISING OUT OF THE USE OR INABILITY TO USE THE PROGRAM (INCLUDING BUT NOT LIMITED TO LOSS OF DATA OR DATA BEING RENDERED INACCURATE OR LOSSES SUSTAINED BY YOU OR THIRD PARTIES OR A FAILURE OF THE PROGRAM TO OPERATE WITH ANY OTHER PROGRAMS), EVEN IF SUCH HOLDER OR OTHER PARTY HAS BEEN ADVISED OF THE POSSIBILITY OF SUCH DAMAGES.

END OF TERMS AND CONDITIONS

### How to Apply These Terms to Your New Programs

If you develop a new program, and you want it to be of the greatest possible use to the public, the best way to achieve this is to make it free software which everyone can redistribute and change under these terms.

To do so, attach the following notices to the program. It is safest to attach them to the start of each source file to most effectively convey the exclusion of warranty; and each file should have at least the "copyright" line and a pointer to where the full notice is found.

*one line to give the program's name and an idea of what it does.*

Copyright (C) yyyy *name of author*

This program is free software; you can redistribute it and/or modify it under the terms of the GNU General Public License as published by the Free Software Foundation; either version 2 of the License, or (at your option) any later version.

This program is distributed in the hope that it will be useful, but WITHOUT ANY WARRANTY; without even the implied warranty of MERCHANTABILITY or FITNESS FOR A PARTICULAR PURPOSE. See the GNU General Public License for more details.

You should have received a copy of the GNU General Public License along with this program; if not, write to the Free Software Foundation, Inc., 59 Temple Place - Suite 330, Boston, MA 02111-1307, USA. Also add information on how to contact you by electronic and paper mail.

If the program is interactive, make it output a short notice like this when it starts in an interactive mode:

Gnomovision version 69, Copyright (C) *year name of author*

Gnomovision comes with ABSOLUTELY NO WARRANTY; for details

type `show w'. This is free software, and you are welcome

to redistribute it under certain conditions; type `show c'

GN-BR31NE-RH 2.4GHz AirCruiser N150 Wireless Router

for details.

The hypothetical commands `show w` and `show c` should show the appropriate parts of the General Public License. Of course, the commands you use may be called something other than `show w` and `show c`; they could even be mouse-clicks or menu items--whatever suits your program. You should also get your employer (if you work as a programmer) or your school, if any, to sign a "copyright disclaimer" for the program, if necessary. Here is a sample; alter the names:

Yoyodyne, Inc., hereby disclaims all copyright interest in the program `Gnomovision' (which makes passes at compilers) written by James Hacker.  
*signature of Ty Coon*, 1 April 1989  
Ty Coon, President of Vice

This General Public License does not permit incorporating your program into proprietary programs. If your program is a subroutine library, you may consider it more useful to permit linking proprietary applications with the library. If this is what you want to do, use the GNU Lesser General Public License instead of this License.

**PLEASE RECORD THE FOLLOWING INFORMATION REGARDING YOUR WARRANTY**

<b>Name of Customer:</b>	
<b>Phone No:</b>	
<b>Address:</b>	
<b>Email:</b>	
<b>Model:</b>	
<b>Serial:</b>	
<b>Date of Purchase:</b>	
<b>Place of Purchase:</b>	
<b>From Whom:</b>	
<b>Distributor:</b>	

**Customer Service**

**GIGA-BYTE TECHNOLOGY CO., LTD.**  
No.6, Bau Chiang Road, Hsin-Tien,  
Taipei Hsien, Taiwan.  
Tel: 886-2-89124888 Fax:886-2-89124007  
<http://www.GIGABYTE.com.tw>