

Copyright © 2010 by GIGABYTE TECHNOLOGY CO., LTD.  
All rights reserved.

GIGABYTE T1125 Series Notebook Computer User's Manual  
Release Edition: 2010/ 10

This manual guides you in setting up and using your new notebook.  
Information in the manual has been carefully checked for accuracy and is subject to change without notice.

No part of this manual may be reproduced, stored in a retrieval system, or transmitted, in any form or by any means, electronic, mechanical, by photocopy, recording, or otherwise, without prior written consent from GIGABYTE.

#### Trademarks

GIGABYTE™ is registered trademarks of GIGABYTE Technology.

All other brands or product names mentioned in this manual are trademarks or registered trademarks of their respective companies.

## Safety Instructions

Use the following safety guidelines to help protect yourself and your notebook.

### When Using Your T1125 Notebook Computer



**CAUTION:** Do not operate your portable computer for an extended period of time with the base resting directly on your body. With extended operation, heat can build up in the base. Allowing sustained contact with the skin can cause discomfort or a possible burn.

- Do not attempt to service the notebook yourself. Always follow installation instructions closely.
- Do not carry a battery in your pocket, purse, or other container where metal objects (such as car keys) could short-circuit the battery terminals. The resulting excessive current flow can generate extremely high temperature and may cause burns to your skin.
- Be sure that nothing rests on your AC adapter's power cable and that the cable is not located where it can be tripped over or stepped on.
- While you are using the computer or charging the battery, place the AC adapter in a ventilated area, like on a desktop or on the floor. Do not cover the AC adapter with papers or other items that may prevent ventilation. Also, do not use the AC adapter while it is inside a carrying case.
- Do not insert objects into the air vent of your notebook computer. Doing so can cause short-circuiting and may result in fire or electrical shock.
- Use only the AC adapter and batteries that are supplied by your notebook manufacturer. Using other types of battery or AC adapter may heighten the risk of fire or explosion.
- Incorrectly installed or placed batteries may result in an explosion.
- Replace only with the same or a compatible battery recommended by the manufacturer.
- Please discard used batteries according to the manufacturer's instructions.
- Before you connect your notebook to a power source, ensure that the voltage rating of the AC adapter matches that of the available power source.
  - 115 V/60 Hz in most of North and South America and some Far Eastern countries such as South Korea.
  - 100 V/50 Hz in eastern Japan and 100 V/60Hz in western Japan.
  - 230 V/50 Hz in most of Europe, the Middle East, and the Far East.
- If you use an extension cord with your AC adapter, ensure that the total ampere rating of all devices plugged into the extension cord does not exceed its total capacity.
- When removing a battery from your notebook, first turn off the system, disconnect the AC adapter from the electrical outlet, and then remove the battery.
- To avoid risk of an electrical shock, do not connect or disconnect any cables, or perform any maintenance or reconfiguration of this product during a thunderstorm.
- Do not throw batteries into a fire, doing so may cause explosion. Check with local authorities first for battery disposal instructions.
- When setting up your notebook for work, place it on a level surface.

- When traveling, do not check your notebook as baggage. You can put your notebook through an X-ray security machine, but never put your notebook through a metal detector. If you have your notebook checked by hand, be sure to have a charged battery ready in case you are asked to turn on your notebook.
- When traveling with the hard drive removed from your notebook, wrap the drive in an insulated material, such as cloth or paper. If you have the drive checked by hand, you may be asked to install the drive into your notebook. You can have the hard drive checked through an X-ray machine, but never put the drive through a metal detector.
- When traveling, do not place your notebook in the overhead storage compartment where it could shift around. Do not drop your notebook or subject it to other mechanical shocks.
- Protect your notebook, battery, and hard drive from environmental hazards such as dirt, dust, food, liquids, extreme temperature, and direct exposure to sunlight.
- When you move your notebook in environments where there is a substantial difference of temperature or humidity level, condensation may form on or within your notebook. To avoid damaging your notebook, please allow sufficient time for the moisture to evaporate before continuing use of the notebook.

*NOTICE: When taking your notebook from a colder to a warmer environment or vice versa, allow your notebook enough time to adapt to the new environment before turning on power.*

- When unplugging the power cord, please make sure that you pull on its connector or on its strain relief loop, and not on the power cord itself. As you pull out the connector, please ensure

that it is pulled out evenly in order not to bend its connecting pins. Also, before you connect the power cord, make sure that both connectors are correctly oriented and aligned.

- Before you clean your notebook, turn it off first, unplug it from its power source, and remove the battery.
- Handle interior components with care. When removing a component, please hold it by the edge and not on the connecting pins (such as the memory module).

When using your telephone equipments, safety instructions should always be followed in order to prevent fire, electrical shock or injuries, these instructions include:

- Do not use this product near water, for example, near a bathtub, washing basins, kitchen/laundry sinks, wet basements or swimming pools.
- Avoid using cordless phones during an electrical storm as lightning may cause electrical shocks.
- Do not use the telephone to report a gas leak within the leakage area.

#### WARNING: Voiding of the Warranty

- \* If the battery is not properly handled, there may be a risk of explosion; make sure you are using the same or compatible battery.
- \* Please discard used batteries according to the instructions given by the manufacturer.
- \* Please be aware that use of cracked, severely scratched or poor quality discs may damage the optical drive and corrupt data in the disc. Such discs may break while drive operates in high-speed, in this case, your product warranty may be voided.

## Regulatory Notices

### Federal Communications Commission Notice

This equipment has been tested and found to comply with the limits for a Class B digital service, pursuant to Part 15 of the FCC rules. These limits are designed to provide reasonable protection against harmful interference in a residential installation.

Any changes or modifications made to this equipment may void the user's authority to operate this equipment. This equipment generates, uses, and can radiate radio frequency energy. If not installed and used in accordance with the instructions, may cause harmful interference to radio communications. However, there is no guarantee that interference will not occur in a particular installation. If this equipment does cause harmful interference to radio or television reception, which can be determined by turning the equipment off and on, the user is encouraged to try to correct the interference by one or more of the following measures:

- Reorient or relocate the receiving antenna.
- Increase the separation between the equipment and receiver.
- Connect the equipment into an outlet on a circuit different from that to which the receiver is connected.
- Consult the dealer or an experienced radio/TV technician for help.
- All external cables connecting to this basic unit must be shielded.

For cables connecting to PCMCIA cards, see the option manual or installation instructions.

### RF Exposure

This equipment must be installed and operated in accordance with provided instructions and must not be co-located or operating in conjunction with any other antenna or transmitter. End-users and installers must be provide with antenna installation instructions and transmitter operating conditions for satisfying RF exposure compliance.

## CE Notice (European Union)

This symbol  indicates this T1125 notebook complies with the EMC Directive and the European Union's Low Voltage Directive. This symbol also indicates that T1125 meets the following technical standards:

- EN 55022 — “Limitations and Methods of Measurement for the Radio Interferences of Information Technology Equipment.”
- EN 55024 — “Information technology equipment - Immunity characteristics - Limits and methods of measurement.”
- EN 61000-3-2 — “Electromagnetic compatibility (EMC) - Chapter 3: Limits - Section 2: Limits on the harmonic current emissions (Equipment input current up to and including 16 A per phase).”
- EN 61000-3-3 — “Electromagnetic compatibility (EMC) - Chapter 3: Limits - Section 3: Limits on the voltage fluctuations and flicker in low-voltage power supply systems for equipment with rate current up to and including 16 A.”
- EN 60950 — “Safety of Information Technology Equipment.”



NOTE: EN 55022 emissions requirements provide for two classifications

- Class A governs commercial use
- Class B is governs residential use

### For CB:

- Only use batteries designed for this computer. The wrong battery type may explode, leak or damage the computer

- Do not remove any batteries from the computer while it is powered on
- Do not continue to use a battery that has been dropped, or that appears damaged (e.g. bent or twisted) in any way. Even if the computer continues to work with a damaged battery in place, it may cause circuit damage, which may possibly result in fire.
- Recharge the batteries using the notebook's system. Incorrect recharging may make the battery explode.
- Do not try to repair a battery pack. Refer any battery pack repair or replacement to your service representative or qualified service personnel.
- Keep children away from, and promptly dispose of a damaged battery. Always dispose of batteries carefully. Batteries may explode or leak if exposed to fire, or improperly handled or discarded.
- Keep the battery away from metal appliances.
- Affix tape to the battery contacts before disposing of the battery.
- Do not touch the battery contacts with your hands or metal objects.

## **Battery Disposal & Caution**

The product that you have purchased contains a rechargeable battery. The battery is recyclable. At the end of its useful life, under various state and local laws. It may be illegal to dispose of this battery into the municipal waste stream. Check with your local solid waste officials for details in your area for recycling options or proper disposal.

Danger of explosion if battery is incorrectly replaced. Replace only with the same or equivalent type recommended by the manufacturer. Discard used battery according to the manufacturer's instructions.

#### **BSMI Notice (Taiwan Only)**

Most Booktop computers are classified by the Bureau of Standards, Meteorology and Inspection (BSMI) as Class B information technology equipment (ITE).



The symbol above must be attached to the product indicating compliance with the BSMI standard.



#### **Replaceable Batteries**

If an equipment is provided with a replaceable battery, and if replacement by an incorrect type could result in an explosion (for example, with some lithium batteries), the following applies:

- if the battery is placed in an operator access area, there shall be a marking close to the battery or a statement in both the operating and the servicing instructions;
- if the battery is placed elsewhere in the equipment, there shall be a marking close to the battery or a statement in the servicing instructions.

This marking or statement shall include the following or similar text:

CAUTION  
RISK OF EXPLOSION IF BATTERY IS REPLACED  
BY AN INCORRECT TYPE.  
DISPOSE OF USED BATTERIES  
ACCORDING TO THE INSTRUCTIONS

**FCC statement**

This device has been tested and found to comply with the limits for a Class B digital device pursuant to Part 15 of the FCC rules. These limits are designed to provide reasonable protection against harmful interference in a residential installation. This device generates, uses, and can radiate radio frequency energy and, if not installed and used in accordance with the instructions, may cause harmful interference to radio communications. However, there is no guarantee that interference will not occur in a particular installation. If this device does cause harmful interference to radio or television reception, which can be determined by turning the device off and on, the user is encouraged to try to correct the interference by one or more of the following measures:

- Reorient or relocate the receiving antenna.
- Increase the separation between the device and receiver.
- Connect the device into an outlet on a circuit different from that to which the receiver is connected.
- Consult the dealer or an experienced radio/television technician for help.

**Notice: Shielded cables**

All connections to other computing devices must be made using shielded cables to maintain compliance with FCC regulations.

**Notice: Peripheral devices**

Only peripherals (input/output devices, terminals, printers, etc.) certified to comply with the Class B limits may be attached to this equipment. Operation with non-certified peripherals is likely to result in interference to radio and TV reception.

**Caution**

Changes or modifications not expressly approved by the manufacturer could void the user's authority, which is granted by the Federal Communications Commission, to operate this computer.

**Notice: Canadian users**

This Class B digital apparatus complies with Canadian ICES-003.

**Remarque à l'intention des utilisateurs canadiens**

Cet appareil numérique de la classe B est conforme à la norme NMB-003 du Canada.

**Compliant with Russian regulatory certification**

ME61

**Modem notices (only for certain models)****Notice for USA**

This equipment complies with Part 68 of the FCC rules. Located on the modem is a label that contains, among other information, the FCC Registration Number and Ringer Equivalence Number (REN) for this equipment. Upon request, you must provide this information to your telephone company. If your telephone equipment causes harm to the telephone network, the telephone company may discontinue your service temporarily. If possible, they will notify you in advance. But, if advance notice is not practical, you will be notified as soon as possible. You will also be informed of your right to file a complaint with the FCC.

Your telephone company may make changes in its facilities,

equipment, operations, or procedures that could affect the proper functioning of your equipment. If they do, you will be notified in advance to give you an opportunity to maintain uninterrupted telephone service.

If this equipment should fail to operate properly, disconnect the equipment from the phone line to determine if it is causing the problem. If the problem is with the equipment, discontinue use and contact your dealer or vendor.

**Caution:**

To reduce the risk of fire, use only No. 26 AWG or larger UL Listed or CSA Certified Telecommunication Line Cord.

**TBR 21**

This equipment has been approved [Council Decision 98/482/EC - "TBR 21"] for single terminal connection to the Public Switched Telephone Network (PSTN).

However, due to differences between the individual PSTNs provided in different countries, the approval does not, of itself, give an unconditional assurance of successful operation on every PSTN termination point. In the event of problems, you should contact your equipment supplier in the first instance. For more information about applicable countries, please refer to "**Regulations and safety notices**" on page 46

**Notice for Australia**

For safety reasons, only connect headsets with a telecommunications compliance label. This includes customer equipment previously

labelled permitted or certified.

**Notice for New Zealand**

1 The grant of a Telepermit for any item of terminal equipment indicates only that Telecom has accepted that the item complies with minimum conditions for connection to its network. It indicates no endorsement of the product by Telecom, nor does it provide any sort of warranty. Above all, it provides no assurance that any item will work correctly in all respects with another item of Telepermitted equipment of a different make or model, nor does it imply that any product is compatible with all of Telecom's network services.

2 This equipment is not capable, under all operating conditions, of correct operation at the higher speeds for which it is designed. Telecom will accept no responsibility should difficulties arise in such circumstances.

3 Some parameters required for compliance with Telecom's Telepermit requirements are dependent on the equipment (PC) associated with this device. The associated equipment shall be set to operate within the following limits for compliance with Telecom's Specifications: a There shall be no more than 10 call attempts to the same number within any 30 minute period for any single manual call initiation, and b The equipment shall go on-hook for a period of not less than 30 seconds between the end of one attempt and the beginning of the next call attempt.

4 Some parameters required for compliance with Telecom's Telepermit requirements are dependent on the equipment (PC) associated with this device. In order to operate within the limits for compliance with Telecom's specifications, the associated equipment



labelled permitted or certified. shall be set to ensure that automatic calls to different numbers are spaced such that there is not less than 5 seconds between the end of one call attempt and the beginning of another.

- 5 This equipment shall not be set up to make automatic calls to Telecom's 111 Emergency Service.
- 6 This device is equipped with pulse dialing while the Telecom standard is DTMF tone dialing. There is no guarantee that Telecom lines will always continue to support pulse dialing.
- 7 Use of pulse dialing, when this equipment is connected to the same line as other equipment, may give rise to bell tinkle or noise and may also cause a false answer condition. Should such problems occur, the user should NOT contact the telecom Fault Service.
- 8 This equipment may not provide for the effective hand-over of a call to another device connected to the same line.
- 9 Under power failure conditions this appliance may not operate. Please ensure that a separate telephone, not dependent on local power, is available for emergency use.

#### **LCD pixel statement**

The LCD unit is produced with high-precision manufacturing techniques. Nevertheless, some pixels may occasionally misfire or appear as black or red dots. This has no effect on the recorded image and does not constitute a malfunction.

#### **Radio device regulatory notice**



##### **General**

To prevent radio interference to the licensed service, this device is intended to be operated indoors.

This product complies with the radio frequency and safety standards of any country or region in which it has been approved for wireless use. Depending on configurations, this product may or may not contain wireless radio devices (such as wireless LAN and/or Bluetooth modules). Below information is for products with such devices.

##### **Declaration of Conformity for EU countries**

Hereby, GIGABYTE, declares that this notebook PC series is in compliance with the essential requirements and other relevant provisions of Directive 1999/5/EC.

##### **List of applicable countries**

EU member states as of July 2009 are: Belgium, Denmark, Germany, Greece, Spain, France, Ireland, Italy, Luxembourg, the Netherlands, Austria, Portugal, Finland, Sweden, United Kingdom, Estonia, Latvia, Lithuania, Poland, Hungary, Czech Republic, Slovak Republic, Slovenia, Cyprus, Malta, Bulgaria and Romania. Usage allowed in the countries of European Union, as well as Norway, Switzerland, Iceland and Liechtenstein. This device must be used in strict accordance with the regulations and constraints in the country of use. For further information, please contact local office in the country of use. Please see <http://ec.europa.eu/enterprise/rtte/implem.htm> for the latest country list.

### The FCC RF safety requirement

The radiated output power of the wireless LAN Mini PCI Card and Bluetooth card is far below the FCC radio frequency exposure limits. Nevertheless, the notebook PC series shall be used in such a manner that the potential for human contact during normal operation is minimized as follows:

1 Users are requested to follow the RF safety instructions on wireless option devices that are included in the user's manual of each RF option device.



Caution: To comply with FCC RF exposure compliance requirements, a separation distance of at least 20 cm (8 inches) must be maintained between the antenna for the integrated wireless LAN Mini PCI Card built in to the screen section and all persons.

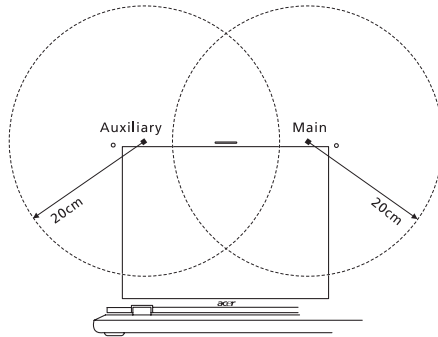

### Note:

The wireless Mini PCI adapter implements a transmission diversity function. The function does not emit radio frequencies simultaneously from both antennas. One of the antennas is selected automatically or manually (by users) to ensure good quality radiocommunication.

- 2 This device is restricted to indoor use due to its operation in the 5.15 to 5.25 GHz frequency range. FCC requires this product to be used indoors for the frequency range 5.15 to 5.25 GHz to reduce the potential for harmful interference to co-channel Mobile Satellite systems.
- 3 High power radar are allocated as primary users of the 5.25 to 5.35 Hz and 5.65 to 5.85 GHz bands. These radar stations can cause interference with and/or damage this device.
- 4 An improper installation or unauthorized use may cause harmful interference to radio communications. Also any tampering of the internal antenna will void the FCC certification and your warranty.

### Canada — Low-power license-exempt radio communication devices (RSS-210)

#### Exposure of humans to RF fields (RSS-102)

The notebook PC series employs low gain integral antennas that do not emit RF field in excess of Health Canada limits for the general population; consult Safety Code 6, obtainable from Health Canada's website at [www.hc-sc.gc.ca/rpb](http://www.hc-sc.gc.ca/rpb).

This device complies with RSS210 of Industry Canada.

This Class B digital apparatus complies with Canadian ICES-003, Issue 4, and RSS-210, No 4 (Dec 2000) and No 5 (Nov 2001).

Cet appareil numérique de la classe B est conforme à la norme NMB-003, No. 4, et CNR-210, No 4 (Dec 2000) et No 5 (Nov 2001).

"To prevent radio interference to the licensed service, this device is intended to be operated indoors and away from windows to provide maximum shielding. Equipment (or its transmit antenna) that is installed outdoors is subject to licensing."

« Pour empêcher que cet appareil cause du brouillage au service faisant l'objet d'une licence, il doit être utilisé à l'intérieur et devrait être placé loin des fenêtres afin de fournir un écran de blindage maximal. Si le matériel (ou son antenne d'émission) est installé à l'extérieur, il doit faire l'objet d'une licence.

**Caution:**

When using IEEE 802.11a wireless LAN, this product is restricted to indoor use due to its operation in the 5.15- to 5.25-GHz frequency range.

Industry Canada requires this product to be used indoors for the frequency range of 5.15 GHz to 5.25 GHz to reduce the potential for harmful interference to co-channel mobile satellite systems. High power radar is allocated as the primary user of the 5.25- to 5.35-GHz and 5.65 to 5.85-GHz bands. These radar stations can cause interference with and/or damage to this device.

The maximum allowed antenna gain for use with this device is 6dBi in order to comply with the E.I.R.P limit for the 5.25- to 5.35 and 5.725 to 5.85 GHz frequency range in point-to-point operation.

LCD panel ergonomic specifications

Design viewing distance	500 mm
Design inclination angle	0.0°
Design azimuth angle	Pixel fault class
Viewing direction range class	Class IV
Screen tilt angle	85.0°
Design screen illuminance	<ul style="list-style-type: none"> <li>• Illuminance level: <math>[250 + (250\cos\theta)]</math> lx where <math>\theta = 85^\circ</math></li> <li>• Color: Source D65</li> </ul>
Reflection class of LCD panel (positive and negative polarity)	<ul style="list-style-type: none"> <li>• Ordinary LCD: Class I</li> <li>• Protective LCD: Class III</li> </ul>
Image polarity	Both
Reference white: Pre-setting of luminance and color temperature @ 6500K (tested under BM7)	<ul style="list-style-type: none"> <li>• Yn</li> <li>• u'n</li> <li>• v'n</li> </ul>
Pixel fault class	Class II



## Introduction

Congratulations and thank you for purchasing the GIGABYTE T1125 series notebook computer. This portable notebook computer provides excellent expansion capability thanks to the docking station, includes multimedia functionality, and is designed to provide reliable, no fuss computing.

This manual will tell you how to setup and begin using your T1125. It provides basic configuring, operations and care, and troubleshooting.



# Content

Safety Instructions .....	I
Regulatory Notices & Certifications .....	III
Introduction .....	VI

## Chapter 1 Knowing Your T1125 Series Notebook

1.1 Top View .....	2
1.2 Left View .....	3
1.3 Right View .....	3
1.4 Base View .....	4

## Chapter 2 Using the T1125

2.1 The T1125 Keyboard .....	6
2.2 Use your T1125 as a Tablet PC .....	8
2.3 The T1125 Quick Battery Life Test .....	8
2.4 Operating Temperature .....	9

## Chapter 3 T1125 Specifications

3.1 The T1125 Notebook Hardware .....	12
3.2 T1125 Special Functions .....	13

## Chapter 4 The T1125 Utilities

4.1 GIGABYTE Smart Switch .....	16
4.2 GIGABYTE Smart Recovery .....	17
4.3 GIGABYTE Smart Setup .....	18
4.4 GIGABYTE Smart Manager .....	18
4.5 GIGABYTE Utility Driver Disc .....	18

## Chapter 5 Troubleshooting / Q&A

5.1 Troubleshooting .....	20
5.2 Frequently Asked Questions .....	23
5.3 Questions and Answers .....	25
5.4 The Notebook Care .....	26
5.5 GIGABYTE Service Information .....	26









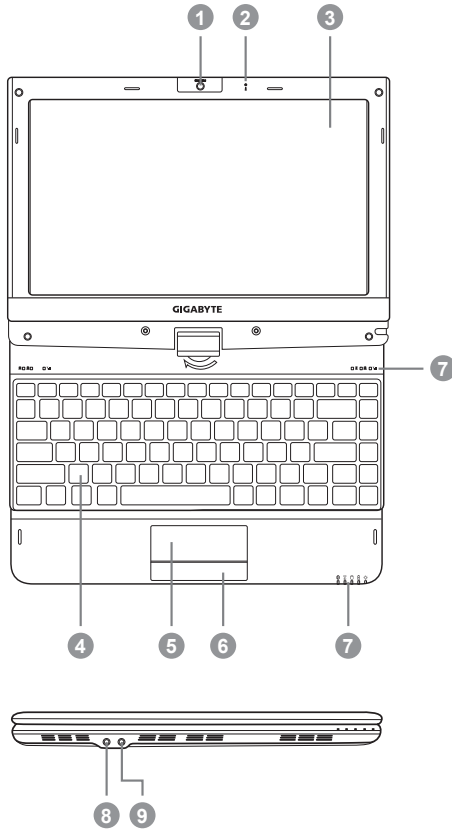



## Chapter 1 Knowing Your T1125 Series Notebook

This chapter will show you the various ports and components of the T1125 and familiarizes you with the notebook. Certain parts of the notebook can be user upgraded while others are fixed and cannot be changed.

## 1.1 Top View





#	Icon	Item	Description
1	MEGA PIXELS	Web Camera	Web camera for video communication.
2		Microphone	Internal microphone for sound recording.
3		LCD Display	Displays computer output.
4		Keyboard	For entering data into your computer.
5		Touchpad	Touch-sensitive pointing device which functions like a computer mouse.
6		Click Buttons	The left and right buttons function like the left and right mouse buttons.
7		Num. Lock Indicator	Indicates the Notebook's embedded numeric keyboard status for numeric data input.
		Caps Lock Indicator	Indicates the Notebook's input are all capital letters.
		3.5G Indicator	Indicates when the 3.5G device is active. (3.5G module may be optional)
		Bluetooth Status LED	Indicates when the Bluetooth device is active.
		Wireless LAN Status LED	Indicates when the WiFi LAN device is active.
		HDD Status LED	Indicates when the hard disk drive is active.
		Battery Status LED	Flash when charging, and off when the battery is full.
8		Power Status LED	Indicates the Notebook's power status.
		Microphone Jack	Accepts inputs from external microphones.
		Headphone Jack	Connects to audio line-out devices such as speakers and headphones.



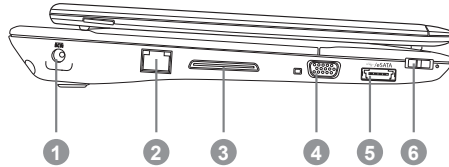

## 1.2 Left View

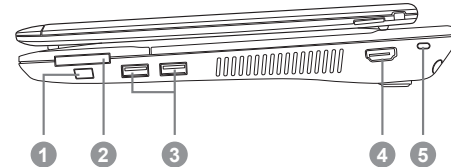

#	Icon	Item	Description
1		DC-in Jack	Connects to an AC adapter.
2		Ethernet Port	Connects to an Ethernet 10/100/1000 Base-T
3		Docking Port	Connects to the Docking station for extension functions. (Docking may be optional).
4		Keyboard	For entering data into your computer.
5		eSATA\USB 2.0 Combo Port	The combo port doubles as an eSATA and a USB port allowing USB devices and external Hard Drives to be connected using just one port.
6		Power Button	Turns the computer on and off.

## 1.3 Right View



#	Icon	Item	Description
1		Function Key	To activate the Function Key a) During the off mode, press "Fn" button to enter "Smart Setup" menu. You can choose BIOS Setup Utility, System Recovery, and other functions in this setup menu. b) In the Windows operation system, press "Fn" button to initiate "Smart Manager".
2		Multi Card Reader	Supports Secure Digital (SD), Multi Media Card (MMC), Memory Stick (MS), Memory Stick PRO (MS PRO) card.
3		USB Port	Connects to USB devices such as USB mouse, USB printers and USB external HDD.
4		HDMI Port	Supports high definition digital video connections.

## 1.4 Base View

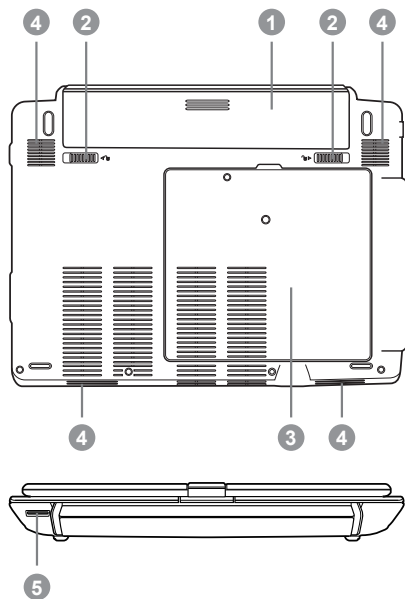

#	Icon	Item	Description
1		Battery Bay	Houses the Notebook's battery pack
2		Battery Release Latch	Release the battery for removal.
3		Hard Disk, Communication Disk, WiFi LAN, 3.5G card and Memory Bay	Housed the Notebook's Hard Disk, WiFi LAN, 3.5G card and main memory.
4		Speakers	Left and right speakers deliver stereo audio and Woofer speakers.
5		SIM Card Slot	To insert of a mobile SIM card for the 3.5G function (Optional).



## Chapter 2 Using the T1125

This chapter will briefly explain the basics of using the T1125 notebook. It will also explain any necessary precautions when using the T1125.

## 2.1 The T1125 Keyboard

### The T1125 features a Windows Compatible Keyboard.

The set language of the keyboard will depend on the region. This section is for the English Qwerty Layout Keyboard. It is compatible with a standard 104/105 Key Windows keyboard, accessed by using specific key press combinations and the hotkeys. The number of keys on the keyboard will also vary by language and region.



(English T1125 Qwerty Keyboard Layout)

### The T1125 Hotkeys

The computer employs hotkeys or key combinations to access most of the computer's controls like screen brightness and volume output. To activate hotkeys, press and hold the <Fn> key before pressing the other key in the hotkey combination.

Hotkey	Function	Description
<b>Fn+F1</b> 	Sleep	Puts the computer in Sleep mode
<b>Fn+F2</b> 	Wireless LAN	Enables/disables the Wireless LAN function
<b>Fn+F3</b> 	Brightness Down	Decrease the screen brightness
<b>Fn+F4</b> 	Brightness Up	Increases the screen brightness
<b>Fn+F5</b> 	Display Toggle	Switches display output between the display screen, external monitor (if connected) and both
<b>Fn+F6</b> 	Touchpad Toggle	Turns the internal touchpad on and off
<b>Fn+F7</b> 	Speaker Toggle	Turns the speaker on and off
<b>Fn+F8</b> 	Volume Down	Decreases the sound volume
<b>Fn+F9</b> 	Volume Up	Increases the sound volume
<b>Fn+F10</b> 	WWAN	Enables/disables the WWAN function
<b>Fn+F11</b> 	Bluetooth	Enables/disables the Bluetooth function
<b>Fn+F12</b> 	Webcam	Turns the internal webcam on and off

## T1125 Keypad Overlay

The T1125 keyboard does not have a numeric keypad but it does have the keypad overlay so that it can function like one would. It is located as seen above towards the center right side of the keyboard. The function of each key is shown in light blue to show what it does.



### Enabling The Overlay

The numeric keypad overlay acts the same way a normal numeric keypad would. To enable the numeric keypad overlay, simply hit the key.

This will enable the numeric keys and convert those keys to their blue (secondary) value. The keys will operate in this mode until the overlay is disabled by again pressing the key.

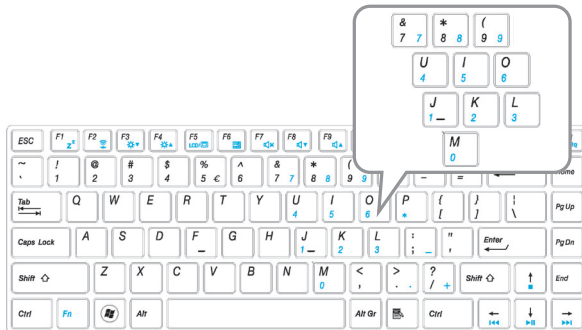

(T1125 Keypad Overlay)



### Windows Keys

The T1125 keyboard has two keys that are specific to windows, namely the Windows Start Button key, which activates the Start menu.



### Application Key

And the Application key which acts like the right click or right mouse button.

## 2.2 Use your T1125 as a Tablet PC

1. Open the lid (the screen display) of T1125.
2. On the top center above the keyboard is the pivot connecting the display panel to the bottom case. There is a sign "↻".
3. Follow the sign to turn the screen clockwise up to 180 degree so that the screen is facing out.
4. Lay the turned screen down into the flat position. The keyboard will be covered by the display. Simply touch the screen to operate T1125 as a Tablet PC.
5. When done with Tablet PC, reverse the screen to 90 degree, turn (counter clockwise to 180 degree) to set T1125 back to original position.

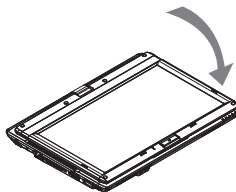
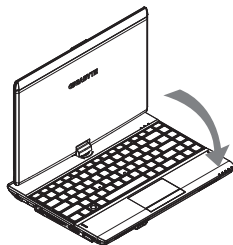
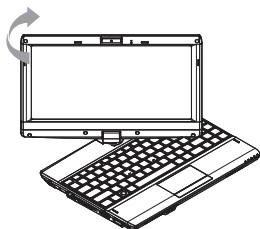

### \*Attention:

Please note that the screen can only rotate at 180 degree clockwise. Be sure to turn the screen according to the sign. forcing

## 2.3 The T1125 Quick Battery Life Test

### How To Test the Battery Life

The T1125 features a special function to test the life remaining in the battery. This function is tied to the secondary mouse button of the units touchpad. The below section briefly explains how to use this feature on the notebook to enable you to check the battery life of the T1125.

Locate the secondary mouse button (Right Button) and look for the small battery icon next to the button as shown below. You can then press the button in for about 3 to 5 seconds to begin the test. (The notebook needs to be off to enable the test).



Battery status, Press here.

The LED indicators will show the battery capacity status as following:

- 5 LED indicators on: Battery capacity 100%
- 4 LED indicators on: Battery capacity 80%
- 3 LED indicators on: Battery capacity 60%
- 2 LED indicators on: Battery capacity 40%
- 1 LED indicator on: Battery capacity 20%
- 1 LED indicator flashing: Low battery capacity
- No LED indicator on:

- A. Please check the battery is inserted properly.
- B. No battery capacity.

## 2.4 Operating Temperature

Operating Temperature: 10°C to 40°C



## Chapter 3 T1125 Specifications

### 3.1 The T1125 Notebook Hardware

*The above specification is for users' reference. The final configuration depends on the T1125 users bought.*

Specification		
Processor	Intel® Pentium® ULV Processor NVIDIA® GeForce® 310M DDRIII Supports NVIDIA Optimus Technology	
OS	Microsoft® Windows® 7 Compliance	
Display	11.6" HD Ready TFT-LCD Touch Panel, WXGA 1366x768, with LED back-light	
System Memory	DDRIII SO-DIMM*2 (Max 4GB*2)	
Chipset	Intel® HM55 Express Chipset	
Video Graphics	Intel® HD Graphics with dynamic frequency	
Hard Disk Drive	250GB/320GB/500GB 2.5" SATA HDD	
I/O Port	USB Port*2, eSATA/USB Combo, HDMI, D-sub, RJ45, Mic-in, Earphone-out, 4-in-1 Card Reader (SD/MMC/MS/MS Pro), DC-in Jack and Docking Connector	
Audio	2 Watt Speaker*4(including Woofer Speaker*2), Internal Microphone	
Communication	LAN Wireless LAN Bluetooth HSDPA (3.5G)	10/100/1000Mbps Ethernet 802.11 b/g/n Wireless Bluetooth V2.1+EDR/ Bluetooth V3.0+HS HSDPA Antenna built-in, HSDPA Module supported (Optional)
Security	1.3 Mega Pixel Webcam	
Webcam	Kensington Lock	
Battery	4 cell /6 cell Li-ion Battery	
Dimensions	290(W) x 220.7(D) x 39.3(H) mm (including 4/6 cell Battery)	
Weight	~1.62kg (including 4 cell battery) ~1.75kg (including 6 cell battery)	







## Chapter 4 The T1125 Utilities

## 4.1 The T1125 Notebook Hardware

GIGABYTE Smart Switch allows users to switch Windows® 7 system to either 64-bit or 32-bit. The Smart Switch can be accessed from the desktop (see figure icon).



You can also access Smart Switch from Windows Gadget (see below icon).



Smart Switch

The handle position helps to show the current mode, and serves as a tool to switch to another mode by pulling it down. Following dialog box will show up when the icon is clicked to toggle between modes.

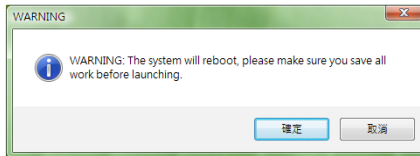

The system will ask you to save all your work before proceed. System will reboot and change to the mode selected in previous step.

## 4.2 GIGABYTE Smart Recovery

### TIPS

64-bit and 32-bit operating systems are installed in different partitions (the files and programs are saved separately). Therefore, you will need to install the software in both modes if you would like to use it in both modes.

### WARNING

Please refer to explanation below to operate GIGABYTE Smart Recovery utility (under either 64-bit or 32-bit operating system).



1. Two options will appear when entering into Smart Recovery.

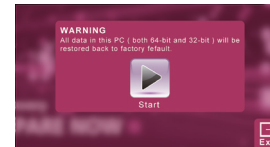

2. Both 64-bit and 32-bit systems will be restored back to factory defaults when pressing "Start" button.



3. You can choose to restore either the 64-bit or the 32-bit system back to its factory defaults in "Advanced Option" (select from the sub-menu after pressing "Advanced Option").

4. Press "Exit" to quit from Smart Recovery.

### 4.3 GIGABYTE Smart Setup

During the off mode, press SMART button to enter “Smart Setup” menu. You can choose BIOS Setup Utility, System Recovery, and other functions in this setup menu.

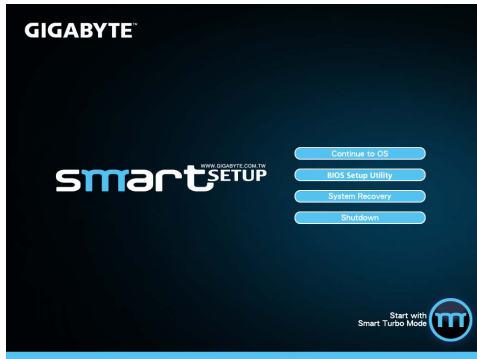

Press “Continue to OS” button to enter operating system.

Continue to OS

Press “BIOS Setup Utility” button to enter BIOS setup utility.

BIOS Setup Utility

Press “System Recovery” button to enter GIGABYTE Xpress Recovery.

System Recovery

Press “Shutdown” button to shutdown the system.

Shutdown

### 4.4 GIGABYTE Smart Manager

The GIGABYTE Smart Manager is a simple utility that gives direct control of system settings to the user in a simple interface. Due to variations of Smart Manager versions, the interface, icons, sequence and functions might be different comparing to the guide. Please operate the Smart Manager by the version preloaded.

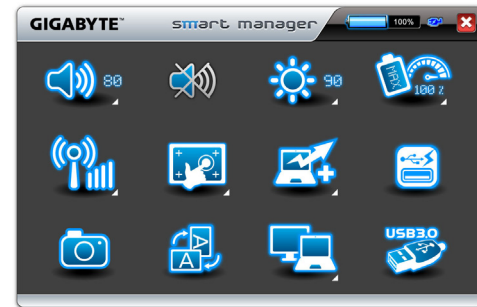

**Battery Status:**

The Battery icon with capacity status will be shown on the screen after the battery is placed.



**AC-IN:**

The AC-IN icon will be shown on the screen once the AC Adapter is plugged in. The battery icon will be shown on the screen when using battery as the main power source.



**Volume control:**

Press the volume control icon to adjust the volume level.



**Mute:**

Press the mute icon to enable/disable the mute mode.

**Brightness:**

Press the brightness icon to adjust the level of the display backlight brightness.

**Power mode:**

Press the power mode icon to select different power management mode.

**Communication:**

Press the communication icon to enable/disable 1/Wireless LAN 2/Bluetooth 3/3G Functions.

**Touch Screen:**

Press the Touch Screen icon to enable/disable Touch Screen function and to enable touch screen calibration function.

**Smart Turbo:**

Press the Smart Turbo icon to enable/disable Smart turbo function. GIGABYTE Smart Turbo over-clocking technology enhanced system performance. You can select the over-clocking frequency percentage you requested. (Optional)

**Smart Charge:**

Press the Smart Charge icon to select the USB power supplying mode under Sleep Mode when using battery as the main power source.

\*The Introduction of GIGABYTE Smart Charge function

The GIGABYTE Smart Charge allows you to charge your digital devices through USB ports while the computer is in the sleep mode. When your computer is powered through an

AC adapter by direct AC power supply, you will be able to use Smart Charge when the computer is in Off/Sleep/Hibernation mode. However, if the battery pack is the sole power supply for your computer, Smart Charge only works in Off/Hibernation mode.

To ensure sufficient power supply for system operation, you can set the computer (via GIGABYTE Smart Manager) to automatically cease this function at 50/40/30% of power level.

**Camera:**

Press the camera icon to turn on/off Webcam power.

**Screen Rotation:**

Press the screen rotation icon to rotate the display direction.

**Screen Output Setting:**

Press the camera icon to turn on/off Webcam power.

**USB3.0:**

Press the USB3.0 icon to enable/disable USB3.0 port.

## 4.5 GIGABYTE Utility Driver Disc

The GIGABYTE T1125 comes with a Driver and Utilities Disc should you need to reinstall any drivers, or if you are installing the operating system because it did not ship with the notebook. Before installing drivers, check on the notebook and with the supplier as to whether they have already installed all the drivers with the operating system. If not, place the Driver CD into the optical device. An installation screen will appear. You can then install all or the needed drivers from the interface.







## Chapter 5 Troubleshooting / Q & A

This section will briefly cover some frequently encountered problems and questions and provide a quick guide to assist with solve these problems. Most problems can be resolved quickly, simply and easily and are not always a system problem. Should you encounter a problem that is not yet or differently listed, please consult the GIGABYTE Website or call your unit supplier for assistance?

For website assistance go to the Support section of [www.gigabyte.com.tw](http://www.gigabyte.com.tw) for telephonic assistance please call the supplier of your unit or take the unit to the supplier directly for assistance.

## 5.1 Troubleshooting

**Warning:** Under the condition that you can't handle problems, please contact to your dealer to get professional assistance and service.

### AC Adapter

Trouble	Solution
No power supplied to notebook	<p>Make sure the AC adapter is well connected to the power source and Notebook.</p> <p>Check the cable and plug to make sure they are OK. If they are broken, please contact your local dealer ASAP.</p>

### Battery Pack

Trouble	Solution
No power supplied to notebook	<p>The remaining power in battery pack may be not enough to power on the machine. Connect AC Adapter to recharge it.</p>
Can't be recharged after connecting AC adapter	<p>Check temperature of battery pack's surface. Battery pack can't be recharged if its temperature is too high or too low. Recharge it only after its temperature is the same with the normal environment one.</p> <p>If battery pack is fully discharged, it won't be recharged at once. Please wait for a few some minutes.</p> <p>If the power indicators of the battery pack are always not lit up, its life may be over. Please contact your dealer to buy another one.</p>

Battery life depends on usage conditions of the Notebook. You can change the settings in the Power Manager of the OS to save power.

Battery life is not as long as it should be

Battery pack can't exert its full capacity if it works when not fully recharged frequently. Power Notebook by battery pack until its power drops to a critically low level and the machine emits a high-pitched beep or displays a warning message; after that, recharge battery packs to make battery pack work longer.

**!** **WARNING:** Please pay attention to the following information regarding the battery pack:

1. Be sure to recycle the waste batteries properly.
2. Do not place the batteries near high-temperature locations, fire source or in burning fire as this may cause the batteries to explode
3. Do not assemble/disassemble /modify the batteries without authorization.
4. Use the battery pack provided by the original manufacturer only. Batteries other than those supplied by the original manufacturer may damage the device.

### Keyboard

Trouble	Solution
Press character keys but number displayed instead of character	Check if Num Lock is activated.
Confusing display	Make sure there is no software to configure the keyboard.



**!** **WARNING:** Please pay attention to the following information about keyboard maintenance.

1. *Dust build-up may occur in the keyboard after long-term use. It is recommended to clean the keyboard with a small brush. Please shut down the machine before cleaning the surface of the keyboard and wipe it with a soft cloth, dipped in cleaner or water, gently.*
2. *In case any liquid enters the keyboard, shut off the power supply immediately, remove the batteries and contact the original manufacturer directly for repair. Do not disassemble the keyboard yourself for repair.*

#### **Hard Disc Drive (HDD)**

Trouble	Solution
HDD can't be booted	The operating system is corrupted by incorrect operation or virus. Try to clean the virus and then configure your operating system correctly.
	Maybe the documents of your OS run in error; please refer to the manual of your OS.
HDD performs very slowly	There is too much file fragment. Use disk defrag tools to rearrange the programs on the hard disk.

**!** **WARNING:** Please pay attention to the following information about Hard Drive maintenance.

1. *The hard disk is a high-speed data storage device. Avoid using the Notebook in unstable locations as far as possible to prevent hard disk damage and data loss.*
2. *Please use the computer in accordance with normal startup/shutdown procedures; improper startup/shutdown may shorten the service life of the hard disk.*

#### **LCD**

Trouble	Solution
The screen is blank	Press hot key Fn + F5 to change the display mode if certain external monitor is connected. Make sure the system isn't in the mode of Hibernation or Standby.

**!** **WARNING:** Please pay attention to the below points on the mounting design of the panel for the LCD module.

1. *Do not put heavy force along the edges of the active area.*
2. *Do not put a heavy shock or stress on the panel and film surface.*
3. *Do not put heavy goods on the display panel.*
4. *The LCD screen is the most fragile component of the Notebook and is prone to damage under external forces. Do not place any object on the keyboard or between the keyboard and the screen to prevent damage to the LCD screen.*
5. *When traveling with GIGABYTE Notebook, place it in a special case in a tidy manner as far as possible. Excess objects may squeeze the machine and therefore damage the LCD screen.*
6. *Do not touch the screen with sharp objects or fingers directly.*
7. *It is recommended that the LCD screen be wiped with a special screen cleaning cloth. Wipe the screen gently to avoid breakage of the screen.*
8. *Prevent any liquid from entering the LCD screen as this may damage the elements of the LCD screen.*

**Printer**

Trouble	Solution
The data can't be output from notebook to printer	Make sure the printer is powered on. Make sure its cable is OK and its USB interface is well connected to Notebook.
Error printing	Make sure your printer is compatible with your Notebook. Please refer to the user's manual of your printer for help.

**Audio**

Trouble	Solution
	Adjust sound controller.
	Check the setting of sound volume of software.
No sound emitted	Check if the ear phone is firmly connected. Check the Devices Manager of Windows. Be sure the Sound function has been activated and isn't interfering with other hardware.

**USB**

Trouble	Solution
Equipments connected can't work	Check and be sure USB port of notebook is firmly connected with the USB cord of the equipment. Be sure the driver of the equipment is installed correctly.

**Stand by / Hibernation**

Trouble	Solution
Can't enter into Standby/ Hibernation	Please check if the Windows Media Player is running. If Yes, the notebook can't enter into Standby or Hibernation mode. Please close Windows Media Player.

**LAN**

Trouble	Solution
Can't be connected	Be sure the RJ45 connector is firmly connected to the network hub or switch.

## 5.2 Frequently Asked Questions

- ◆ My computer switches to hibernation mode much too quickly and I have to constantly hit a key or move the mouse to bring back the screen. What can I do?
  - This is part of Windows Power Management. Access Power Management by clicking on Start / Control Panel / Performance and Maintenance / then Power Options, and change the time next to the "Turn off Monitor" option to the time you want. You have the choice of either adjusting time for the power supply or for the battery.

---

- ◆ I've heard that cleaning and rearranging files on the hard drive will improve program's launch speed. How do I do this?
  - Good disk maintenances can improve program launch speed. This normally includes deleting unnecessary files, and defragmenting the hard disk so the files can be more efficiently grouped. Windows contains maintenance based utilities for these tasks; run Disk Cleanup to remove unnecessary files, and Disk Defragmenter to defragment fragmented file blocks. For more info on these utilities, please refer to your Windows documentation or Windows help.

---

- ◆ What kind of external microphone can I use with my notebook computer?
  - You will need to use a self-amplifying microphone.

---

- ◆ There are echoes coming from my speakers. What can I do?
  - Double click on the Speaker icon on the task bar. Then, under the Microphone Balance, check the Mute box.

---

- ◆ Because of a software problem, I was unable to shut the computer down from Windows, I pressed the power button to power off the computer, but it didn't work. How can I force a power off computer switches to hibernation mode much too quickly and I have to constantly hit a key or move the mouse to bring back the screen. What can I do?
  - Make sure you press the power button for at least 5 seconds. Normally, this will force the computer to shut off completely.

---

- ◆ Why can't I charge the battery of my notebook computer after it is out of use for some time?
  - After your notebook computer has not been used for a long time (for example: more than one month), the battery will enter into low voltage protection mode. Under this circumstance, restoring to normal voltage will require the battery to be slowly charged for several hours. Once the battery has been fully charged, your computer will resume to normal operation.

- ◇ My computer says: “CMOS Battery Low”, what should I do?
- If your computer is without power (i.e. unplug the computer power source from the power outlet and remove the battery pack from it) for over 45 days, you would lose the information stored in CMOS. Please follow the steps below to reconfigure your CMOS settings:
  - step1. Press F2 to enter into the BIOS setup utility.
  - step2. Select “Load Optional Defaults?” When you see the following prompt, choose <OK> and then press <Enter>.
  - step3. Select “Save Changes and Exit”, select <OK> and press <Enter> to restart your computer

◇ How to unplug or eject devices?

- 1. In the notification area next to your task bar, double-click on the Safe Removal icon. Safe removal displays a list of Plug and Play devices that support safe removal and that are currently attached to the system. If you do not see the Safe Removal icon, your device does not support safe removal, and you cannot unplug or eject your device using Safe Removal.
- 2. In Safely Remove Hardware, in the list of devices, select the device that you want to unplug or eject, and then click on Stop. This tells the system that you will be unplugging or ejecting the device.
- 3. In Stop a Hardware device, click OK. A notification appears stating that it is now safe to unplug or eject the device.

Caution

- Unplugging or ejecting a device that supports safe removal without first than using the Safe Removal application to warn the system can cause data to be lost or your system to become unstable. For example, if a device is unplugged during a data transfer, data loss is likely. If you use Safe Removal, however, you can warn the system before you unplug or eject a device, preventing possible loss of data. If you use Safe Removal, however, you can warn the system before you unplug or eject a device, preventing possible loss of data.

Note

- For removable storage devices that can safely be removed while the system is on, the system disables write caching by default. It does this so the devices can be removed without loss of data. When write caching is disabled, however, the system will likely experience slower performance, so be sure to enable write caching when you have finished removing the device.

- ◇ Does the T1125 provide a hardware switch or function button to enable/disable the Bluetooth function?
- the T1125 provides a combined function button to enable/disable the 3.5G (Fn+F10) and Bluetooth (Fn+F11) functions.
- ◇ What is the capacity of SDHC cards that T1125 can support?
- The specification of SDHC that T1125 SD card reader supports shall be in accordance with that of the SD Association. Currently, the maximum capacity announced by SD Association is 32GB <http://www.sdcard.org/developers/tech/sdhc/>

- ◇ How can T1125 BIOS be upgraded in the DOS and Windows mode?
- ➔ Please refer to GIGABYTE website “How to upgrade T1125 BIOS in the DOS and Windows mode?”

### 5.3 Questions And Answers

**Q:** I can feel a mild heat next to the battery pack. Is this normal?

**A:** The battery will generate heat during recharging and discharging. There is a protection circuit inside the Notebook to prevent overheating. User needs not worry.

**Q:** My battery operation time is not as long as it should be. Why?

**A:** The battery is heat sensitive and can only be charged to its maximum if the battery and its environmental temperature remain within 15-25°C (59-77°F). The more the temperature deviates from this range during recharging, the less chance there is for the battery to be fully charged. In order to recharge the pack to its full capacity, users are requested to cool down the unit by unplugging the AC Adapter. Wait until it is cooled down. Then plug in the AC Adapter to start recharging again.

**Q:** I did not use my spare battery for a few days. Even though it was fully recharged, there wasn't as much power left as a newly charged one. Why?

**A:** The batteries will self-discharge when they are not being recharged. To make sure a battery pack is fully charged, recharge before use. Always keep the battery inside the Notebook and have the AC adapter connected whenever possible.

**Q:** I did not use my spare battery for months. I have a problem with recharging it.

**A:** If you happen to leave your battery pack to go through an extended period of self-discharge, say more than three months, the battery voltage level will become too low and needs to be Pre-Charged (to bring the battery voltage level high enough) before it automatically (for Li-Ion only) resumes its normal Fast Charge. Pre-Charge may take 30 minutes. Fast Charge usually takes 2~3 hours.

## 5.4 The Notebook Care

Through prolonged use the Notebook might become dirty or due to some form of accident require cleaning. It may also become damaged due to travel and use. Please follow the below guidelines to care for and clean the Notebook.

Ensure to always carry your Notebook in a Handy Bag or Case so that it is protected during travel and is better able to handle any of the normal bumps, knocks and drops that occur.

Should the work surface of the notebook (Palm Rest, Touch Pad etc.) become dirty, a slightly damp cloth and certified computer cleaner can be used to clean the surface. Do not use any Household or abrasive cleaners as these can damage the surface.

To clean the LCD Panel, please use a slightly damp cloth and approved LCD Cleaner ONLY. Any form of Household or abrasive cleaner can damage the LCD Panel.

In the event that any liquid is spilled in / onto the notebook immediately switch off the machine regardless of any data that might be lost, remove the AC Adaptor if plugged in and remove the battery pack. DO NOT switch the unit back on, immediately contact the provider of the notebook to arrange to have the unit dried and checked for any kind of damage.

## 5.5 GIGABYTE Service Information

More service information please link to GIGABYTE official website:  
<http://www.gigabyte.com>

This device complies with Part 15 of the FCC Rules. Operation is subject to the following two conditions:

(1) This device may not cause harmful interference, and (2) This device must accept any interference received, including interference that may cause undesired operation.