



Check before use

Read me first -----
Introduction of G-scan -----
Safety Warnings and Cautions before Use -----

G-scan Configuration

Specification -----
Introduction of component -----
Introduction of function -----

Basic Use of G-scan

Power supplying -----
Power ON/OFF -----
Description for Main Component of H/W -----
Description for Main Component of S/W Screen -----
Connecting the DLC cable -----
Self Test Adapter connection -----

Configuration

Setup -----
User Information -----
Version -----
Self Test -----

Vehicle Communication Function

System Select	-----
Fault Code Searching	-----
DTC Analysis	-----
DATA Analysis	-----
Actuation Test	-----
Vehicle S/W Management	-----
ECU Upgrade	-----
OBD-II Function (CARB OBD-II)	-----
Flight Recording	-----

PC Communication

Software Installation	-----
Operating Program	-----

Appendix

How to install Optional Items	-----
O/S & Bootloader Update	-----
G-scan and Peripherals Limited Warranty	-----
Disposal of Old Electrical and Electronic Equipment	-----



Read me first



Check before use

Module NO: A-00-002

Introduction

Thank you for purchasing G-scan. This manual describes the basic information for using G-scan. Before using G-scan, please read this manual to be familiar with important information.

Copyright

Global Information Technology Co., Ltd copyrights this Manual. All rights reserved. No part of this manual may be reproduced in any form without the prior written permission of Global Information Technology Co., Ltd. No patent liability is assumed with respect to the use of the information contained herein.

G-scan is registered trademark or trademark of Global Information Technology Corporation in the United States and/or other countries.

©2007 Global Information Technology Co., Ltd. All Right Reserved.

Disclaimer

G-scan specifications and manual are subject to change without prior notice. Global Information technology Co., Ltd. assumes no liability for the products, which GIT do not produce.



Overview

Comparing with the conventional diagnosis equipment, the interface of G-scan is configured to be easily operated. Anyone can easily use the G-scan to maintain the vehicle with maximized service efficiency.

- Input using the Touch Screen

Without complicated button operation, you can select menu and function on the screen directly. You can use diagnosis equipment easily.

- 5.6" Color TFT LCD

Adapting the 5.6" large size Color TFT LCD, various data can be shown on the same screen at the same time.

- TPMS (Option)

Embedding with TPMS module, it is possible to access to the TPMS sensor installed in the vehicle with wireless communication.

- USB communication interface

Using the USB communication interface, it is possible to connect with the diagnosis newly developed in future easily..



Safety Warnings and Cautions Before Use



Check before use

Module NO: A-00-003

This section contains WARNINGS and CAUTIONS for safe usage of G-scan Before use, the user should read the following information.



WARNING

This indicates incorrect handling may result in a major accident involving death or serious injury.

- The G-scan should be secured in a safe location when operated in the vehicle to avoid interference with other vehicle equipment.
- Only use the specified adapters and cables when connecting the G-scan module. (7~35VDC).
- Ensure all cables are properly connected during operation. Do not disconnect communication cable or power cables unless finished with the equipment.
- Do not disassemble the G-scan module.
- When updating G-scan, connect the external power (AC/DC adaptor) to supply stable power.
- Ensure that the module is installed in a safe and secure location to avoid interference with other vehicle equipment.
- Use only genuine accessory parts supplied by GIT.

- Never connect the device to equipment rather than vehicles.
- Products are to be used within the right temperatures. (Refer to Specifications)
- Products are to be stored within the right temperatures. (Refer to Specifications)
- Use GIT products for their original purpose only.
- This product is designed for technicians with proficient skills therefore all users must digest manuals fully before using the product.
- Users have their own responsibility for Product damages, fire hazards and emitted gas caused by users with no full understanding of the Cautions and other information stated in the manual.
- GIT products should never be tested or repaired by any one rather those authorized service technicians by GIT.
- When exchanging rechargeable battery, comply with the method described in this manual by reading before exchanging it.
- Use only rechargeable battery supplied from GIT.
- Do not disconnect the rechargeable battery at one's discretion.
- Be careful that the rechargeable battery is not wet in water.
- Do not put the rechargeable battery near the fire.
- Do not impact to or prick the rechargeable battery with sharpen object.
- Don not put the rechargeable battery into the microwave oven or high pressed vessel.
- Do not throw or apply with physical impact to the rechargeable battery.

- Be careful that the terminals of rechargeable battery are not shorted.
- If the rechargeable battery makes any abnormal condition such as odor, heat, deformation or discolor, do not use it. If you are charging or using the battery, stop the operation and remove the battery immediately.
- Do not reverse the positive(+) and negative(-) terminals.
- Do not connect the battery directly to wall outlets or car cigarette-lighter sockets.
- Do not put the battery into a fire or apply direct heat to it.
- Do not short-circuit the battery by connecting wires or other metal objects to the positive(+) and negative(-) terminals.
- We GIT are not responsible for products other than products produced by GIT.

	<p>CAUTION</p> <p>This indicates incorrect handling may lead to injury or damage to properties. Under certain conditions more serious consequences may result.</p>
---	---

- Do not drop the G-scan.
- Do not place any objects (tools, manuals, etc.) on the G-scan.
- When connecting cables under the hood, secure the cables to avoid damage caused by hot or moving parts.
- When connecting the DLC cable, check the locking device.
- Observe correct polarity when connecting the power supply cable.
- Properly store all components when not in use.

- Do not use cables as carrying handles.
- Do not store products in places where
 - ◆ Extremely high or low temperature (Refer to feature of products)
 - ◆ Extremely high or low humidity (Refer to feature of products)
 - ◆ Inside a vehicle during summer season for a long time
- Exposed to direct rays
- Avoid a shock or vibrations or under heavy weight.
- Avoid a shock or vibrations during shifting.
- Keep products away and store from moisture.
- Keep products away from flammable substances or places where fierce static electricity can occur.
- Products and accessories are not to be coated or painted with chemical substances or acid that can corrode the equipment.
- Do not expose the equipment to X-ray or Microwave. This might cause severe damage to the equipment.
- When inserting SD memory, check the direction.
- When supplying electric power to G-scan with 220/100V source, use only the adapter supplied with this product.
- When using touch screen, use the specified stylus pen only. If you use other sharp or keen object on the touch screen, it can be damaged severely.
- Do not store the battery in the hot area. It may reduce the service time of battery.
- If the G-scan with battery pack has to be stored for a long time(over 3 months), the environmental condition(Temperature: $23\pm 5^{\circ}\text{C}$, Humidity:

65±20%RH, Battery Level Indicator: 2 of 3 levels) should be observed.

- When your eyes contact battery liquid, do not rub your eyes, but clean out them with fresh water. Contact doctor immediately.
- Do not expose the LCD to moisture or water.
- When LCD is broken, the liquid crystal material will be flown out. Do not contact liquid crystal. If you contact it, clean it out immediately with soap water.
- When LCD surface is contaminated, clean it using soft clothes with alcohol.
- Do not contact volatile material except alcohol to LCD surface.
- Do not lay any heavy object down on LCD panel.
- After using for a long time, conduct zero calibration to the touch screen.



Specification



G-scan Components

Module NO: A-01-001

Main Specification

Item		Specifications
Micro Controller		ARM9 (S3C2440A) @400MHz
Memory		NOR Flash Memory 16MB
		NAND Flash 64MB
		SDRAM Memory 32MB×2
External Memory		1GB (up to 4GB)
Temperature	Operating	0°C~45°C(32°F~113°F) : Battery Charging
		0°C~50°C(32°F~113°F) : Battery Discharging or without Battery
	Storage	-10°C~70°C(14°F~158°F) (Refer to cautions of manual)
Relative Humidity	Operating	Noncondensing @ 0°C~10°C(32°F~50°F)
		90%RH @ 10°C~30°C(50°F~86°F)
		70%RH @ 30°C~50°C(86°F~122°F)
	Storage	Noncondensing @ -10°C~70°C(14°F~158°F) (Refer to cautions of manual)
LCD		5.6" TFT Analog LCD (480 × 234 pixel)
Input Devices		Power ON/OFF Key, Enter Key, ESC Key, Arrow 4 Keys, Functional 6 Keys
		Touch Screen 5.6 "

User's Manual

External Lamps	2 Color LED × 3 (Power, DLC, Option)
Sound	Buzzer 1 Tone Module NO: A-01-001
Battery (*Option)	Li-Ion Polymer 2100mAh 1cell
Operating Voltage	7~35VDC
Housing	PC + ABS & Rubber Shroud
Dimension	194×129×59 mm
Weight	about 900g(Body weight including Battery, TPMS Pack)

G-scan TPMS

Item	Specifications
TPMS radio frequency	Transmission: 125Khz Reception: 315Mhz or 433Mhz
TPMS Protocol	TRW (ASK, FSK)
	LEAR (FSK)
	Siemens (FSK)

PC 및 주변기기 통신 포트 규격

Item	Specifications
External input/output device	USB Host, USB Slave (USB 1.1)

G-scan (Vehicle Communication Interface)

Item	Specifications
CAN	ISO - 11898, ISO - 11519
K-Line/L-Line	ISO-9141, ISO-9141-CARB, KWP-2000

Commercial Veh	SAE-J1708, RS-232C
Data/Control Line	Melco Pull-Down UART

Module NO: A-01-001

Added interface

Item	Specifications
1. VSS	Vehicle Speed Simulation
2. Voltage Output	5~20 VDC

FCC ID: TMGG1PDDMN001

NOTE: This equipment has been tested and found to comply with the limits for a Class A digital device, pursuant to Part 15 of the FCC Rules. These limits are designed to provide reasonable protection against harmful interference when the equipment is operated in a commercial environment. This equipment generates, uses, and can radiate radio frequency energy and, if not installed and used in accordance with the instruction manual, may cause harmful interference to radio communications. Operation of this equipment in a residential area is likely to cause harmful interference in which case the user will be required to correct the interference at his own expense.

CAUTION: Changes or modifications not expressly approved by the party responsible for compliance could void the user's authority to operate the equipment.

This device complies with part 15 of the FCC Rules.

Operation is subject to the following two conditions:

- (1) This device may not cause harmful interference.
- (2) This device must accept any interference received, including interference that may cause undesired operation.





G-scan Introduction of Components





G-scan Components

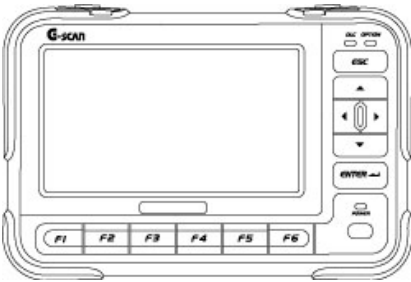

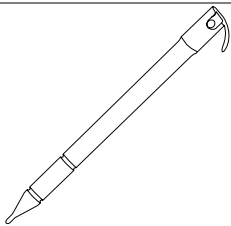
Module NO: A-01-002

G-scan Hardware Components

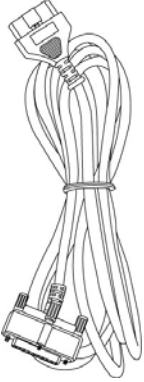

Part	Description	Qty.
	<p>Part Name: G-scan module P/No: G1PDDMN001</p> <p>G-scan module comprises of the main module for vehicle communication and the option pack (Battery pack, TPMS pack).</p>	1
	<p>P/Name: Hand Strap P/No: G1PDDMN002</p> <p>This is the hand strap for preventing damages by falling during using the G-scan.</p>	1
	<p>P/Name: String – Stylus P/No: G1PDDMN003</p> <p>A spring type string for preventing the stylus pen from being lost.</p>	1
	<p>P/Name: Stylus Pen P/No: G1PDDMK020</p> <p>The specific tool for operating touch screen of G-scan. When using the touch screen, use this stylus pen only.</p>	1

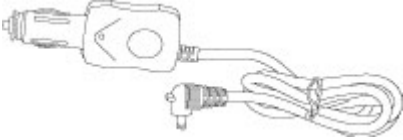
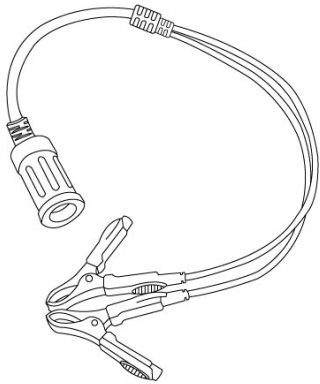
User's Manual

Part	Description	Qty.
	<p>P/Name: CABLE-DLC P/No: G1PDDCA001</p> <p>DLC main cable for communication between G-scan module and (16 pin) OBD-II diagnosis connector on vehicle.</p>	1
	<p>P/Name: User's Manual P/No: N/A</p> <p>The book describing the basic information for using the G-scan.</p>	1
<p>촬영 필요</p>	<p>P/Name: CD (S/W) P/No: N/A</p> <p>CD includes the PC utility program. The PC utility supports the G-scan update and the G-scan system recovery.</p>	1
	<p>P/Name: Adapter[16pin-20pin(R)] P/No: GHDM-244000</p> <p>DLC Adapter cable [16pin to 20pin(R)] for Main DLC cable (P/No: G1PDDCA001) and 20-pin diagnosis connector on vehicle. 20pin (R) connector is GRAY in color.</p>	1

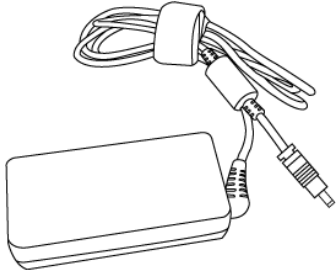
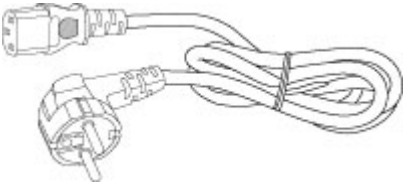
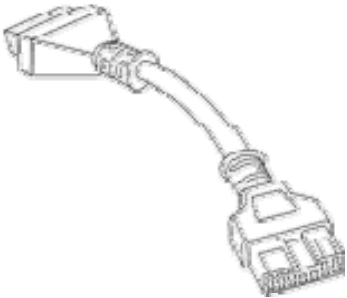
Part	Description	Qty.
	<p>P/Name: CABLE – CIGAR P/No: G1PDDCA002</p> <p>It is used for supplying external power to the G-scan using cigarette lighter terminal.</p>	1
	<p>P/Name: CABLE – BATTERY P/No: GSTA-37210A</p> <p>The cable for connecting the Cable – Cigar (P/No: G1PDDCA002) to the battery terminals.</p>	1
	<p>P/Name: CABLE–mini USB(DOWNLOAD) P/No: G1PDDCA003</p> <p>Cable for communication between G-scan and PC(Laptop)</p>	1
	<p>P/Name: ADAPTER(Self Test Jig) P/No: GHDM-24D000</p> <p>This self-test adapter is used for self-diagnosis functions that are described in a separate chapter. Do not use this adapter except for its specified purposes. For more information about self-diagnosis, see chapter (Module: A-02-006) Self-test adapter.</p>	1

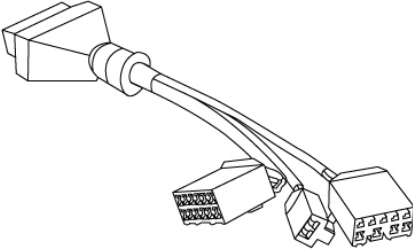
Part	Description	Qty.
	<p>P/Name: Carrying Case P/No: G1PDDHA001</p> <p>The case preserving G-scan body and components. For preventing from being damaged and lost, G-scan should be stored in this case after using.</p>	1
	<p>P/Name: AC/DC Adapter P/No: GHDM-260001</p> <p>Adapter for supplying power to the G-scan main module from AC power</p>	1
	<p>P/Name: AC Power Cable P/No: GHDM-273000</p> <p>Cable for AC/DC adapter</p> <p>The socket plug for AC power cable can be different depends on each area. Please purchase the right plug if it doesn't match with your country's electrics specification.</p>	1
	<p>P/Name: Adapter(16-12) P/No: GHDM-245000</p> <p>This adapter is connected between Main DLC cable(P/No: G1PDDCA001) on the G-scan module and 12pin diagnosis connecter on some specific vehicles.</p>	1

Part	Description	Qty.
	<p>P/Name: (10-8-2) P/No: GHDM-247000</p> <p>DLC adapter cable for reprogramming and setting Remote Keyless Entry(RKE). 3 different connectors each(10, 8 and 2pins) compose the other side of this 16pins diagnosis connector. This adapter is used with the main DLC cable(P/No: G1PDDCA001) , while connected to the G-scan module.</p>	<p>1</p>
<p>(Optional Item)</p> 	<p>P/Name: G-scan TPMS Pack P/No:</p> <p>TPMS module and rechargeable battery are embedded.</p>	<p>1</p>
<p>(Optional Item)</p> 	<p>P/Name: G-scan Battery Pack P/No:</p> <p>Rechargeable battery is embedded.</p>	<p>1</p>

- Please check above items at opening this product.
- The optional items are for purchasing additionally.



- Possible to communicate with all vehicles of HMC/KIA
- 5.6" TFT LCD
- Possible to search the DTC of all control module installed in vehicle at the same time
- ECU upgrade
- Diagnose the vehicle with CARB OBD-II
- Record the travel data
- Support supplementary functions for diagnosis
- Actuator enforced drive test
- Comparison analysis through dual mode
- Support data relating to DTC
- Convenience and Long endurance
- Easy to operate using touch screen
- Expandable function using USB interface
- TPMS module diagnosis
- Embedded rechargeable battery (Option)
- Support supplementary function relating to TPMS (Option)

1. Supply external power

There are 4 methods for supplying external DC power to the G-scan.

- With DLC cable
- From the cigarette lighter terminal in cabin
- From the battery of vehicle
- From the AC/DC adapter

2. Power supplying from embedded rechargeable battery (Option)

- When using wireless communication (LF/RF) of TPMS

Caution

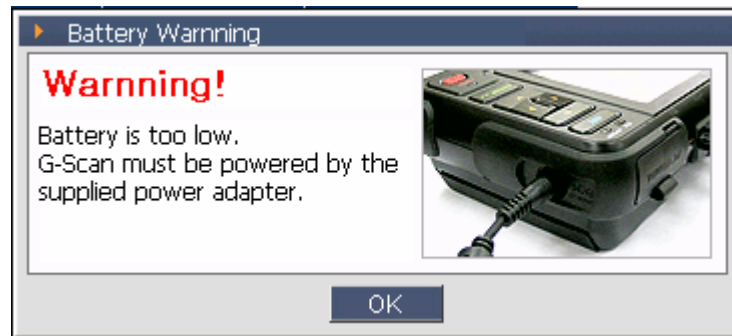

<Figure 1: Low Voltage Warning for Rechargeable Battery>

- The <Figure 1> is the message warning the low battery. If you see this message, supply the external power immediately.
- Otherwise, the G-scan will be turn OFF automatically.

How to connect the external power

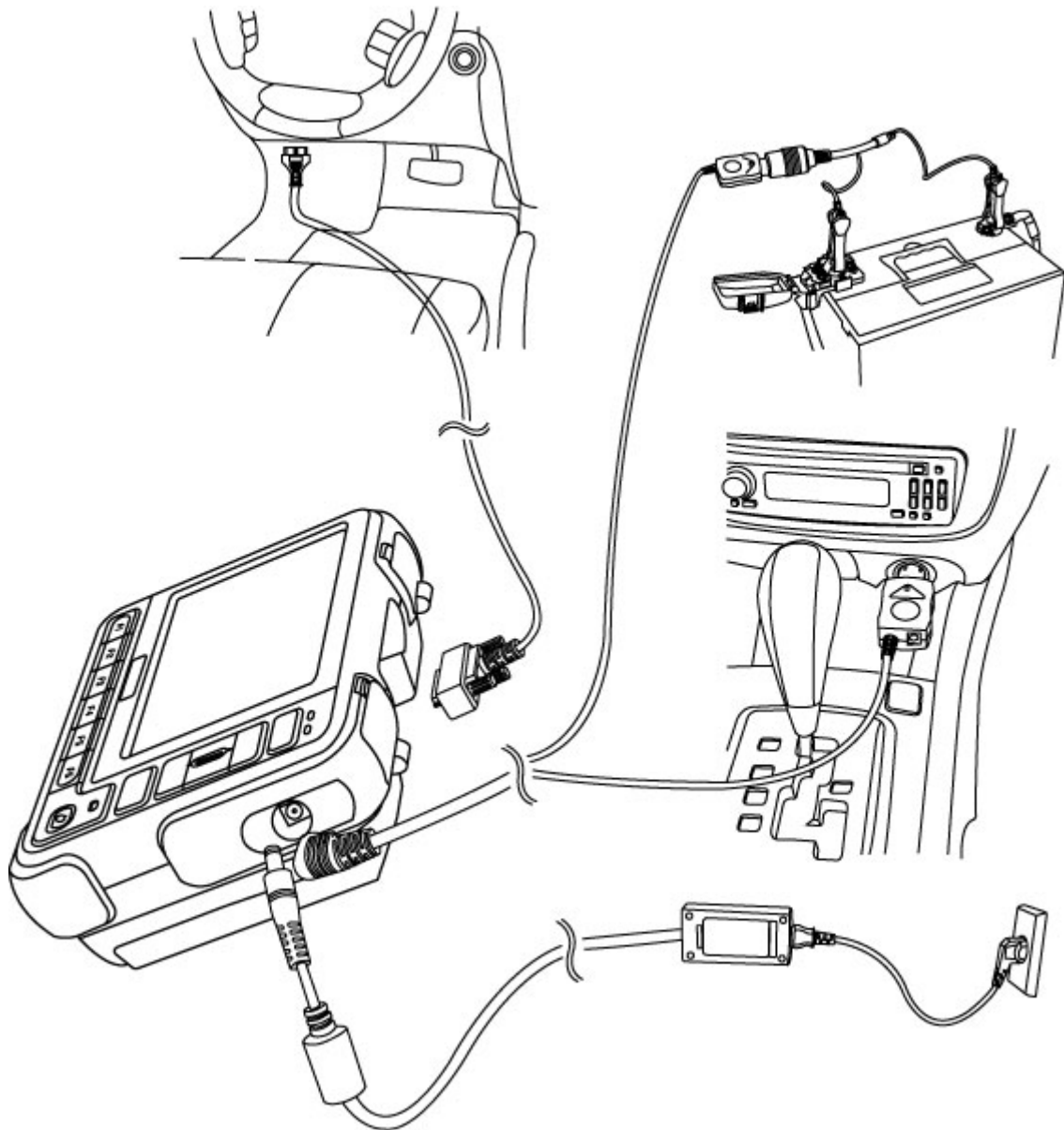

<Figure 2: Connect the External DC power to G-scan>

Description of Power Supplying Method

Power supplying with the DLC cable

The vehicle of which diagnosis connector terminal is the 20-Pin connector or which is satisfying the OBD-II communication regulation can be supplied the electric power from the DLC cable without any additional power line.

Note:

The DLC connector, in general, is located at the lower part of the driver's front panel. This location may be different somewhat, please check the correct location before connecting.

From the cigarette lighter in the cabin

Using the cigarette lighter power cable purchased as a basic item with the G-scan, the electric power can be supplied.

Note:

When using the cigar cable, the power will be cut during ignition of the engine. Therefore, for the G-scan without rechargeable battery, the power will be OFF. If your G-scan does not have rechargeable battery and you diagnose vehicle relating to the ignition of engine, use other power supplying method.

From the vehicle battery

When power is supplied from the vehicle battery, the electric power can be supplied without interruption.

Cautions at connecting the vehicle battery

- ◆ Do not contact the battery power line to the driving part in the engine room.
- ◆ Connect correct power lines to the battery terminals.

From the AC/DC adapter

Using the AC/DC adapter purchased as a basic item with the G-scan, the electric power can be supplied to the G-scan.

When updating the G-scan, use the AC/DC adapter for supplying stable power to the G-scan.



Warning

Use only the AC/DC adapter supplied by GIT for the G-scan. GIT has not responsibility for the damage by different kinds of AC/DC adapter.



Caution

- ◆ At communicating with vehicle (for all vehicle diagnosis function with DLC cable), the vehicle battery should be connected always.
- ◆ For updating the G-scan, connect the AC/DC adapter for supplying the stable power.

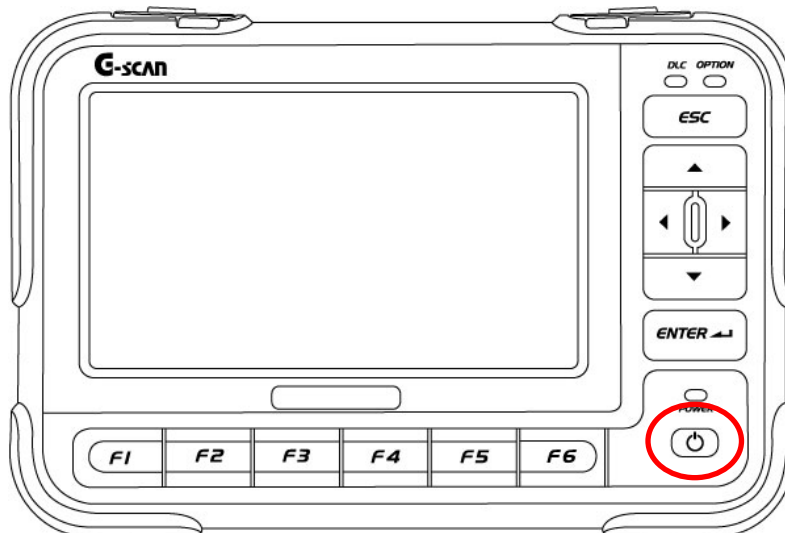

<Figure 1: Location of the Power S/W>

Power ON/OFF Method

Power ON

- 1) Check the power supplying condition of G-scan.

Notice:

For the details of power connection to the G-scan, refer to “Power Supplying” of the “Basic use of G-scan”.

- 2) Press the “Power Switch” shown in <Figure 1> until the DLC LED and OPTION LED located at upper right of the G-scan are turn from amber to green. (It requires about 0.5 seconds..)

Notice

For the lightening color of POWER LED, refer to the “Description for Main Component of H/W” of the “Basic Use of G-scan” (Module: A-02-003).

After booting the G-scan normally, the main screen of G-scan will be shown as <Figure 2>.

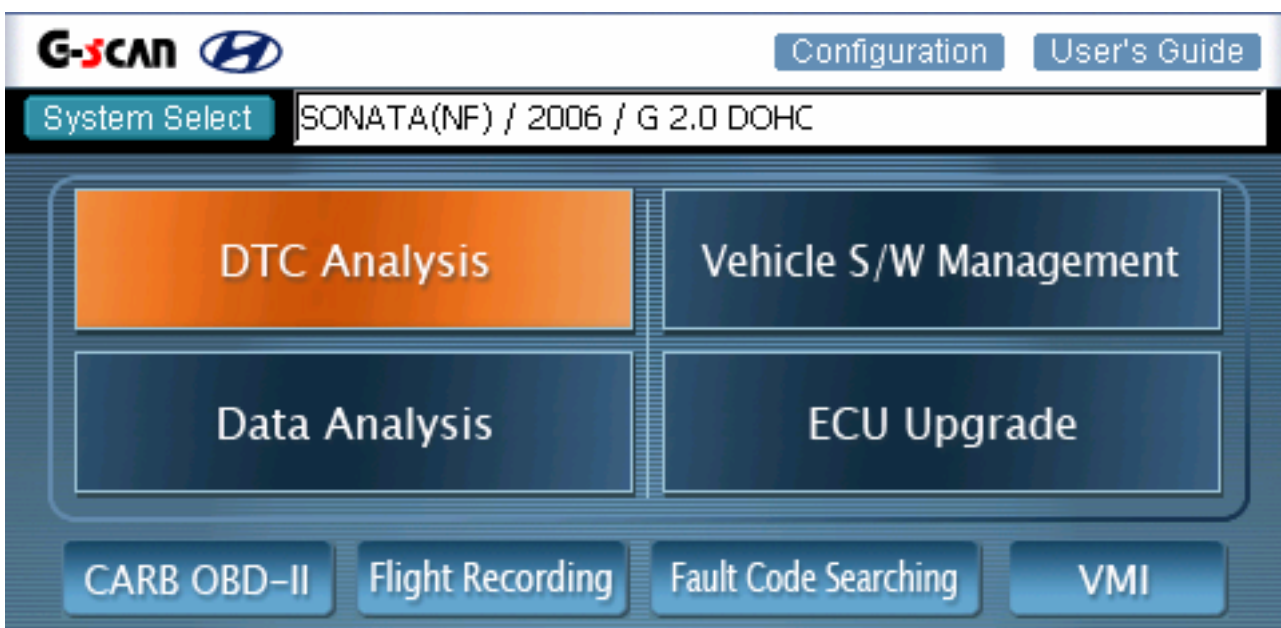

<Figure 2: Main Screen of G-scan>

Power OFF

- Press the power switch for 2.5 seconds, the G-scan will be turn off.



Description for Main Component of H/W



Basic Use of G-scan

Module NO: A-02-003





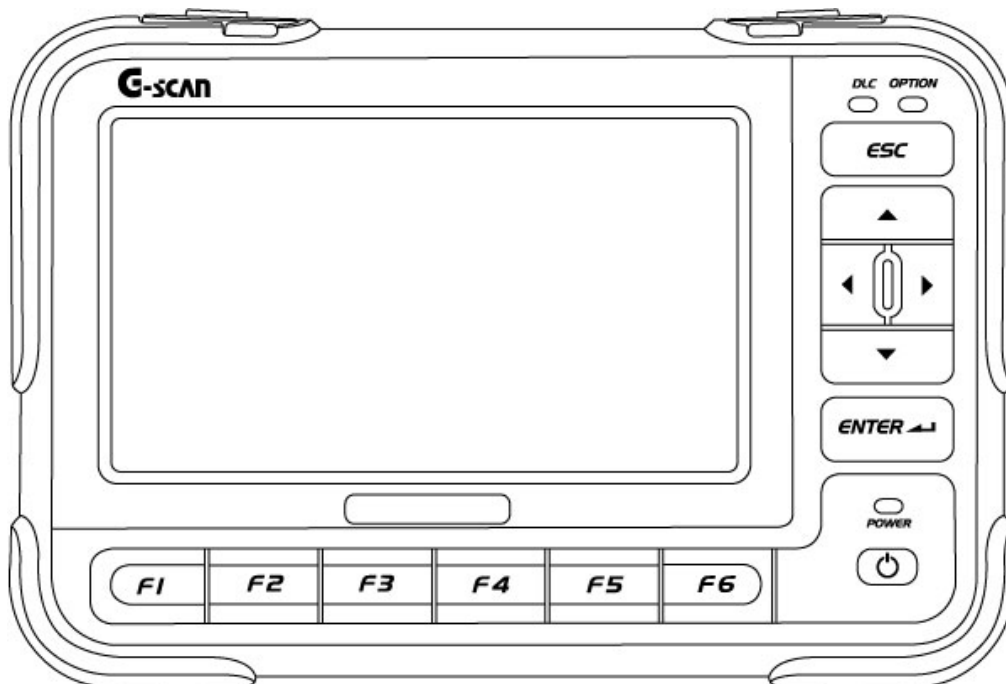

Even the G-scan is developed as its function can be operated through the touch screen, for more fluent operation of G-scan, please be familiar with the functions and positions of the buttons, terminals and LEDs installed at the G-scan hardware.

Touch Screen and Input Button

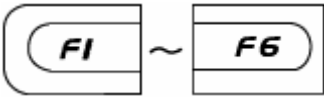

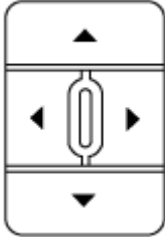
<Figure 1: Front view of G-scan>

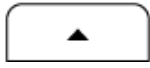
1. Description for Front side of Body

①	Touch Screen	Use the specific stylus pen at selecting functions and items on the touch screen
②		H/W buttons for operating functions represented in the screen function button at bottom of screen.
③		<ul style="list-style-type: none"> ◆ Exit from the screen currently executed. ◆ Move the previous screen at selecting model. ◆ Close the pop-up window.
④		<ul style="list-style-type: none"> ◆ Execute the item or function selected on the current screen ◆ Move to the next screen at selecting model.
⑤		<ul style="list-style-type: none"> ◆ Move the cursor to the wanted item or function on the current screen. ◆ At diagnosing in dual mode, you can select the diagnosing window with ,  and the items in the diagnosing window with , .
⑥	Power 버튼	ON/OFF the power of G-scan.
⑦	POWER LED	LED showing the power condition.
⑧	DLC LED	LED showing the communication condition with the control module installed in the vehicle.
⑨	OPTION LED	LED showing the communication condition with supplementary option item connected to G-scan.

Note:

As the CALIBRATION of the touch screen may be changed by the temperature variation or passing of the time, reset the CALIBRATION of the touch screen at the “Setup” in the Configuration.

Notice

For the details relating to the power ON/OFF, refer to the “Power ON/OFF” in the “Basic Use of G-scan” <Module NO: A-02-002>.

- POWER LED Lighting Condition

		Charging	Charged
Battery Pack Installation	With DC power	LED (Red) ON	LED (Green) ON
	Without DC power	LED OFF	LED OFF

Tips

If the battery pack is not installed, when the external power is connected, the Power LED lights the Green up.

Notice:

For the details of the power supplying, refer to the “Power Supplying” in the “Basic Use of G-scan” <Module NO: A-02-001>.

- DLC LED Lighting Condition

	LED operating condition
Communicate with Control Module	LED (Green) Flicker
Communication with Control module is OFF	LED OFF

- OPTION LED Lighting Condition

TPMS Pack (LF) wireless transmission	LED (Red) ON
TPMS Pack (RF) wireless reception	LED (Green) ON
Communication by USB port (Host) of the G-scan body	LED (Green) Flicker
Others	LED OFF

2. Description for the Communication Terminals

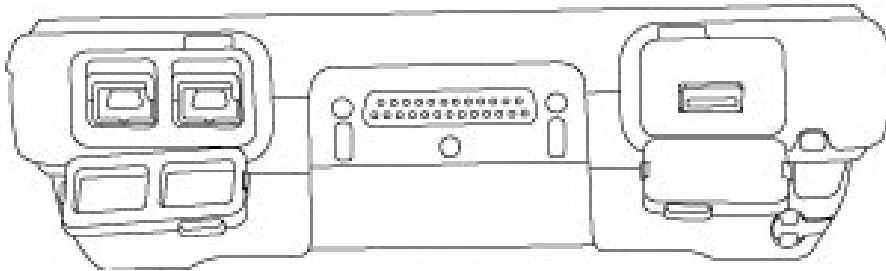

<Figure 2: G-scan COM port>

DLC		Terminal for connecting to DLC cable to communicate with vehicle.
OPTION		The USB Host port prepared for expanding the function by connecting to additional equipments in future.
PC COMM	PASS-THRU	The COM port for using the vehicle COM functions from the PC.
	DOWNLOAD	The COM port for maintaining the G-scan and expanding the functions in future.

3. SD Memory Slot & Reset Button

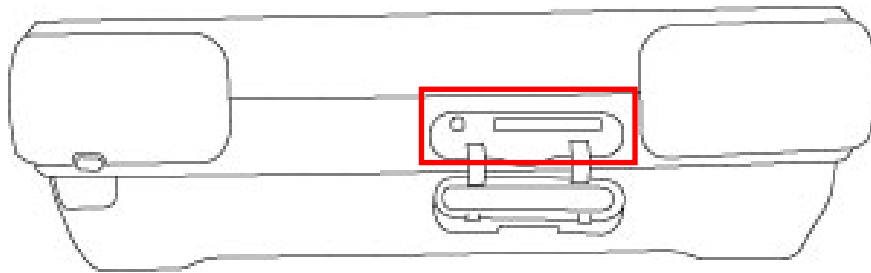

<Figure 3 SD Memory Slot and Reset Button>

SD Memory Slot	Slot for inserting the SD card restoring the various data for driving the G-scan.
RESET Button	When program has errors by the O/S or other problems, press the Reset button to turn OFF the G-scan in force. After pressing the Reset button, press the Power Switch to reboot the G-scan.



Description for the Main Component of the S/W Screen



Unlike the conventional diagnosis equipments, the screen of the G-scan is equipped with the touch screen. The images output on the G-scan screen are not simple pictures but the functional buttons for operating the diagnosis equipment.





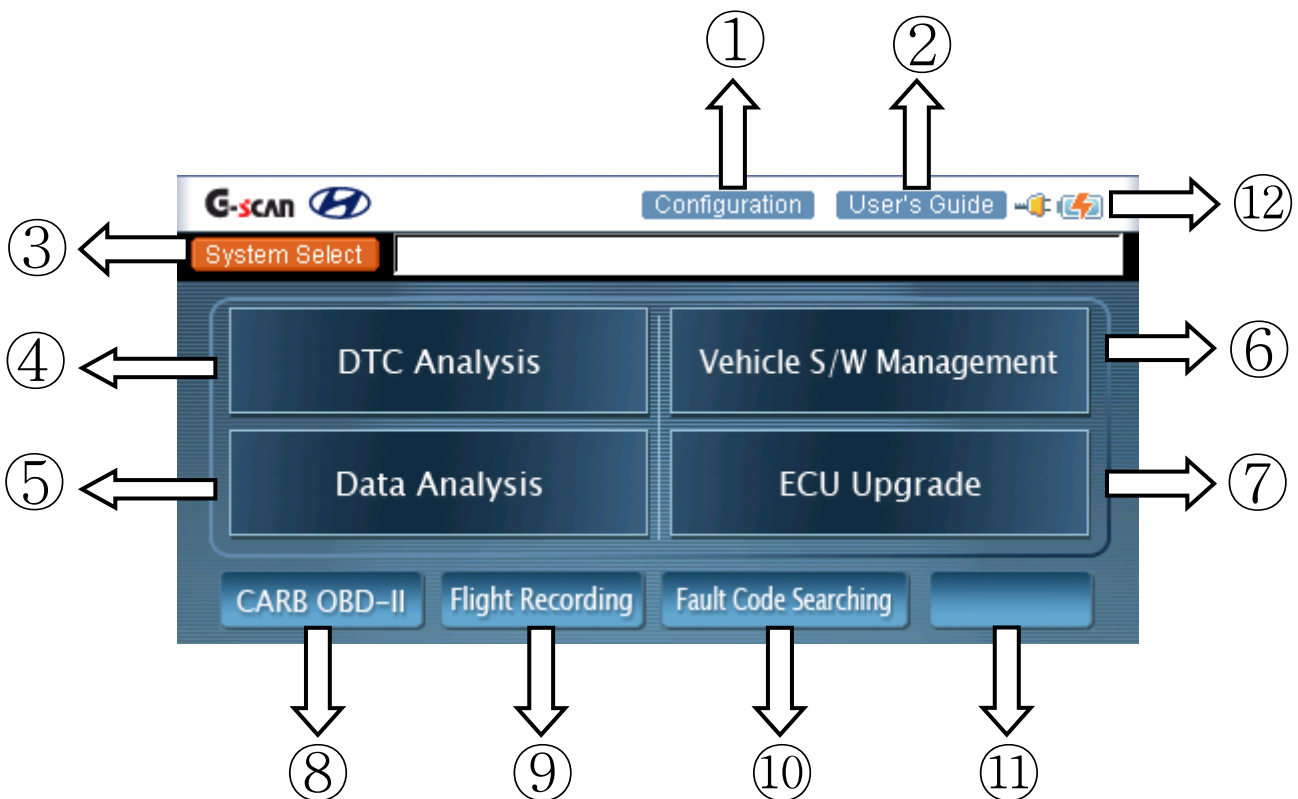





This chapter describes the functions and marks commonly applied to the Main Screen of the G-scan and other diagnosing screen. Please be familiar with these descriptions to operate G-scan freely.

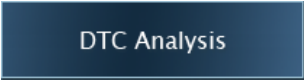



Components of the Initial Screen

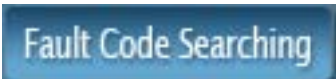

<Figure 1: Components of the Main Screen>

Description for the Components of the Initial Screen

Configuration and Help		
①		Configure or proceed to the "Setup", "User Information", "Software version" or "Self-diagnosis"
②		Support the Help for using this product.
Model Selection		
③		Select the model and system for diagnosing. * The selected system is shown in the window right side of the "System Select" button.
Diagnosis Menu		
④		Show the fault code on the screen by communication with the selected vehicle system. Show the additional fault codes by further communication.
⑤		Check the data of input/output device of ECU installed at the current vehicle by the communication with the selected vehicle system.
⑥		Support supplementary vehicle S/W function except the diagnosing functions (DTC, Current Data, Actuation Test).
⑦		Support the ECU upgrade.
⑧		Diagnose the vehicle applied with OBD-II COM program.
⑨		Recording the travel data, analyze the data.
⑩		Search the fault codes of vehicle systems setup in system selection multiply at the same time without re-selection of system.
⑪		At connecting GDS VMI (expanded install item), the multi-meter, oscilloscope, simulation test functions are possible.

⑫		외부 전원 연결 상태에서 배터리 충전중 표시 (번개 표시: 적색)
		외부 전원 연결 상태에서 배터리 만충전 표시 (번개 표시: 청색)
		방전중 배터리 사용 가능량 표시(배터리 사용에 따라 사용 가능량 표시가 한칸씩 줄어듭니다.)
		배터리 팩은 있으나 충전 배터리가 없는 경우

Note:

배터리팩 미적용 제품의 경우 메인 화면에 배터리 표시가 없습니다.

Diagnosis Screen Components







Data Analysis - SONATA(NF) / 2006 / G 2.0 DOHC		
Throttle Open(PWM)	4.7	%
Adapted Throttle Position	6.5	'
Battery Positive Voltage	14.5	V
Engine Coolant Temperature Sensor	54.0	°C
Engine Coolant Temperature Sensor (Model)	47.3	°C
Intake Air Temperature Sensor	0.8	°C
Canister Purge Duty	3.0	%
Cylinder 1 Injection Time	3.3	mS
Cylinder 2 Injection Time	3.3	mS
Cylinder 3 Injection Time	3.3	mS
Cylinder 4 Injection Time	3.3	mS
Torque Request From TCU	99.6	%
Oxygen Sensor Heating Time-Bank1/Sensor1	50	mS

<Figure 2: Diagnosis Screen>

Showing the Diagnosing Model and Hot Key



- The diagnosing item currently undergoing and the model for diagnosing are shown. For the right icons, refer to the following table.
- Description for the Common Icons in Diagnosing Window

	Closing the window currently undergoing, return to the initial main screen.
	Capture the screen currently undergoing and save it. The captured screen will be saved at the "Storage CardWG-scanImageWModel" folder of SD memory inserted into G-scan.
	Show the data of the system currently communicating in detail.
	Change the system for diagnosing except the vehicle model.
	Change to the dual mode from the overall screen.
	Change to the overall screen from the dual mode.

Diagnosing Window

According to the diagnosis mode of the G-scan, it shows the data and the results of the diagnosis.

Throttle Open(PWM)	4.7	%
Adapted Throttle Position	6.5	'
Battery Positive Voltage	14.5	V
Engine Coolant Temperature Sensor	54.0	'C
Engine Coolant Temperature Sensor (Model)	47.3	'C
Intake Air Temperature Sensor	0.8	'C
Canister Purge Duty	3.0	%
Cylinder 1 Injection Time	3.3	mS
Cylinder 2 Injection Time	3.3	mS
Cylinder 3 Injection Time	3.3	mS
Cylinder 4 Injection Time	3.3	mS
Torque Request From TCU	99.6	%
Oxygen Sensor Heating Time-Bank1/Sensor1	50	mS

<Figure 3: Data Output Window>

Screen Function Button

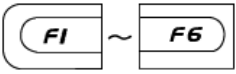

<Figure 4: Screen Function Button>

At the diagnosis item currently undergoing, the functions of the function button  are shown. the function can be operated by selecting it using the stylus pen.

Tips:

The property of the screen function button will be changed according to the diagnosis mode (or the activated window at the dual mode).

For the communication between the control module installed at the vehicle and the G-scan, the DLC cable should be connected.

According to the kinds of connector used in the communication, there are different in connection of power supplying line and the adaptor connection.

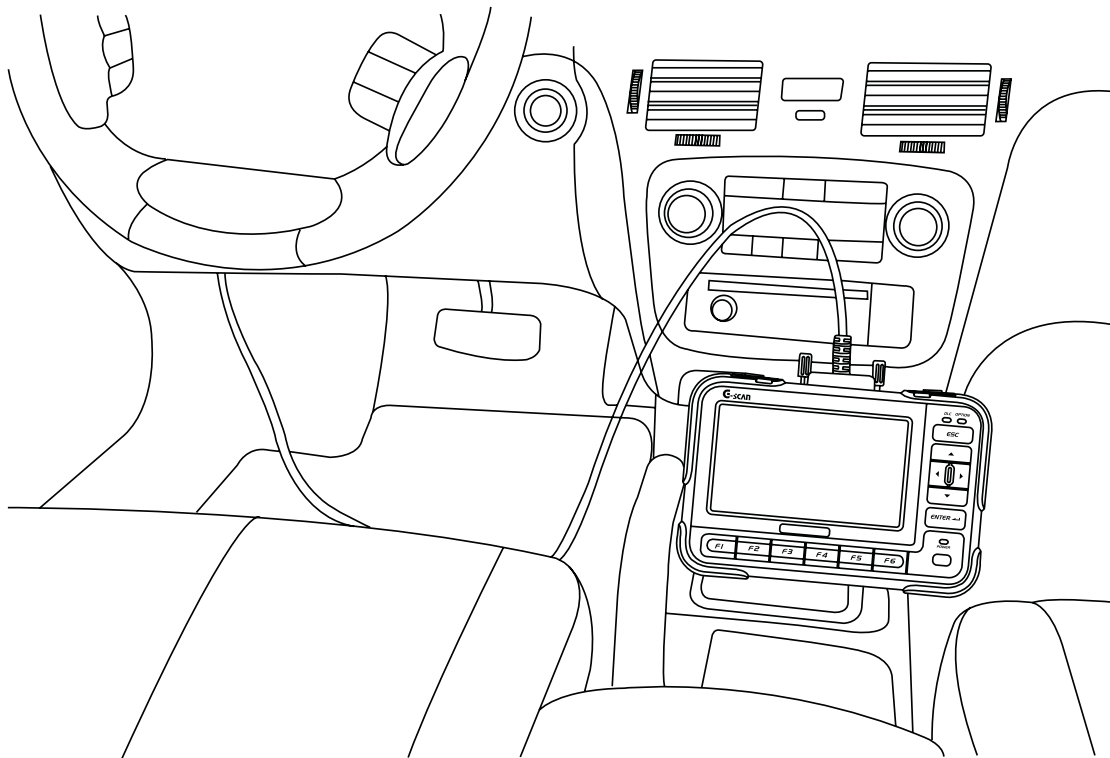

<Figure 1: Connecting the DLC cable>

Vehicle with the OBD-II Standard Connector

Only with the DLC COM cable without additional power line, it is possible to communicate with control module and to supply power.

Tips

In general, the DLC connector is located at the lower part of the driver's front panel. According to the kinds of vehicle, it may be different. Therefore, before connecting, please check the correct position at first.

Vehicle without the OBD-II Standard Connector

Connecting the power

For the vehicle without the OBD-II standard connector, connect the power line additionally for operating the G-scan

Connecting the vehicle diagnosis

For the communication with the control module installed at the vehicle, additional adapter is required. After connecting the adapter to the 16th pin of the DLC cable, connect it to the COM connector terminal of the vehicle.

Notice:

For the power supplying, refer to "Power Supplying"<A-02-001> in the "Basic Use of G-scan".



Caution

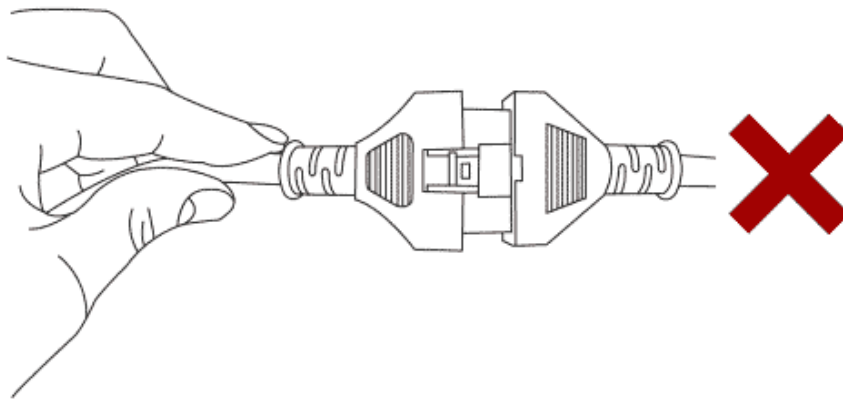
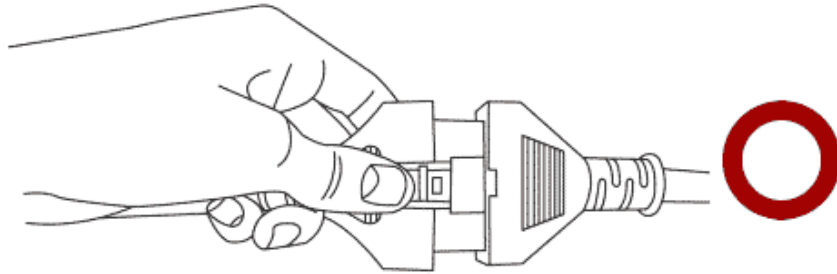

When disconnecting the main DLC cable, press the locking clip. Do not pull the wire or distort it. It may cause the damages of the cable or connector.

Caution

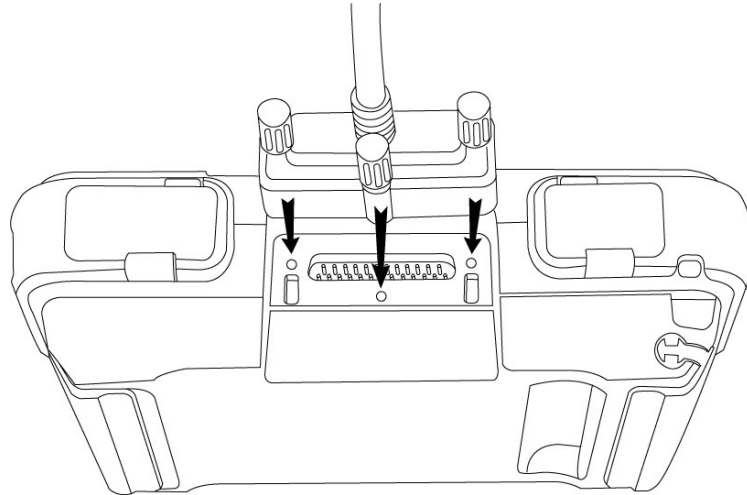

At connecting the main DLC connector to the G-scan, tighten the 3 clamping screws to the body of G-scan firmly.

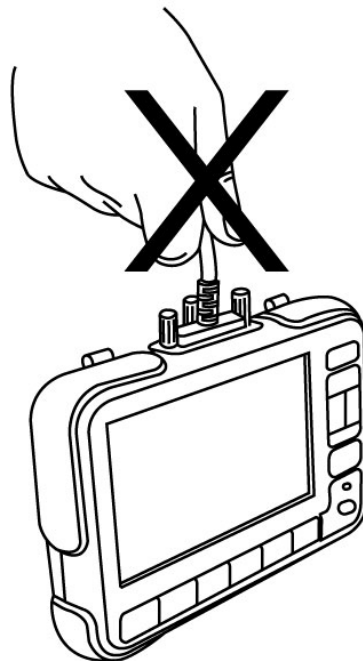

At carrying the G-scan, do not hold the DLC cable. Hold the module body or hand strap.



The self-test functions are used to check the Main DLC cable (P/No: G1PDDCA001) and specific related circuits. Not all G-scan circuits are checked with the self-test functions.

Purpose and Scope of Self Test (Semi-Test)

Basic operation of the self-test function is the loop-back theory.

Loop-back theory is verification between sent data from the G-scan module and returned data, which passed through the pins of all the outside connectors during the self-test.

Some communication circuits such as high speed CAN, low speed CAN and SAE-J1708, cannot be checked with loop-back tests.

There are 2 self-test steps included in the Self Test function on the Configuration menu.

- Step A: Performs test functions by automatically changing circuit Configurations at the inner end of DLC connector of the G-scan module.

- Step B: Performs test functions on the Main DLC cable using the self-test adapter which will short all the terminals (except power and ground functions) at the end of Main DLC cable.

This self-test function cannot determine open or short circuits in other adapter cables except Cable-DLC (P/No: G1PDDCA001).

Connecting the Self-Test Adapter (GHDM – 24D000)

Before performing the self-test function, connect the Main DLC cable (P/No: G1PDDCA001) between G-scan module and Self-test adapter (P/No: GHDM – 24D000). Then, connect the other side of Self-test Adapter to the OBD- II Connector on the vehicle as shown in [Figure1].

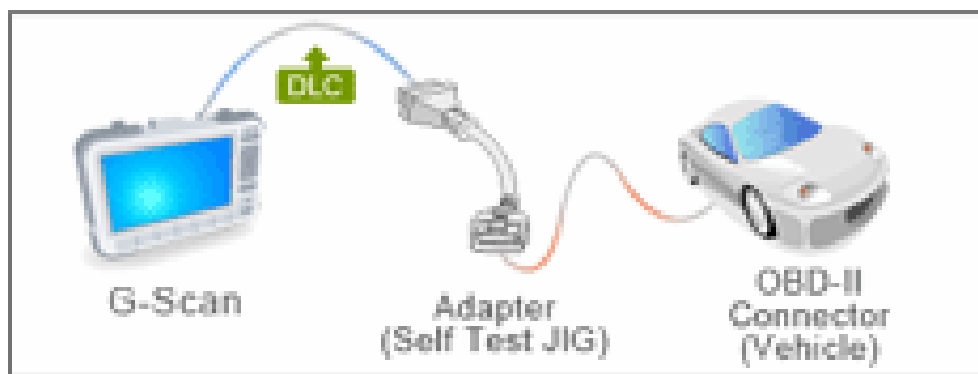

Figure 1. Installation of the Self-test adapter

After installing the adapter, follow the instructions as indicated on the Self-Test screen located on the Configuration menu.

Configuration

Selecting **Configuration** at the main screen, “Setup” screen will be shown. In this item, the brightness of touch screen can be adjusted for the user's favor, the language can be selected and the operation of key pad and calibration of the touch screen can be controlled.

Introduction of the Setup Main Screen



<Figure 1: Setup Screen>

The descriptions for the screen function button in “Setup” are as follows.

Back Light	Item for setup the brightness of LCD screen.
Language	Item for setup the language.
Key Pad	Checking the operations of the 12 function buttons.
Touch SCR	Calibrating of the touch screen.
Unit	Set the diagnosis Data unit and the Buzzer ON/OFF.
Move Tab	Move to the next Tab.



Screen Brightness Adjustment

1) Select the “Back Light” item to change the gray scale of ambient color.

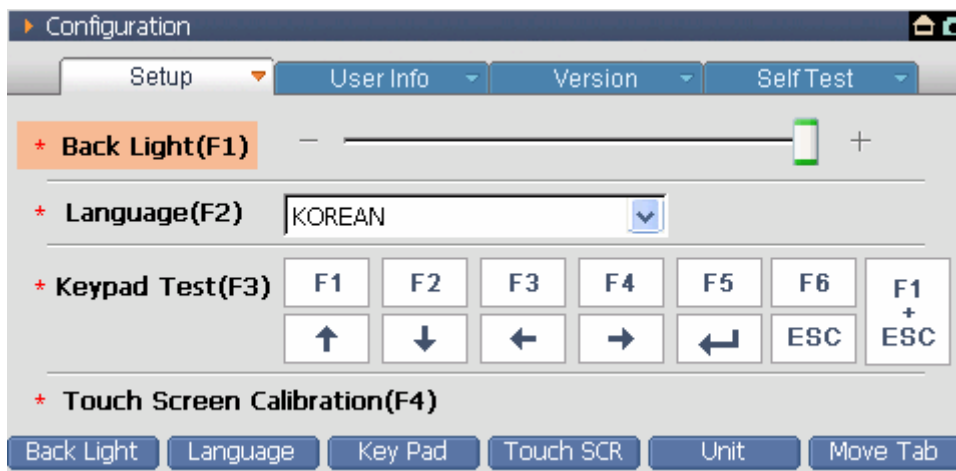
- ◆ Select the function button .
- ◆ Select the  at the bottom of screen on the touch screen.
- ◆ Select the “Back Light(F1)” on the touch screen.



<Figure 2: Back Light Adjustment>

2) Adjust the brightness using stylus pen or pressing the   on the keypad.



3) It can be adjusted with 5 levels. Screen will be brighter as it is adjusted to (+).

4) Item movement after adjusting screen

- ◆ Using stylus pen, move to the item directly on the screen
- ◆ Selecting the , move to the menu and use the direction arrow keys to move to wanted item.

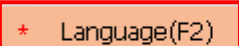

Language Selection

1) Selecting the “Language” item, the gray scale of around is changed.

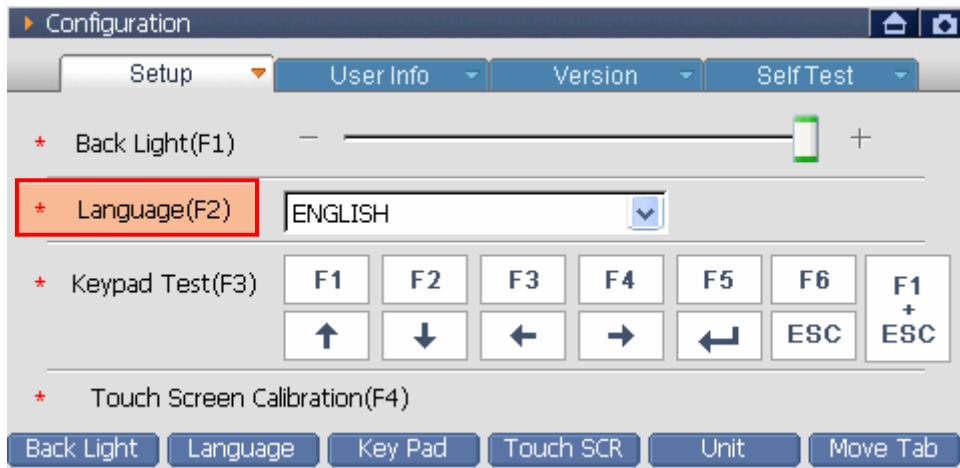
- ◆ Select the function button .
- ◆ Select the  at the bottom of the touch screen.
- ◆ Select the  of “Language(F2)” on the touch screen.



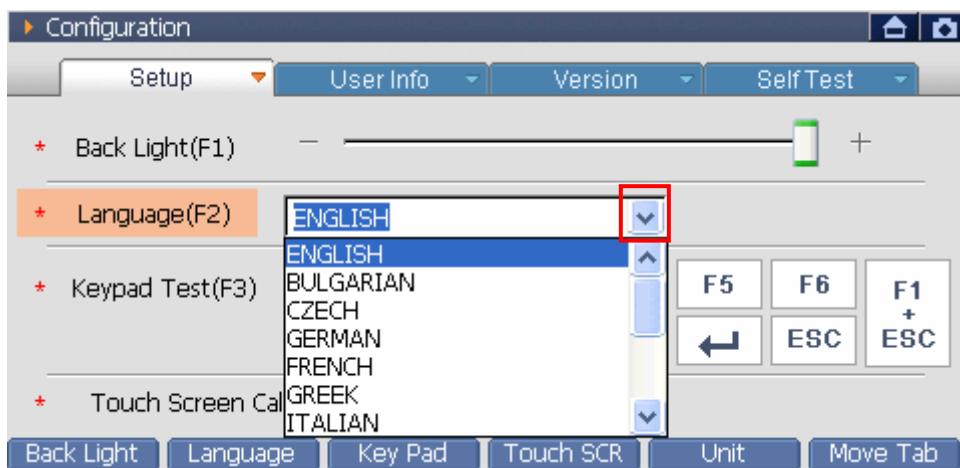

<Figure 3: Move to Language Selection>

2) Using the stylus pen, press the right mark of language window or , and press the . Then language list will be shown.





<Figure 4: Language Selection>

3) Change item after selecting language

- ◆ Using stylus pen, select item want to move on the touch screen.
- ◆ Select  or  to move to menu, change item using arrow keys

Keypad Test

1) Selecting “Keypad Test” item, around color is changed as shown in <Figure 5>.

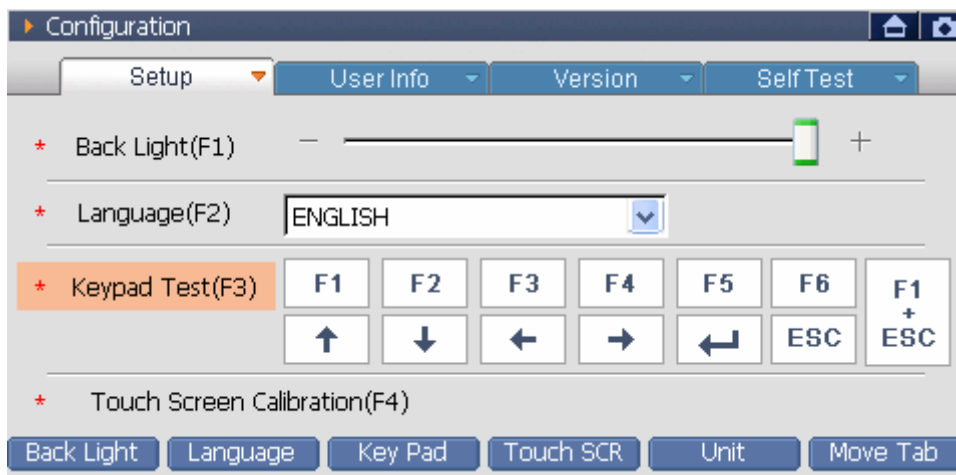

- ◆ Select the function button  .
- ◆ Select  at the bottom of the touch screen.
- ◆ Select the “Keypad Test(F3)” on the touch screen directly.



<Figure 5: Keypad Test>



2) Pressing the function button F1~F6, arrow keys, ENTER, ESC key, the color of position representing mark of button will be changed to orange color. You can easily check the button condition.

3) Change Item after completing Keypad Test

- ◆ Select item want to move on the touch screen using stylus pen.
- ◆ Select  +  at the same time, move to menu. Using arrow keys, move to the wanted item.

Calibration of Touch Screen

Selecting the “Touch Screen Calibration(F4)” item, following screen will be shown.

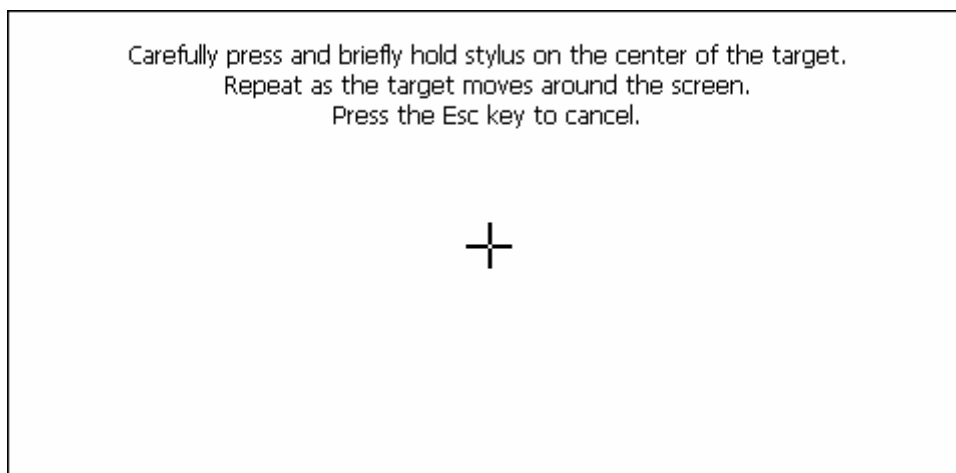

- ◆ Select the function button .
- ◆ Select the  at the bottom of the touch screen.
- ◆ Select the “Touch Screen Calibration(F4)” directly on the touch screen.



<Figure 6: Calibration of Touch Screen>

- 1) Select the center of (+) mark on the touch screen as shown in the above figure with the stylus pen.
- * Totally 5 points are shown on the screen. Select all center points of the 5 marks.

2) After selecting 5 centers of (+) marks, message is shown in <Figure 7>.

- ◆  : Save the new calibration and move to menu.
- ◆  : Cancel the new calibration and move to menu.

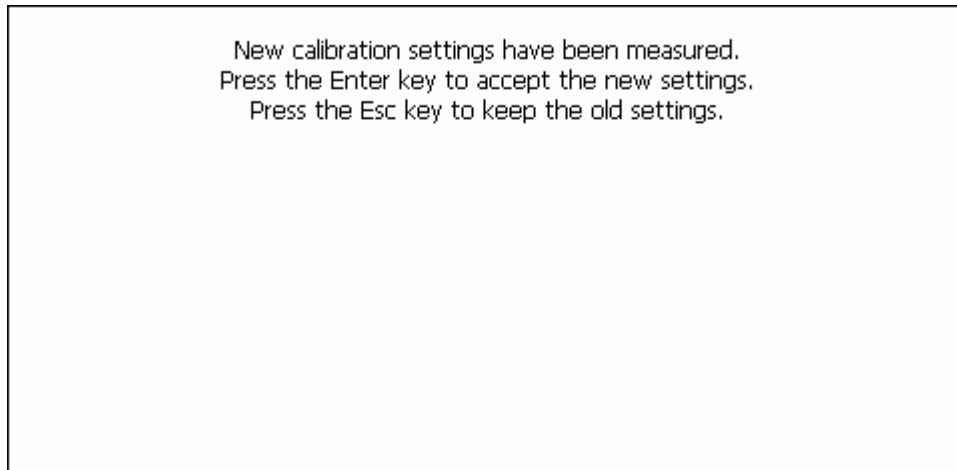

<Figure 7: Completion of the Touch Screen Calibration >

Setup for Unit and Buzzer ON/OFF



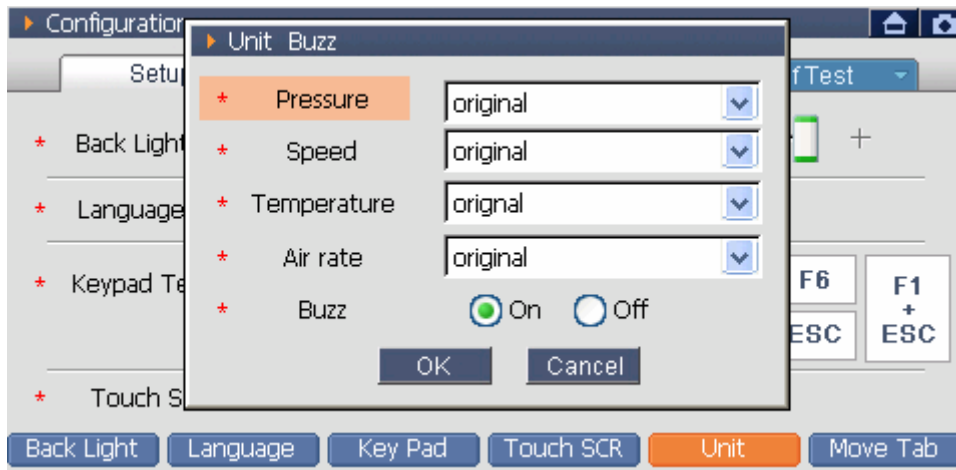

1) Selecting **Unit** or 'F5', following setup window will be shown.



<Figure 8: Unit & Buzz setup>

2) Setup the Unit and Buzz operation in the setup window.

- ◆ Using stylus pen, setup on the touch screen.
- ◆ Setup using the function button

①		Change to the wanted item among the setup items
②		Select the item to setup
③		Unit: select wanted unit in the list. Buzz: select ON or OFF
④		Unit: after selecting unit, move to setup list. Buzz: after setup ON/OFF, move to setup list.
Repeating ①~④, setup the unit		

3) After completing all setup, select  at the bottom of setup window.

Notice:



The unit selected at this Tab is applied to the unit of data represented in the diagnosis function.

Exit from “Setup”

After completing “Setup” item, move to other Tab.

- ◆ Select  to move to “User Info”.
- ◆ Using stylus pen, select the “Tab” on the upper portion of the touch screen directly to move.



Move to the main screen

- ◆ Select  to move to the main screen.
- ◆ Select  at the right upper portion of the screen to move to the main screen.

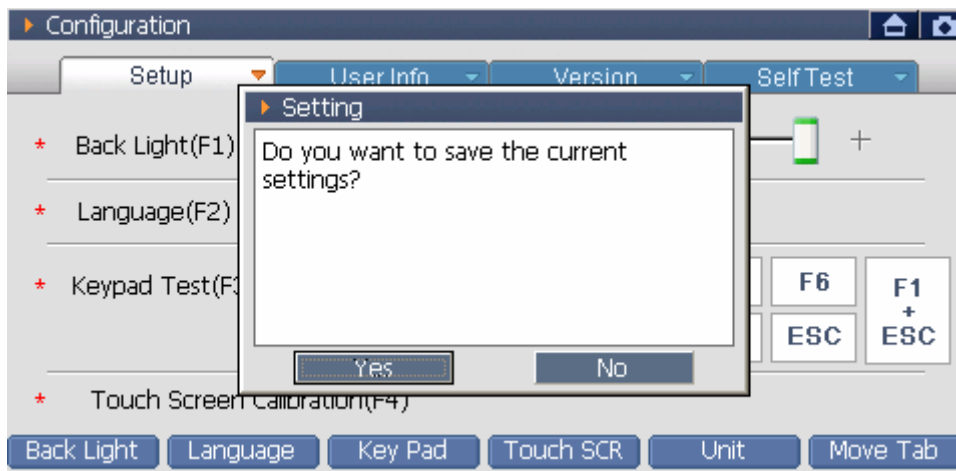
Selecting ‘Move to main screen’, following message will be shown.



<Figure 9: Save Message>

	Save the setups and exit to the main screen.
	Cancel the setups and exit to the main screen.

“Back Light”, “Touch SCR”, “Unit” among the “Setup” items will be save with the final setups regardless of this message shown at moving to main screen.

This is the item for inputting customer's personal information.

To change items in the below level of 'User Info' item, use the touch screen and the function button. To input personal information, use the touch screen only.

How to input the User Information

How to change to "User Info" item

- ◆ Selecting the "User Info" on the touch screen using the stylus pen, following screen will be shown.
- ◆ Select the **MOVE TAB**, **F6** buttons in the "Setup" to move to "User Info".

How to change between "User Info" lists

- ◆ Select the items on the touch screen using the stylus pen.
- ◆ Using arrow keys (Up, Down) of the function button, move to the list want to input and press the arrow key (right) to select it.

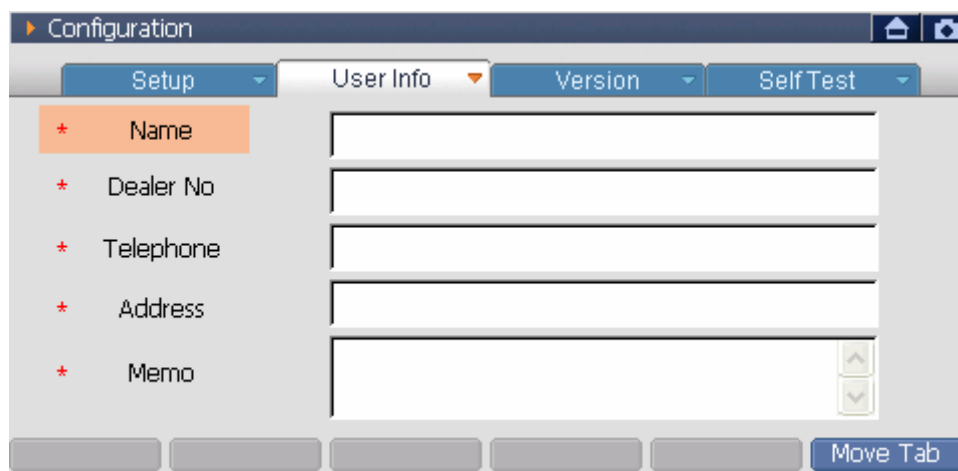





<Figure 1: User Info Screen>

Input the personal information

It is impossible to input the information using the Function & Supplementary Function buttons. Use the stylus pen on the touch screen to input personal information.

How to input

- 1) Using stylus pen, at the “User Info” screen, select the input window or using the direction button  , select the User Info list and select the , then following keyboard will be shown.
- 2) Using the stylus pen, press the keyboard on the touch screen to input the personal information.
- 3) After input the user information, select  or select other input window using the stylus pen.

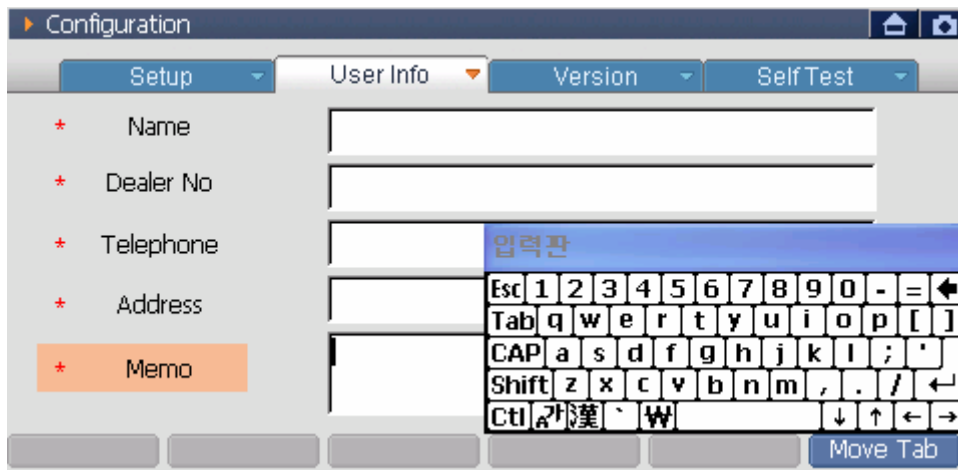



<Figure 2: Screen Keyboard>

Exit from “User Info”

After setup the “User Info” item, move to other Tab

- ◆ Select the  to move to “Version”.
- ◆ Select the “Tab” at the upper side of the touch screen using the stylus pen to move.



Move to main screen

- ◆ Select  to move to the main screen.
- ◆ Select  at the upper right side of the touch screen to move to the main screen.

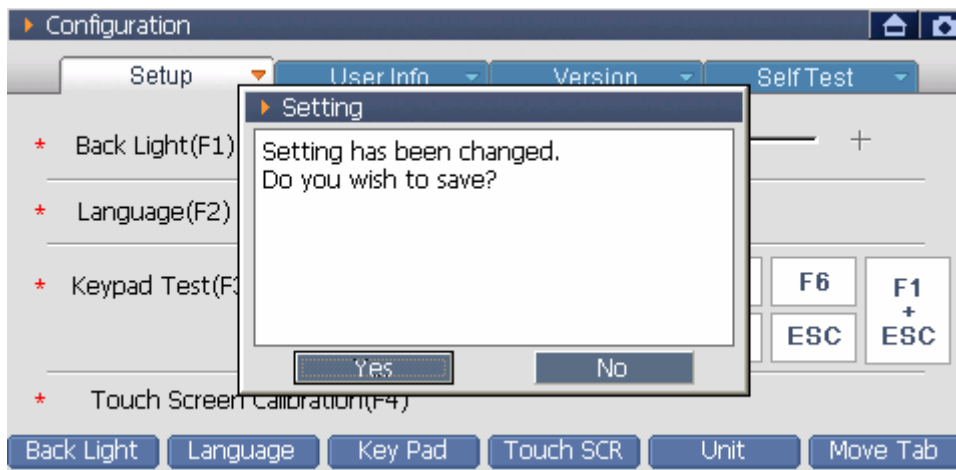
Selecting the ‘to main screen’, the following message will be shown.



<Figure 3: Save Message>

	Save the setups and move to main screen.
	Cancel the setups and move to main screen.

It is the item for checking the software version of the G-scan and for updating the firmware of VMI and TPMS, the expansion equipments. Check the version and update the software to the latest version.

Description of Version Information Screen

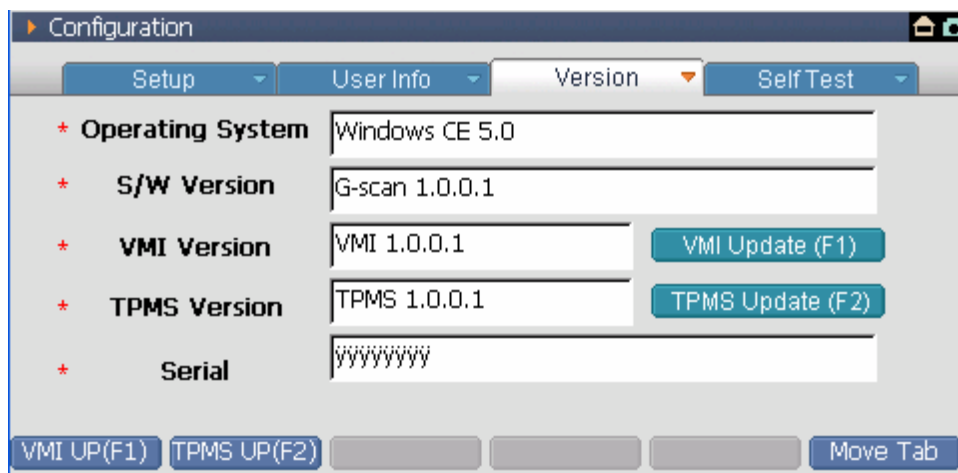



<Figure 1: Version Information Screen>

		Update the VMI Firmware.
		Update the TPMS Firmware.

How to check Version & to update the Expansion equipment

How to move to the “Version” item

- Using the stylus pen, select the  on the touch screen to move to the “Version” screen.
- Press the  or  button in the “User Info” to move to the “Version” item.

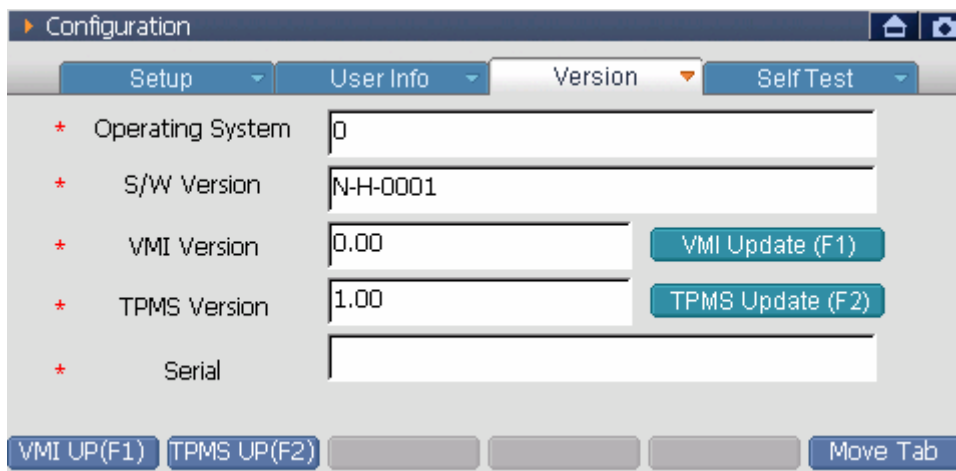

<Figure 2: Version Information Screen>

How to update VMI

- 1) Select **VMI Update (F1)** or **VMI UP(F1)** on the touch screen using stylus pen or press the function button , then following screen will be shown.

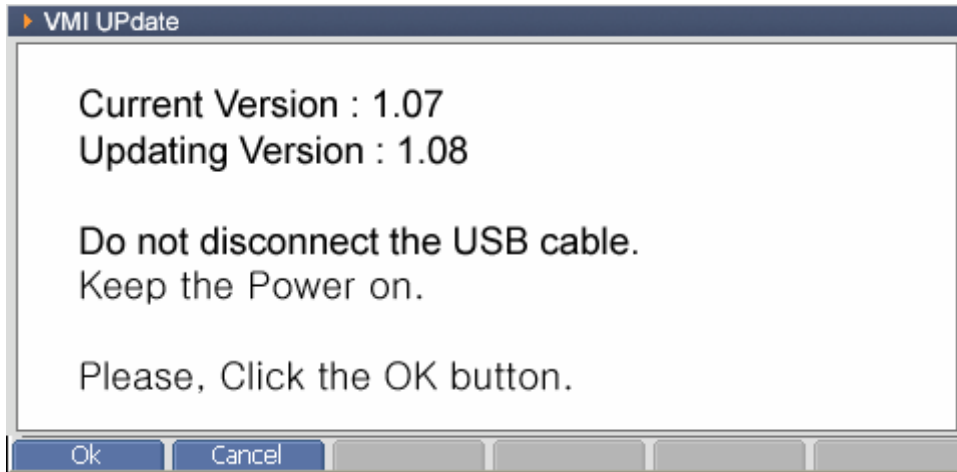

<Figure 3: VMI Update 1>

If the current version of Firmware is the latest version, then the following screen will be shown.

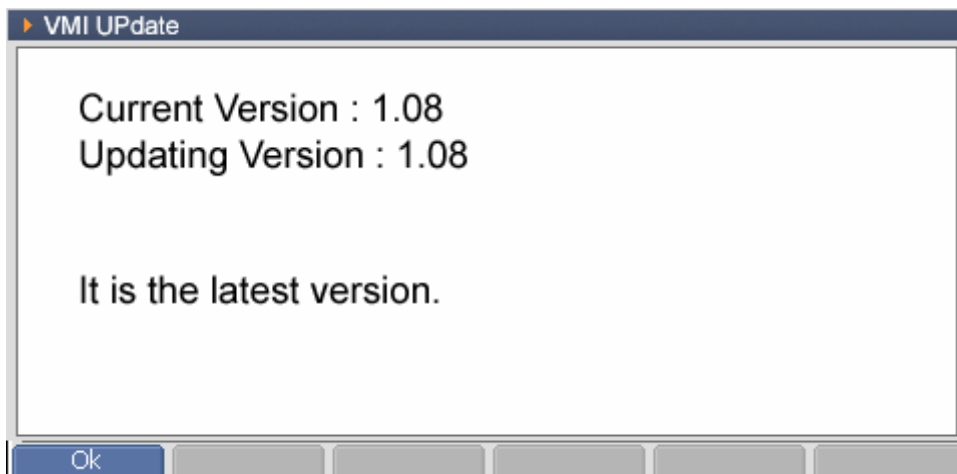

<Figure 4: VMI Update 2>

- 2) Select , following screen will be shown and the update is started.

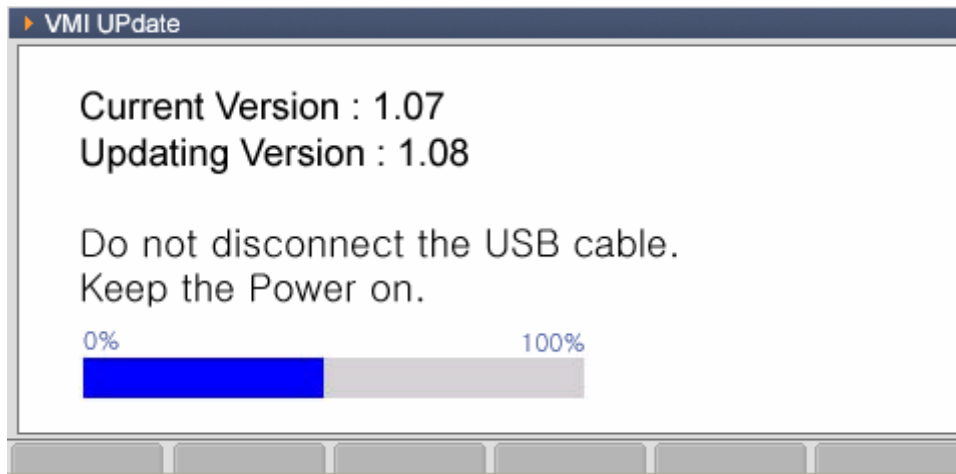

<Figure 5: VMI Update 3>

- 3) After completing the update, the following message will be shown. Check the version and press the  key.

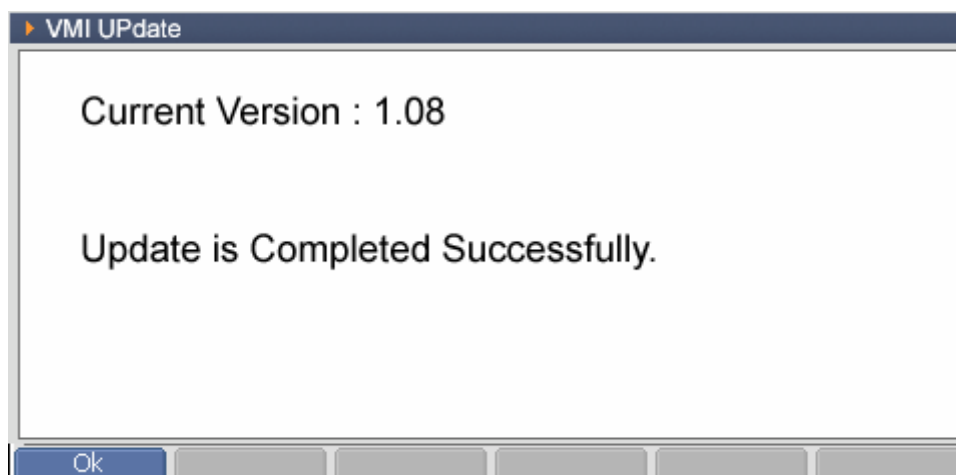

<Figure 6: VMI Update 4>

How to update the TPMS

- 1) Select **TPMS Update (F2)** or **TPMS UP(F2)** on the touch screen using the stylus pen or press the supplementary function button **F2**..

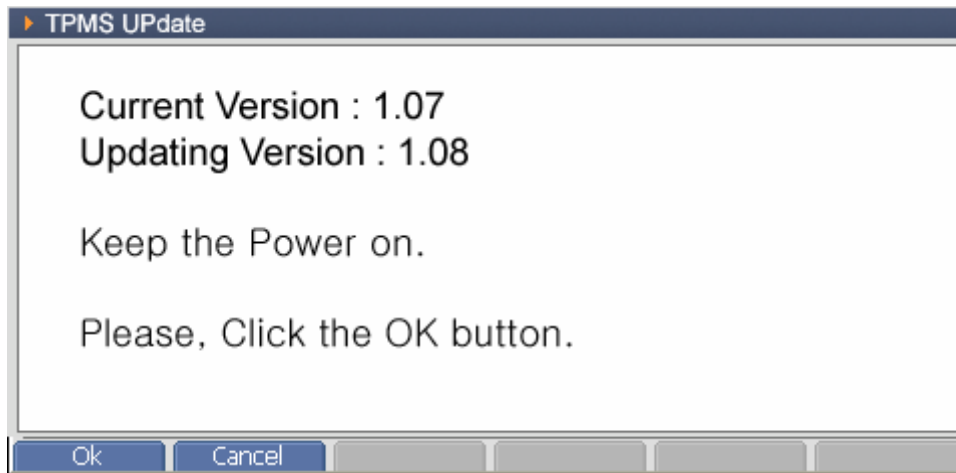

<Figure 7: TPMS Update 1>

If the current version of the Firmware is the latest version, then the following screen will be shown.

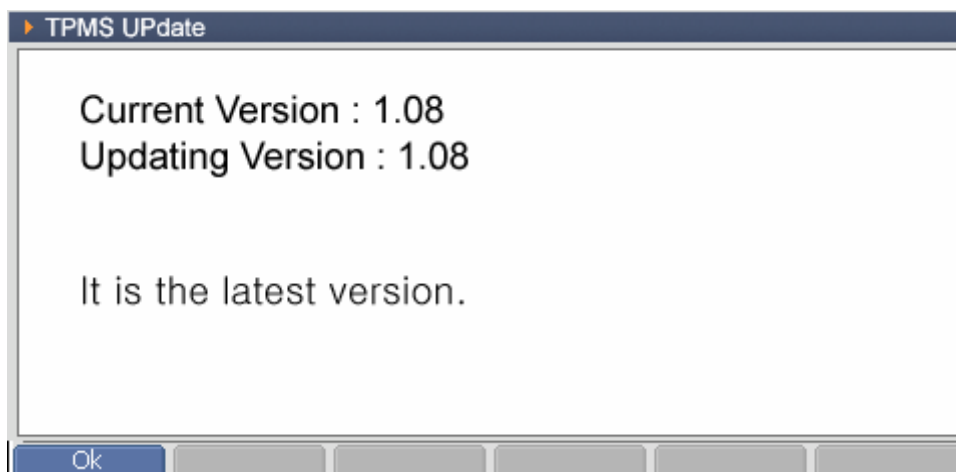

<Figure 8: TPMS Update 2>

- 2) Select **Ok**, then the following screen will be shown and the update will be started.

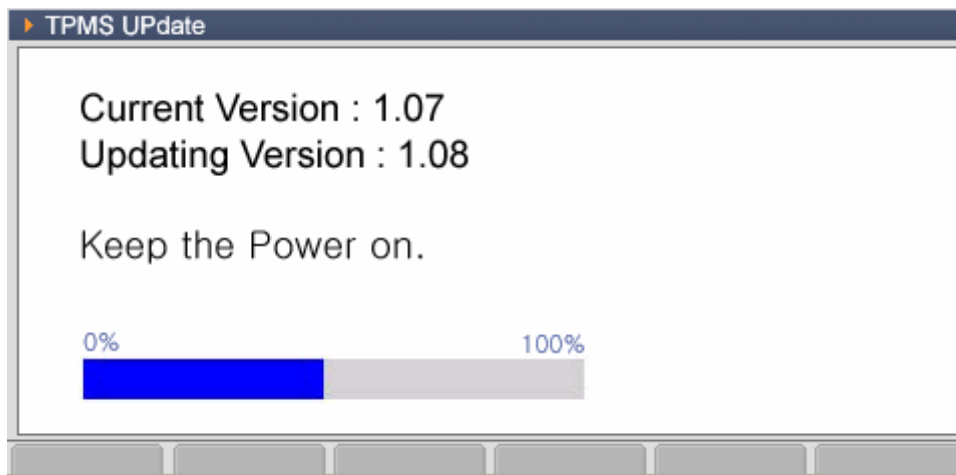

<Figure9: TPMS Update 3>

- 3) After completing the update, the following message will be shown. Check the version and press the **Ok** key.

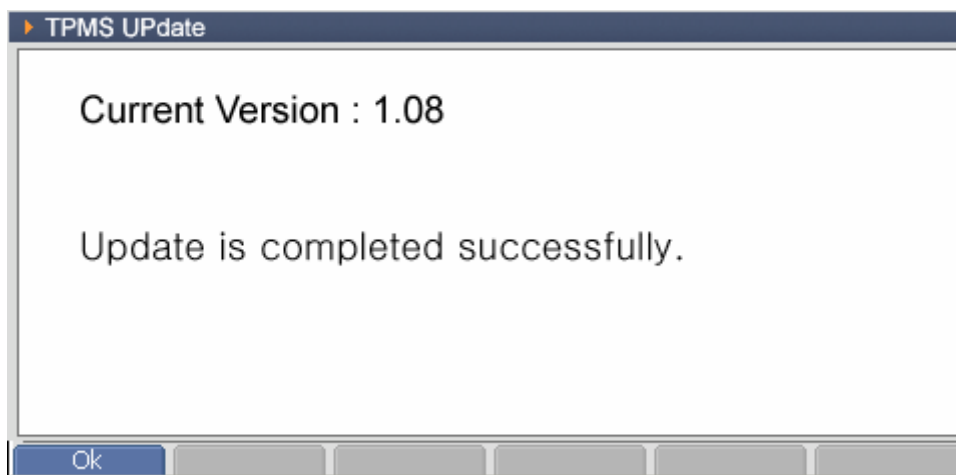



<Figure10: TPMS Update 4>

Exit from “Version”

After setup the “Version” item, move to other Tab.

- ◆ Select the  to move to the “Selftest”.
- ◆ Using the stylus pen, select the “Tab” at the upper side of the touch screen.



Move to the main screen

- ◆ Select the  to move to the main screen.
- ◆ Select the  at the upper right side of the touch screen to move to the main screen.

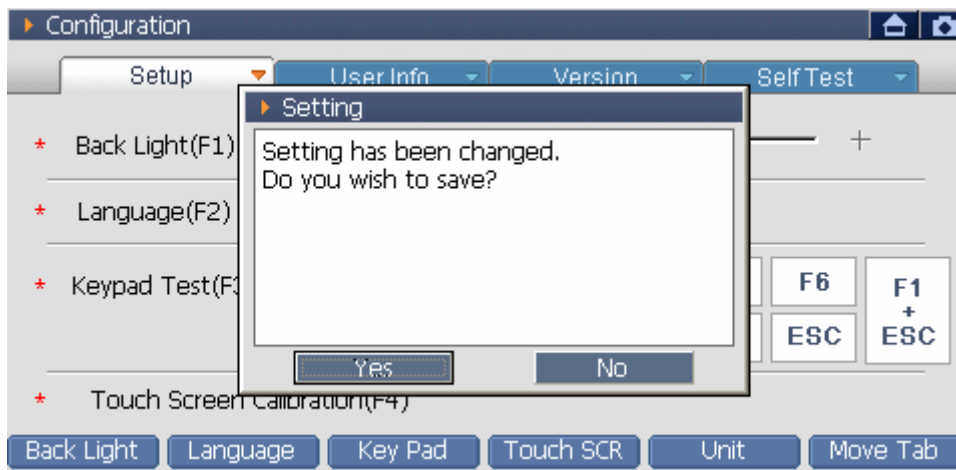
Selecting ‘Move to main screen’, the following message will be shown.



<Figure 11: Save Message>

	Save the setups and move to main screen.
	Cancel the setups and move to main screen.

It is the function for checking if the circuits relating to the communication of G-scan and the DLC cable have defects or not. If the equipment has problems relating to the communication function, conduct test following to the instruction of the screen.

Description of Self Test Screen

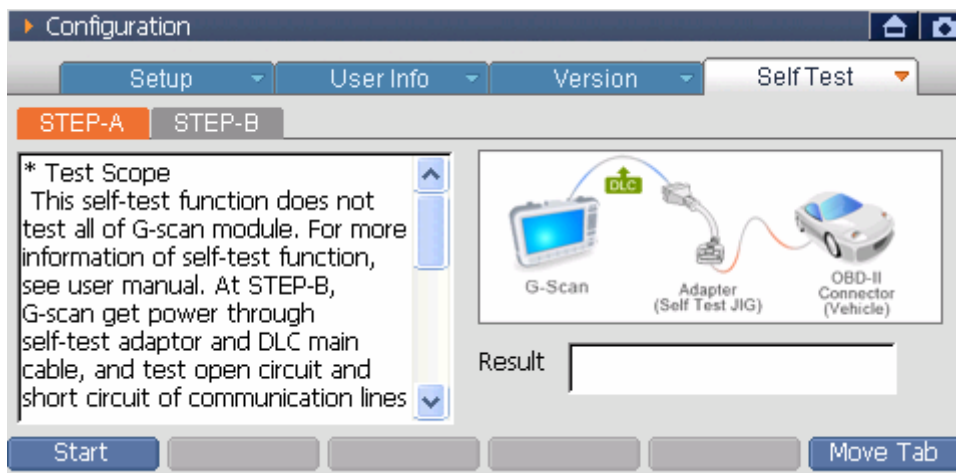

<Figure 1: Description of Self Test Screen>

STEP-A	Item for checking the defects of circuits relating to the communication of G-scan.
STEP-B	Item for checking the defects of the DLC cable.
START	Start the Self Diagnosis Test.

Self Diagnosis Test

How to change to the “Self Test” item

- Selecting the “Self Test” on the touch screen using the stylus pen, the following screen will be shown.
- Press the **에서** **MOVE TAB** , **F6** button at “Version” to move to the “Self Test”.

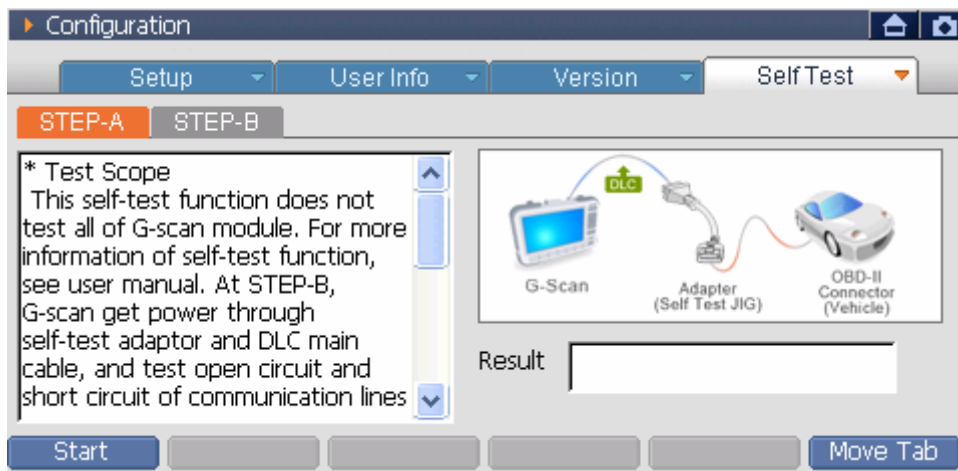

<Figure 2: Move to the Self Test>

- Using the stylus pen, select it on the touch screen or press the direction buttons **◀** **▶** , then **STEP-A** , **STEP-B** can be selected.

STEP-A Test

The purpose of STEP-A test is for diagnosing the specific communication circuit of the G-scan. During proceeding with this test, the power is supplied by the DLC cable and the Self Test adapter. For the details of Self Test adapter, refer to the 'Connecting the Self Test adapter' in the 'Basic Use of G-scan'.

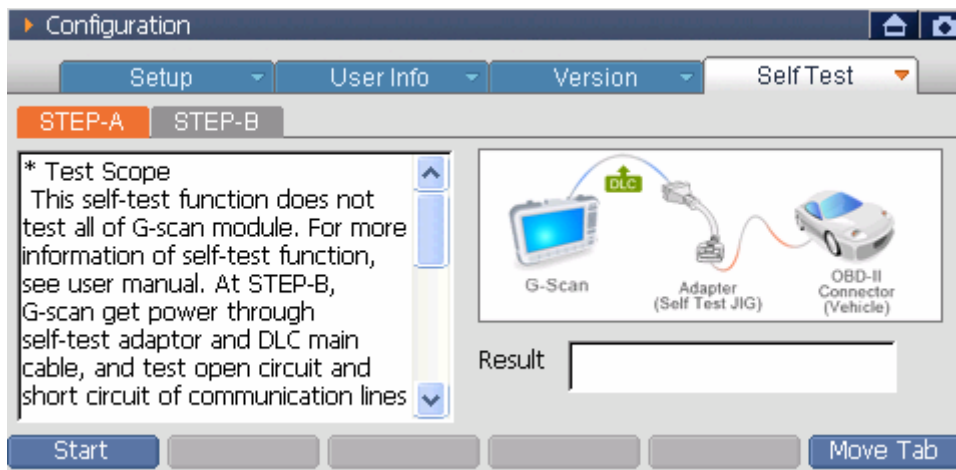

<Figure 3: Self Test A Screen>

Method for proceeding with the test is as follows.

- 1) Connect the DLC cable to the G-scan and connect the Self Test adapter to the other end of DLC cable. Connect the adapter to the OBD-II connector of the vehicle.
- 2) Turn the power of G-scan ON and change to the 'Self Test' item of configuration.

3) After selecting the **STEP-A**, select the **START** or 'F1' to proceeding to the test.

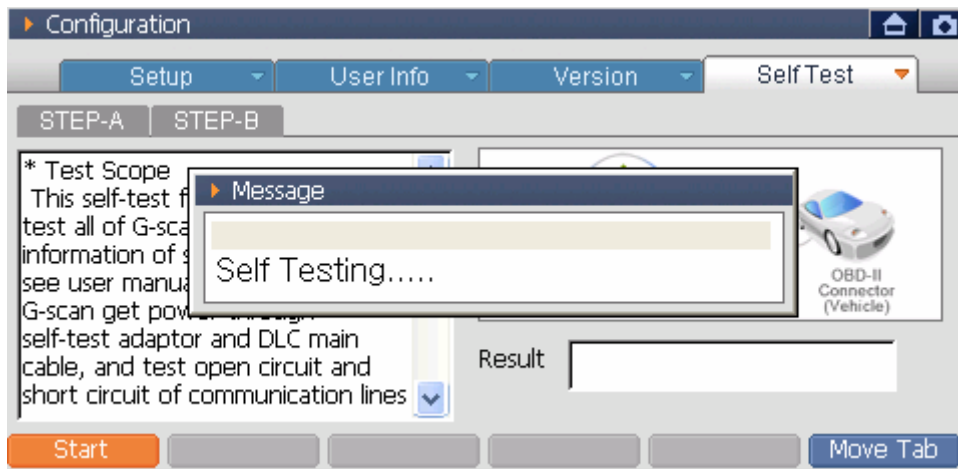

<Figure 4: Self Test A Proceeding 1>

4) Check the 'Test Result' shown on the test result window.

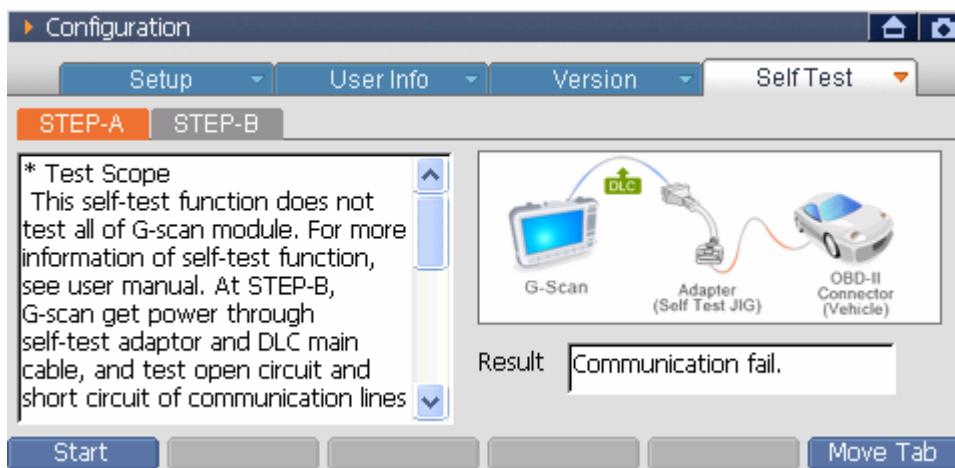

<Figure 4: Self Test A Result>

Good: Proceed with the test of 16-pin DLC cable; begin the "STEP-B" test.

Failure: G-scan main module may be inoperative. Contact the authorized service provider

STEP-B Test

The STEP-B test is the function for checking if the DLC main cable line is broken or shorted with the condition in which the communication module of G-scan is normal state. During proceeding to this test, the power is supplied by the DLC cable and the Self Test adapter. For the details of Self Test adapter, refer to the 'Connecting Self Test adapter' in the 'Basic Use of G-scan.'

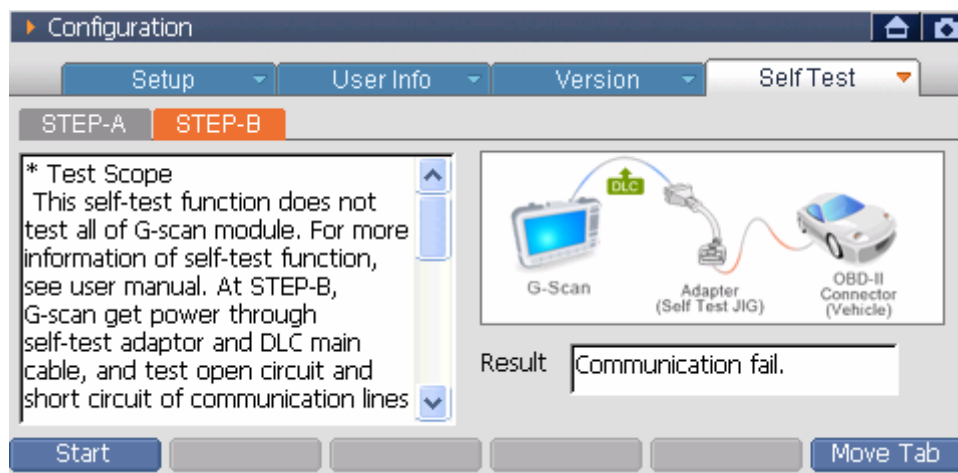

<Figure 5: Self Test B Screen>

The method for proceeding to test is as follows.

- 1) Connect the DLC cable to the G-scan and connect the other end to the Self Test adapter. Connect the adapter to the OBD-II connector of the vehicle.
- 2) Turn the G-scan power on to move to the 'Self Test' item of the configuration.

- 3) Select the **STEP-B** and then select the **START** or 'F1'. The test will be proceeding.

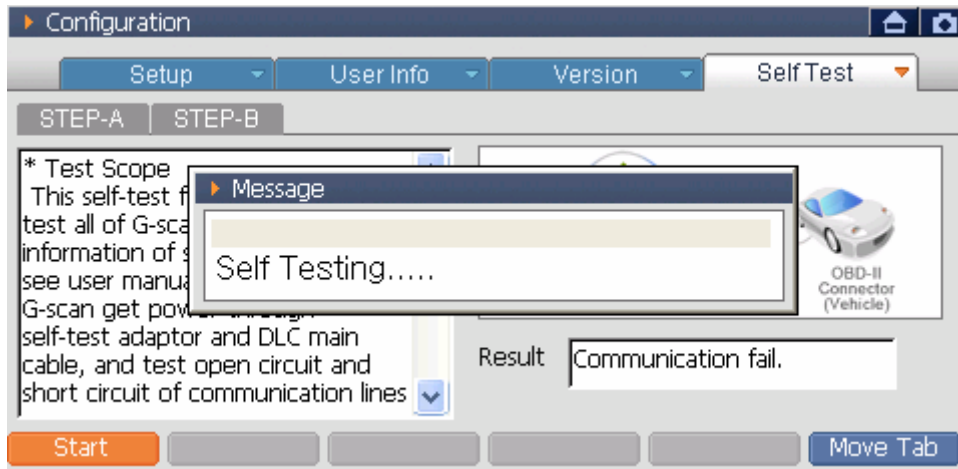

<Figure 6: Self Test B Proceeding>

- 4) Check the test result in the test window.

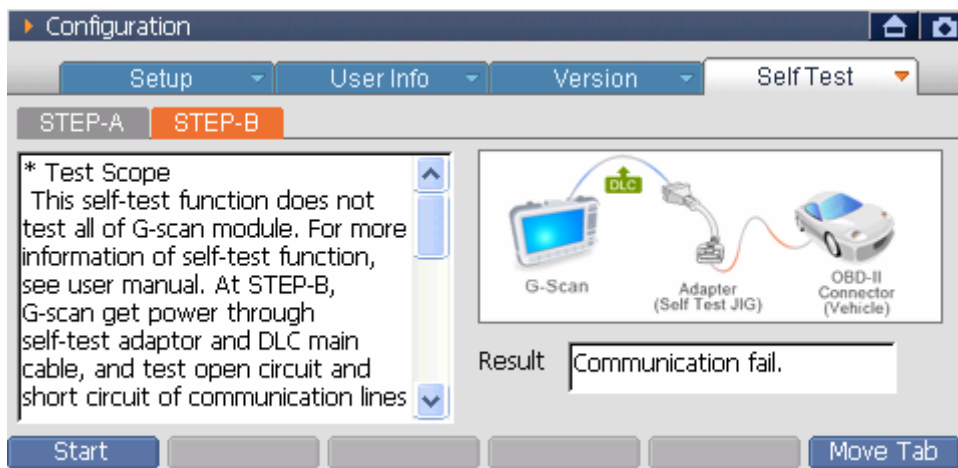

<Figure 7: Self Test B Result>

The test result messages are explained below:

Good: You may still need to test cable integrity by wiggling to test for intermittent connections.

** If the test results indicate “Good” and the vehicle communication continues to fail after the self-test adaptor is removed, verify that the communication problem is not vehicle related; contact the authorized service provider if necessary.



Failure: When the test result in self-diagnosis STEP-A are good but the result of STEP-B is failure, then there is a high possibility that the 16-pin Main DLC cable (P/No: G1PDDCA001) is inoperative. Contact the authorized service provider.

Exit from the “Self Test”

After setup the “Self Test” item, move to other Tab.

- Select the  to move to the “Setup”.
- Using stylus pen, select the “Tab” at the upper side of the touch screen to move there.



Move to main screen

- Select the  to move to the main screen.
- Select the  at the upper right side of the touch screen to move to the main screen.

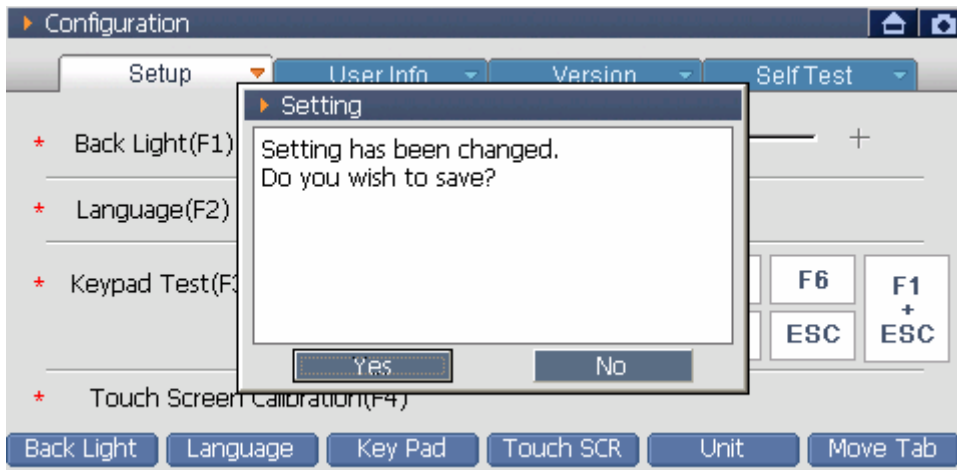
Selecting ‘Move to main screen’, the following message will be shown.



<Figure 8: Save Message>

	Save the setups and move to main screen.
	Cancel the setups and move to main screen.

For diagnosing the vehicle using the G-scan, select the vehicle model and system wanted to be diagnosed by user at first.

The system selection can select the multiple systems saved in the G-scan at the same time and diagnose the system problems.

Introduction of Model Selection Screen

For the convenience of user, it is divided into the Model, Year, Engine, System and Option. According to the order of selected windows, the system selected by user can be shown in the “Selected” window at right side.

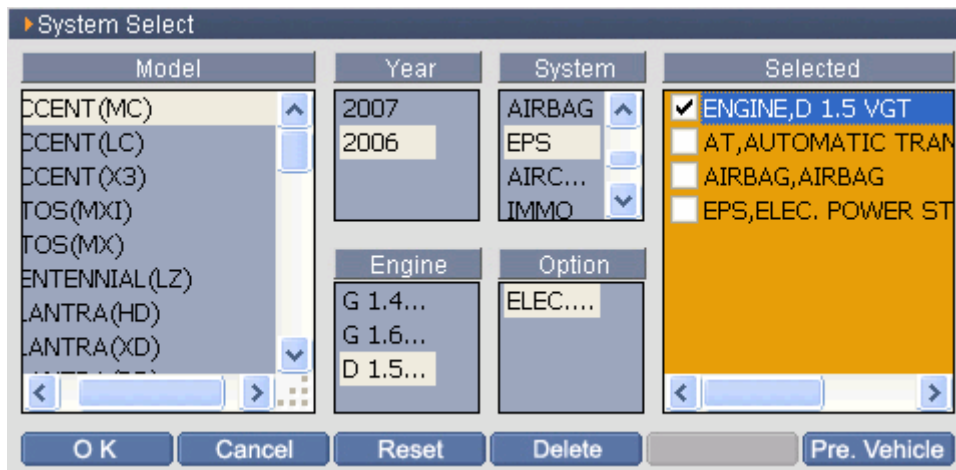

<Figure 1: Model Selection Screen>

	Save the diagnosing system selected by user. Change to the initial main screen or the diagnosis item screen selected by user.
	Cancel the selection of system selection of current window and return to the main screen.
	Release the all system items currently selected.
	Set to system SPEC setup in the latest version.
	Delete the list on which the cursor is located in the list of the “Selected” zone.



System Selection using the H/W Button

Select the **System Select** on the main screen, then the screen as shown in below figure will be shown.

How to select System

1) Model Selection



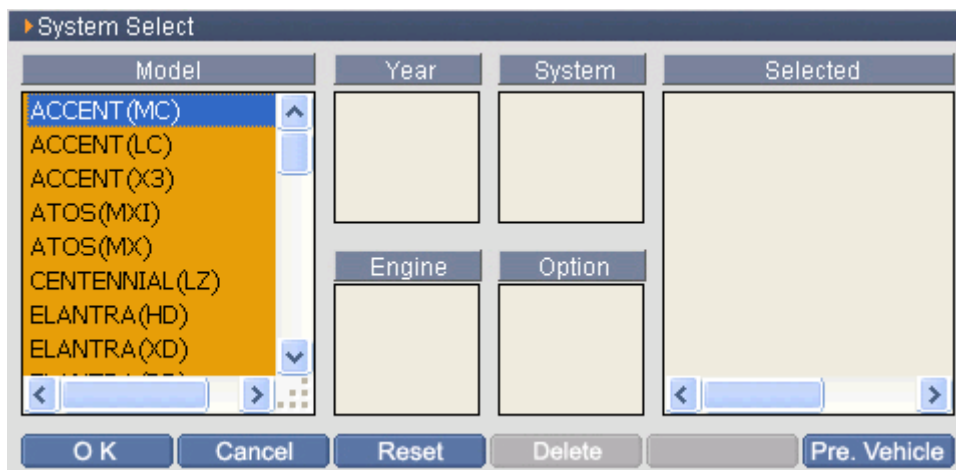

Changing to the system selection screen, the cursor will be located at the upper portion of the Model Selecting Zone as follows.

1		Set the cursor on the model to be diagnosed.
2		Select the model to be diagnosed. Move to "Year" zone.

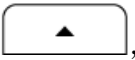

<Figure 2: Change to Model Selection Screen>



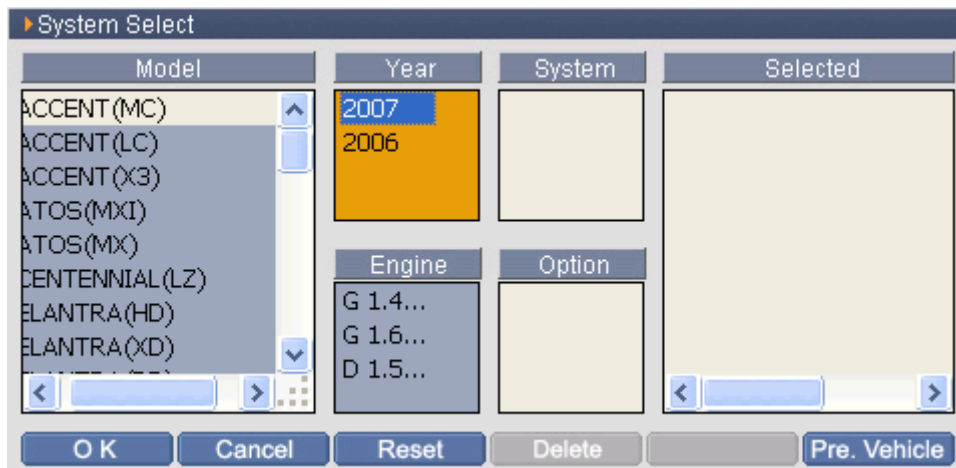

2) Year Selection

1	 , 	Set the cursor on the year of model to be diagnosed.
2	 , 	Select the year of model to be diagnosed. Move to "Engine" zone.

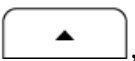

<Figure 3: Year Selection>

3) Engine Selection

1	 , 	Set the cursor on the engine of model to be diagnosed.
2	 , 	Select the engine of model to be diagnosed. Move to "System" zone.

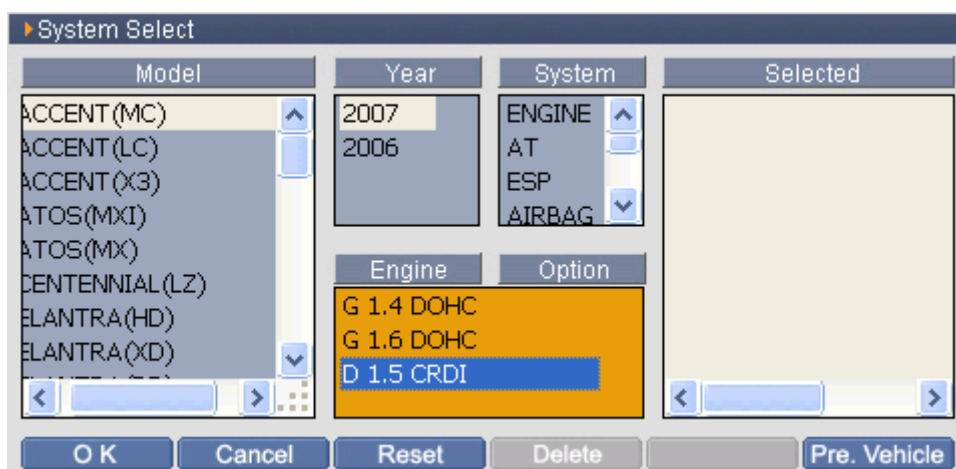

<Figure 4: Engine Selection>



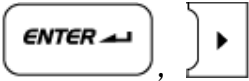

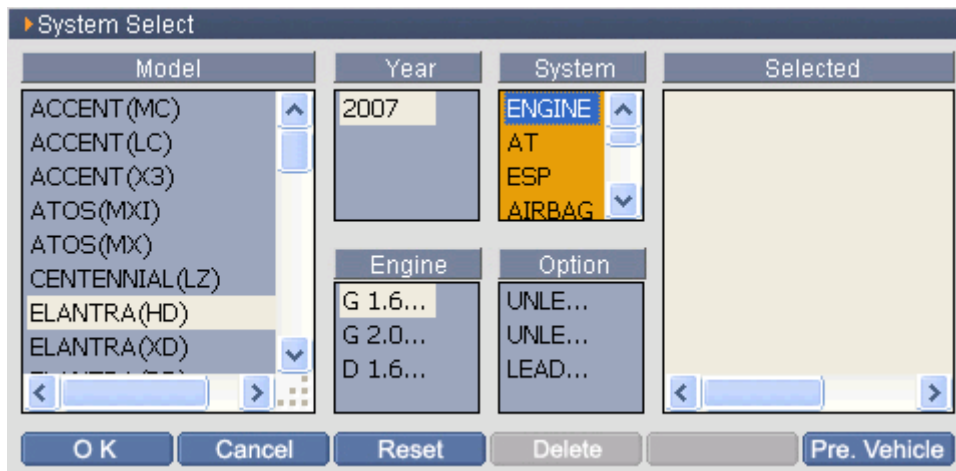
4) System Selection

1		Set the cursor on the system of model to be diagnosed.
2		<p>After selecting the system of model to be diagnosed, conduct followings according to the condition.</p> <p>When there is one system option: The system is registered in the “Selected” zone.</p> <p>When there are two or more system options: Move to the “Option” zone.</p>

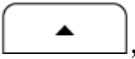

<Figure 5: System Selection>

5) Option Selection

1	 , 	Set the cursor on the system option of model to be diagnosed.
2	 , 	The system option of model to be diagnosed is registered in the “Selected” zone.

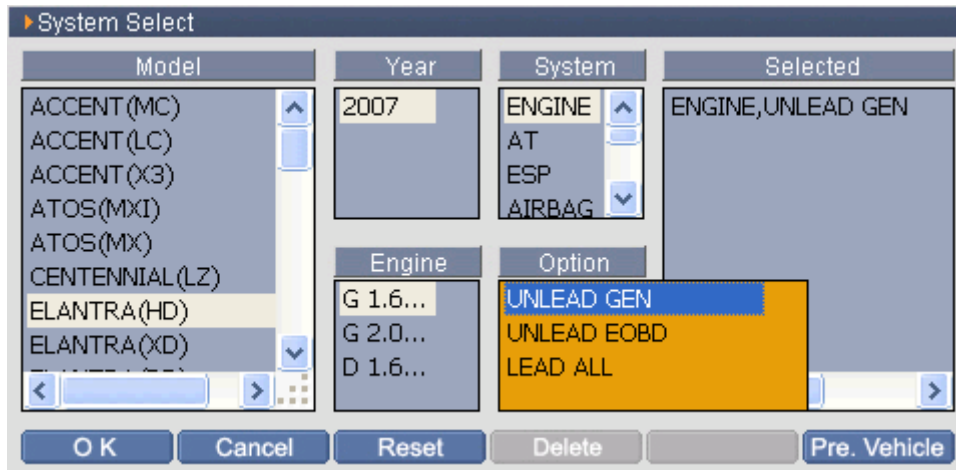

<Figure 6: Option Selection>

6) Multiple System Selection

When the number of the System to be diagnosed is multiple, press the





or with cursor locating at “Selected” zone to move to

the “System” zone and repeat from 4) to select again.

Notice:

During selecting system, when it moves to upper zone than “System” zone (“Model”, “Year”, “Engine” zones), all previously selected system selection will be released.

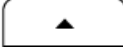
7) Main Diagnosis System Selection

Using   in the “Selected” zone, locate the cursor on the wanted system and select the . Then the mark will be shown at the front of the system name as following figure.

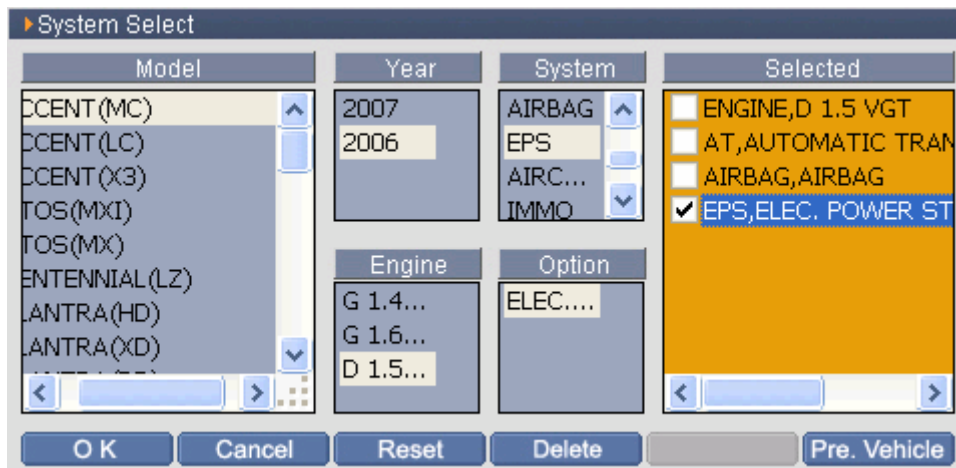

Main Diagnosis System:

The vehicle communication function except the “Fault Code Searching” can communicate with the control module marked with at vehicle selection. Please be advised that the other control modules without mark can communicate in the “Fault Code Searching”.



<Figure 7: Main Diagnosis System Selection>

8) Completion of System Selection

After selecting all system to be diagnosed, press the  or  button to complete the system selection.

9) Delete the selected System

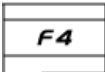

For deleting the system registered in the “Selected” zone, select the system to be deleted in the “Selected” zone and then press the

 or  button.

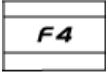
System Selection using touch screen

- The system selection order and cautions using the touch screen are the same with them using the H/W button described above. Using the stylus pen, select wanted items on the touch screen.
- When the wanted items are not shown in each zone, move the scroll bar up and down to find the items.
- To delete the registered system in the “Selected” zone, select the system in the “Selected” zone again and then press the  or  button.

Note:

- ◆ The system selection setup finally by user is not deleted even the power is OFF. When the  is selected, the previous setup will be applied again.
- ◆ 다수의 시스템을 선택한 진단은 에서만 가능합니다. 이외의 진단 모드에서는 “Selected” 영역의 체크 박스에 선택된 시스템만 통신이 가능합니다.

Multiple System Selection

The multiple of control modules registered in the “Selected” will shows all fault codes saved in the control modules to be diagnosed in one screen by just one function selection using the .

Select all control modules which may have problems in the vehicle.

However, it is not supported to the vehicle applied with special protocol type communication method.



Fault Code Searching



Vehicle COM Function

Module NO: A-04-002

It, the error diagnose mode, can search the all fault codes occurred at the multiple system selected at the 'System Selection', diagnose the problems at the system having fault code and move to the 'Service Data' directly.

Introduction for Fault Code Auto Searching Screen

System	Code	Description	State
ENGINE	P0646	A/C Clutch Relay Control Circuit Low	
ENGINE	P0031	HO2S Heater Control Circuit Low Bank 1 Se...	
AT		No Error Code	
AIRBAG		No Error Code	
AIRCON		Comm. Fail / Check selected system, IG key,...	

Buttons: Goto DTC, Goto Data, Retry, Close

<Figure 1: Fault Code Search Screen>

GOTO DTC	Change to the Error Diagnosis Mode of system selected at the "Fault Code Search" window.
GOTO DATA	Change to the Service Data Mode of system selected at the "Fault Code Search" window.
RETRY	Search the fault code of the selected system again.
CLOSE	Close the current window and change to the main screen.

Operating Sequence and Reference

Fault Code Searching

Executing the **Fault Code Searching** in the main screen after completing system selection, the fault code occurred at all system selected at the system selection are searched and shown on the screen as the following figure.

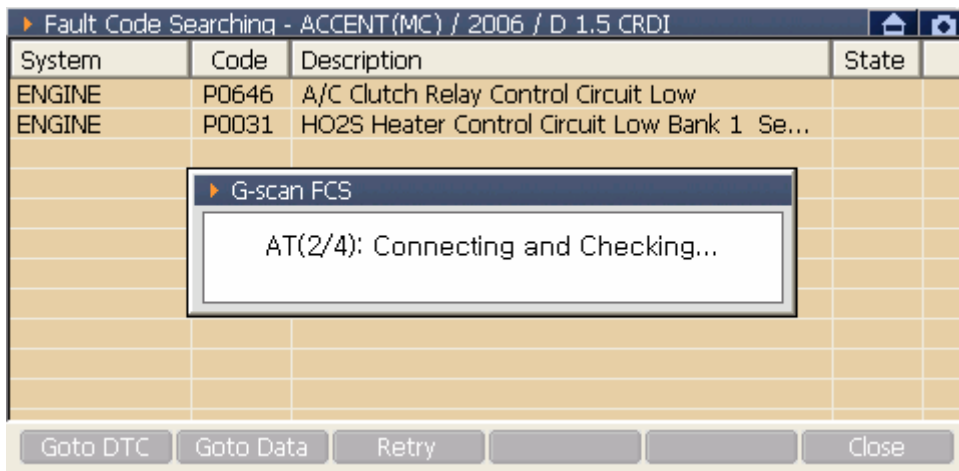



<Figure 2: Fault Code Search>

DTC Analysis, Current Data Analysis로 이동

1) Using the stylus pen or   buttons, select the searched fault code item.

2) Select the diagnosis mode.

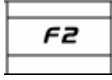
<p>Move to DTC Analysis of system having fault code selected at step 1).</p>	<p>Select  or </p>
<p>Move to Data Analysis of system having fault code selected at step 1).</p>	<p>Select  or </p>

- When **GOTO DTC** is selected

You can delete the fault code and check the data for the related DTC.

DTC Analysis - SONATA(NF) / 2006 / G 2.0 DOHC	
P1676	Smarta Message Error
P1505	Idle Speed Control Actuator Circuit 1-Low
P1507	Idle Speed Control Actuator Circuit 2-Low
P0076	Intake Valve Control Solenoid Circuit-Low (Bank 1)
P0445	Evaporative Emission System-Purge Control Valve Circuit Shorted
P0532	A/C Refrigerant Pressure Sensor "A" Circuit Low Input
P0113	Intake Air Temperature Sensor 1 Circuit High Input
P0102	Mass or Volume Air Flow Circuit Low Input

Buttons: Tips, Freeze, Erase, Sel. Erase, Status, Function

<Figure 3: When 'GOTO DTC' is selected>

- When **GOTO DATA** is selected

You can check the input/output status of related control module.

Data Analysis - SONATA(NF) / 2006 / G 2.0 DOHC		
Throttle Open(PWM)	4.7	%
Adapted Throttle Position	6.5	'
Battery Positive Voltage	14.5	V
Engine Coolant Temperature Sensor	54.0	°C
Engine Coolant Temperature Sensor (Model)	47.3	°C
Intake Air Temperature Sensor	0.8	°C
Canister Purge Duty	3.0	%
Cylinder 1 Injection Time	3.3	mS
Cylinder 2 Injection Time	3.3	mS
Cylinder 3 Injection Time	3.3	mS
Cylinder 4 Injection Time	3.3	mS
Torque Request From TCU	99.6	%
Oxygen Sensor Heating Time-Bank1/Sensor1	50	mS

Buttons: Tips, Fix, Full, Graph, Record, Function

<Figure 4: When 'GOTO DATA' is selected>

The "Fault Code Searching" searches the fault code of the system selected by user and presents exact information of the fault code and can delete the fault code after troubleshooting the faults.

There are 3 methods for using the fault code searching.

- On the main screen, select the **DTC Analysis**.
→ Move to the DTC Analysis of main diagnosis system set at the system selection.
- On the "Fault Code Searching", select the **GOTO DTC**.
→ Move to the DTC Analysis of the control module in which DTC selected at the "Fault Code Searching" is include.
- Select the DTC among the menu output after selecting the **FUNCTION** at the "Data Analysis"
→ The "DTC Analysis" and "Data Analysis" of the control module which communicated at the "Data Analysis" are output at the same time in dual mode.

Introduction of Fault Code Searching Screen

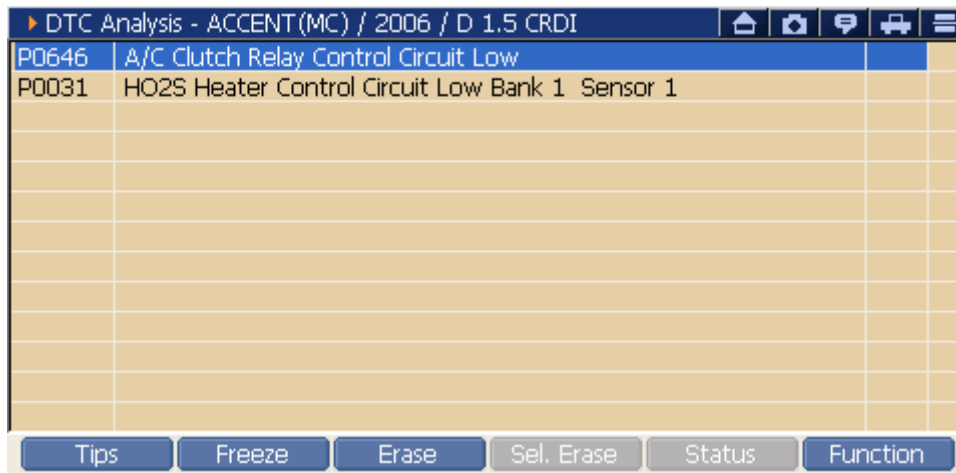

<Figure 1: DTC Analysis Screen>



	General Description of fault code are shown.
	As the Freeze Frame function, the input/output data of the control module relating to the saved fault code when the fault code is occurred. * According to the specification of control module, function supporting is different.
	Delete all fault codes saved at the control module
	Delete the fault code selectively among the fault codes shown by the fault searching. * According to the specification of control module, function supporting is different.
	Show the "Fault Detail Information". * According to the specification of control module, function supporting is different.
	Change to the dual mode and use other supplementary information function.

Note:

- When all items are not shown in one screen due to a lot of fault codes, move the scroll bar at right side using the stylus pen or the arrow keys to find item you want.
- If you want to back to main screen, press the or at the right upper side in <Figure 1>.



Fault Searching Sequence and Reference

See Tips

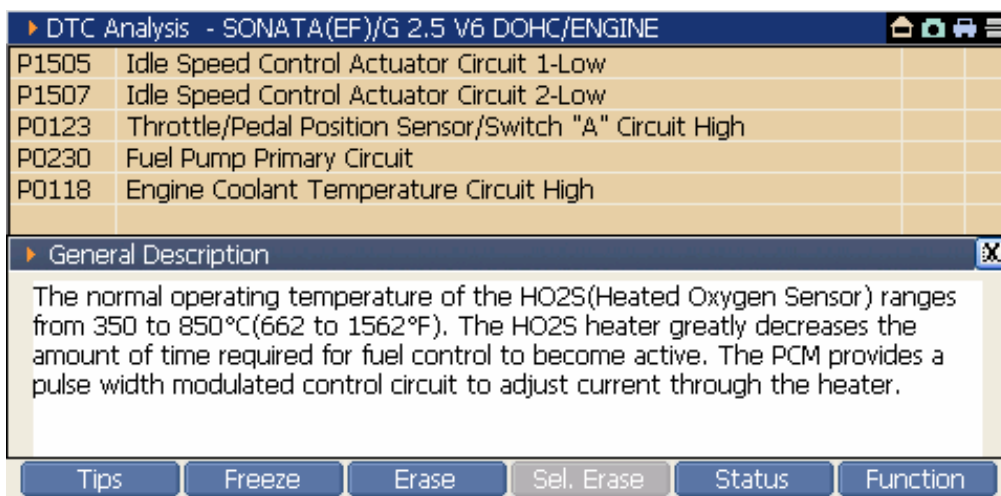
- 1) To see the detail information about the fault code occurred by the diagnosis result, select the relating fault code item.
- 2) Select the  or  buttons, a description window will be shown as in <Figure 2>.



<Figure 2: Show Tips>

- 3) If you want to close the 'General Description' select the ,  or .

See Freeze Frame

1) Select the fault code item of the Freeze Frame you want to see.

Freeze Frame: Data of sensor related to the fault code saved by the control module when fault code is occurred.

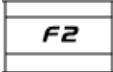
2) Select  or  button on the fault searching screen, you can see the Freeze Frame as shown in <Figure 3>.

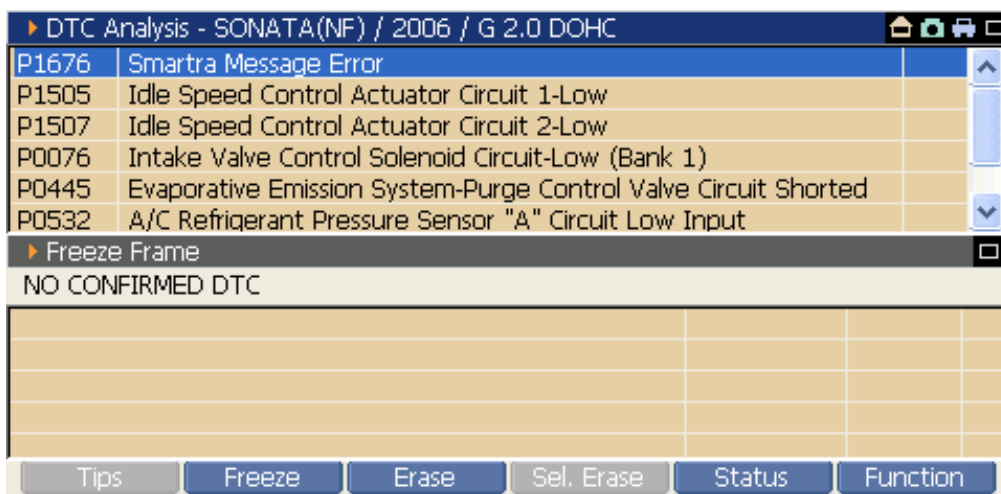

<Figure 3: See the Freeze Frame>

3) If you want to close the Freeze Frame screen, select the  of “DTC Analysis” at the upper side of <Figure 2>.

Notice:

According to the control module, it is supported to some kinds of model.

Delete the Fault Code

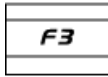
- 1) Select the  or  button on the fault searching screen.

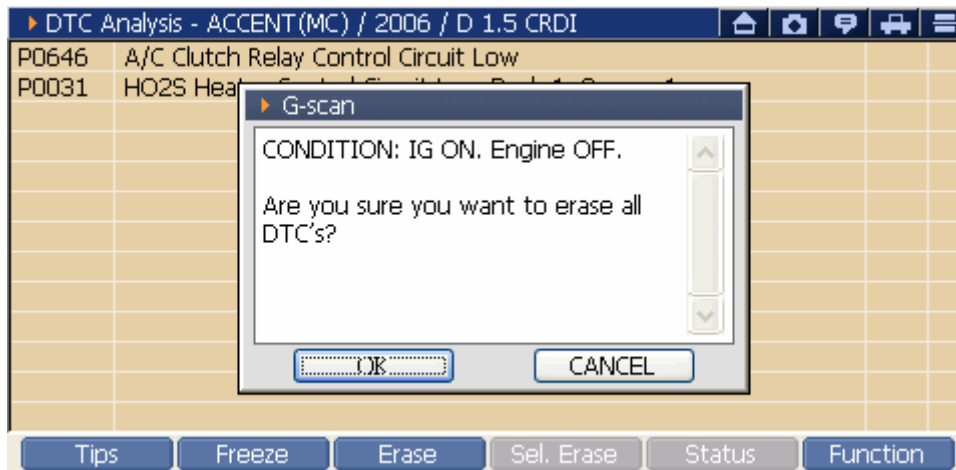

<Figure 4: Delete Fault Code>

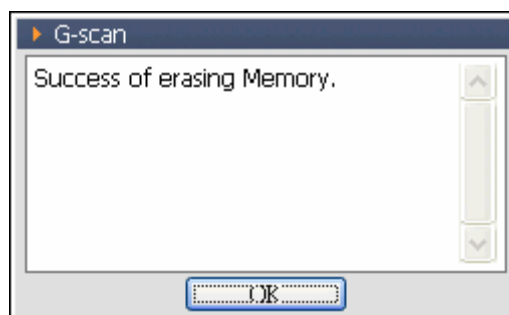

- 2) As shown in <Figure 4>, the message window for deleting the fault code is shown overlapping the diagnosis window.
- When  is selected:
All fault codes are deleted and the message like the <Figure 5> will be shown.



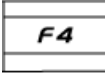

<Figure 5: Fault Code Delete Message>

- When  is selected:
The Fault Code delete will be canceled.

Fault Code Selection Delete

- 1) Select the fault code to be deleted on the Fault Searching Screen.
- 2) Select the  or  button.
- 3) The message for checking the fault code delete will be shown.
 - When  is selected:
The fault code selected in step 1) is deleted and message is shown.
 - When  is selected:
The fault code delete is cancelled.

See the Fault Code Detail Information

- 1) Select the fault code on the Fault Code Searching screen.
- 2) Select the  or  button.

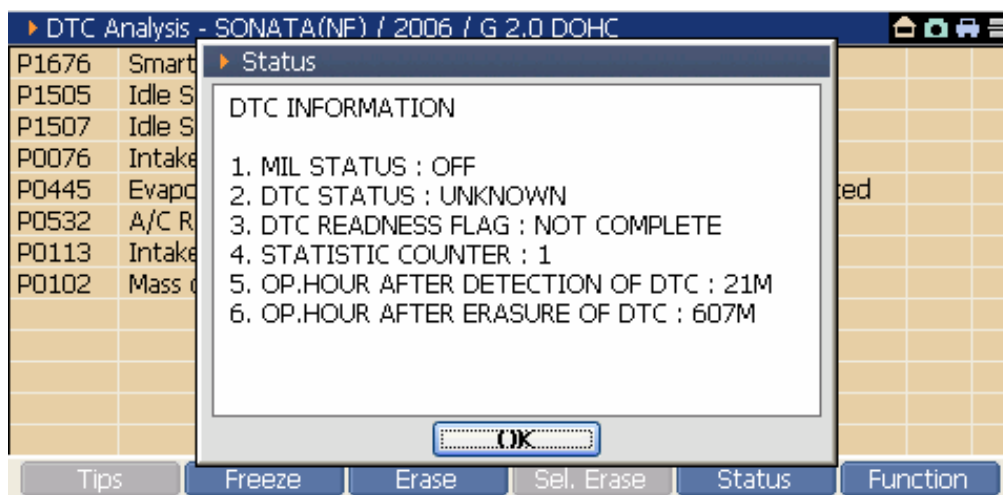



<Figure 5: Detail Fault Information>

- 3) As shown in <Figure 5>, the “Fault Code Detail Information” window will be shown. You can check the detail information about the selected fault code.

DTC Analysis Dual Diagnosis Mode

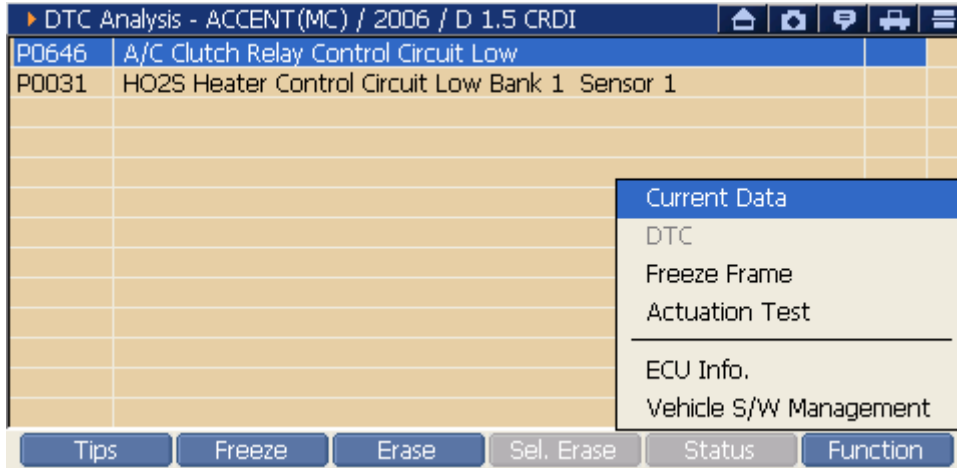

See the DTC Analysis and Data Analysis at the same time

- 1) On the <Figure 1> DTC Analysis screen, select the  or , the Function Menu is shown as in <Figure 6>.



<Figure 6: DTC Analysis “Function Menu”>

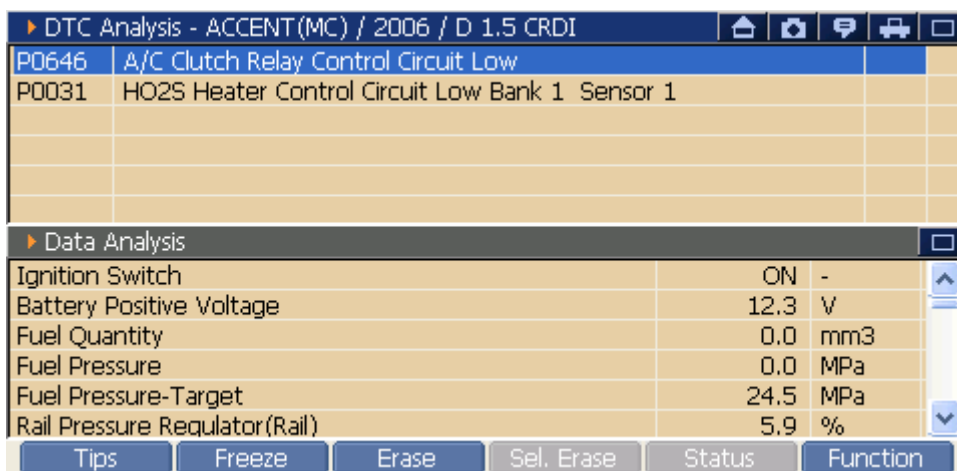

- 2) On the showing menu, select the Current Data, it changes to the Dual mode as shown in <Figure 7>.

- Using stylus pen, select on the touch screen directly.
- After moving cursor using H/W buttons  , press the  button





<Figure 7: DTC Analysis & Data Analysis Dual Diagnosis Mode>

See DTC Analysis and Actuation Test at the same time

1) On the <Figure 1> DTC Analysis screen, select  or ,
The Function Menu will be shown as in <Figure 6>.

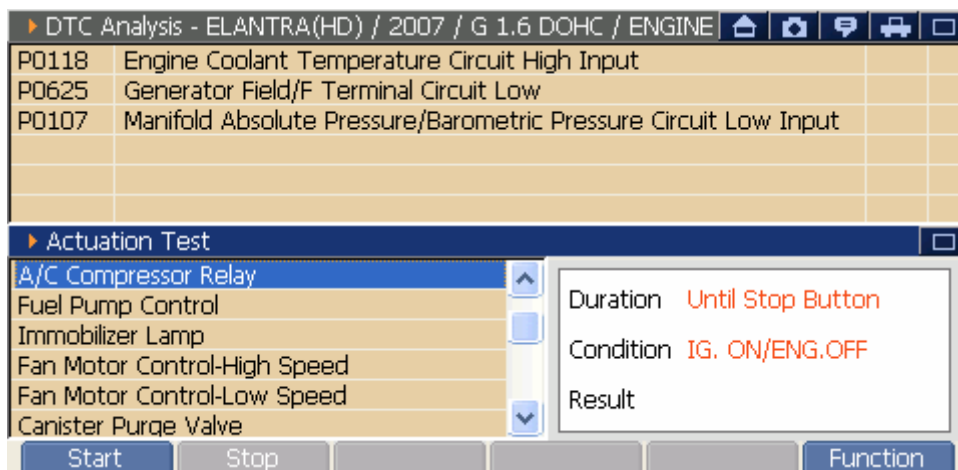

2) Select the Current Data on the showing menu, then it changes to the Dual mode as shown in <Figure 8>.

- ◆ Select it using stylus pen on the touch screen.
- ◆ After moving the cursor using H/W buttons  , press the  button.





<Figure 8: DTC Analysis & Actuation Test Dual Diagnosis Mode>

Check the ECU Information

- 1) On the <Figure 1> DTC Analysis screen, select  or , then the Function Menu is shown as in <Figure 6>.

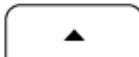
Selecting the ECU Info in the showing menu, the screen changes to the ECU Information as shown in <Figure 9>.

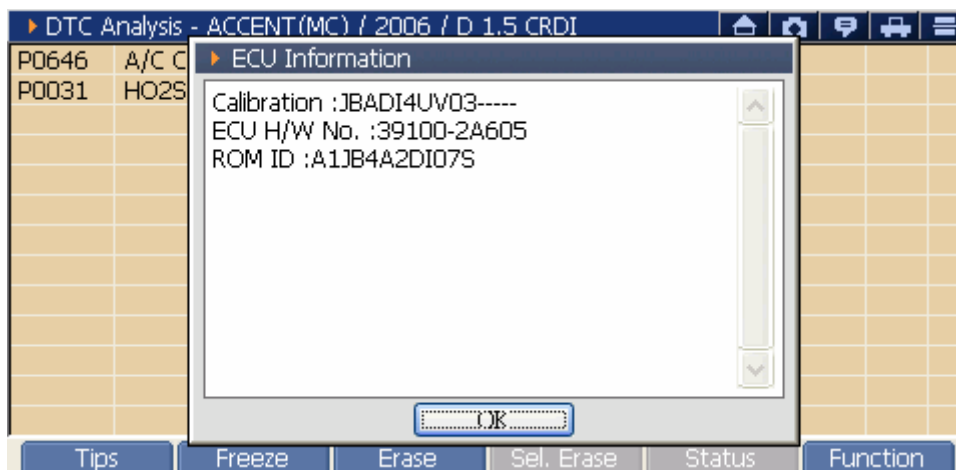

- ◆ Using the stylus pen, select on the touch screen directly.
- ◆ After moving cursor using the H/W buttons  , press the  button.





<Figure 9: ECU Information>

- 2) Press the  button at the bottom of the “ECU Information” to close the window.

Change to the Vehicle S/W Management

1) On the <Figure 1> DTC Analysis screen, select the  or , then the Function Menu is shown as <Figure 6>.

2) Select the Vehicle S/W Management in the showing menu, the screen changes to the Vehicle S/W Management as <Figure 9>.

- ◆ Using the stylus pen, select on the touch screen directly.
- ◆ After moving cursor using the H/W buttons  , press the  button.

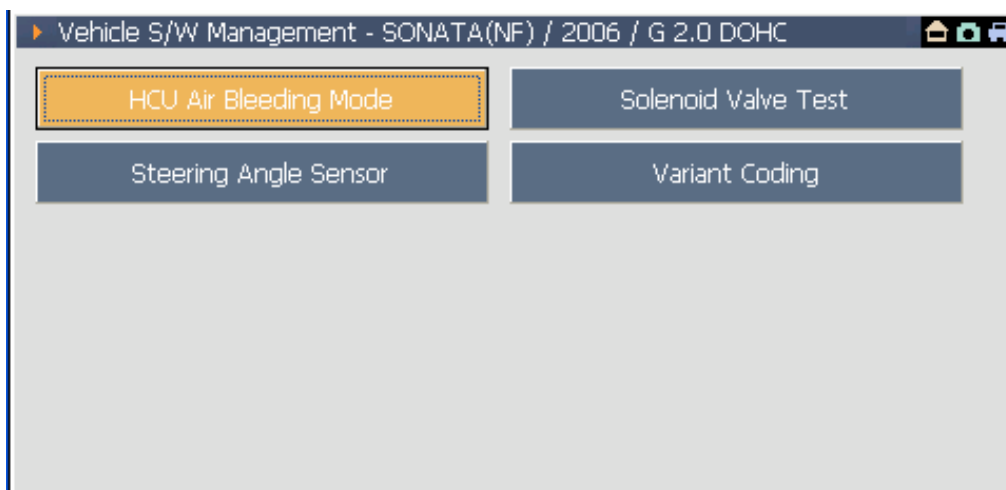

<Figure 10: Vehicle S/W Management>

It is the diagnosis item for checking the data input/output status of the control mode to be diagnosed through the service data.

There are 3 methods for using the service data.

- Select the **Data Analysis** on the main screen
→ Move to the “Data Analysis” of main diagnosis system set in the System Selection.
- Select the **GOTO DATA** at the “Fault Code Searching”
→ Move to the “Data Analysis” of the control module having DTC selected in the “Fault Code Searching”.
- Select the **FUNCTION** in the “DTC Analysis” and select the Current Data among the showing menu
→ The “DTC Analysis” and “Data Analysis” of the control module communicated in the “DTC Analysis” are output in dual mode at the same time.

Introduction of Service Data screen

Data Analysis - ACCENT(MC) / 2006 / D 1.5 CRDI		
Ignition Switch	ON	-
Battery Positive Voltage	12.4	V
Fuel Quantity	0.0	mm3
Fuel Pressure	0.0	MPa
Fuel Pressure-Target	24.5	MPa
Rail Pressure Regulator(Rail)	12.5	%
Rail Pressure Regulator(Pump)	0.0	%
Fuel Temperature Sensor	30.8	°C
Fuel Temperature Sensor	2863	mV
Air Mass Flow Max. Plausible	0.0	kg/h
Air Mass Flow per Cylinder	0.0	mg/st
Intake Air Temperature Sensor	22.2	°C
Intake Air Temperature Sensor	3255	mV

Tips Fix Full Graph Record Function

<Figure 1: Data Analysis Screen>

	Fix the selected item at the top of the screen.
	Split the service data screen into left and right sides and show the 26 data at maximum.
	Show the fixed item in line graph.
	Change to dual mode and use other functions.
Reference	
<ul style="list-style-type: none"> If the wanted item is not shown, move the scroll bar with the stylus pen or use the direction buttons to find it. 	
<ul style="list-style-type: none"> If you want to return to initial screen, press the or at the right upper side of screen 	

Operating Sequence and References

Fix the Data Item

- How to fix the Data item

1) Select the item want to fix.

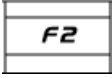
2) Select the  or  at the bottom of the screen or double click the item using the stylus pen on the touch screen, then the selected item will be fixed at the top of the screen as shown in <Figure 2>.

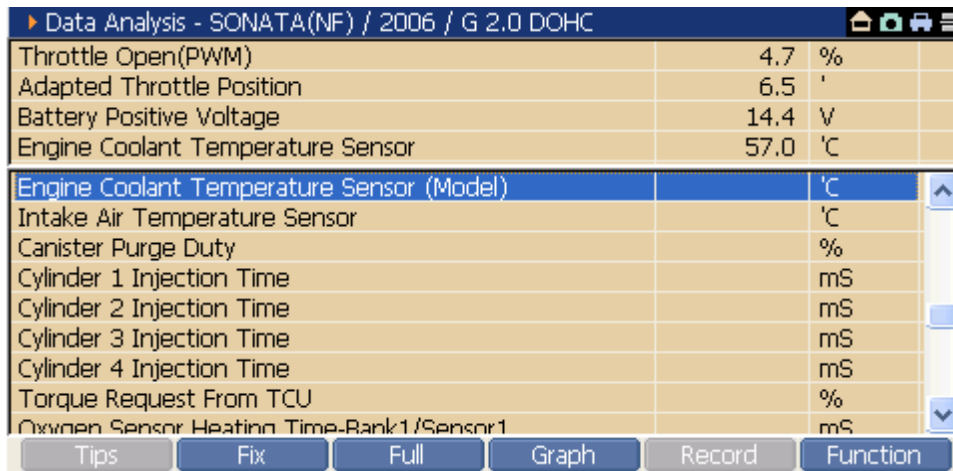

<Figure 2: Fix the Data Item>

- Release the fixed Data item

1) Select the fixed item again.

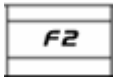

2) Select the  or  at the bottom of the screen or double click the item to be released using the stylus pen on the touch screen.

Tips

* The number of Fix is 4 at most in single mode and 2 at most in dual mode.

Full

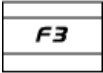
- See with Full screen

On the service data screen, select  or  , then the screen will be divided as shown in <Figure 3> and 26 data items are shown.

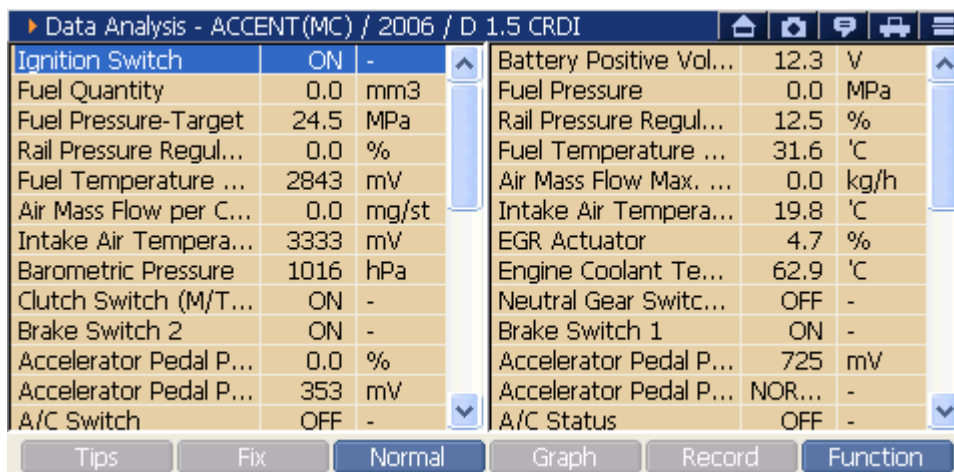

Data Analysis - ACCENT(MC) / 2006 / D 1.5 CRDI			
Ignition Switch	ON -	Battery Positive Vol...	12.3 V
Fuel Quantity	0.0 mm3	Fuel Pressure	0.0 MPa
Fuel Pressure-Target	24.5 MPa	Rail Pressure Regul...	12.5 %
Rail Pressure Regul...	0.0 %	Fuel Temperature ...	31.6 °C
Fuel Temperature ...	2843 mV	Air Mass Flow Max. ...	0.0 kg/h
Air Mass Flow per C...	0.0 mg/st	Intake Air Tempera...	19.8 °C
Intake Air Tempera...	3333 mV	EGR Actuator	4.7 %
Barometric Pressure	1016 hPa	Engine Coolant Te...	62.9 °C
Clutch Switch (M/T...	ON -	Neutral Gear Switc...	OFF -
Brake Switch 2	ON -	Brake Switch 1	ON -
Accelerator Pedal P...	0.0 %	Accelerator Pedal P...	725 mV
Accelerator Pedal P...	353 mV	Accelerator Pedal P...	NOR... -
A/C Switch	OFF -	A/C Status	OFF -

<Figure 3: See in Full>

- Return to Normal screen

On Full screen mode, press  or .

Note:

- ◆ On the screen in Full mode, FIX and Graph functions are not available.
- ◆ Find the item now shown on the screen using the arrow button or moving the scroll bar with the stylus pen.
- ◆ If all of item names are not shown, select the item using the stylus pen, then all item name can be shown by moving it to right side.

Graph

1) Fix the item want to see in graph.

2) Select **GRAPH** or **F4**, then the selected item will be shown in graph mode as in <Figure 4>.

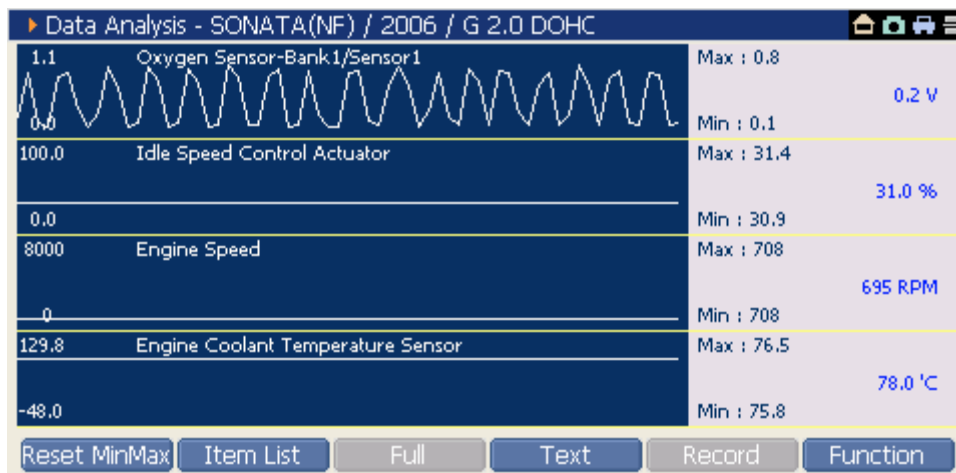

<Figure 4: Graph Mode>

Reset MinMax	Initialize the Max and Min values output on graph.
Item List	Modify the item list on the graph.

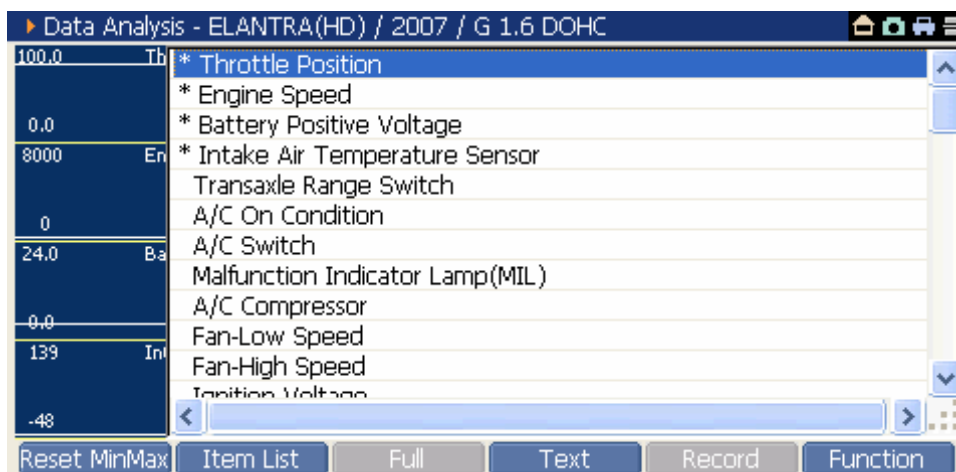

* Add/Delete the graph list using **Item List**





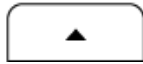

<Figure 5: Item List>

① In the graph mode, select **Item List**, then Item List is shown as in <Figure 5>.

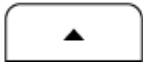
(The item having “*” mark among the Item List means the item shown in graph mode currently.)

② Select the item want to be deleted among the list shown in graph mode currently using the arrow buttons   and  key or using the stylus pen on the touch screen.

③ Select the item want to be shown in graph mode among the list not shown in graph mode using the arrow buttons   and  key, or using the stylus pen on the touch screen.

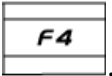

3) If you want to return to the service data, press the  or .

Note:

* The number of service data possible to applied to Graph mode is 4 at most in single mode, and 2 at most in dual mode.

Data Analysis Dual Diagnosis Mode

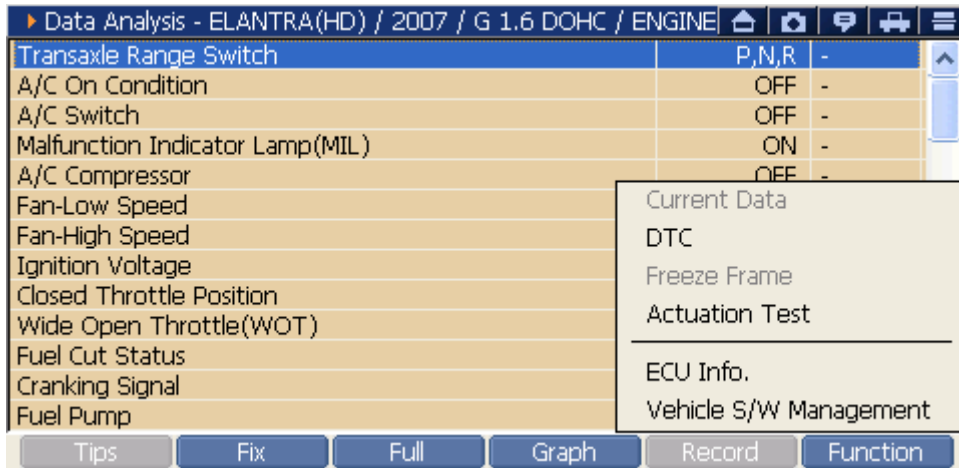

See the Data Analysis and the DTC Analysis at the same time

1) On the <Figure 1> DTC Analysis screen select  or , the Function Menu will be shown as in <Figure 6>.

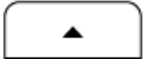

<Figure 6: DTC Analysis “Function Menu”>

2) On the showing menu, select the Current Data to change the screen to the Dual mode as shown in <Figure 7>.

- Using the stylus pen, select on the touch screen
- Moving the cursor with H/W buttons , , press the  key.

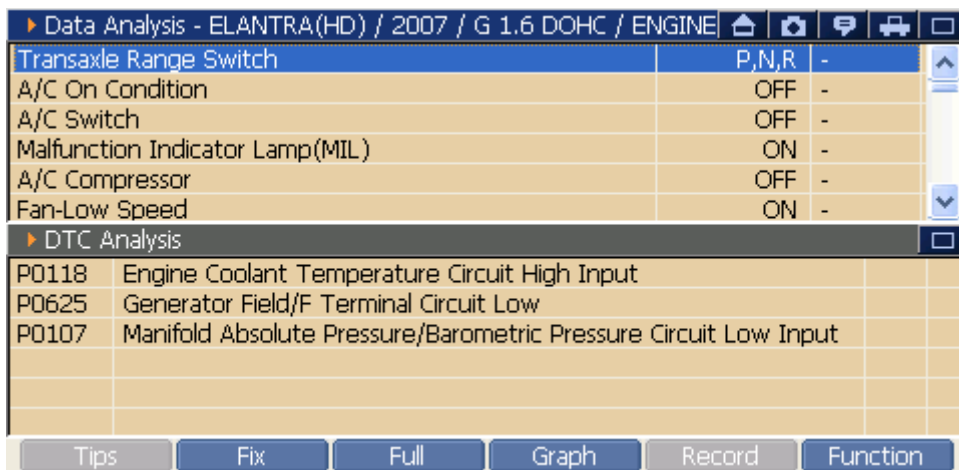

<Figure 7: Data Analysis & DTC Analysis Dual Diagnosis Mode>



See the DTC Analysis and the Actuation Test at the same time

1) On the <Figure 1> DTC Analysis screen, select **FUNCTION** or



, the Function Menu will be shown as in <Figure 6>.

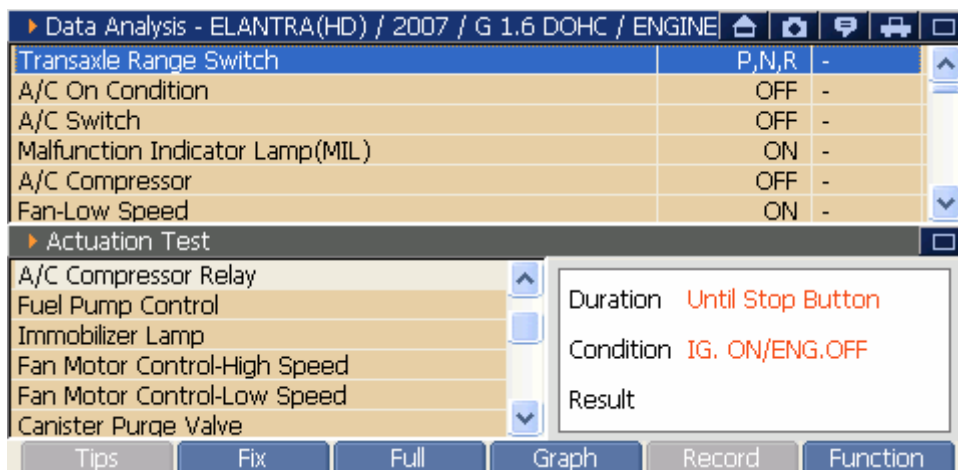

2) On the showing menu, select the Current Data, the screen will be changed to the Dual mode as shown in <Figure 8>.

- Using the stylus pen, select on the touch screen directly.
- Moving the cursor with H/W buttons , , press the  key.





<Figure 8: Data Analysis & Actuation Test Dual Diagnosis Mode>

Check the ECU Information

3) On the <Figure 1> Data Analysis screen, select  or , the Function Menu will be shown as in <Figure 6>.

4) On the showing menu, select the ECU Info, then the ECU Information popup window as in <Figure 9> is shown.



- ◆ Using the stylus pen, select on the touch screen directly.
- ◆ Moving the cursor with H/W buttons , , press the  key.





<Figure 9: ECU Information>

5) Press the  button at the bottom of the “ECU Information” to close the window.

Change to Vehicle S/W Management

3) On the <Figure 1> Data Analysis screen, select  or , the Function Menu will be shown as in <Figure 6>.

On the showing menu, select the ECU Info, then the screen will be changed to the Vehicle S/W Management as in <Figure 9> is shown.

- ◆ Using the stylus pen, select on the touch screen directly.
- ◆ Moving the cursor with H/W buttons , , press the  key.

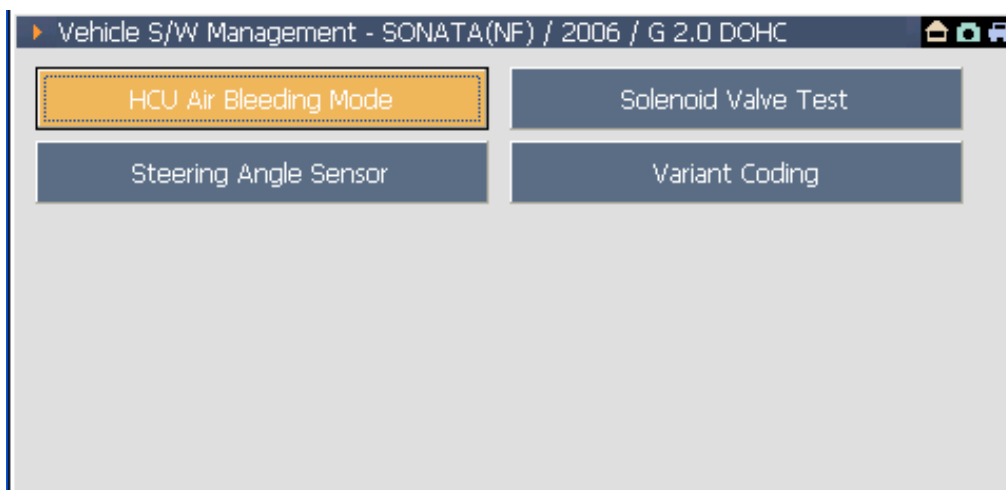



<Figure 10: Vehicle S/W Management>



Through the "Actuation Test", it is possible to check if the control module and unit to be tested are defected or not.

There are two methods for using "Actuation Test".

- At the "DTC Analysis", select the "Actuation Test" of the menu included in .
- "DTC Analysis" and "Actuation Test" are output in dual mode.

- At the "Data Analysis", select the "Actuation Test" of the menu included in .
- "DTC Analysis" and "Actuation Test" are output in dual mode.

Description of Actuation Test screen

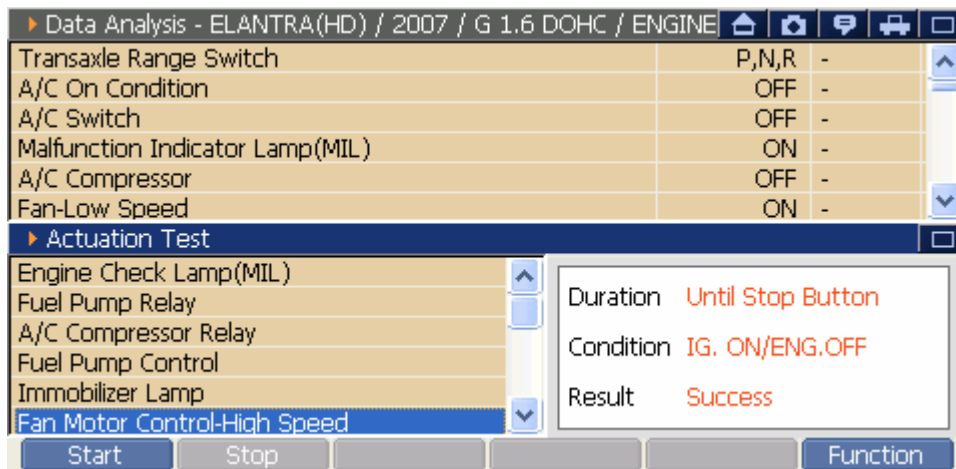

<Figure 1: Actuation Test& Data Analysis>

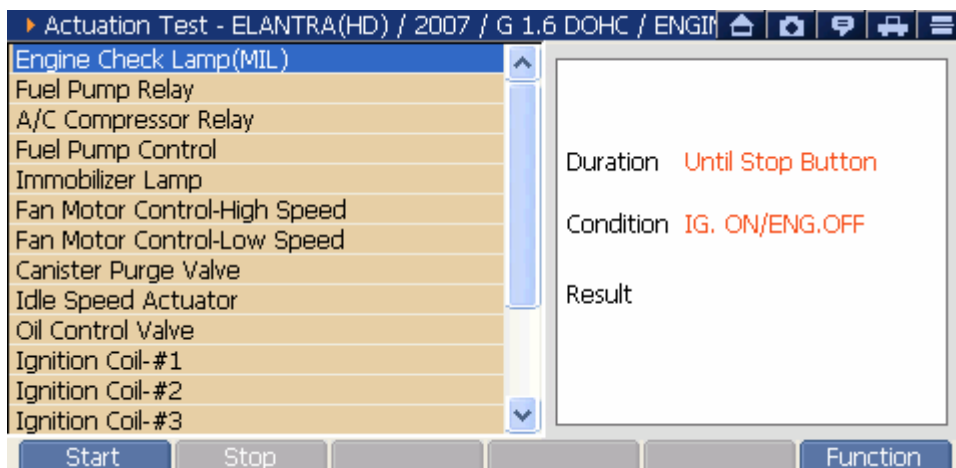

<Figure 2: Actuation Test overall screen>



Change to the "Actuation Test" overall screen:

Select the  indicated by the arrow in <Figure 1>, then screen will be changed to the overall screen.

Change to the Dual Mode Previous on Overall screen:



Select the  at the upper right side of <Figure 2>, then the screen will be change to the dual mode previous on overall screen.

Left Zone of "Actuation Test" Screen:

You can see the "Actuation Test" item. For check the item, move the scroll bar using the stylus pen or using the direction buttons  .



Right Zone of "Actuation Test" Screen:

You can check the Testing Lap Time, Test Condition and Test Result.

	Start the test for the selected item.
	Finish the test of selected item.
	Change to the Current Data, DTC, ECU Info, or Vehicle S/W management.

How to execute the Actuation Test

1) Select the Actuation Test item

At the left zone of “Actuation Test” screen, select using stylus pen on the touch screen or move the cursor using direction buttons  .

2) Check and setup the Actuation Test condition

After checking the Test Lap Time and Test Condition at the right zone of “Actuation Test” screen, setup them according to the condition of the testing vehicle.



3) Start the Actuation Test

Select  or  to start the test.



4) Check the Actuation Test result

On the right zone of the “Actuation Test” screen, the test result (Failure or Success) will be shown.

5) Stop the Actuation Test

Test which lap time is determined:	After completing test time, the test will be terminated automatically.
Test which lap time is not determined:	After checking the result, select  or  to terminate the test.

Note:

Even it is the test which lap time is determined, press the  or  during test, then it will be terminated.

It is the function for diagnosing all items except the fault searching, service data, actuator test. For exact diagnosis, it supports various diagnosis functions by system.

Diagnosis Supplementary Function Main Screen

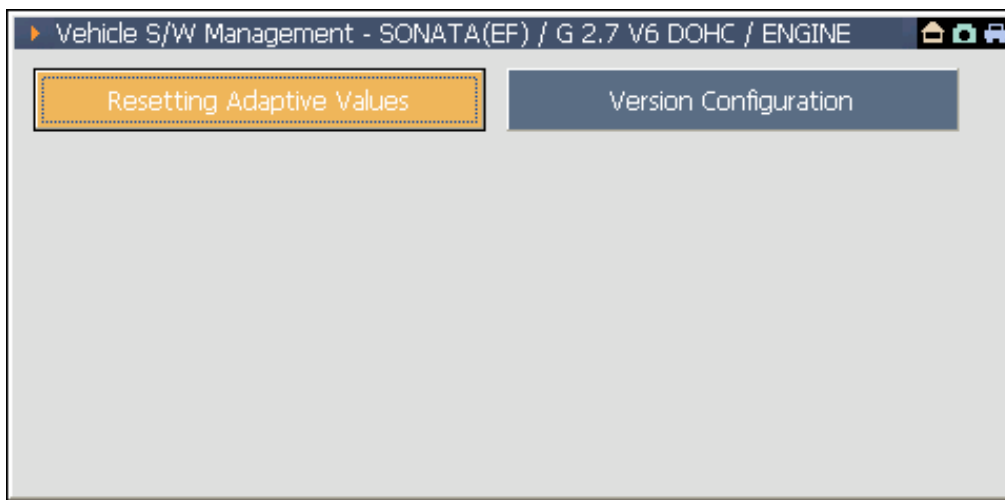

<Figure 1: Vehicle S/W Management Screen>

	Function for initializing the teaching value in ECU.
	Function for setting the option such as ABS and TCS configured in ECU.

Note:

This screen is the main screen for supplementary diagnosis function of specific vehicle. According to the system, the screen for diagnosis supplementary function may be different.

Example of Diagnosis Supplementary Function



Resetting Adaptive Values

The "Resetting Adaptive Values" function is used to reset adaptive learn data on specific ECUs.

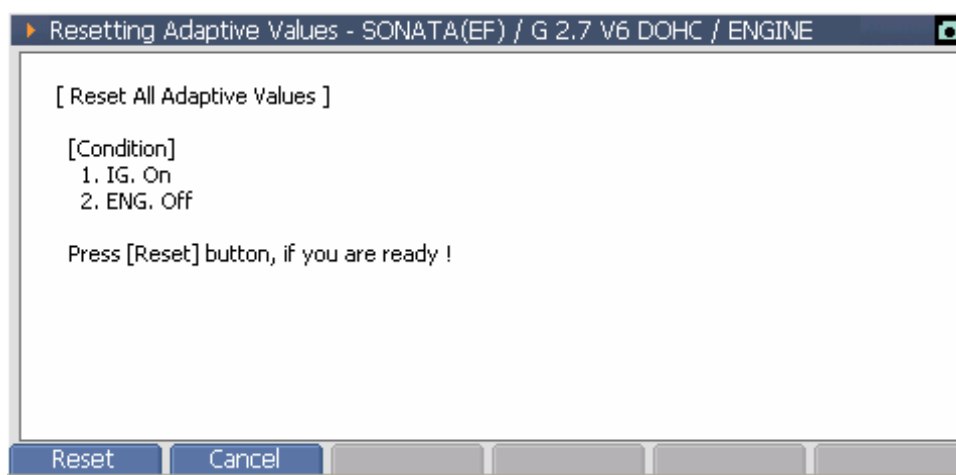
- On the main screen, select **Resetting Adaptive Values**, then screen will show the window as in <Figure 2>. After checking the sentence shown in screen, press the **Reset** or **FI**.



<Figure 2: Resetting Adaptive Values step 1>

- After checking the sentence shown in the message window, press  button to initialize the ECU teaching value.
- * Select , then the option setup will be cancelled and the message window will be closed.

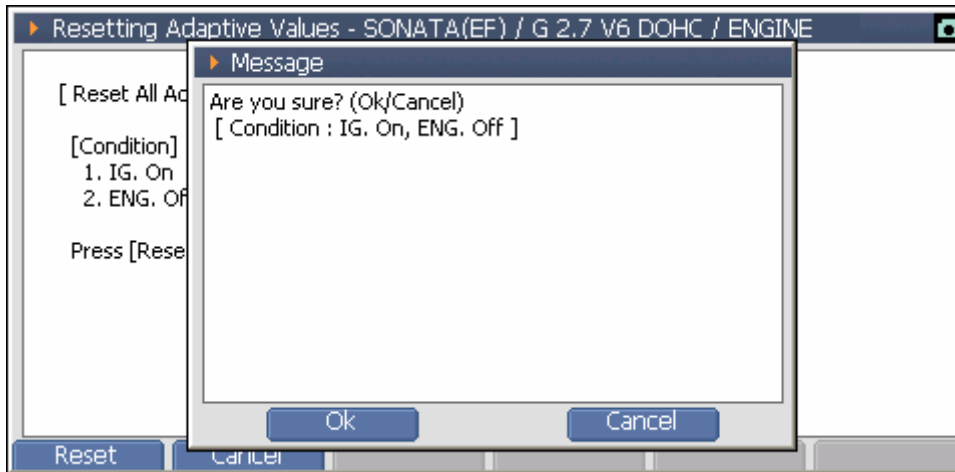

<Figure 3: Resetting Adaptive Values step 2>

- Checking the following message, press  to complete the initialization of ECU teaching value.

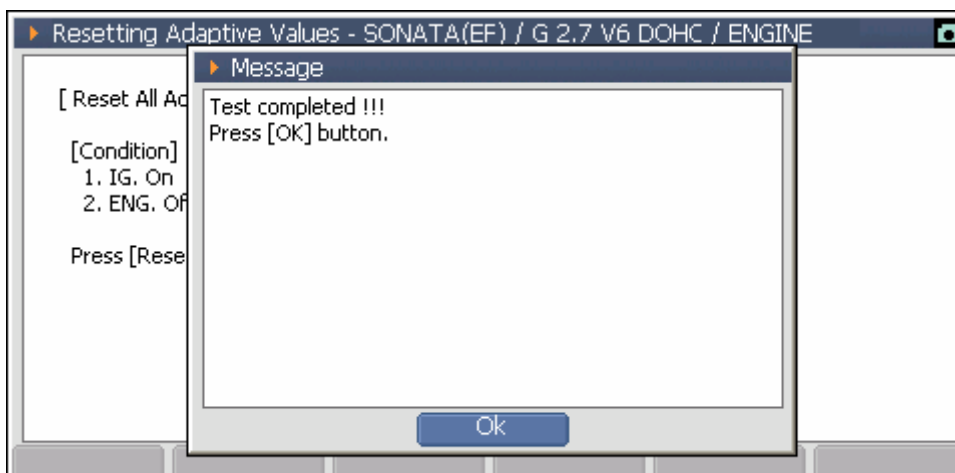

<Figure 4: Resetting Adaptive Values step 3>



Version Configuration

The "Version Configuration" function is used on supported engine ECUs to configure for transaxle and ABS ECU options.

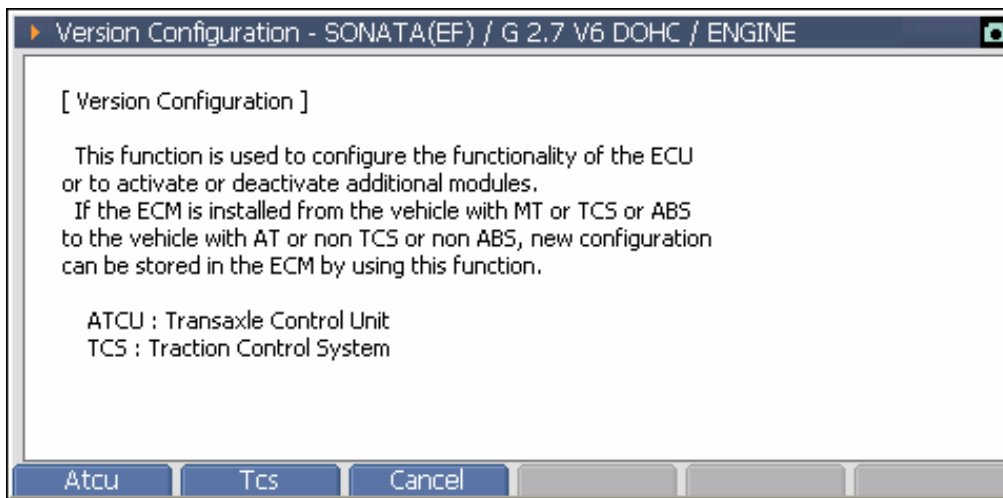
On the main screen, select  then following window will be shown. After checking the sentence on the screen, select the proceeding item.



<Figure 5: Version Configuration step 1>

- After checking the sentence on the message window, press the  button.
- * Select  to cancel the option setup and to close the message window.

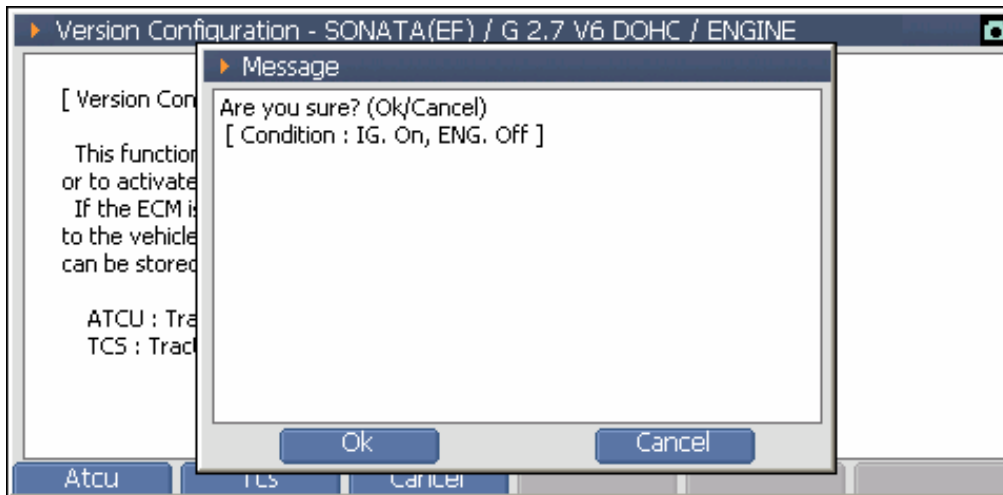

<Figure 6: Version Configuration step 2>

- After showing the following message, press . Then the ECU option setup is completed.

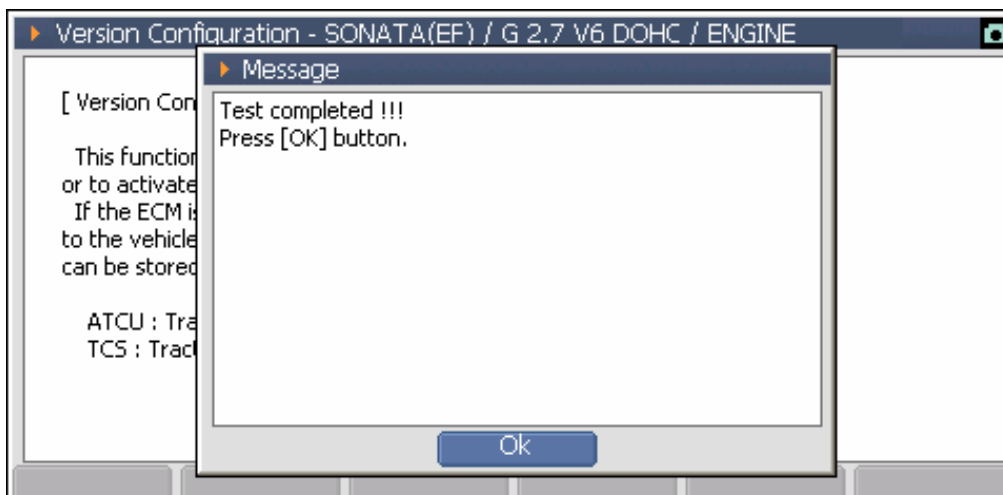



<Figure 7: Version Configuration step 3>

It is the function for modifying the ECU program to enhance the performance of ECU. Before using this function, be familiar with the cautions and then perform the ECU upgrade. The ECU upgrading not comply with the cautions may cause serious damages on the ECU.

Introduction of the ECU Upgrade screen



<Figure 1: ECU Upgrade Screen>

	Upgrade the ECU for the selected event automatically.
	For the case not to upgrade automatically, upgrade the ECU in manual.
	Show the Technical Service Bulletin of selected event. It should be checked before updating.

How to ECU Upgrade

How to use the Auto Upgrade

When the ECU of relating vehicle has the update event not applied, the auto update is conducted in the Auto Mode.

- 1) On the main screen, select , then screen will be changed to the event selection screen as in the following figure, and all events applied to the vehicle are shown. If there is no event applied to the ECU of the vehicle, it is not changed from the main screen to the event selection screen.



<Figure 2: ECU Upgrade Screen>

Notice:

After selecting the event to be upgraded, select  at the bottom of the screen to perform the update after checking the Technical Service Bulletin.

2) After selecting the event on the event selection screen, select **AUTO** or , then the screen will be changed to the ECU update preparing screen as follows.

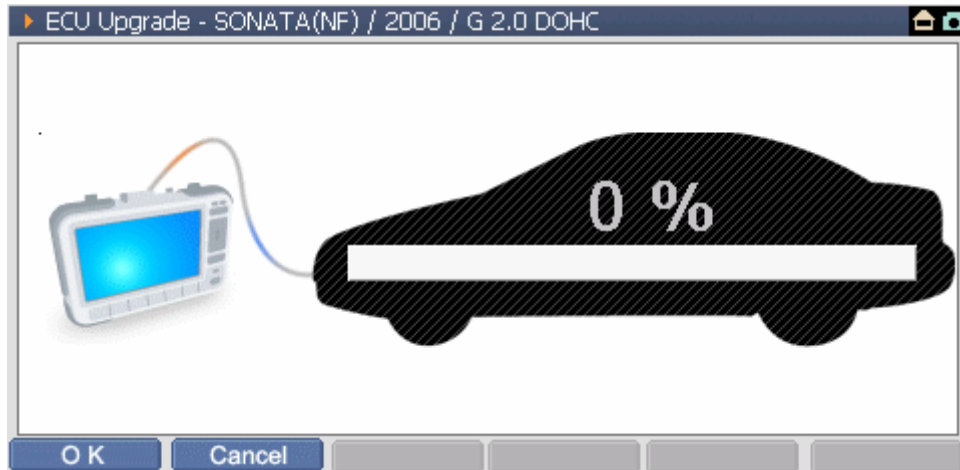

<Figure 3: ECU Auto Upgrade step 1>

Error Message:

- ◆ When the selected event is already applied to the vehicle



<Figure 4: ECU Auto Upgrade step 2>

- ◆ When there is no event related to the ECU specification of the vehicle

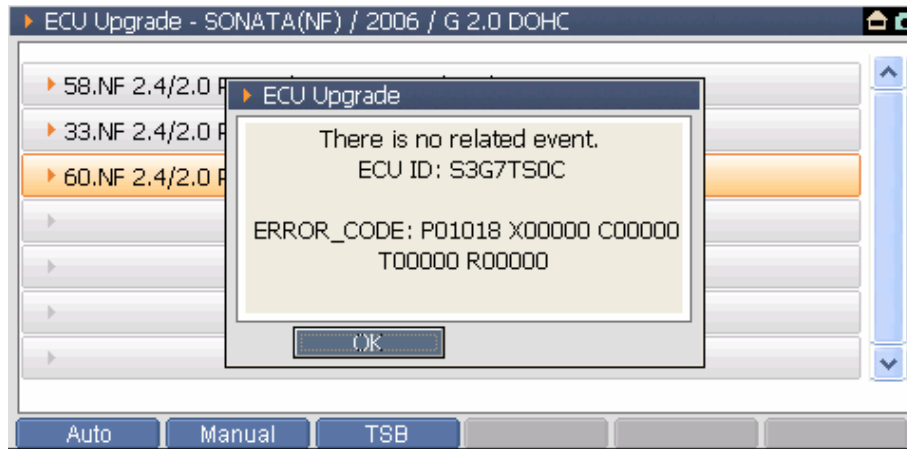

<Figure 5: ECU Auto Upgrade step 3>

- 3) Select **OK** button at the bottom of the update proceeding window screen, then following message will be shown.

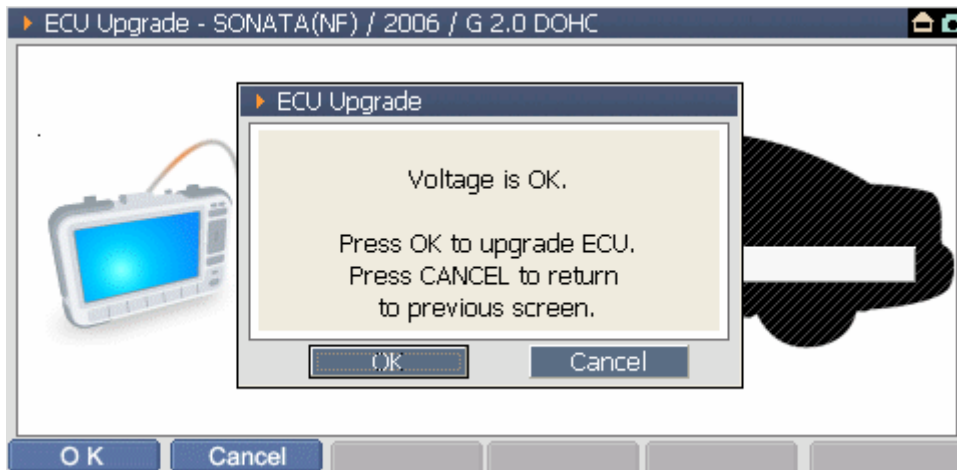

<Figure 6: ECU Auto Upgrade step 4>

- 4) After checking the battery voltage of the vehicle, if there is no voltage problem, select **OK** button, then update will be started as shown in following figure.

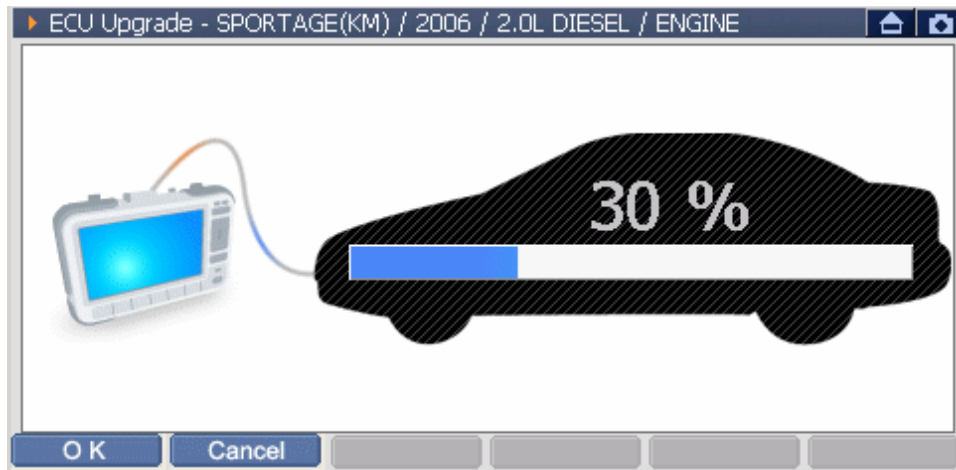

<Figure 7: ECU Auto Upgrade step 5>

- 5) After completing all ECU update procedure, the following message will be shown.



<Figure 8: ECU Auto Upgrade step 6>

If an error is occurred during updating the ECU, the following message will be shown. Then, using manual upgrade, conduct the upgrade in force.

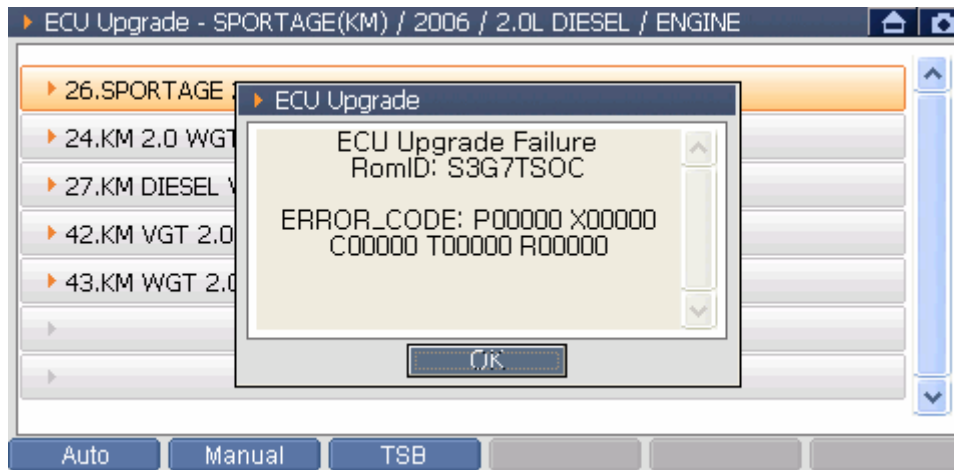

<Figure 9: ECU Auto Upgrade step 7>

Cautions for processing

The time required to complete an upgrade will vary. Menus and buttons are all disabled during the upgrade process.



CAUTIONS

Following instructions should be kept during the upgrade process, or else ECU could be damaged.

- Do not start the engine or turn the ignition key OFF.
- Do not operate any vehicle accessories during the upgrade process.
- Do not disconnect the G-scan during the upgrade process.
- Review the TSB (Technical Service Bulletin) before upgrade, as upgrade procedures can be different for each event.

How to conduct the Manual Upgrade

The manual mode is the ECU upgrade mode used when event is applied in force even there is no event to be applied to the ECU of the vehicle. Unlike the auto mode, in order to apply the event to the ECU of the vehicle, the user directly selects the event and enters the password.

- 1) On the main screen, select , then the screen will be changed to the screen as shown in following figure and all events applied to the vehicle are shown. If there is no event applied to the ECU of the vehicle, it is not changed from the main screen to the ECU upgrade screen.



<Figure 10: ECU Upgrade Screen>

Caution:

After selecting the event to be upgraded, select  at the bottom of the screen to perform the update after checking the Technical Service Bulletin.

2) After selecting the event on the event selection screen, press **Manual** or **F2**, then the screen will be changed to the system selection screen as shown in following figure.

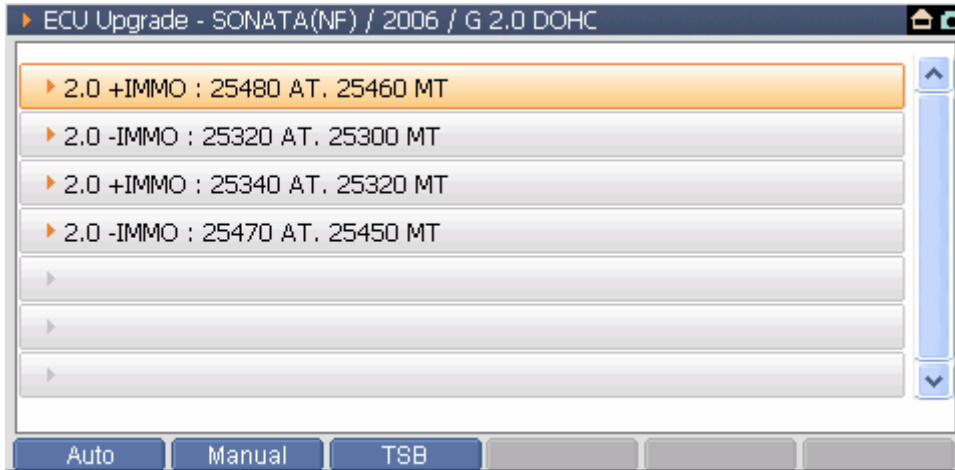

<Figure 11: ECU Manual Upgrade step 1>

Note:

It is changed to the system selection screen. Select the system comply with the vehicle specification.

3) Select **Manual** or **F2**, then the message window for entering the password as following figure.

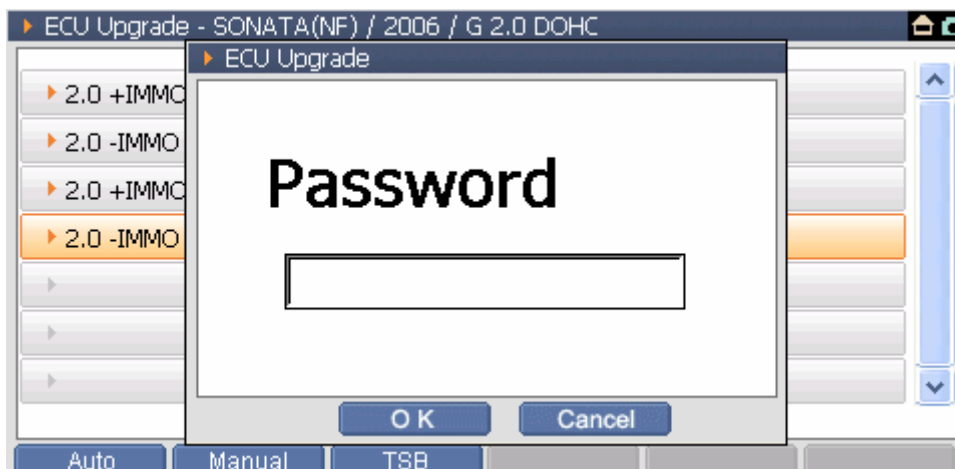

<Figure 12: ECU Manual Upgrade step 2>

- 4) After entering the password using the stylus pen as shown in following figure, select **OK** button at the bottom of the message window.

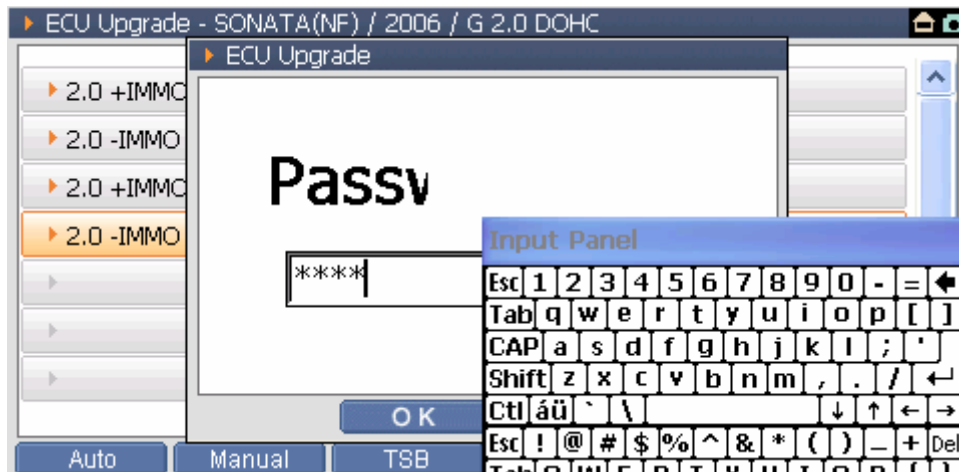

<Figure 13: ECU Manual Upgrade step 3>

- 5) If the password is correct, the following update preparing screen will be shown

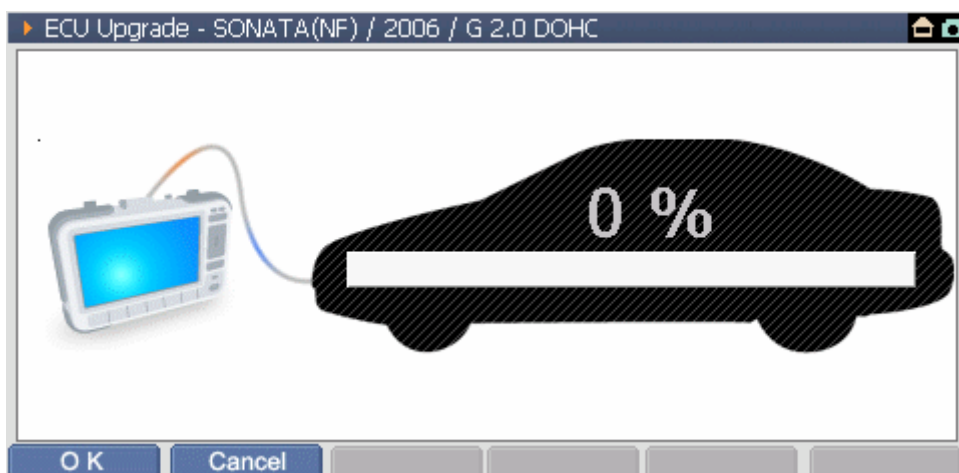

<Figure 14: ECU Manual Upgrade step 4>

- 6) Select **OK** button at the bottom of the update proceeding window, then following message will be shown.

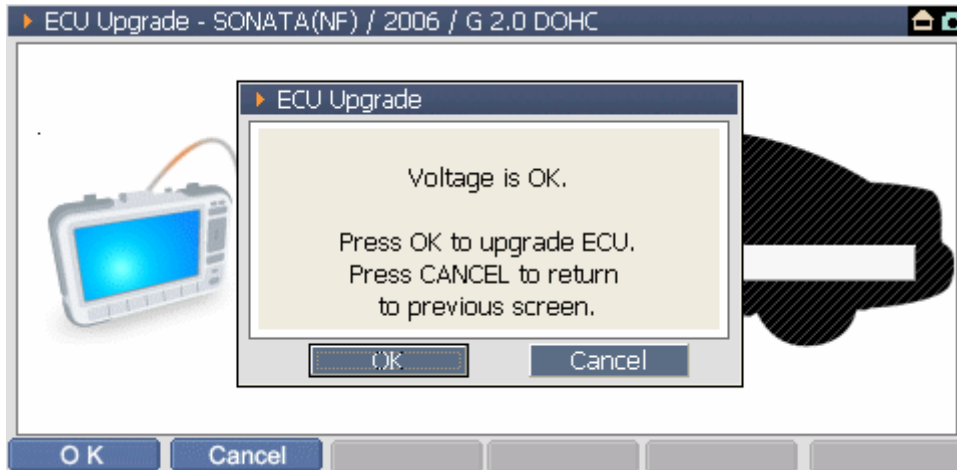

<Figure 15: ECU Manual Upgrade step 5>

- 7) After checking the battery voltage of the vehicle, if there is no problem, then select **OK** button to start the update as shown in the following figure.

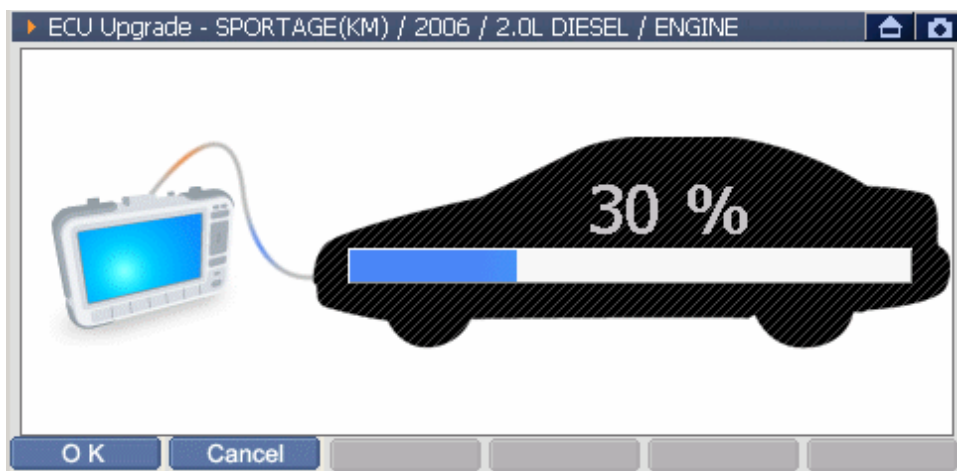

<Figure 16: ECU Manual Upgrade step 6>

8) After completing all ECU updates, the following message will be shown.



<Figure 17: ECU Manual Upgrade step 7>

Error Message

If any error is occurred during updating the ECU, the following message will be shown.

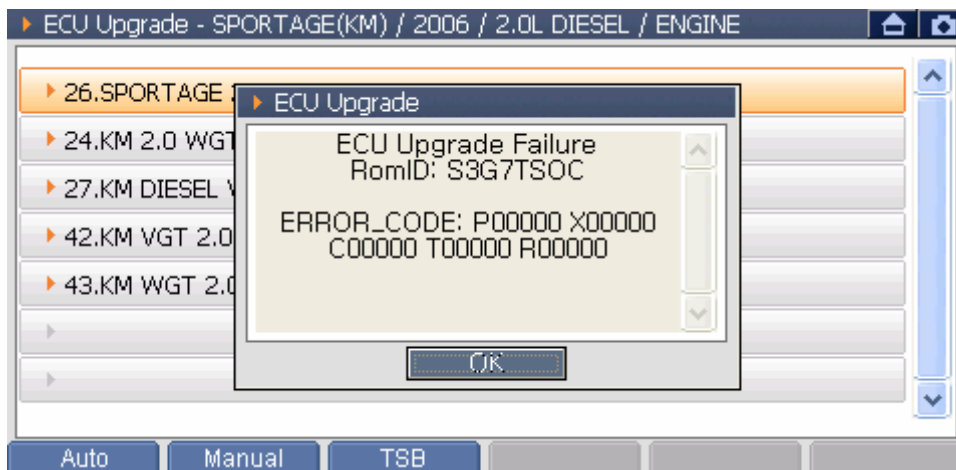

<Figure 18: ECU Manual Upgrade step 8>

Cautions for processing

The time required to complete an upgrade will vary. Menus and buttons are all disabled during the upgrade process.



CAUTIONS

Following instructions should be kept during the upgrade process, or else ECU could be damaged.

- Do not start the engine or turn the ignition key OFF.
- Do not operate any vehicle accessories during the upgrade process.
- Do not disconnect the G-scan during the upgrade process.
- Review the TSB (Technical Service Bulletin) before upgrade, as upgrade procedures can be different for each event.



Optional Item Installation and Expenditure Exchange



The rechargeable battery and TPMS module embedded into G-scan are the optional items.

The optional items should be installed to the G-scan according to the method described in the manual. Otherwise, it may cause defects on the product.

Battery & TPMS Pack Installation

- 1) Loosen the Package mounting bolts from the 4 points shown in <Figure 1> with ①.
- 2) Disconnect the body module and Pack to the direction ② as shown in <Figure 1> carefully.
(If excessive force is applied, the product may be damaged.)
- 3) Install the Battery Pack (or TPMS Pack) as the same figure of the previous Pack condition.
- 4) Tighten the 4 mounting bolts loosened at step 1).

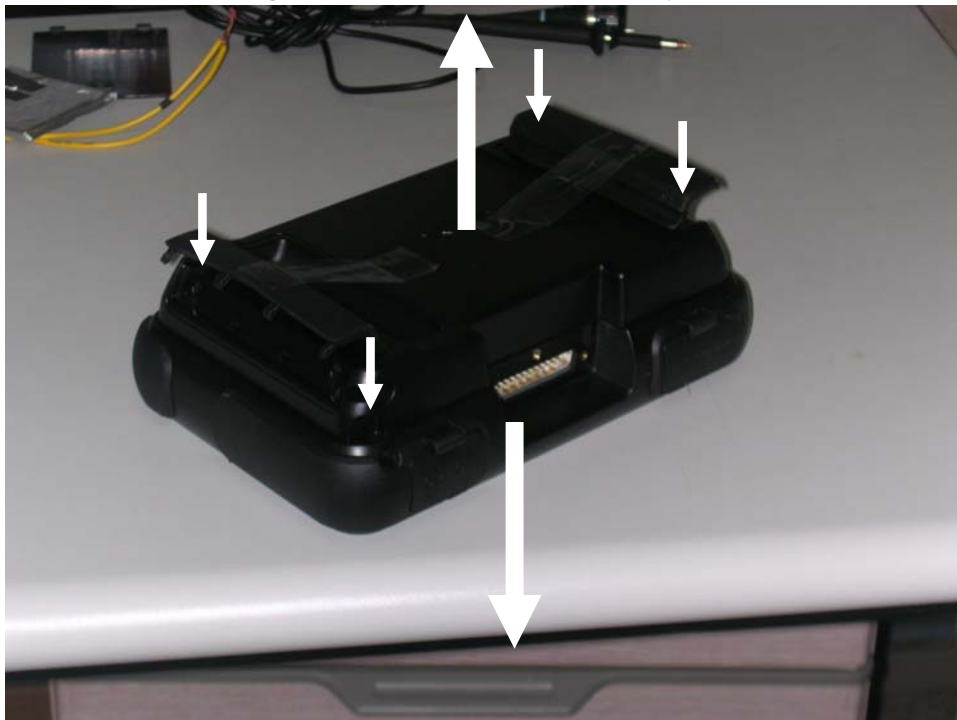

<Figure 1 Position of the Pack Mounting Bolt>

Exchanging the Rechargeable Battery

- 1) For installation and removal of the Pack, refer to the Battery Pack & TPMS Pack Installation.
- 2) Open the battery cover of Pack disassembled like the ① shown in <Figure 2>.

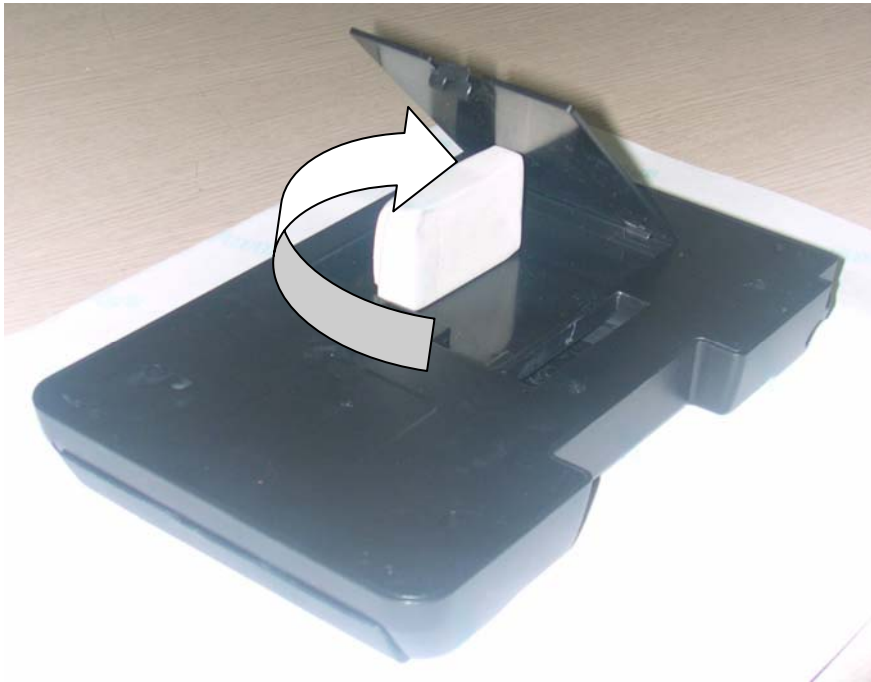

<Figure 2 Open the battery cover>

- 3) Remove the used battery like the ① as shown in <Figure 3>.



<Figure 3 Remove the battery>

- 4) Checking the battery terminal shape of the new rechargeable battery, insert it properly.

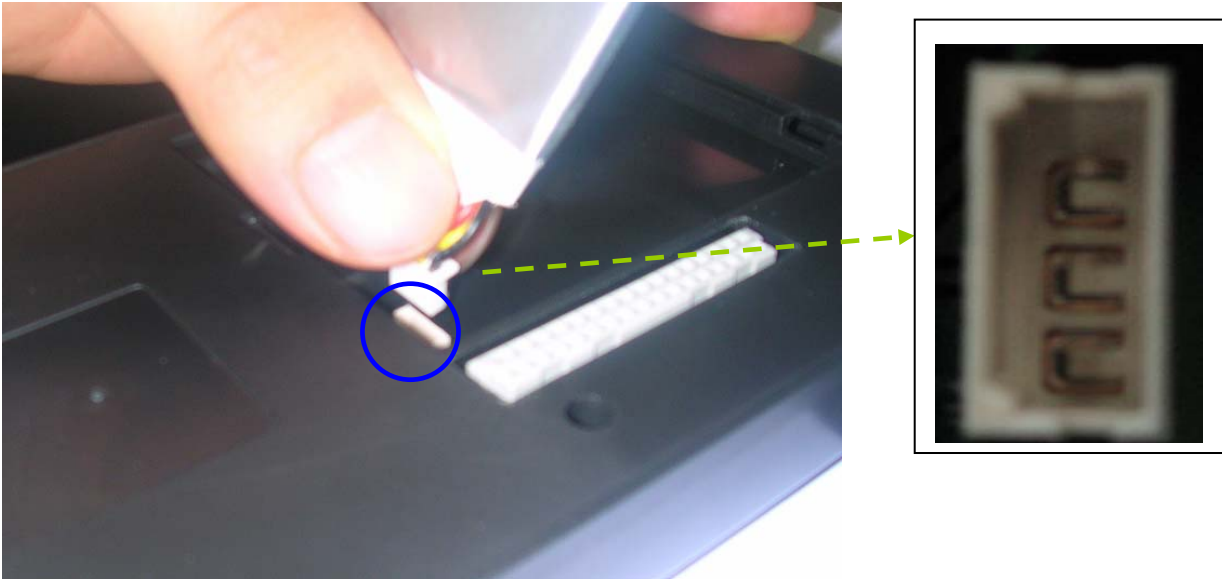

<Figure 4 Install the New battery>

- 5) Locate the new rechargeable battery into the case correctly.
- 6) Close the rechargeable battery and assemble the pack according to the manual.



Caution

- Be careful of the connector direction not to change the polarity of the rechargeable battery.
- After installing the connector, be careful that the battery wiring is not damage by the battery cover.
- After the rechargeable battery cover is closed completely, the Pack should be mounted on the body module.

Exchanging the Cigar-Cable Fuse

- 1) Turning the portion marked in the <Figure 5> to the counter clockwise direction with the 10mm Hexagonal wrench, it is disassembled as shown in <Figure 5>.

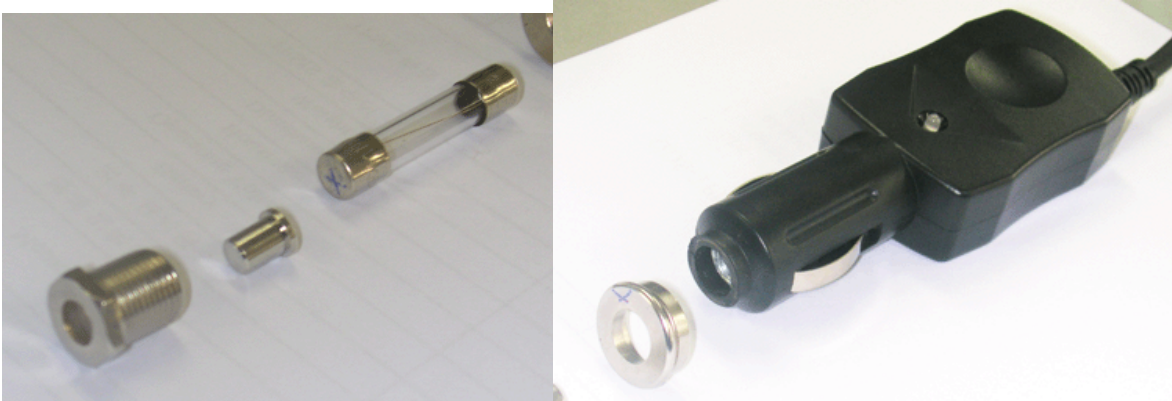

<Figure 5 Disassemble the Cable – Cigar>

- 2) After exchanging the fuse (250V 4A), assemble it in reversed order of disassemble.



Providing that this product has been installed and used as instructed in the operation manual, Global Information Technology (referred to as "GIT") will repair G-scan module (main body other than software, which is covered by a separate warranty) with new or rebuilt parts, free of charge for three (3) years from the date of original purchase in the event of a defect in materials or workmanship. This warranty excludes all other options and accessories, which are covered for a period of one (1) year from the date of original purchase.

This warranty is extended solely to the original purchaser. A purchase receipt or other proof of evidencing the date of original purchase will be required before warranty service is provided.

This warranty only covers failures due to defects in materials or workmanship, which may occur during normal use. It does not cover damage which occurs in shipment or failures which may be caused by products not supplied by GIT, or failures resulting from alteration, accident, misuse, introduction of liquid material or other foreign matter into the product, abuse, neglect, installation, maladjustment of consumer controls, improper maintenance, modification or service by anyone other than GIT, or damage to be attributable to acts of God.

GIT SHALL NOT BE LIABLE FOR LOSS OF DATA OR OTHER INCIDENTAL OR CONSEQUENTIAL DAMAGES RESULTING FROM THE USE OF THIS PRODUCT, OR ARISING OUT OF ANY BREACH OF THIS WARRANTY. ALL EXPRESS AND IMPLIED WARRANTIES, INCLUDING THE WARRANTIES OF MERCHANTABILITY AND FITNESS FOR A PARTICULAR PURPOSE ARE

LIMITED TO THE APPLICABLE WARRANTY PERIOD SET FORTH ABOVE.

GIT's entire liability, and your exclusive remedy under this warranty shall be limited to the replacement, of any defective parts or functions in the product, which is returned to GIT's Service Center, together with a copy of the purchase receipt, during the aforementioned warranty period. Anything in the foregoing to the contrary notwithstanding, GIT shall have no obligation for any defects in the product resulting from your storage thereof, or for defects that have been caused by operation of the product other than on the operation manual or in environmental conditions other than those specified by GIT or by alteration, accident, misuse, abuse, neglect, mishandling, misapplication, installation, maladjustment of consumer controls, improper maintenance, modification of damage that is attributable to acts of God.

This limited warranty gives you specific legal rights, and you may also have other rights, which vary from country to country. The laws of Republic Korea, without regard to its conflict-of-laws rules, will govern this Limited Warranty.

To obtain help or technical Assistance, please contact your product supplier or distributor.



Disposal of Old Electrical and Electronic Equipment



WEEE (Waste Electrical and Electronic Equipment) symbol shown in [Figure 1] is indicated on the back of the **G-scan** main module

Please follow the regulation guide for disposal of Waste Electrical and Electronic Equipment.



[Figure 1] WEEE Symbol

Disposal of Old Electrical & Electronic Equipment (Applicable in the European Union and other European countries with separate collection systems)

This symbol on the product or on its packaging indicates that this product shall not be treated as household waste. Instead it shall be handed over to the applicable collection point for the recycling of electrical and electronic equipment. By ensuring this product is disposed of correctly, you will help prevent potential negative consequences for the environment and human health, which could otherwise be caused by

inappropriate waste handling of this product. The recycling of materials will help to conserve natural resources. For more detailed information about recycling of this product, please contact your local city office, your household waste disposal service or the shop where you purchased the product.